



どうぶつの森

77047



LEGO® Builder



LEGO.com/sustainable-packaging



FR  
**DONNEZ**  
OU  
**RECYCLEZ**



OU



OU



ASSOCIATION

MAGASIN

DÉCHÈTERIE

Adresses sur [quefairedemesdechets.fr](http://quefairedemesdechets.fr)

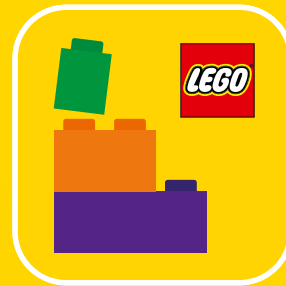

# BUILDER



Apple and the Apple logo are trademarks of Apple Inc., registered in the U.S. and other countries and regions. App Store is a service mark of Apple Inc. Google Play and the Google Play logo are trademarks of Google LLC. Tencent and the Tencent logo are trademarks of Tencent Inc.

LEGO.com/devicecheck

**EN** Ask parents' permission before going online | **DE** Eltern um Erlaubnis bitten, bevor du online gehst | **FR** Demande l'autorisation d'un parent avant d'aller en ligne | **IT** Chiedi il permesso ai tuoi genitori prima di andare online | **ES** Pídeles permiso a tus papás antes de conectarte a Internet | **PT** Pede autorização aos pais antes de acederes online | **ZH** 上网前应先征得父母的同意 | **PL** Poproś rodziców o zgodę, zanim wejdiesz do Internetu | **CS** Než půjdeš na internet, požádej rodiče o svolení | **SK** Skôr než pôjdeš na internet, vypýtaj si povolenie od rodičov | **HU** Kérj szülői engedélyt, mielőtt online csatlakoznál! | **RO** Cere permisiunea părinților înainte de a te conecta online | **BG** Поискайте разрешение от родител, преди да влезете онлайн | **LV** Pirms došanās tiešsaistē palūdz atļauju vecākiem | **ET** Enne Interneti kasutamist küsi vanematelt luba | **LT** Prieš prisijungdami prie interneto, atsklauskite tėvų

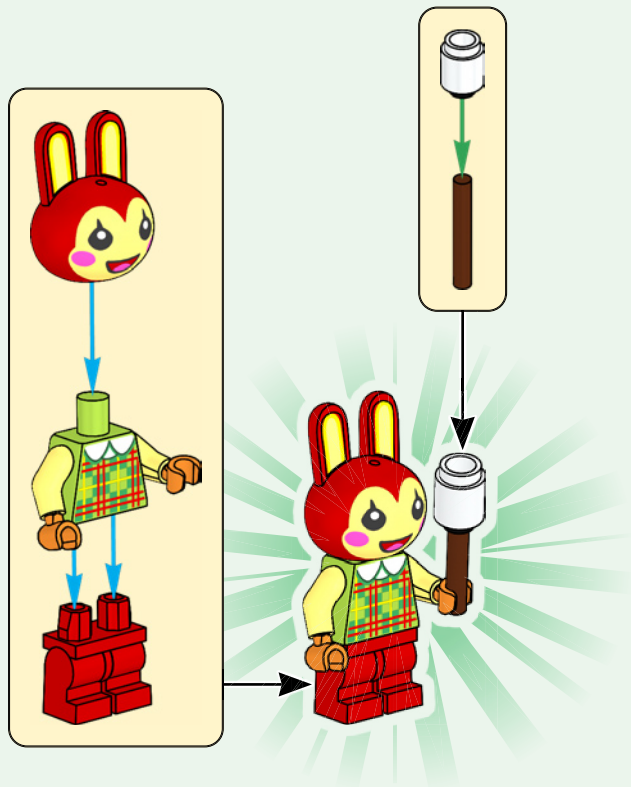





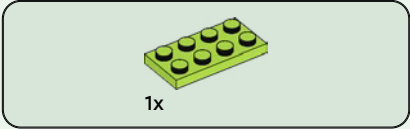

1x

1

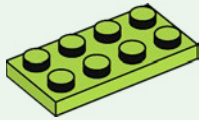

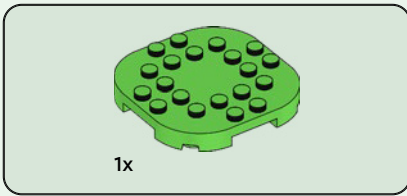

2

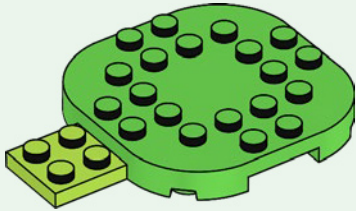

3

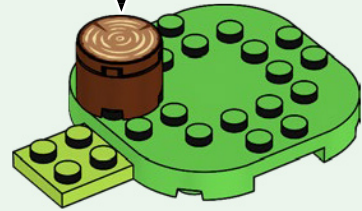



1x

4

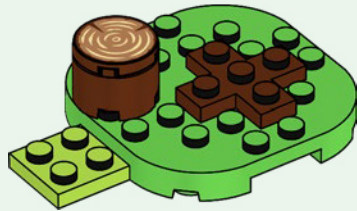





5

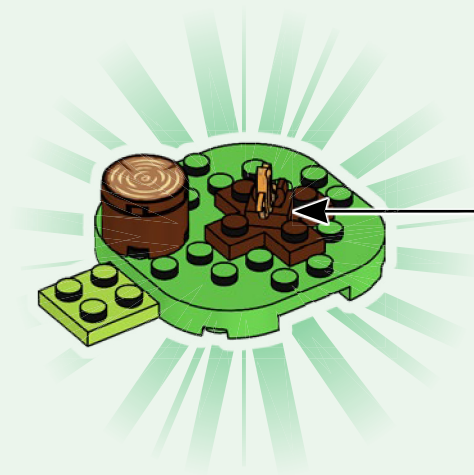

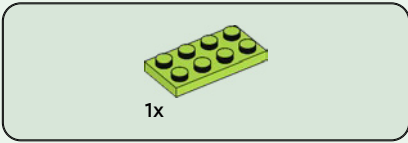
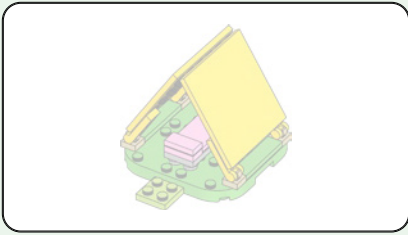

6

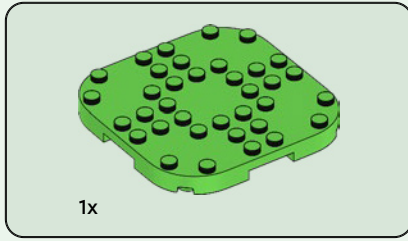
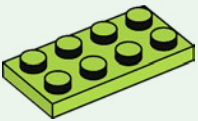

7

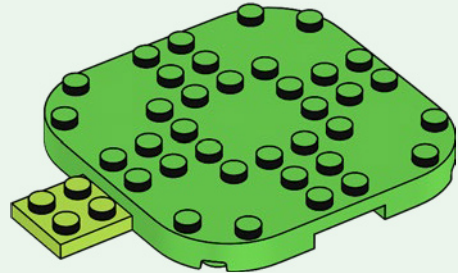

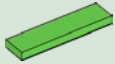

2x

8

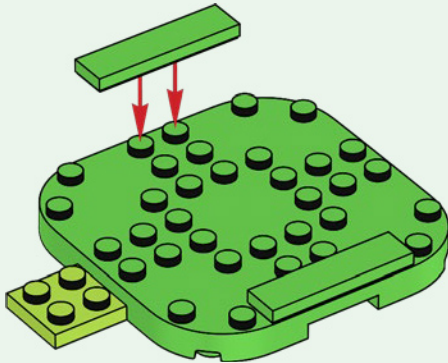

4x

9

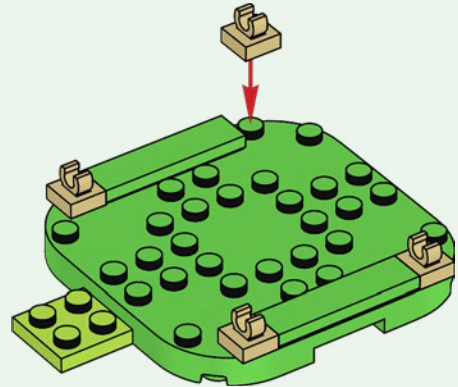



1x



1x

10

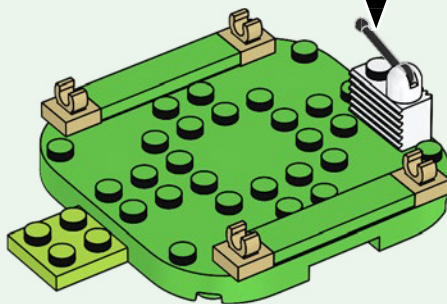
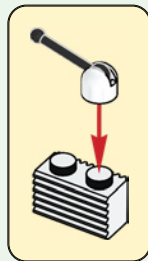



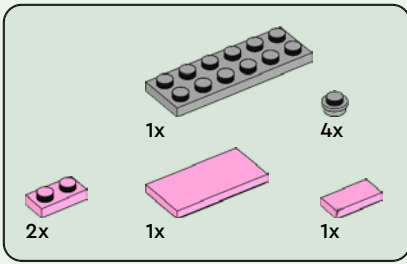

# 11

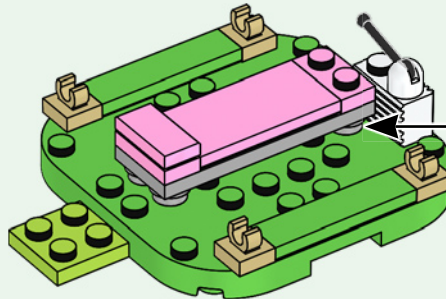
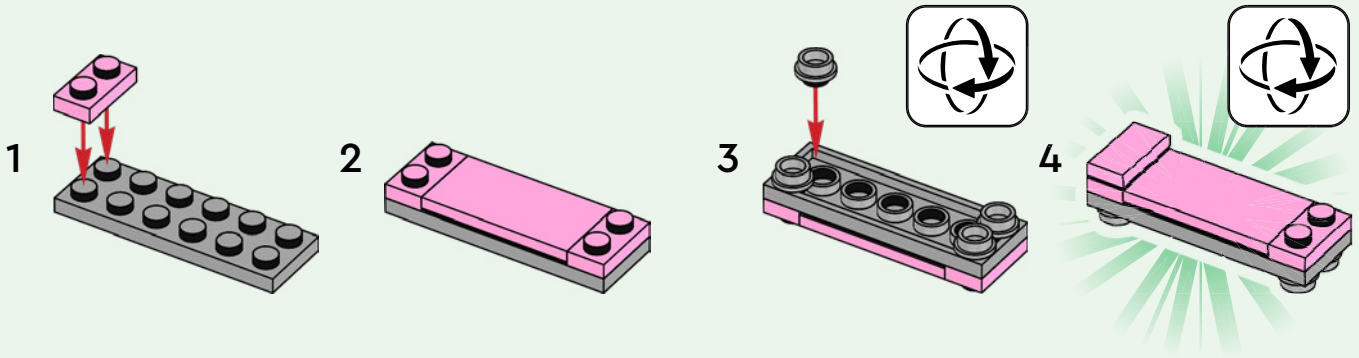

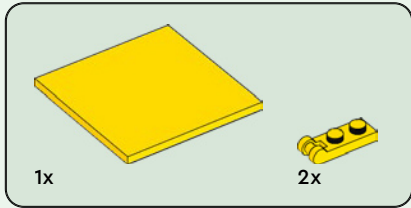
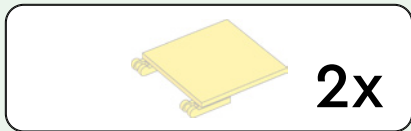

12

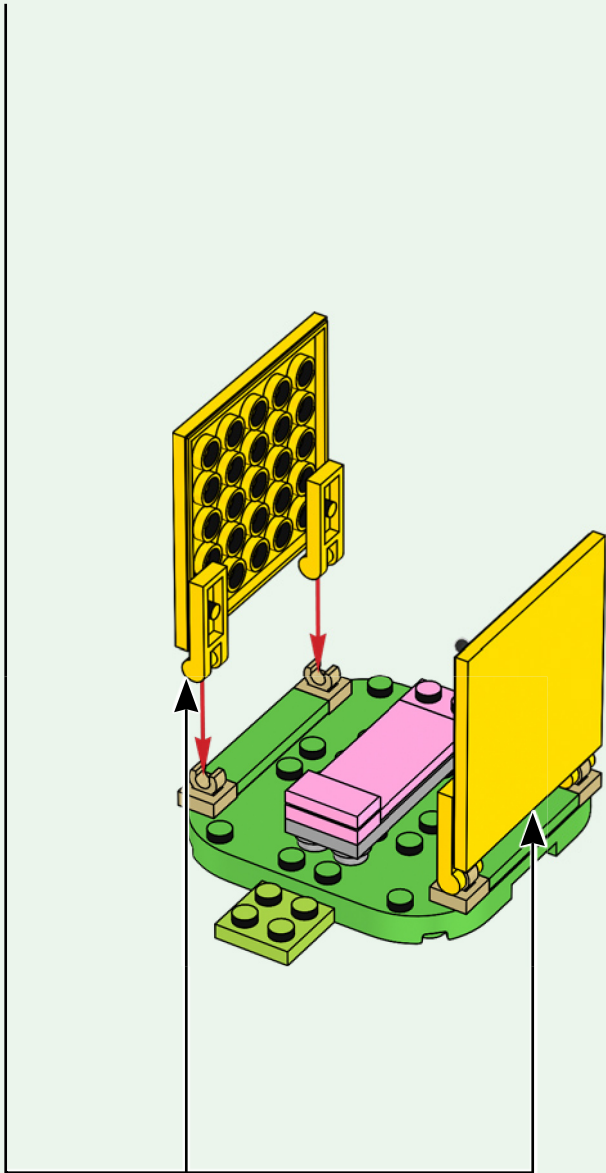
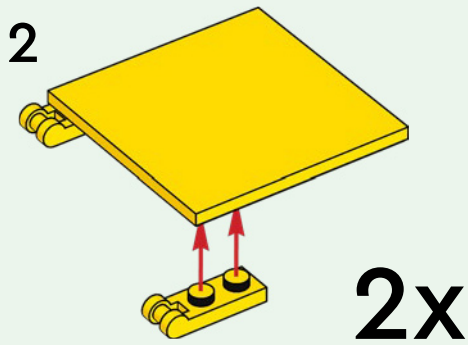
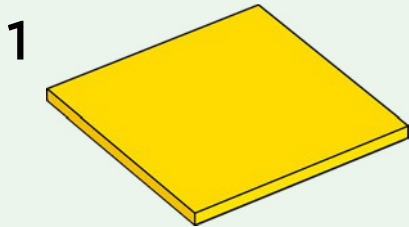

13

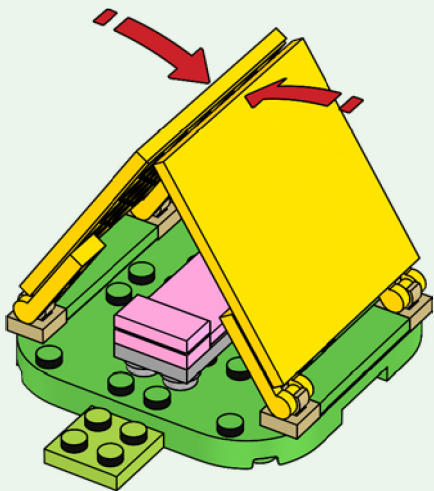

14

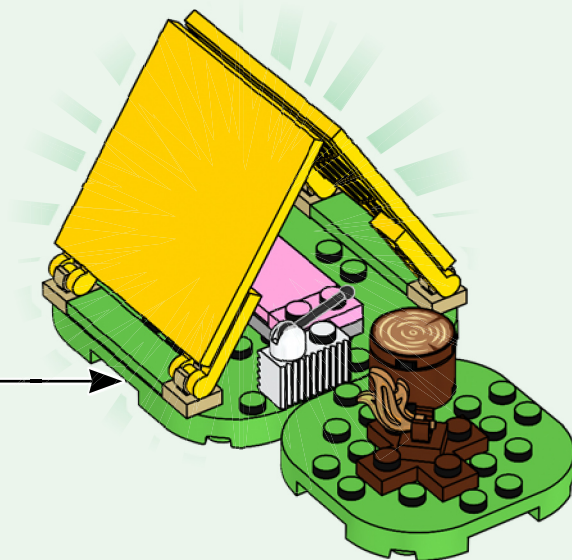

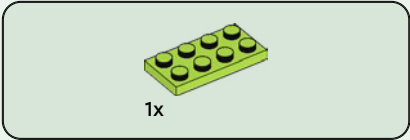
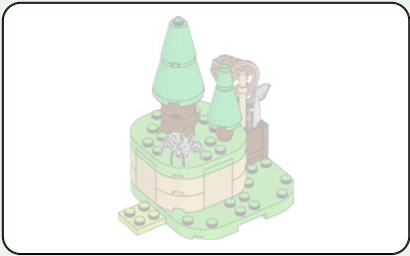

1

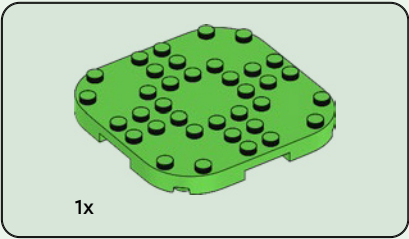
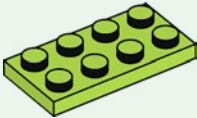

2

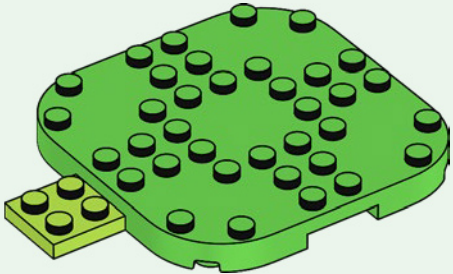



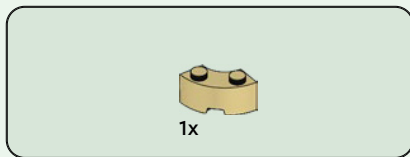

3

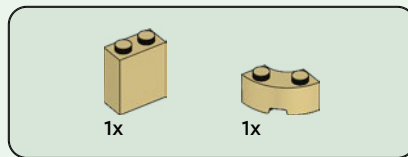
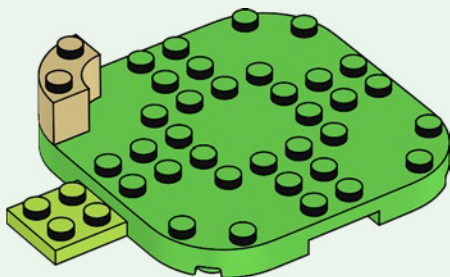

4

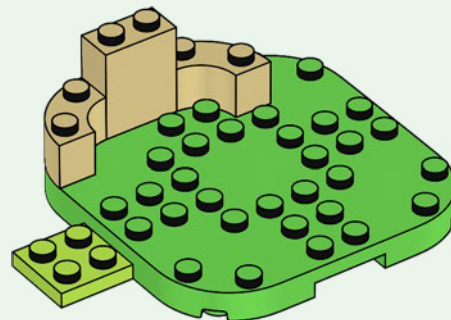



2x

5

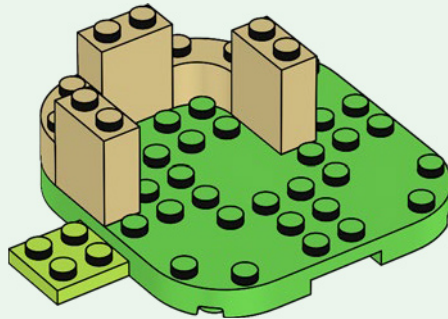

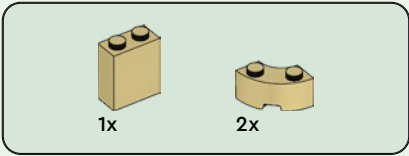

6

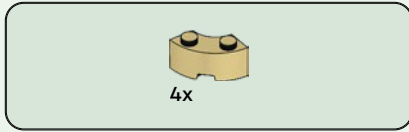
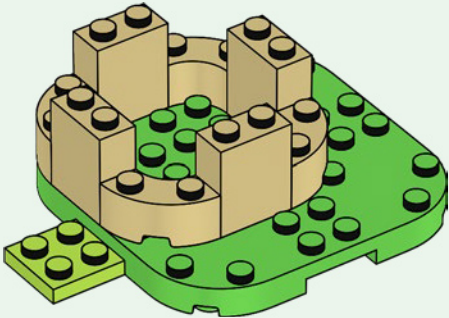

7

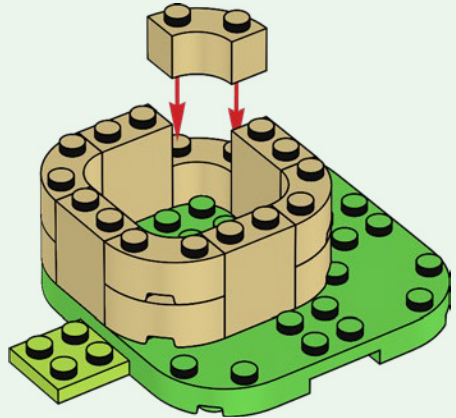



4x

8

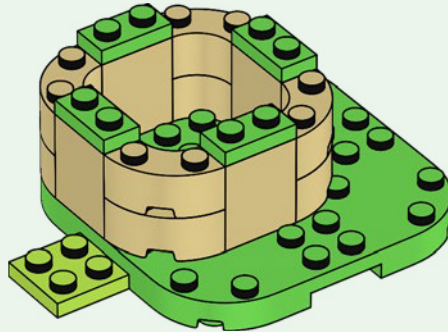

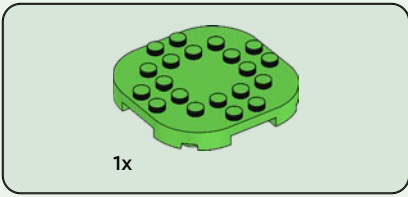

9

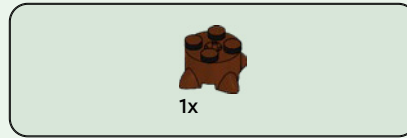
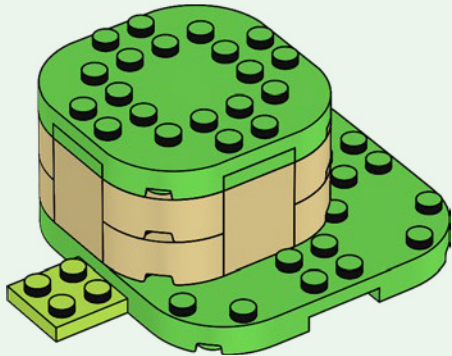

10

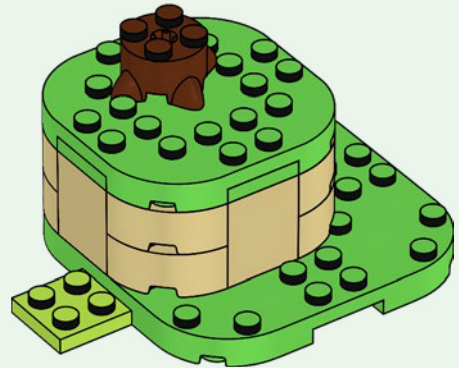

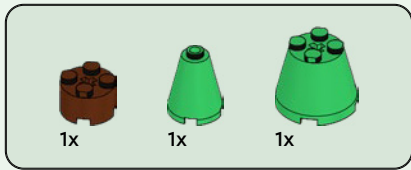

11

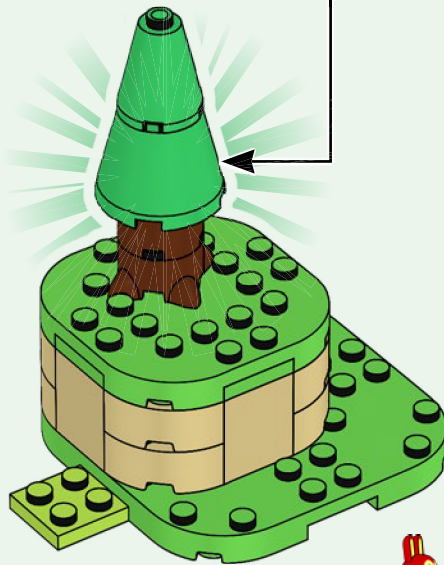
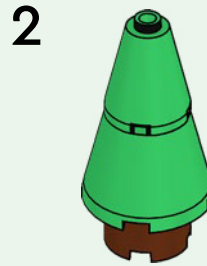
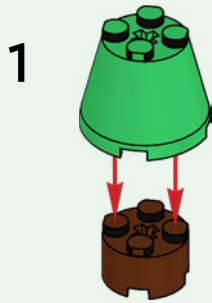



1x

12

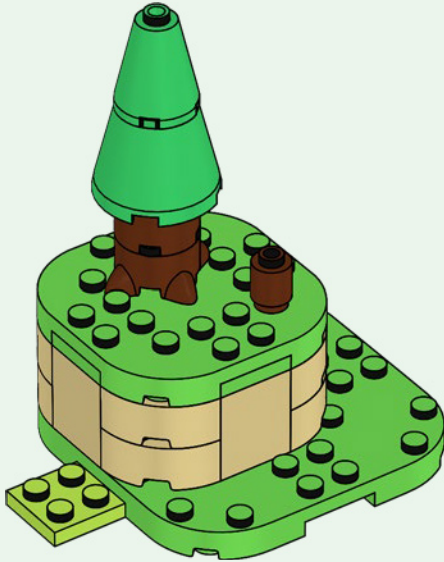

1x



1x

13

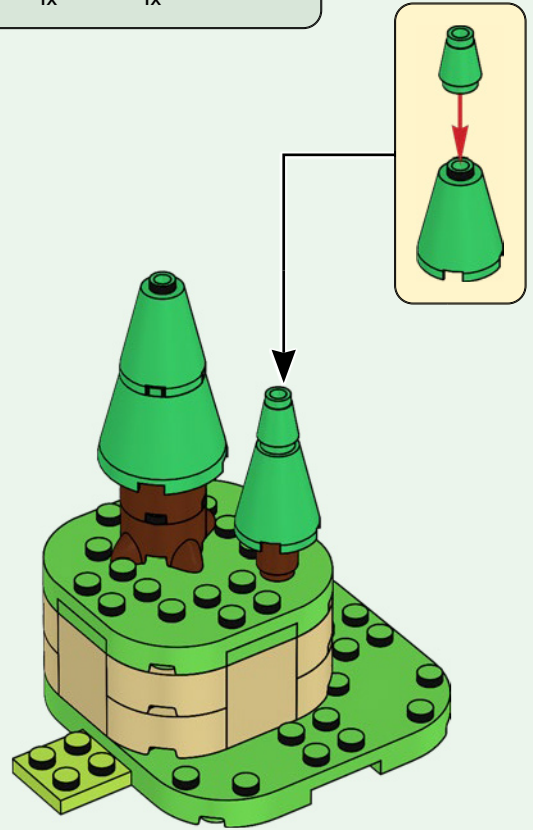



1x

14

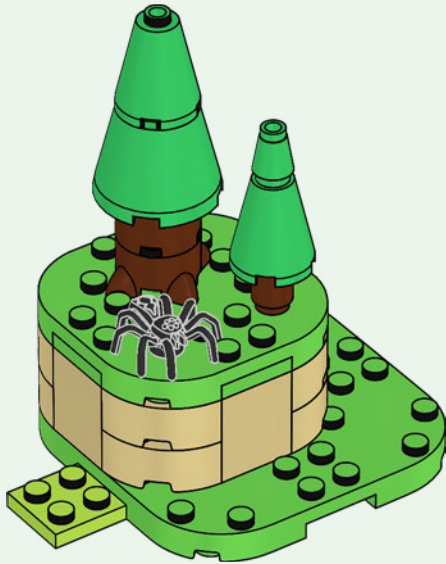

1x

15

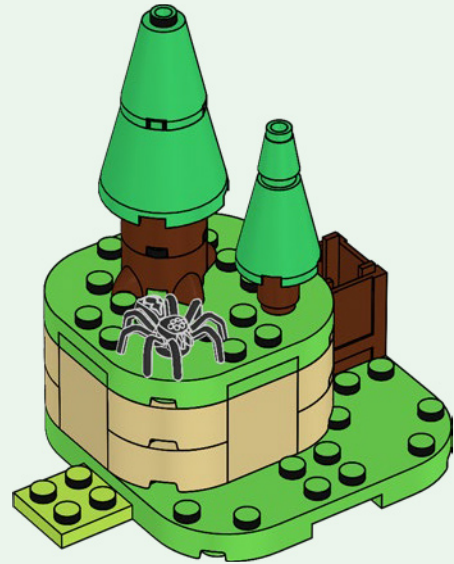



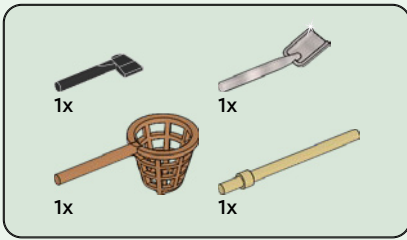

16



17

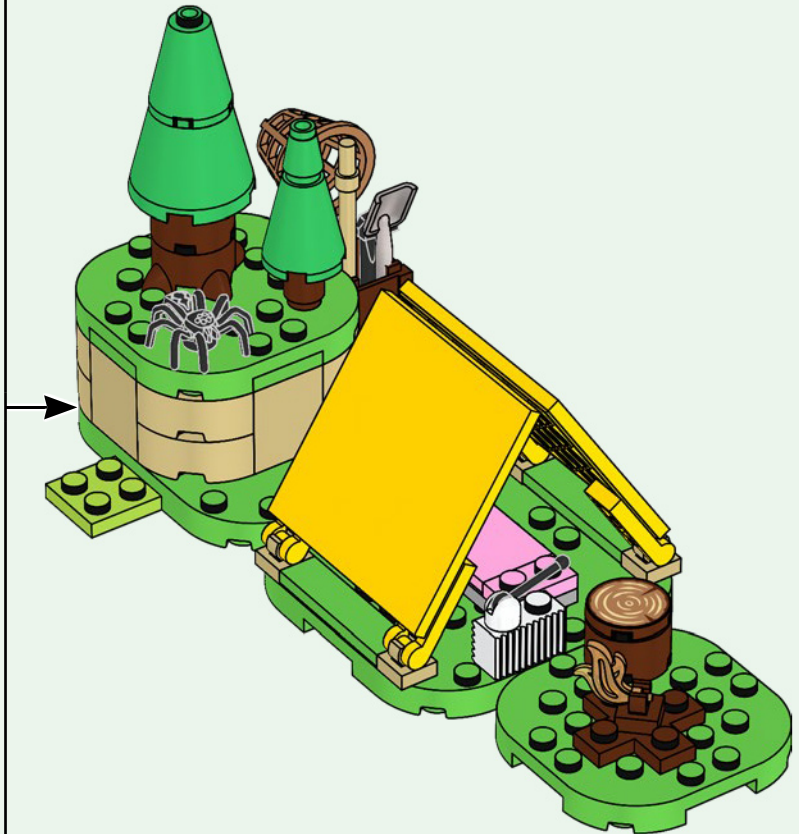

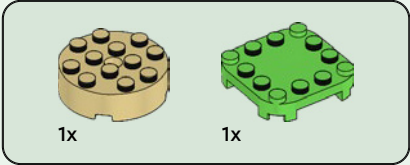
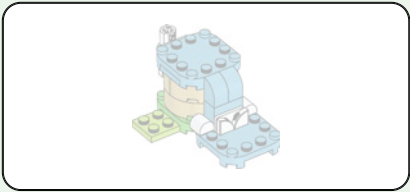

18

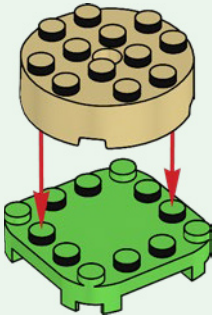

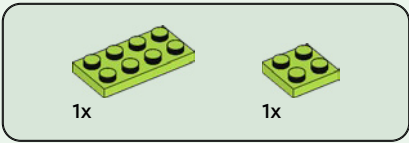

19

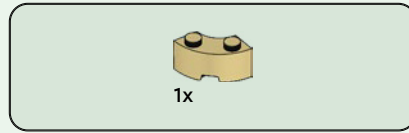
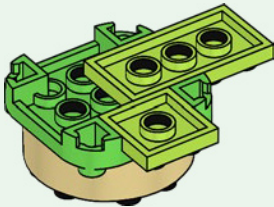

20

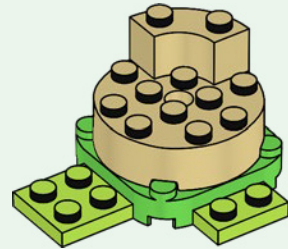
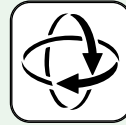



3x

21

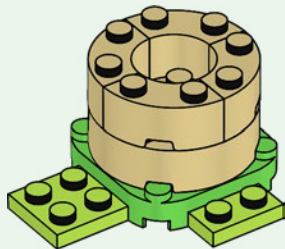



1x

22

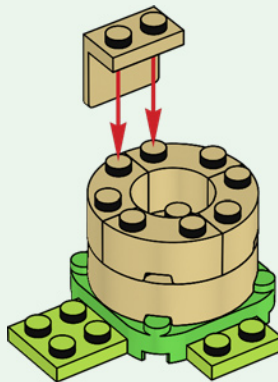

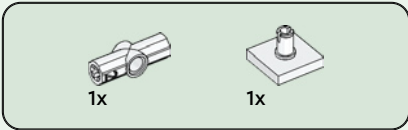

# 23

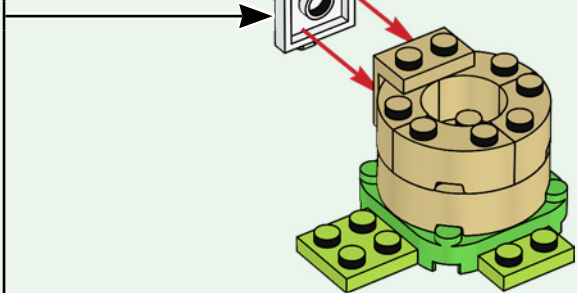
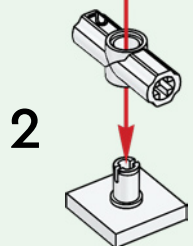
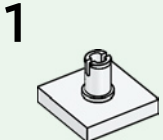

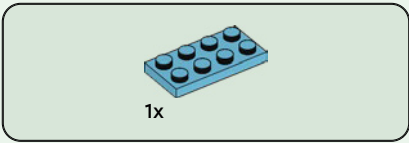

24

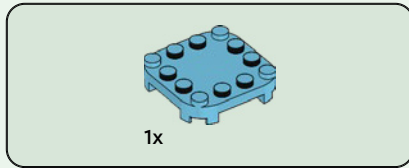
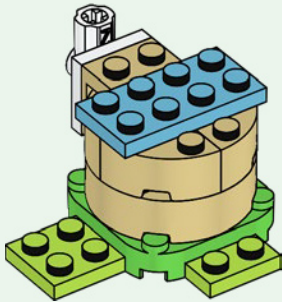

25

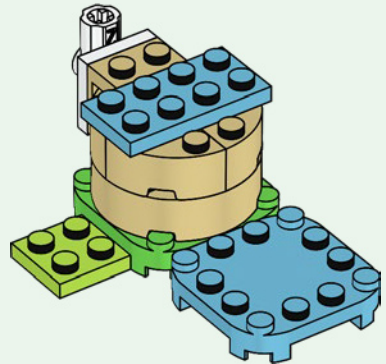

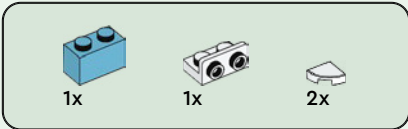

# 26

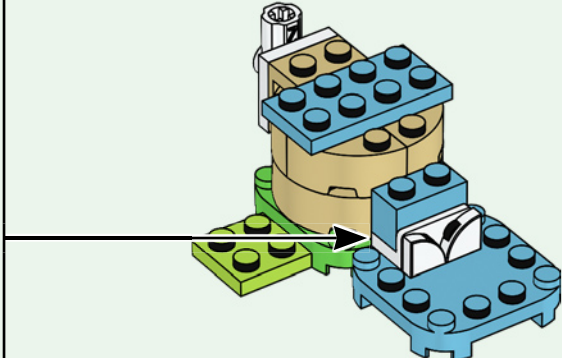
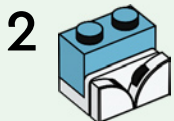
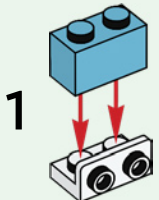





2x

27

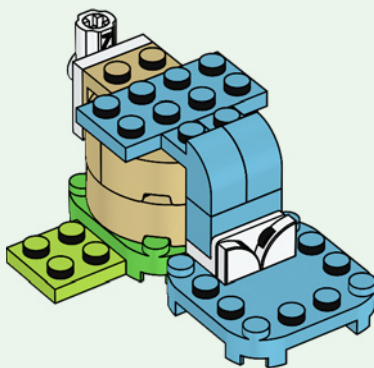

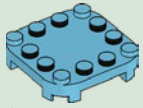

1x

28

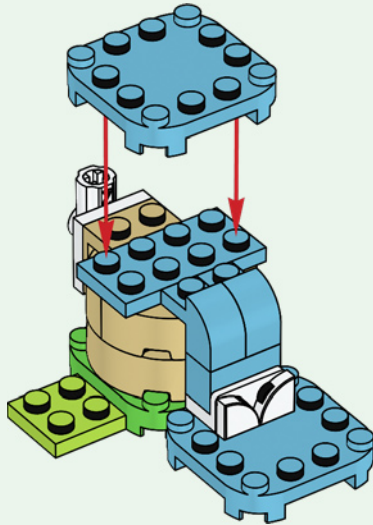

2x

29

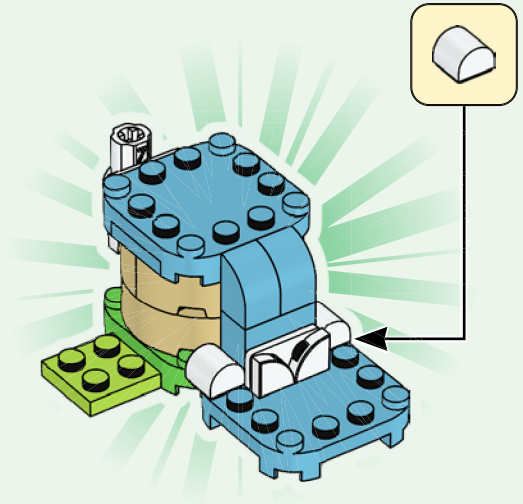

30

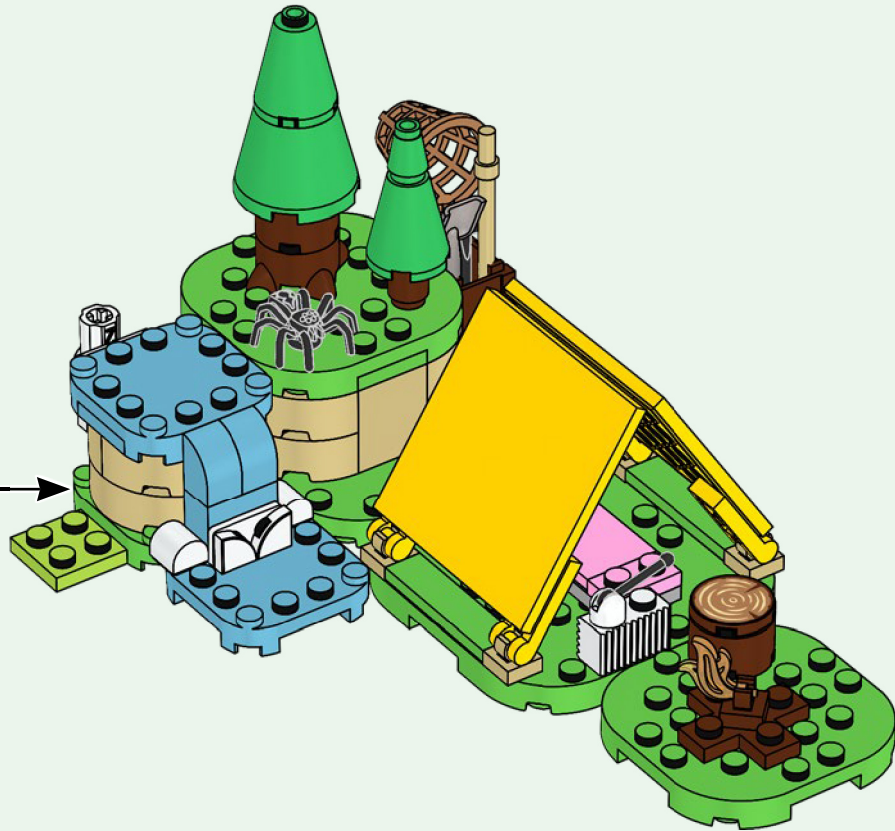



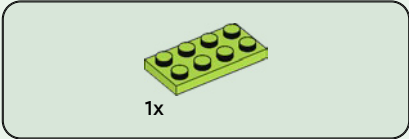
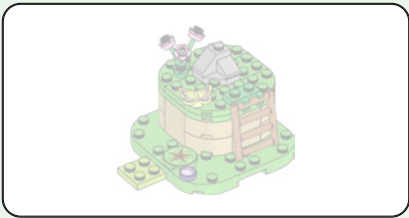

31

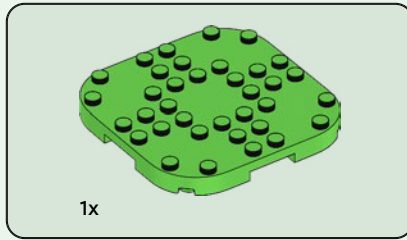
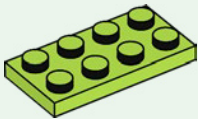

32

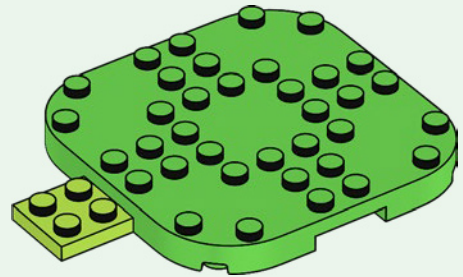



1x

33

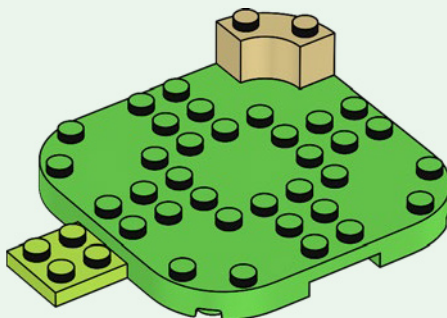

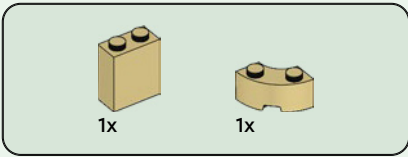

34

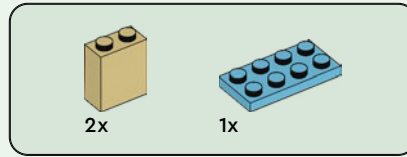
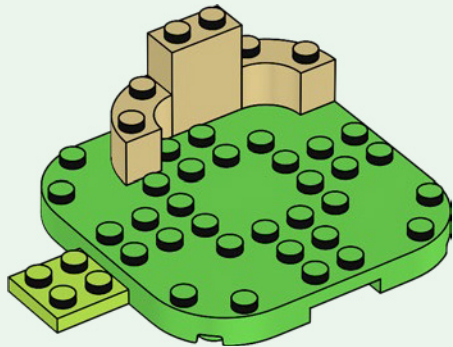

35

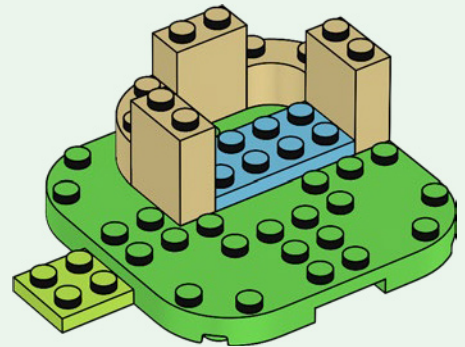



1x



2x

36

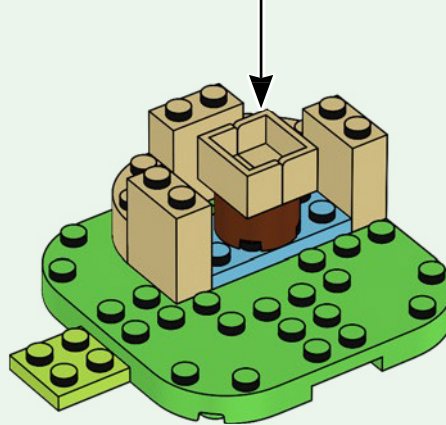
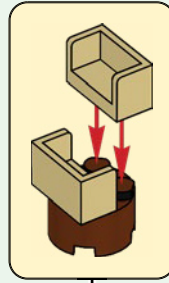



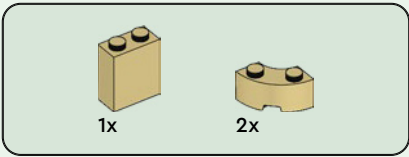

37

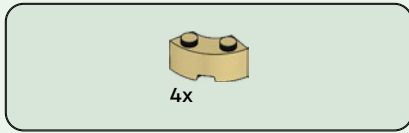
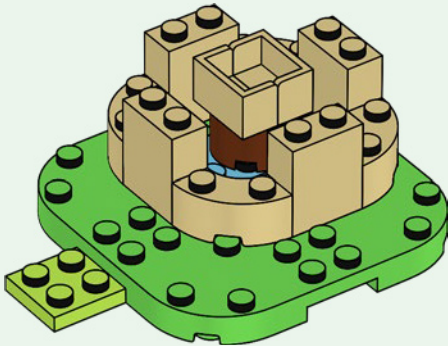

38

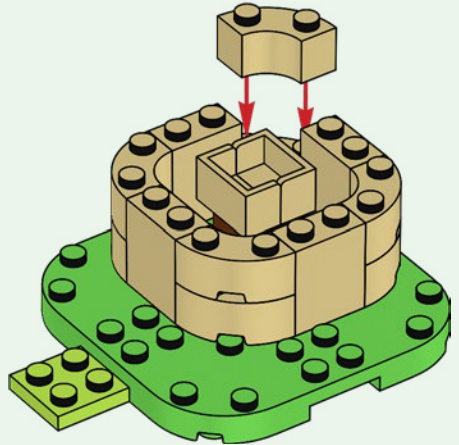



1x



1x

# 39

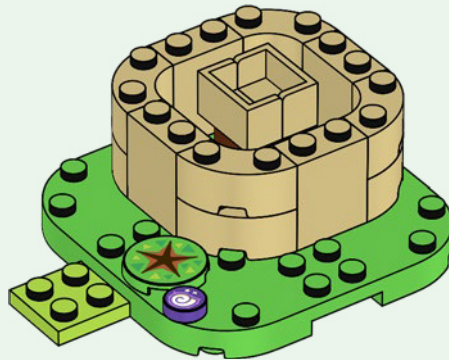

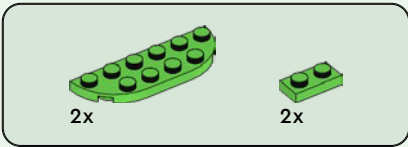

40

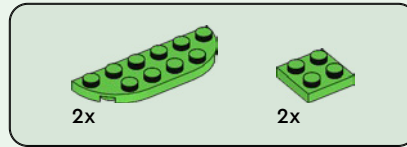
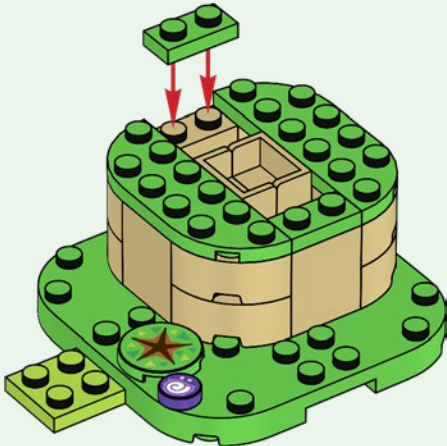

41

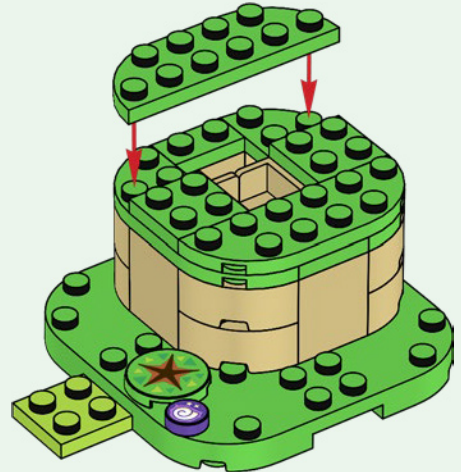

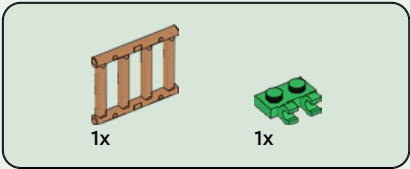

42

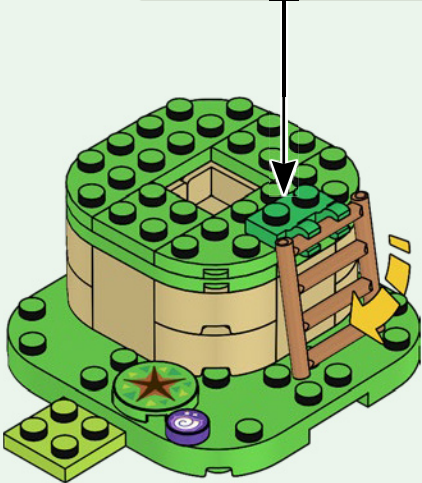
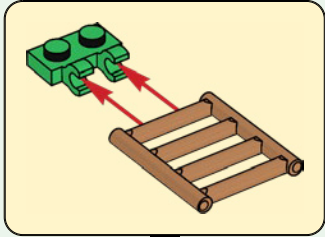



43

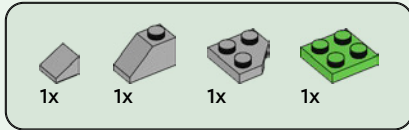
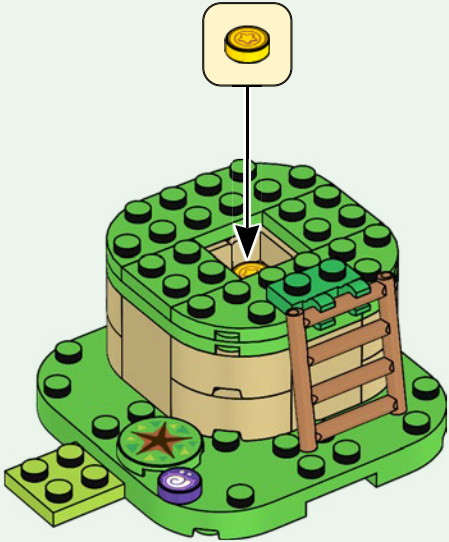

44

1



2

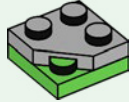

3

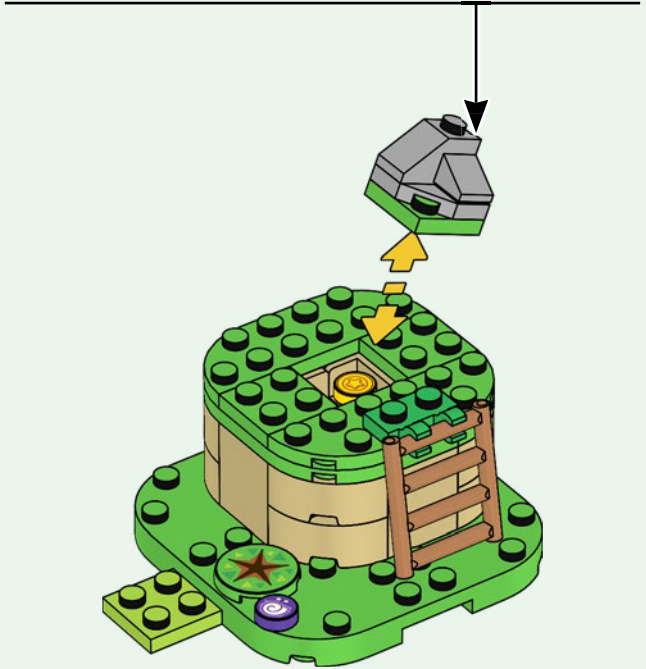



1x



1x

# 45

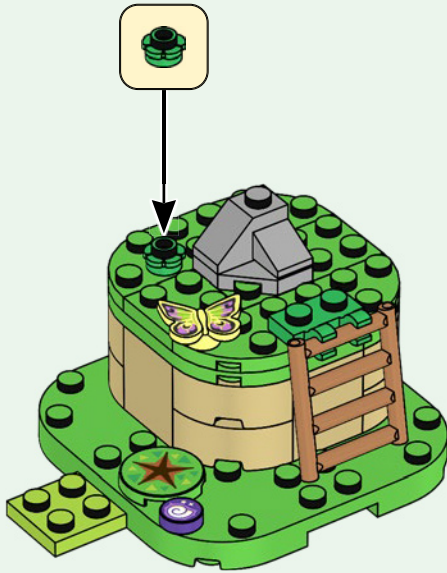

1x



3x

# 46



47





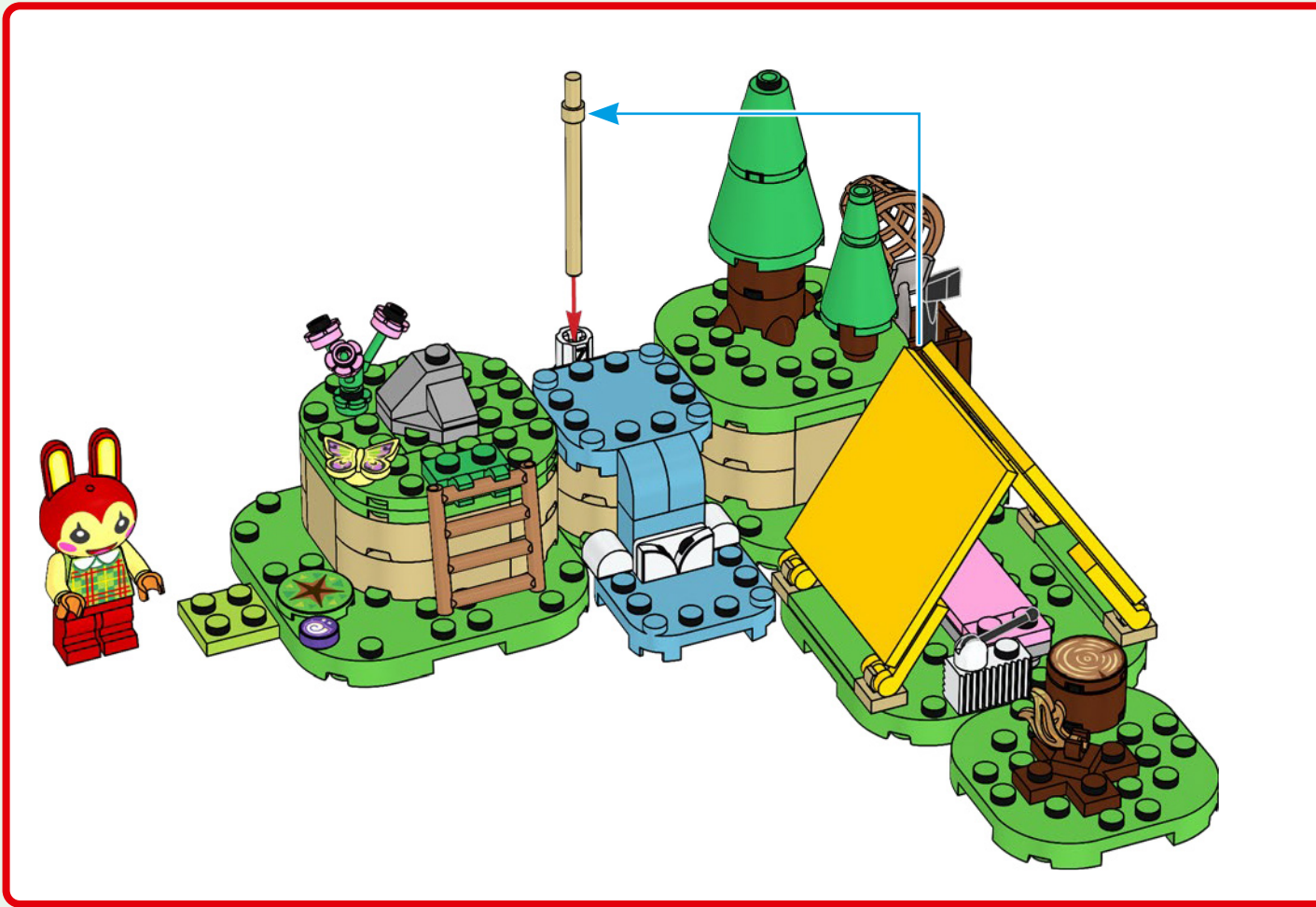





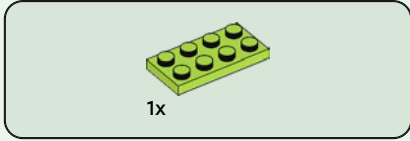
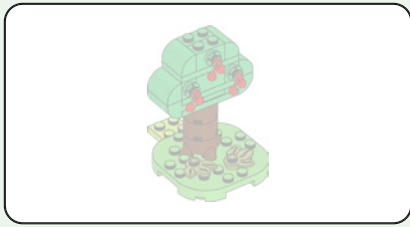

1x

48

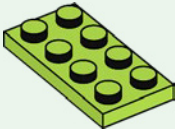

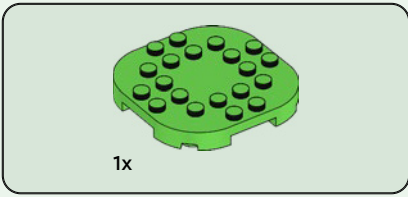

49

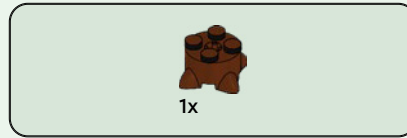
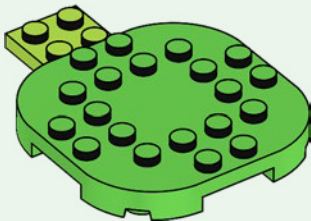

50

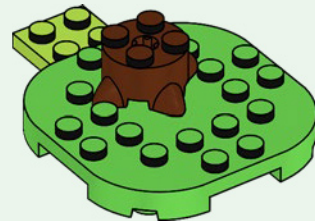



2x

51

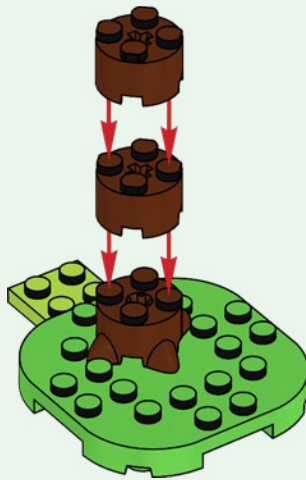

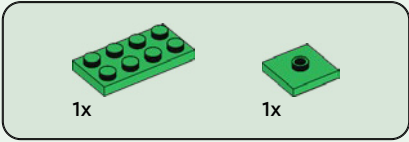
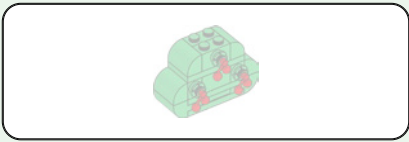

52

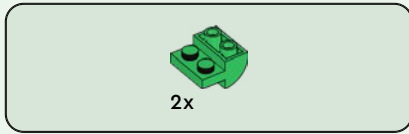
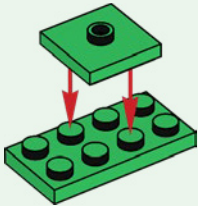

53

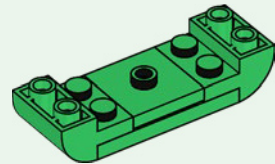

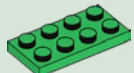

1x

54

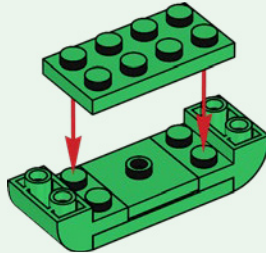



2x

55

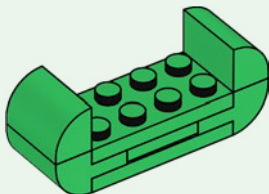

2x

56

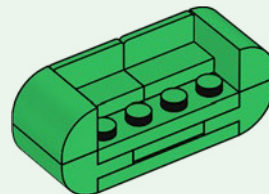



1x



2x

57

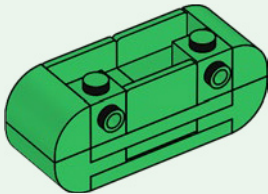

1x



1x

58

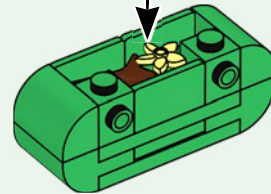



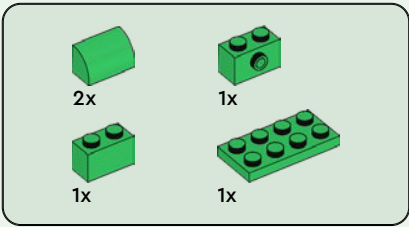

59

1

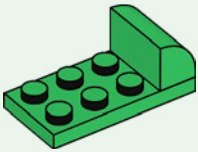

2

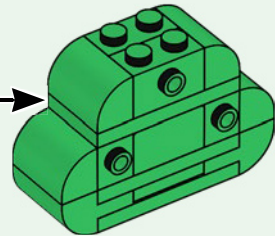



3x



3x

60

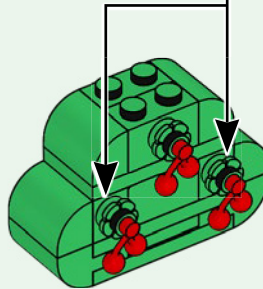
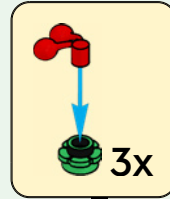

61

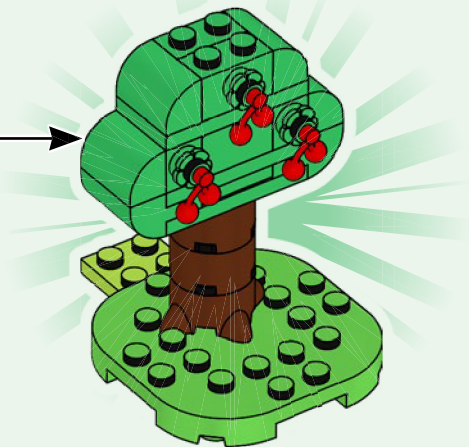

62

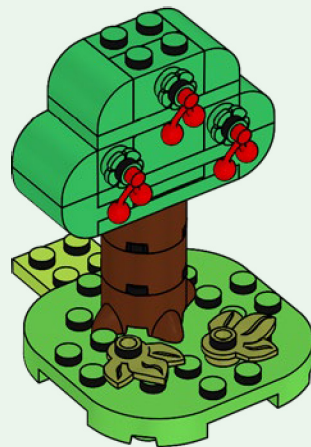

63

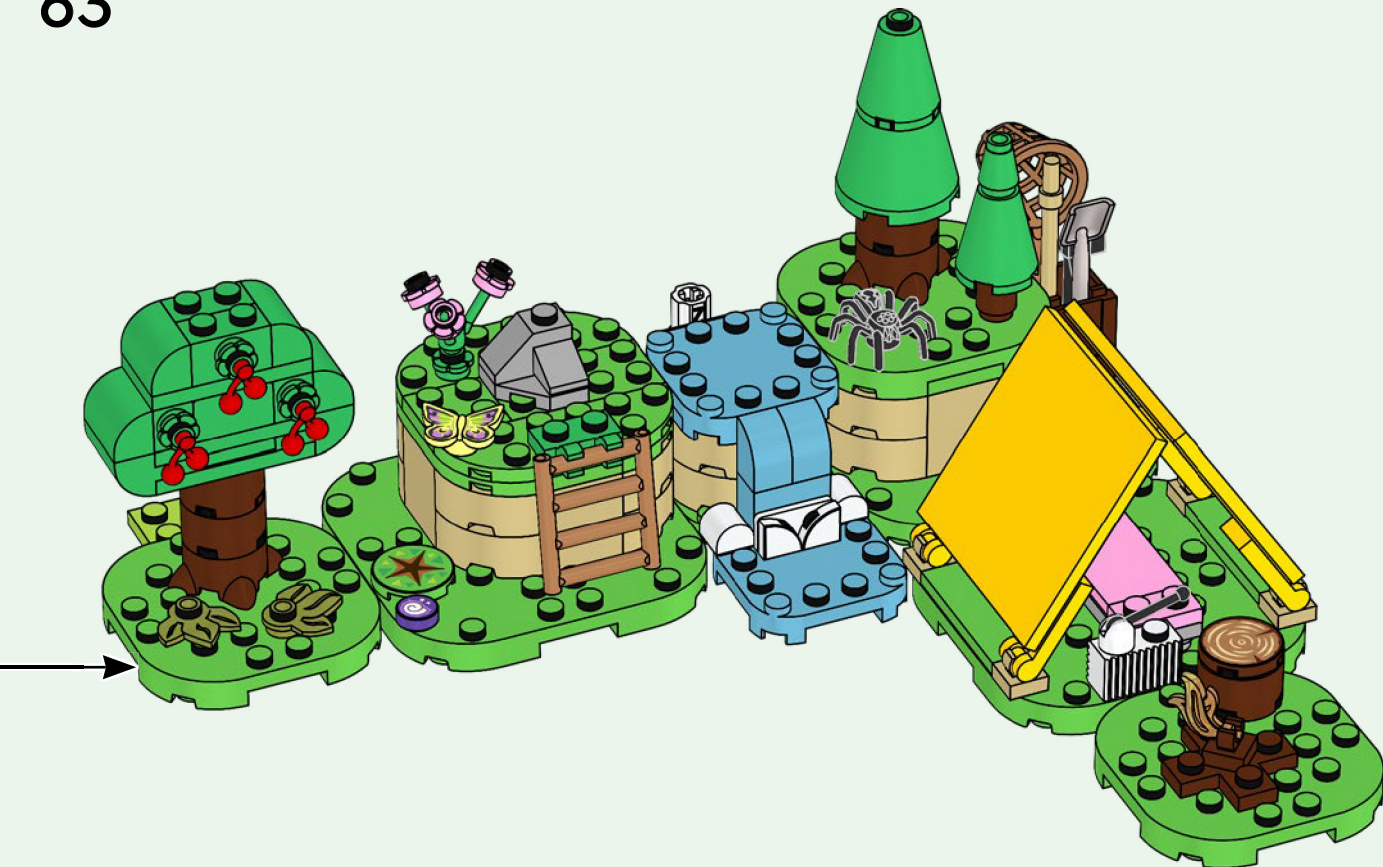

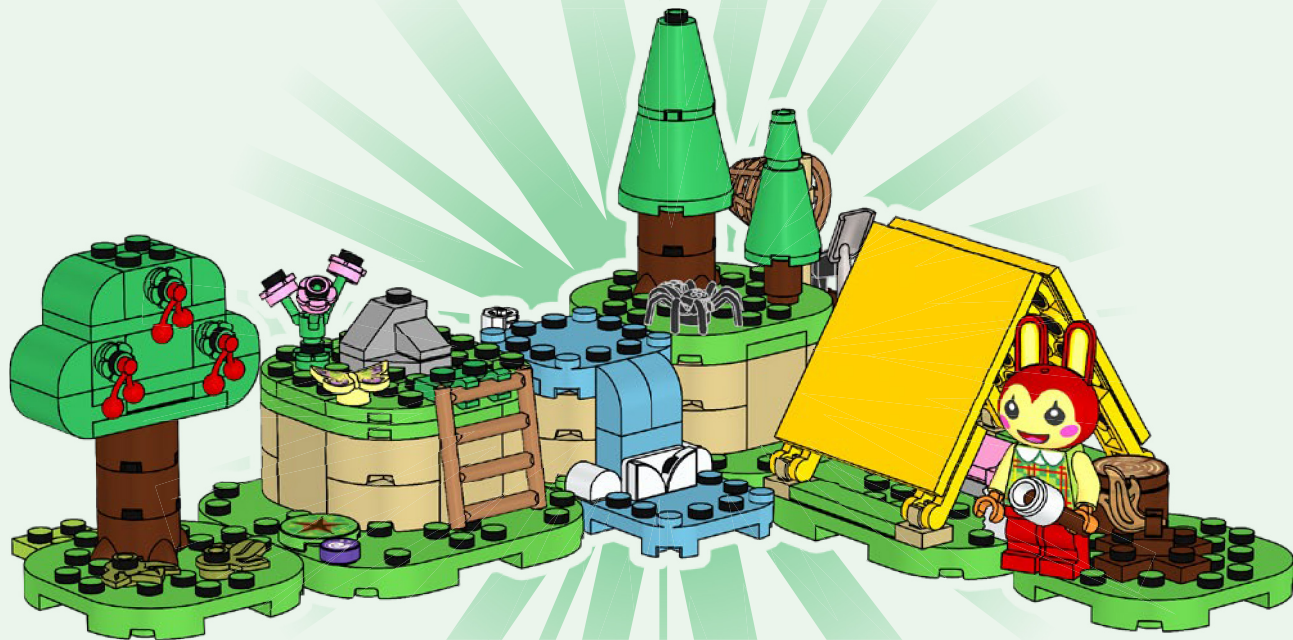



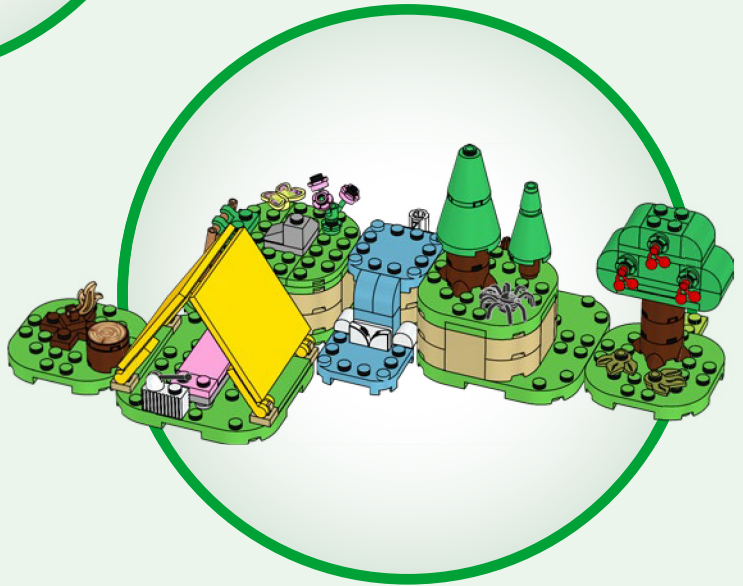





# どうぶつの森







77046



77047



77048



77049



77050

1x  
73737

4x  
6360078

1x  
6469545

1x  
6269971

3x  
302028

1x  
306201

2x  
6248495

1x  
6469535

3x  
6146227

1x  
6469544

2x  
6258135

8x  
4159279

4x  
4515367

1x  
4107736

6x  
6343326

2x  
6172366

1x  
6117975

2x  
6469905

1x  
6469903

3x  
6357612

1x  
287701

20x  
6055868

1x  
6234806

4x  
6270719

2x  
6195267

1x  
6070698

1x  
6294592

1x  
383526

1x  
6347288

1x  
6308875

1x  
6313138

1x  
6254770

4x  
6135287

2x  
6469900

4x  
6134287

1x  
6271870

3x  
6100565

1x  
4529239

1x  
6389692

3x  
6301631

1x  
6336210

2x  
6385644

1x  
6469906

3x  
6301641



1x  
4537937



1x  
6483981



6x  
4537936



1x  
6314353



1x  
4211183



1x  
6348057



1x  
6182435



5x  
4211166



1x  
6078605



2x  
6468829



1x  
6428805



1x  
4520638



1x  
6050918



4x  
4211525



1x  
4521921



1x  
6186657



1x  
4211614



1x  
4211452



3x  
6212501



2x  
4654128



1x  
4580010



1x  
6106713



1x  
6451205



1x  
6420457



1x  
6469536



1x  
6167599



1x  
6253187



1x  
6210601



1x  
6092674



2x  
6335566



2x  
4655256



2x  
6469904



2x  
6398008



 [LEGO.com/service](https://www.LEGO.com/service)

YOU COULD **WIN**



Scan this QR code or go to **LEGO.COM/PRODUCTFEEDBACK** and give us your short feedback about this LEGO® set for a chance to win a cool LEGO prize.

Terms and Conditions apply\*

**EN: YOU COULD WIN.** Terms and Conditions apply\* **DE: Du könntest GEWINNEN.** Es gelten die Teilnahmebedingungen\* **FR: Tu pourrais GAGNER.** Des conditions s'appliquent\* **IT: Potresti VINCERE tu.** Termini e condizioni sono applicabili\* **ES: Puedes GANAR.** Aplican términos y condiciones\* **PT: Poderá GANHAR.** Aplicam-se termos e condições\* **ZH: 轻松获奖. 条款和条件适用\*** **PL: Szansa na WYGRANĄ.** Obowiązują warunki korzystania\* **CS: Máte šanci VYHRÁT.** Platí všeobecné smluvní podmínky\* **SK: Máte šancu VYHRAŤ.** Platia všeobecné zmluvné podmienky\* **HU: TE IS NYERHETSZ.** Felhasználási feltételek érvényesek\* **RO: Ai putea CÂȘTIGA.** Se aplică termeni și condiții\* **BG: Можете да СПЕЧЕЛИТЕ.** Има определени правила и условия\* **LV: Tu vari LAIMĒT.** Ir spēkā noteikumi un nosacījumi.\* **ET: Sul on võimalus VÕITA.** Kehtivad tingimused\* **LT: Jūs galite LAIMĖTI.** Taikomos sąlygos\*

\*[LEGO.com/productfeedback-terms](https://www.lego.com/productfeedback-terms)