



SPEED
CHAMPIONS

76919



LEGO® Builder



Get excited about our new packaging!

We're switching from plastic to paper-based packaging. That's why you might find a mix of paper and plastic in our boxes!

Nos nouveaux emballages vous emballeront !

Nous passons des emballages en plastique aux emballages à base de papier. C'est pourquoi vous pourriez trouver un mélange de papier et de plastique dans nos boîtes !

¡Te presentamos nuestros nuevos empaques!

Estamos sustituyendo las bolsas de plástico por bolsas con base de papel. ¡Por eso, puedes encontrar una mezcla de papel y de plástico en nuestras cajas!

[LEGO.com/sustainable-packaging](https://www.lego.com/sustainable-packaging)



Q LEGO® Builder

BUILDER



Apple and the Apple logo are trademarks of Apple Inc., registered in the U.S. and other countries and regions. App Store is a service mark of Apple Inc. Google Play and the Google Play logo are trademarks of Google LLC. Tencent and the Tencent logo are trademarks of Tencent Inc.

Q [LEGO.com/devicecheck](https://lego.com/devicecheck)

EN Ask parents' permission before going online | **DE** Eltern um Erlaubnis bitten, bevor du online gehst | **FR** Demande l'autorisation d'un parent avant d'aller en ligne | **IT** Chiedi il permesso ai tuoi genitori prima di andare online | **ES** Pídeles permiso a tus papás antes de conectarte a Internet | **PT** Pede autorização aos pais antes de acederes online | **ZH** 上网前应先征得父母的同意 | **PL** Poproś rodziców o zgodę, zanim wejdziesz do Internetu | **CS** Než půjdeš na internet, požádej rodiče o svolení | **SK** Skôr než pôjdeš na internet, vypýtaj si povolenie od rodičov | **HU** Kérj szülői engedélyt, mielőtt online csatlakoznál! | **RO** Cere permisiunea părinților înainte de a te conecta online | **BG** Поискайте разрешение от родител, преди да влезете онлайн | **LV** Pirms došanās tiešsaistē palūdz atļauju vecākiem | **ET** Enne Interneti kasutamist küsi vanematelt luba | **LT** Prieš prisijungdami prie interneto, atsiklauskite tėvų

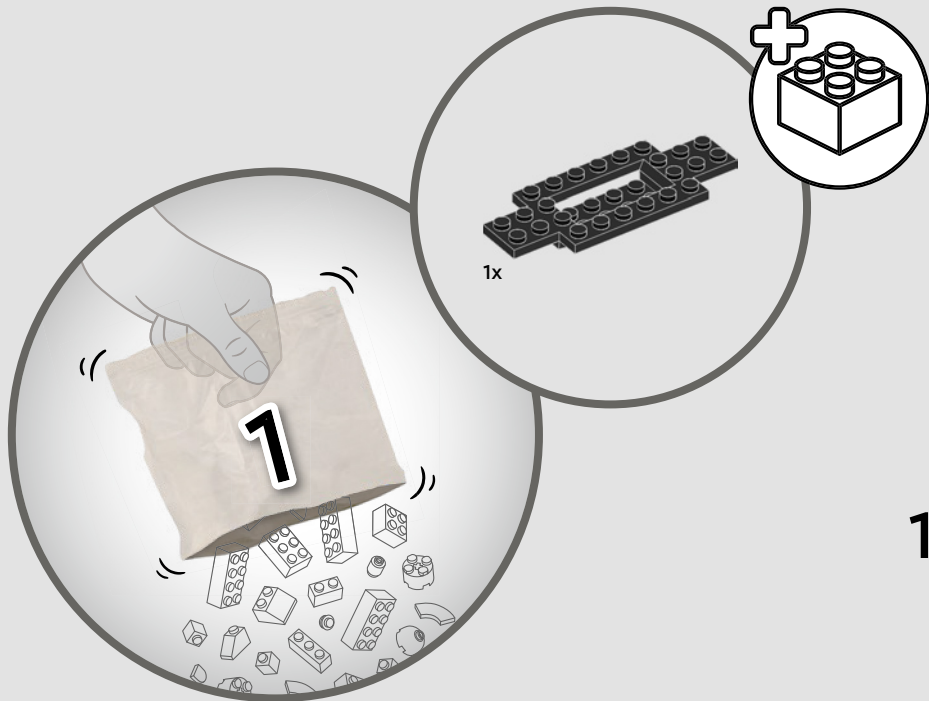

1

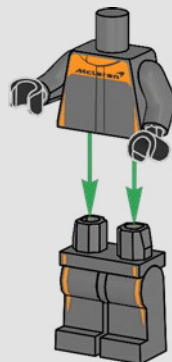

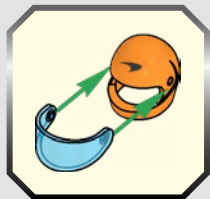

2

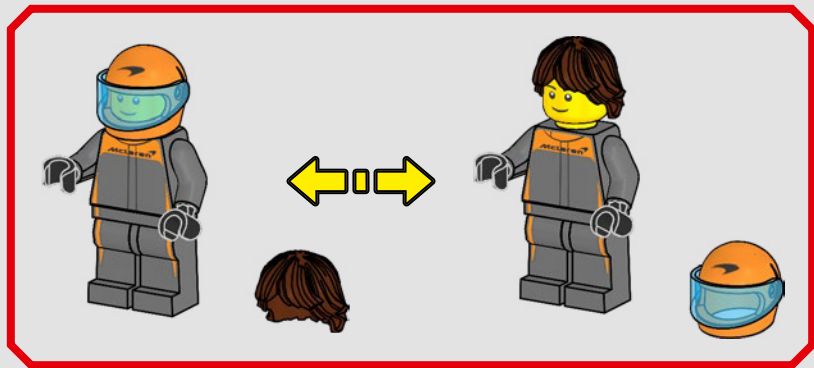

3



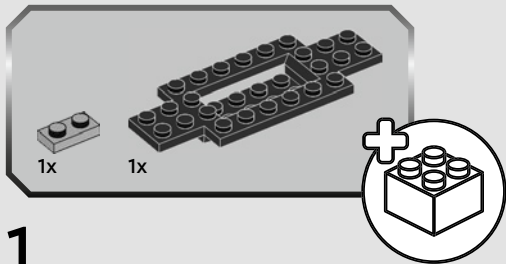

1

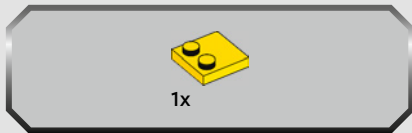
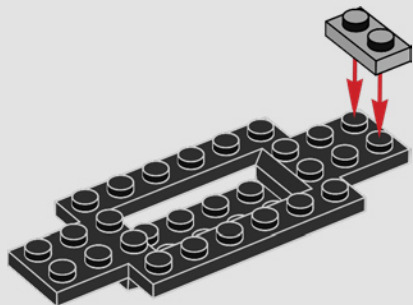

2

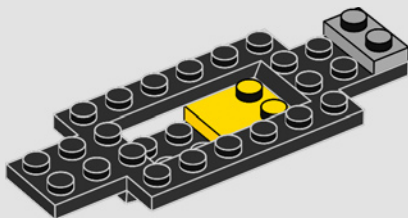

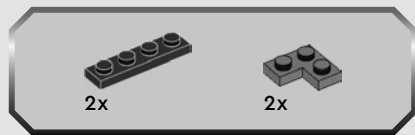

3

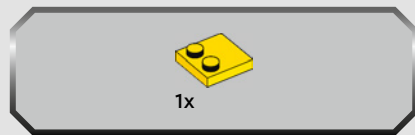
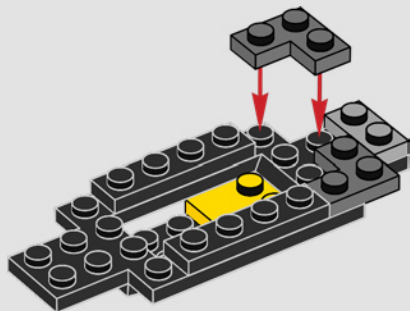

4

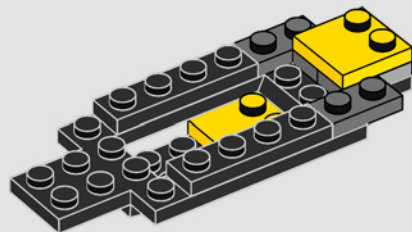



2x



2x

5

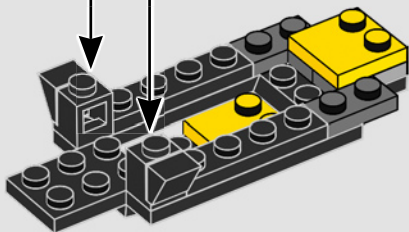
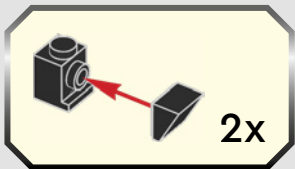

1x



1x

6

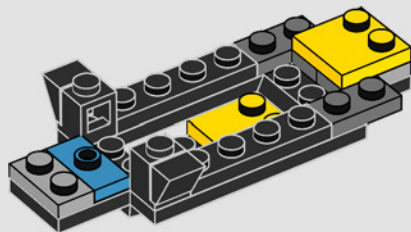

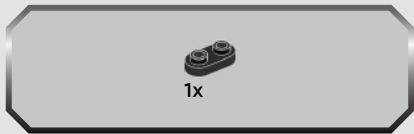

7

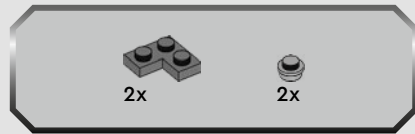
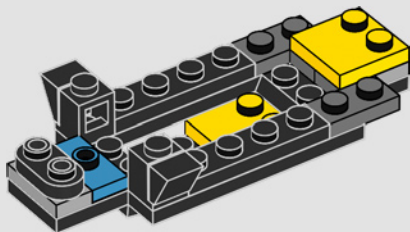

8

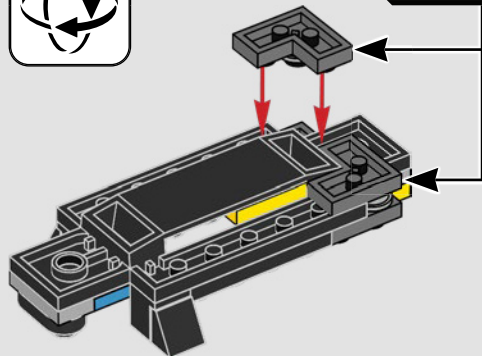
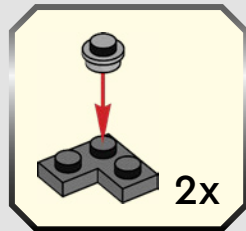

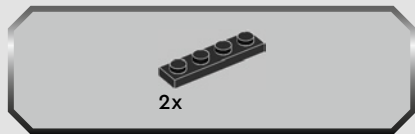

9

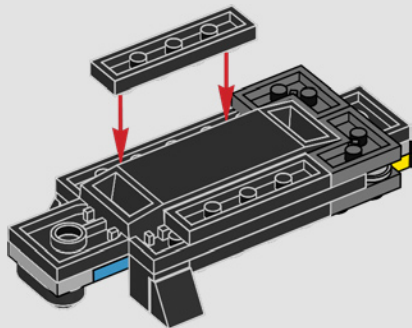

10

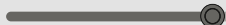
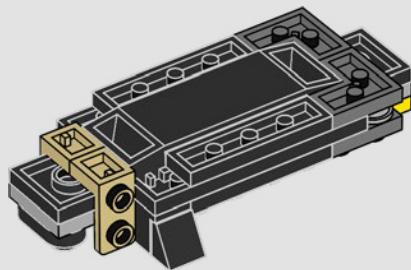

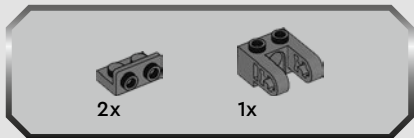

11

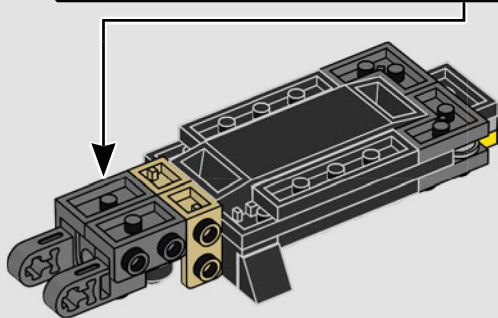
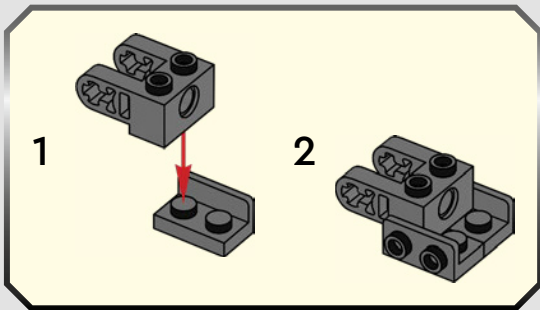

12

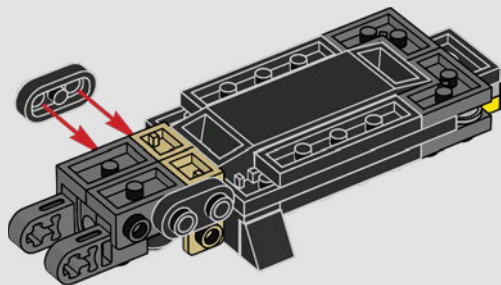



13

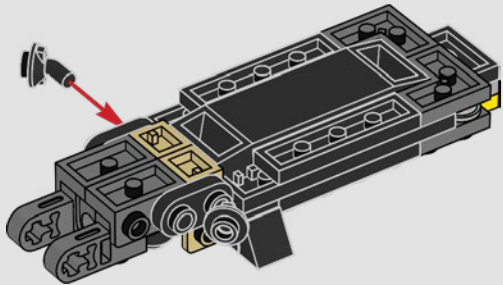

14

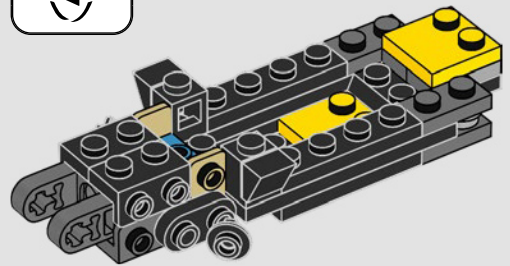

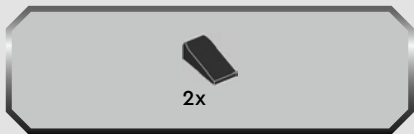

15

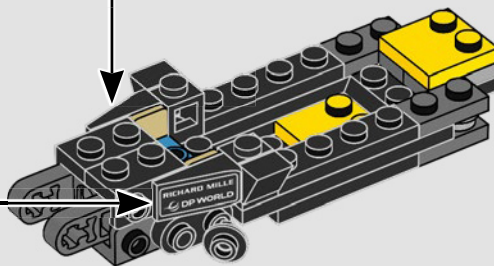
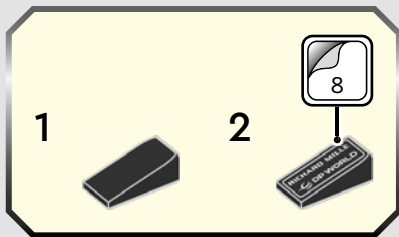
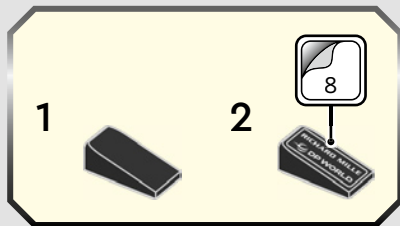



16

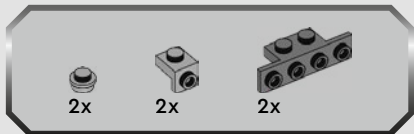
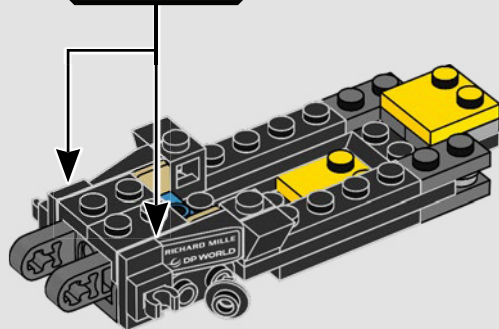
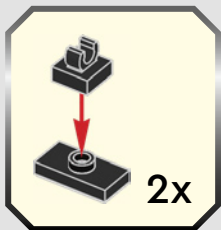

17

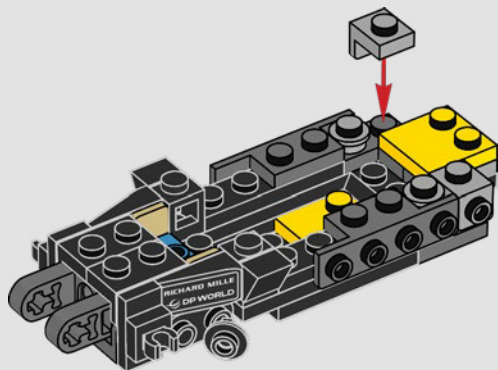

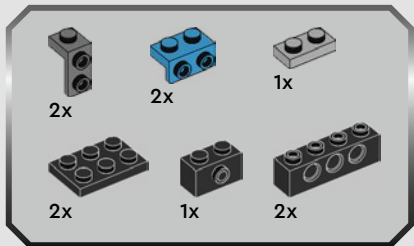
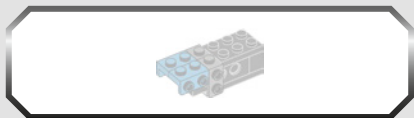

18

1

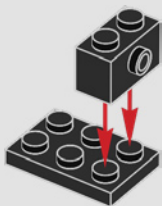

2

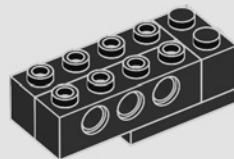

3

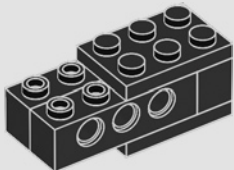

4

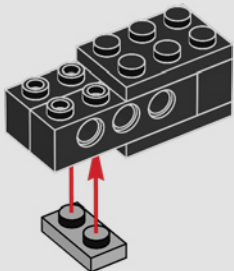

5

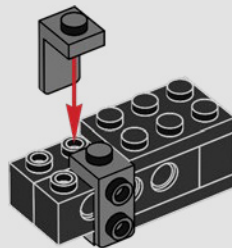

6

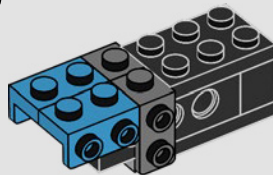

19

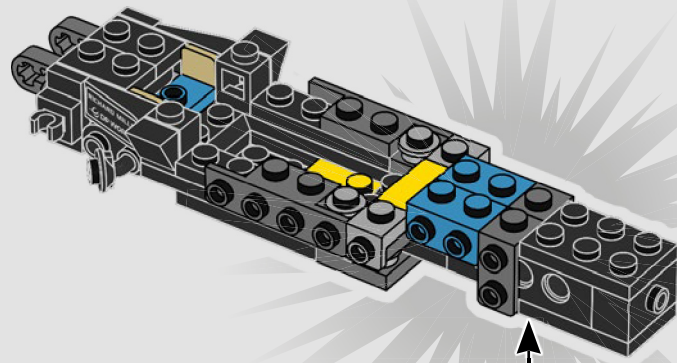



2x

20

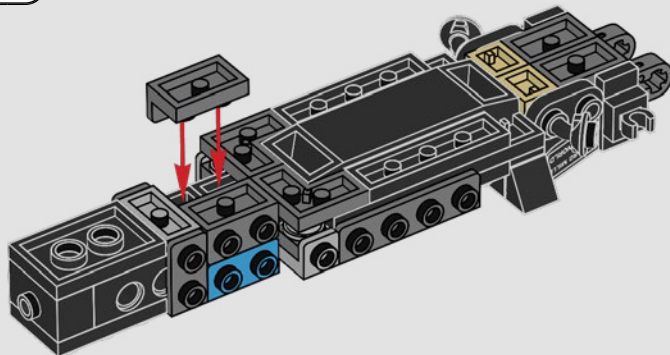



21

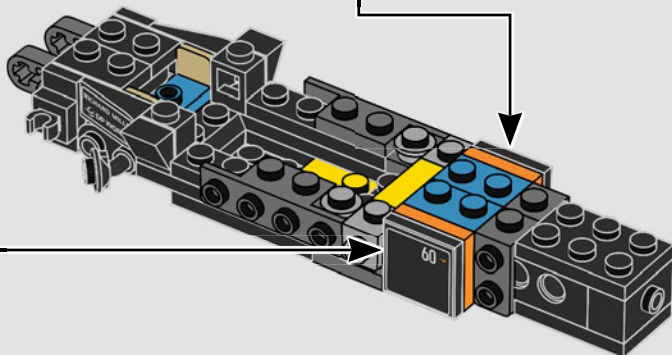
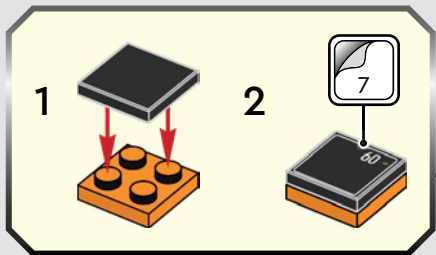
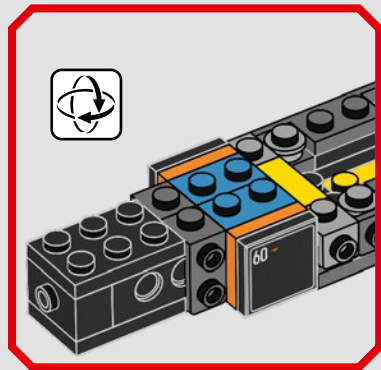
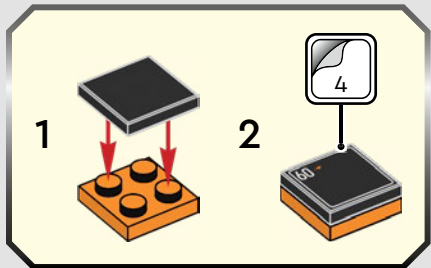



22

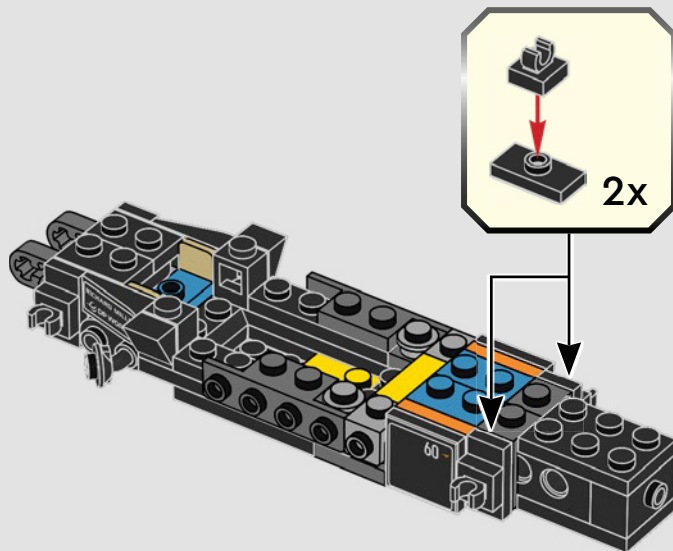



23

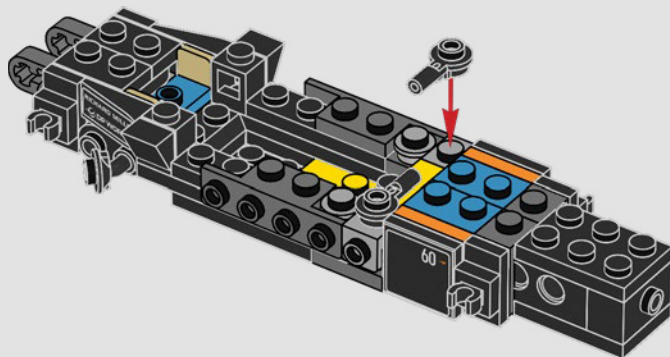



24

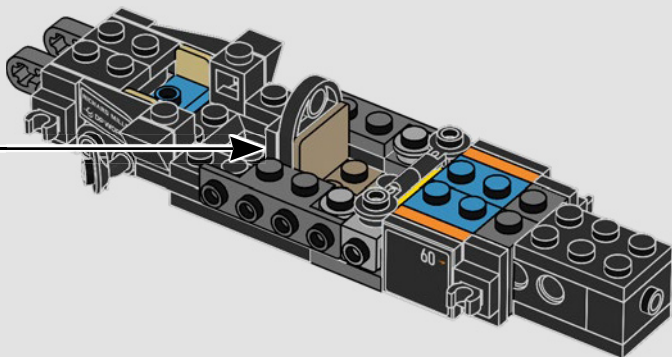
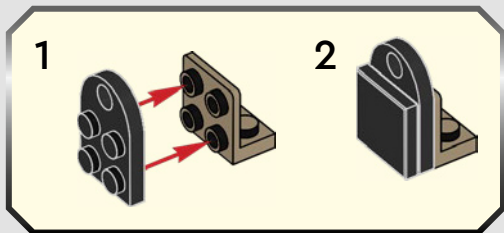
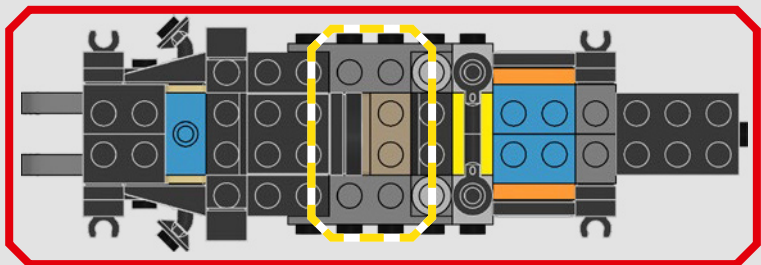



25

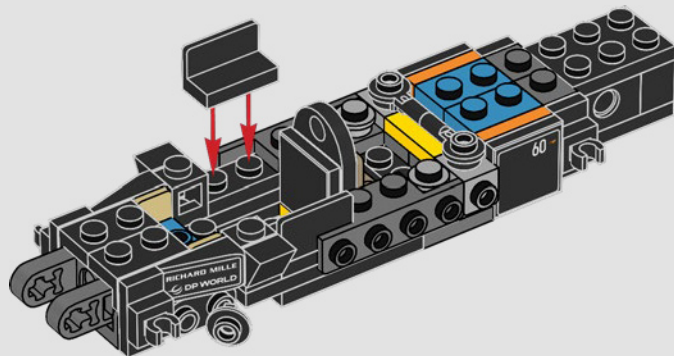



26

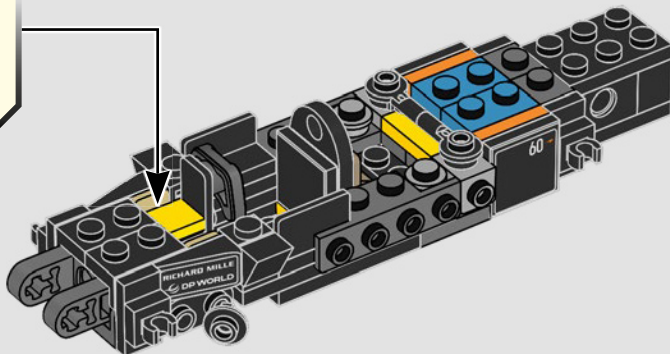
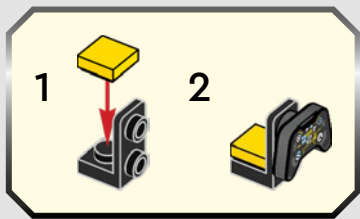



27

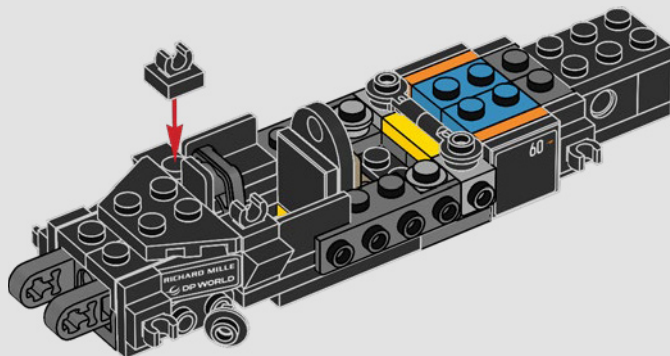



28

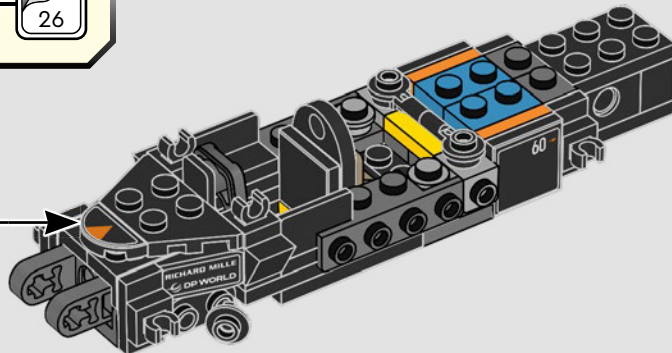
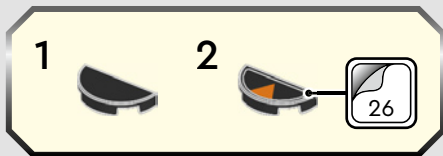



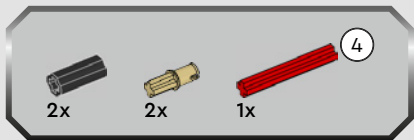

30

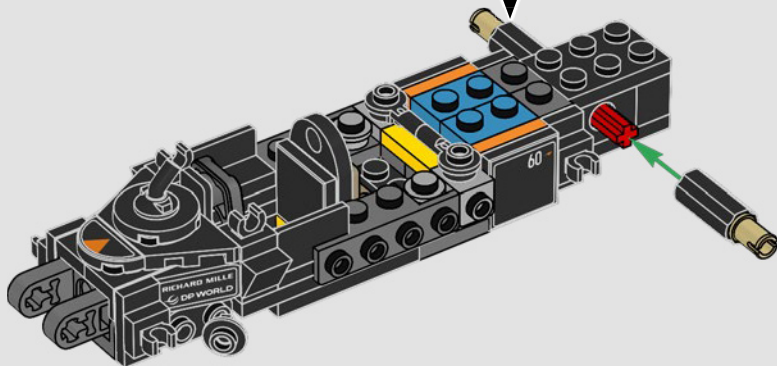
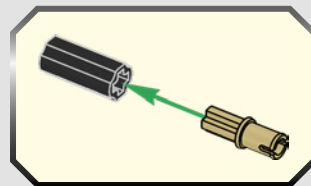
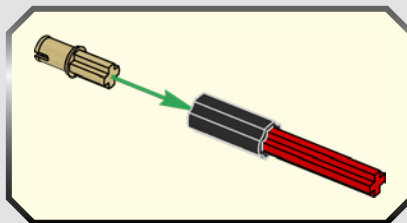



31

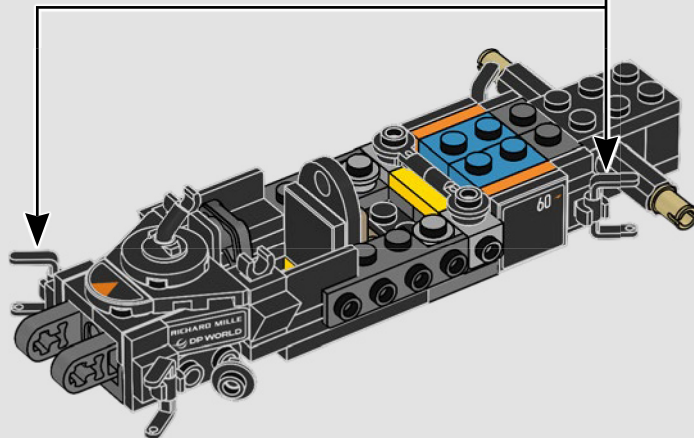

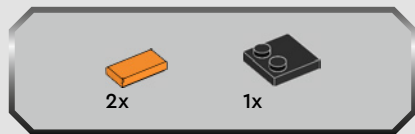

32

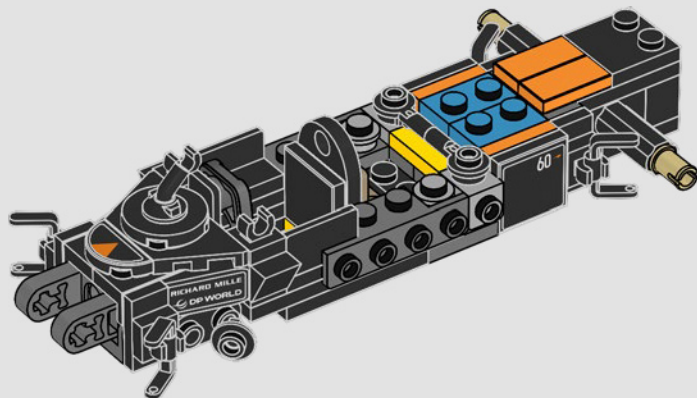

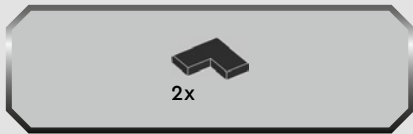

33

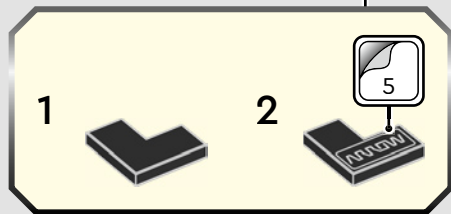
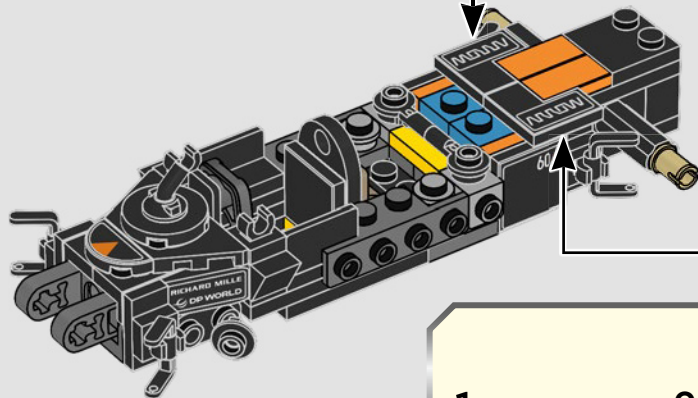
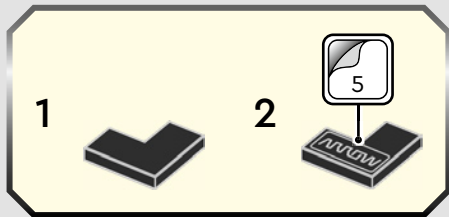



34

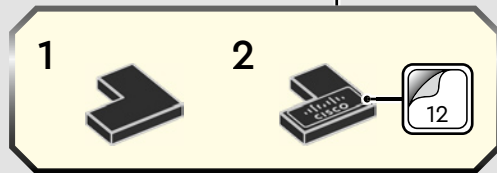
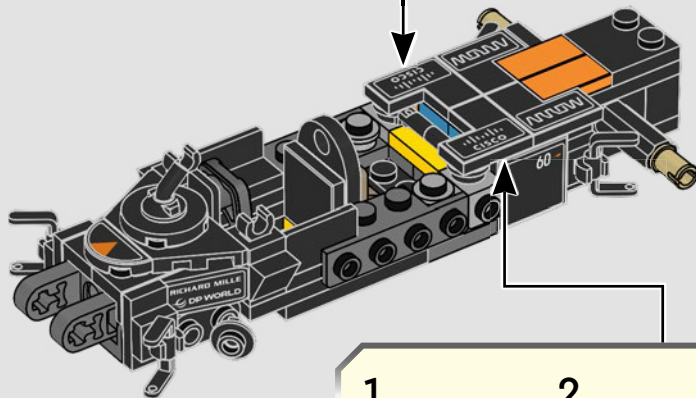
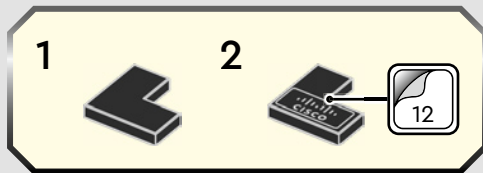

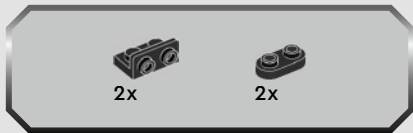

35

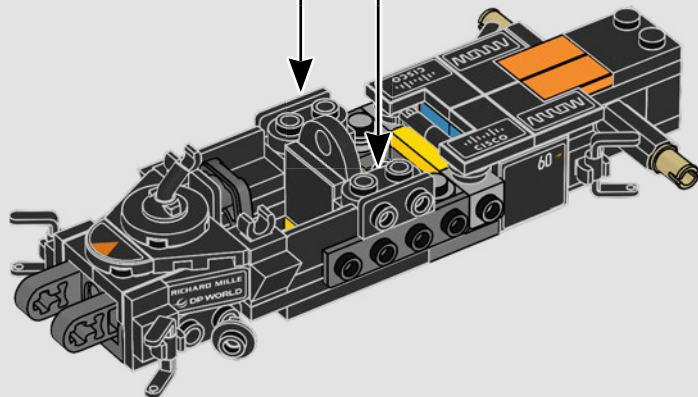
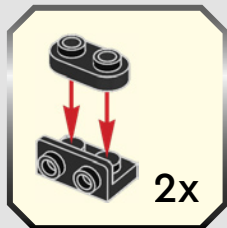

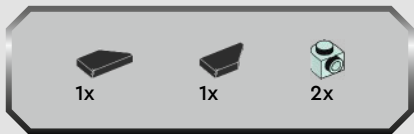

36

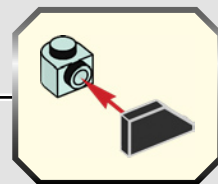
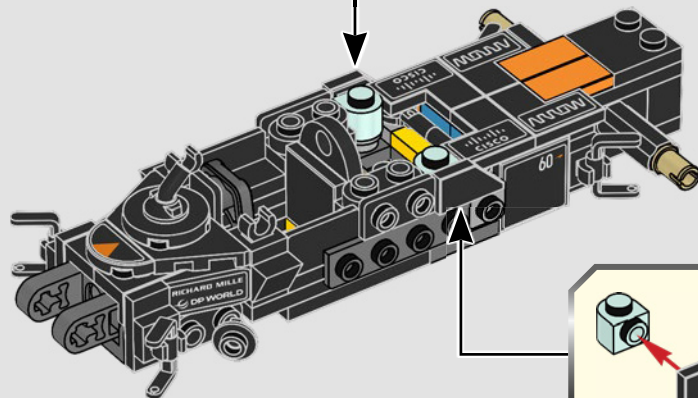
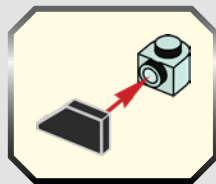



37

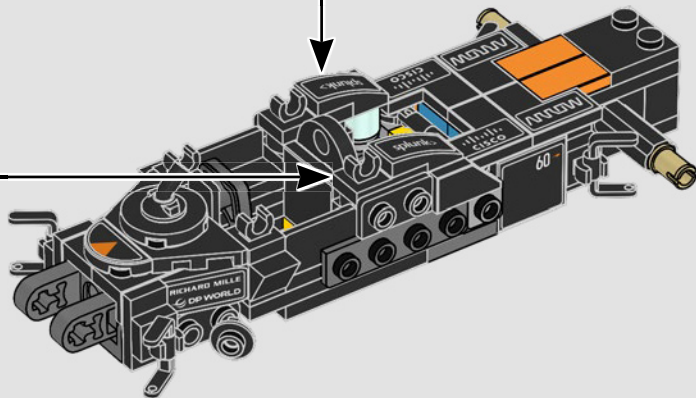
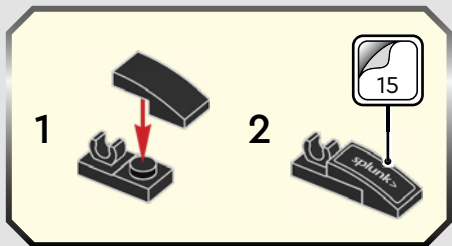
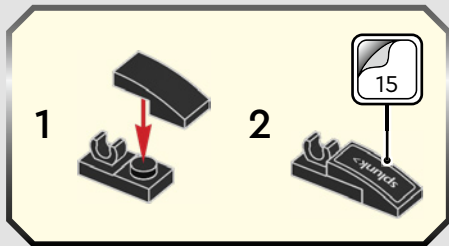



38

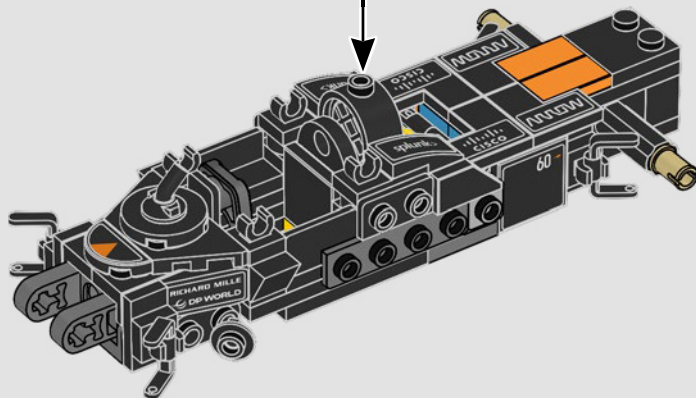



1x

39

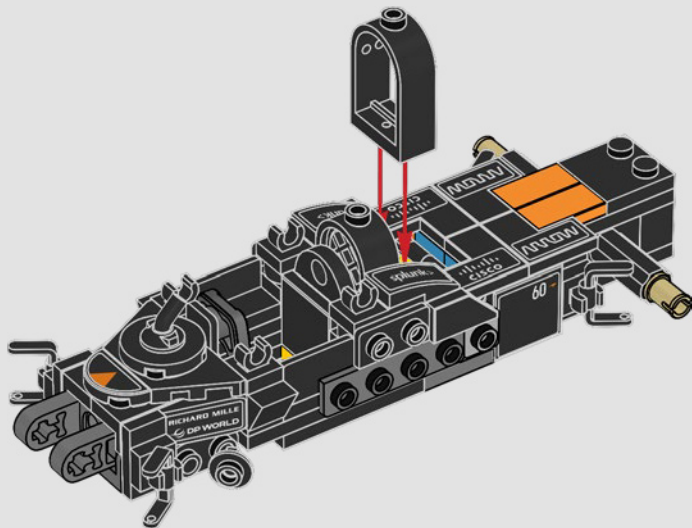



40

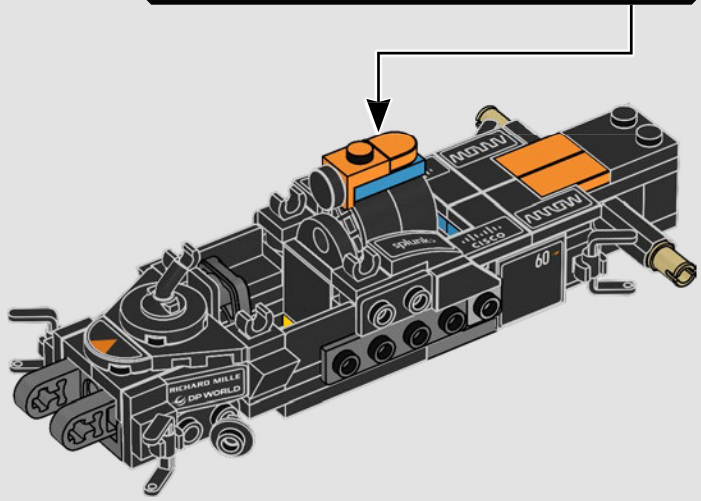
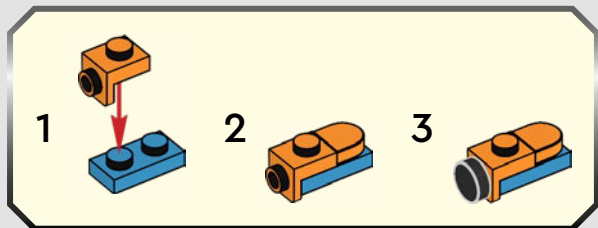

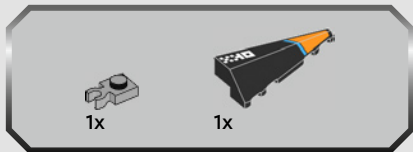

41

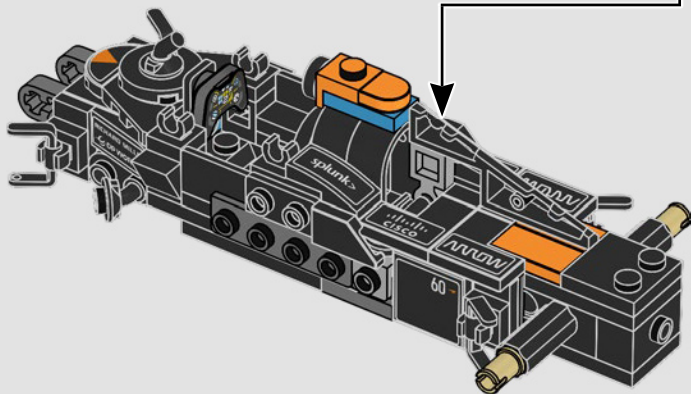
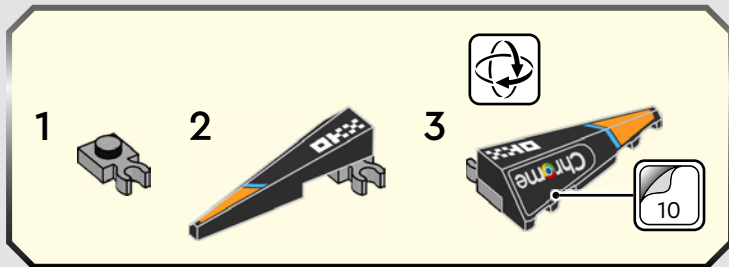

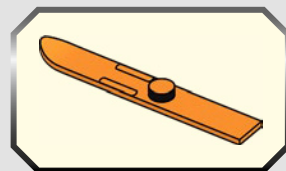
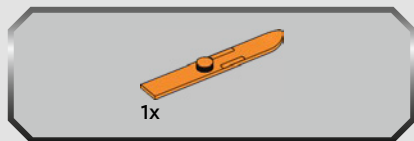

42

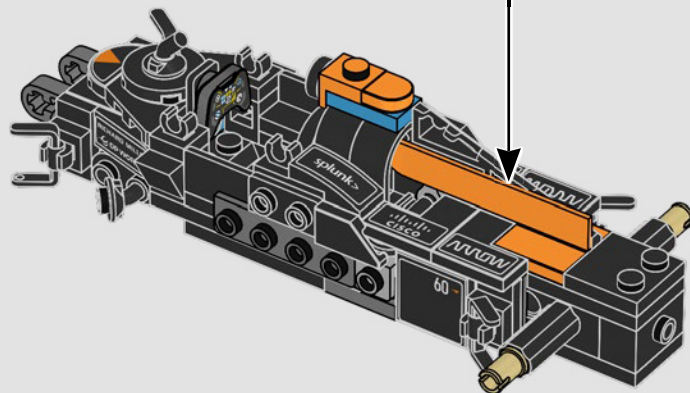

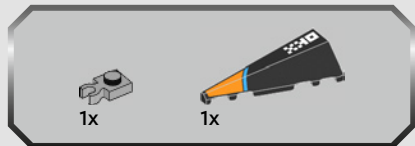

43

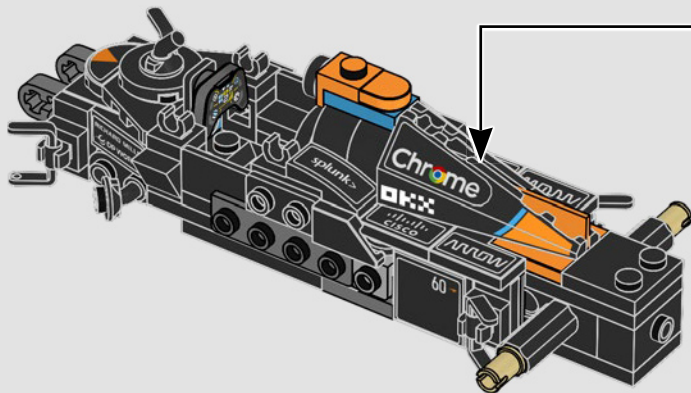
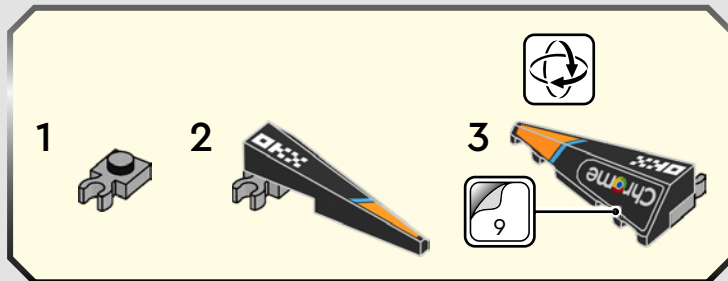

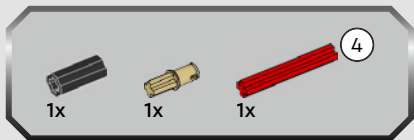

44

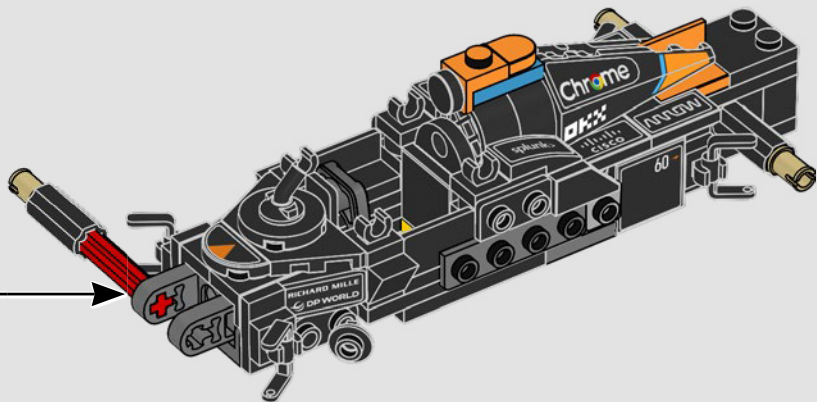
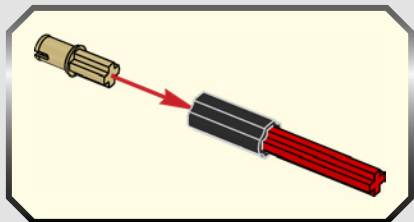

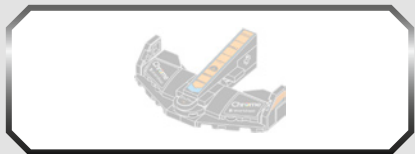

45

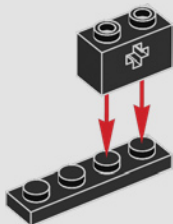

46

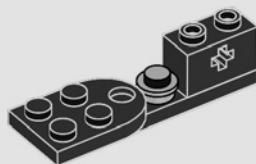

47

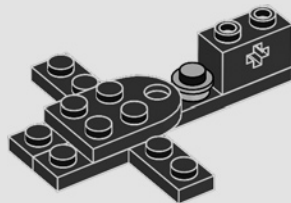



48

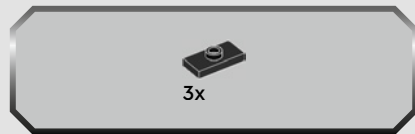
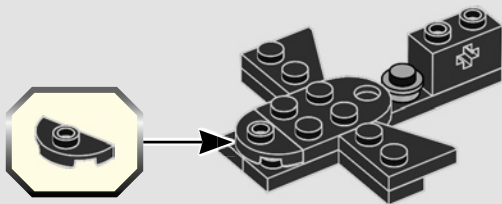

49

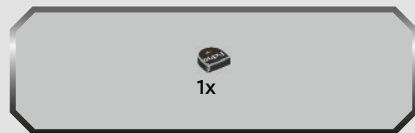
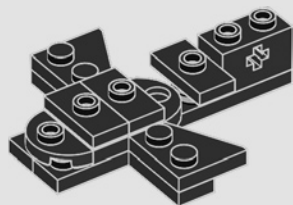

50

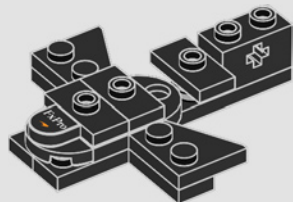

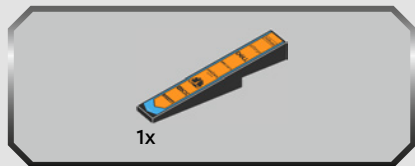

51

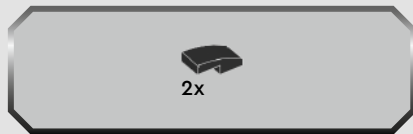
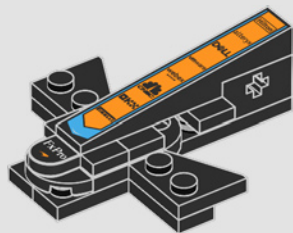

52

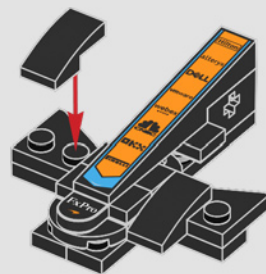



53

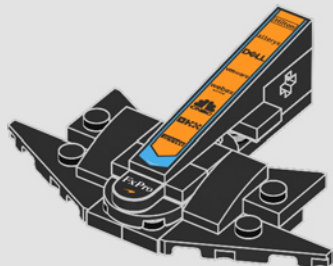

54

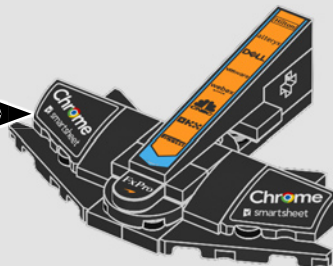
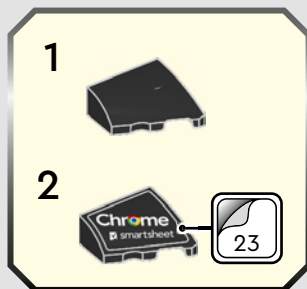

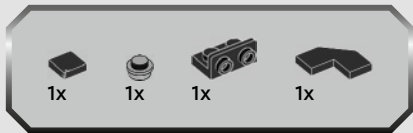

55

1



2

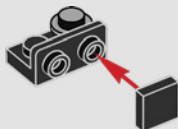

3

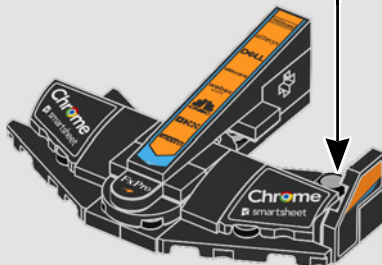

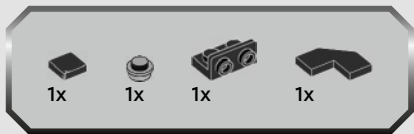

56

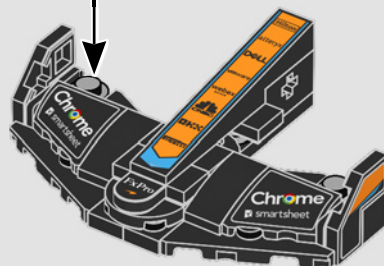
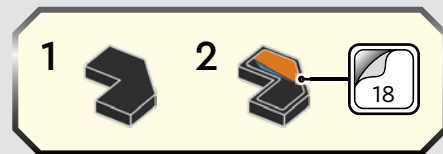
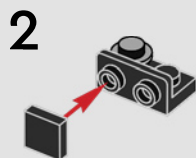
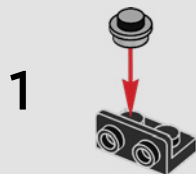

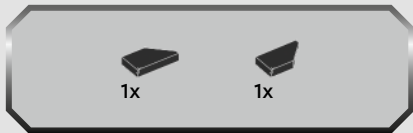

57

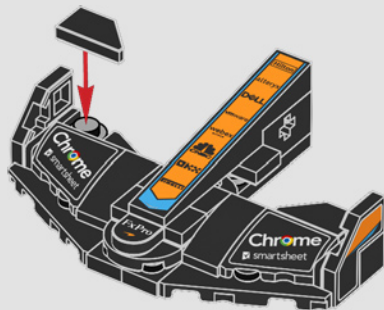

58

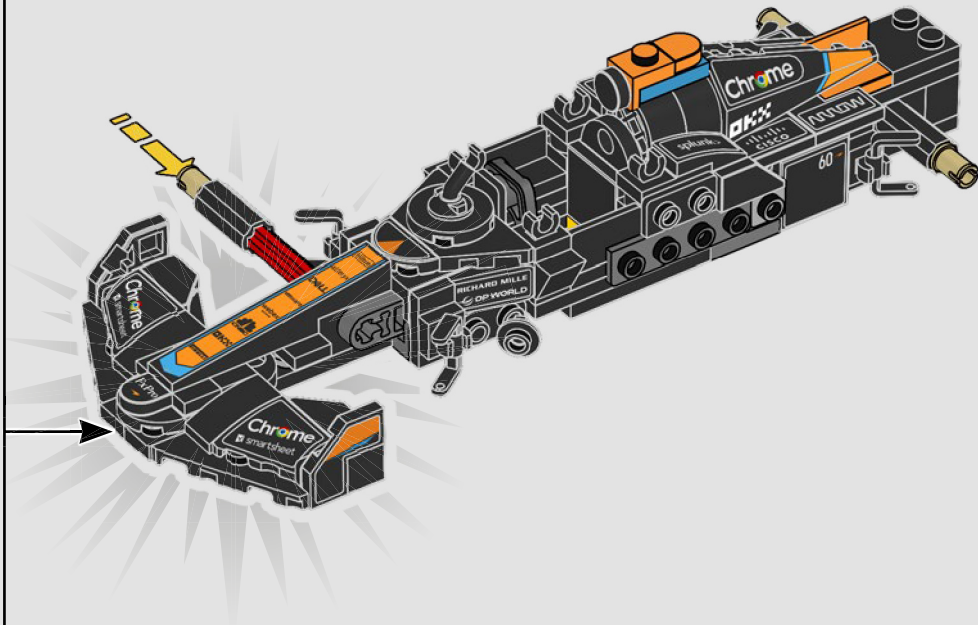



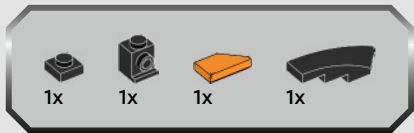

60

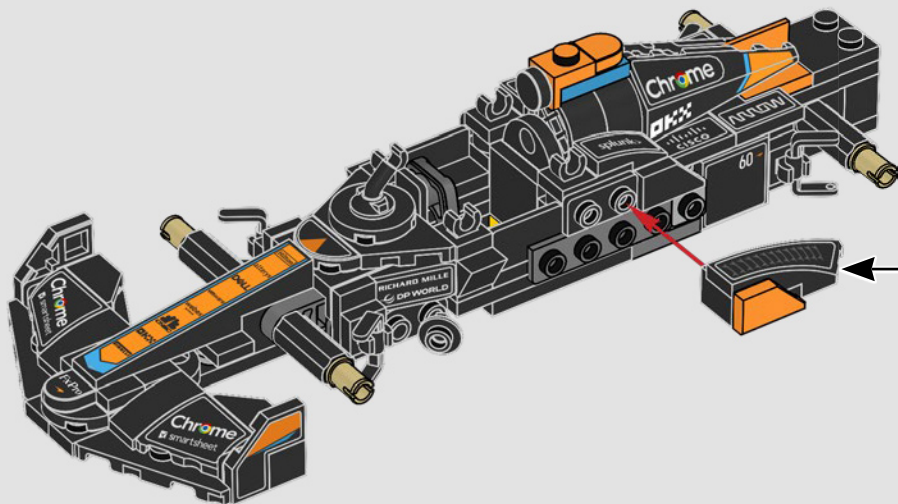
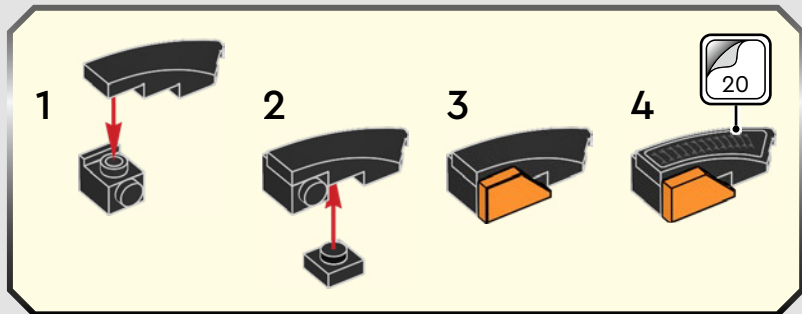

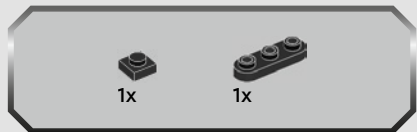

61

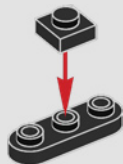

62

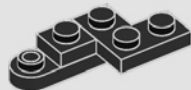

63

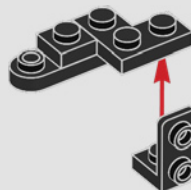

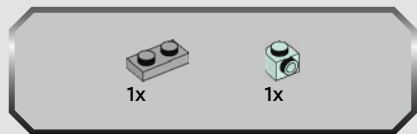

64

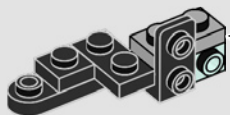
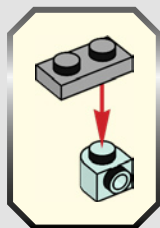

65

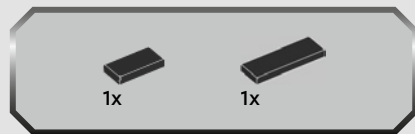
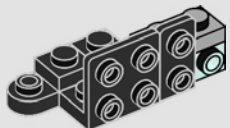

66

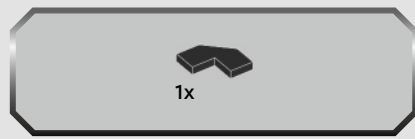
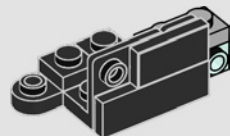

67

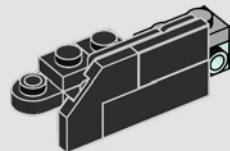

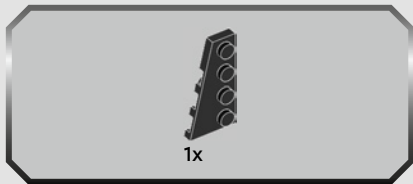

68

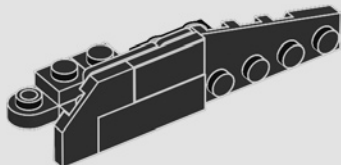

69

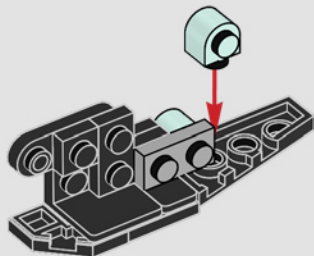

70

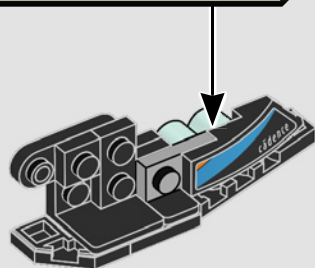
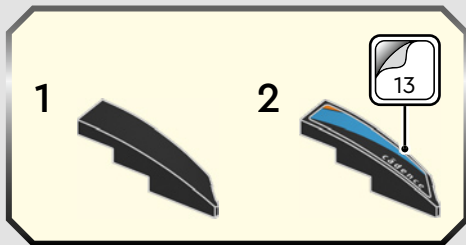

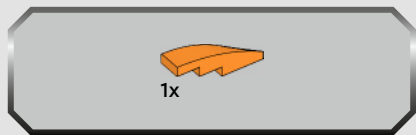

71

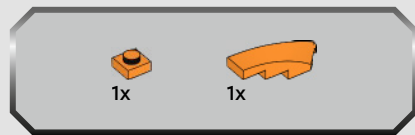
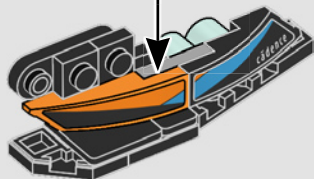
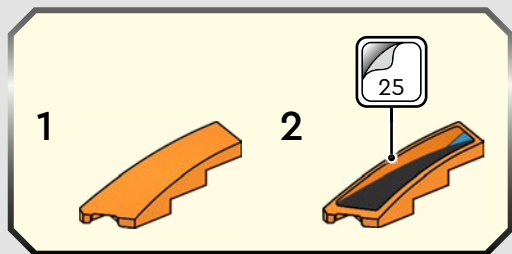

72

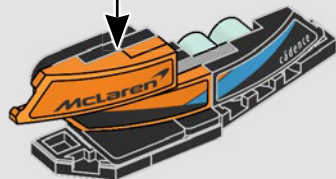
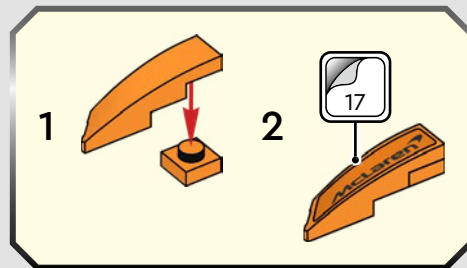

73

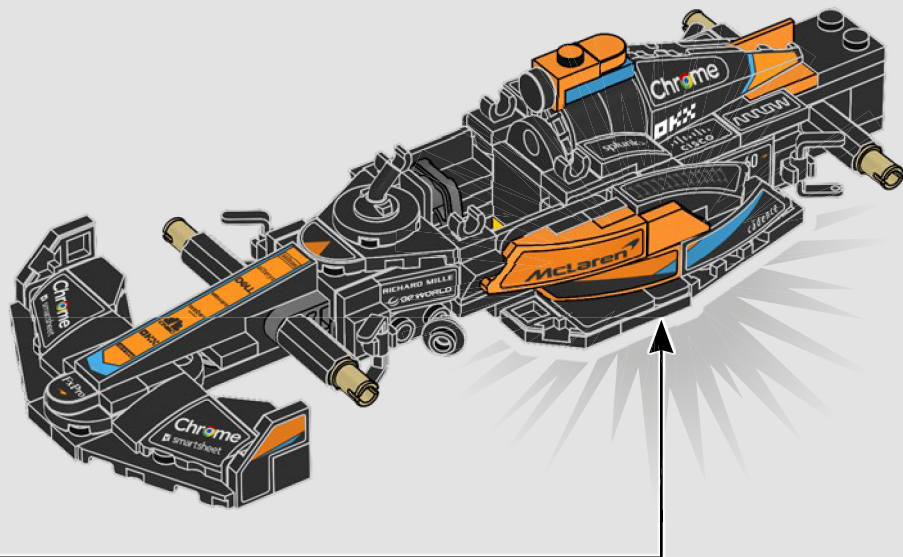



1x

74

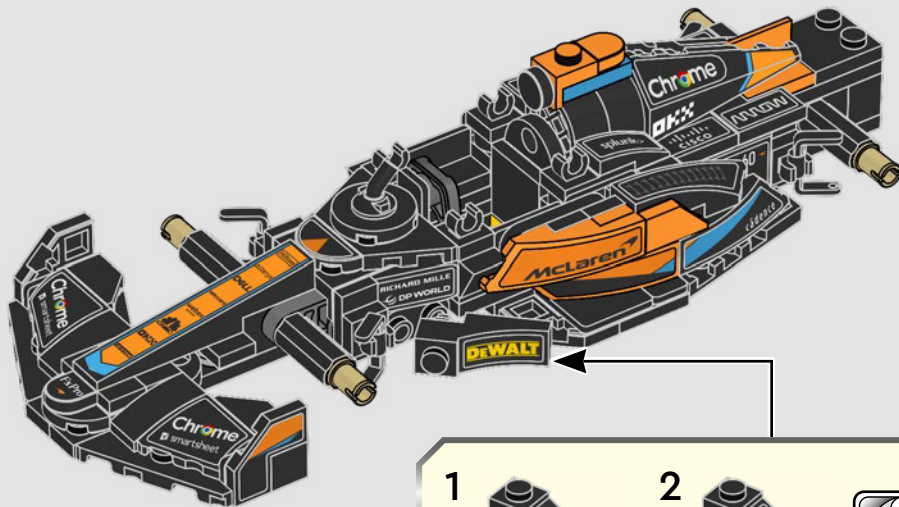

1

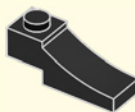

2

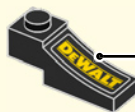

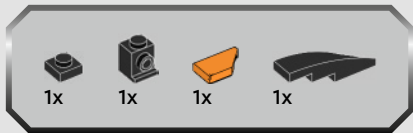

75

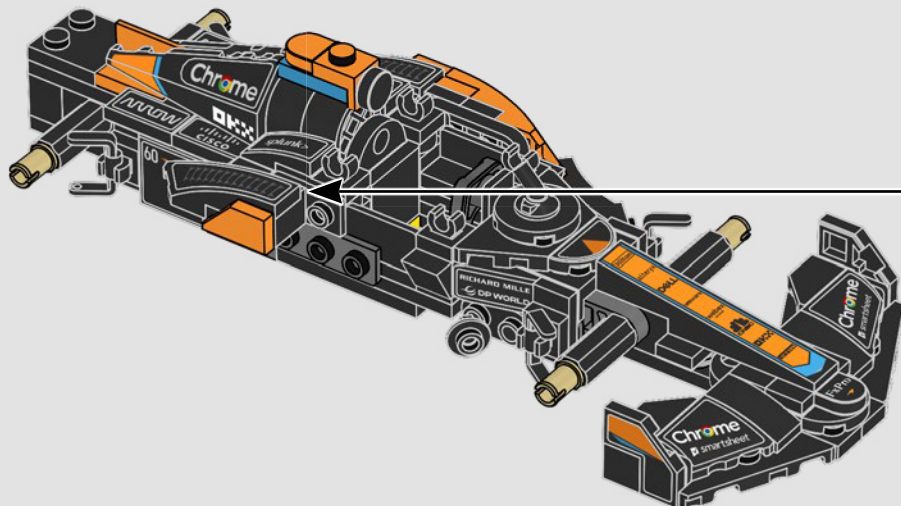
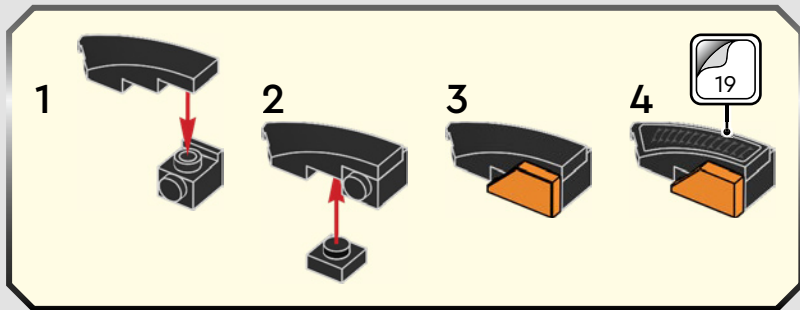

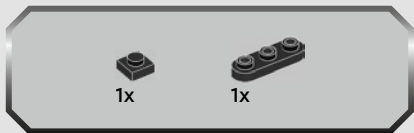

76

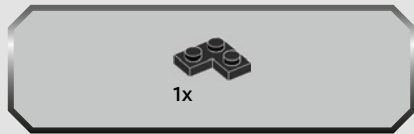

77

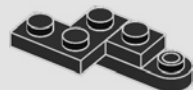

78

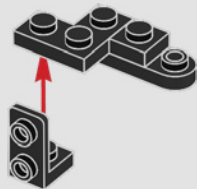

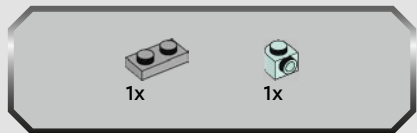

79

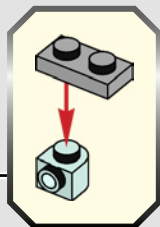

80

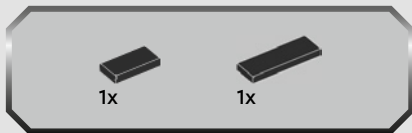
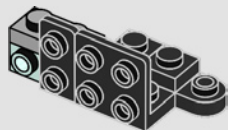

81

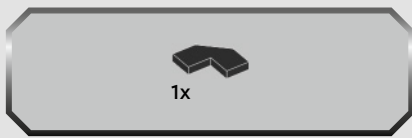
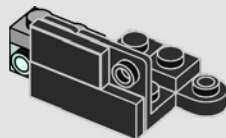

82

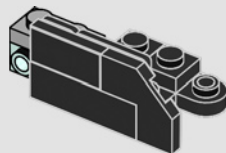

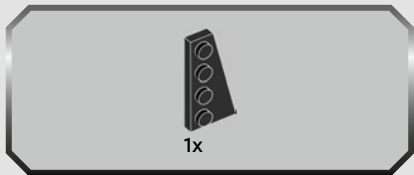

83

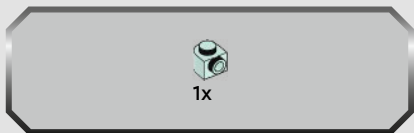
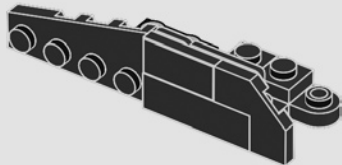

84

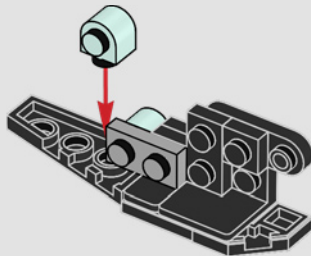
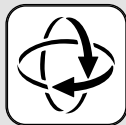

85

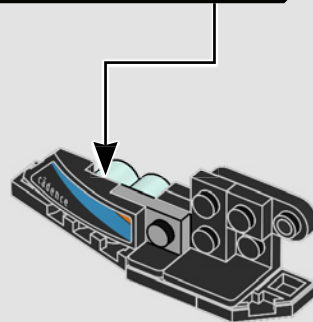
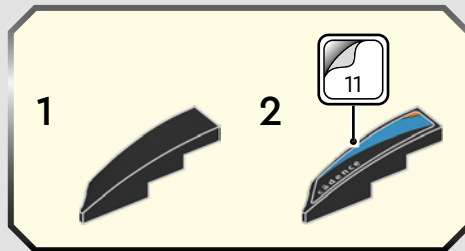

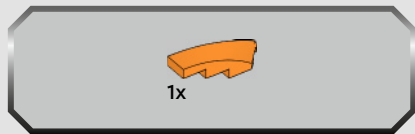

86

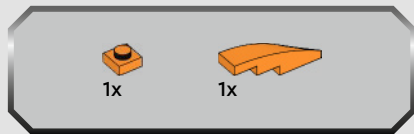
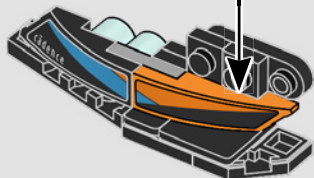
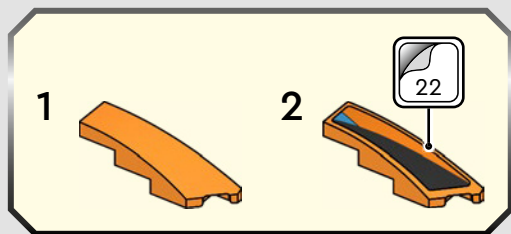

87

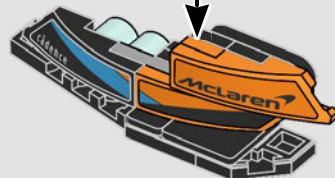
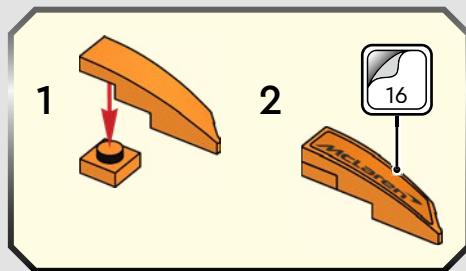

88

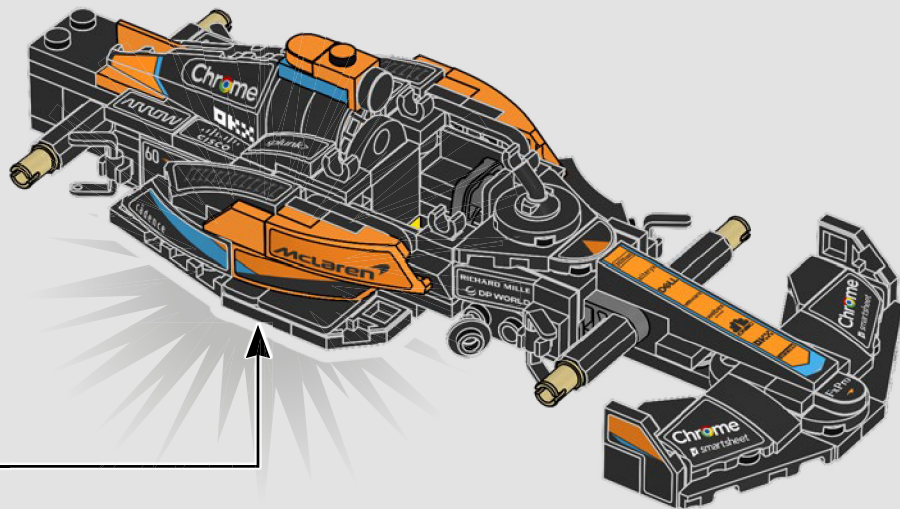

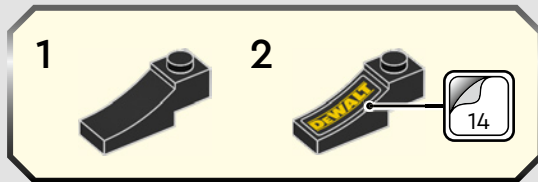
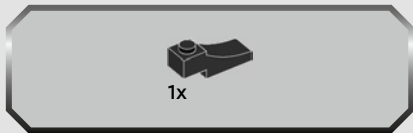

89

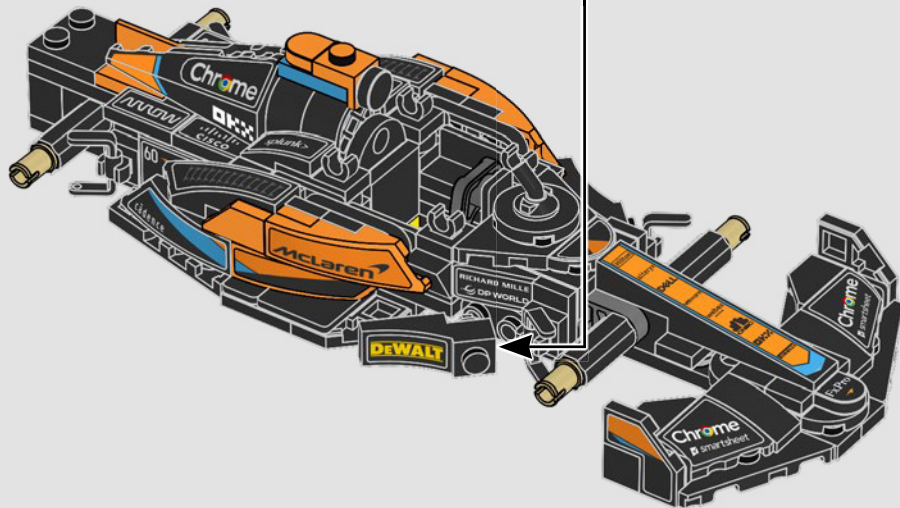



93

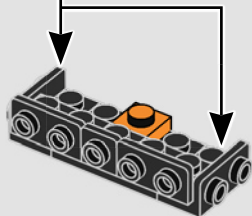
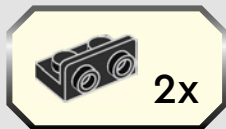

94

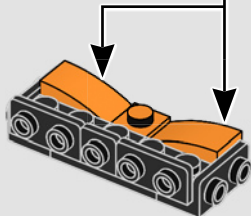
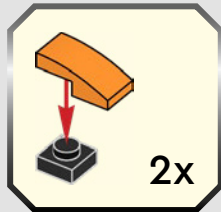

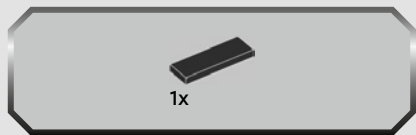

95

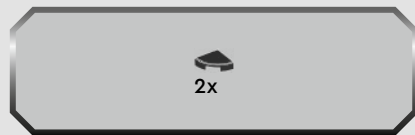
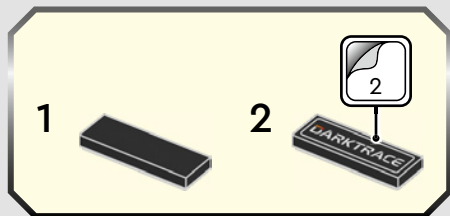

96

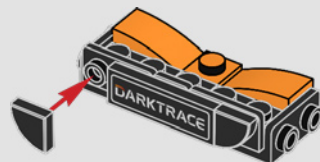

97

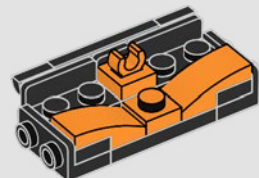



98

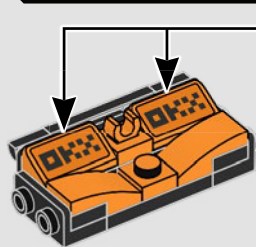
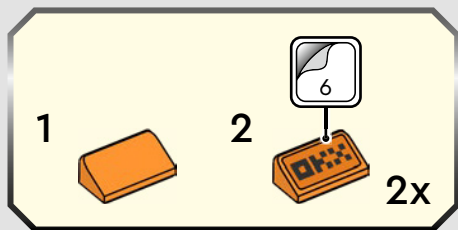

99

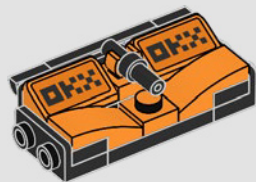

100

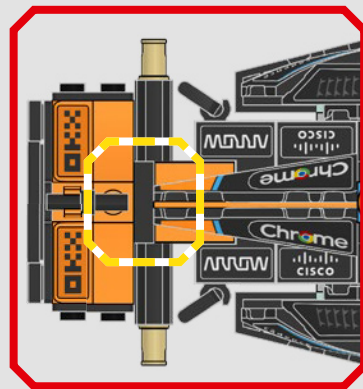
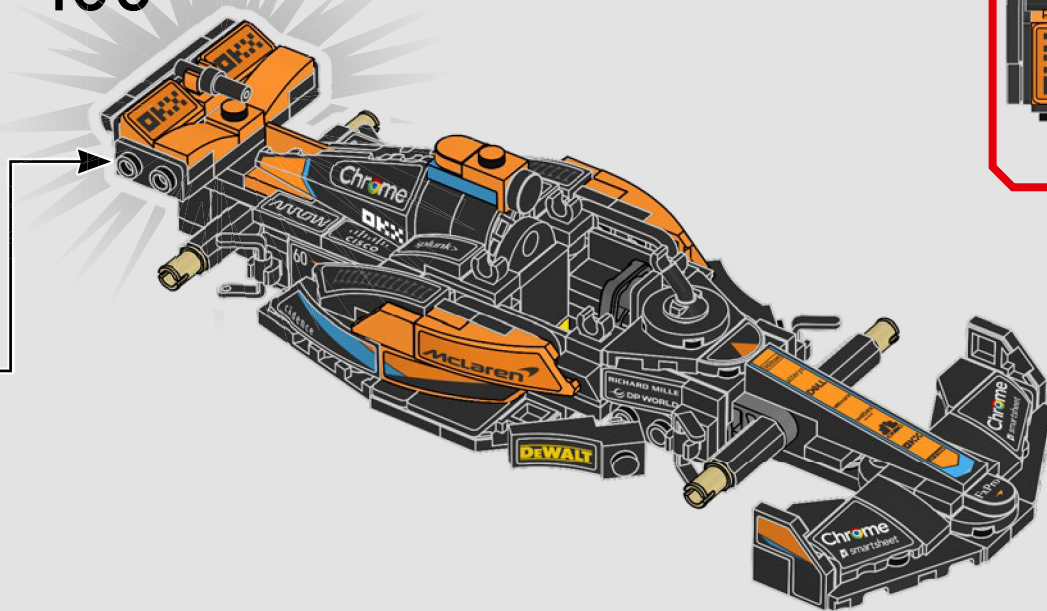

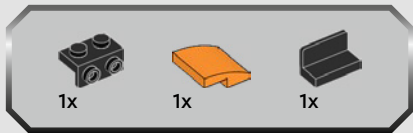

101

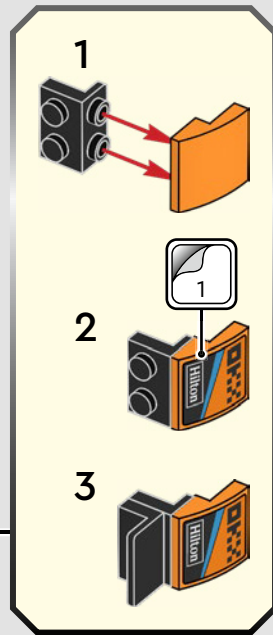
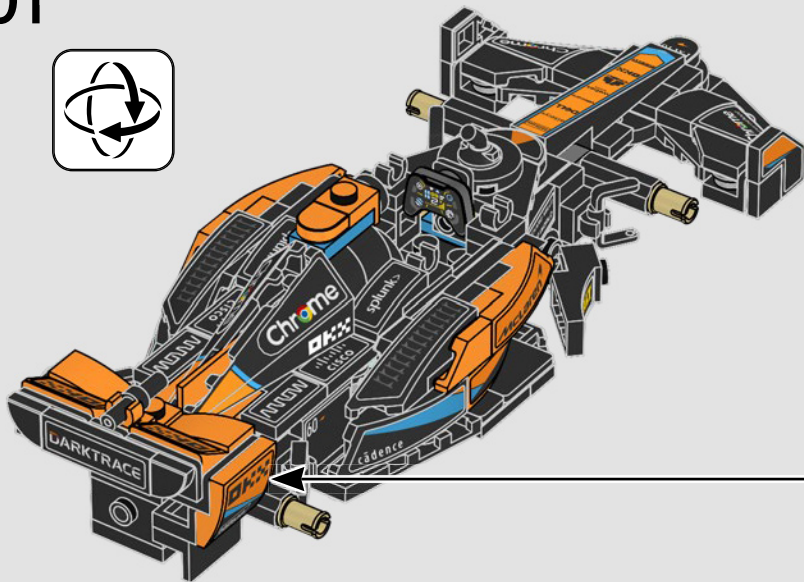

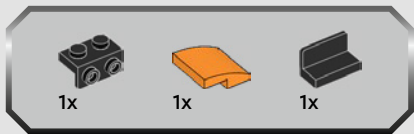

102

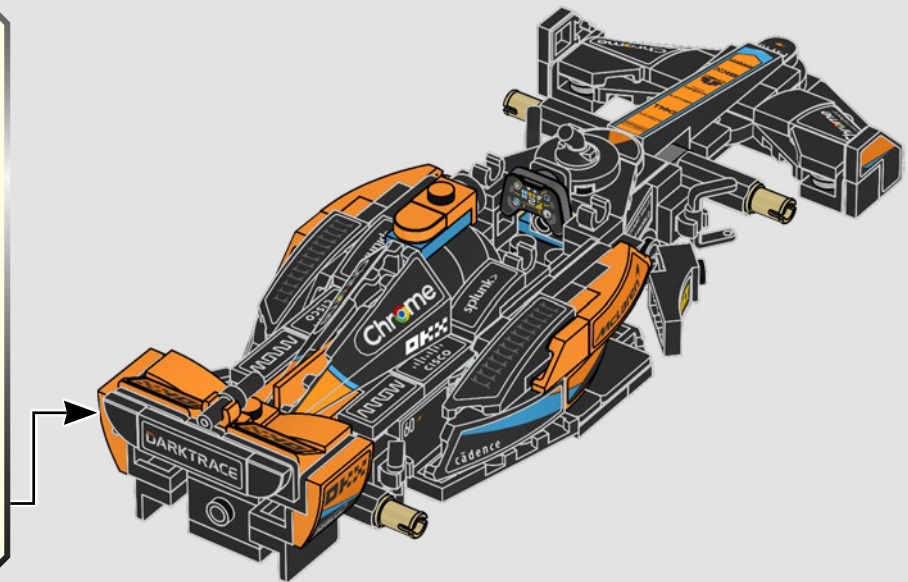
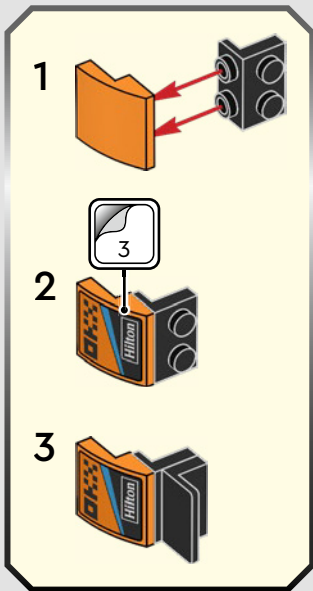



1x



1x

103

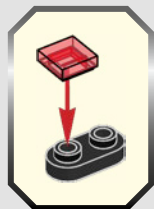
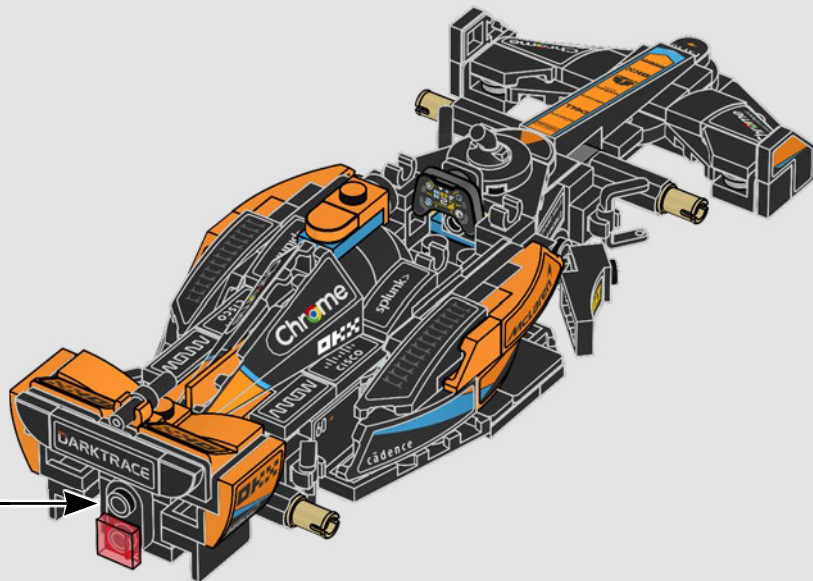

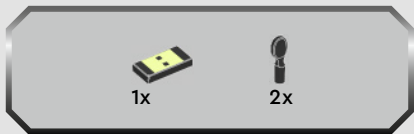

104

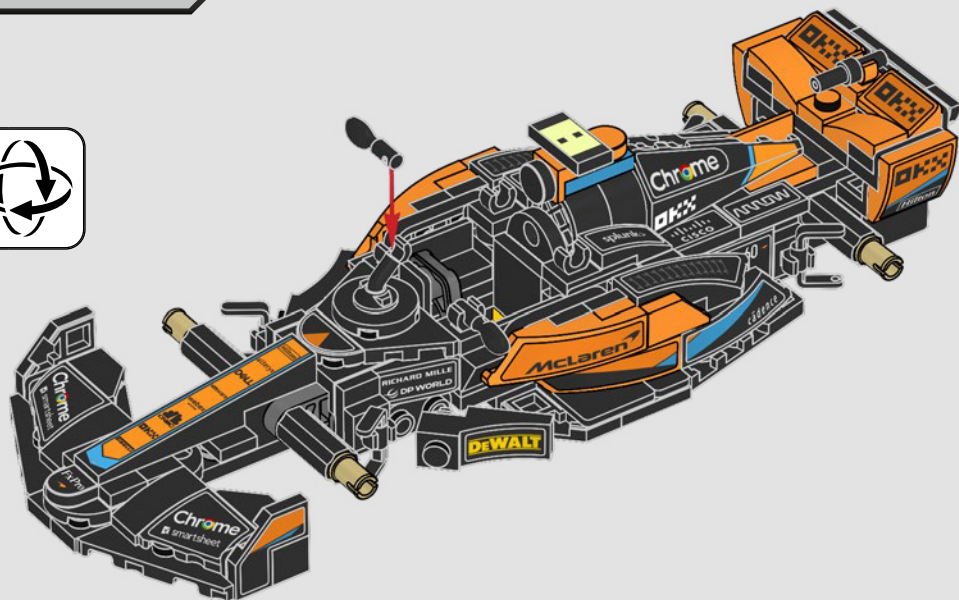
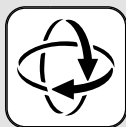

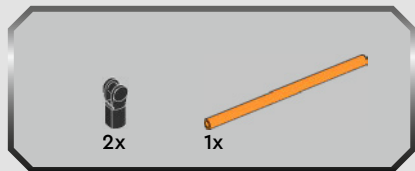

105

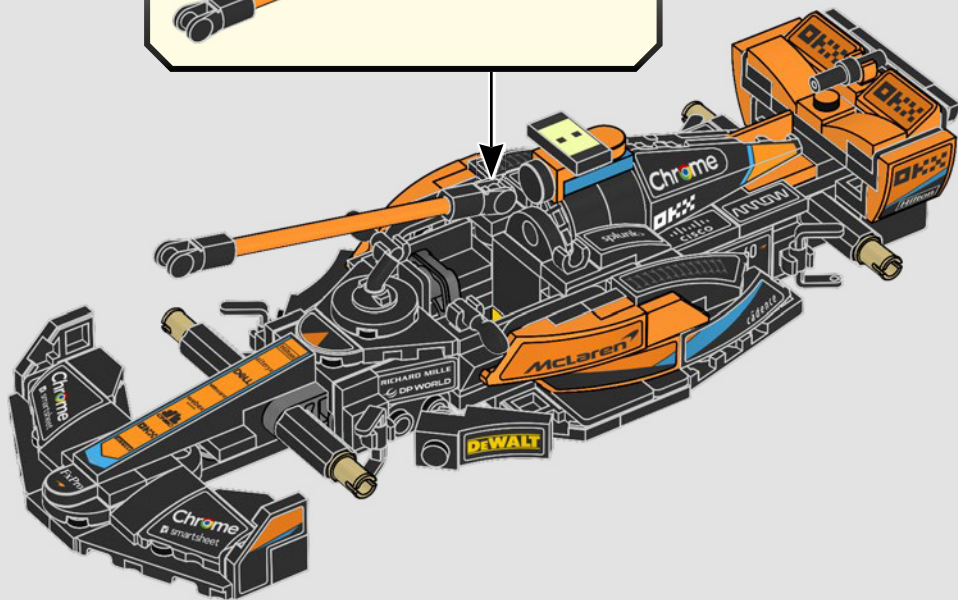
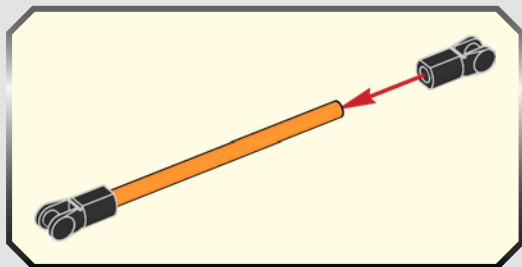

106

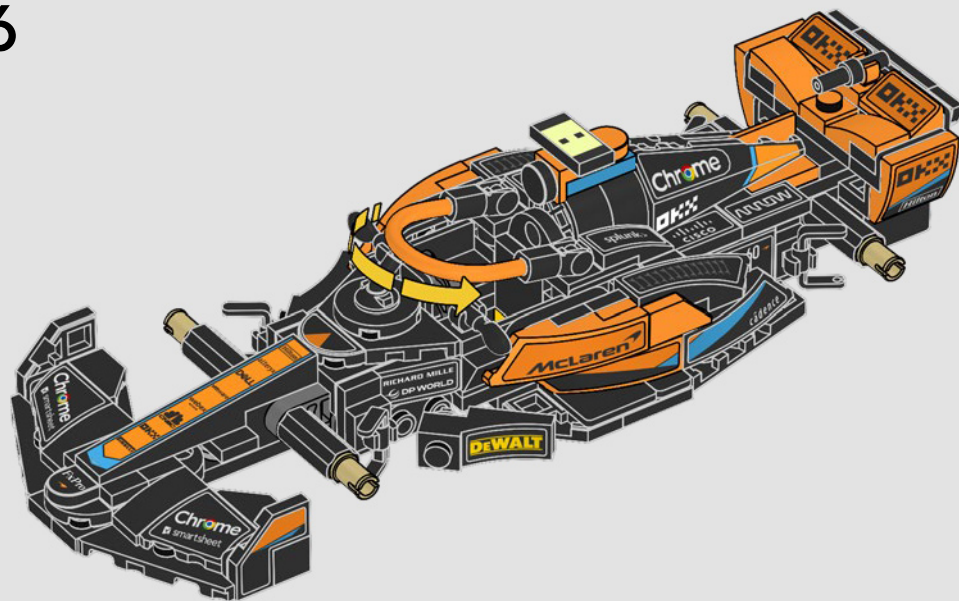



107

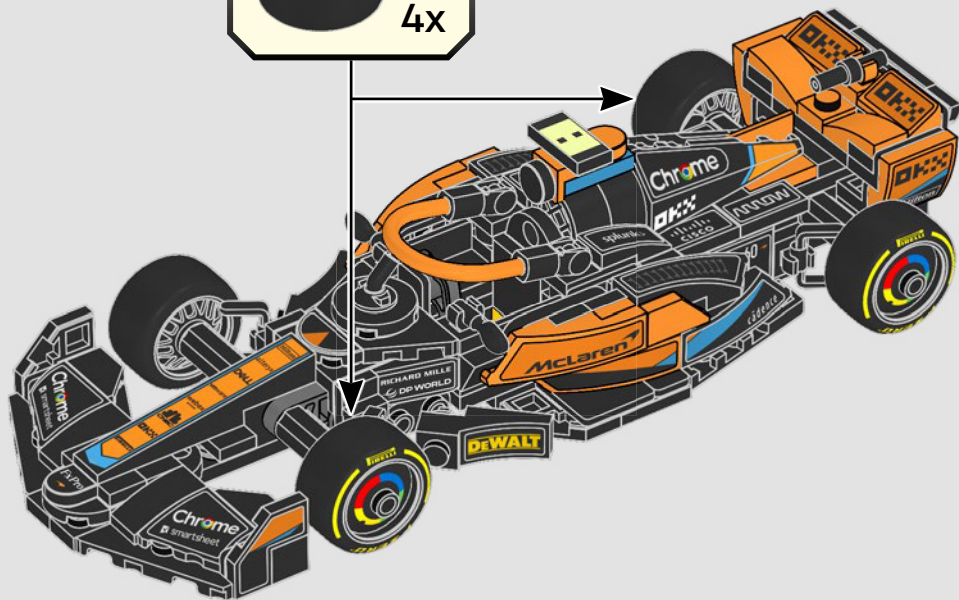
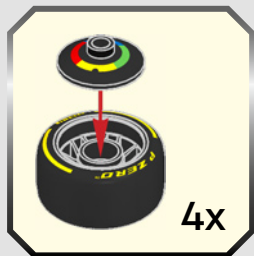

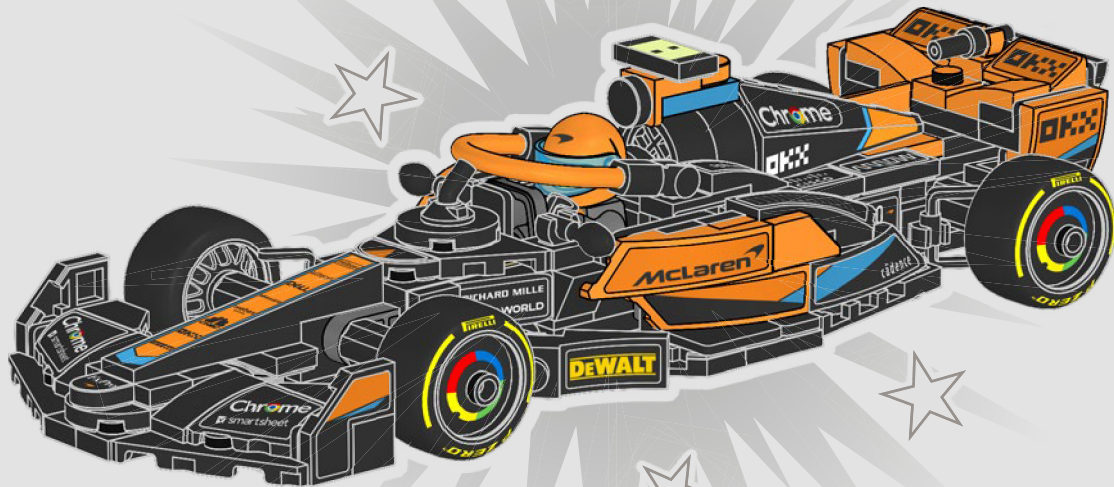



SPEED CHAMPIONS



76922



76919



76920



76921

The BMW logo, the BMW word mark and the BMW model designation are trademarks of BMW AG and are used under license.

Manufactured under license from McLaren Racing Limited. 'McLaren' is a trademark of McLaren Services Limited.

Ford Motor Company Trademarks and Trade Dress used under license to the LEGO Group.

Trademarks, design patents and copyrights are used with the approval of the owner AUDI AG.

 2x 6475201	 2x 4504382	 2x 6458188	 1x 4160869	 4x 4512363	 4x 6047276	 4x 6166859
 2x 6321194	 6x 302426	 1x 6141554	 1x 4161332	 7x 6092585	 8x 6020193	 3x 4558170
 1x 6284070	 2x 307026	 1x 6295295	 1x 6371584	 1x 6475339	 2x 6000650	 2x 6328095
 3x 6443416	 1x 6173105	 1x 6420852	 2x 6483559	 2x 6408578	 4x 6016172	 4x 6481568
 1x 6472230	 1x 6234695	 1x 6141556	 1x 6477759	 2x 306926	 2x 6428168	 1x 400626
 2x 6172383	 1x 6234695	 1x 6438919	 1x 6143850	 2x 6347310	 3x 306826	 2x 317626
 4x 407026	 3x 6335317	 1x 6295293	 4x 6483751	 4x 6146220	 1x 6192346	 2x 6477765
 6x 6335388	 4x 6245281	 6x 6210270	 1x 6477763	 1x 6472237	 2x 242026	 1x 4531412
		 2x 6196548	 2x 6458187	 1x 6178922	 4x 6133722	 3x 302126

2x
6477767

2x
370126

5x
371026

2x
6439175

1x
6472232

1x
6483755

1x
6472231

1x
4656764

2x
6357613

4x
4666579

2x
6129995

1x
4651441

1x
307024

2x
6224666

1x
6254248

1x
6431592

1x
6344851

1x
6472962

3x
4524929

1x
6403225

1x
6477755

1x
6483753

2x
6068996

1x
6477748

2x
4188771

2x
6055069

2x
4159007

2x
6067913

2x
6470163

2x
6470164

1x
6440441

1x
6447647

1x
6330148

1x
6413913

1x
6472255

7x
4211525

2x
6248078

2x
6296894

5x
4211398

2x
6435043

1x
6483752

4x
6000606

4x
4210635

1x
6324639

1x
6501810

2x
6271127

1x
6151671

1x
4653988

2x
6152101

6x
6469825

4

 [LEGO.com/service](https://www.LEGO.com/service)

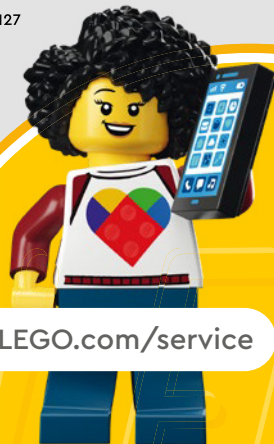

YOU COULD
WIN



Scan this QR code or go to
LEGO.COM/PRODUCTFEEDBACK and give us
your short feedback about this LEGO® set for
a chance to win a cool LEGO prize.

Terms and Conditions apply*

EN: YOU COULD WIN. Terms and Conditions apply* **DE: Du könntest GEWINNEN.** Es gelten die Teilnahmebedingungen* **FR: Tu pourrais GAGNER.** Des conditions s'appliquent* **IT: Potresti VINCERE tu.** Termini e condizioni sono applicabili* **ES: Puedes GANAR.** Aplican términos y condiciones* **PT: Poderá GANHAR.** Aplicam-se termos e condições* **ZH: 轻松获奖. 条款和条件适用*** **PL: Szansa na WYGRANĄ.** Obowiązują warunki korzystania* **CS: Máte šanci VYHRÁT.** Platí všeobecné smluvní podmínky* **SK: Máte šancu VYHRAŤ.** Platia všeobecné zmluvné podmienky* **HU: TE IS NYERHETSZ.** Felhasználási feltételek érvényesek* **RO: Ai putea CÂȘTIGA.** Se aplică termenii și condiții* **BG: Можете да СПЕЧЕЛИТЕ.** Има определени правила и условия* **LV: Tu vari LAIMĒT.** Ir spēkā noteikumi un nosacījumi.* **ET: Sul on võimalus VÕITA.** Kehtivad tingimused* **LT: Jūs galite LAIMĖTI.** Taikomos sąlygos*

*[LEGO.com/productfeedback-terms](https://www.lego.com/productfeedback-terms)

LEGO and the LEGO logo are trademarks of the/sont des marques de commerce du/son marcas registradas de LEGO Group.

©2024 The LEGO Group.

Manufactured under license from McLaren Racing Limited. 'McLaren' is a trademark of McLaren Services Limited.

6507093