



STAR WARS™

75378



Q LEGO® Builder



LEGO.com/sustainable-packaging



FR
DONNEZ
OU
RECYCLEZ

 OU  OU 

ASSOCIATION MAGASIN DÉCHÈTERIE

Adresses sur quefairedemesdechets.fr



BUILDER



Apple and the Apple logo are trademarks of Apple Inc., registered in the U.S. and other countries and regions. App Store is a service mark of Apple Inc. Google Play and the Google Play logo are trademarks of Google LLC. Tencent and the Tencent logo are trademarks of Tencent Inc.



EN Ask parents' permission before going online | **DE** Eltern um Erlaubnis bitten, bevor du online gehst | **FR** Demande l'autorisation d'un parent avant d'aller en ligne | **IT** Chiedi il permesso ai tuoi genitori prima di andare online | **ES** Pídeles permiso a tus papás antes de conectarte a Internet | **PT** Pede autorização aos pais antes de acederes online | **ZH** 上网前应先征得父母的同意 | **PL** Poproś rodziców o zgodę, zanim wejdiesz do Internetu | **CS** Než půjdeš na internet, požádej rodiče o svolení | **SK** Skôr než pôjdeš na internet, vypýtaj si povolenie od rodičov | **HU** Kérj szülői engedélyt, mielőtt online csatlakoznál! | **RO** Cere permisiunea părinților înainte de a te conecta online | **BG** Поискайте разрешение от родител, преди да влезете онлайн | **LV** Pirms došanās tiešsaistē palūdz atļauju vecākiem | **ET** Enne Interneti kasutamist küsi vanematelt luba | **LT** Prieš prisijungdami prie interneto, atsiklauskite tėvų

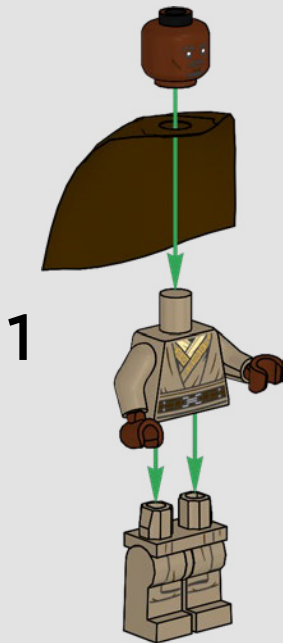

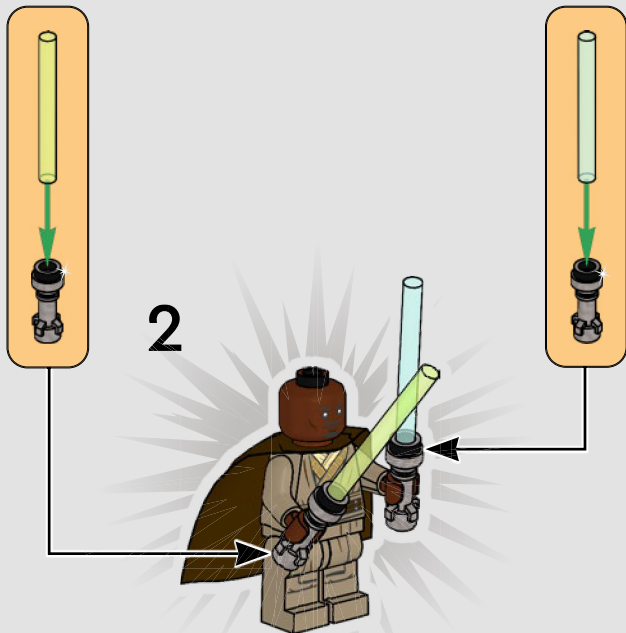

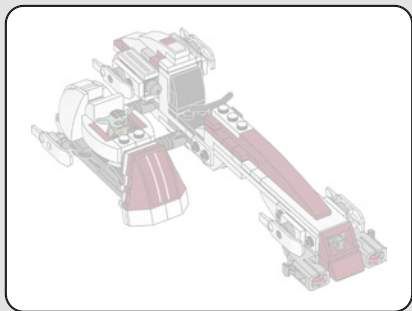

1x

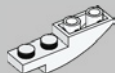

1x

1

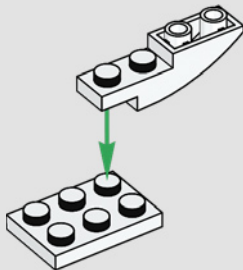



1x

2

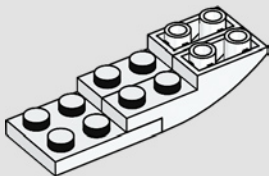

1x

3

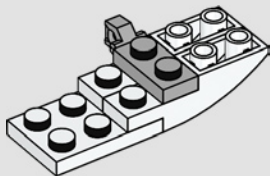



2x



4x

4

1

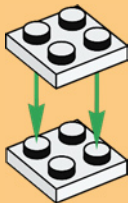

2

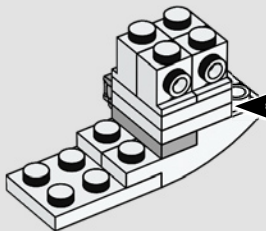
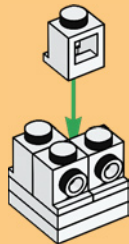



1x



1x



1x

5

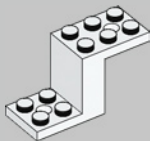
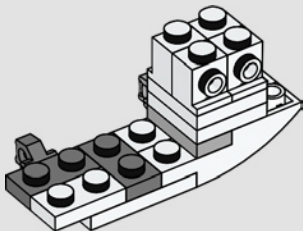

1x

6

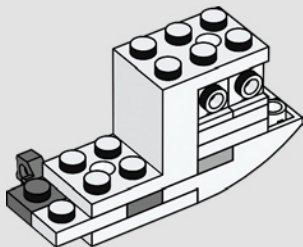



1x



1x

7

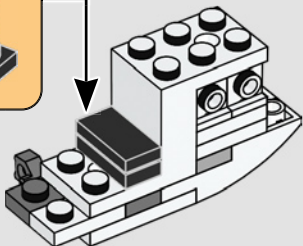
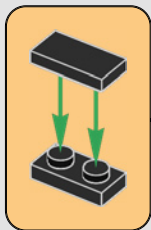

8



1x

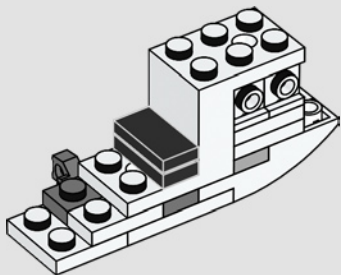



2x

9

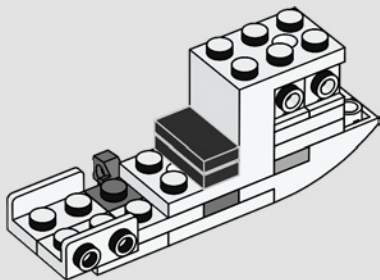

2x

10

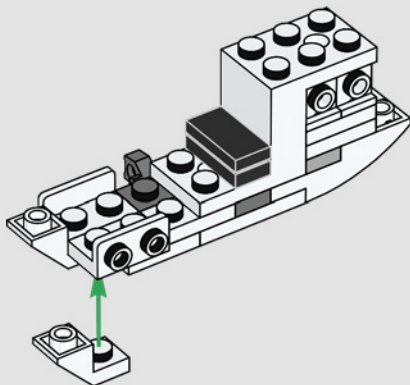



1x

11

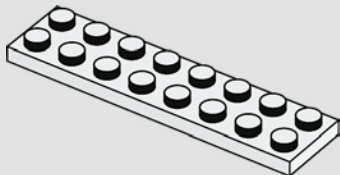

12



2x

12

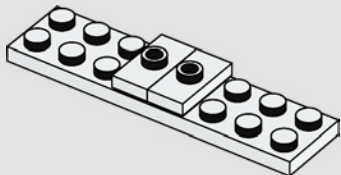



1x

13

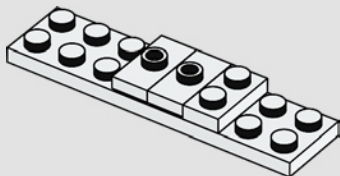

1x

14

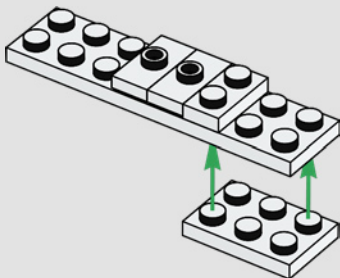

15

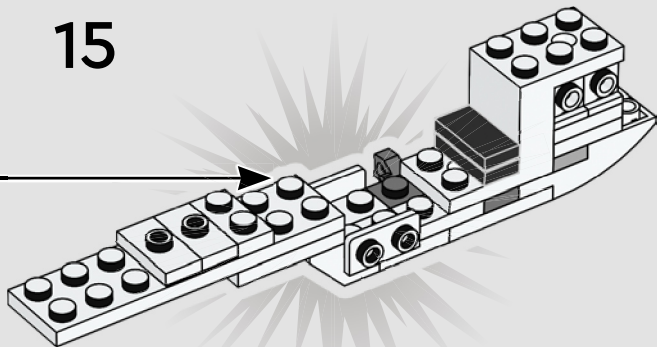

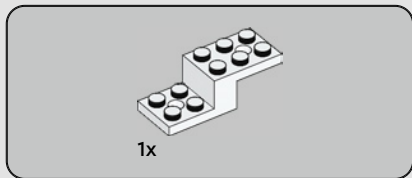

16

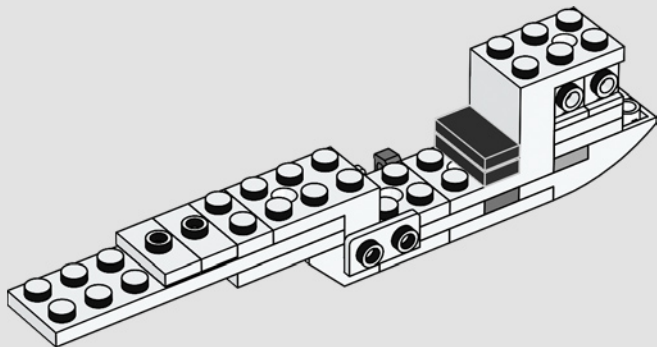

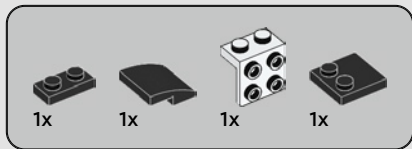

17

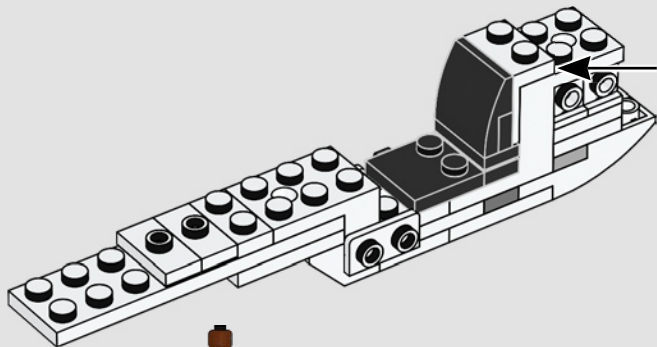
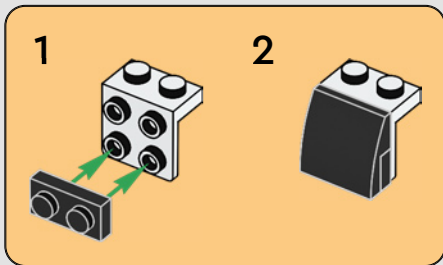

16



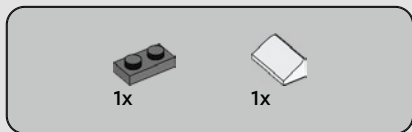

18

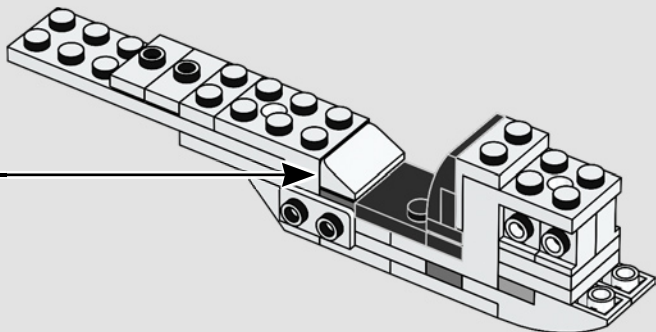
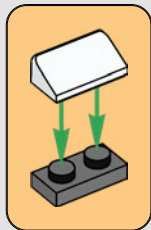

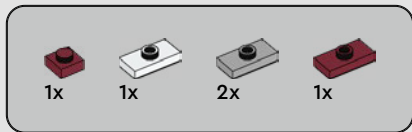

19

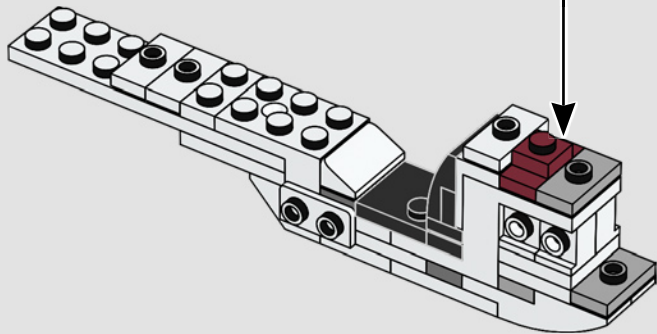
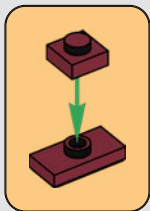

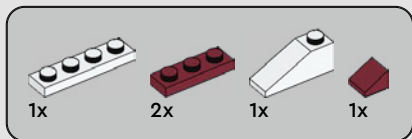

20

1

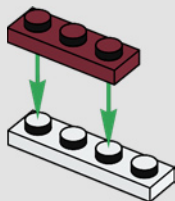

2

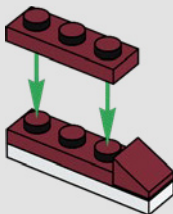

3

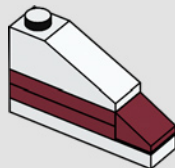

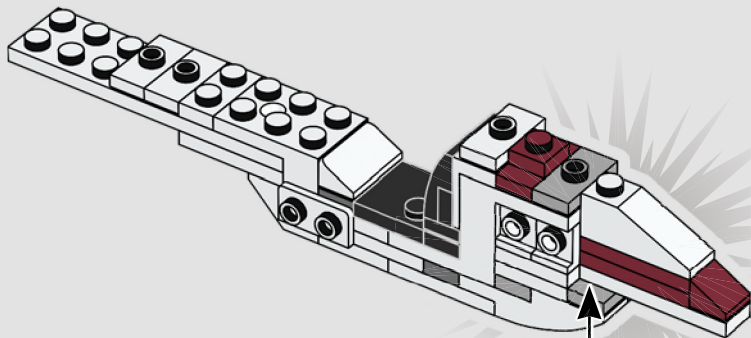

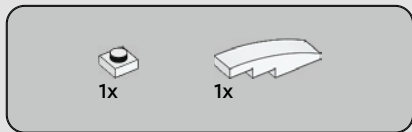

21

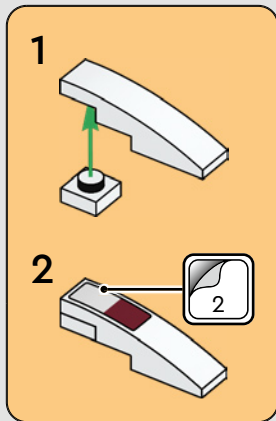
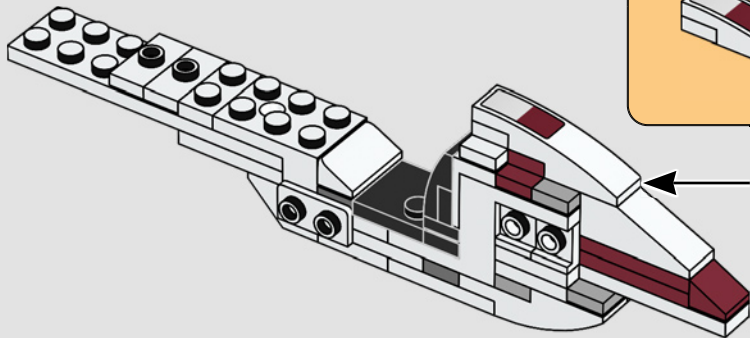



3x

22

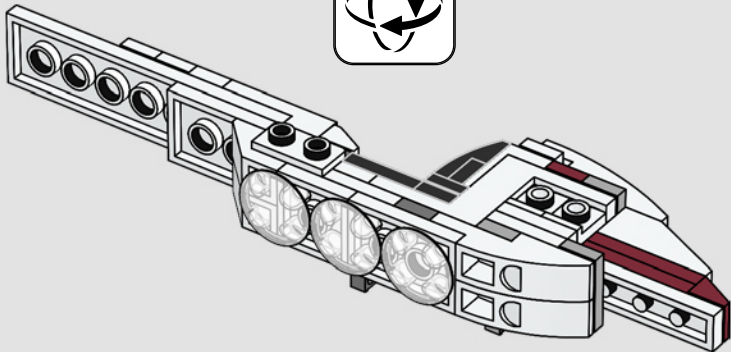

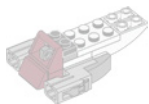

1x



1x

23

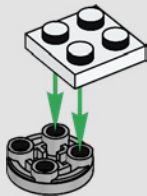

1x

24





2x

25

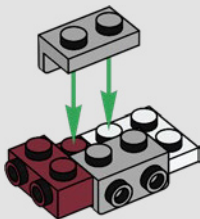

2x

26

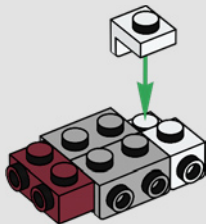



1x

27

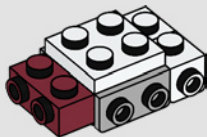

1x



1x

28

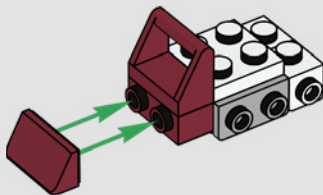



1x



1x

29

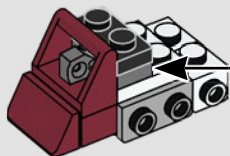
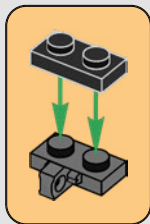



2x

30

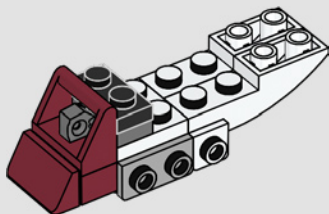

1x

31

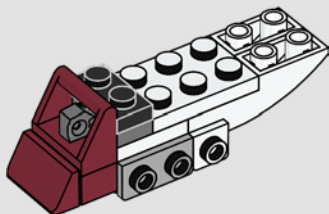

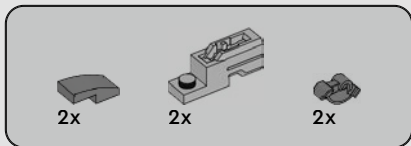

32

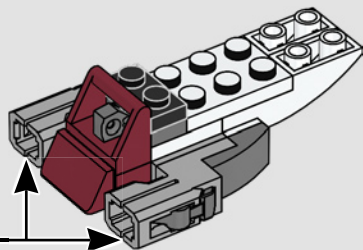
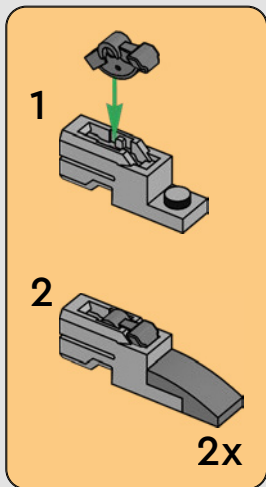

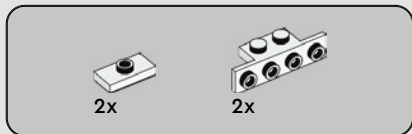

33

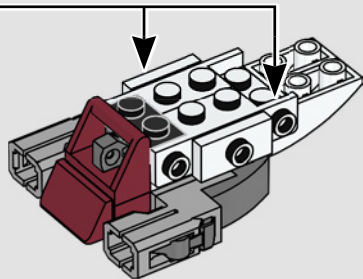
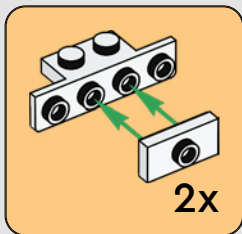



34

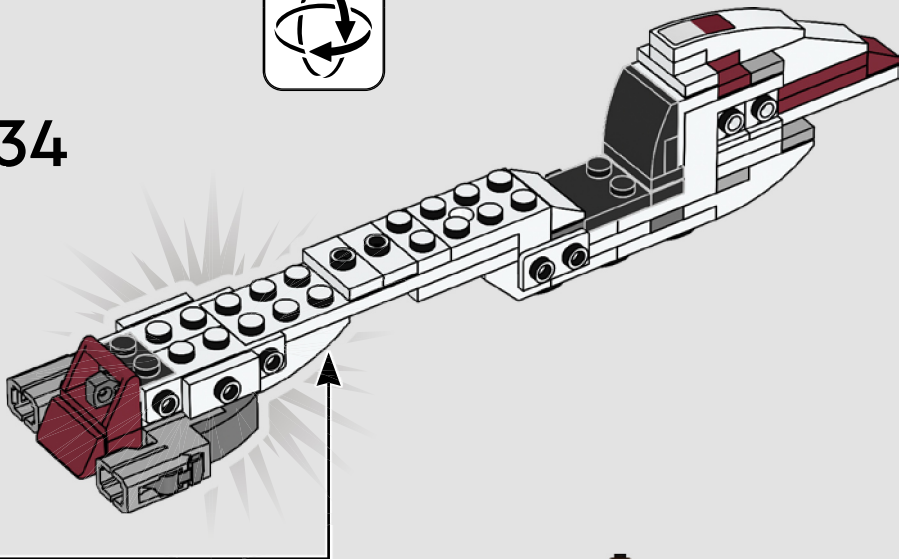

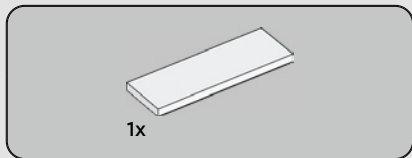

35

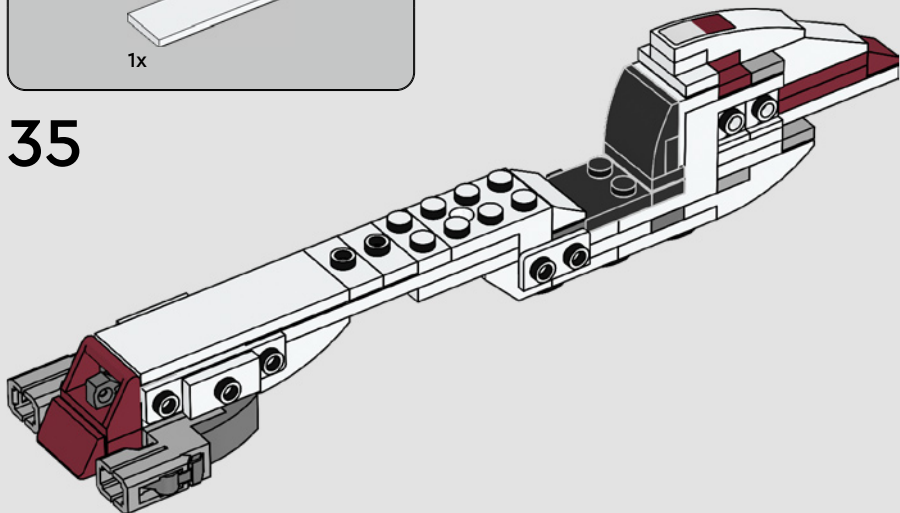



1x



1x

36

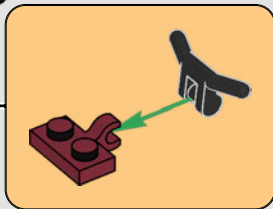
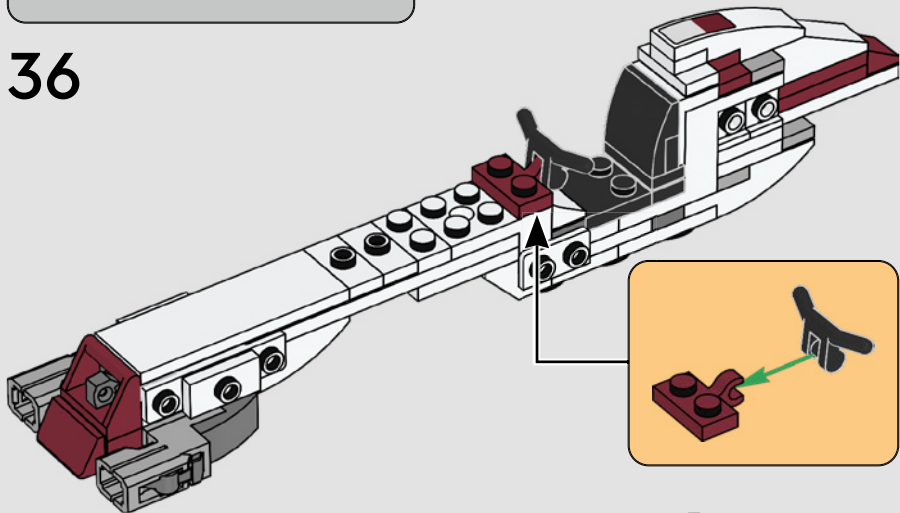



1x



4x

37

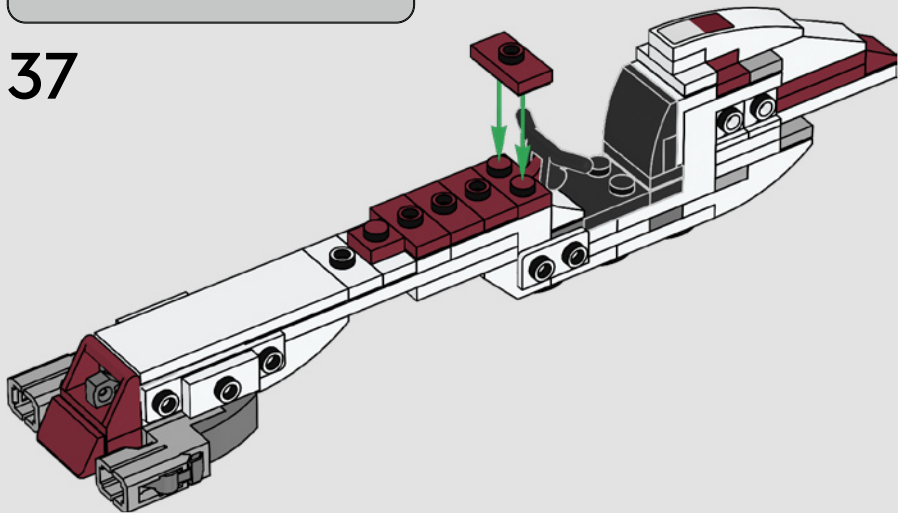

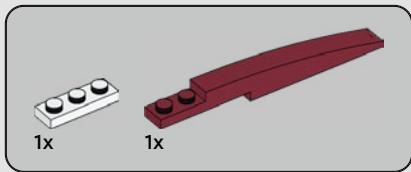

38

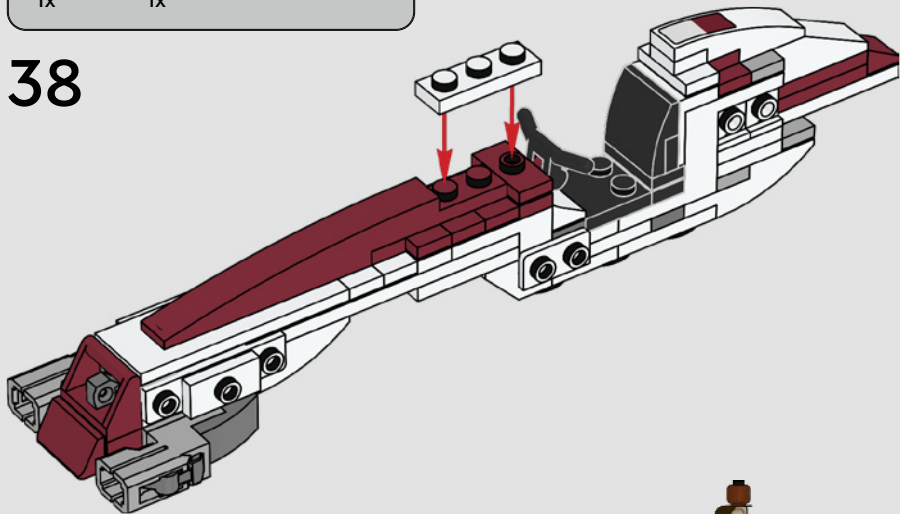



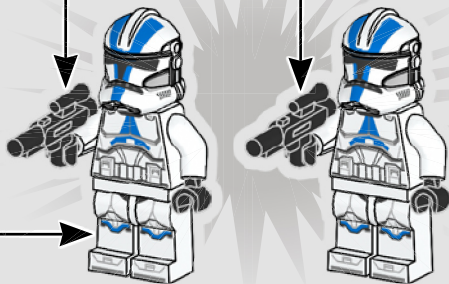
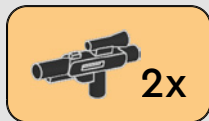
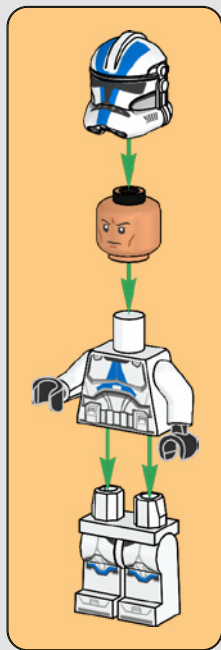

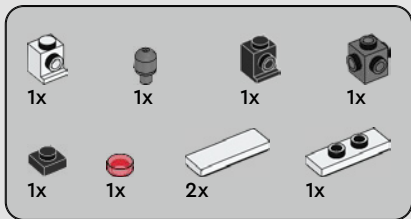

39

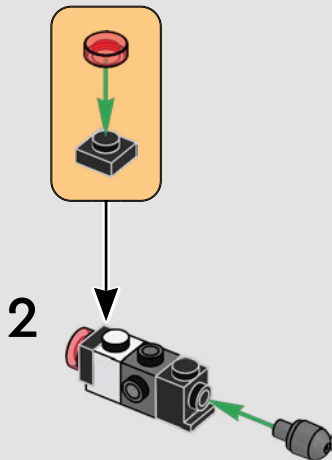
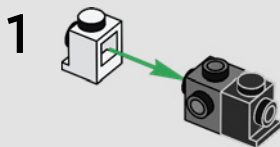

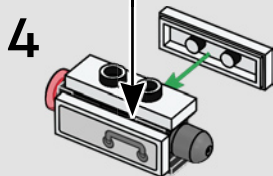
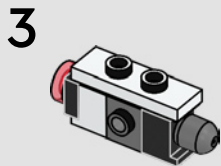
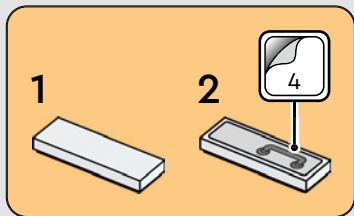

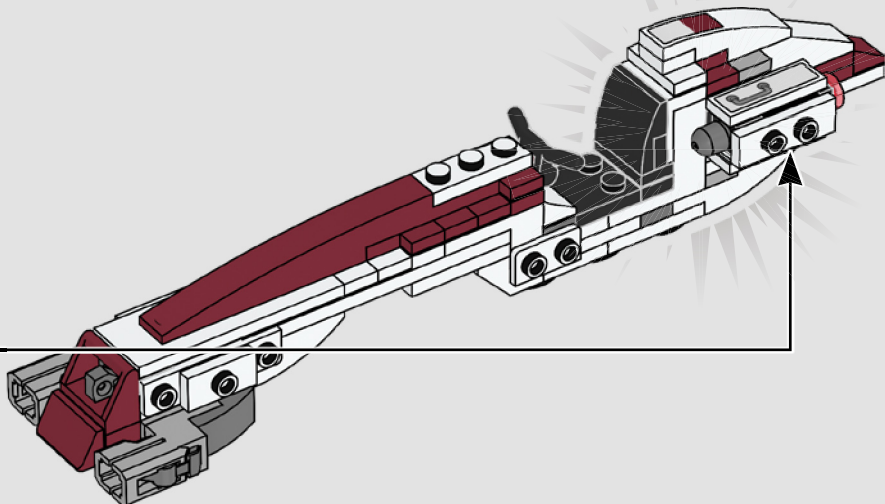

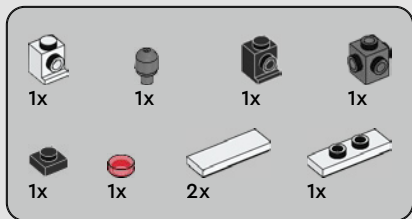

40

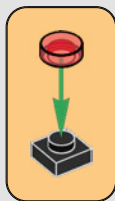
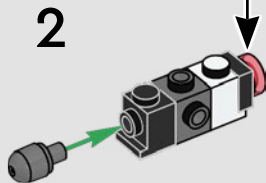
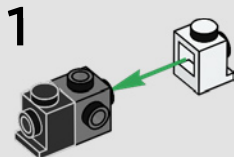

3

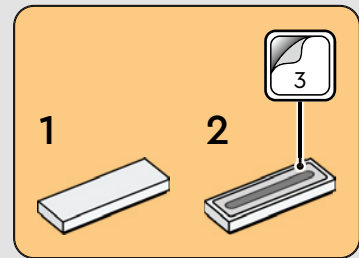
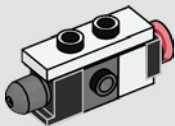

4

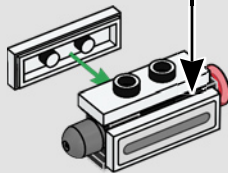

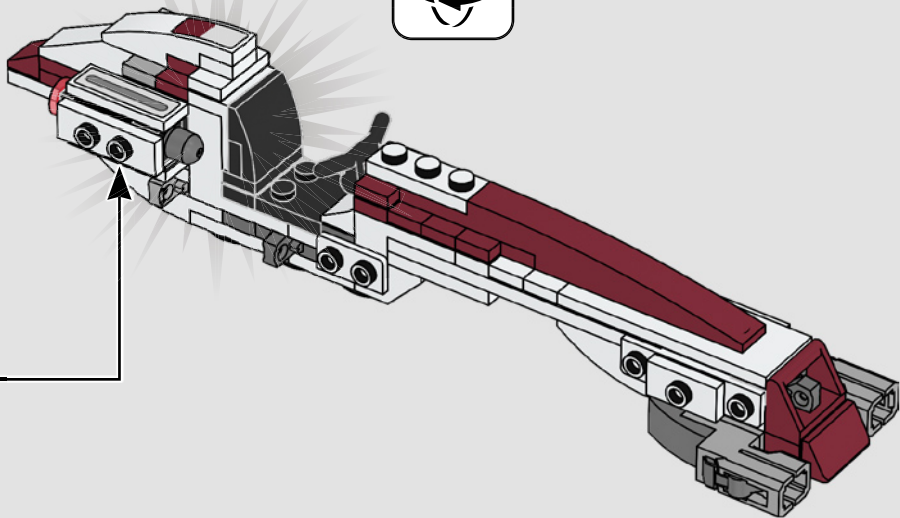

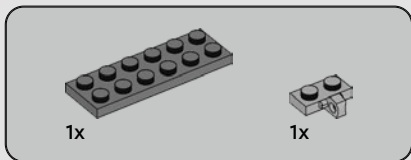
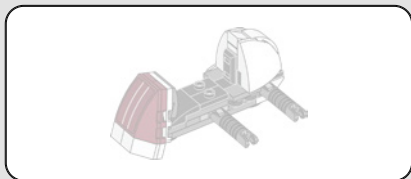

41

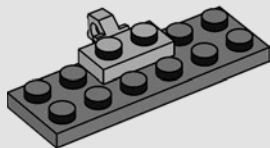



1x

42

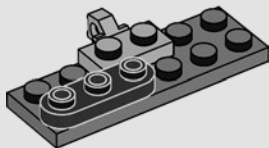

1x



1x

43

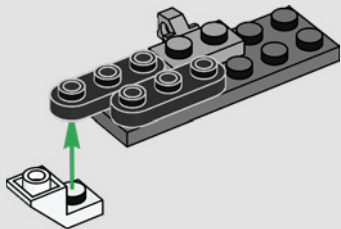

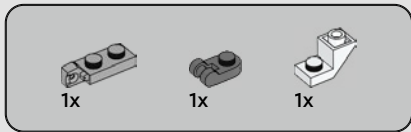

44

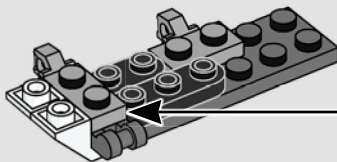
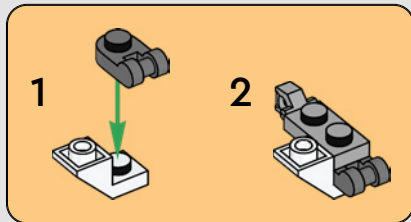



2x

45

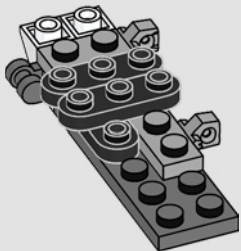

1x

46

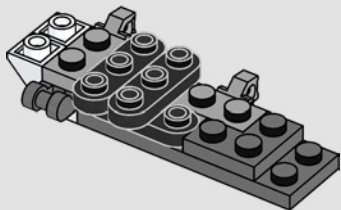



1x

47

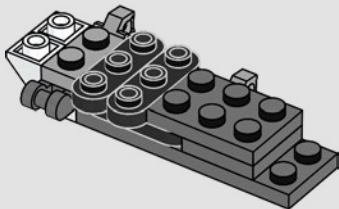

2x



1x

48

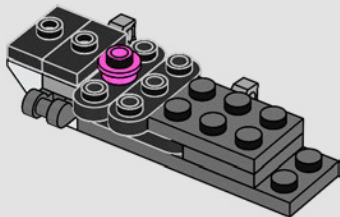



1x



2x

49

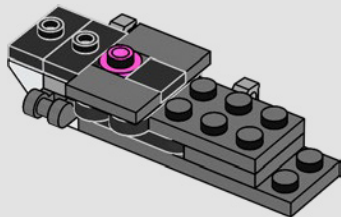

2x

50

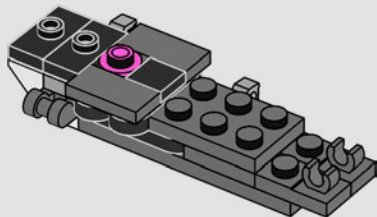



1x



2x

51

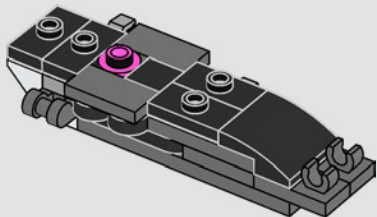

1x

52

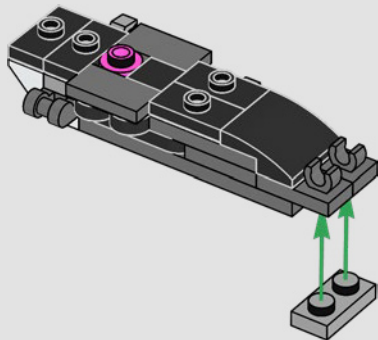



1x



1x

53

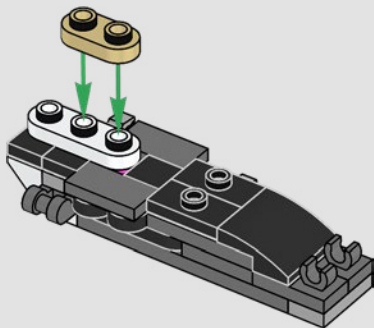

1x

54

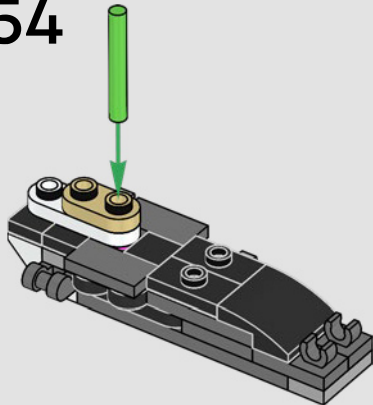



1x



1x

55

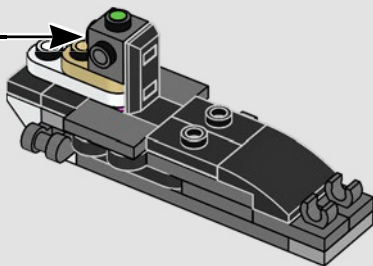
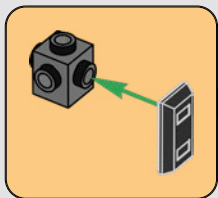

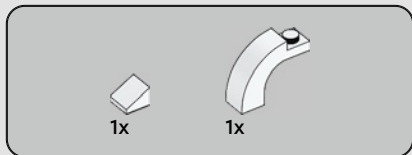

56

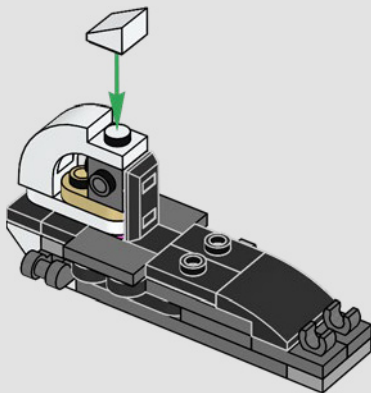

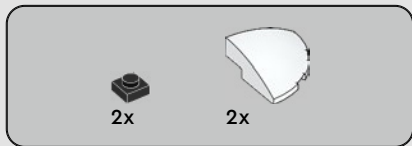

57

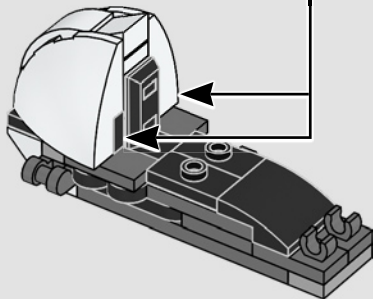
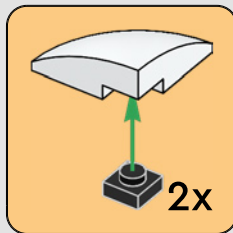



1x



1x

58

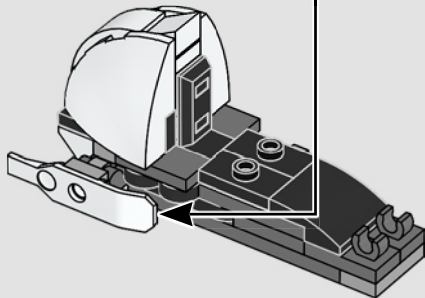
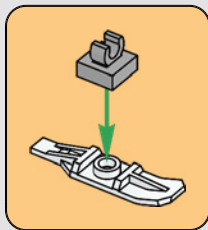



2x

59

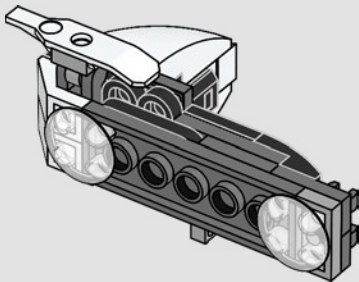



1x

60

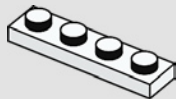

1x

61

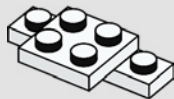



1x



1x

62



1x

63

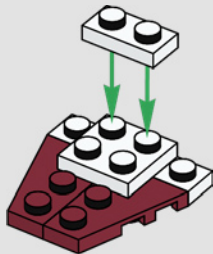



2x

64

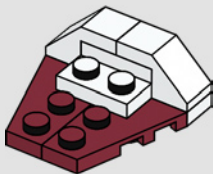

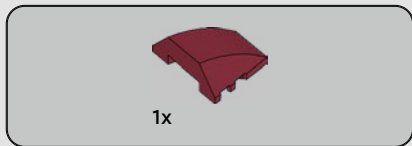

65

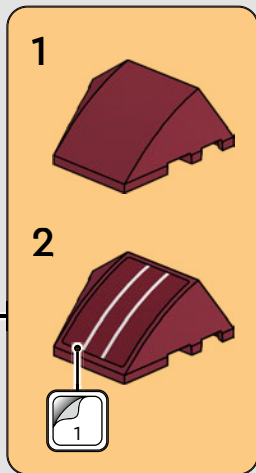
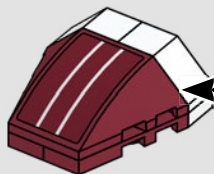



1x

66

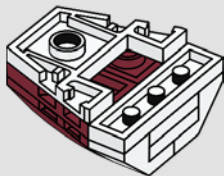



1x

67

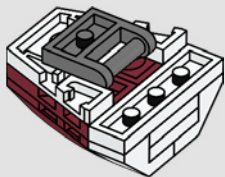

1x

68

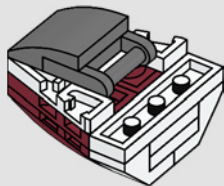

69

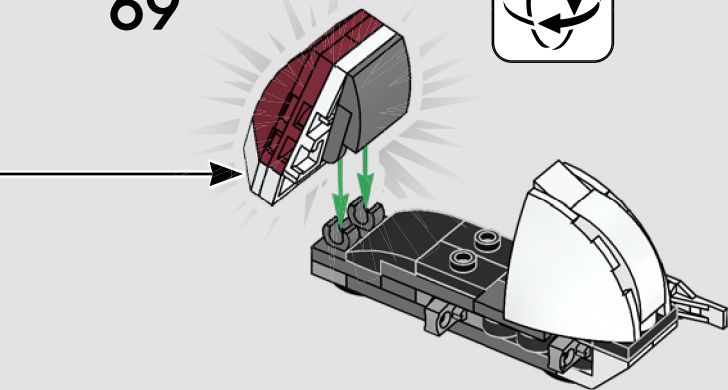

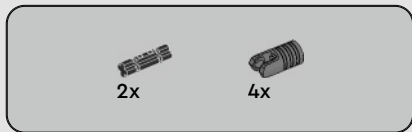

70

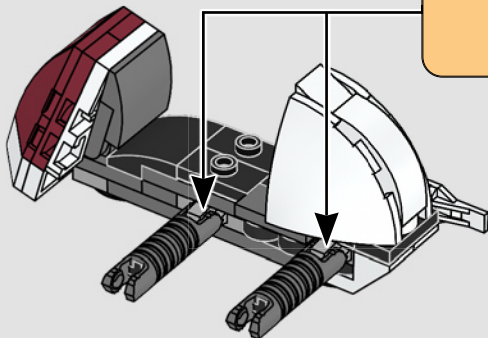
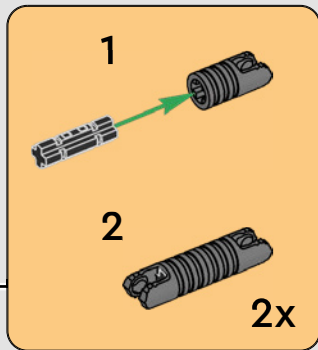

71

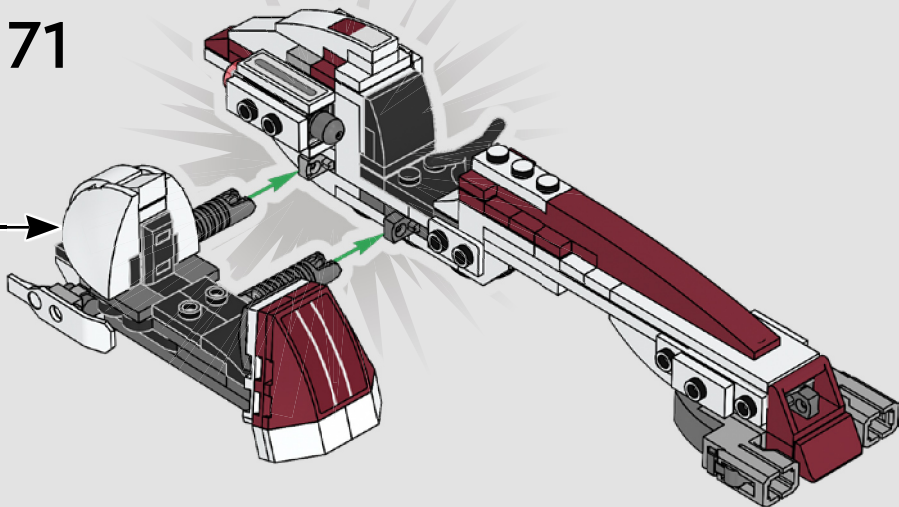



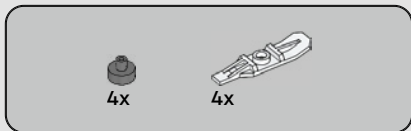

72

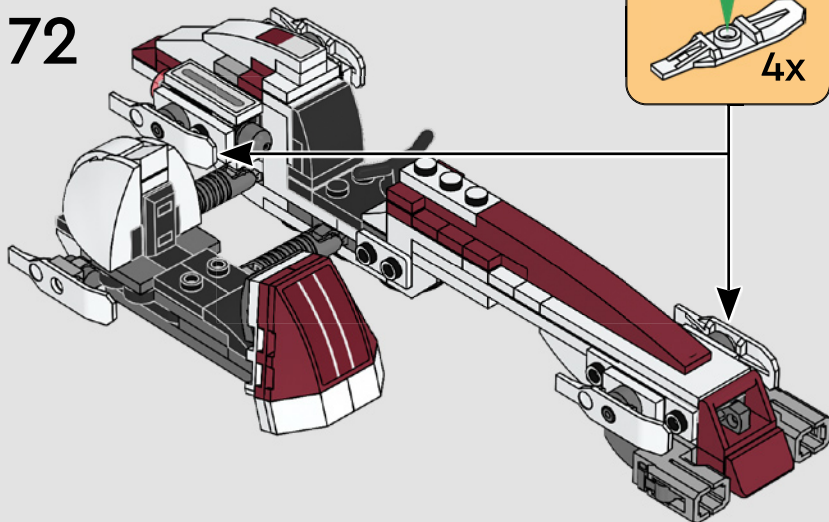



1x



1x

73

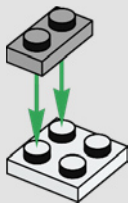

1x

74

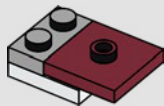



1x

75



4x

76

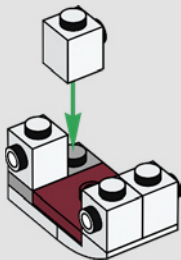

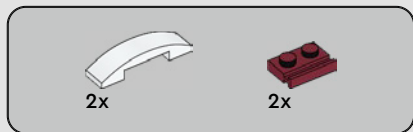

77

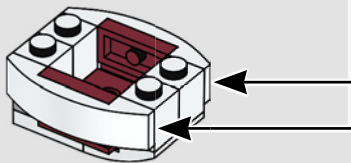
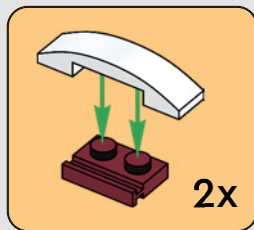



1x

78

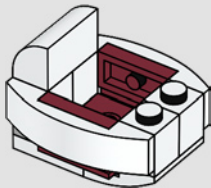

1x



1x

79

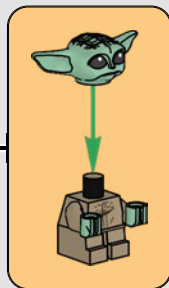

80

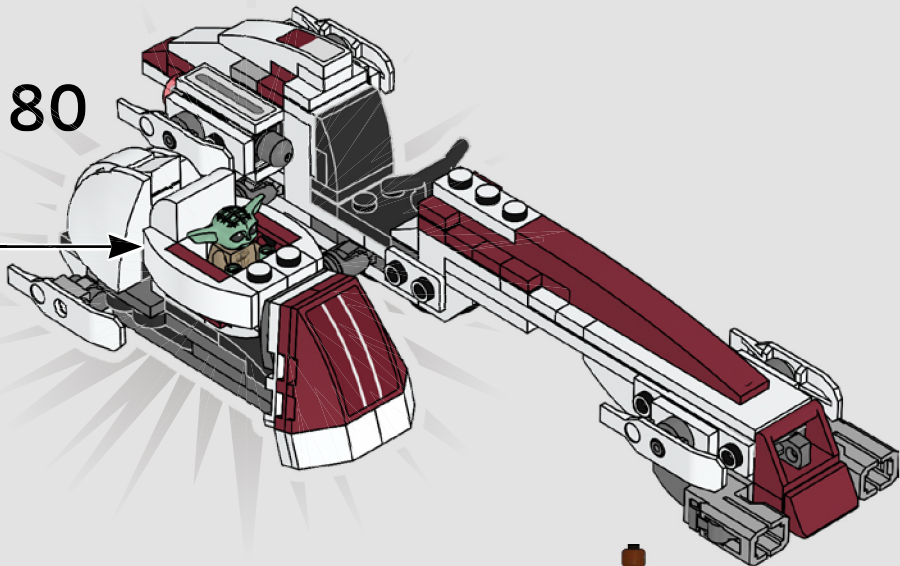



4x



81

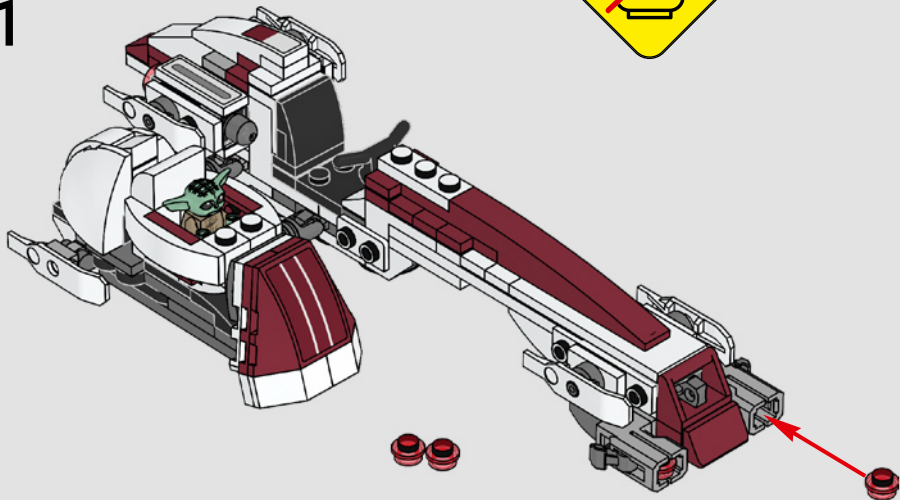

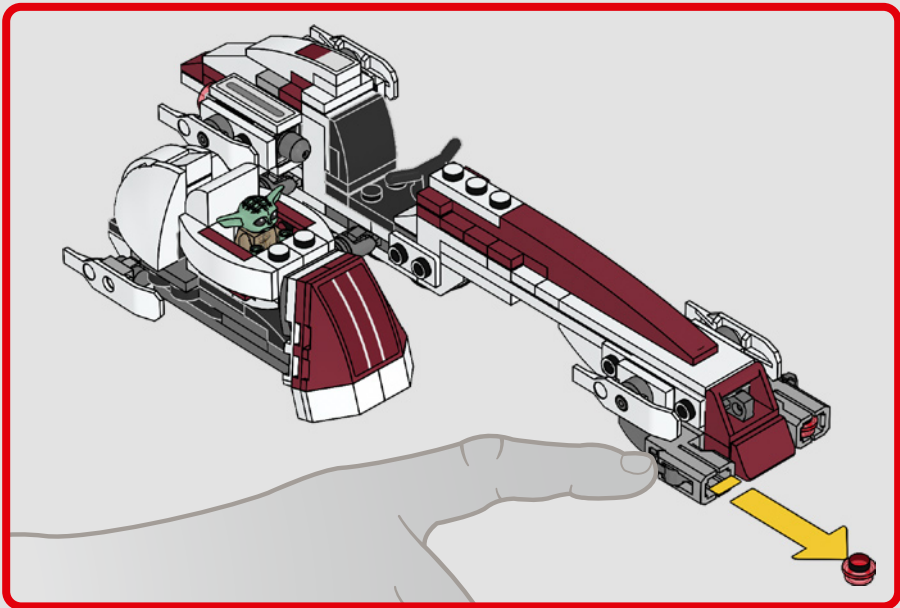



1x

82

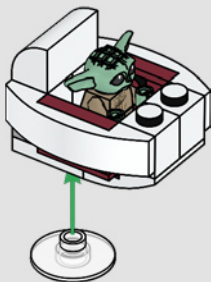

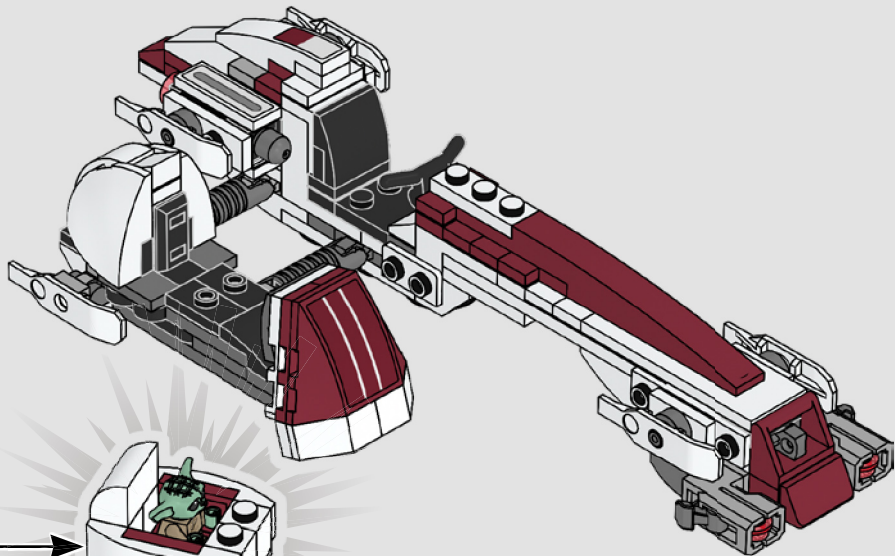



1x



1x

1

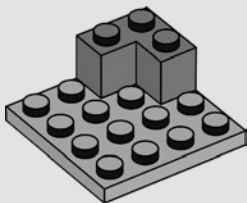

1x



1x

2

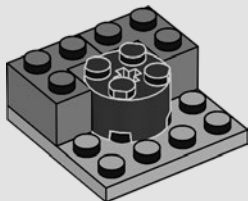



2x

3

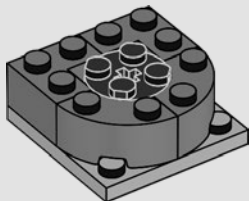

2x



2x

4

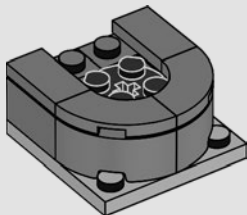



1x



1x

5

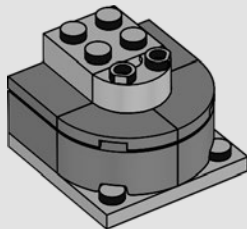

1x



1x

6

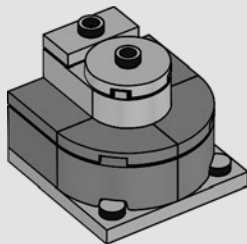

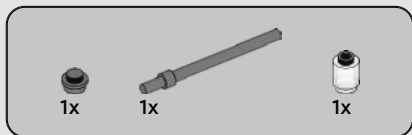

7

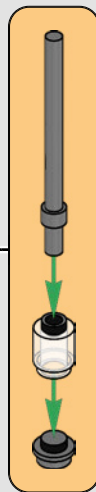
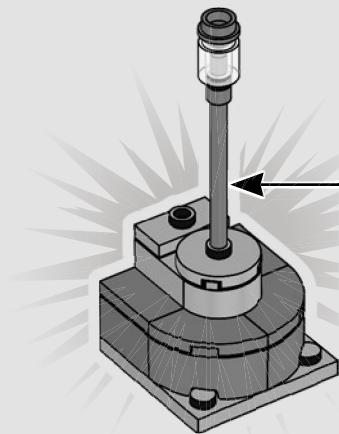

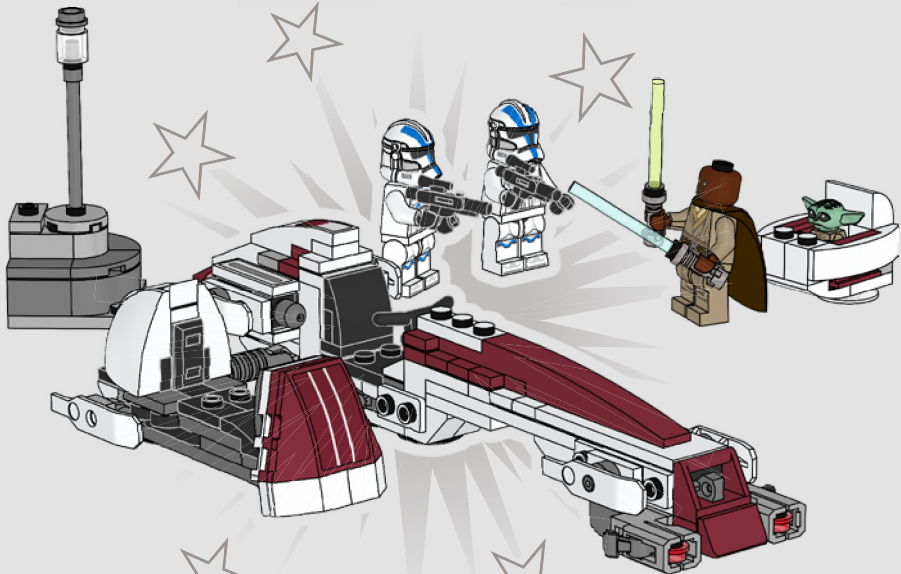



6x
407001



1x
302401



4x
4558952



1x
4504369



2x
6296132



2x
6380146



1x
4547489



2x
6308127



3x
302301



5x
6051511



4x
6458097



1x
6248827



2x
6166894



2x
6070698



1x
6117940



1x
6450820



7x
302201



1x
6210385



2x
6334524



2x
6195371



4x
4558168



1x
362301



1x
4629913



1x
428601



2x
6311398



2x
6168618



3x
302101



5x
6484391



4x
6034675



1x
6045936



2x
371001



1x
6170524



1x
6053026



1x
6310374



1x
6332042



1x
303401



2x
6023806



1x
6212758



2x
6308125



2x
407026



4x
302426



















































1x
307026



2x
4109810



1x
614326

| | | | | | |
|---|--|--|--|--|--|
|  3x 302326 |  2x 6053077 |  1x 6472377 |  1x 6083977 |  5x 6092597 |  1x 6508097 |
|  1x 306926 |  1x 6161772 |  1x 6488937 |  1x 6313126 |  1x 6470185 |  3x 6066097 |
|  4x 6092585 |  1x 6223655 |  1x 6488937 |  1x 6484390 |  2x 4539076 |  1x 6266251 |
|  1x 6156991 |  1x 6245306 |  1x 6510467 |  2x 6186005 |  1x 6472375 |  2x 4211398 |
|  1x 3003126 |  5x 6163901 |  2x 4539114 |  1x 4613761 |  1x 6311384 |  2x 4654582 |
|  2x 4498713 |  4x 6208450 |  1x 4531415 |  1x 6175314 |  1x 6183782 |  2x 6266231 |
|  4x 6428168 |  2x 6258607 |  1x 6267490 |  1x 6293875 |  1x 6308012 |  1x 4211387 |
|  1x 6192346 |  1x 6507882 |  1x 6267492 |  1x 6293875 |  1x 6308012 |  1x 4211387 |
| |  1x 6483616 | | | | |



2x
6360382

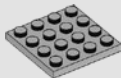

1x
4243797



2x
6344216



1x
4210633



4x
6271752



3x
4210700



2x
6360675



1x
6388119



4x
6271538



4x
4211052



2x
4211063



2x
6266248



2x
6029948



2x
6344754



1x
6146321



2x
6265306



2x
4211109



1x
4210635



2x
6360619



1x
6344820



1x
4211043



1x
6170420



1x
4211002



1x
6230582



1x
6492810



1x
6507884



2x
6051389



[LEGO.com/service](https://www.LEGO.com/service)

YOU COULD

WIN

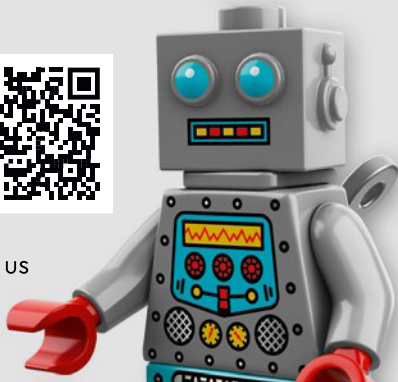

Scan this QR code or go to
LEGO.COM/PRODUCTFEEDBACK and give us
your short feedback about this LEGO® set
for a chance to win a cool LEGO prize.

Terms and Conditions apply*

EN: YOU COULD WIN. Terms and Conditions apply* **DE: Du könntest GEWINNEN.** Es gelten die Teilnahmebedingungen* **FR: Tu pourrais GAGNER.** Des conditions s'appliquent* **IT: Potresti VINCERE tu.** Termini e condizioni sono applicabili* **ES: Puedes GANAR.** Aplican términos y condiciones* **PT: Poderá GANHAR.** Aplicam-se termos e condições* **ZH: 轻松获奖.** 条款和条件适用* **PL: Szansa na WYGRANĄ.** Obowiązują warunki korzystania* **CS: Máte šanci VYHRÁT.** Platí všeobecné smluvní podmínky* **SK: Máte šancu VYHRÁT.** Platia všeobecné zmluvné podmienky* **HU: TE IS NYERHETSZ.** Felhasználási feltételek érvényesek* **RO: Ai putea CÂȘTIGA.** Se aplică termenii și condiții* **BG: Можете да СПЕЧЕЛИТЕ.** Има определени правила и условия* **LV: Tu vari LAIMĒT.** Ir spēkā noteikumi un nosacījumi.* **ET: Sul on võimalus VÕITA.** Kehtivad tingimused* **LT: Jūs galite LAIMĖTI.** Taikomos sąlygos*

*[LEGO.com/productfeedback-terms](https://www.lego.com/productfeedback-terms)

LEGO and the LEGO logo are trademarks of the LEGO Group. ©2024 The LEGO Group.

© & ™ Lucasfilm Ltd.

6515725