



40684





### **Get excited about our new packaging!**

We're switching from plastic to paper-based packaging. That's why you might find a mix of paper and plastic in our boxes!

### **Nos nouveaux emballages vous emballeront !**

Nous passons des emballages en plastique aux emballages à base de papier. C'est pourquoi vous pourriez trouver un mélange de papier et de plastique dans nos boîtes !

### **¡Te presentamos nuestros nuevos empaques!**

Estamos sustituyendo las bolsas de plástico por bolsas con base de papel. ¡Por eso, puedes encontrar una mezcla de papel y de plástico en nuestras cajas!

**[LEGO.com/sustainable-packaging](https://www.lego.com/sustainable-packaging)**

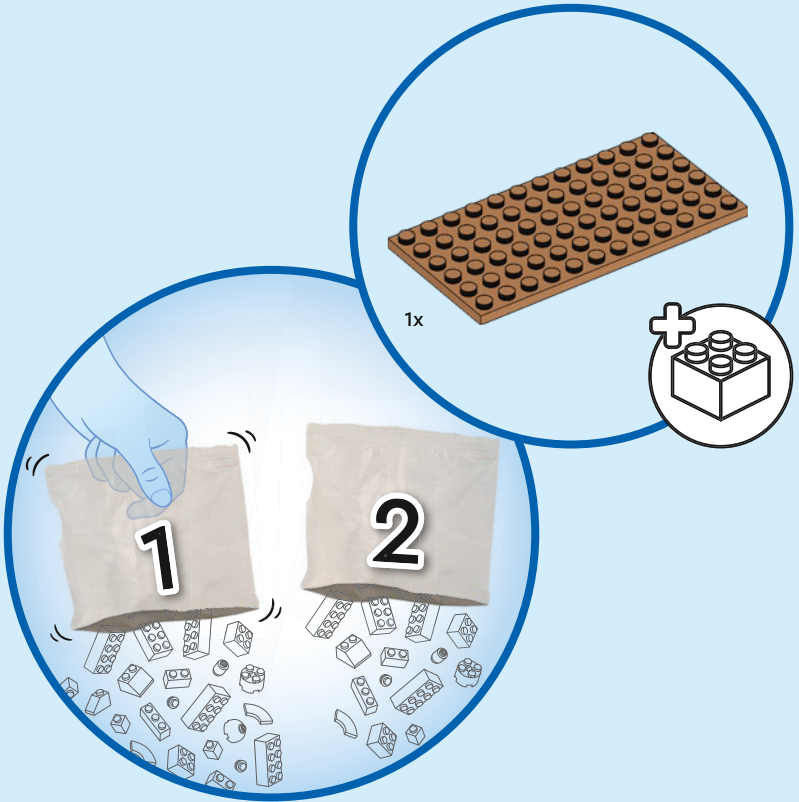

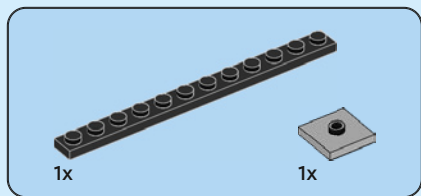

1

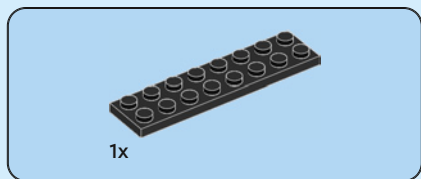
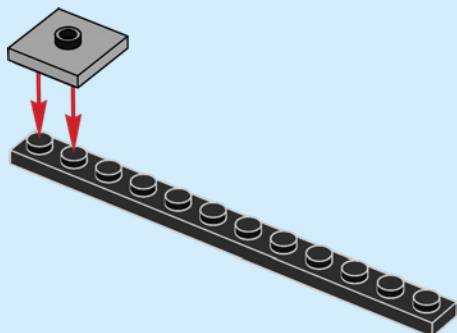

2

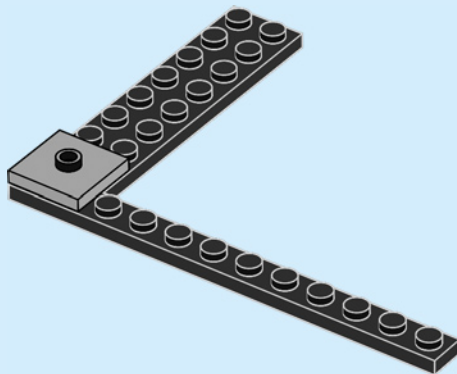

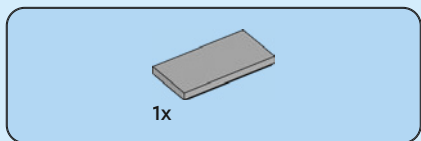

3

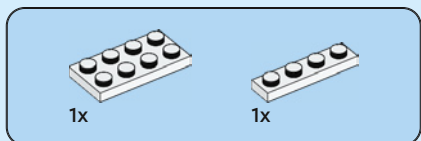
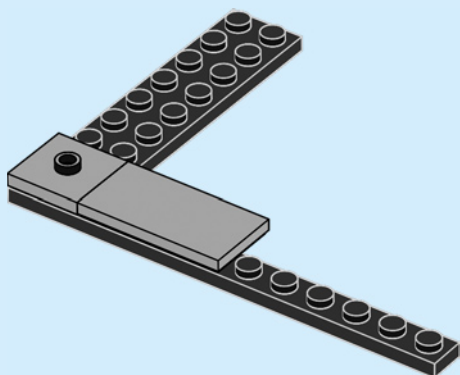

4

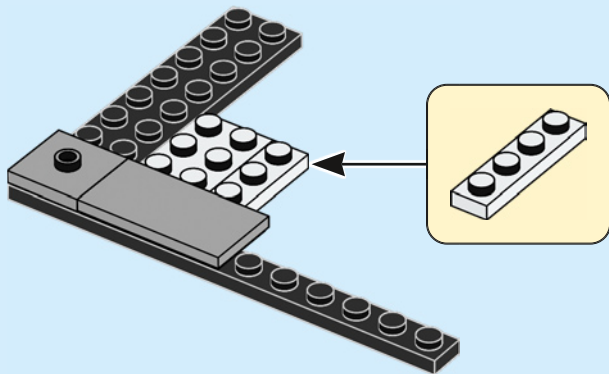

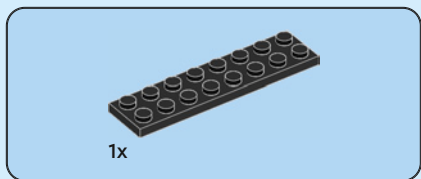

5

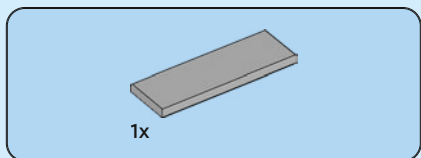
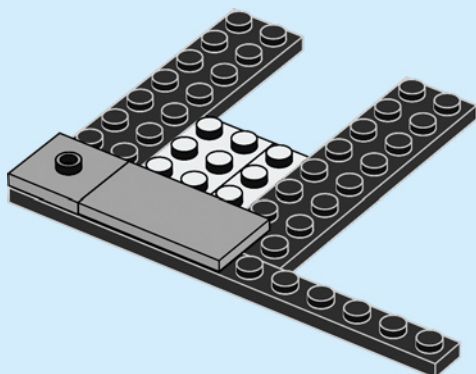

6

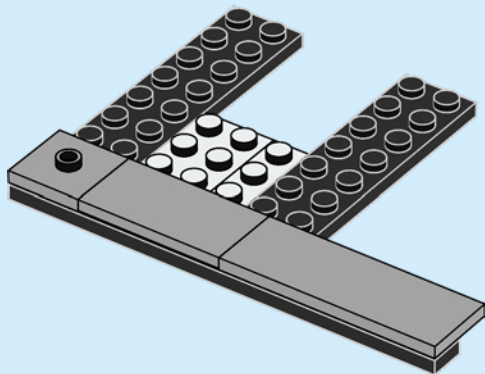

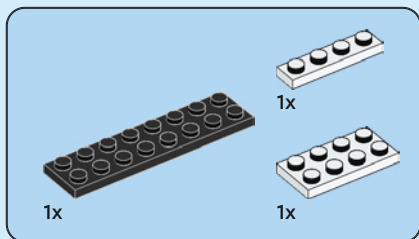

7

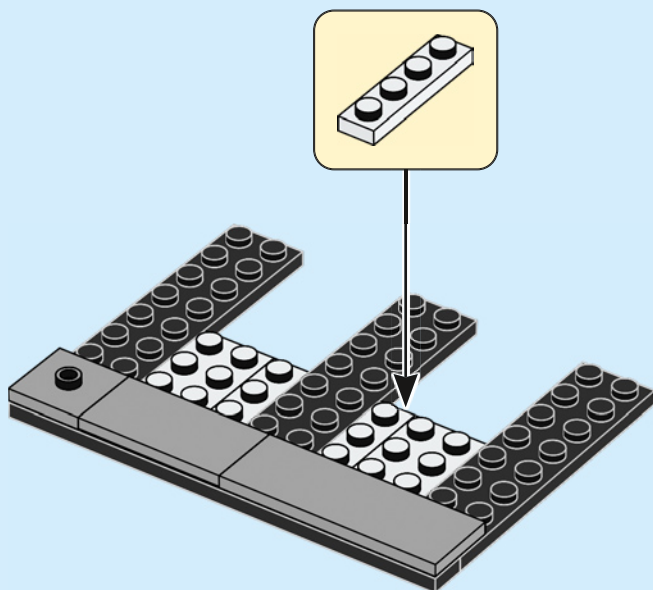



2x



5x



6x

8

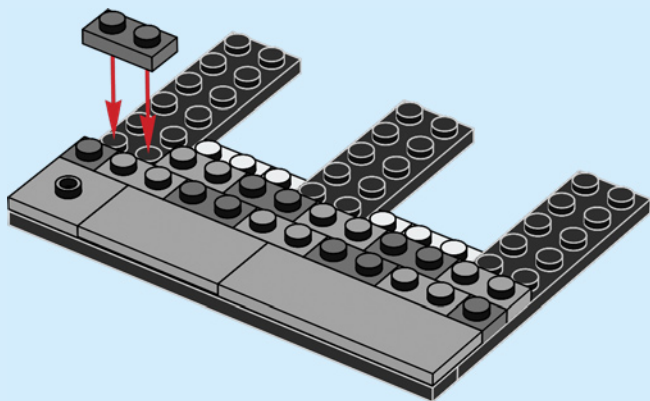



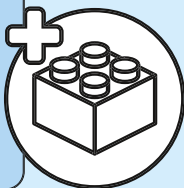
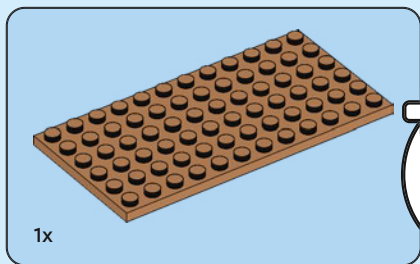

9

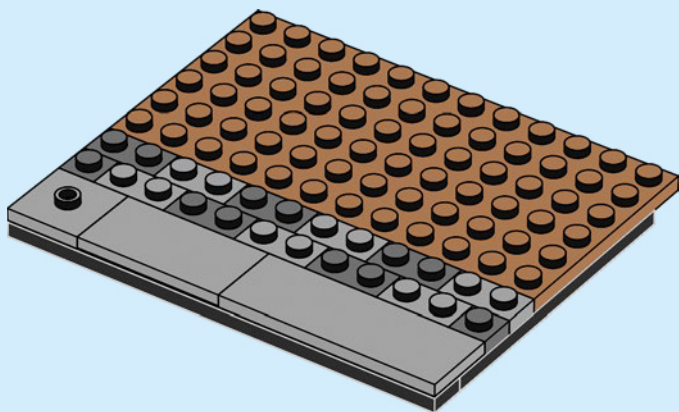

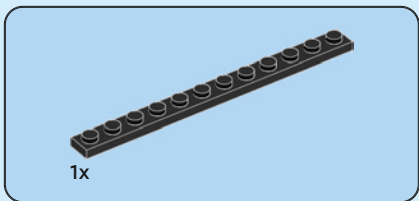

10

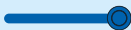
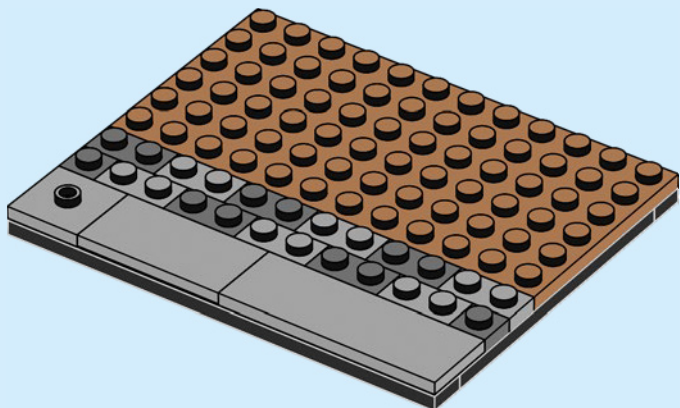
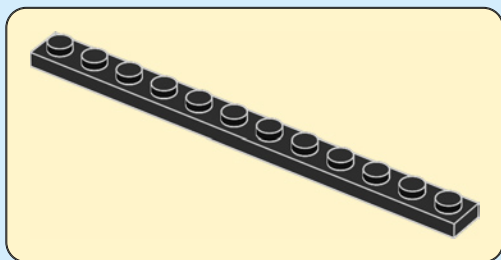



2x

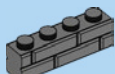

2x

# 11

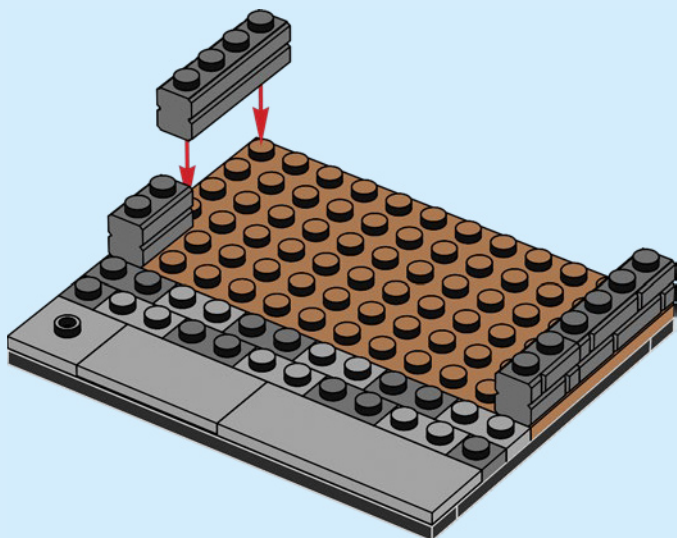



4x

12

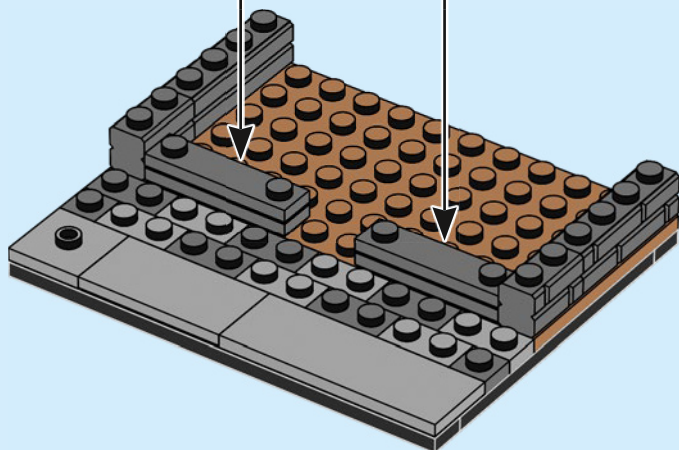
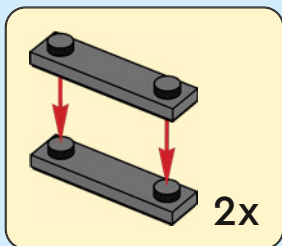



2x



1x



4x

# 13

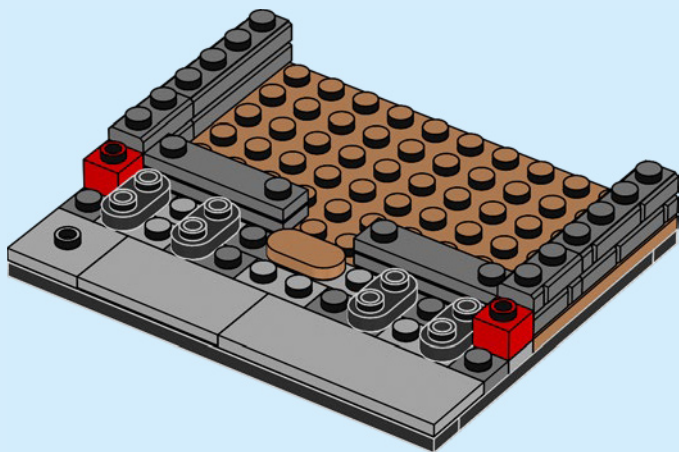



2x



1x



1x

# 14

1



2

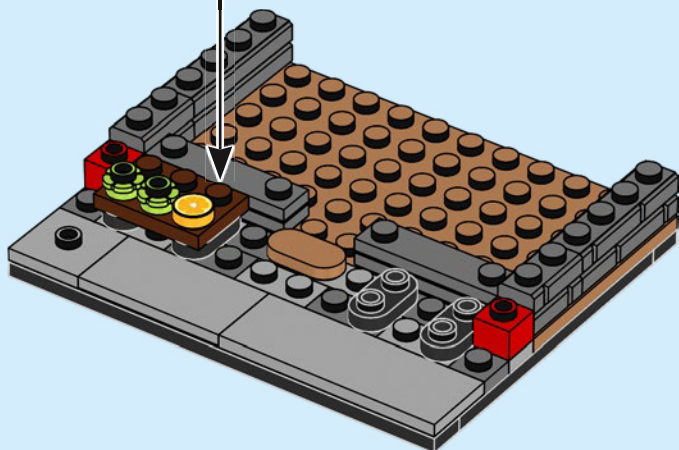

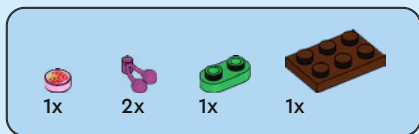

# 15



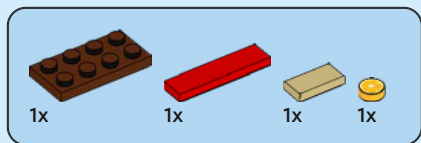

16

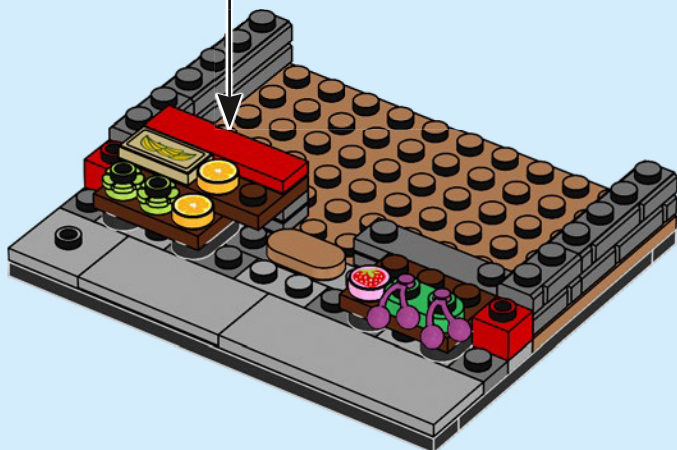
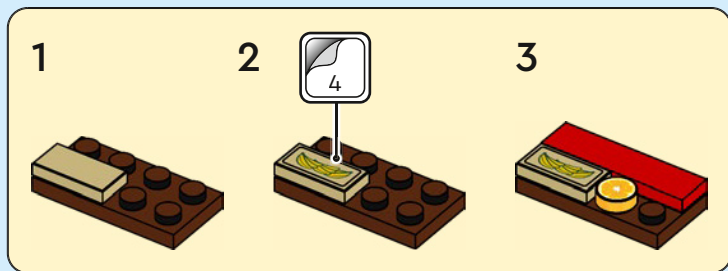



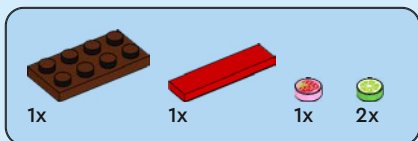

17

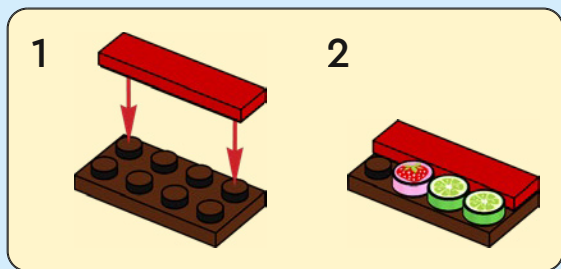

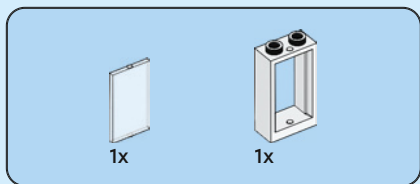

18

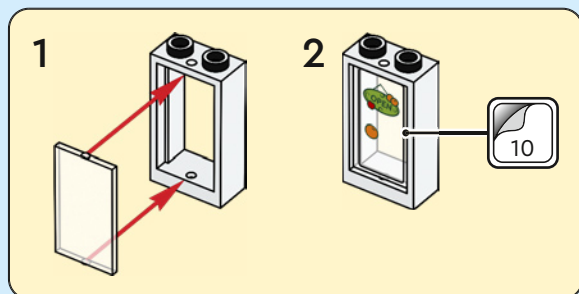



2x

19



2x

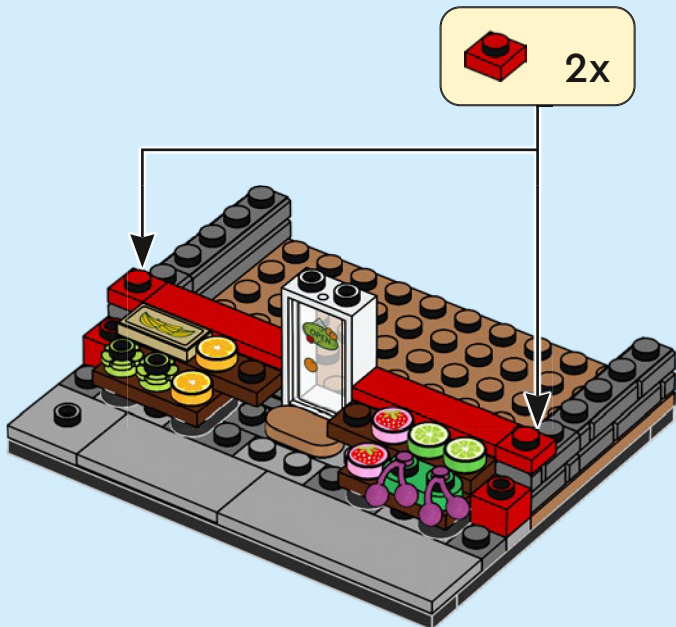

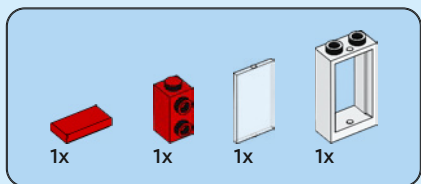
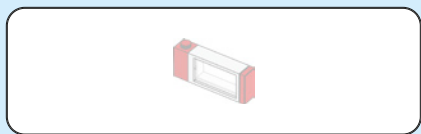

20

1

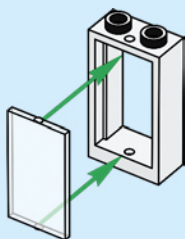

2

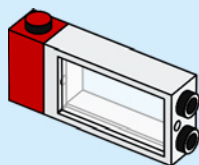

3

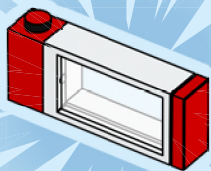

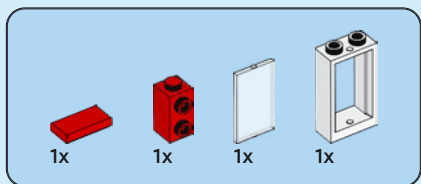

21

1

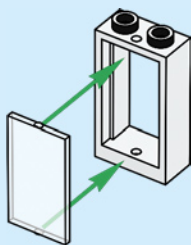

2

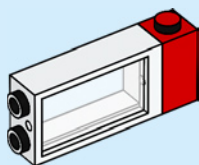

3

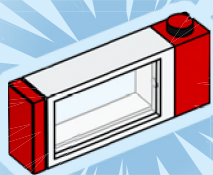



2x

22







3x

23





2x



1x



1x

# 24





4x

25



2x

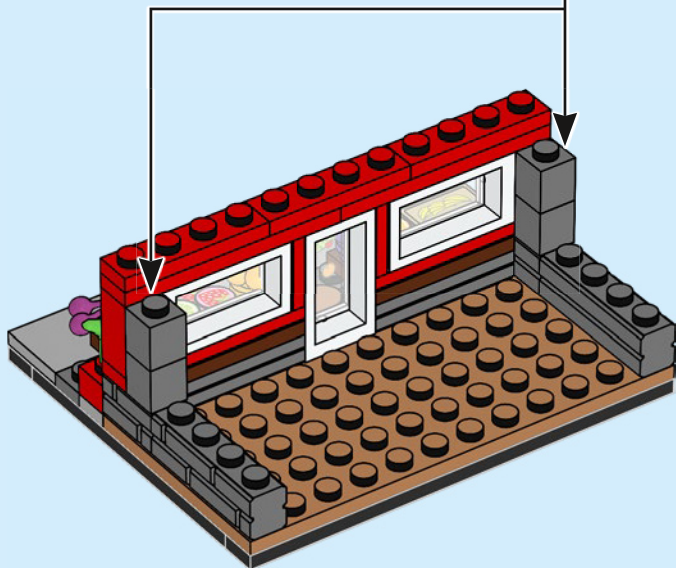



2x



2x

# 26

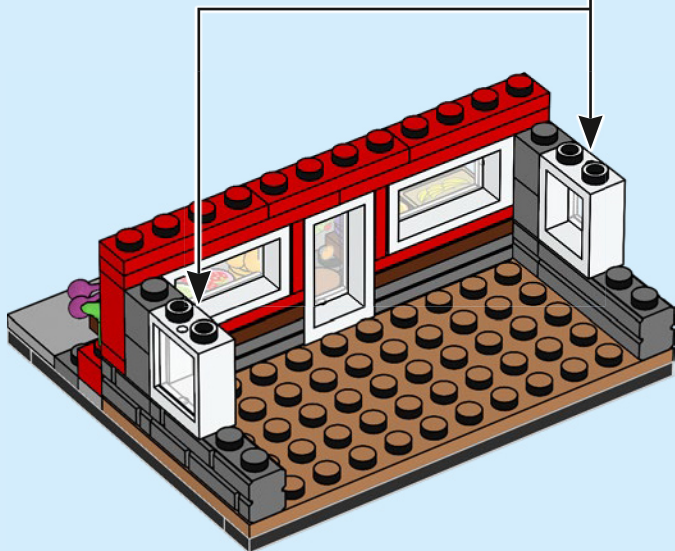
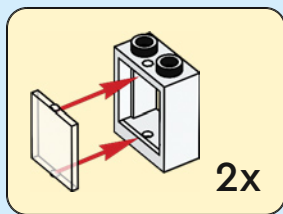



1x



1x

27

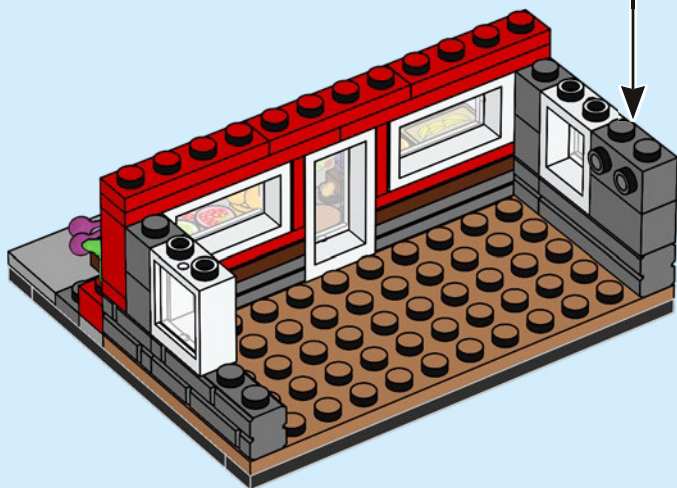
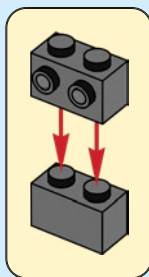



1x



1x

# 28

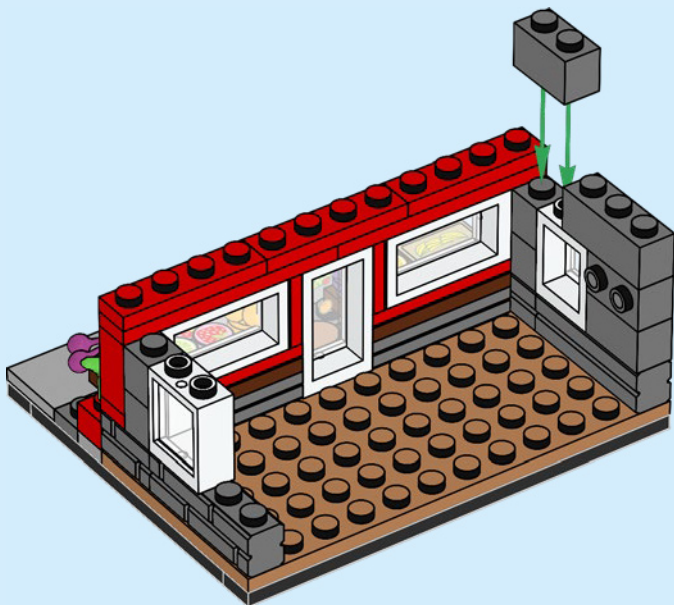



3x

29

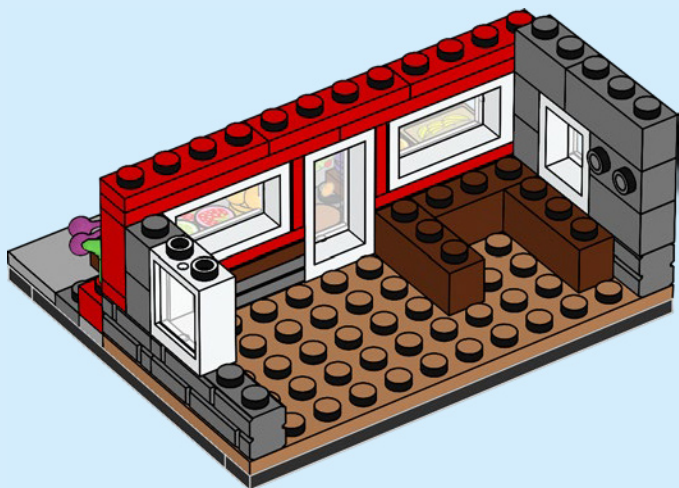



2x



2x

# 30

1



2

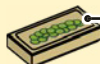

1



2







# 31

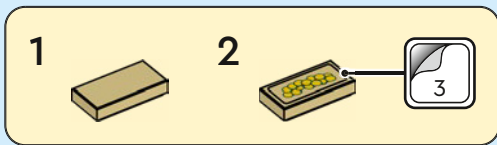



1x



2x



3x

# 32

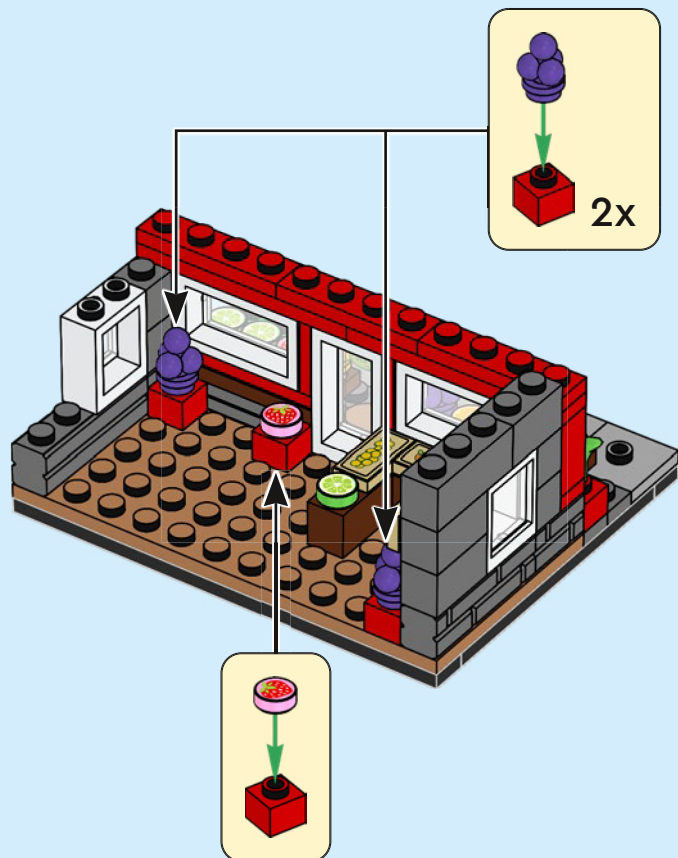

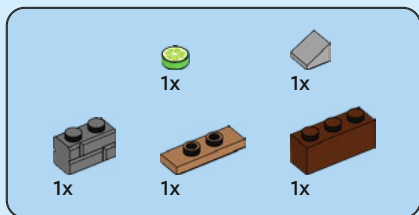

33

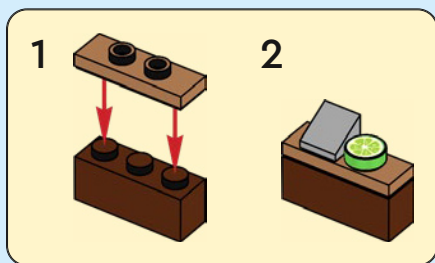



1x

# 34

1

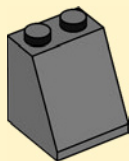

2

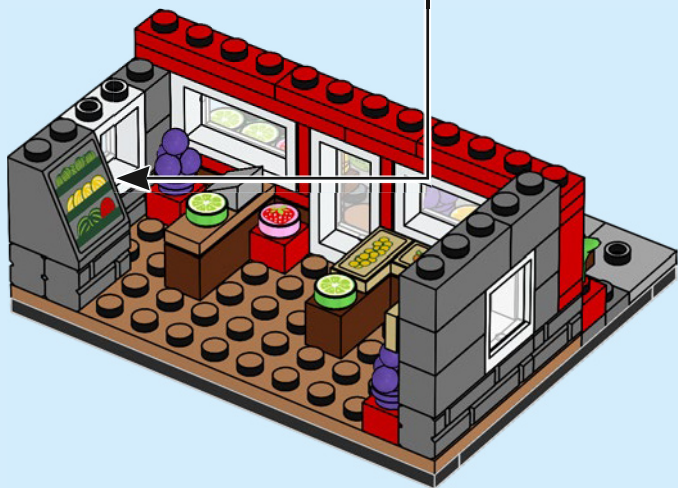



1x



1x

# 35



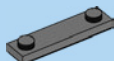

2x

# 36

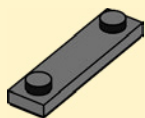

2x





6x



6x

# 37

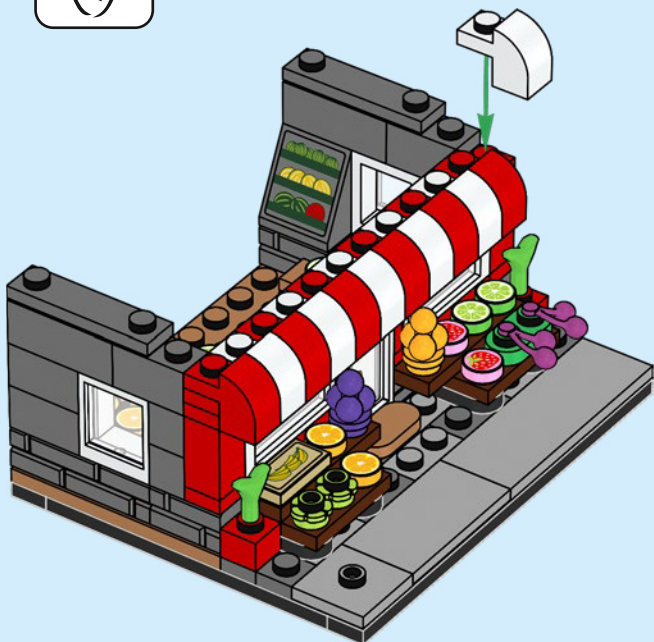



2x



2x

# 38







2x



1x



2x

# 39

1

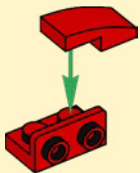

2



3

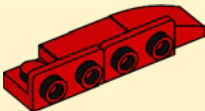

4

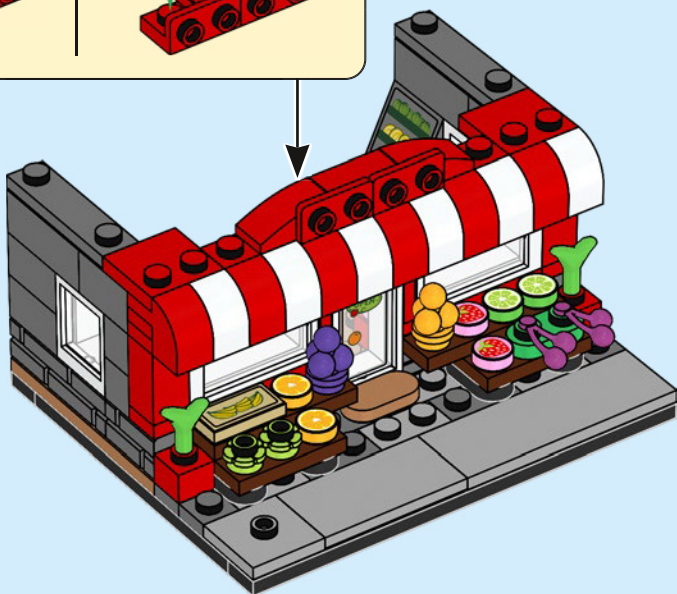
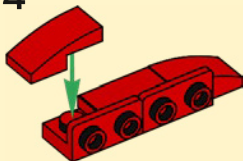



1x



2x

# 40

1

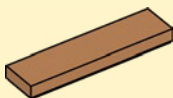

2

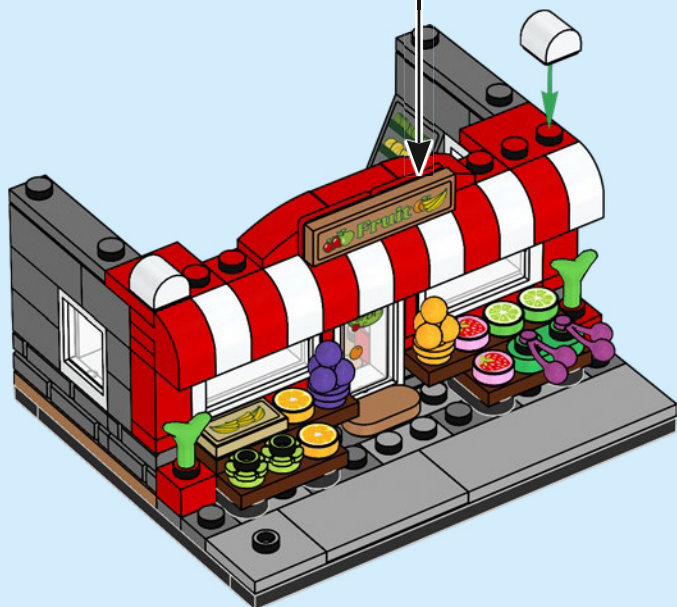



41

1



2



3



4

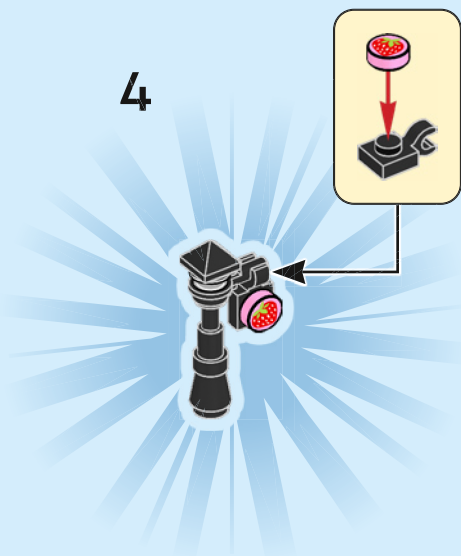





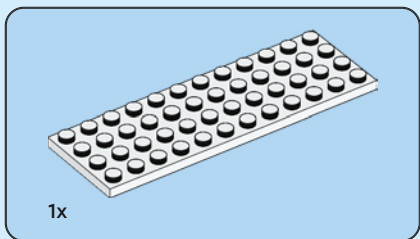
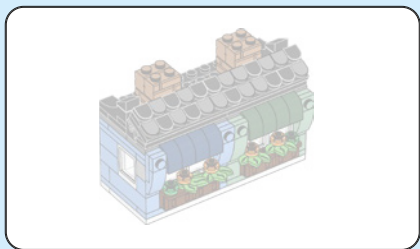

42

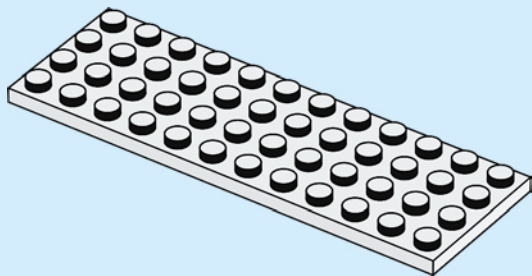

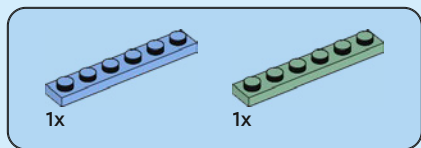

43

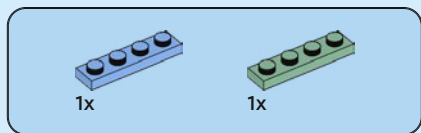
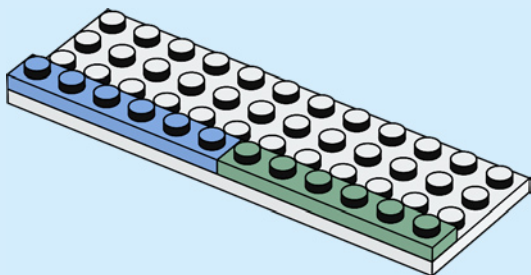

44

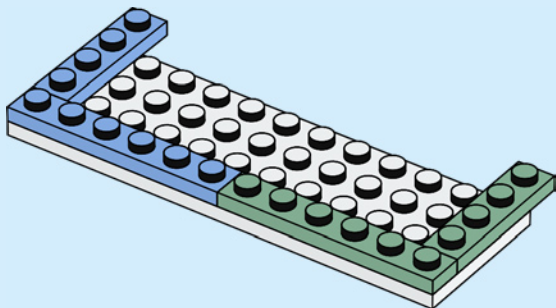



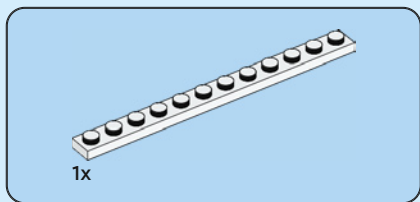

45

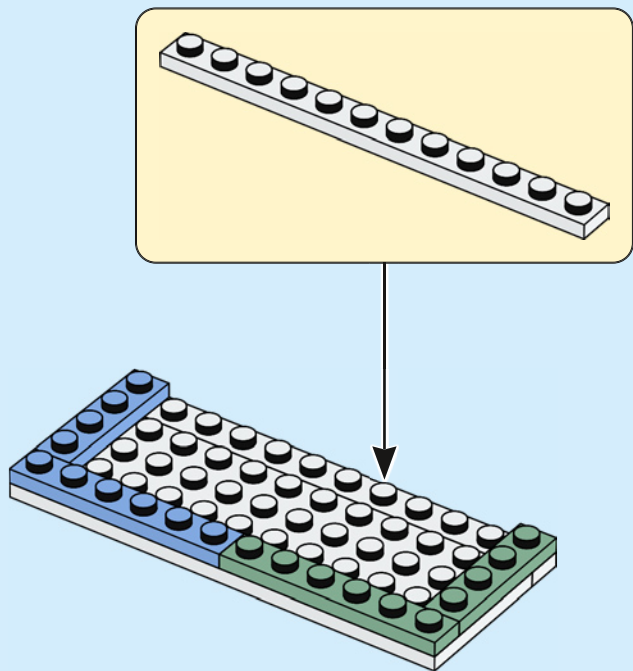



4x

46

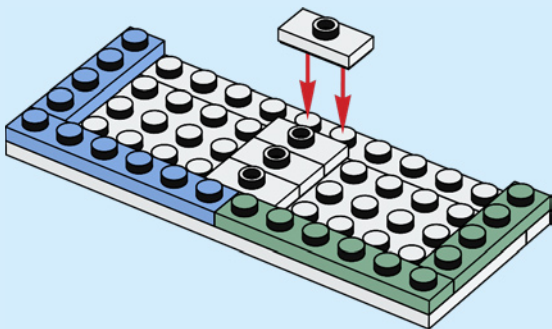

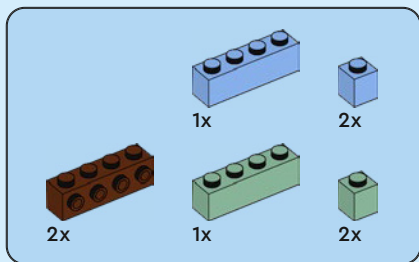

47

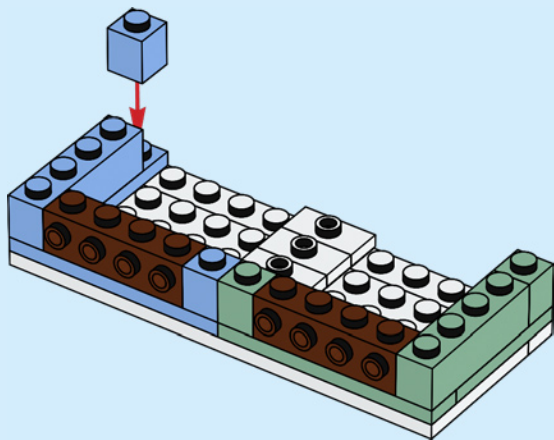

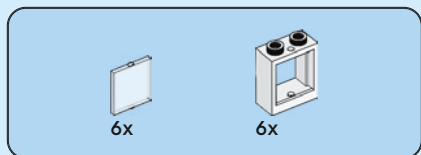

48

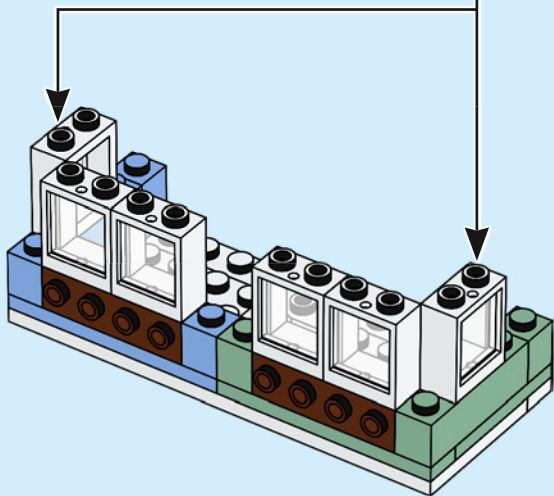
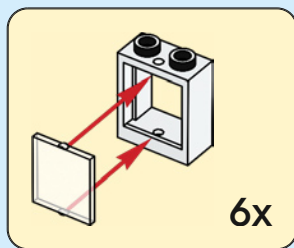



2x



2x



2x



2x

# 49



2x



2x

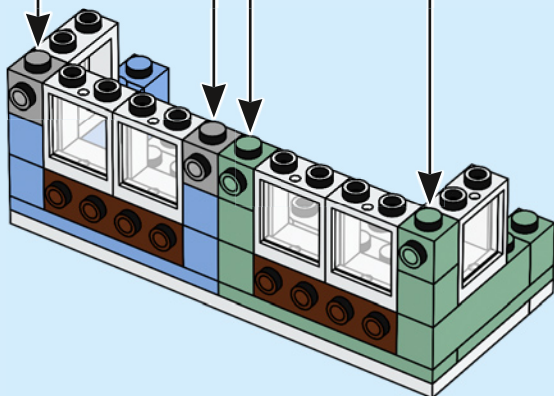

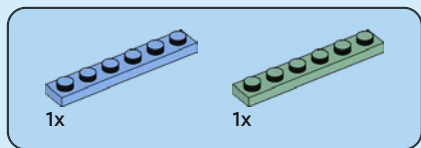

50

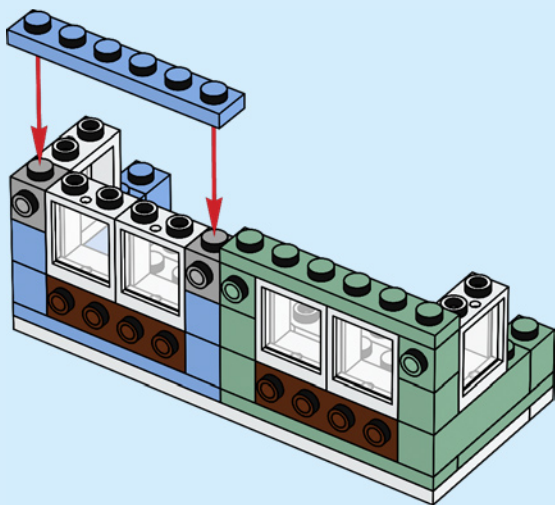



1x



1x



1x



1x

# 51

1

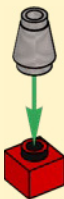

2



3

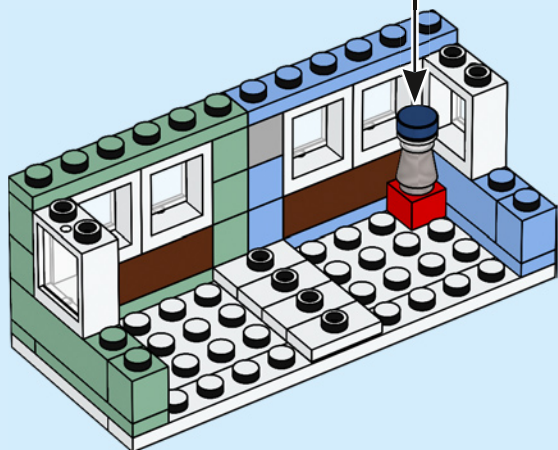



1x



2x

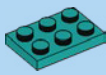

1x



1x

# 52

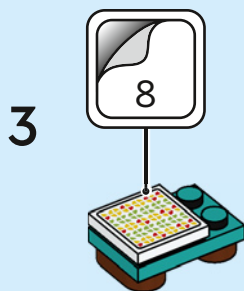
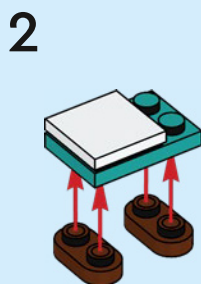
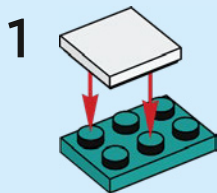



4

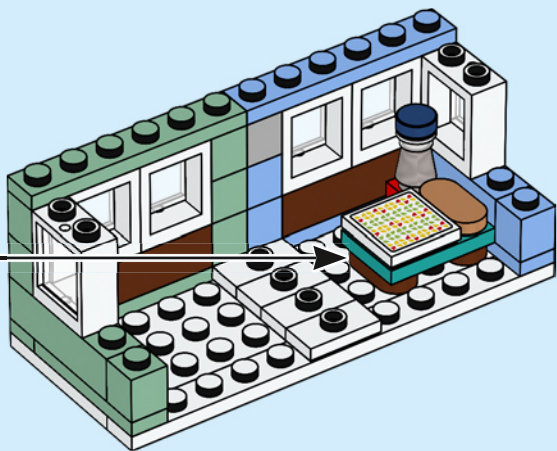



1x



1x



1x

# 53

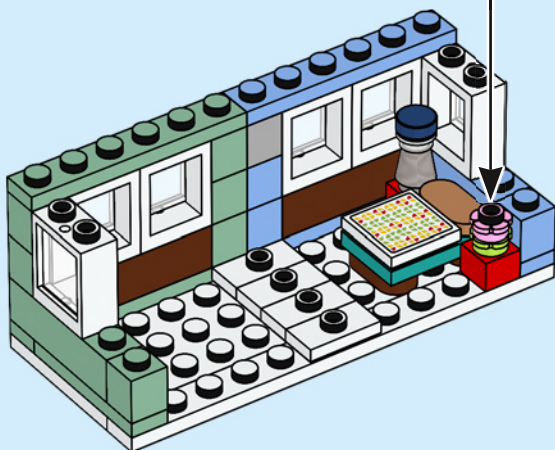
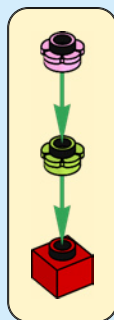



4x



1x



1x

# 54

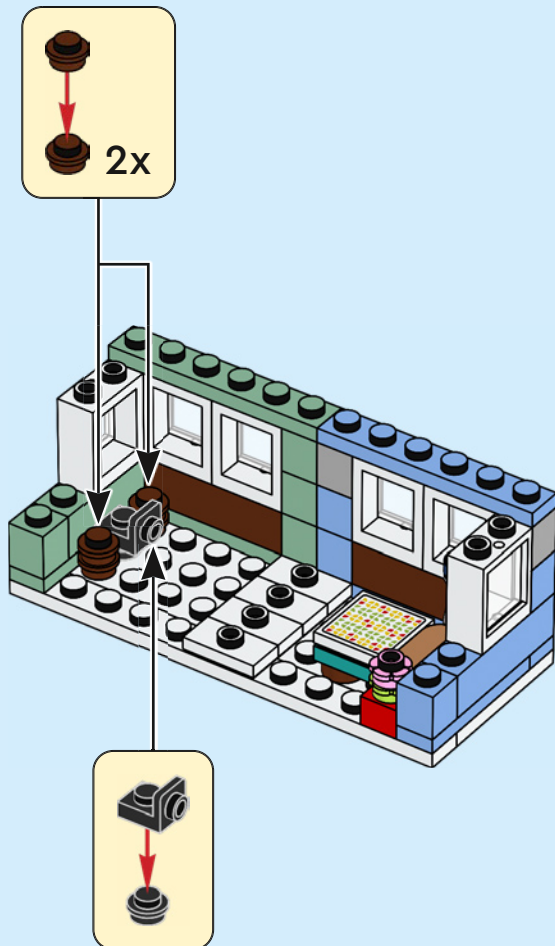



1x

55

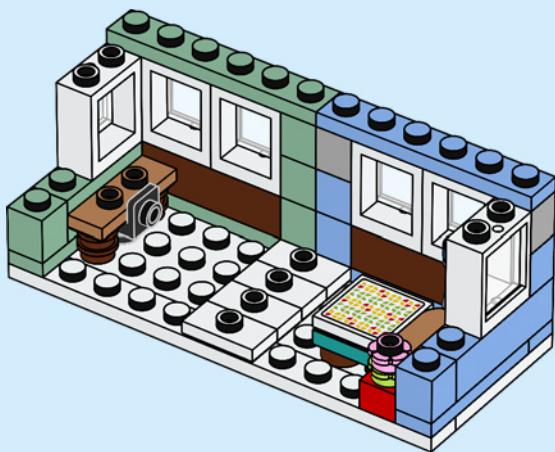



2x



1x



1x



2x

# 56

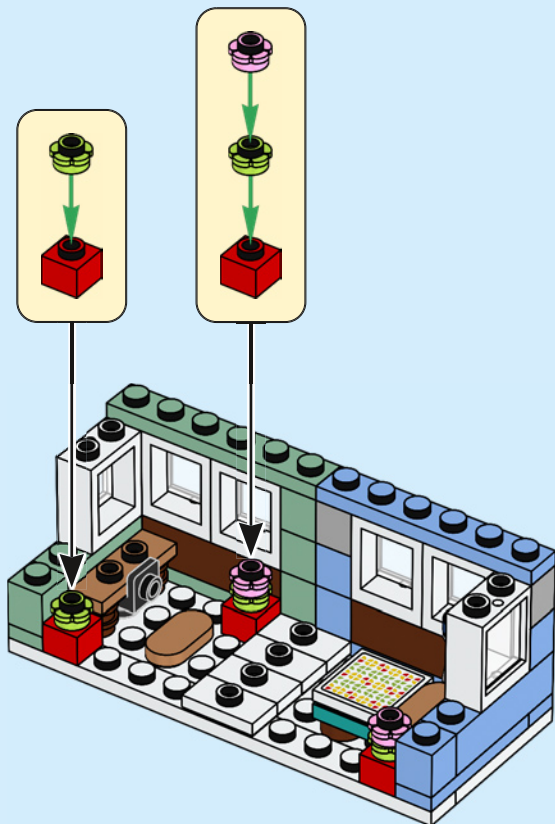



1x



1x

57

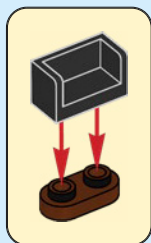



2x



1x

# 58

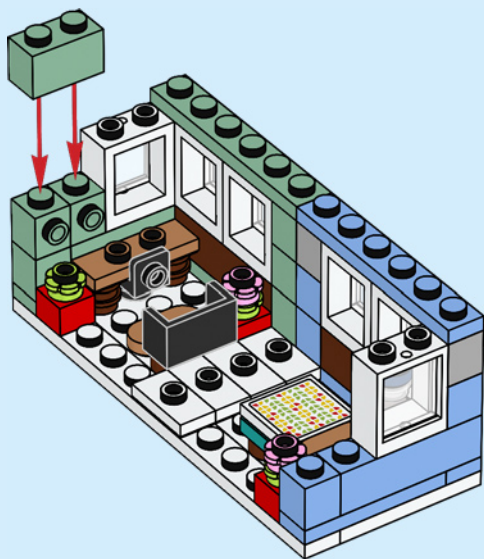



1x

# 59

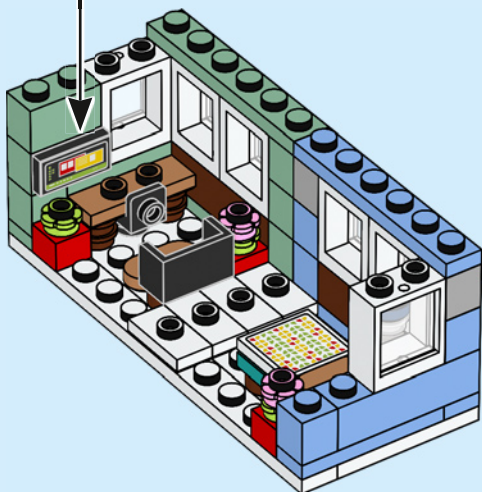
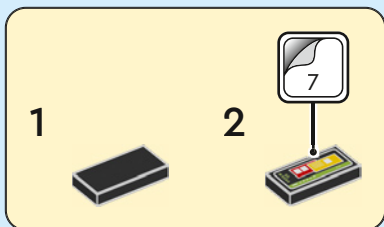



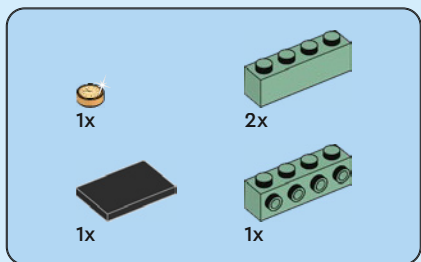

60

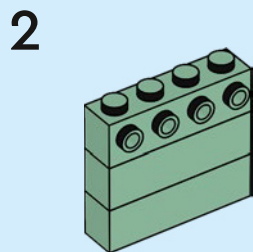
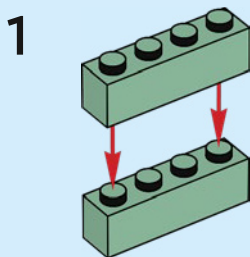



3

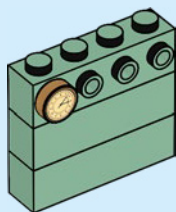

4



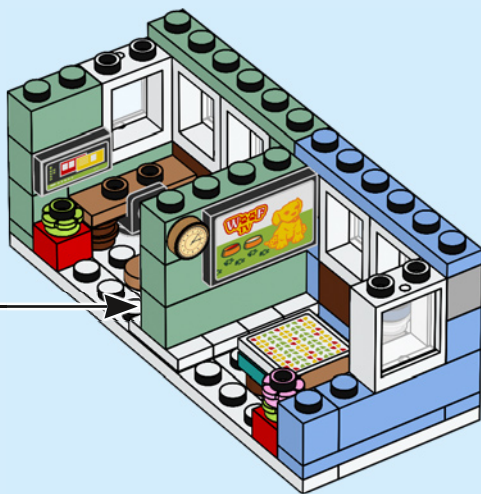



2x

61

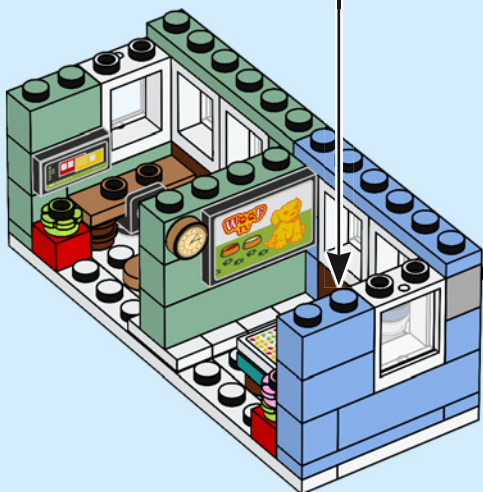
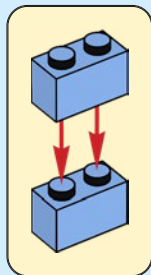



1x

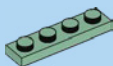

2x

62

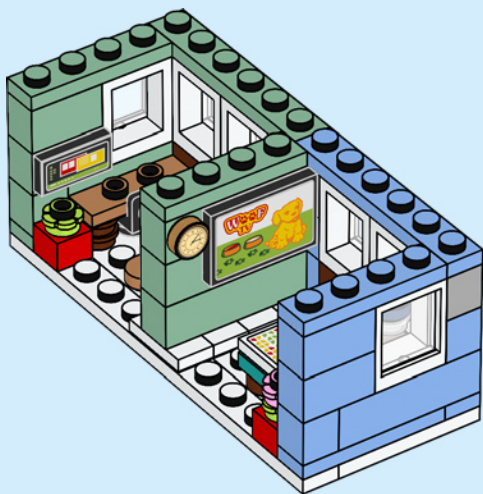

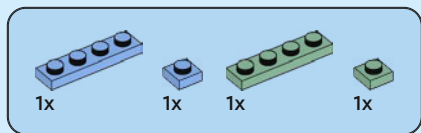

63

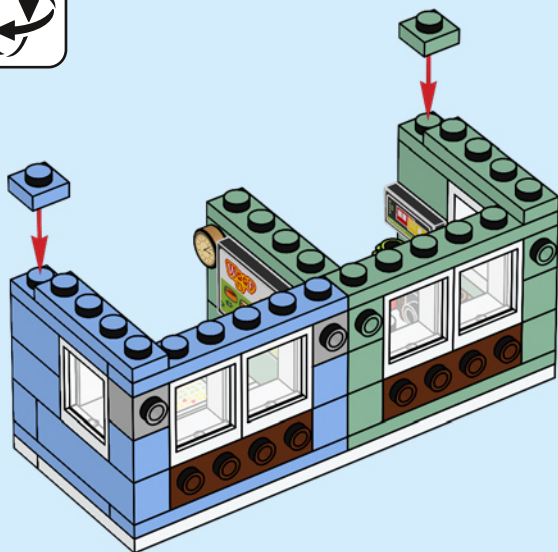



1x



1x



1x

# 64

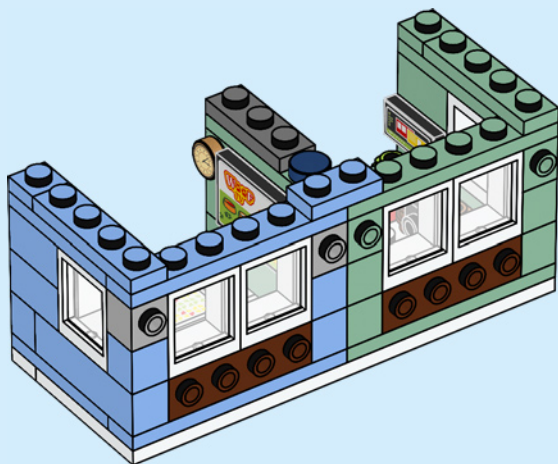



2x



2x



2x

# 65

1

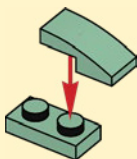

2

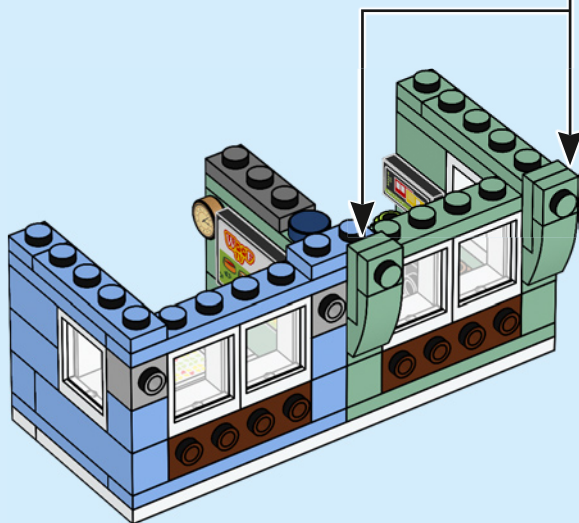
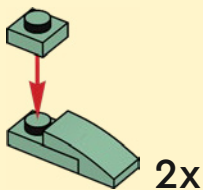





66

1

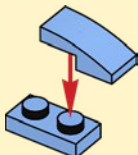

2

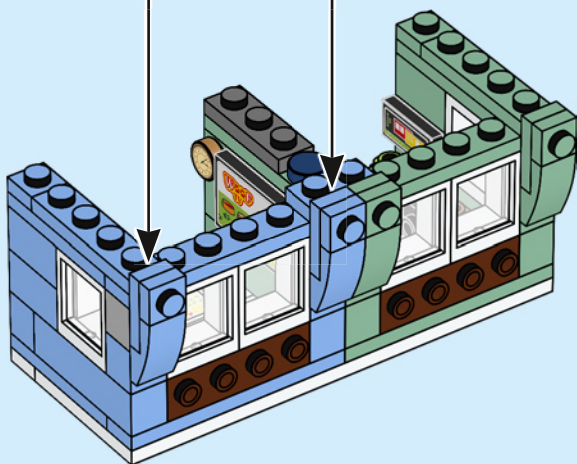
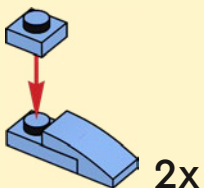



4x



4x

67

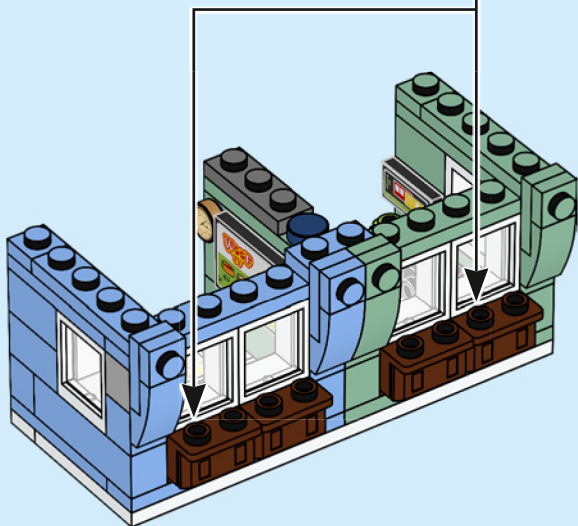
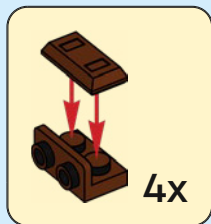



2x

68

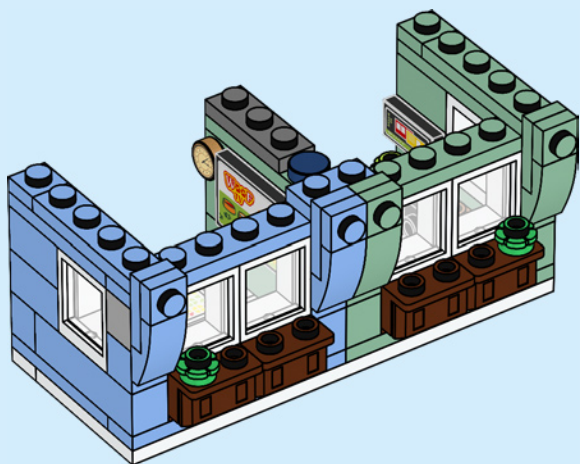



69

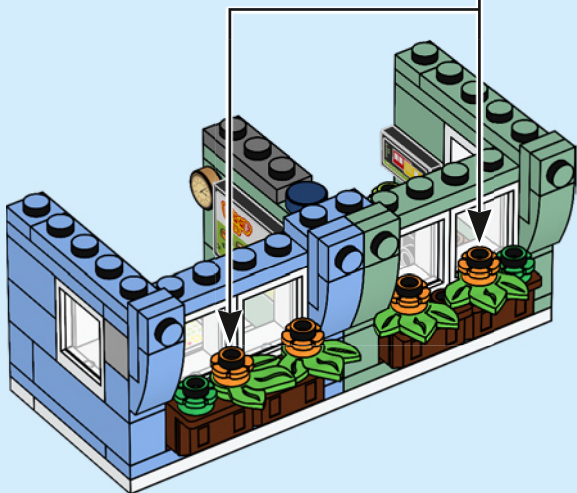
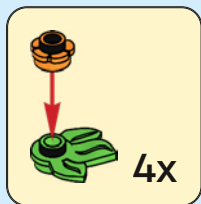



4x



4x

# 70

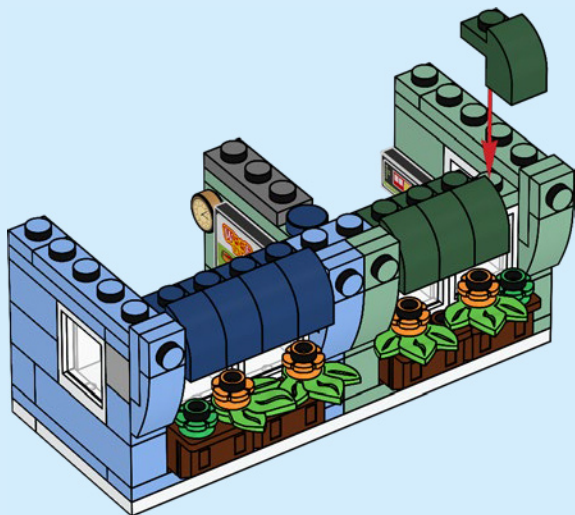

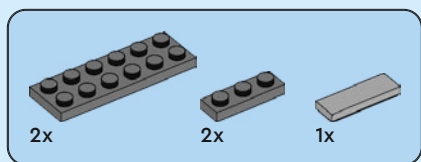

71

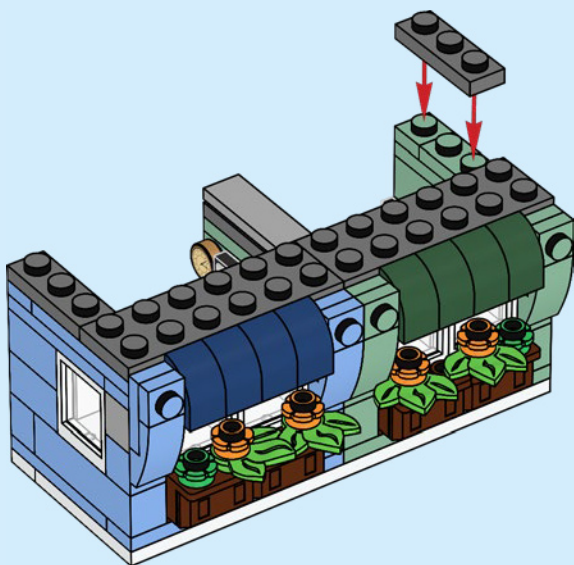

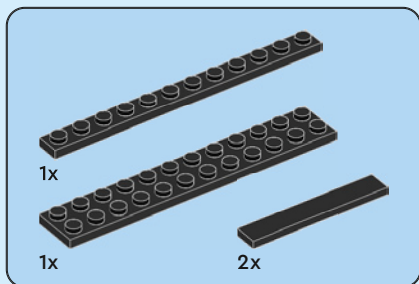

72

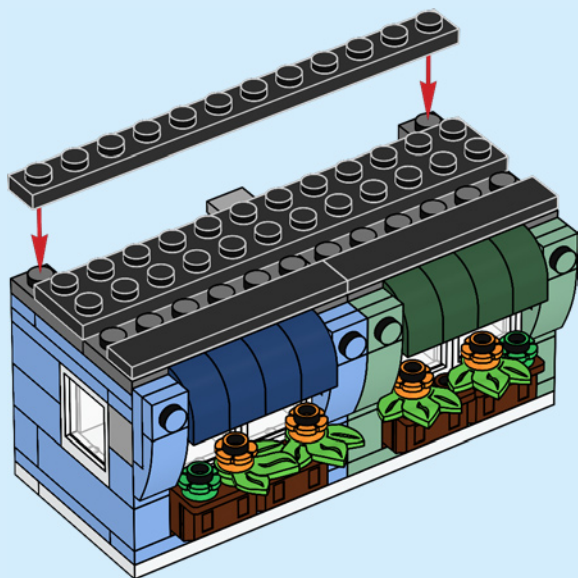



2x



2x



2x

# 73

1

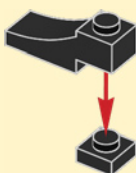

2

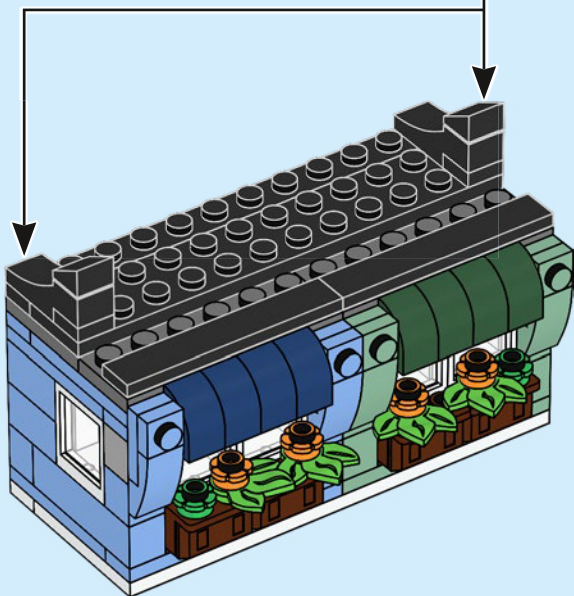
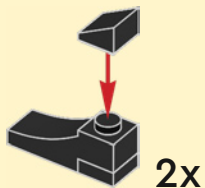





4x

74

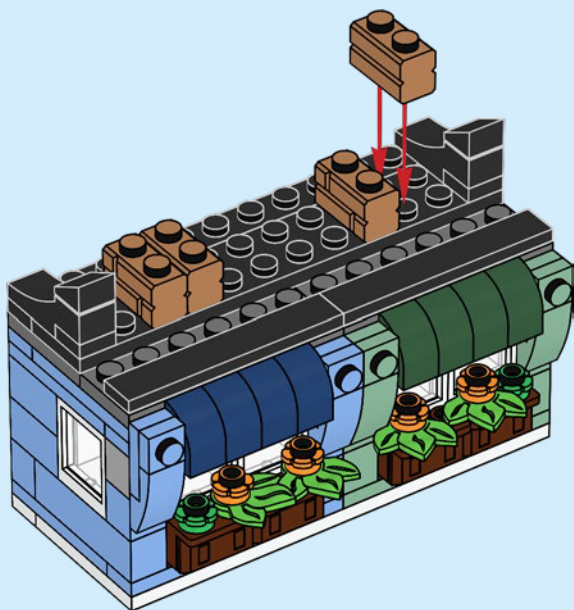



4x

75

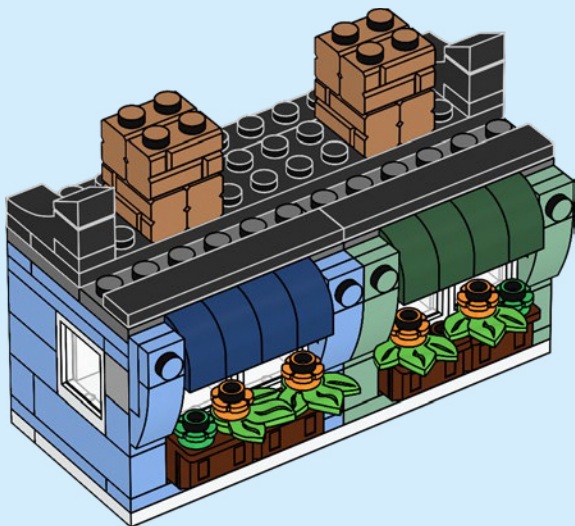



6x



6x

76



6x

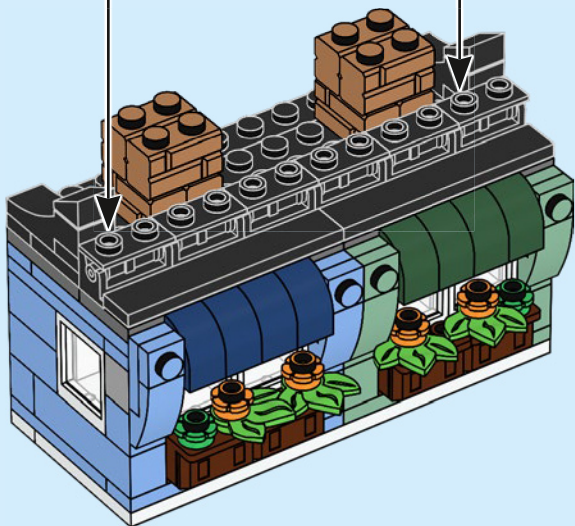

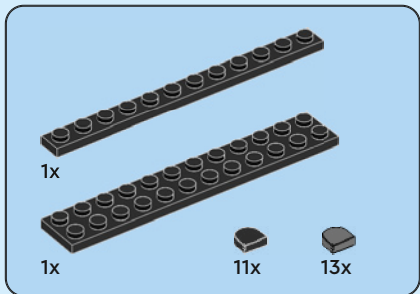
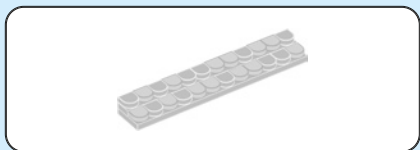

77

1

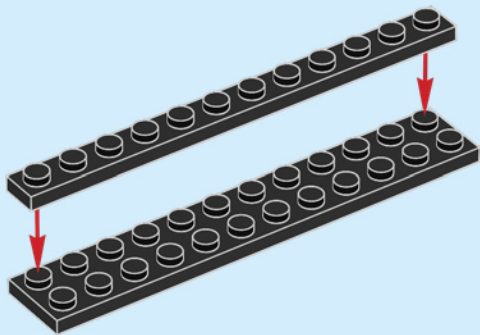

2

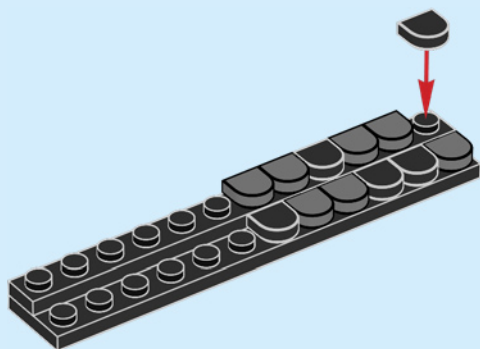

3

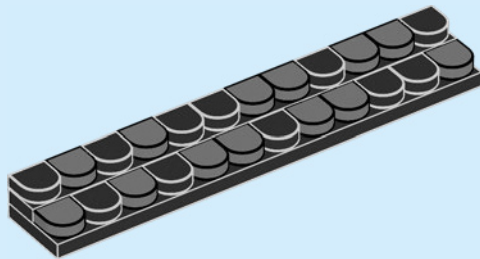

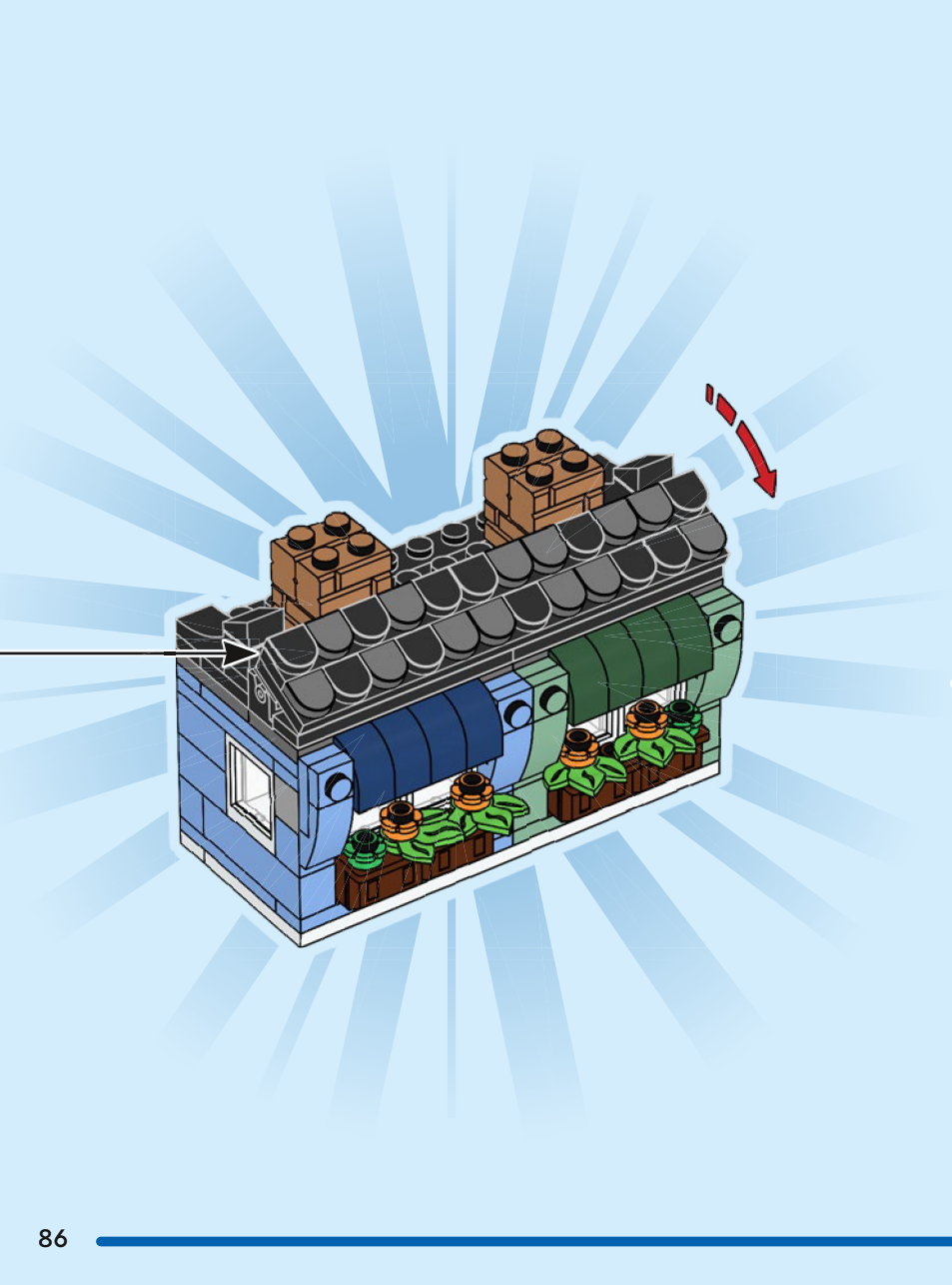

78

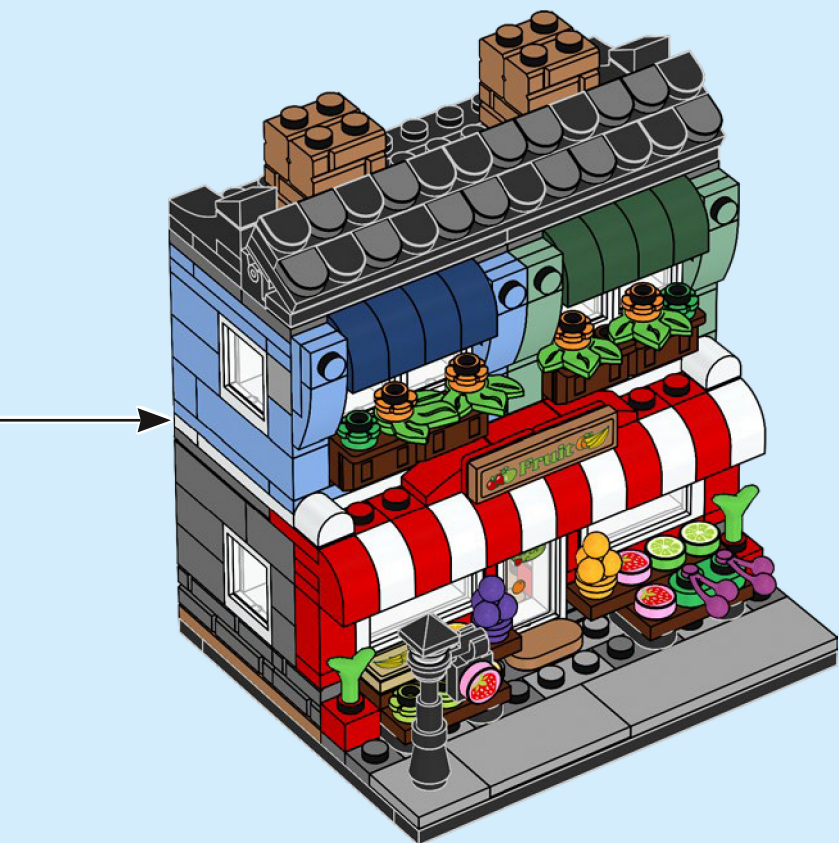





  
2x  
6258135

  
6x  
6285777

  
4x  
6051511

  
1x  
306801

  
8x  
6382045

  
3x  
6468341

  
2x  
371001

  
2x  
302001

  
1x  
4514842

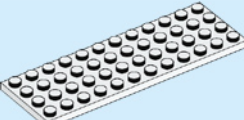
  
1x  
4168072

  
2x  
302421

  
2x  
6187620

  
9x  
6397571

  
3x  
306921

  
6x  
6184782

  
2x  
6029946

  
2x  
6089698

  
2x  
6219819

  
2x  
243121

  
5x  
371021

  
2x  
366621

  
2x  
6100562

  
4x  
6435103

  
1x  
4286789

  
3x  
6278447

  
4x  
6214234

  
2x  
6212501

  
5x  
6209692

  
1x  
6372427

  
4x  
6287844

  
2x  
6135287

  
1x  
6210271

  
5x  
4114026

  
4x  
6435099

  
2x  
4119479

  
4x  
6182261

  
3x  
4179826

  
4x  
4179830

  
2x  
6301857

  
3x  
4179825

  
2x  
4179833

  
1x  
4163696

  
3x  
4179828

  
2x  
4179829



4x  
6009656



4x  
4521948



3x  
6099189



2x  
4655080



1x  
4616581



2x  
6196591



3x  
4521947



4x  
6100234



1x  
6423405



2x  
6099187



1x  
6051385



2x  
6240030



8x  
6254552



3x  
6252258



4x  
4216581



3x  
6248944



4x  
6261744



4x  
6174856



4x  
4211220



2x  
4211189



2x  
6153594



2x  
4211186



1x  
614126



11x  
6256435



1x  
4529236



2x  
4504382



1x  
6312449



2x  
302426



1x  
6234695



1x  
6308000



1x  
6196548



1x  
4538456



1x  
306926



4x  
6210270



6x  
393826



1x  
6248496



6x  
393726



2x  
6328095



1x  
6162892



2x  
663626



3x  
303426



4x  
4514845



2x  
244526



2x  
4558953



1x  
4521921



6x  
4211398



1x  
6126082



1x  
4558169



1x  
4560183

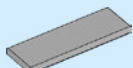

1x  
6318584



2x  
6284584



4x  
6411363



4x  
6411352



1x  
6249417



13x  
6362252



2x  
4210719



4x  
4211098



5x  
4211063



3x  
4211088



1x  
6230233



3x  
6000311



1x  
4234534



3x  
4211133



2x  
4211104



6x  
6257592



2x  
6055310



2x  
4211002



3x  
6399909



8x  
4656783



2x  
6292145



1x  
6102998

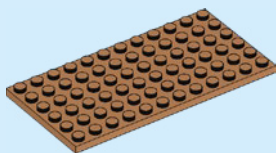

1x  
6423217



LEGO.com/service

YOU COULD

# WIN



Scan this QR code or go to **LEGO.COM/PRODUCTFEEDBACK** and give us your short feedback about this LEGO® set for a chance to win a cool LEGO prize.

Terms and Conditions apply\*

**EN: YOU COULD WIN.** Terms and Conditions apply\* **DE: Du könntest GEWINNEN.** Es gelten die Teilnahmebedingungen\* **FR: Tu pourrais GAGNER.** Des conditions s'appliquent\* **IT: Potresti VINCERE tu.** Termini e condizioni sono applicabili\* **ES: Puedes GANAR.** Aplican términos y condiciones\* **PT: Poderá GANHAR.** Aplicam-se termos e condições\* **ZH: 轻松获奖. 条款和条件适用\*** **PL: Szansa na WYGRANĄ.** Obowiązują warunki korzystania\* **CS: Máte šanci VYHRÁT.** Platí všeobecné smluvní podmínky\* **SK: Máte šancu VYHRAŤ.** Platia všeobecné zmluvné podmienky\* **HU: TE IS NYERHETSZ.** Felhasználási feltételek érvényesek\* **RO: Ai putea CÂȘTIGA.** Se aplică termenii și condiții\* **BG: Можете да СПЕЧЕЛИТЕ.** Има определени правила и условия\* **LV: Tu vari LAIMĒT.** Ir spēkā noteikumi un nosacījumi.\* **ET: Sul on võimalus VÕITA.** Kehtivad tingimused\* **LT: Jūs galite LAIMĖTI.** Taikomos sąlygos\*

\*[LEGO.com/productfeedback-terms](https://www.lego.com/productfeedback-terms)