



40601





Get excited about our new packaging!

We're switching from plastic to paper-based packaging. That's why you might find a mix of paper and plastic in our boxes!

Nos nouveaux emballages vous emballeront !

Nous passons des emballages en plastique aux emballages à base de papier. C'est pourquoi vous pourriez trouver un mélange de papier et de plastique dans nos boîtes !

¡Te presentamos nuestros nuevos empaques!

Estamos sustituyendo las bolsas de plástico por bolsas con base de papel. ¡Por eso, puedes encontrar una mezcla de papel y de plástico en nuestras cajas!

[LEGO.com/sustainable-packaging](https://www.lego.com/sustainable-packaging)

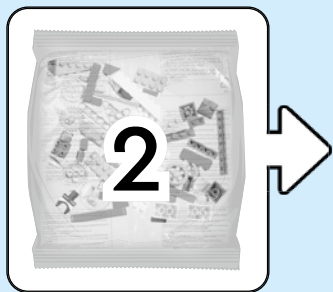
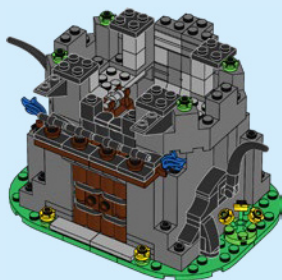

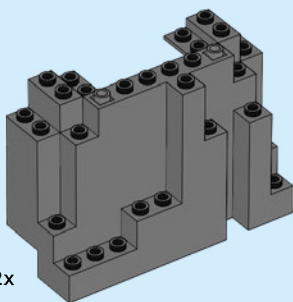
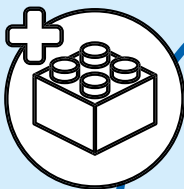

2x



1

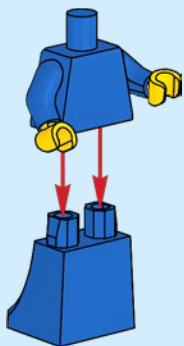

2

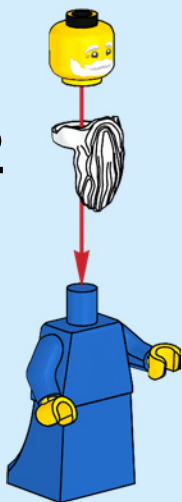

3



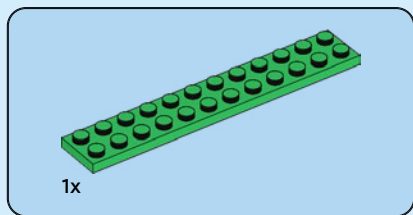
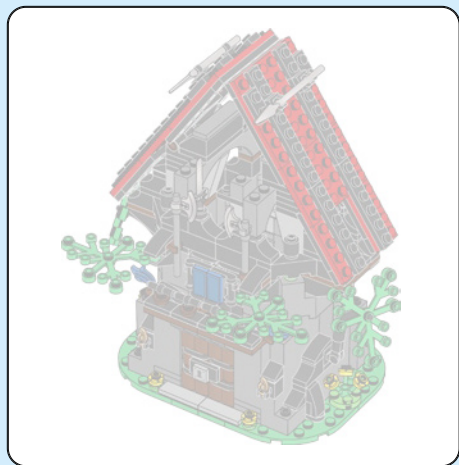

1x

1

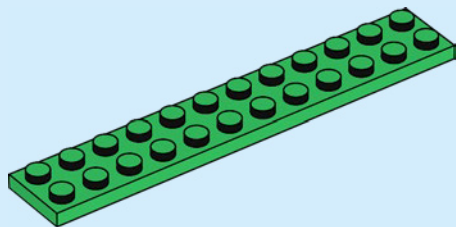

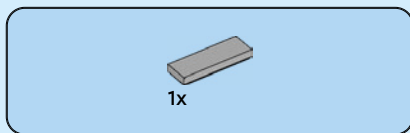

2

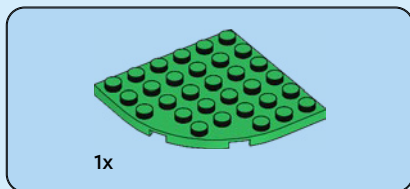
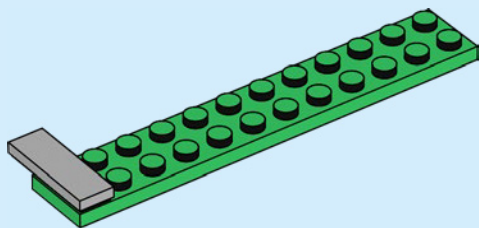

3

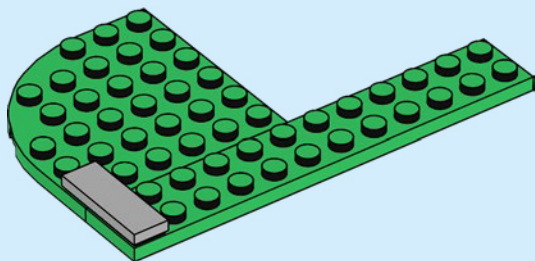



1x



2x

4

1

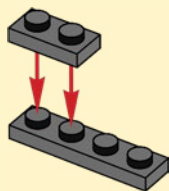

2

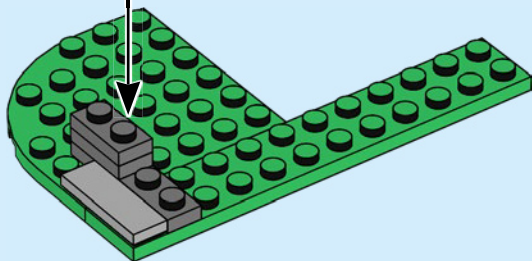
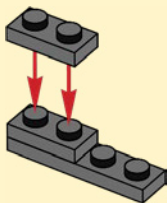



1x

5

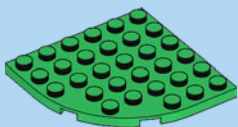
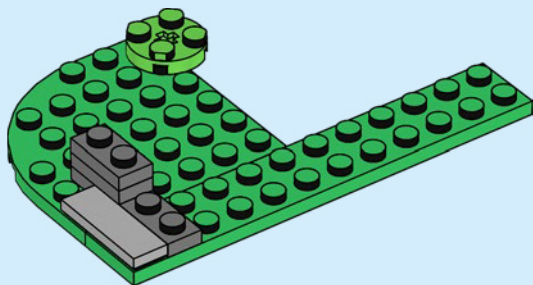

1x

6

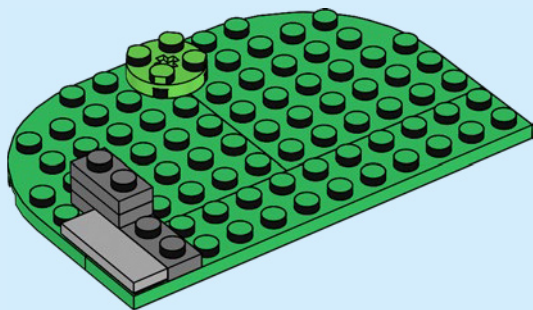



2x



2x

7

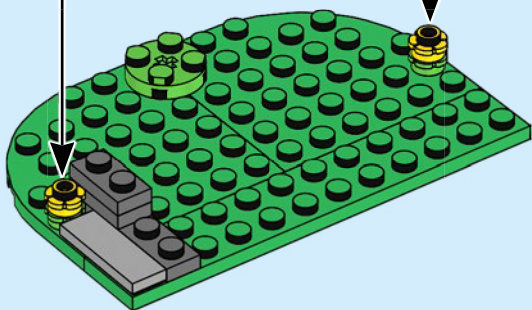
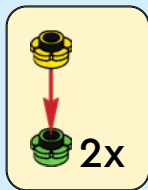

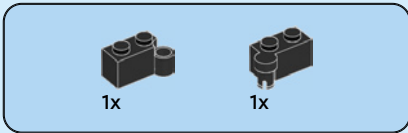

8

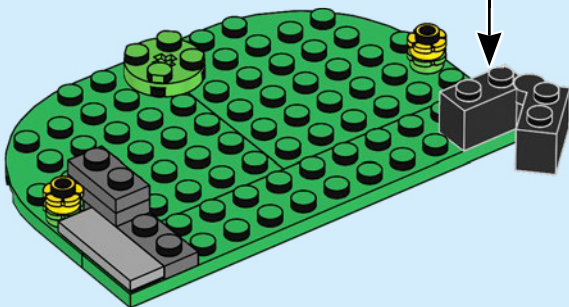
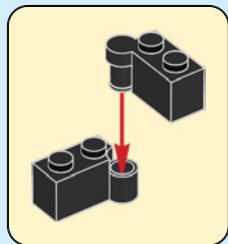



1x

9

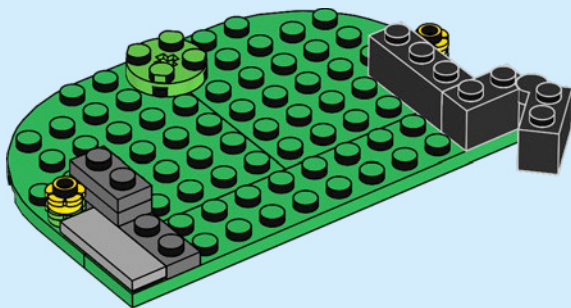

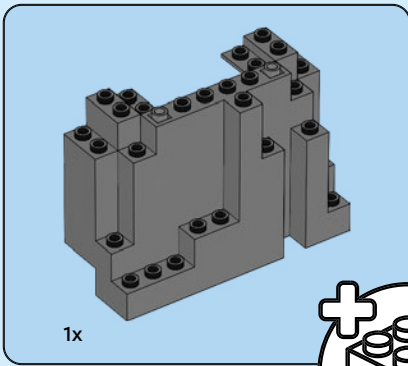

1x

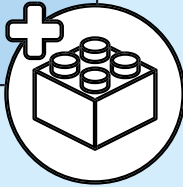

10

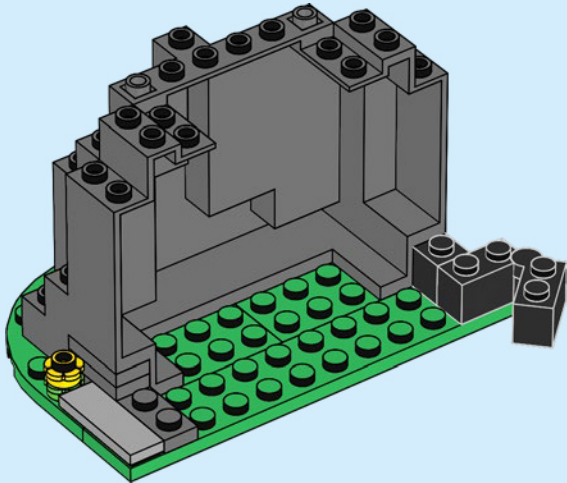

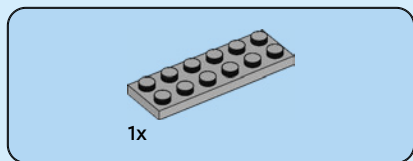

11

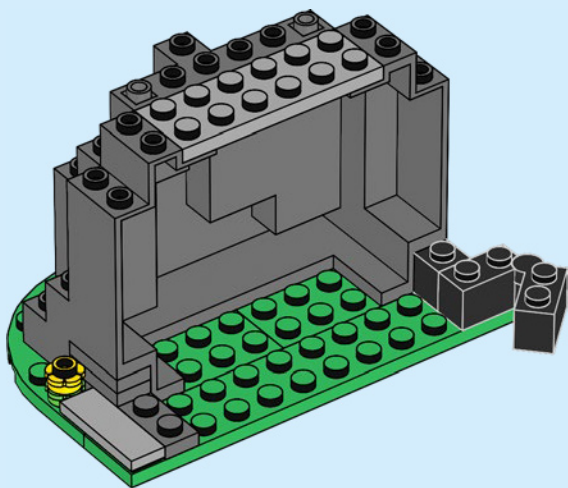

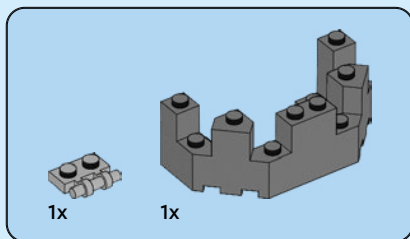

12

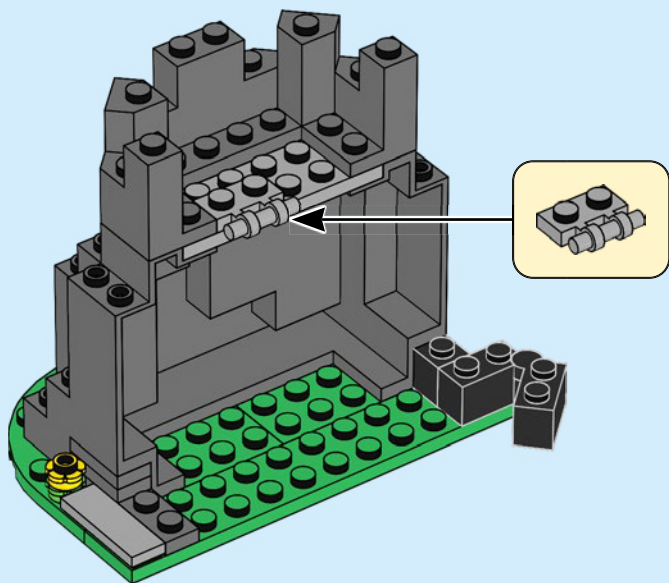



1x



1x

13

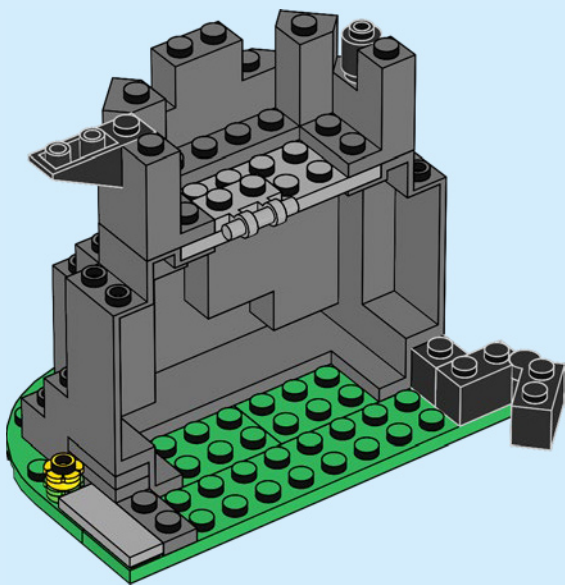



3x



1x

14

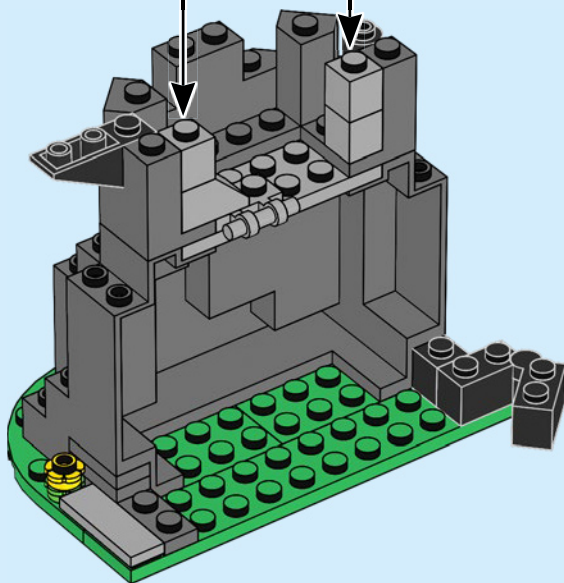
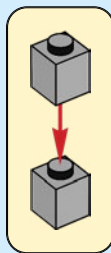
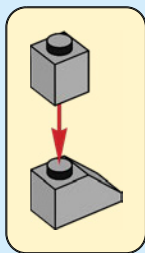



2x



2x

15

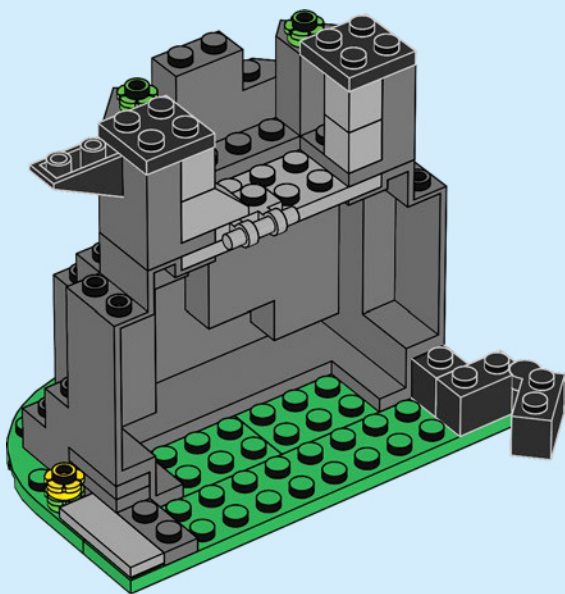



1x



1x

16

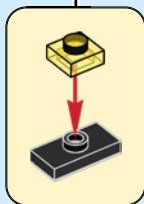
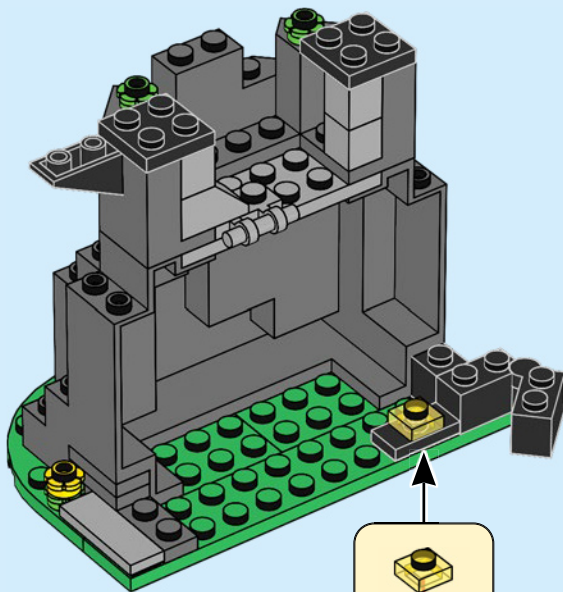

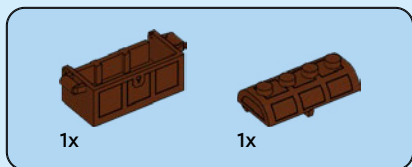

17

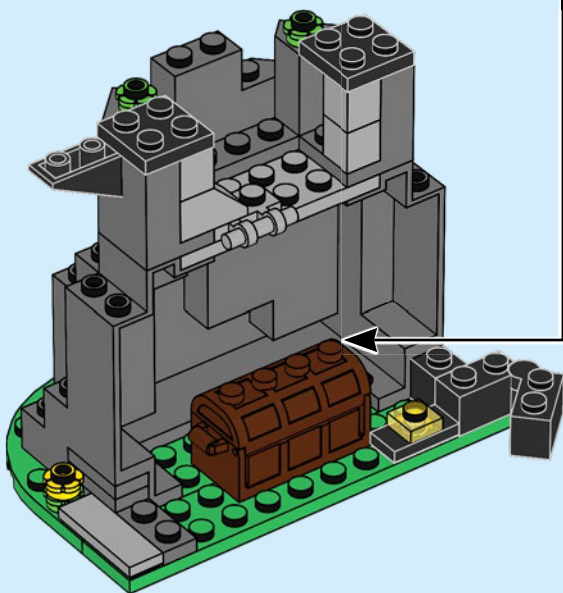
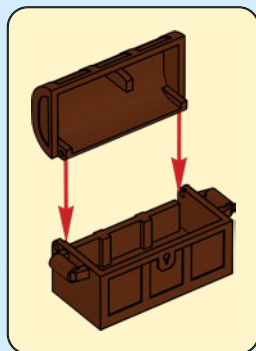

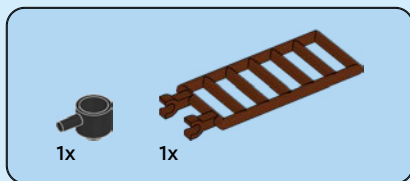

18

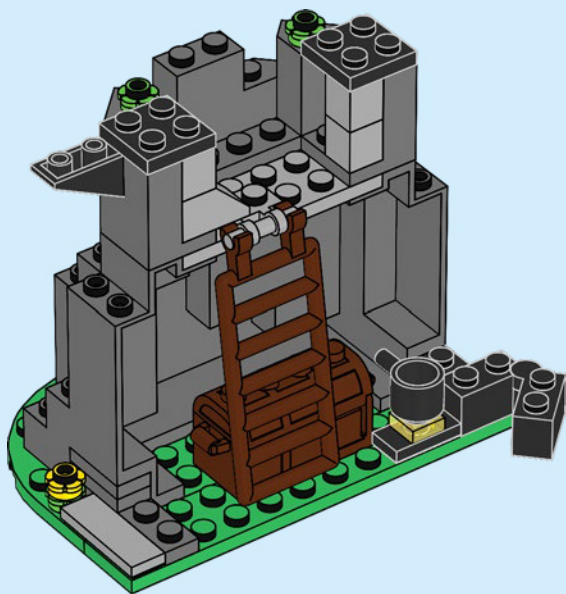



1x



1x

19

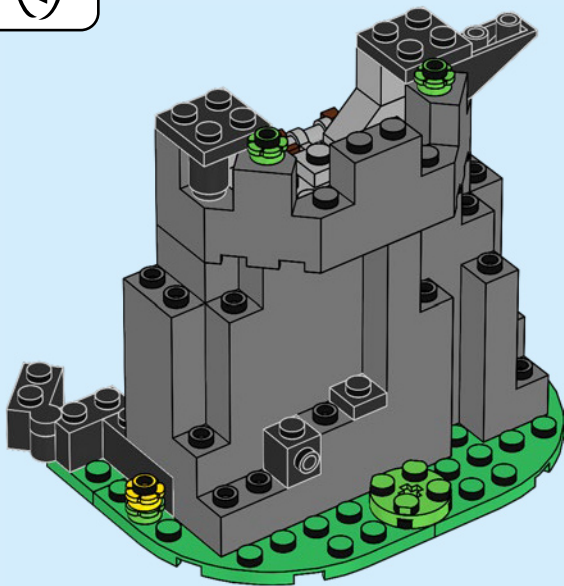
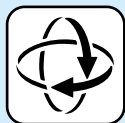



1x



1x

20

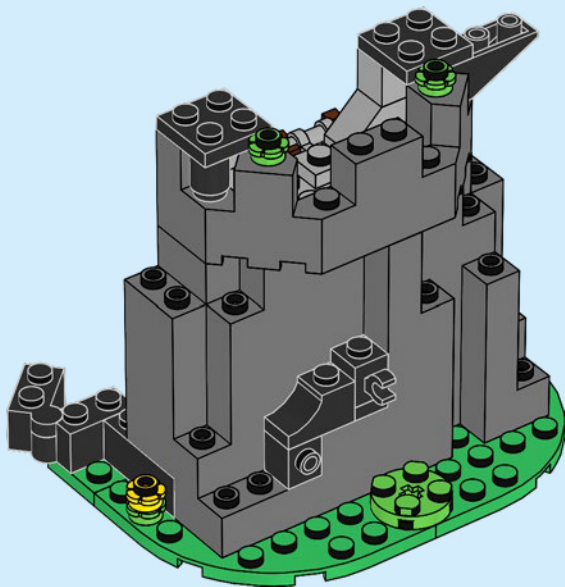



1x

21

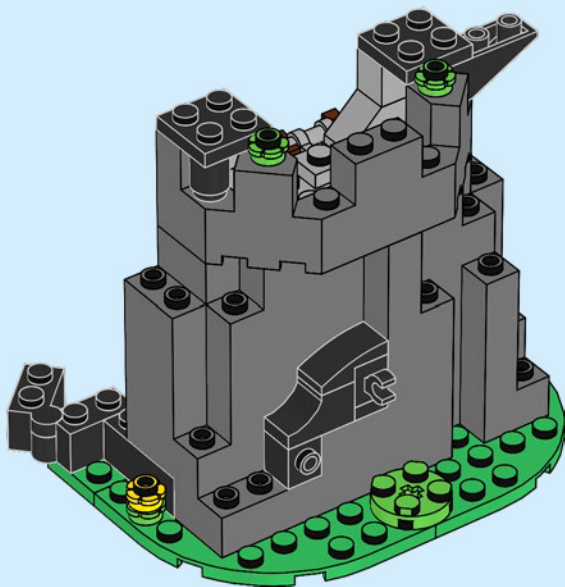



1x



1x

22

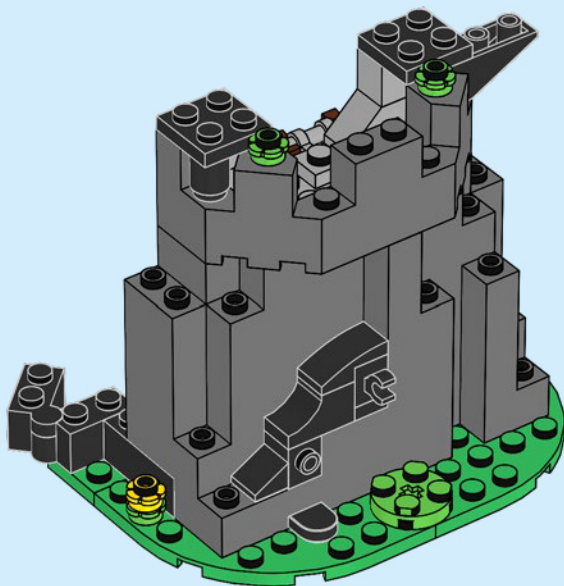



1x



1x

23

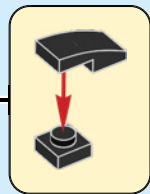
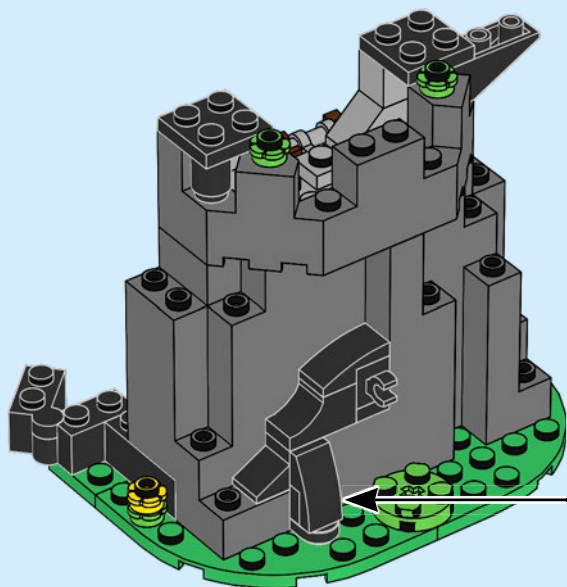



1x



3x

24

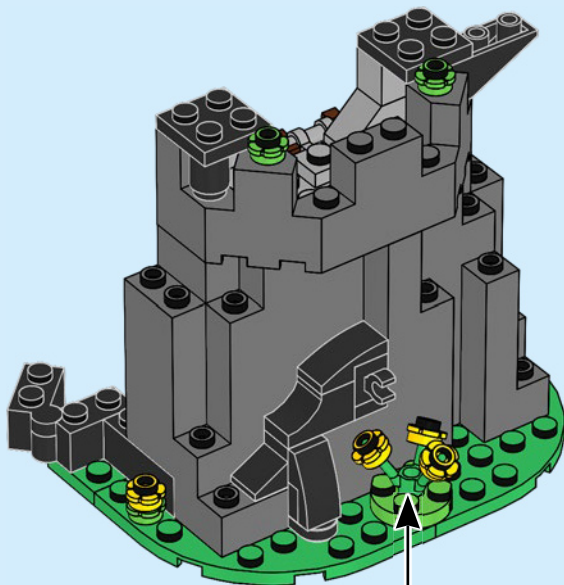

1



2



1x



1x



25

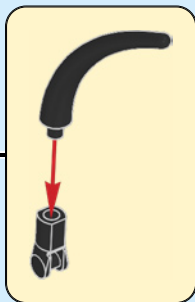
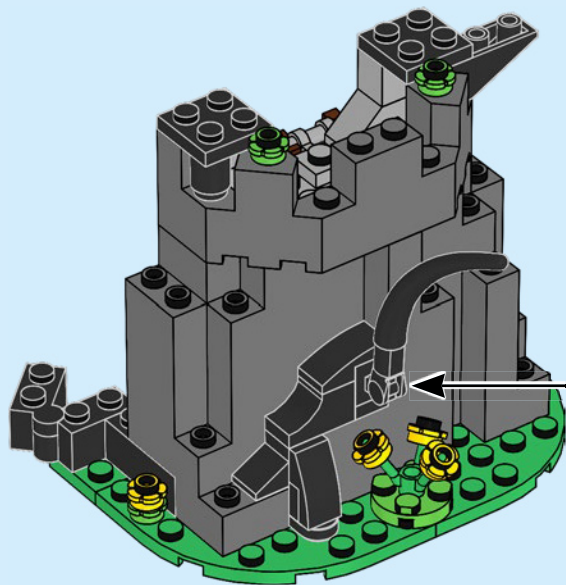

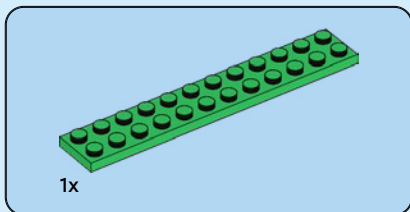
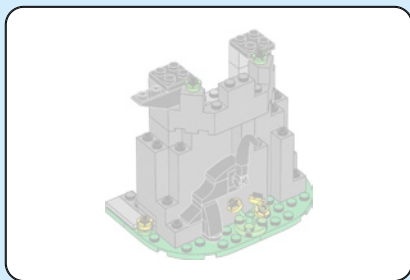

26

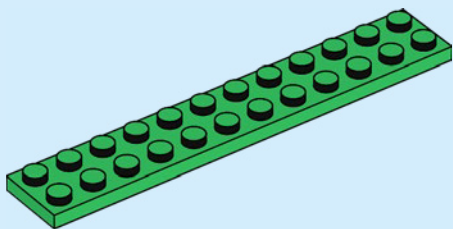

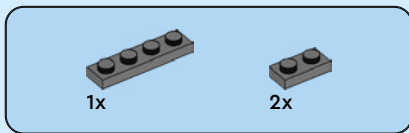

29

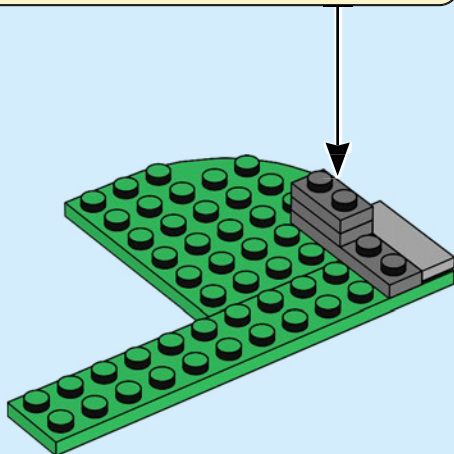
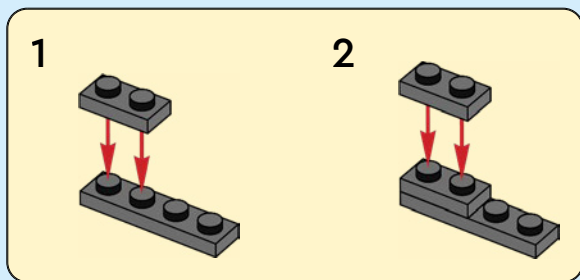



1x

30

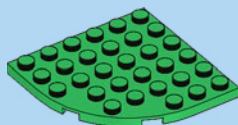
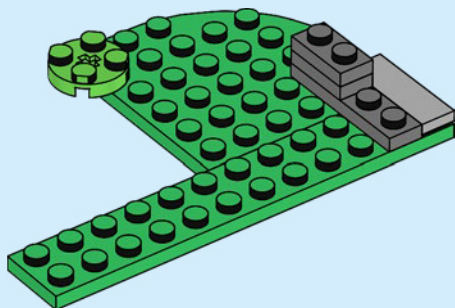

1x

31

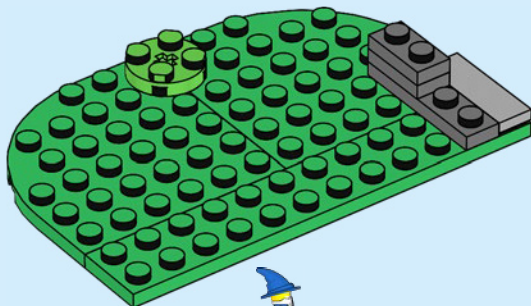



2x



2x



2x

32

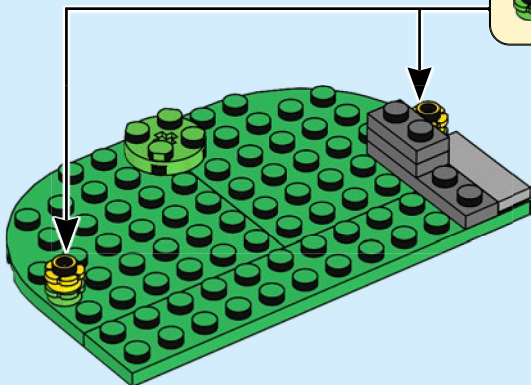

1x

33

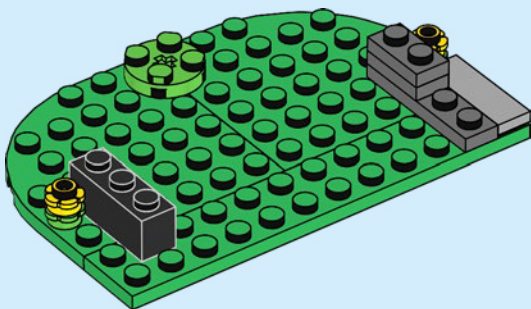

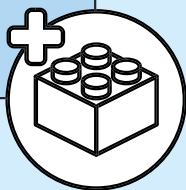
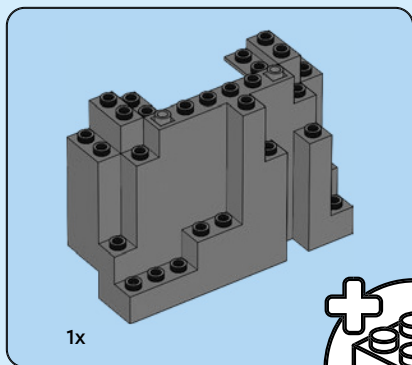

34

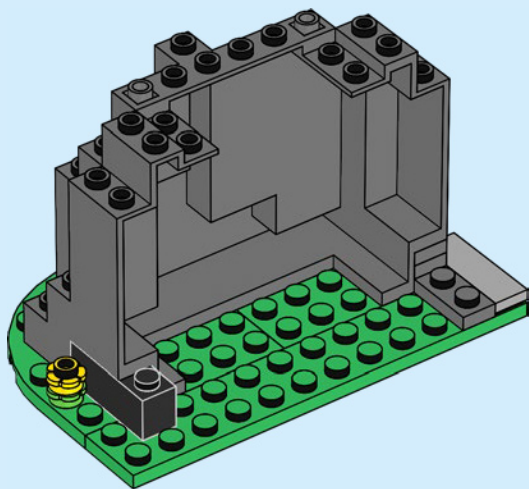

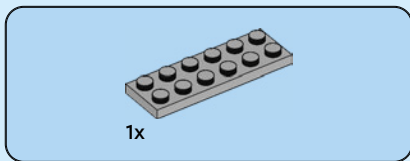

35

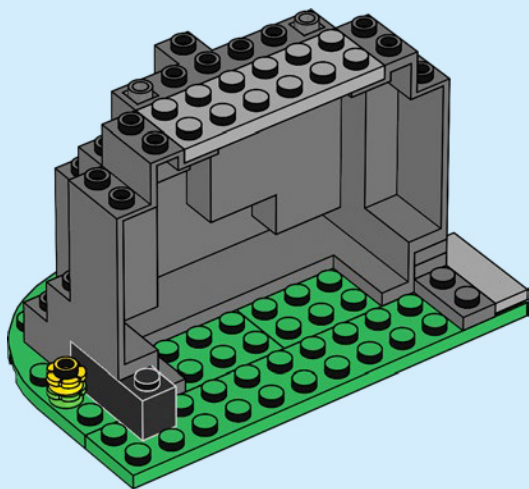

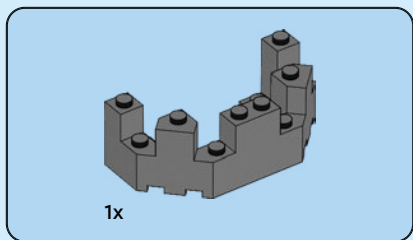

36

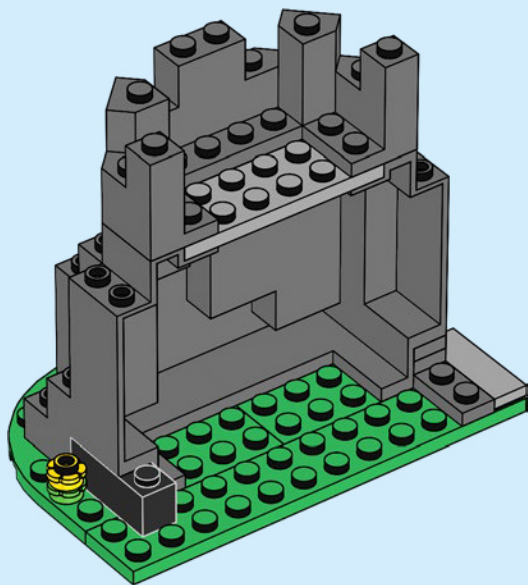



1x



1x

37

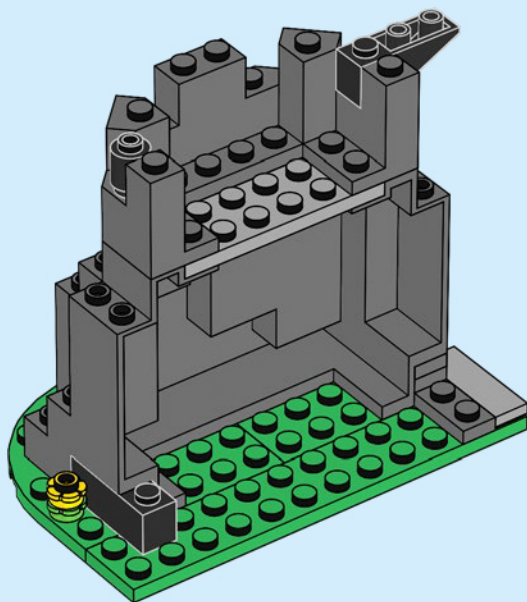



4x

38



2x

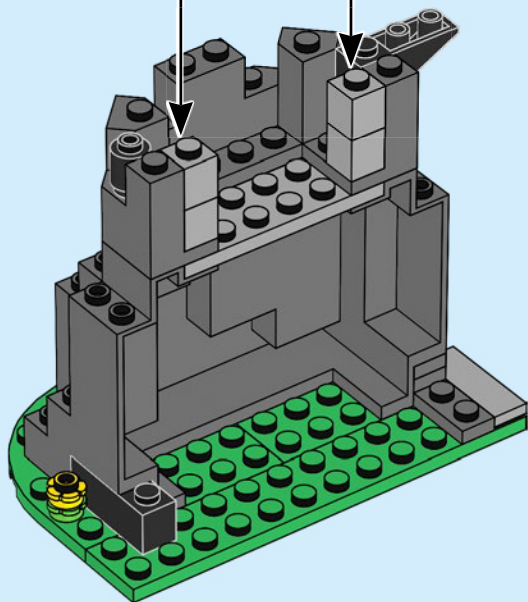



2x



2x

39

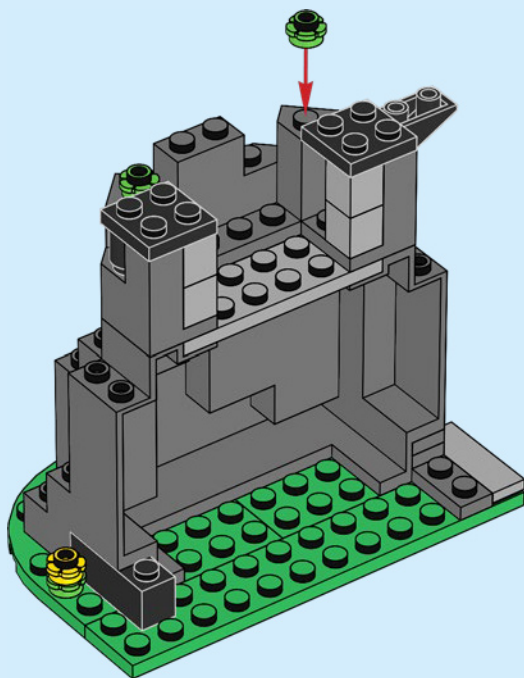

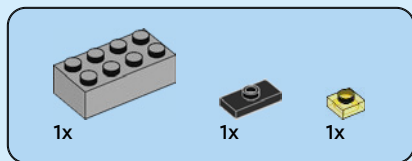

40

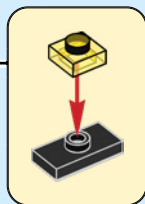
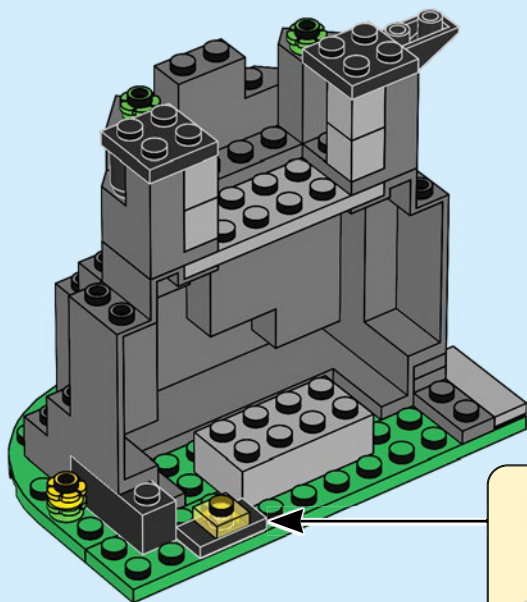



1x



2x

41

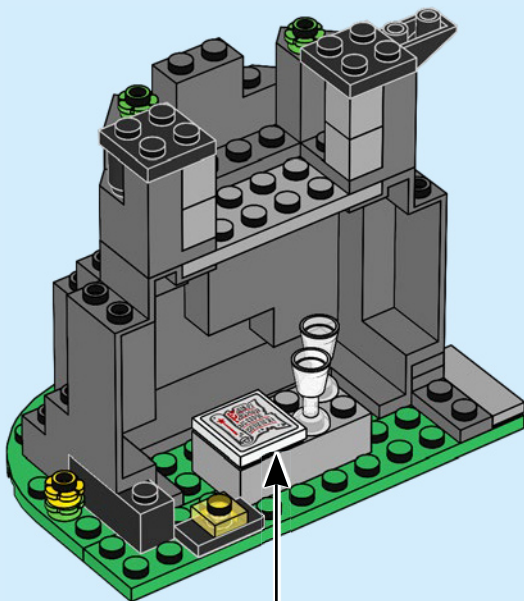

1



2





1x



1x

42

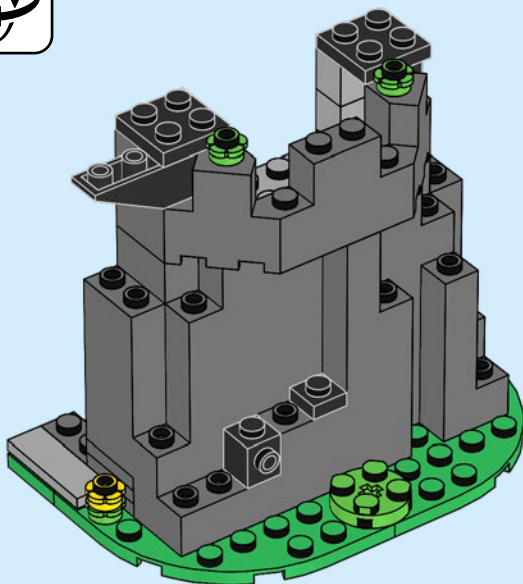



1x



1x

43

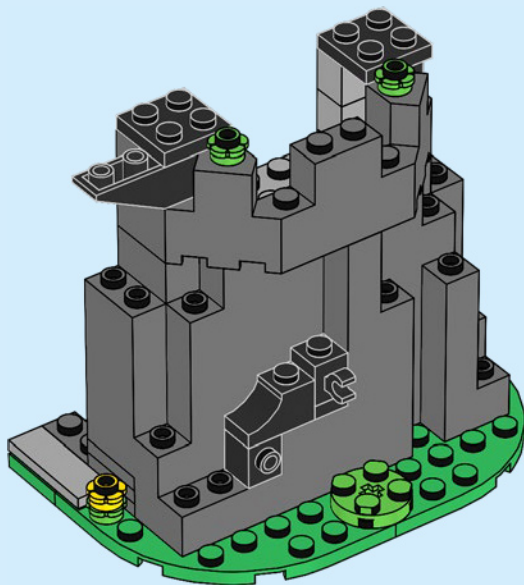



1x

44

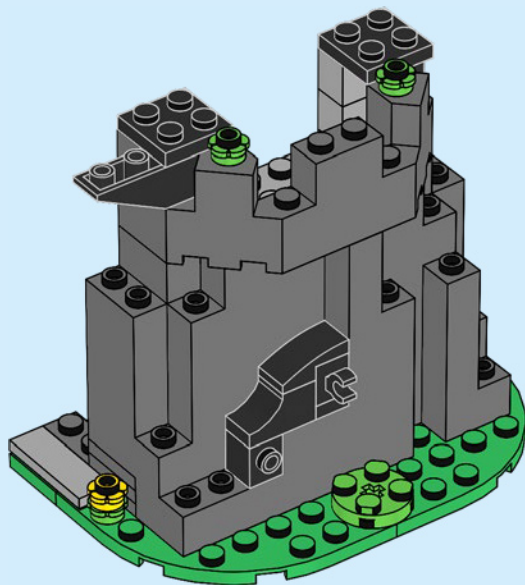



1x



1x

45

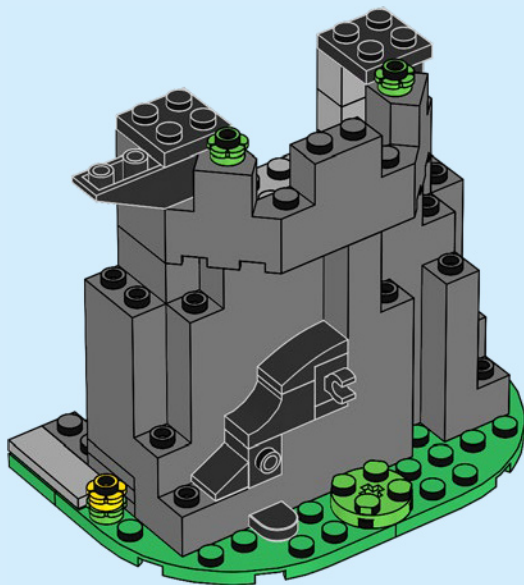



1x



1x

46

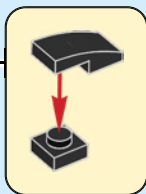
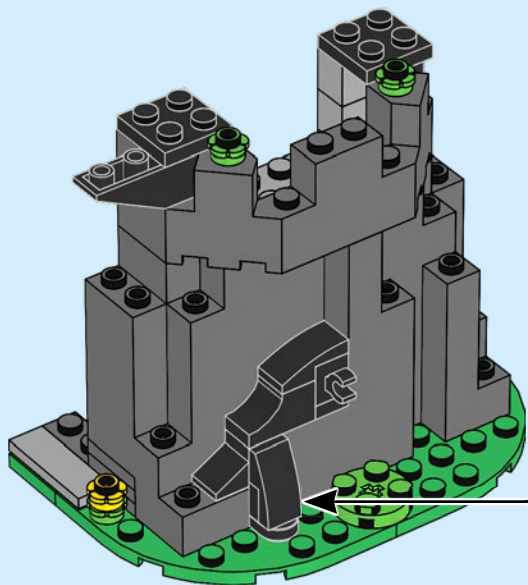



1x



3x

47

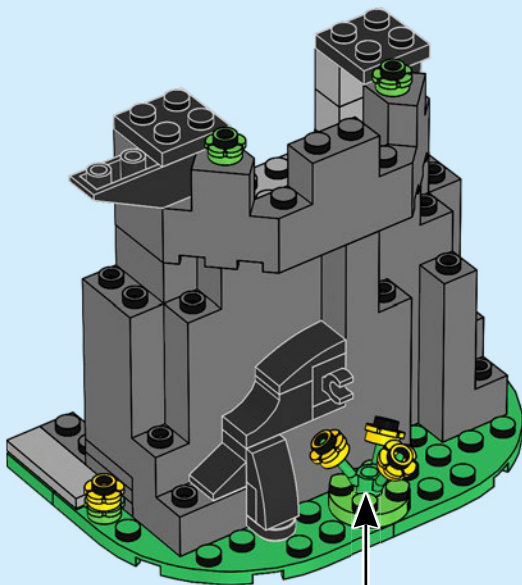

1



2





1x



1x

48

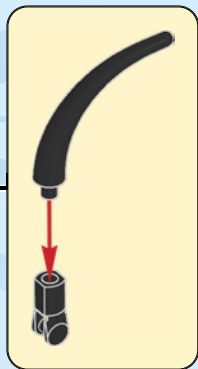
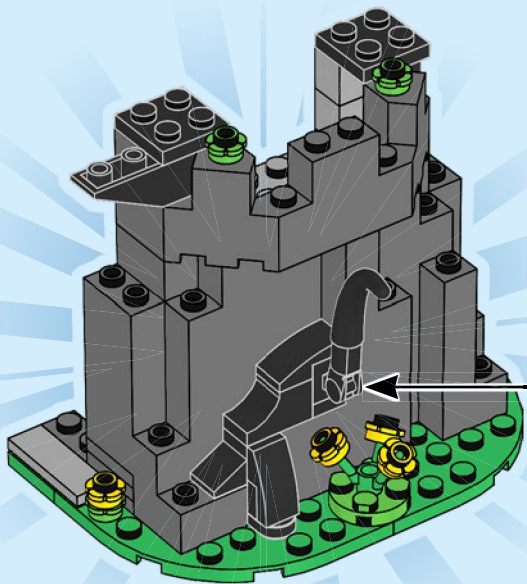

49

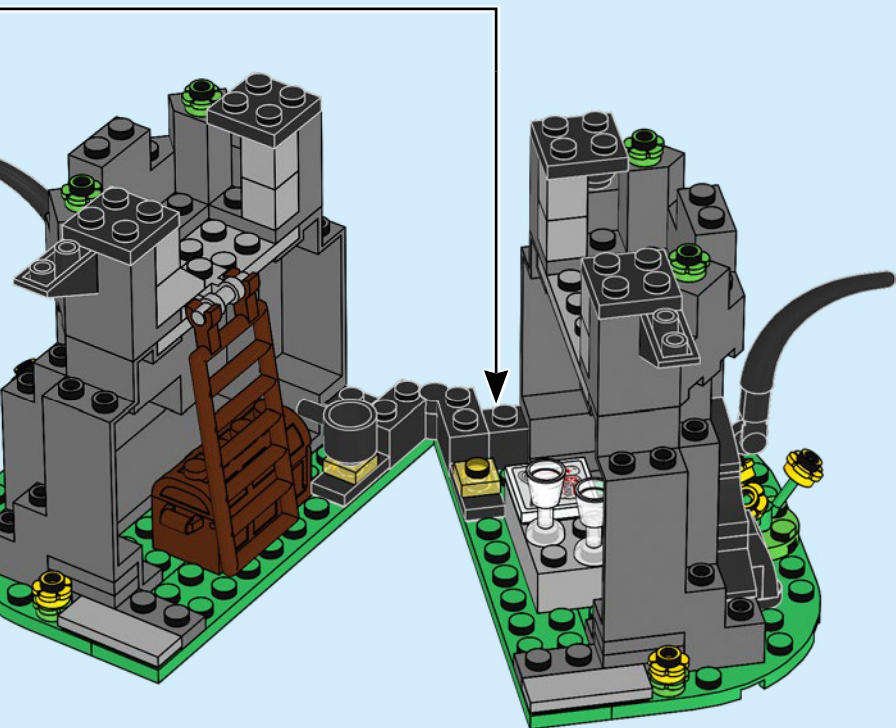

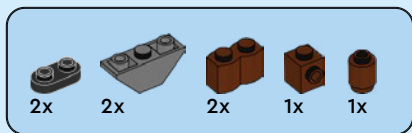

50

1

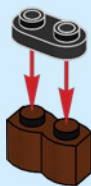

2

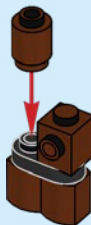

3

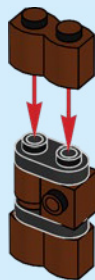

4

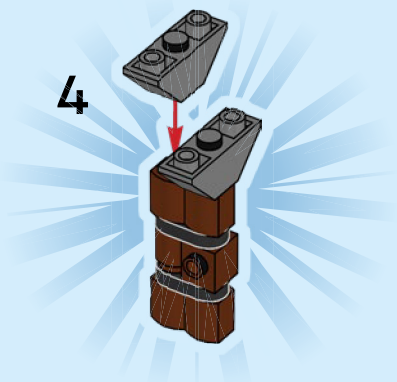

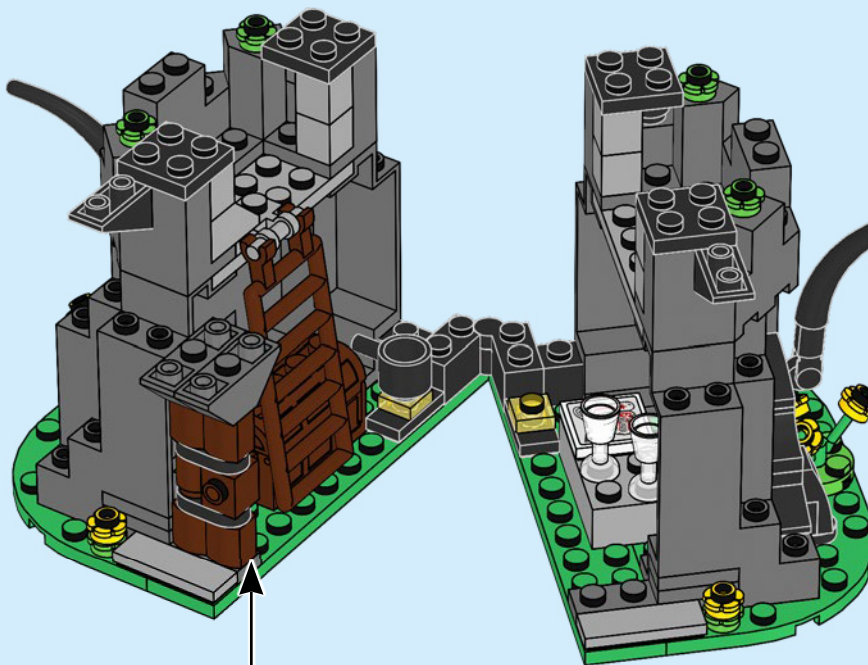

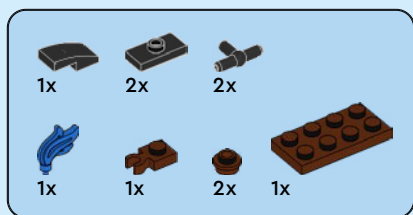

51

1

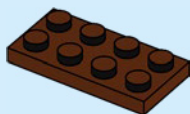

2

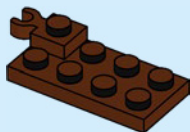

3

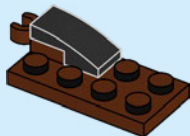

4

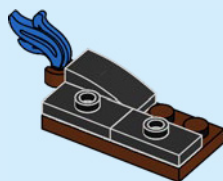

5

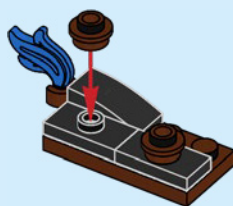

6

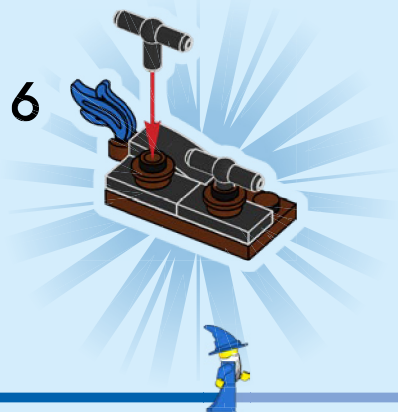

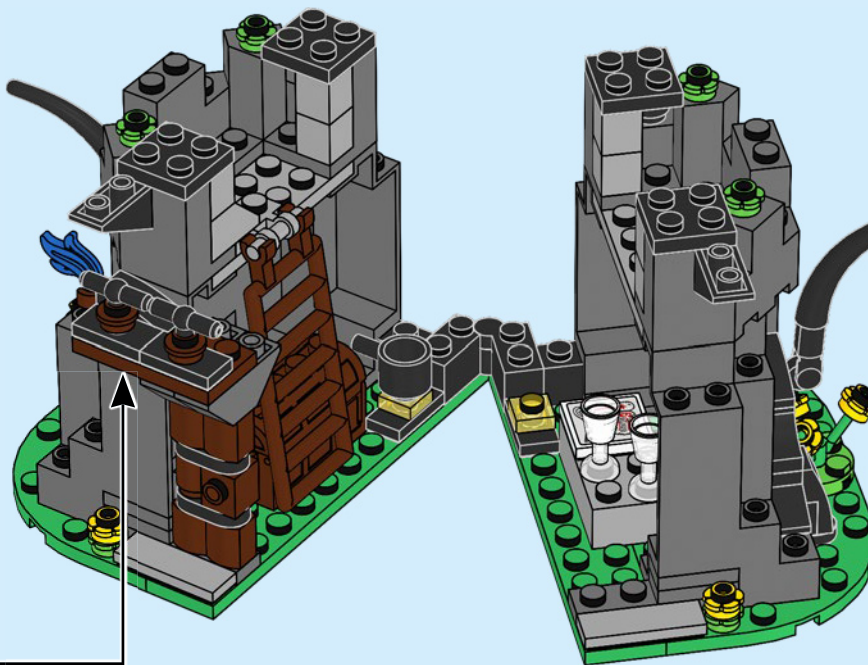

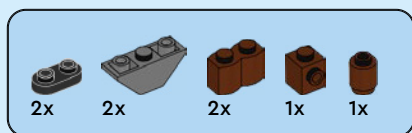

52

1

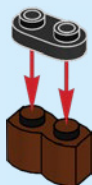

2



3

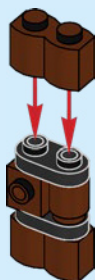

4

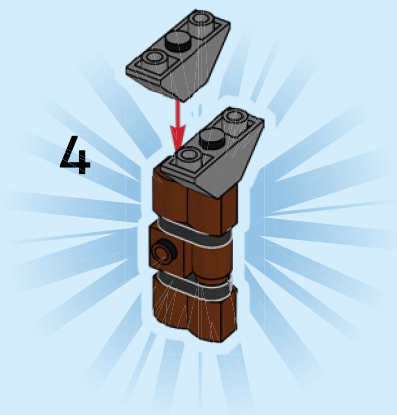

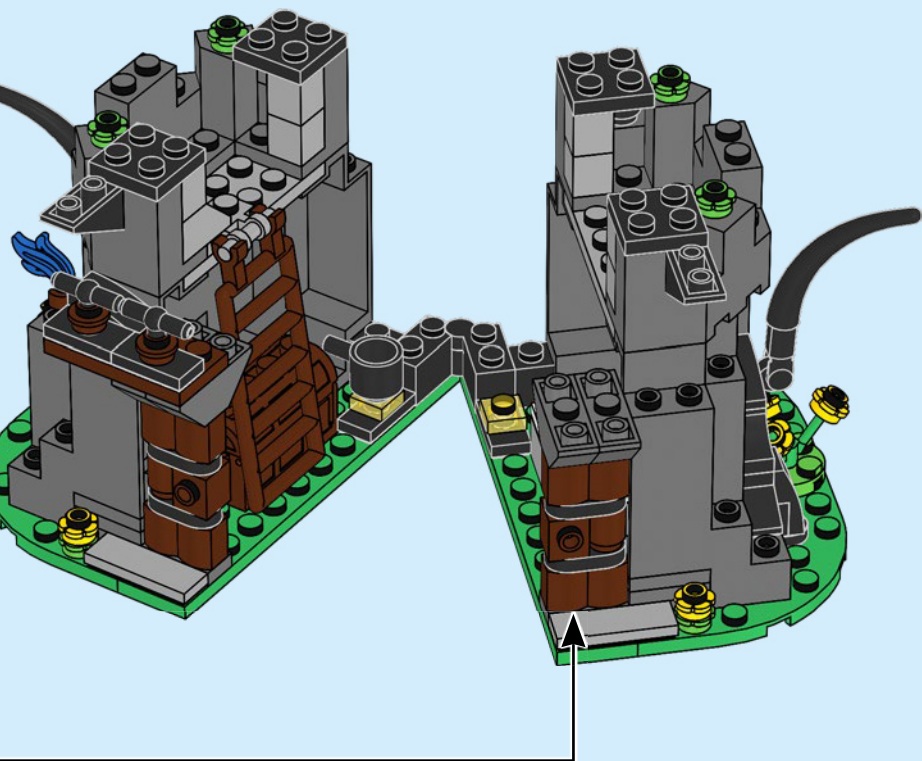

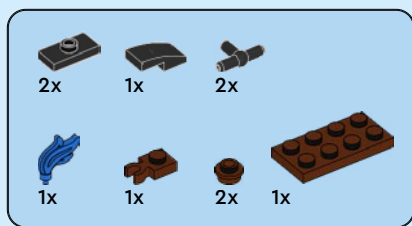

53

1



2

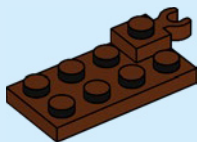

3

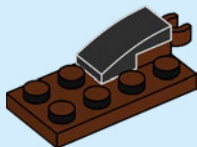

4

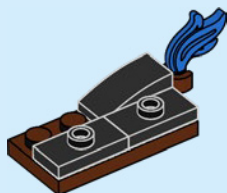

5

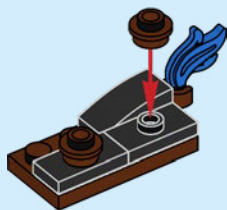

6



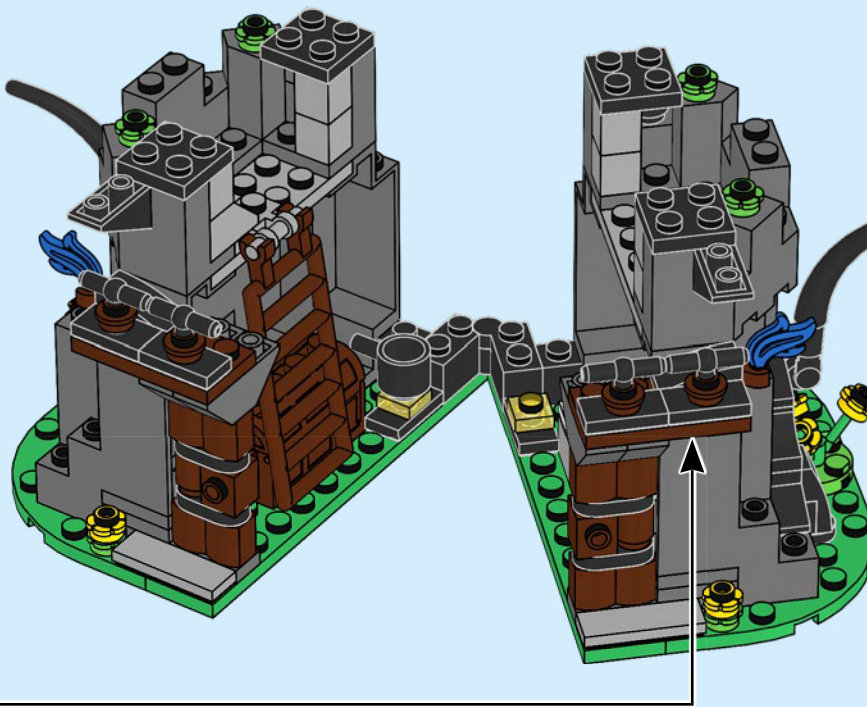



1x



1x



1x



1x

54

1

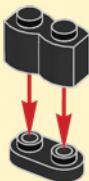

2

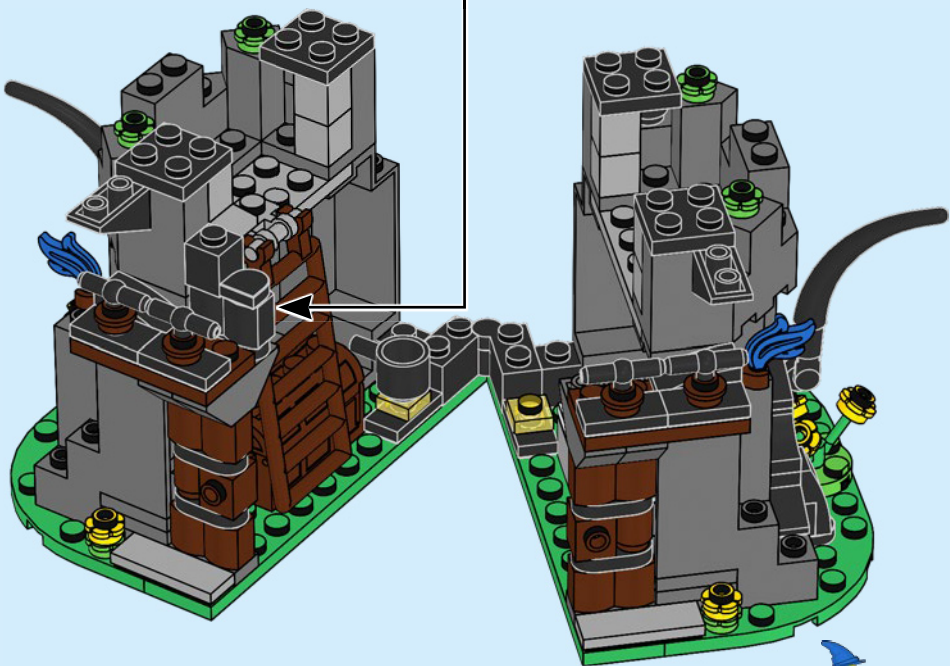



1x



1x



1x



1x

55

1

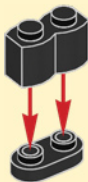

2

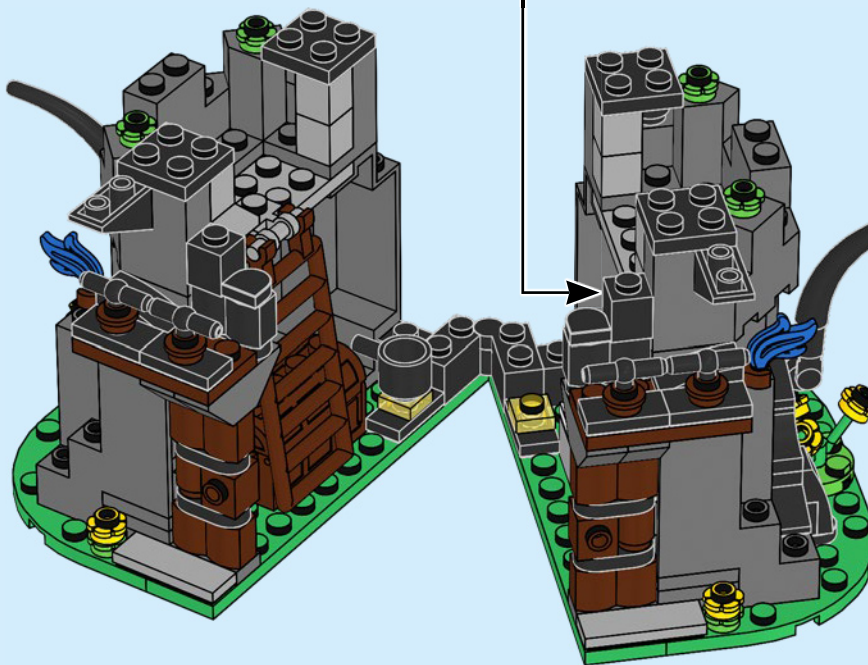



1x



1x

56

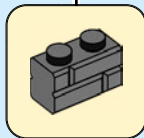
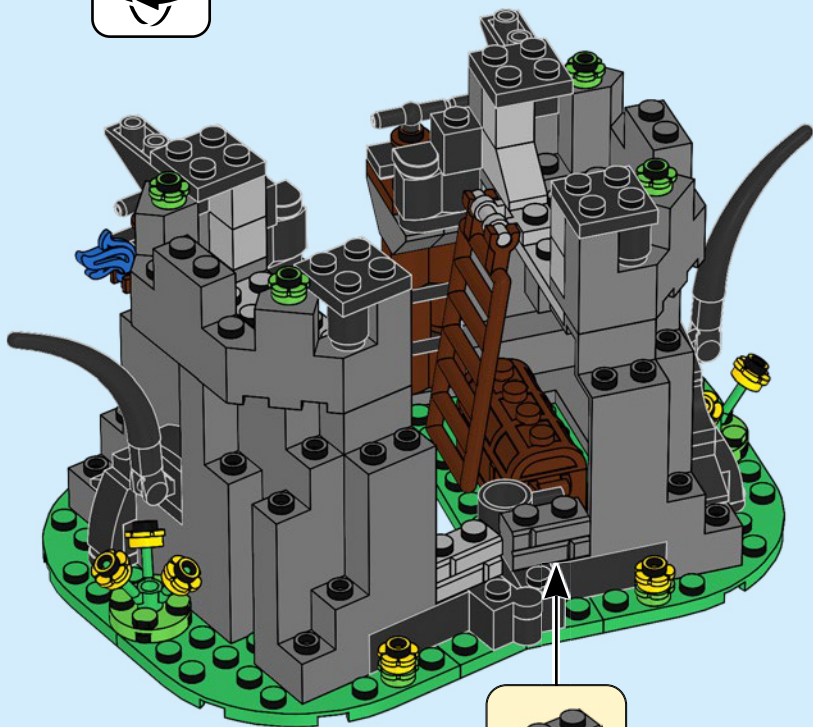



1x



1x

57

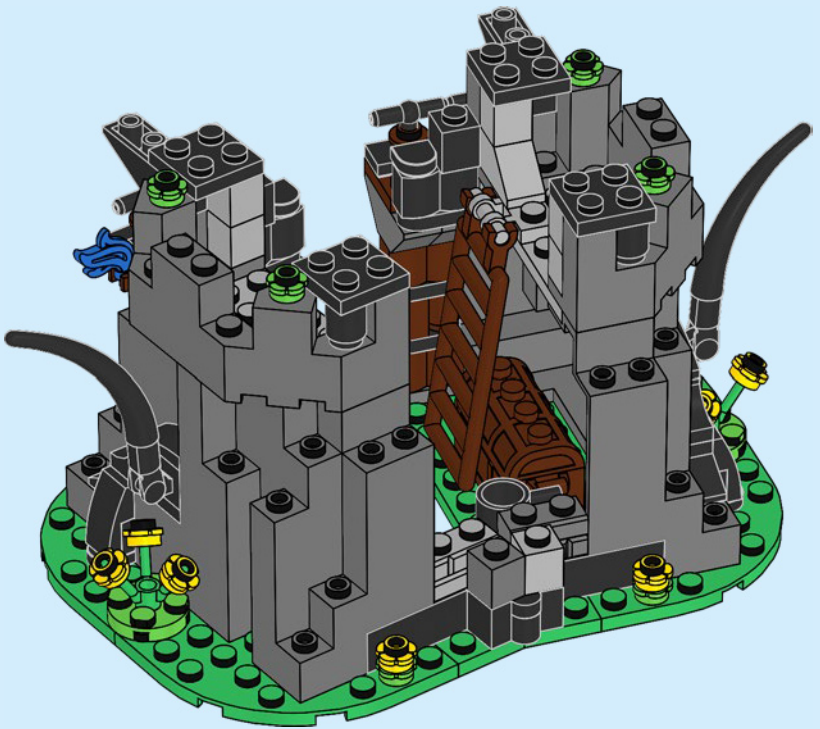



1x

58

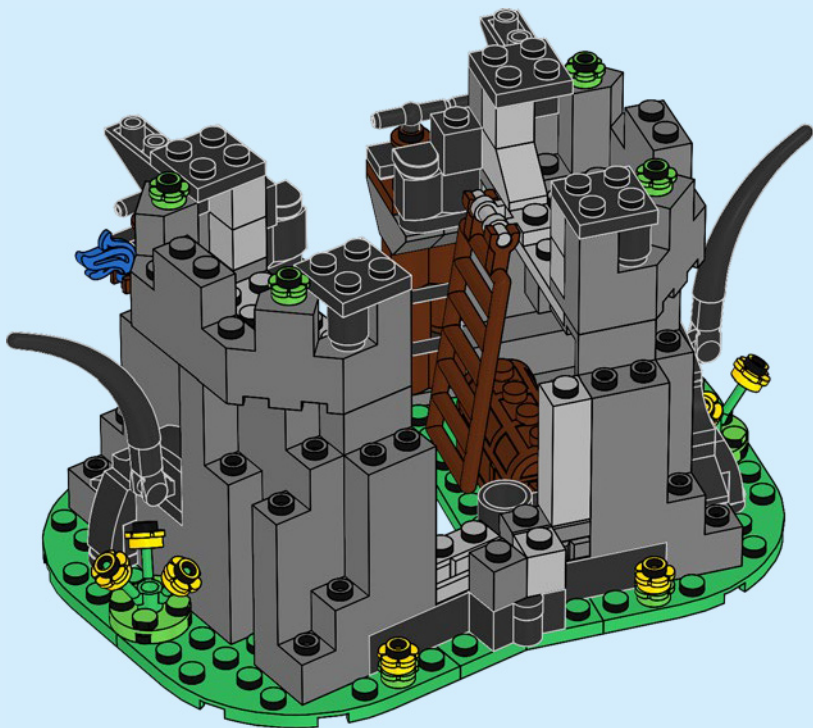

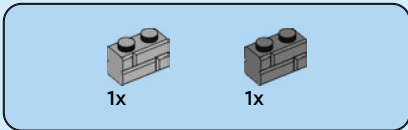

59

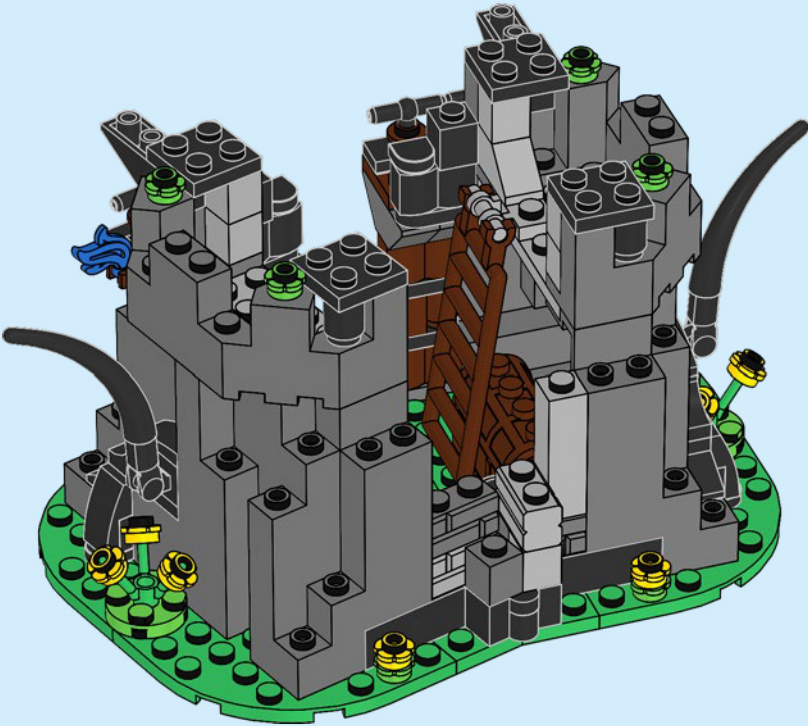



2x

60



2x

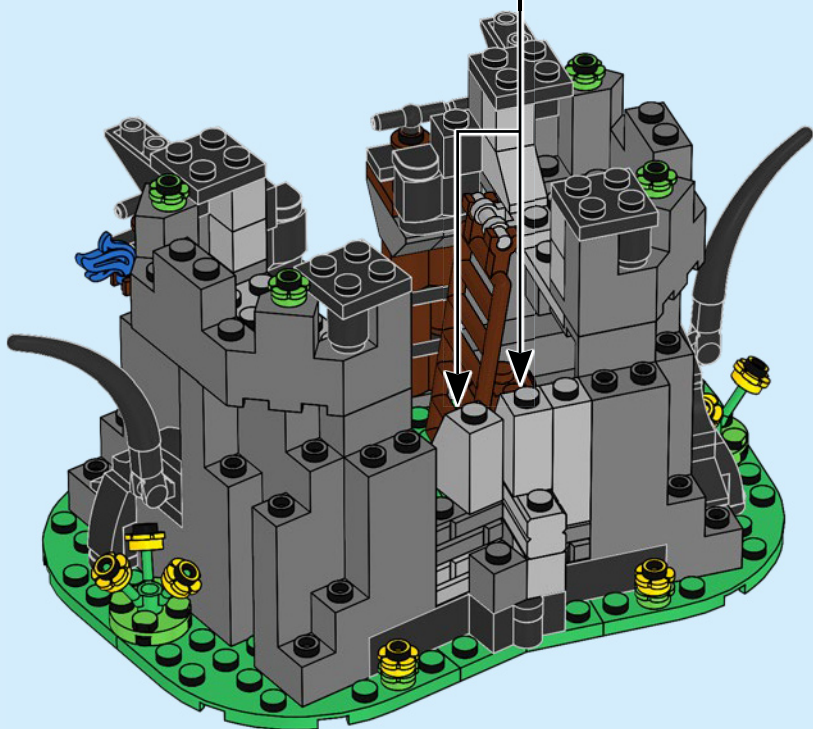



2x

61

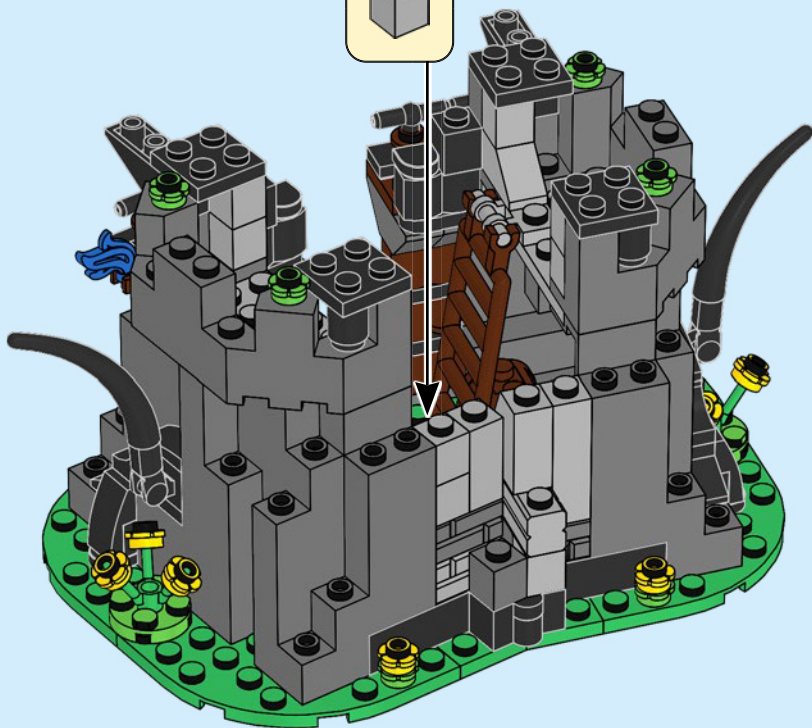
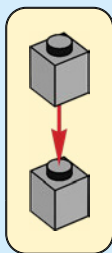

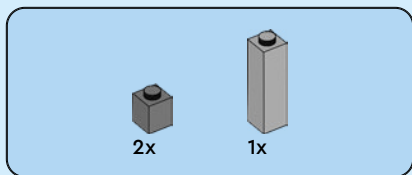

62

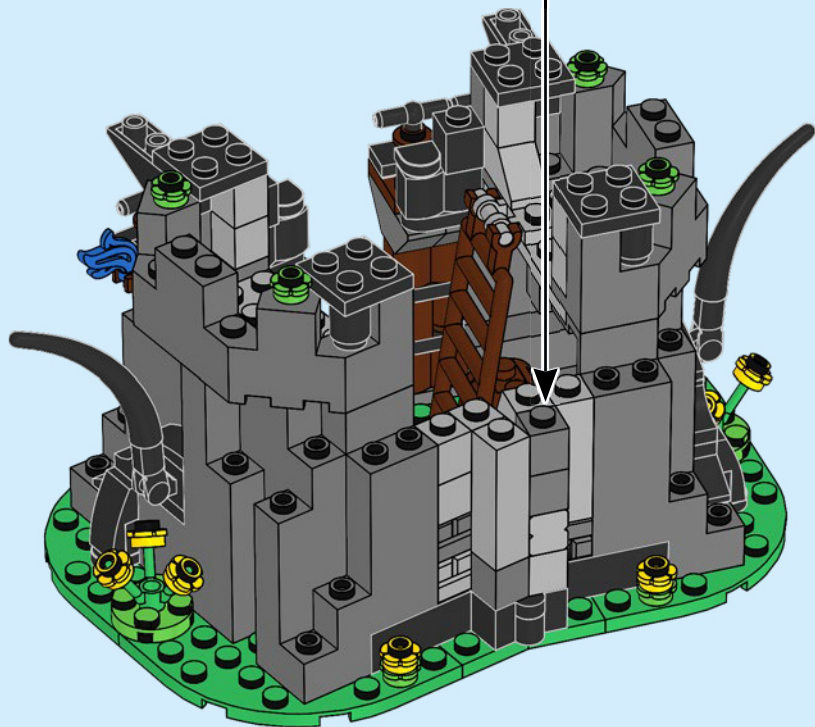
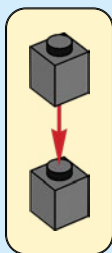



2x

63

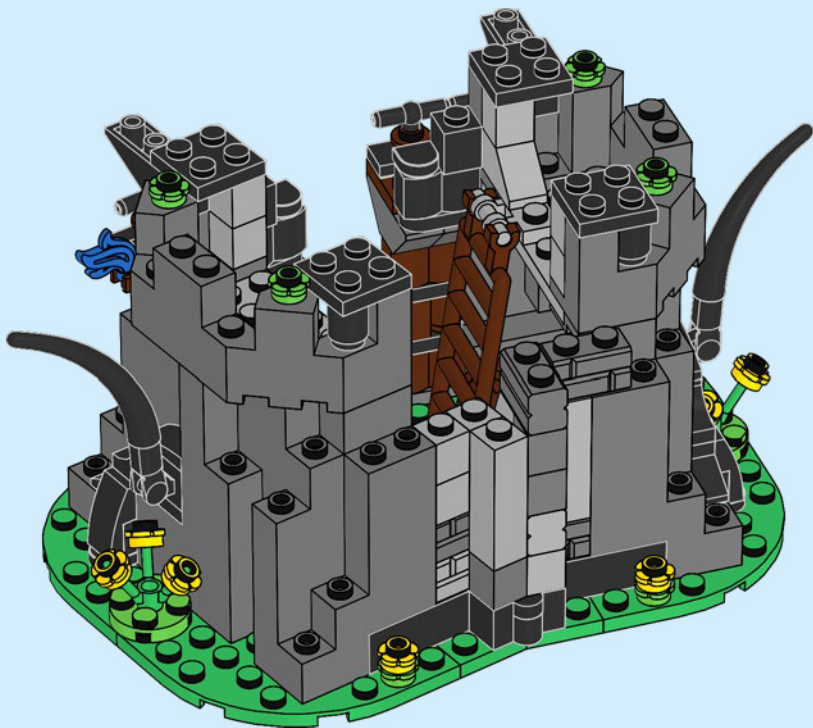



1x



1x

64

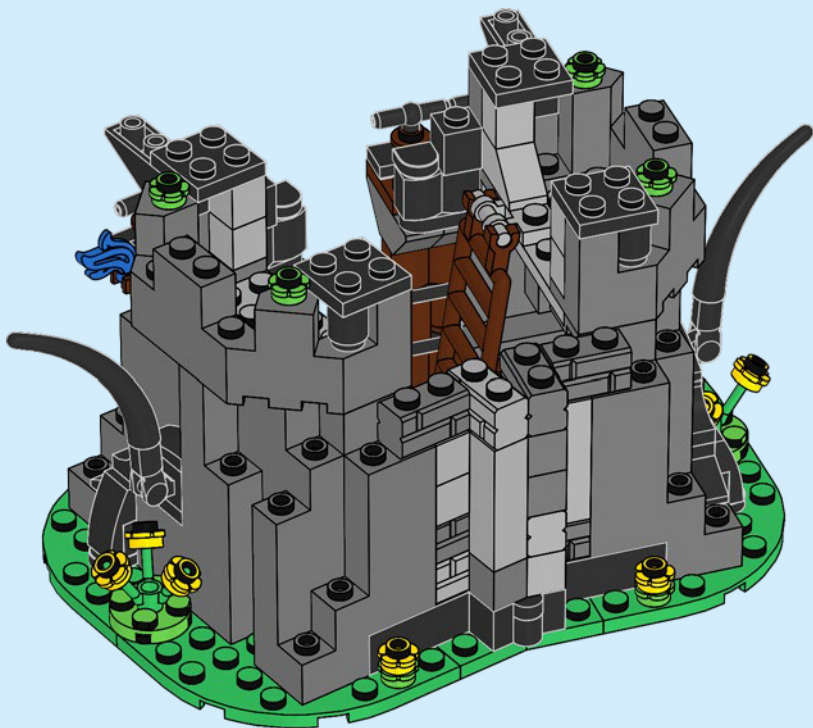

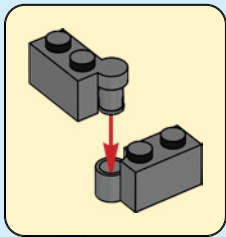
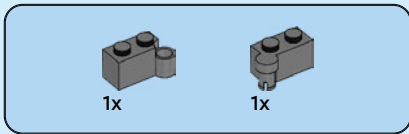

65

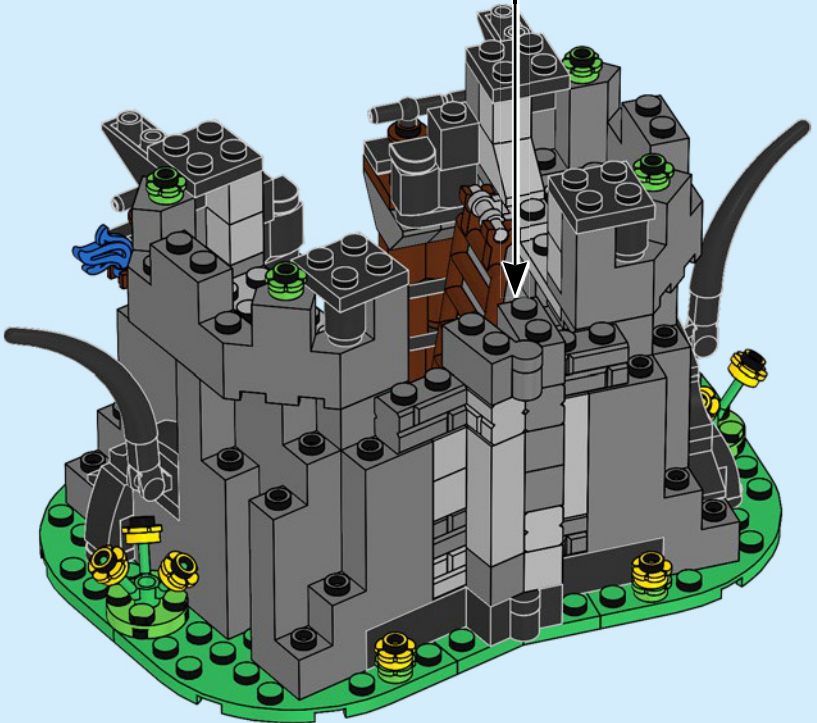



2x

66

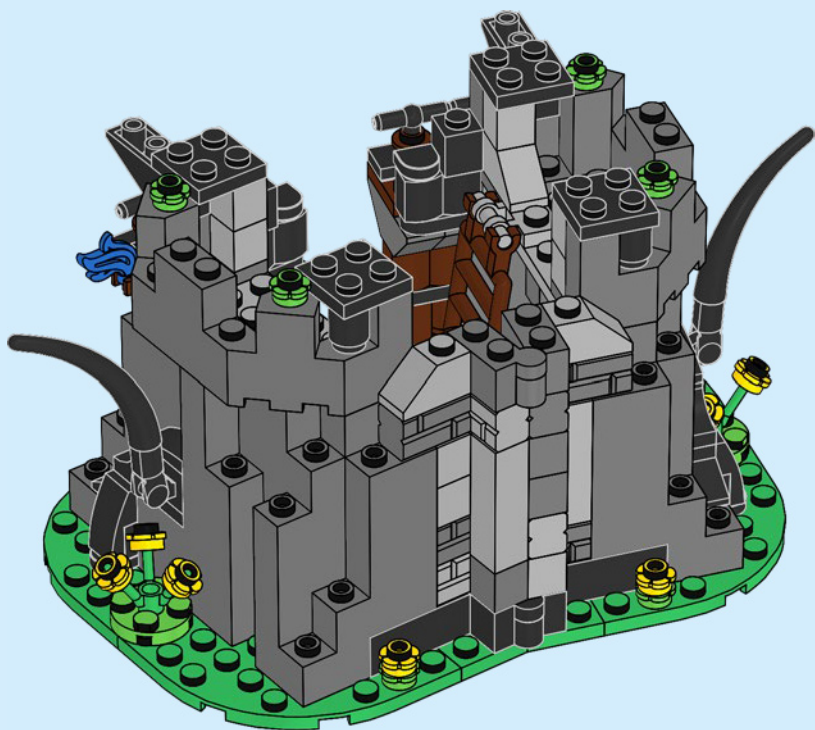



1x



1x

67

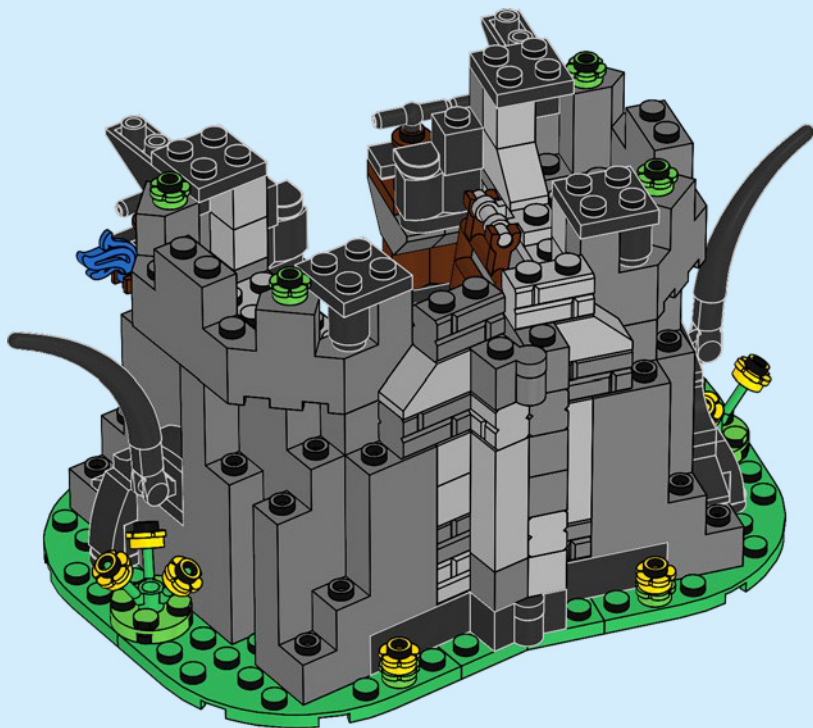



1x



1x

68

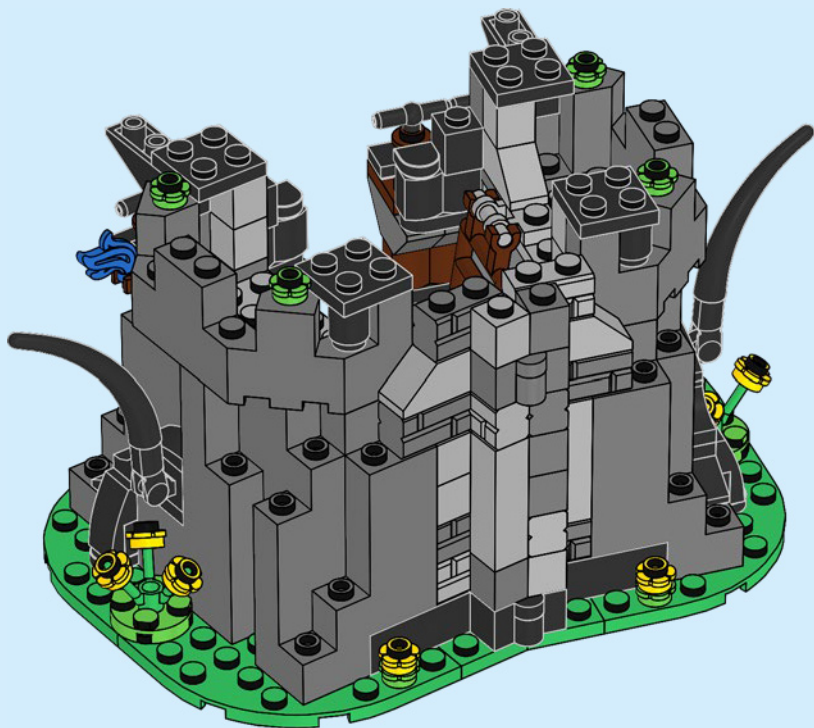



2x

69

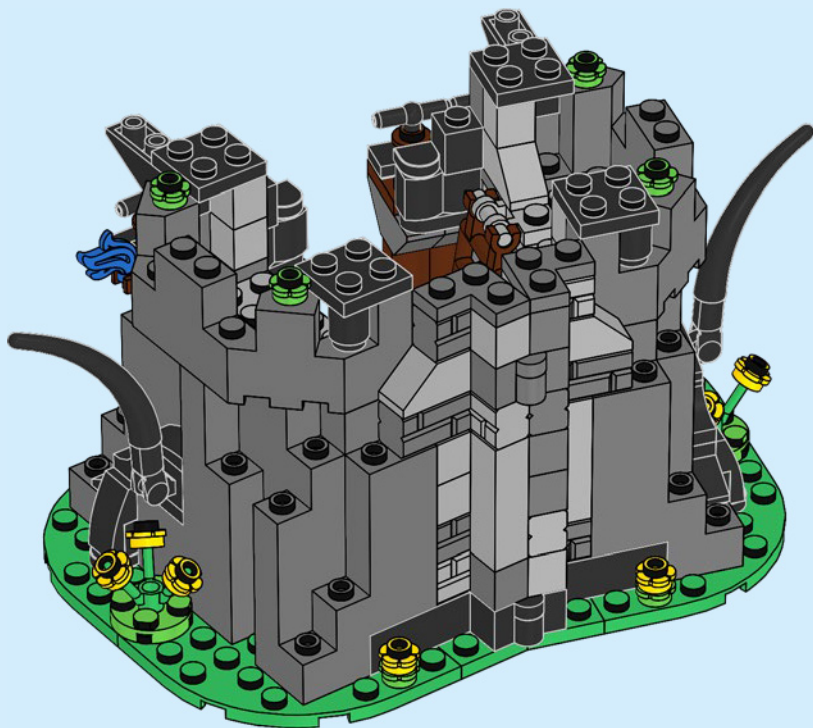

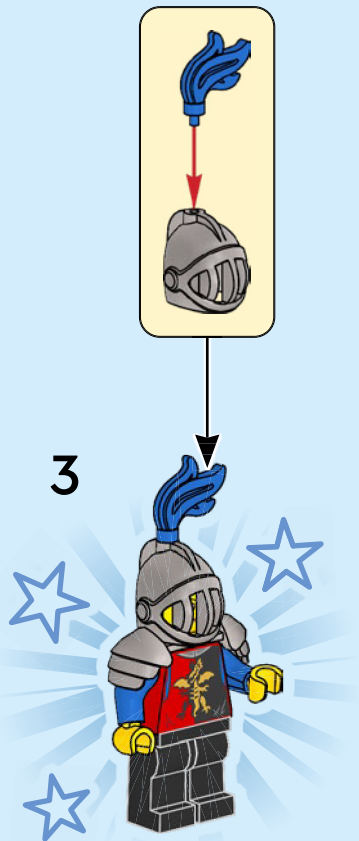
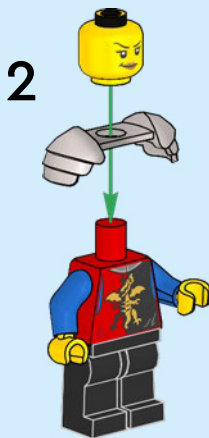
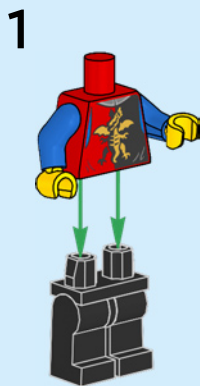

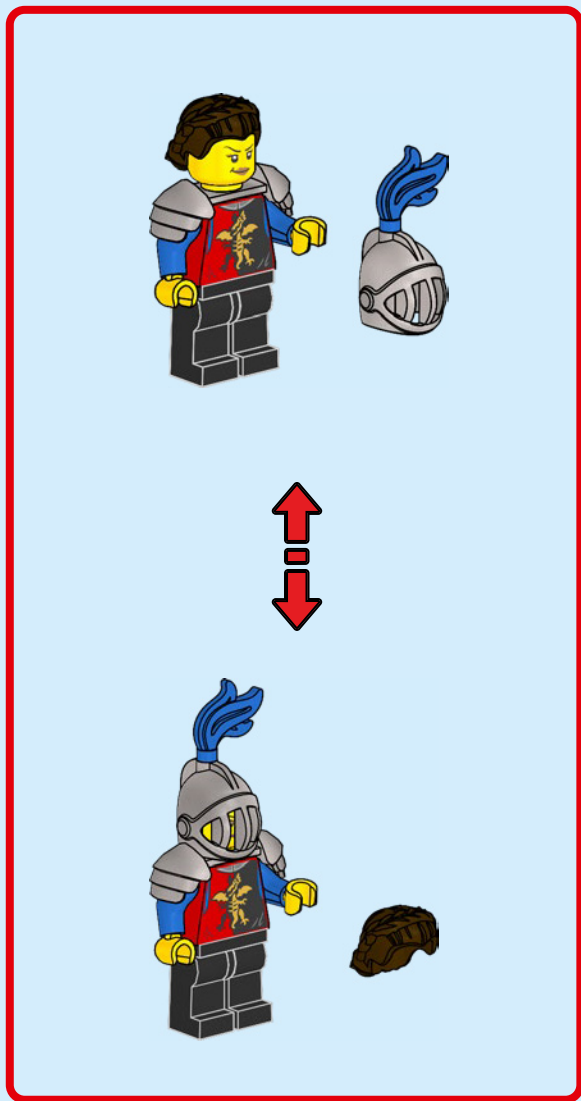



1x



2x

70

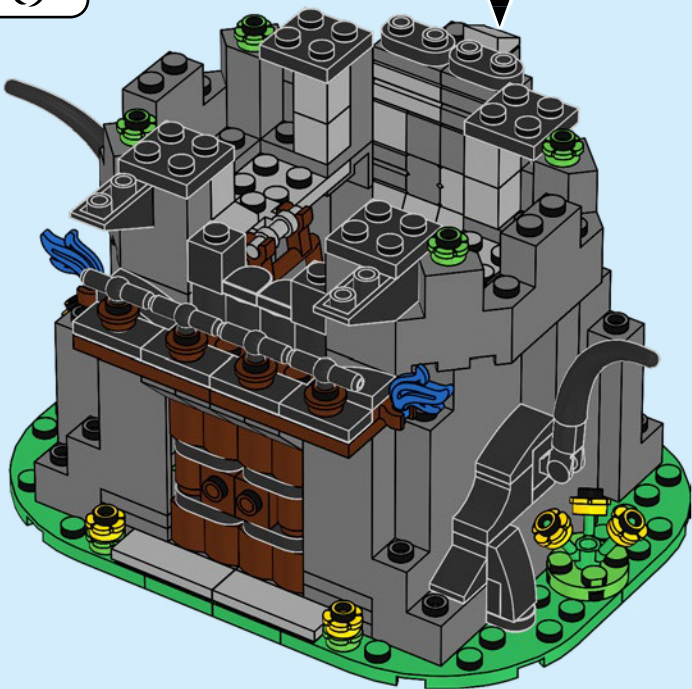
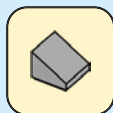

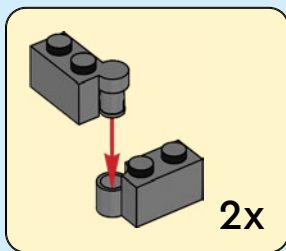
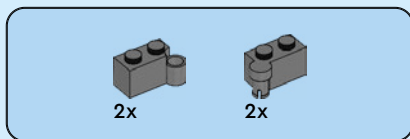

71

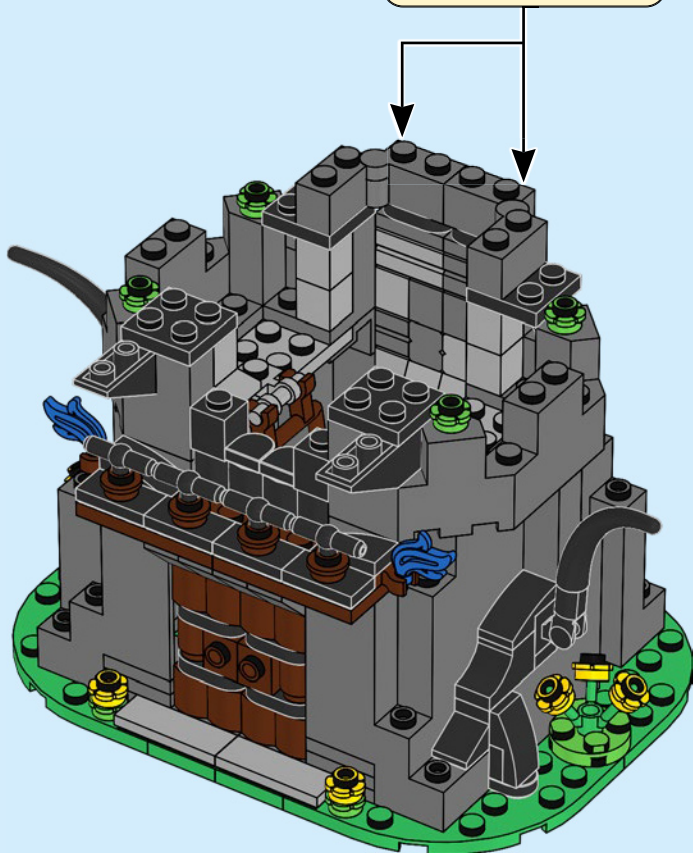



2x



2x



4x



2x



4x



2x

72

1

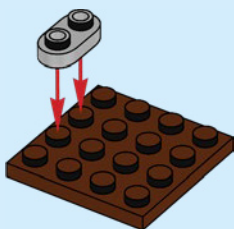

2

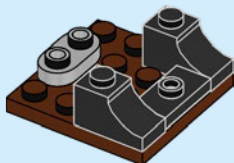

3

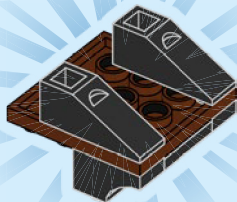

2x

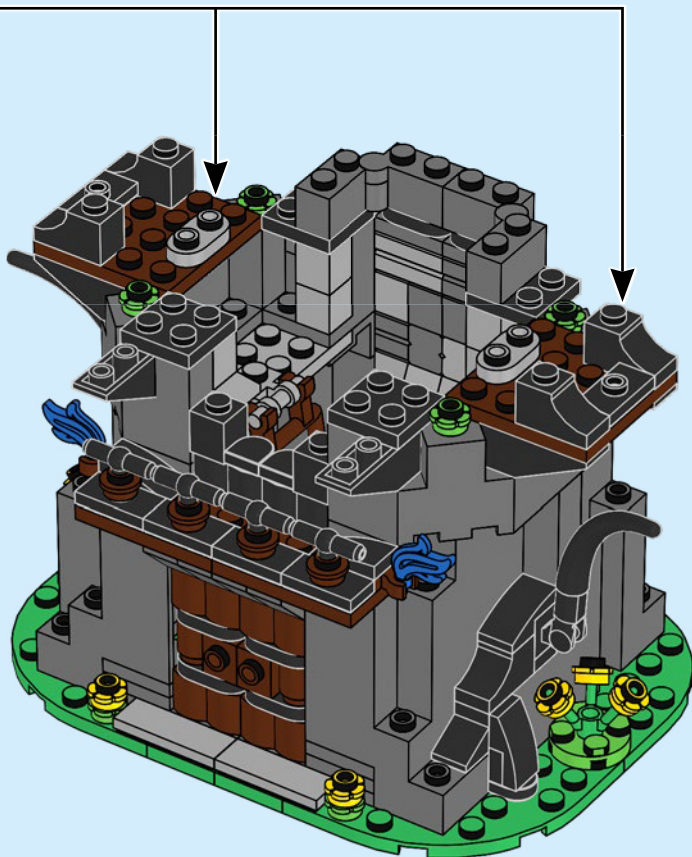



4x

73

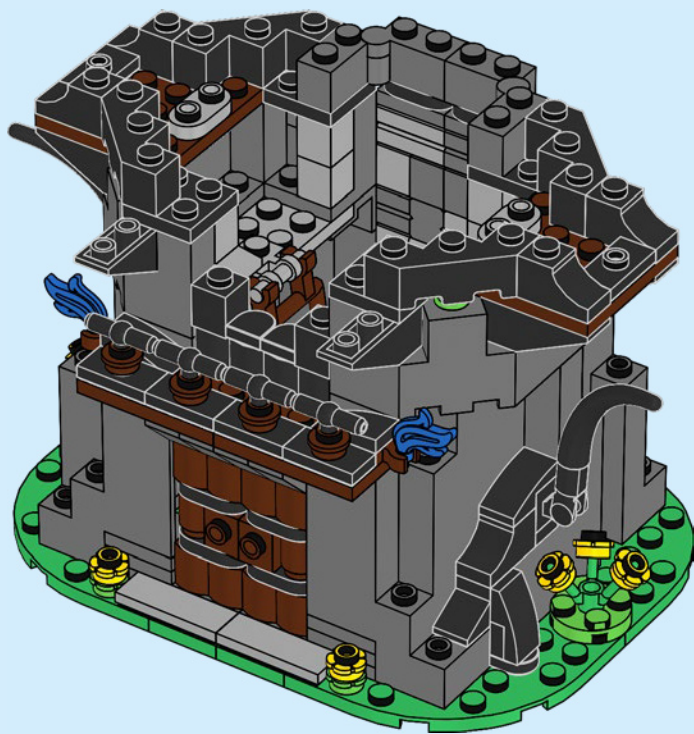



74

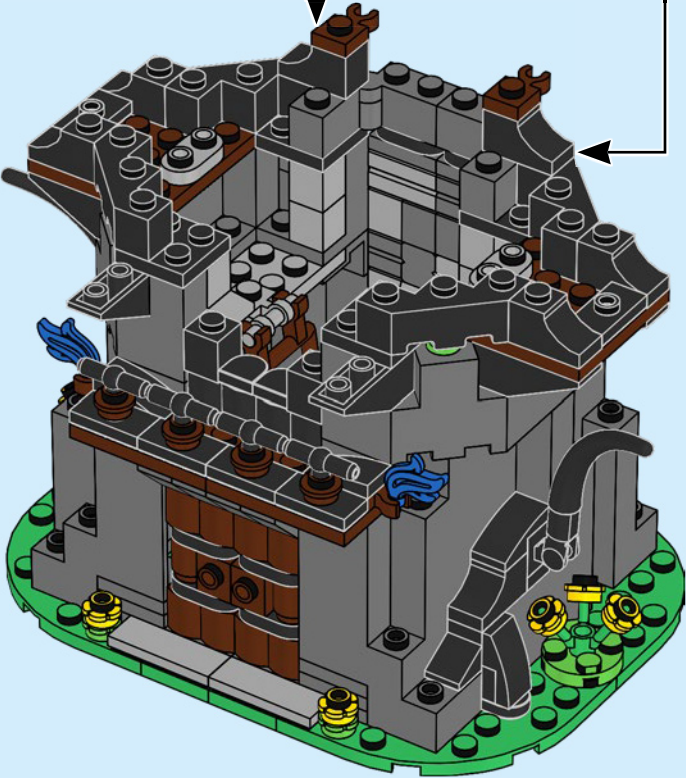
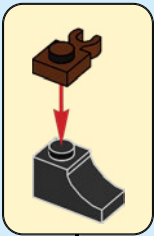
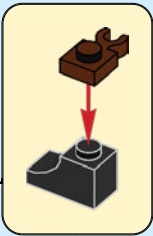



2x

75

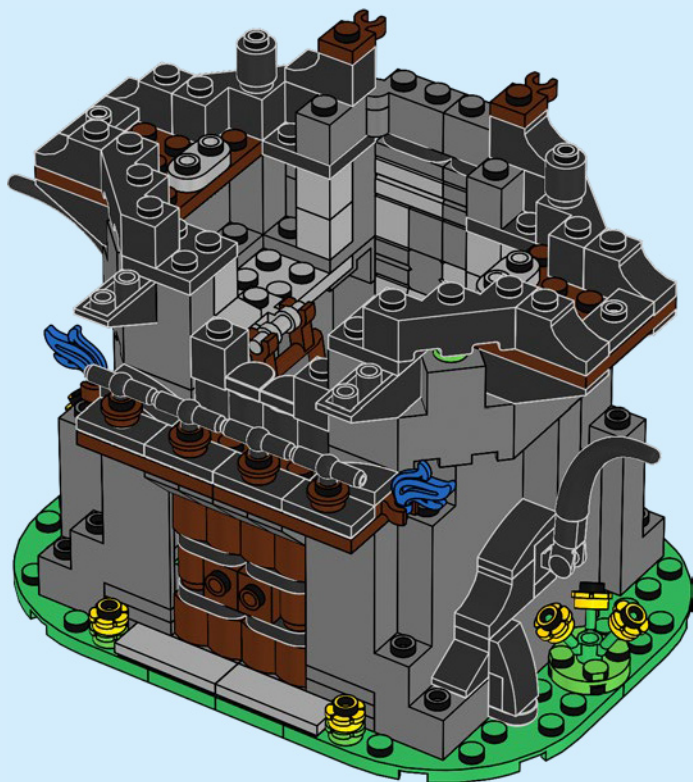

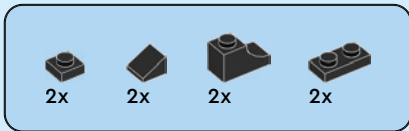

76

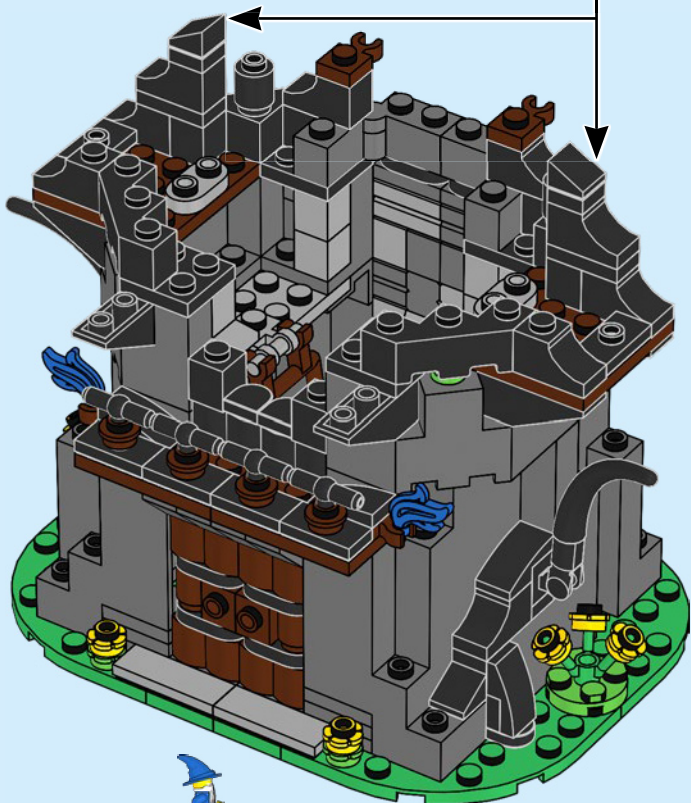
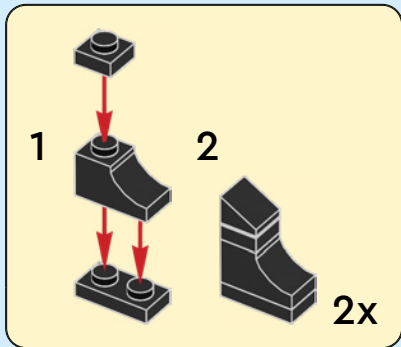



2x



2x



2x



2x



2x

77

1

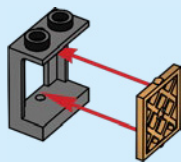

2



3

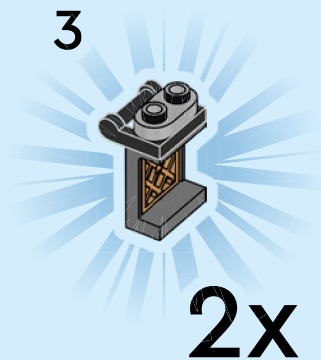

2x

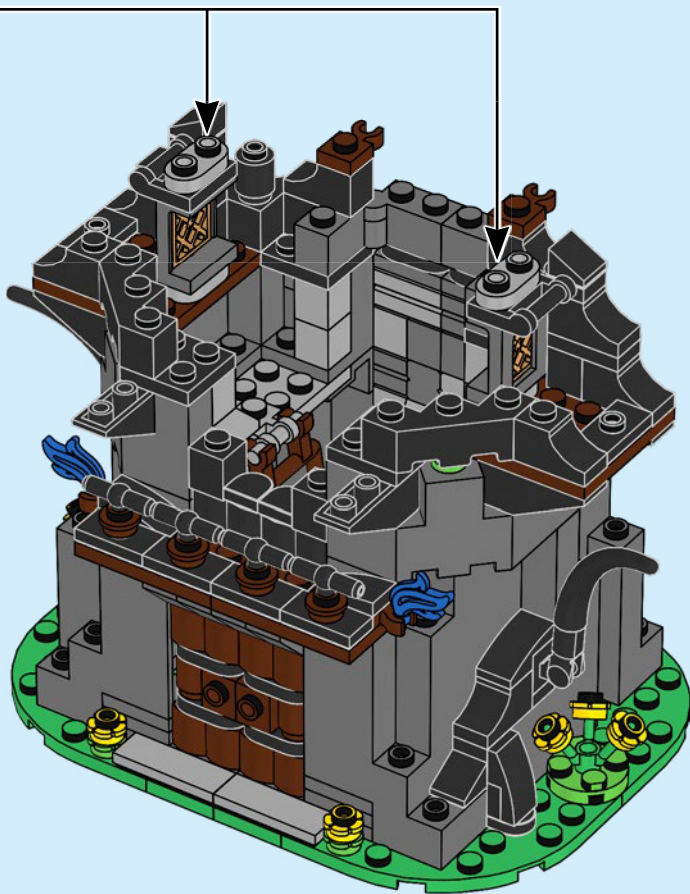

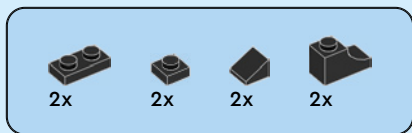

78

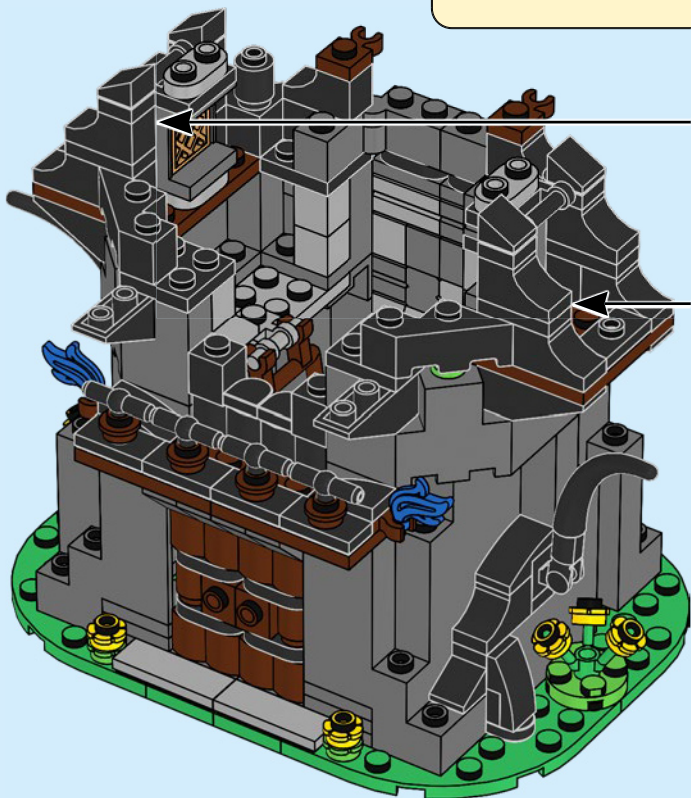
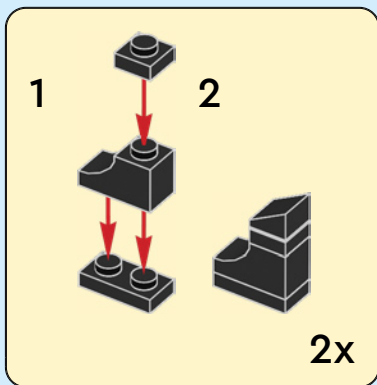

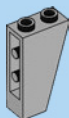

4x

79

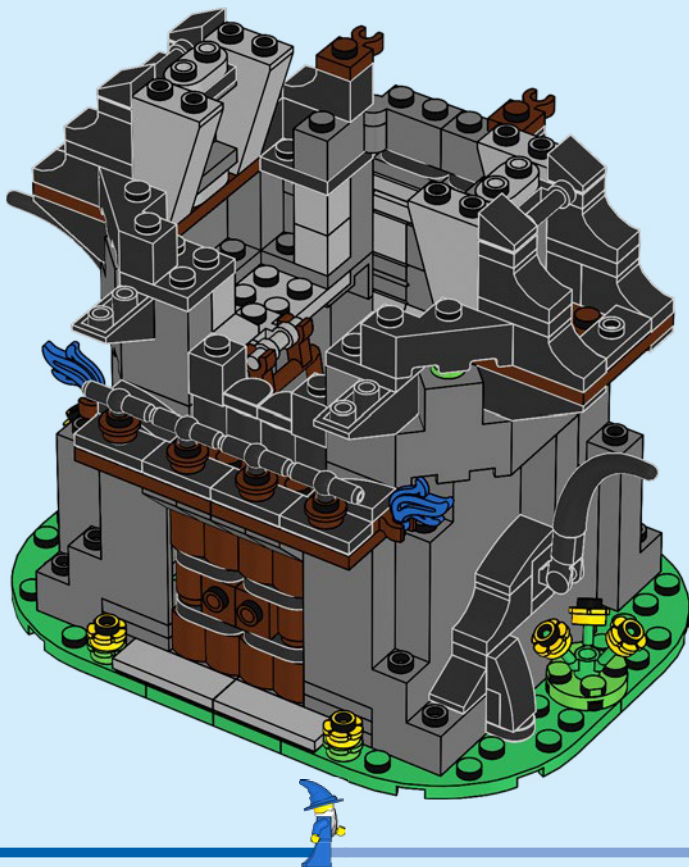



2x

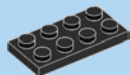

2x



2x



4x



8x

80

1

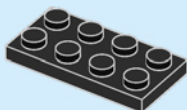

2

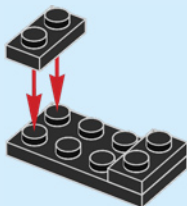

3

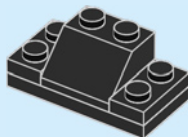

4

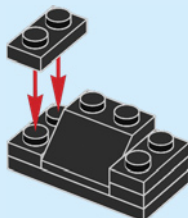

5

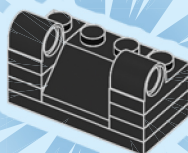

2x

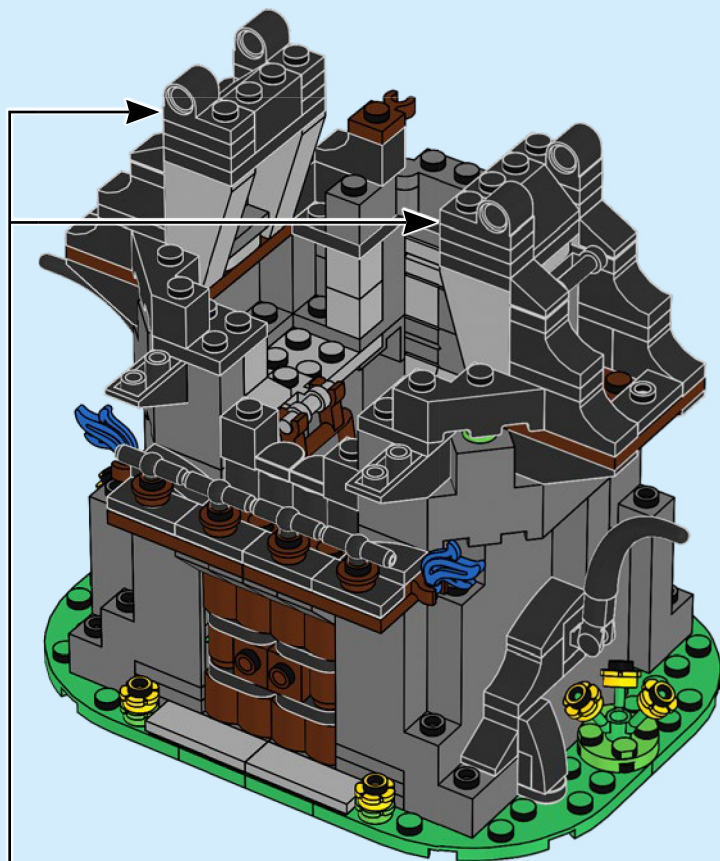



2x



2x

81

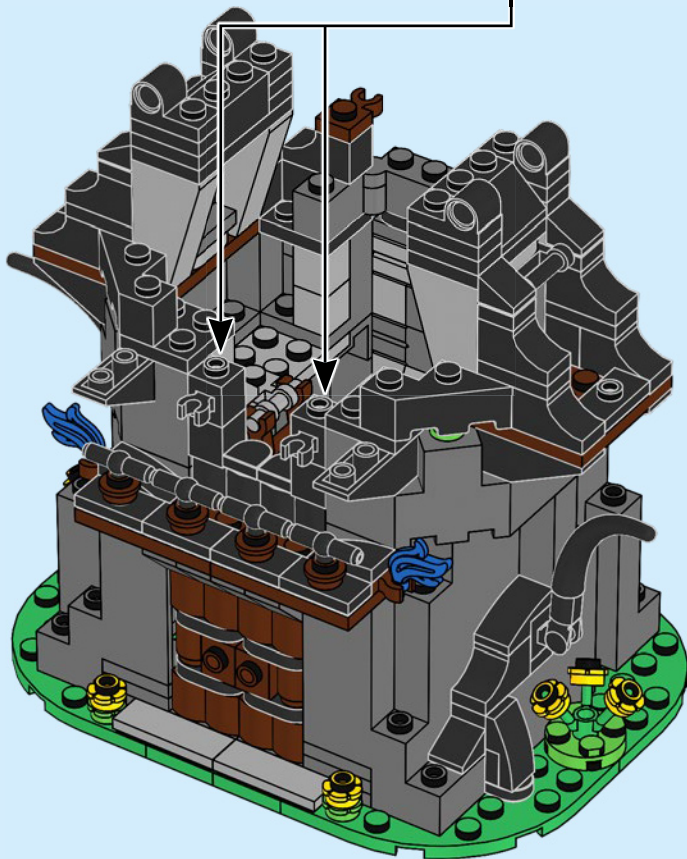

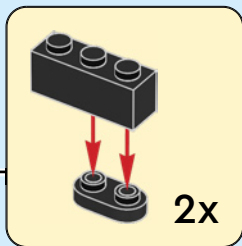
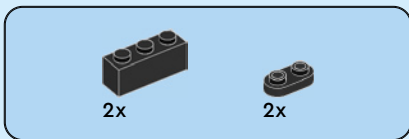

82

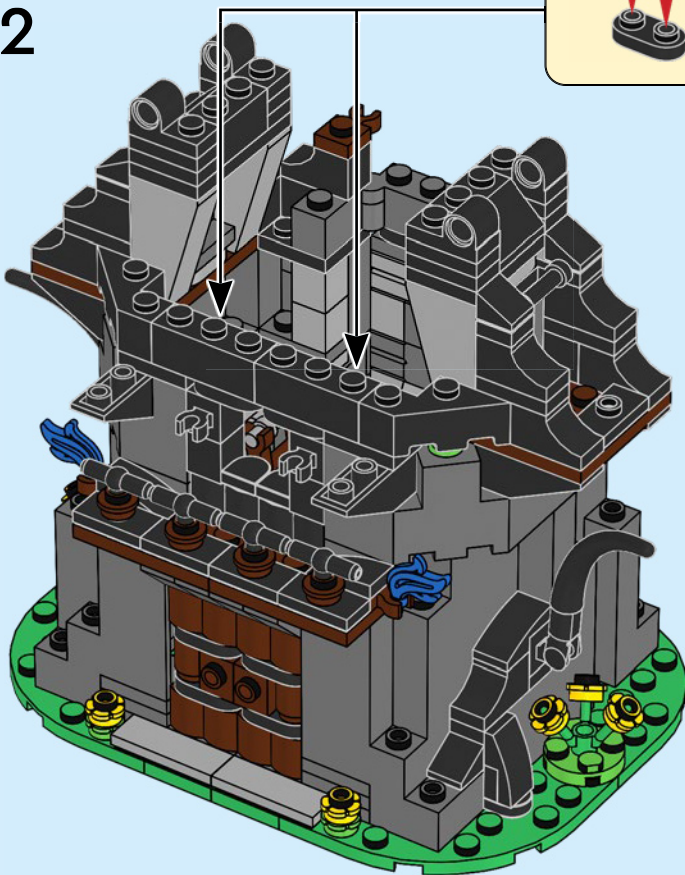



4x

83

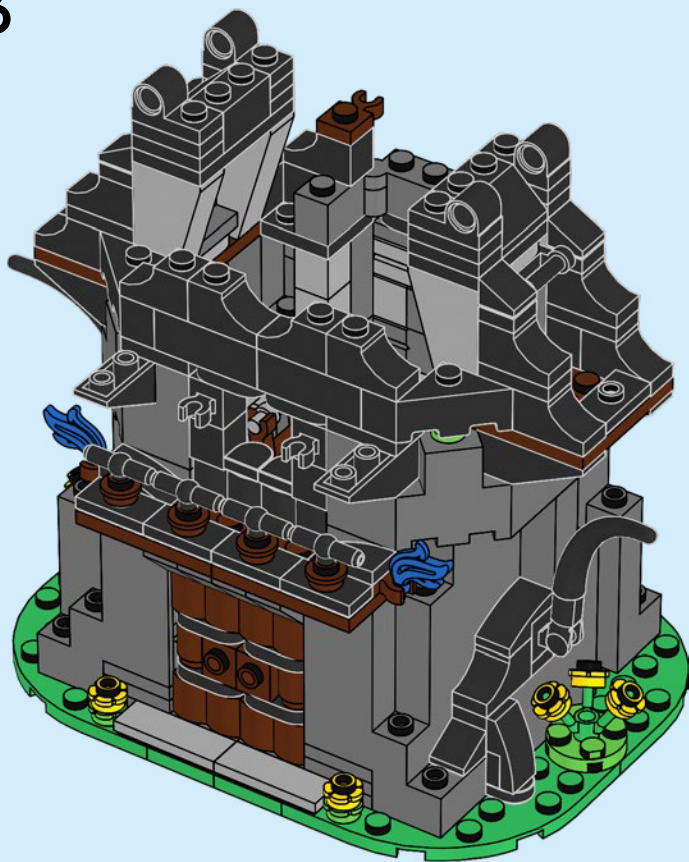



2x

84

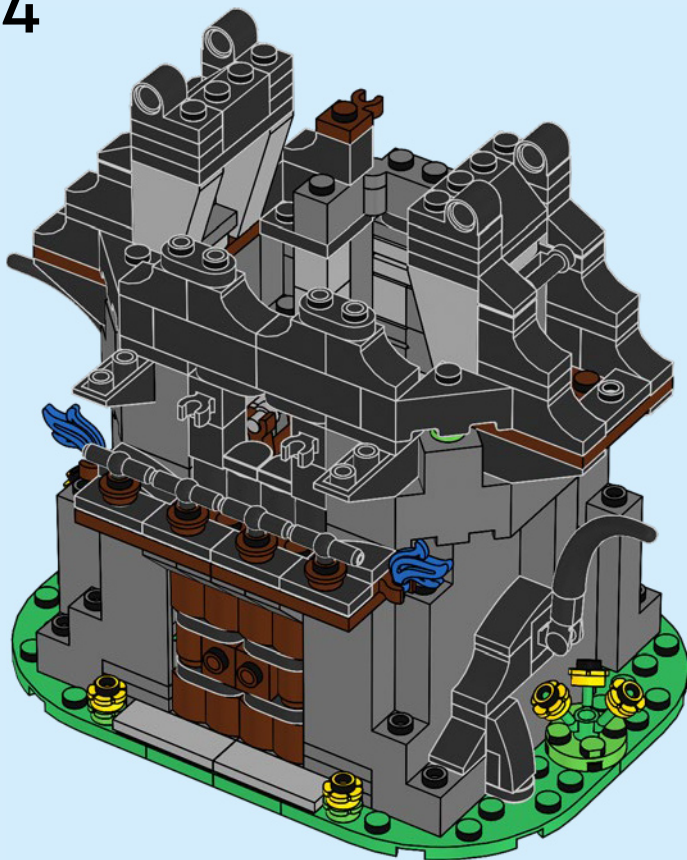



2x



2x

85

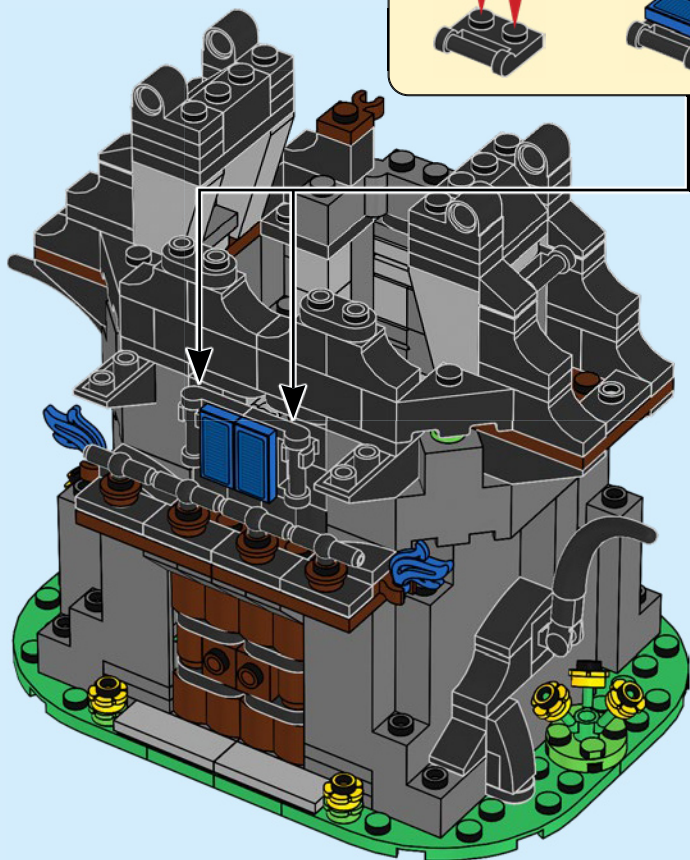
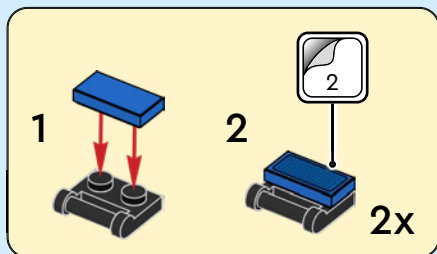

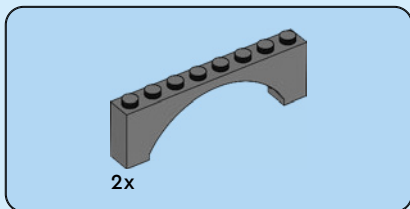

86

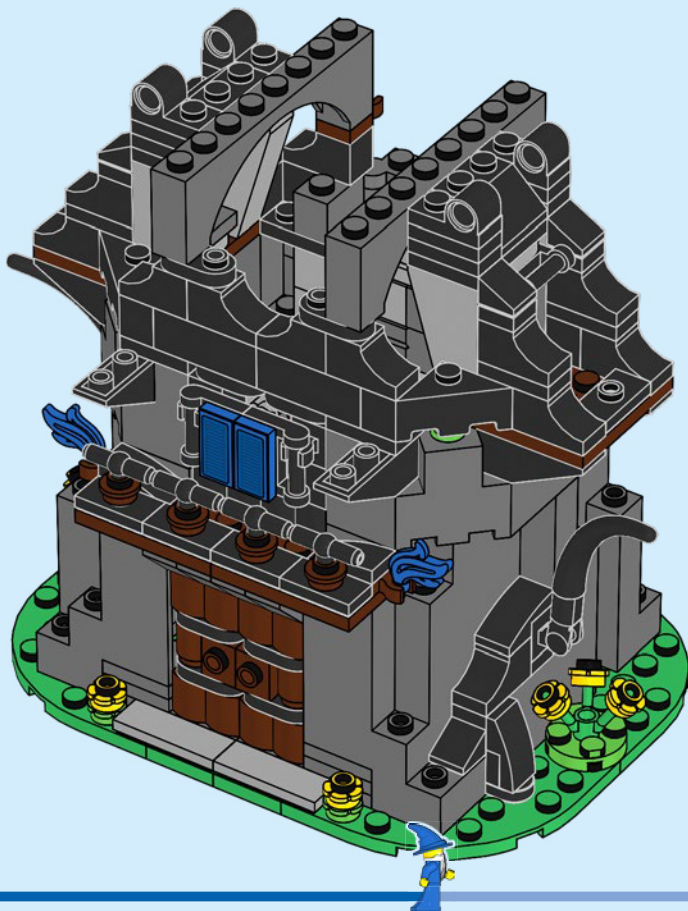

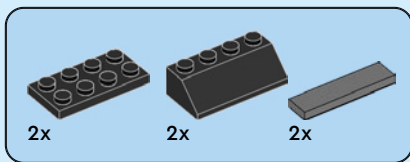

87

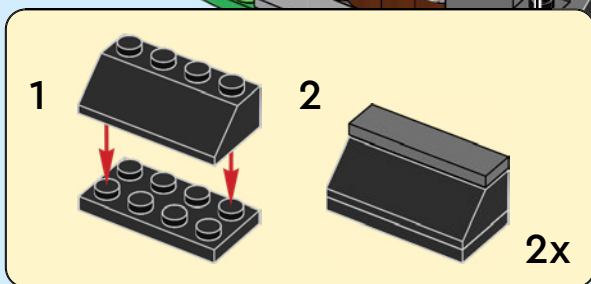
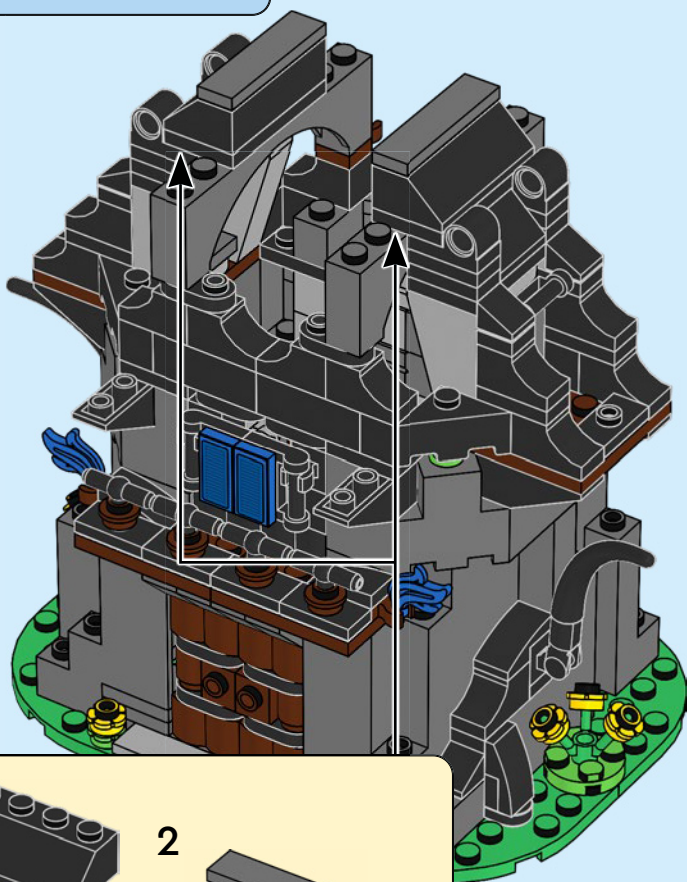

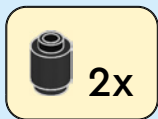
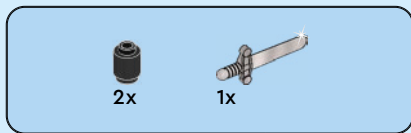

88

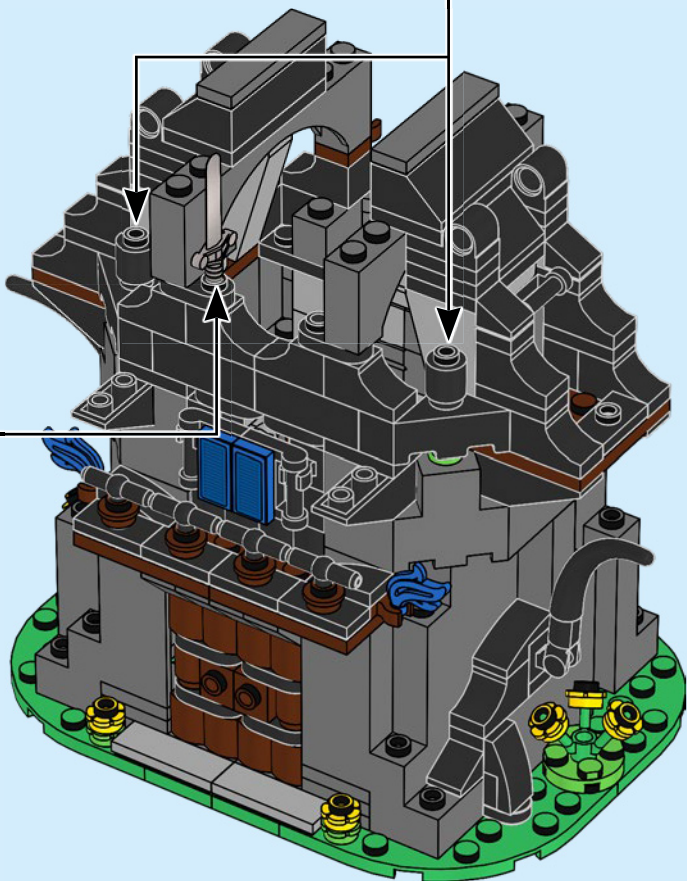
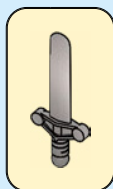



2x

90

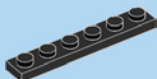
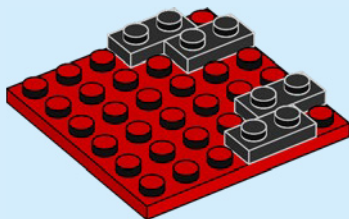

2x

91

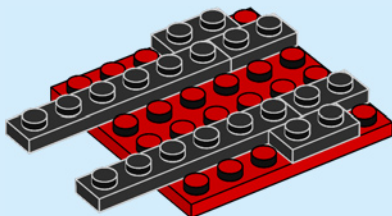

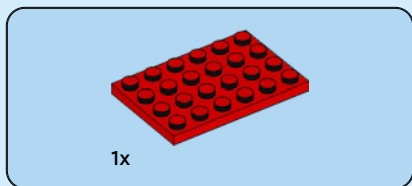

92

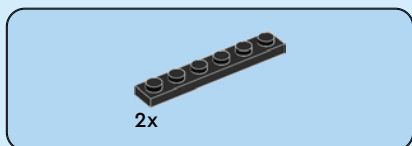
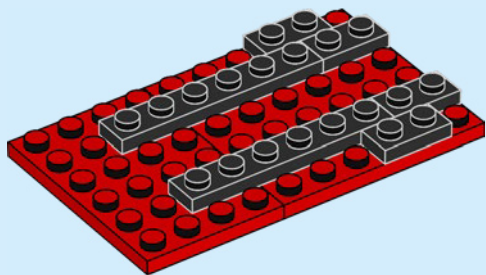

93

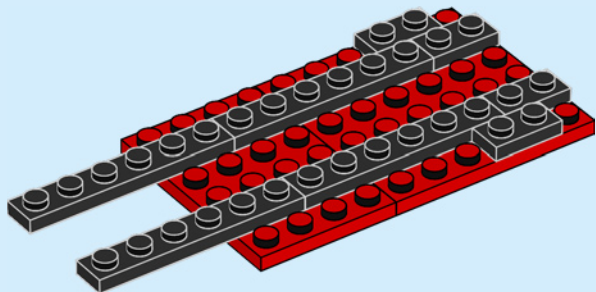

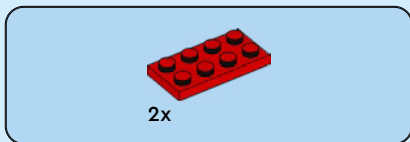

94

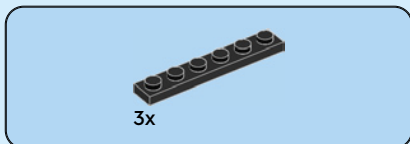
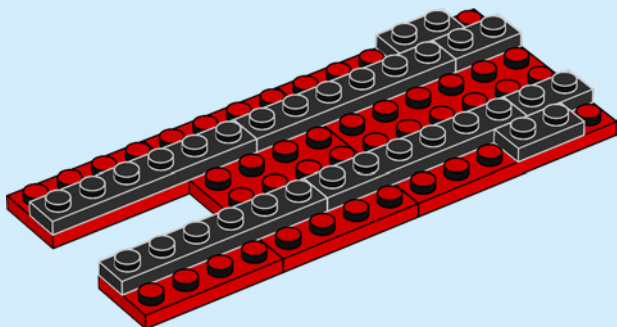

95

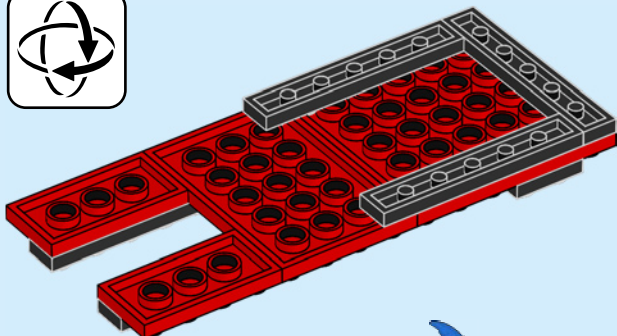
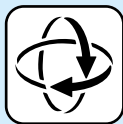

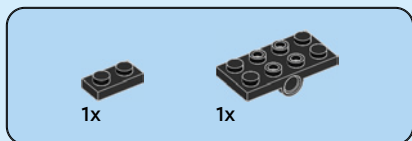

96

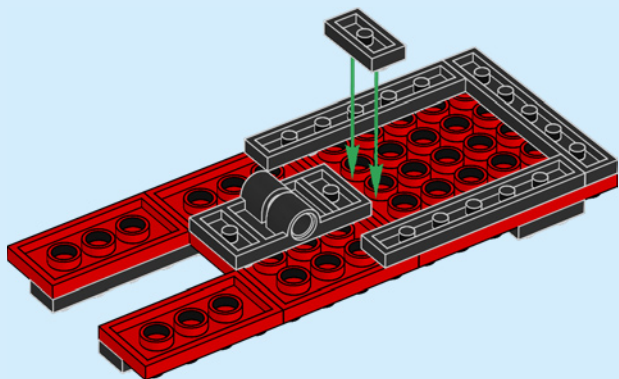



1x

97

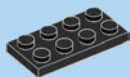
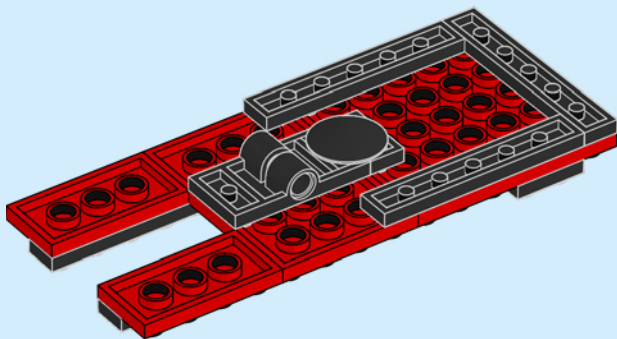

2x

98

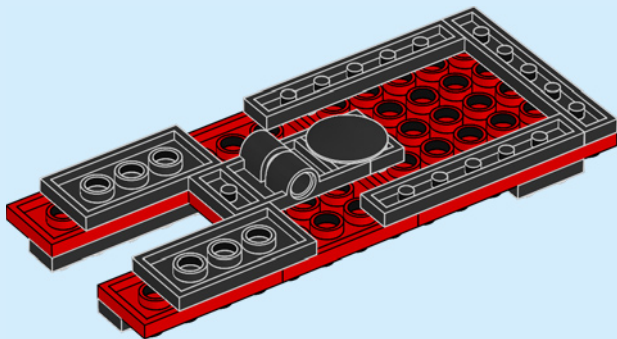



2x

99

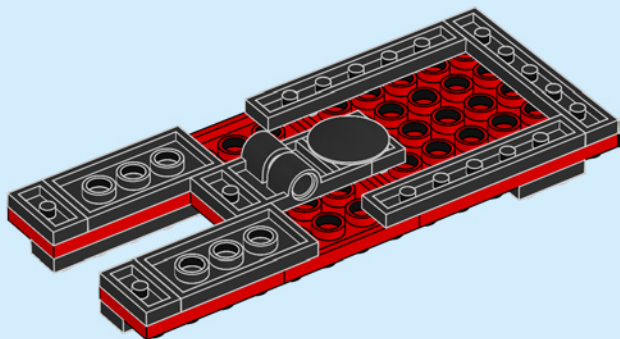

2x

100

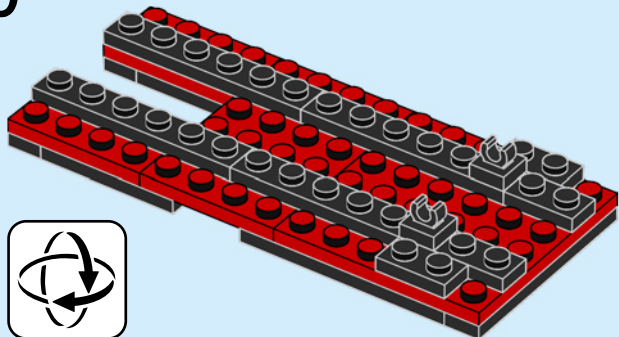

2x

101

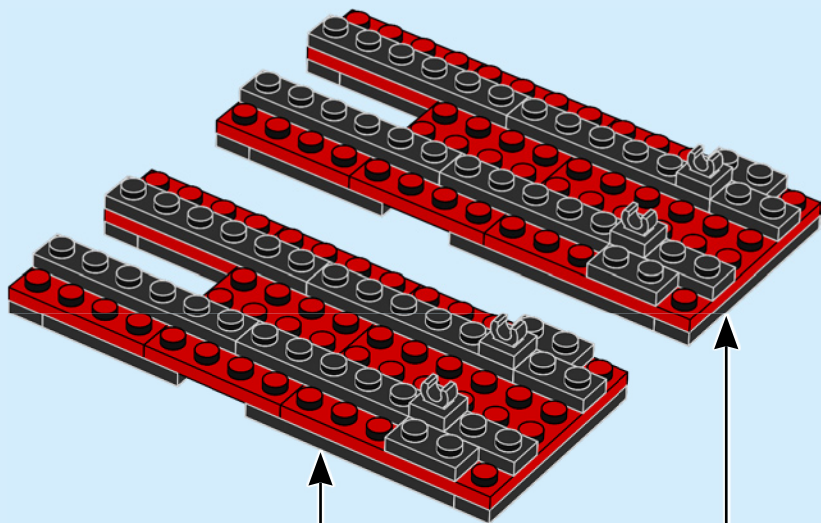

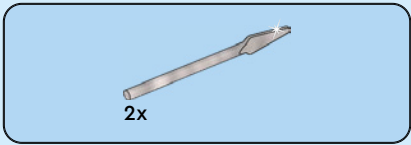

102

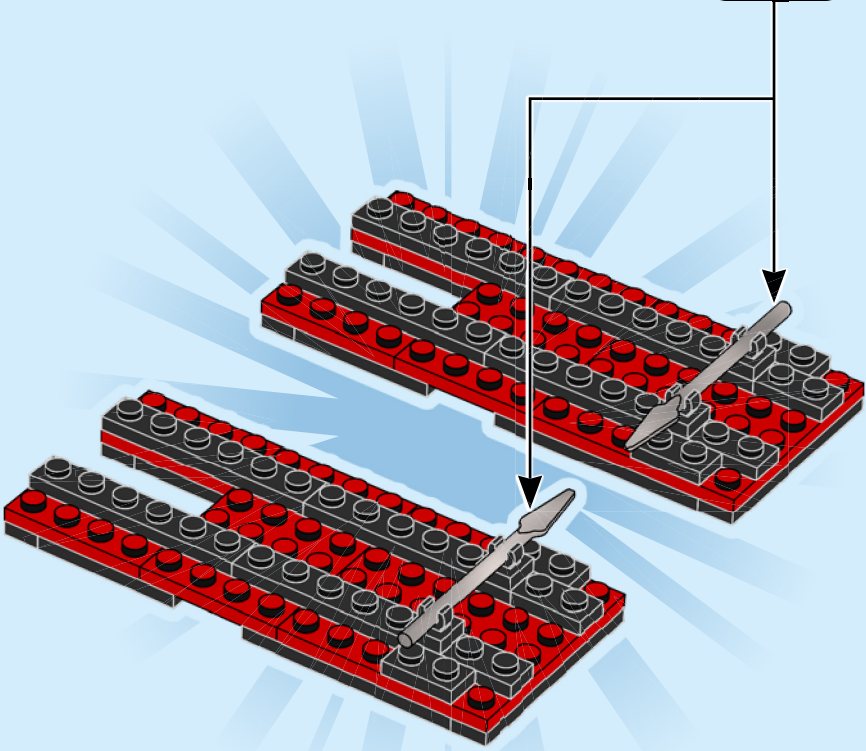
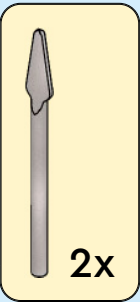

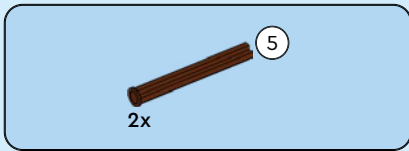

103

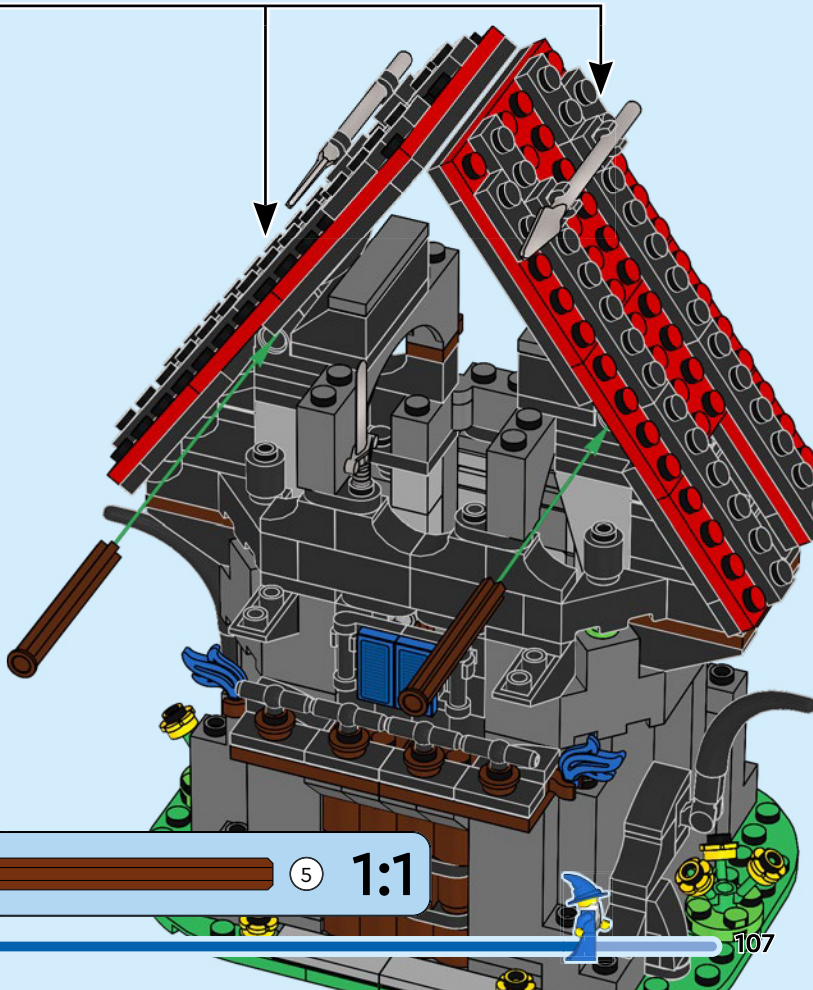



2x



2x

104

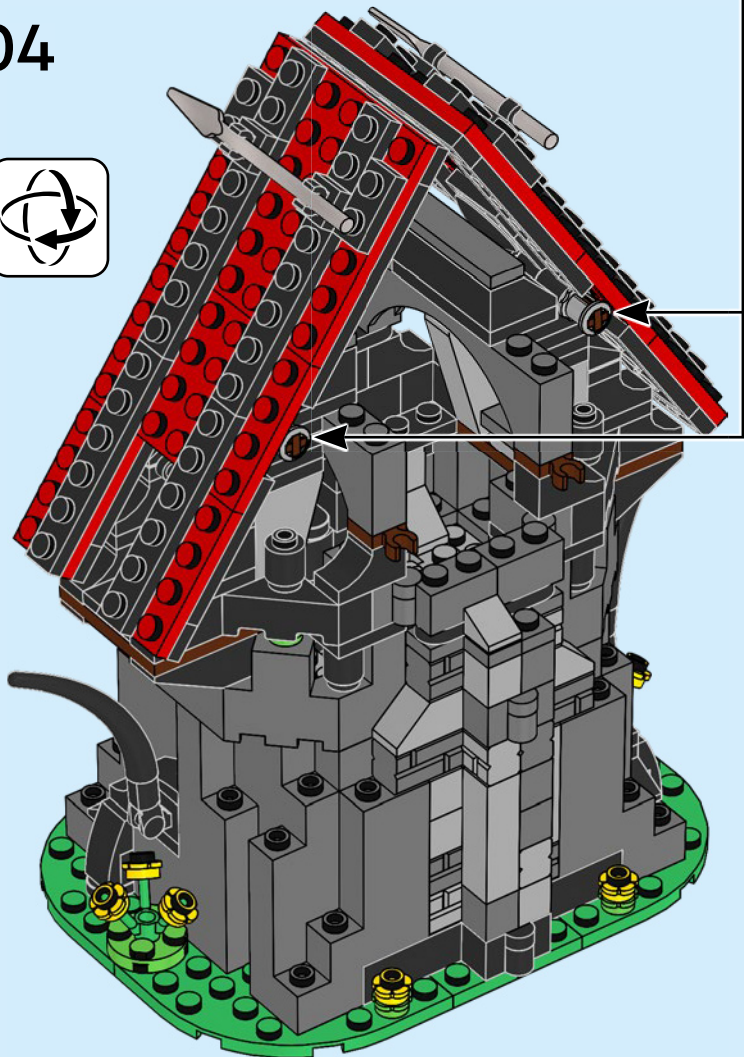

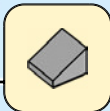
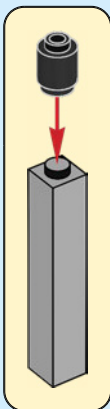
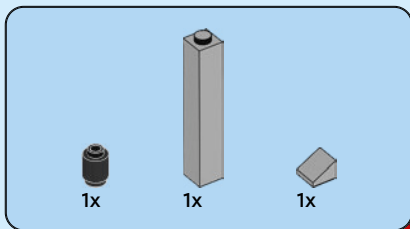

105

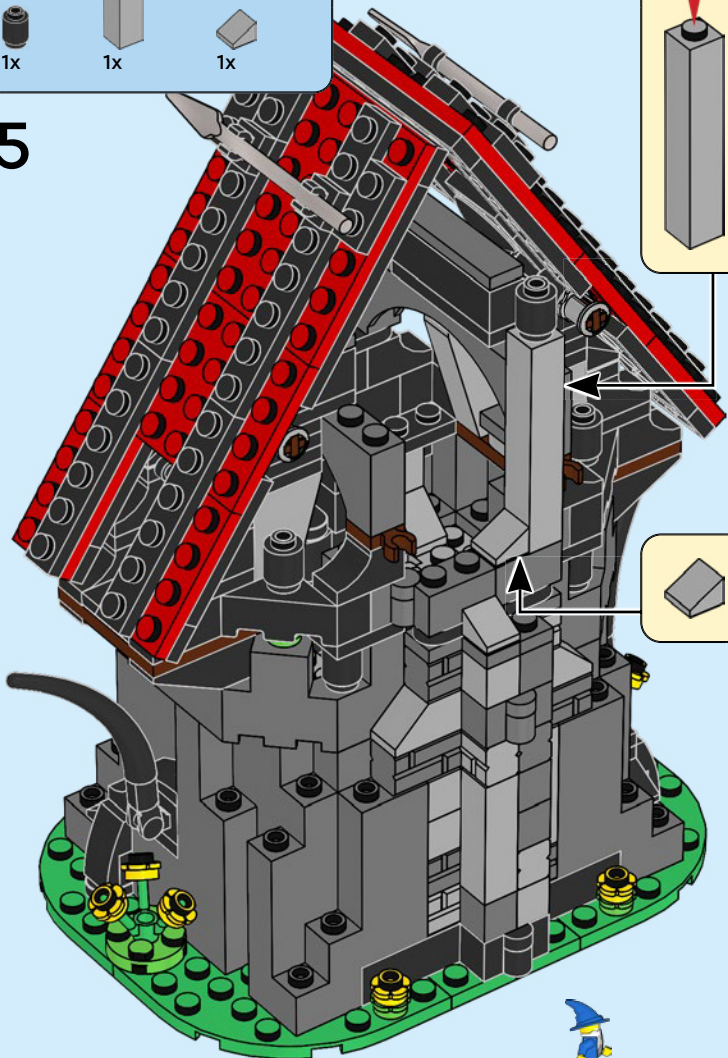

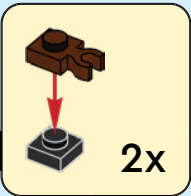

106

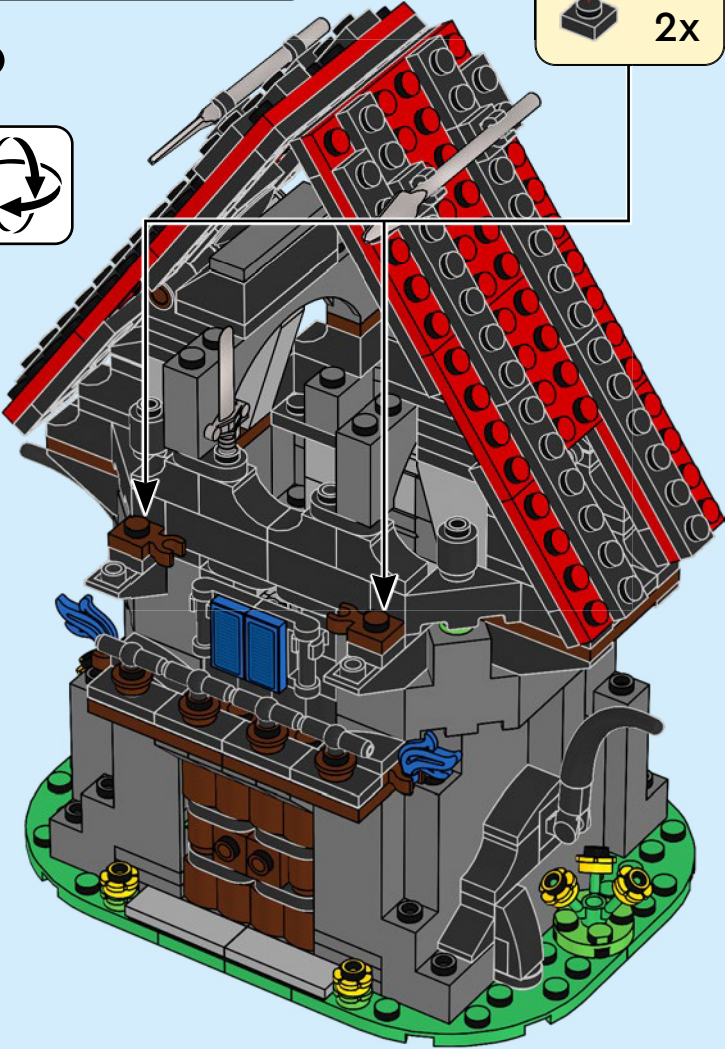



2x

107





2x

108

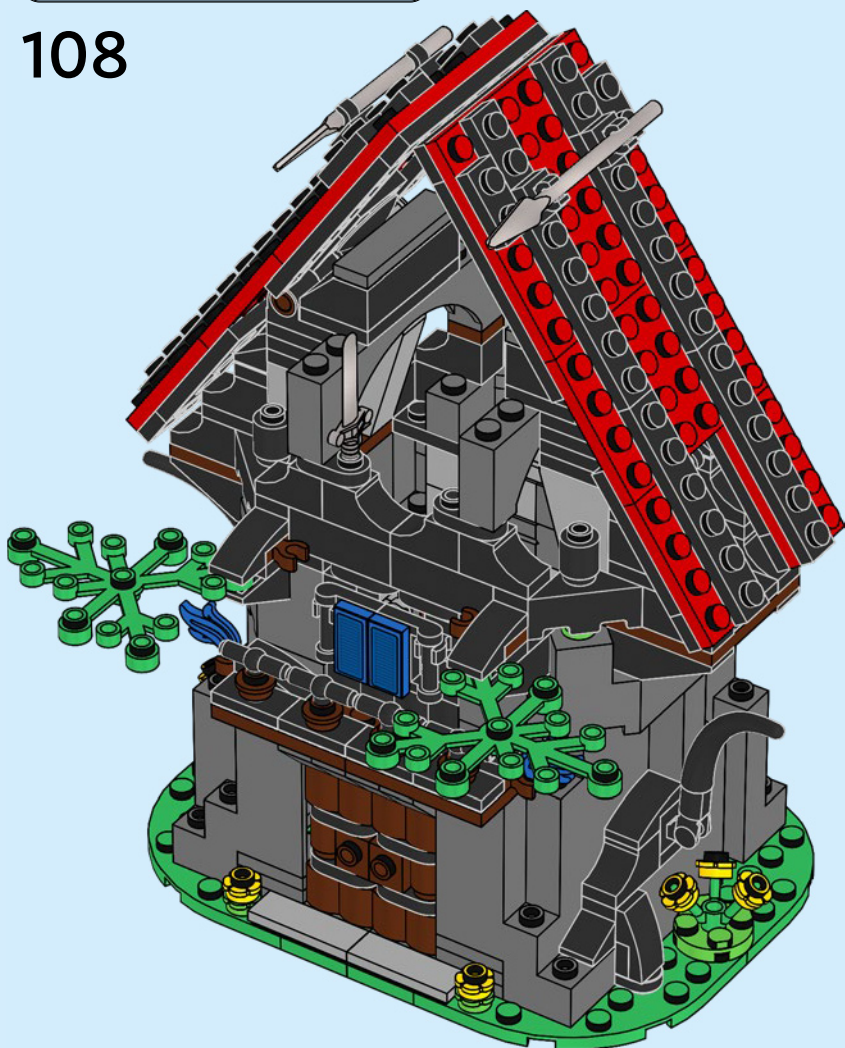

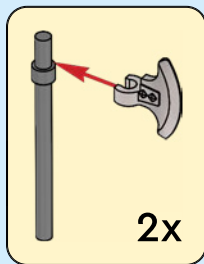
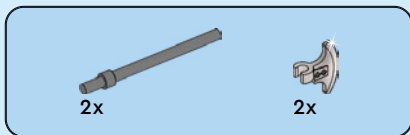

109

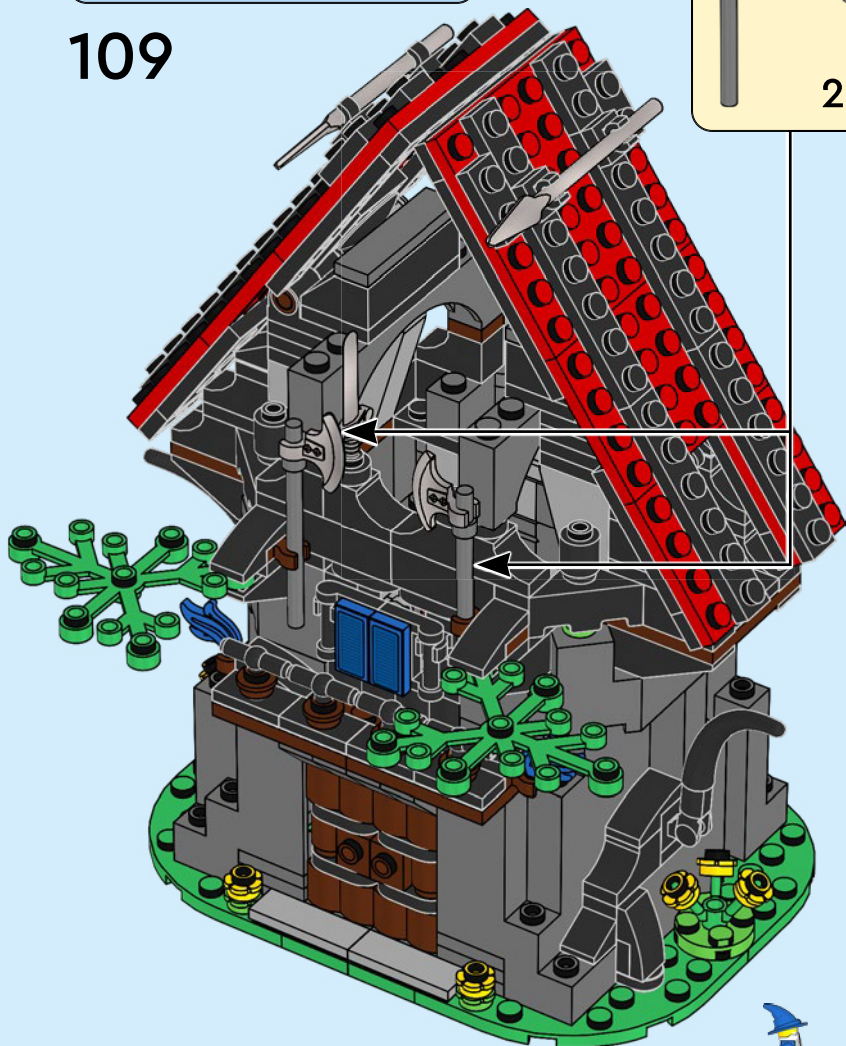



2x



2x

110

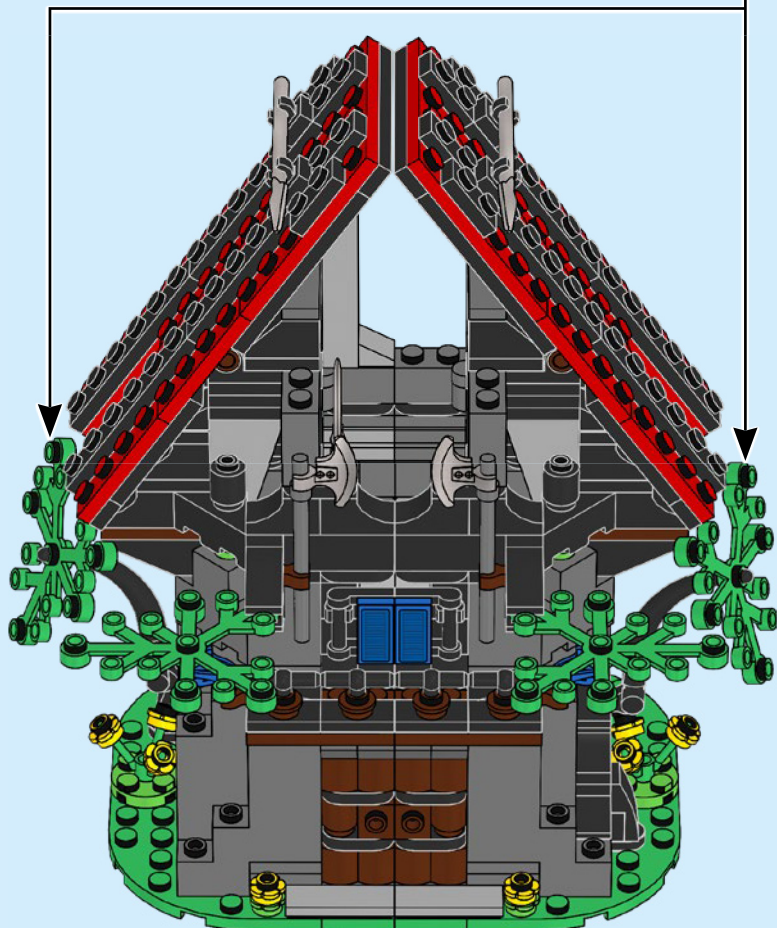

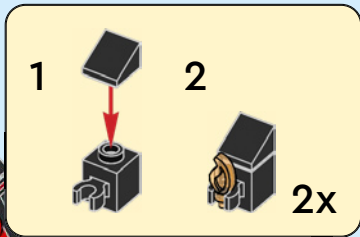
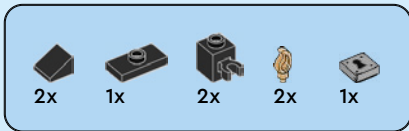

111

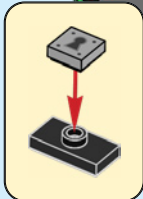
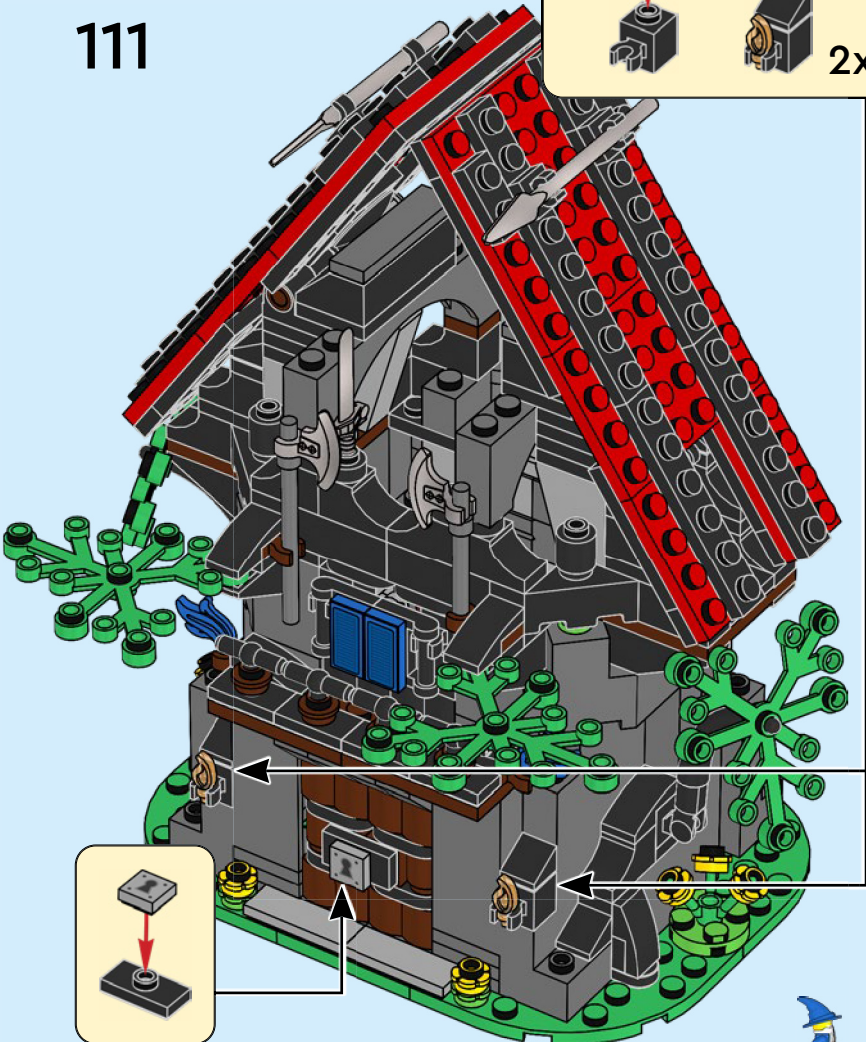

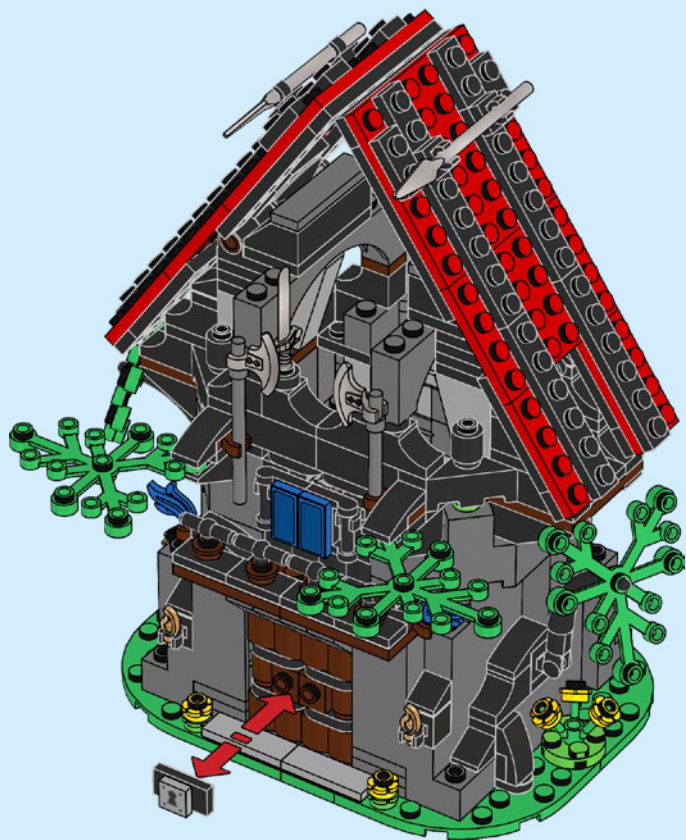





1x
6315564

1x
306801

1x
6453943

4x
302021

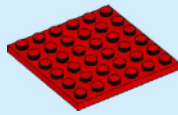
2x
303221

2x
4144302

3x
6289361

2x
306923

1x
6387371

1x
6408141

1x
4275815

10x
6299813

1x
6352820

1x
6174813

2x
6321194

7x
306226

4x
6256435

8x
4504382

2x
4558954

10x
302426

2x
300526

4x
6335388

2x
6320309

4x
6336977

4x
6104209

12x
6210270

2x
4278359

2x
4644456

1x
9339

9x
6092585

16x
6369578

8x
6047276

26x
302326

4x
6114987

1x
6344999

1x
383126

4x
4225201

4x
302226

2x
303926

1x
452926

4x
362226

6x
428726

4x
6394879

8x
302026

2x
303726

2x
6194233

2x
6055070

14x
366626

2x
6269971

4x
6266968

4x
6215659

2x
4211183

2x
6062574

6x
6337003

4x
4211180

2x
4211186

1x
6254220

2x
6159763

1x
4533101

2x
4243838

1x
6030812

1x
6411593

2x
6252045



2x
6166107



1x
6359231



2x
6357747



2x
6275844



11x
4211389



2x
4521921



1x
6251308



2x
6061702



1x
4211362



4x
6248890



4x
6000066



4x
4216248



3x
4211614



2x
4515374



1x
4211632



2x
4558169



1x
4211385



2x
4211452



4x
4211098



4x
4211063



2x
4210635



6x
6000311



2x
6181291



3x
6327414



3x
4210795



4x
6100124



2x
4211001



2x
4211053



2x
6170420



2x
6313652



2x
6295686



1x
4632767



2x
6363145



2x
4611883



1x
6125711



1x
6327807



1x
6020190



8x
6206150



2x
6138624

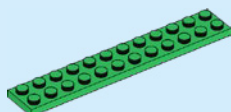

2x
6218146



4x
6021999

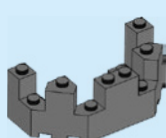

2x
6454127

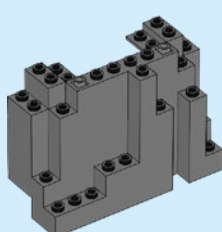

2x
4279446



LEGO.com/service



YOU COULD

WIN



Scan this QR code or go to **LEGO.COM/PRODUCTFEEDBACK** and give us your short feedback about this LEGO® set for a chance to win a cool LEGO prize.

Terms and Conditions apply*

EN: YOU COULD WIN. Terms and Conditions apply* **DE: Du könntest GEWINNEN.** Es gelten die Teilnahmebedingungen* **FR: Tu pourrais GAGNER.** Des conditions s'appliquent* **IT: Potresti VINCERE tu.** Termini e condizioni sono applicabili* **ES: Puedes GANAR.** Aplican términos y condiciones* **PT: Poderá GANHAR.** Aplicam-se termos e condições* **ZH: 轻松获奖. 条款和条件适用*** **PL: Szansa na WYGRANĄ.** Obowiązują warunki korzystania* **CS: Máte šanci VYHRÁT.** Platí všeobecné smluvní podmínky* **SK: Máte šancu VYHRAŤ.** Platia všeobecné zmluvné podmienky* **HU: TE IS NYERHETSZ.** Felhasználási feltételek érvényesek* **RO: Ai putea CÂȘTIGA.** Se aplică termenii și condiții* **BG: Можете да СПЕЧЕЛИТЕ.** Има определени правила и условия* **LV: Tu vari LAIMĒT.** Ir spēkā noteikumi un nosacījumi.* **ET: Sul on võimalus VÕITA.** Kehtivad tingimused* **LT: Jūs galite LAIMĖTI.** Taikomos sąlygos*

*[LEGO.com/productfeedback-terms](https://www.lego.com/productfeedback-terms)

LEGO and the LEGO logo are trademarks of the/sonnt des marques de commerce du/son marcas registradas de LEGO Group. ©2023 The LEGO Group.