



Booklet available in English on
Heft in deutscher Sprache erhältlich auf
Livret disponible en français sur
Libretto disponibile in italiano su
Folleto en español disponible en
如需中文版手册，请访问



FR

DONNEZ
OU
RECYCLEZ



ASSOCIATION

OU



MAGASIN

OU



DÉCHÈTERIE

Adresses sur quefairedemesdechets.fr



LEGO.com/sustainable-packaging

LEGO® VIP

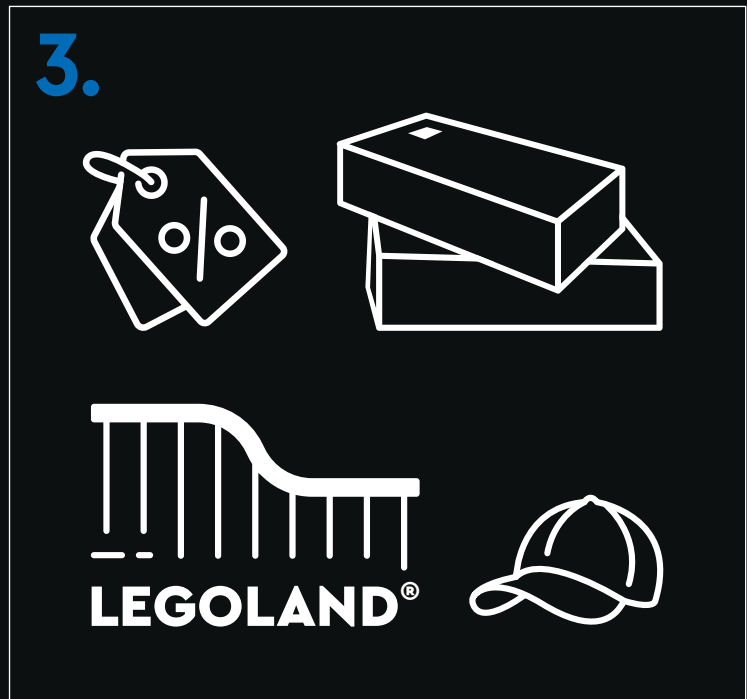
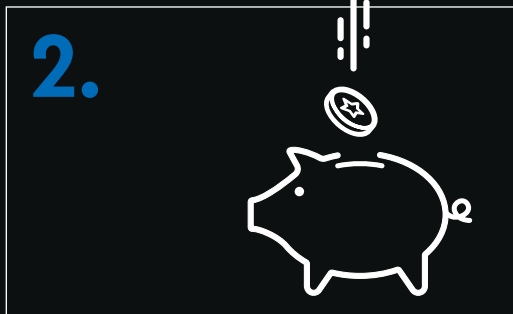

1. Sign up **2.** Earn points for purchases **3.** Redeem points for rewards, experiences, discounts & more | **1.** Melde dich an **2.** Sammle Punkte bei jedem Kauf **3.** Löse die Punkte für Belohnungen, Erlebnisse, Rabatte und Ähnliches ein | **1.** Inscrivez-vous **2.** Gagnez des points lors de vos achats **3.** Échangez vos points contre des récompenses, des expériences, des remises et bien plus encore | **1.** Iscriviti **2.** Guadagna punti con i tuoi acquisti **3.** Riscatta punti per premi, esperienze, sconti e altro ancora | **1.** Regístrate **2.** Gana puntos por tus compras **3.** Canjea puntos por recompensas, experiencias, descuentos y mucho más | **1.** Registe-se **2.** Ganhe pontos em compras **3.** Troque os pontos para prêmios, experiências, descontos e muito mais | **1.** 注册 **2.** 购物赚积分 **3.** 用积分兑换奖励、体验、折扣等 | **1.** Zarejestruj się **2.** Zdobywaj punkty za zakupy **3.** Wymieniaj punkty na rabaty, przygody i inne nagrody | **1.** Zaregistrujte se **2.** Sbirejte body za nákupy **3.** Vyměňujte body za odměny, zážitky, slevy a spoustu dalšího | **1.** Zaregistrujte sa **2.** Získavajte body za nákupy **3.** Uplatnite si body a získajte odmeny, rôzne zážitky, zľavy a ešte viac | **1.** Regisztrálj **2.** Szerez pontokat minden vásárlással **3.** Váltsd be pontjaidat jutalmakra, élményekre, kedvezményekre és egyébekre | **1.** Înscrie-te **2.** Câștigă puncte pentru achiziții **3.** Valorifică puncte pentru recompense, experiențe, reduceri și multe altele | **1.** Регистриаите се **2.** Получавайте точки за покупки **3.** Използвайте точките за награди, услуги, отстъпки и т.н. | **1.** Regístrējies **2.** Pelni punktus par pirkumiem **3.** Izmanto punktus, lai saņemtu balvas, izklaides iespējas, atlaides un daudz ko citu | **1.** Registreeru **2.** Teeni ostude eest punkte **3.** Lunasta punktide eest preemiad, elamused, allahindlused ja muu | **1.** Užsiregistruokite **2.** Pelnkite taškus už pirkinius **3.** Panaudokite taškus atlygiui, funkcijoms, nuolaidoms ir ne tik



WELCOME TO LEGO® ART

● Add a stroke of warm, vivid and unique modern LEGO® Art to your walls. Recreate a gallery vibe in any room with one of four exclusive designs featured in this booklet or reconstruct your artwork anytime you feel inspired to try new expressions!

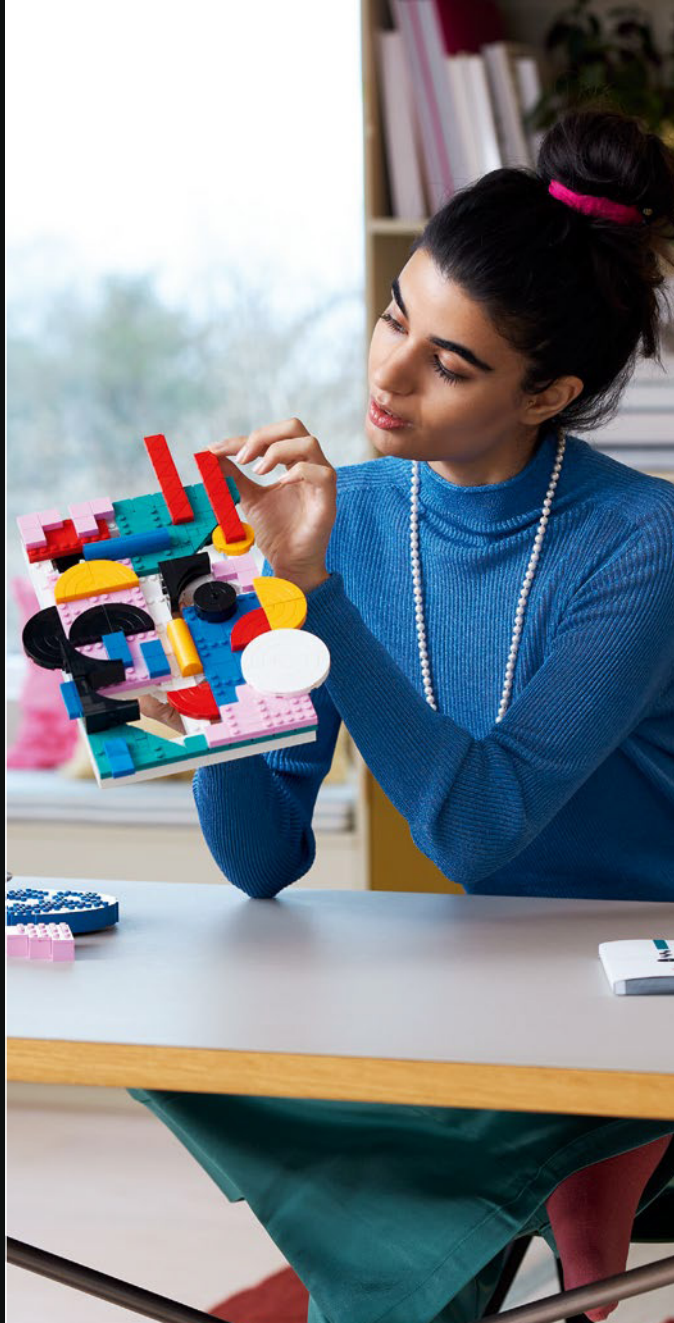



CREATE AND DISPLAY – YOUR WAY

● Klint, Kandinsky, Matisse, YOU. Be inspired by your favourite abstract artists, build your own vibrant masterpiece and turn it into endless new combinations. Find tips to rebuild and combine your modules and play with colours, lines and shapes to create balance, rhythm, movement – and fun!



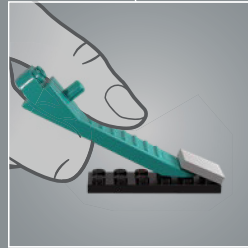
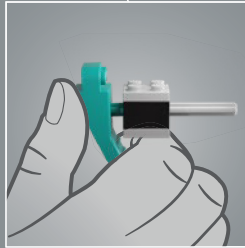
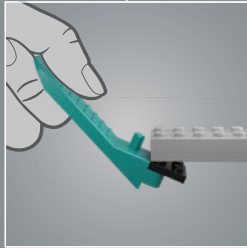
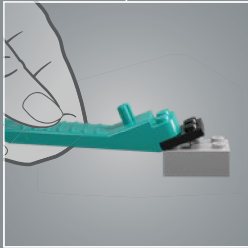
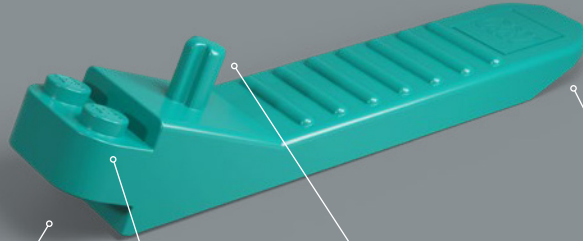

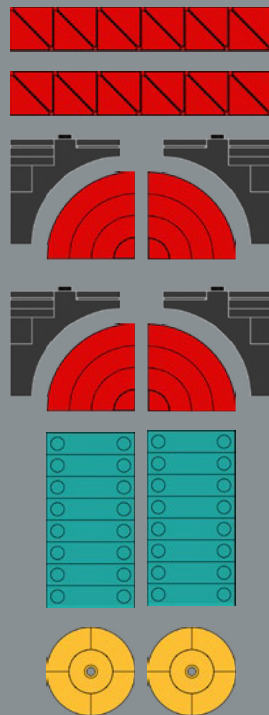
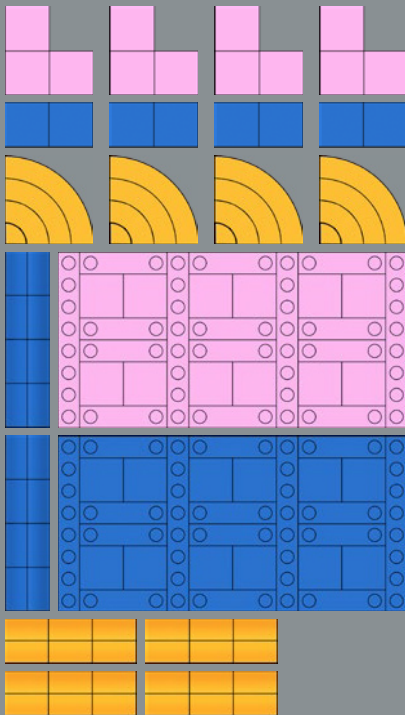
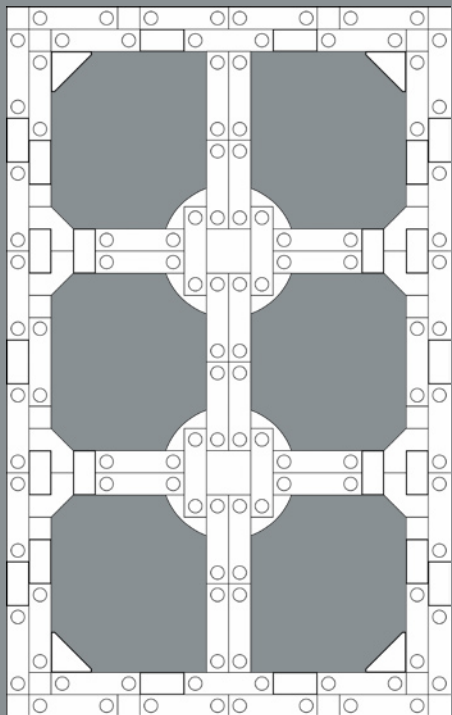

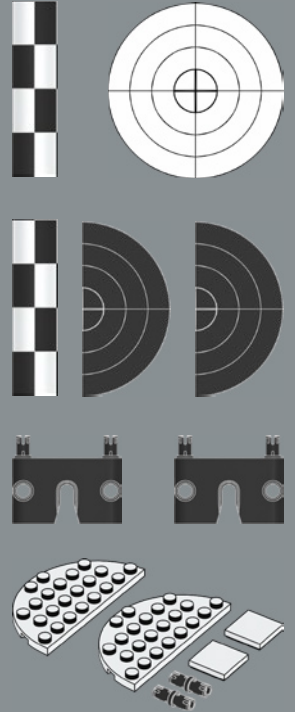
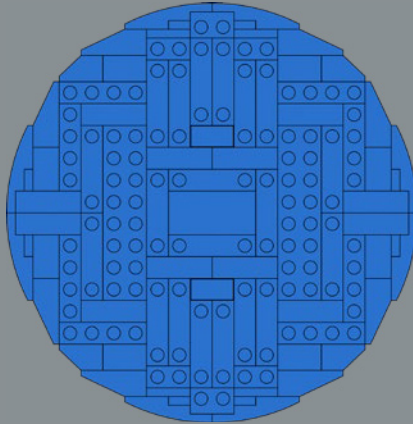
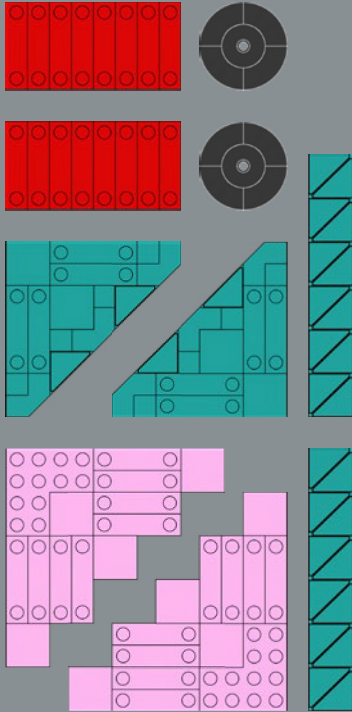

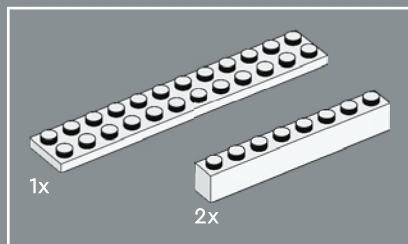

1

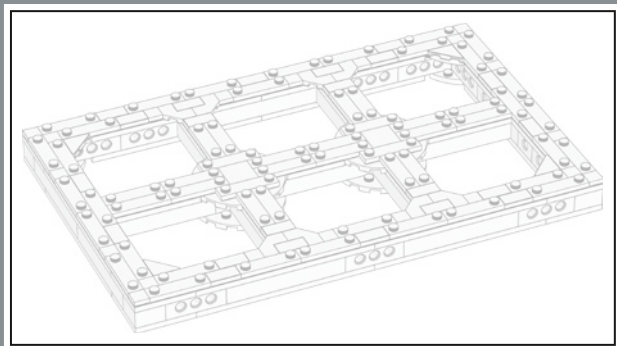
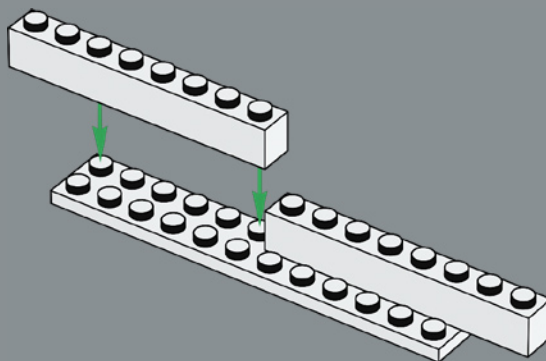

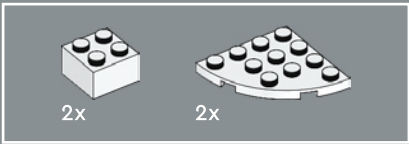

2

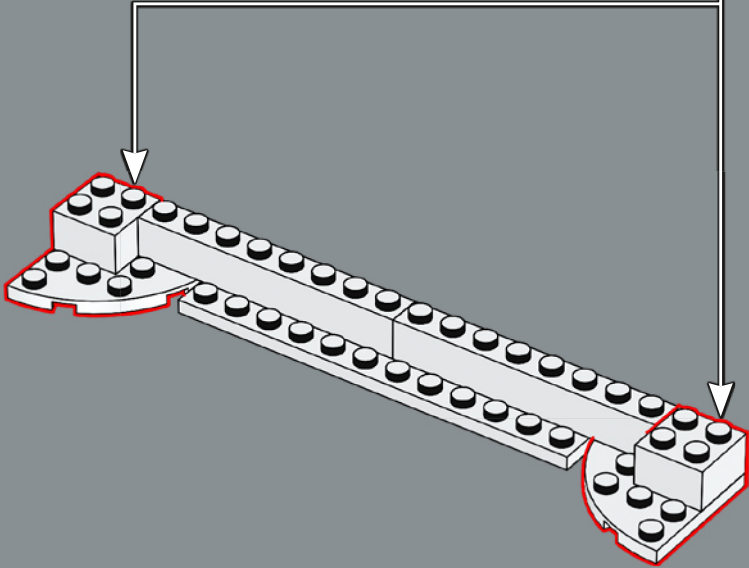
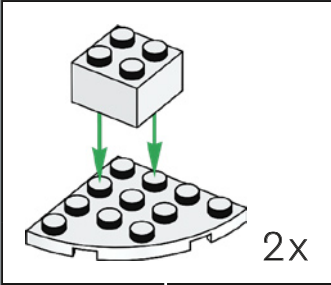

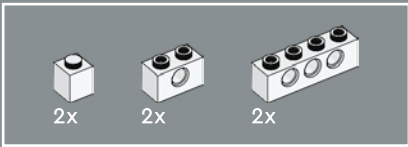

3

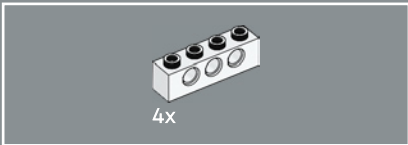
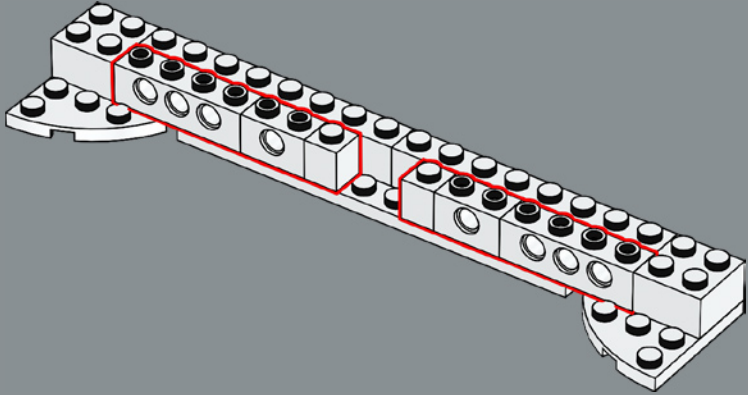

4

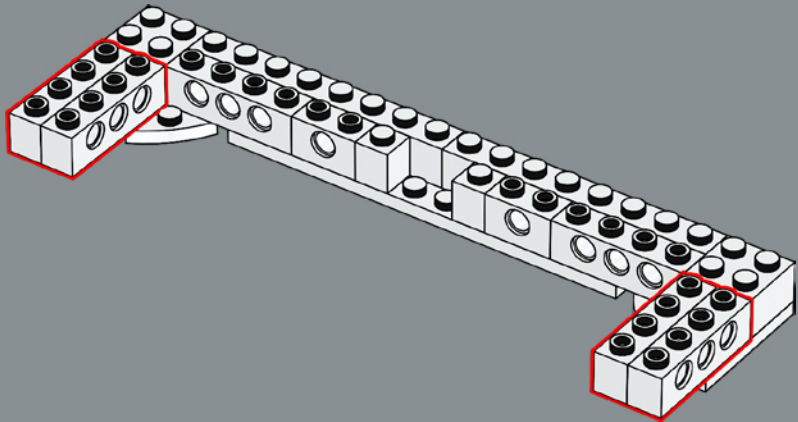

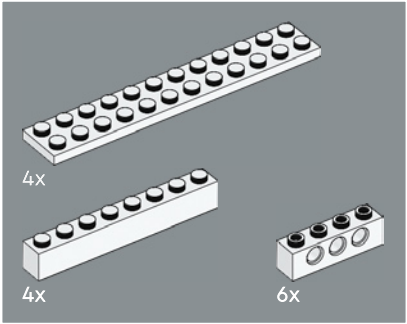
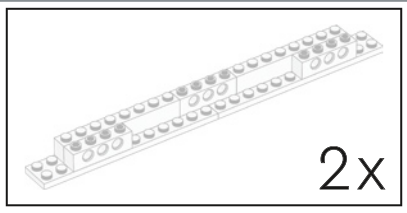

5

1

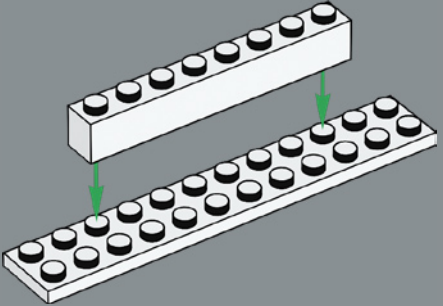

2

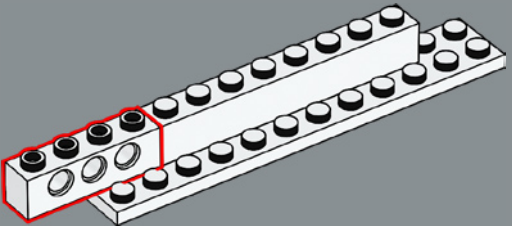

3

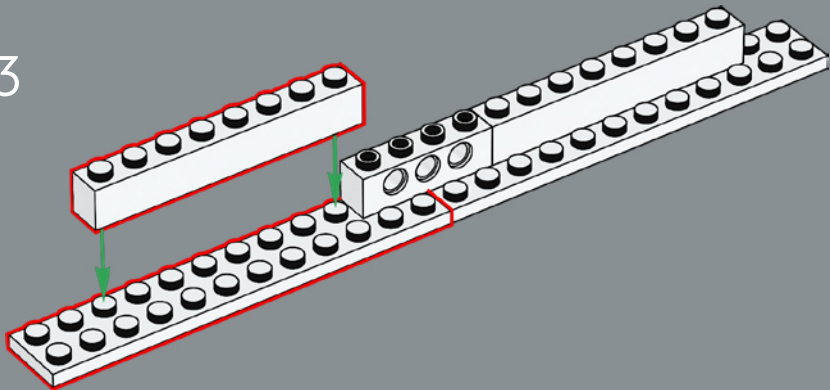

4

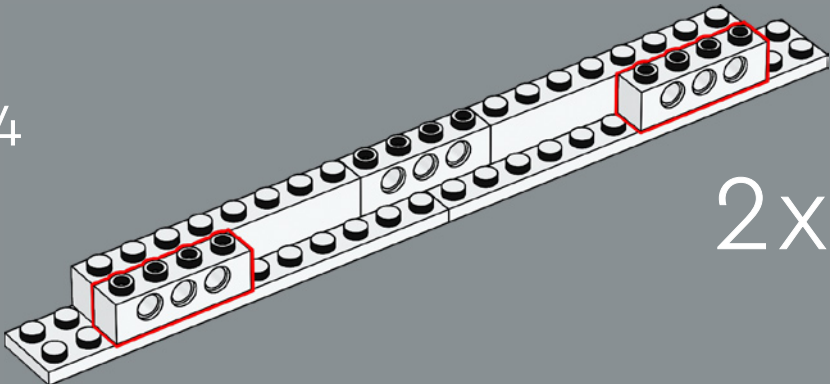

2x

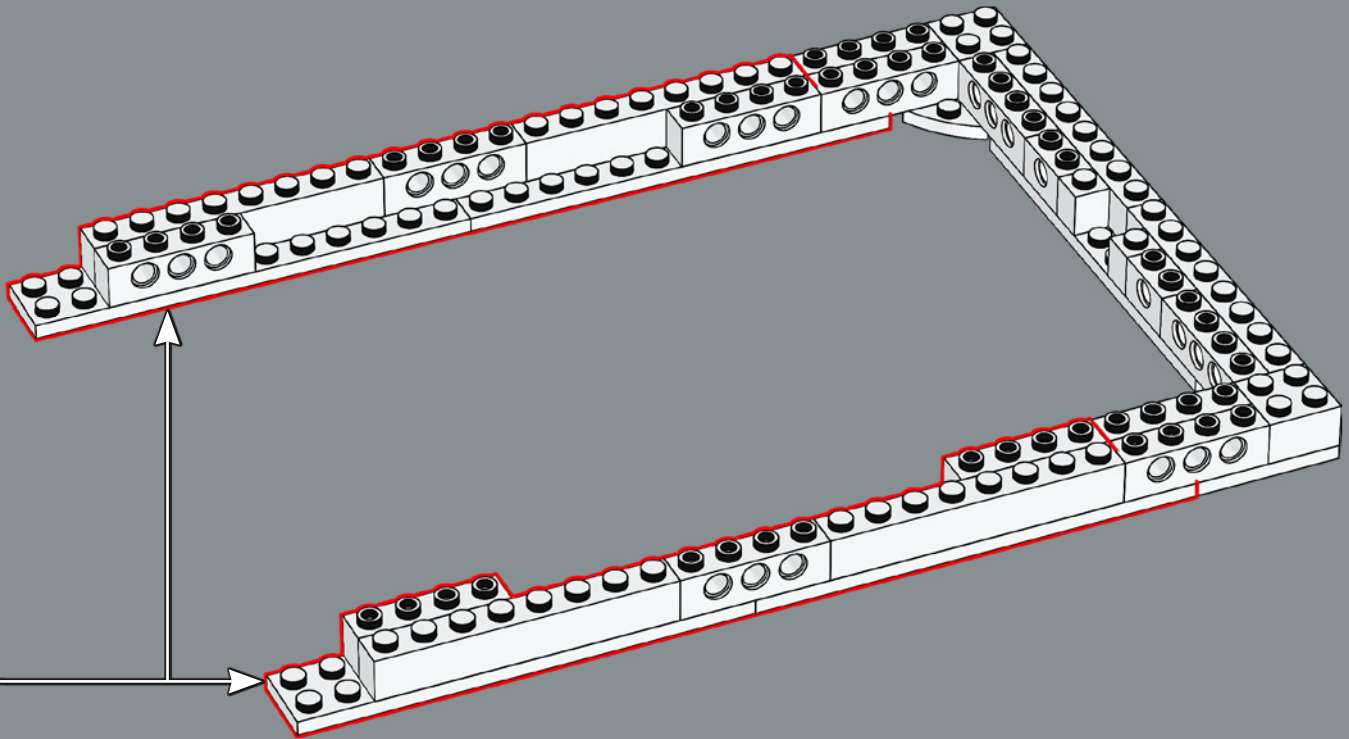

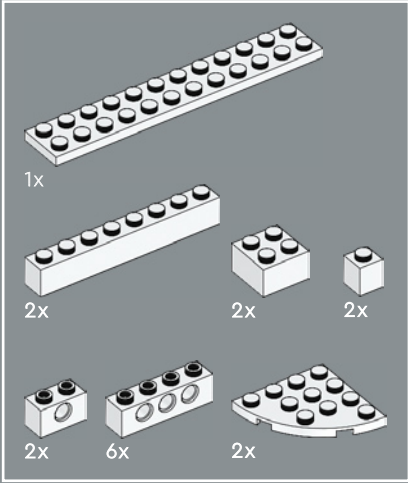
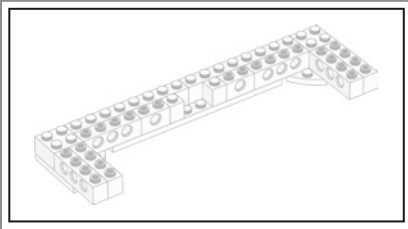

6

1

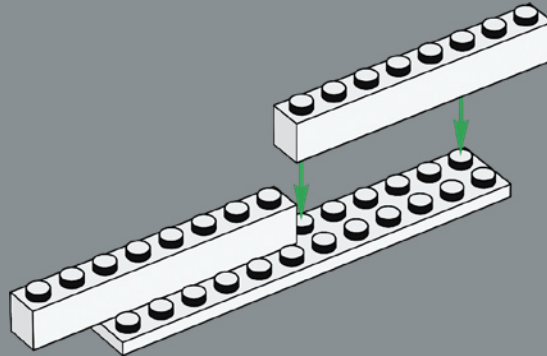

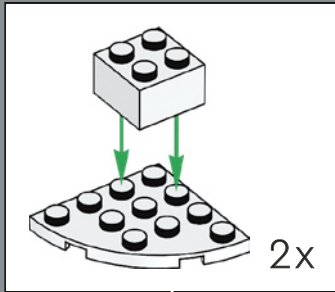

2

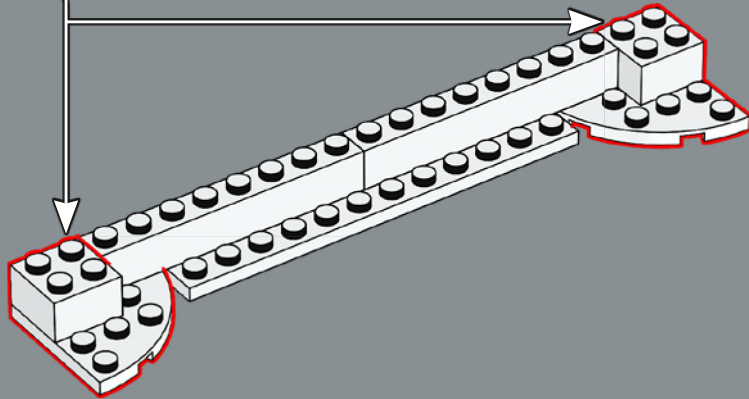

3

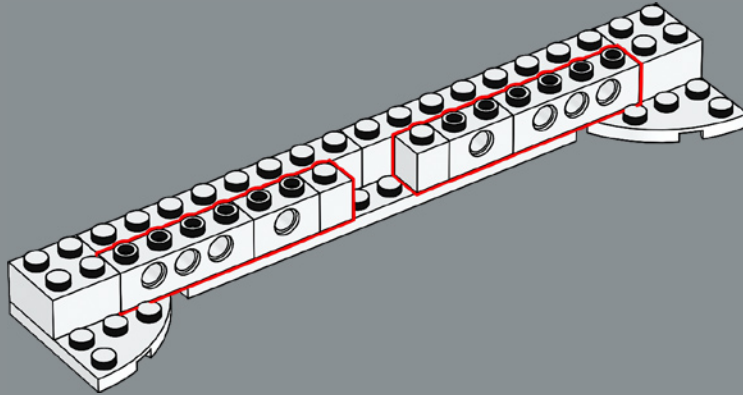

4

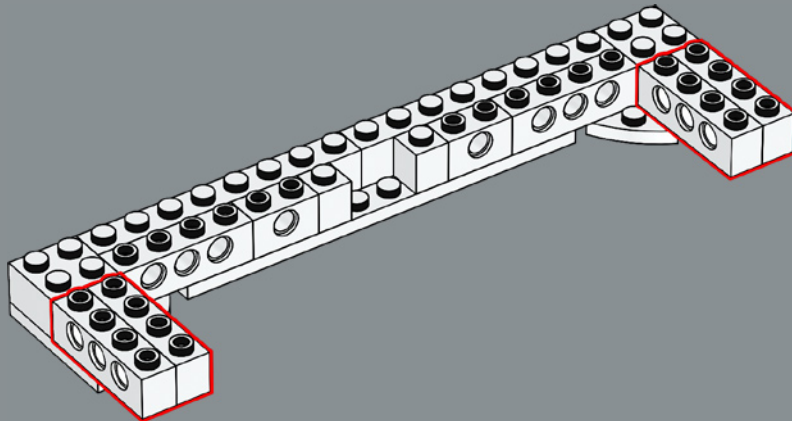

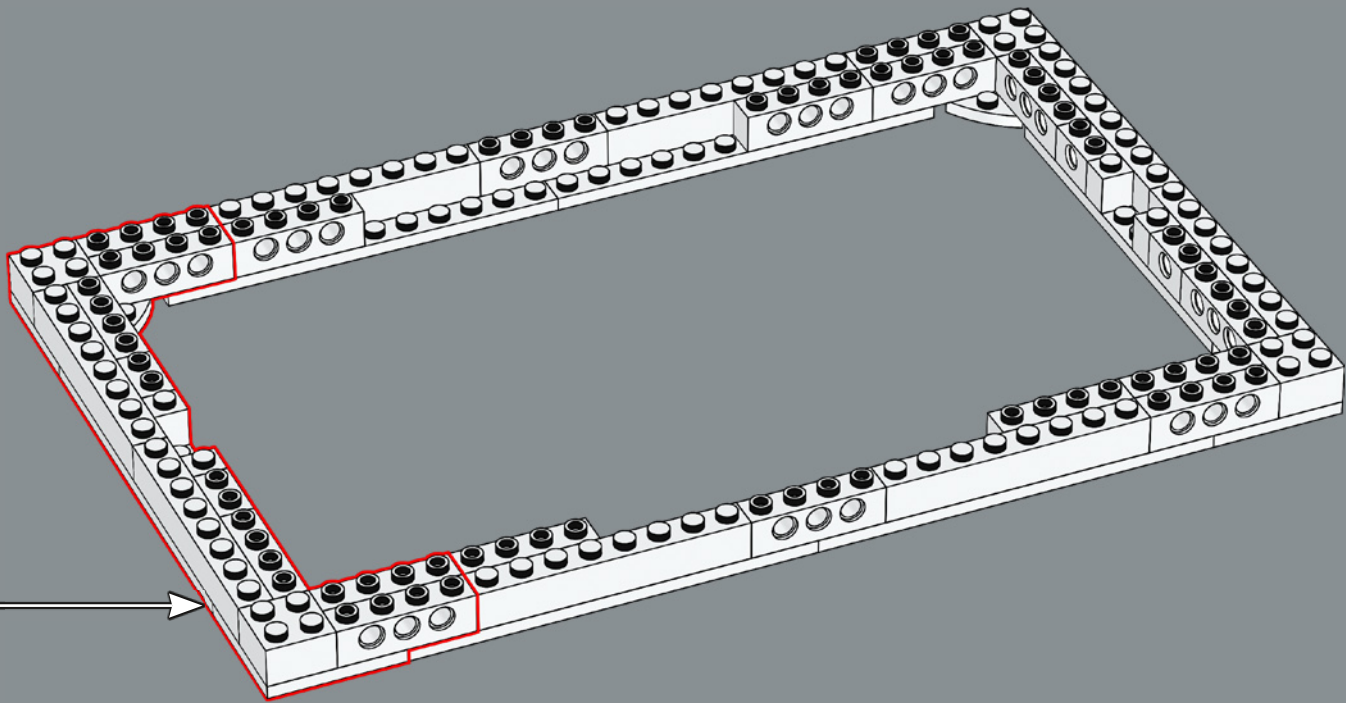

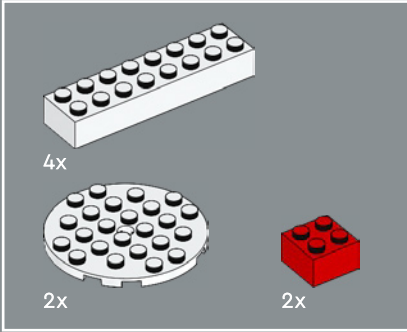
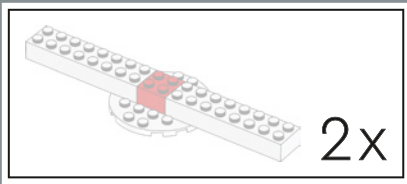

7

1

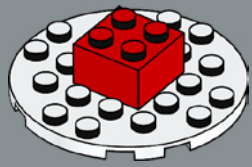

2

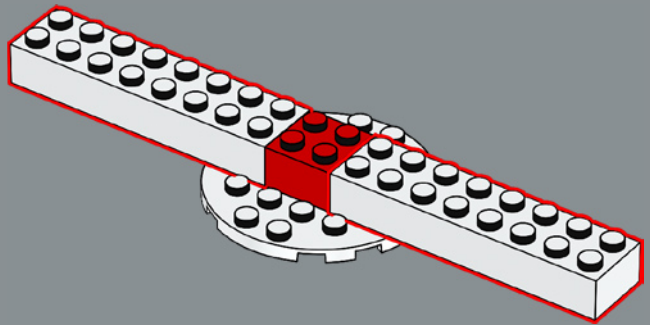

2x

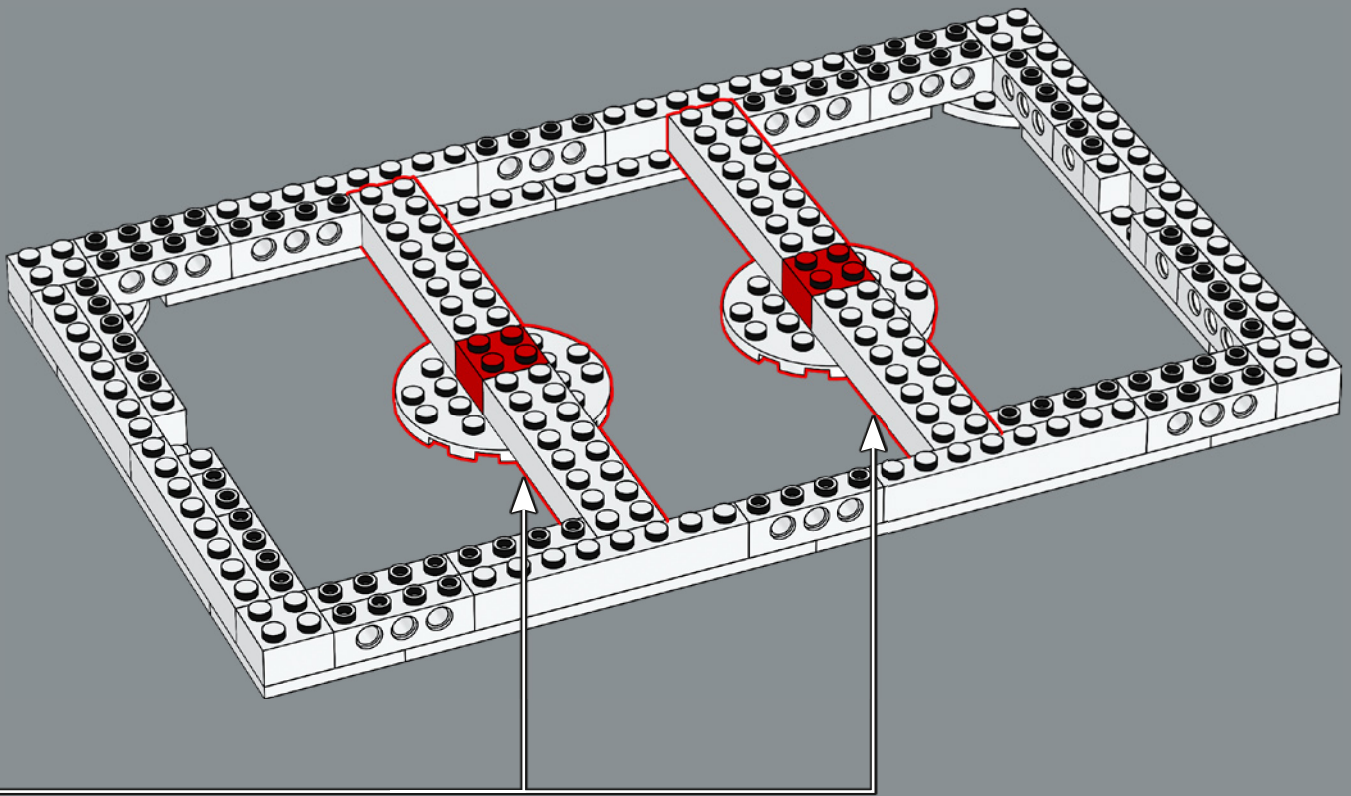

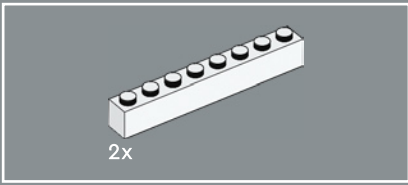

8

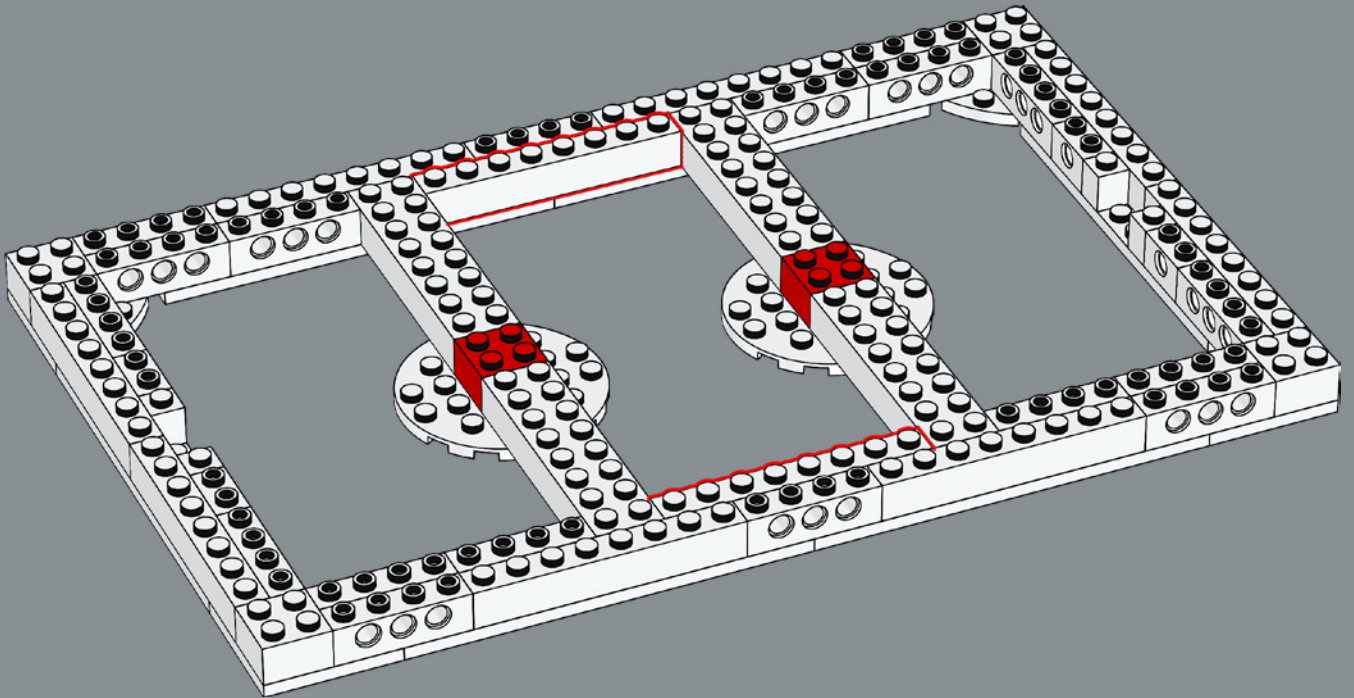

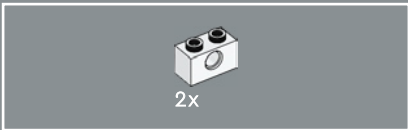

9

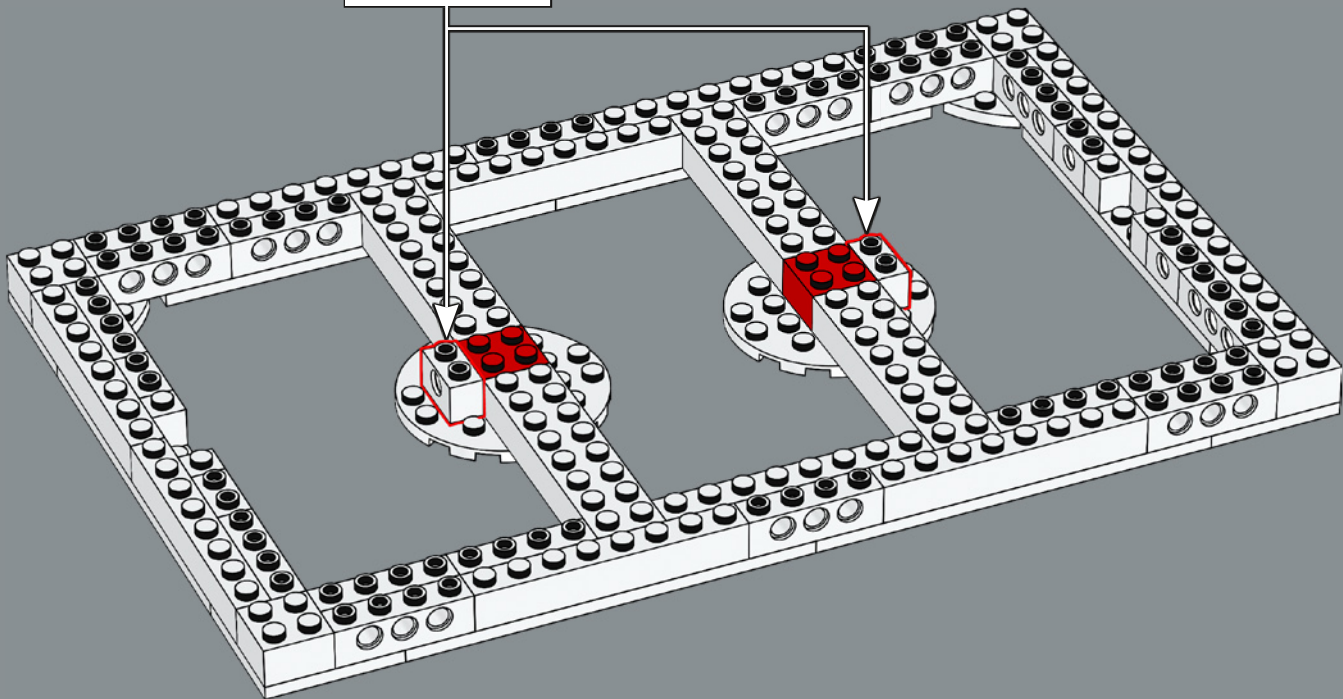
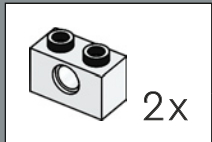

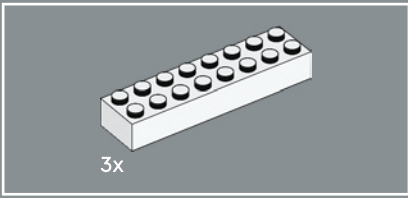

10

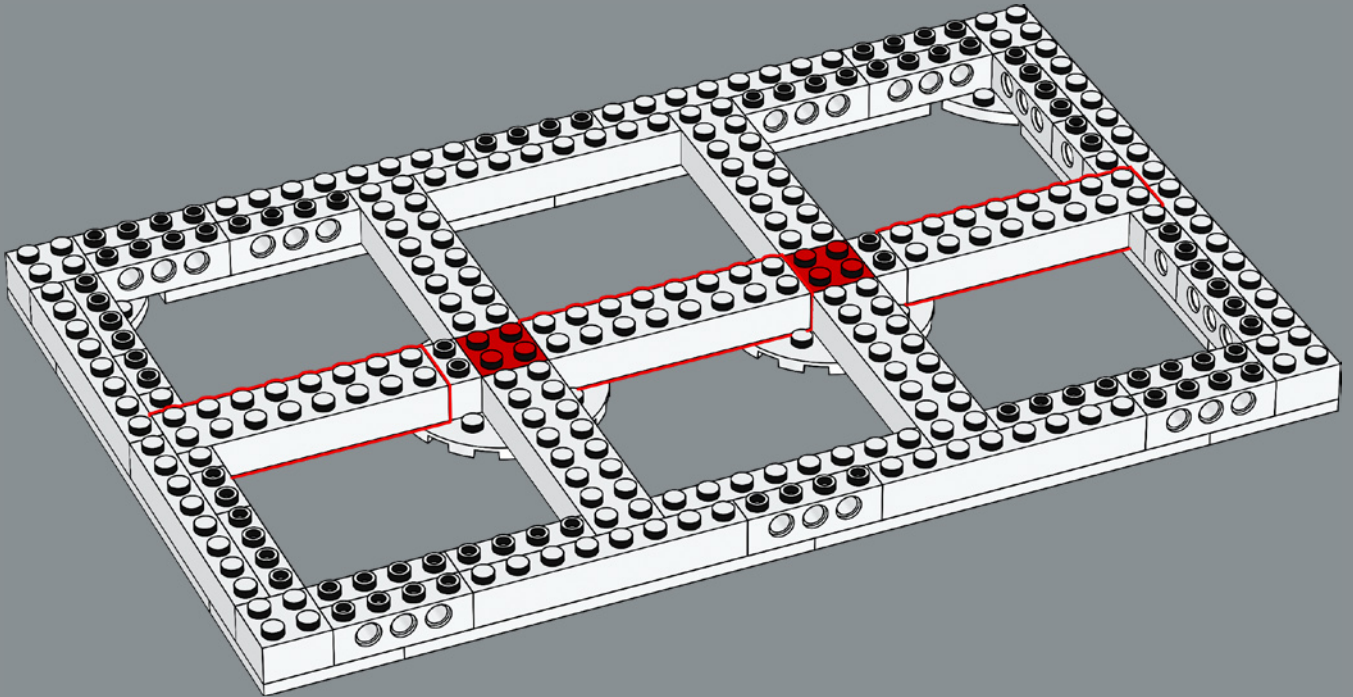



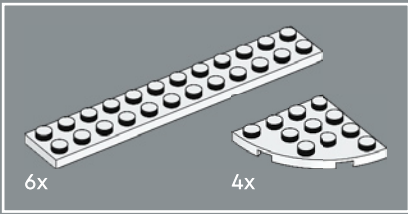

11

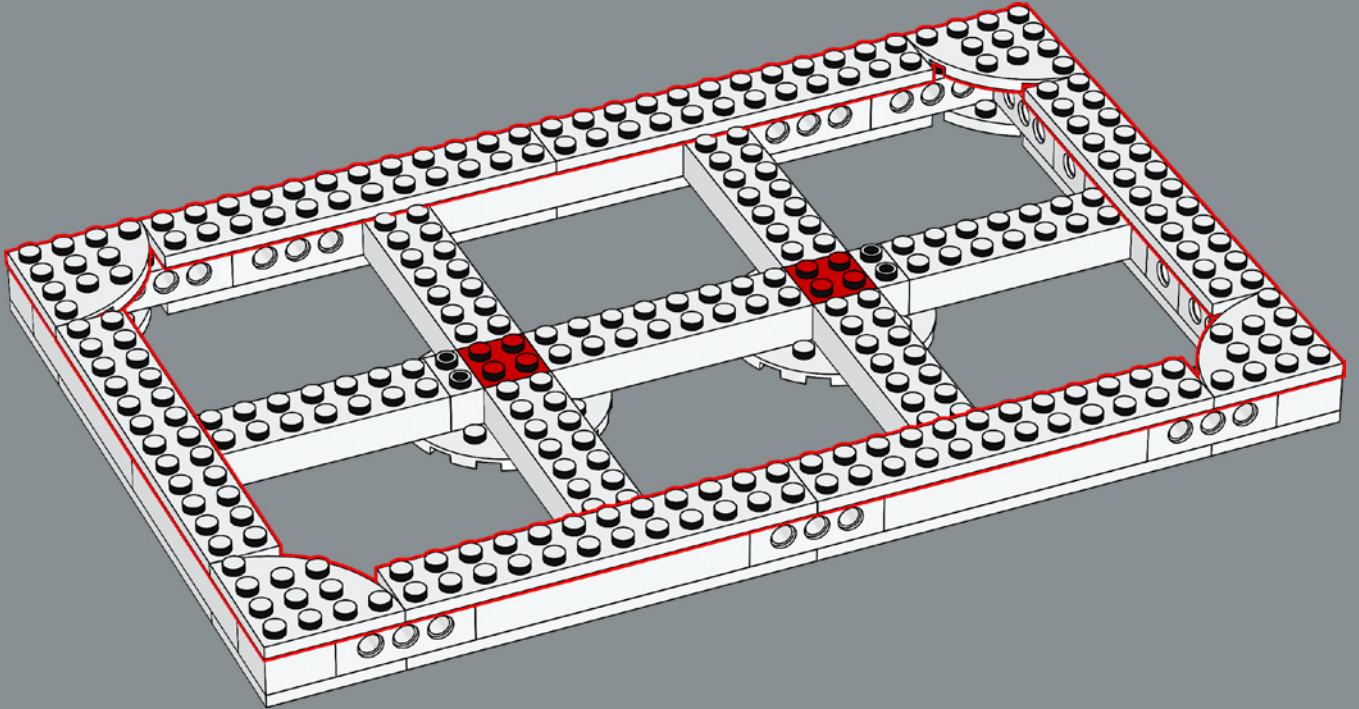

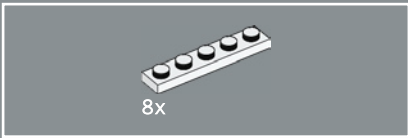

12

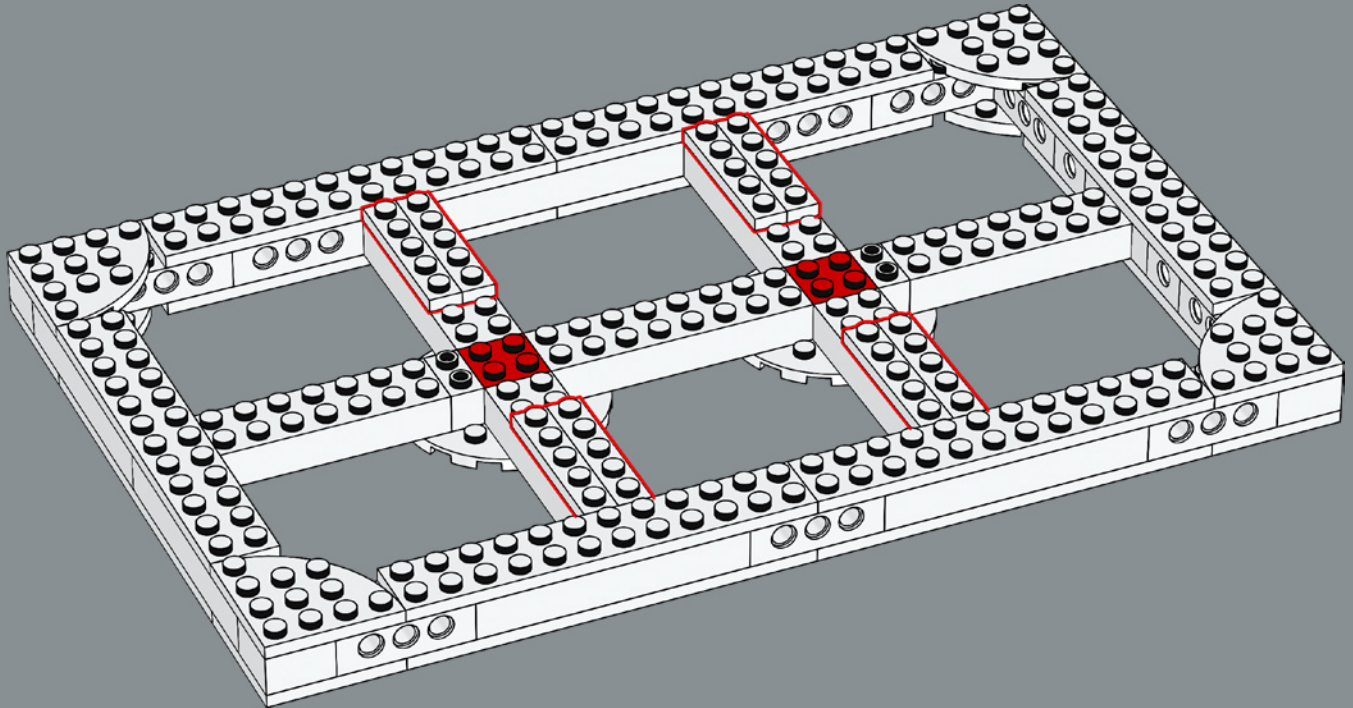

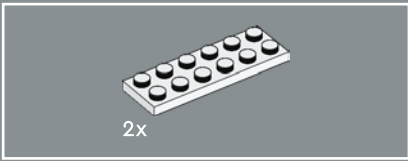

13

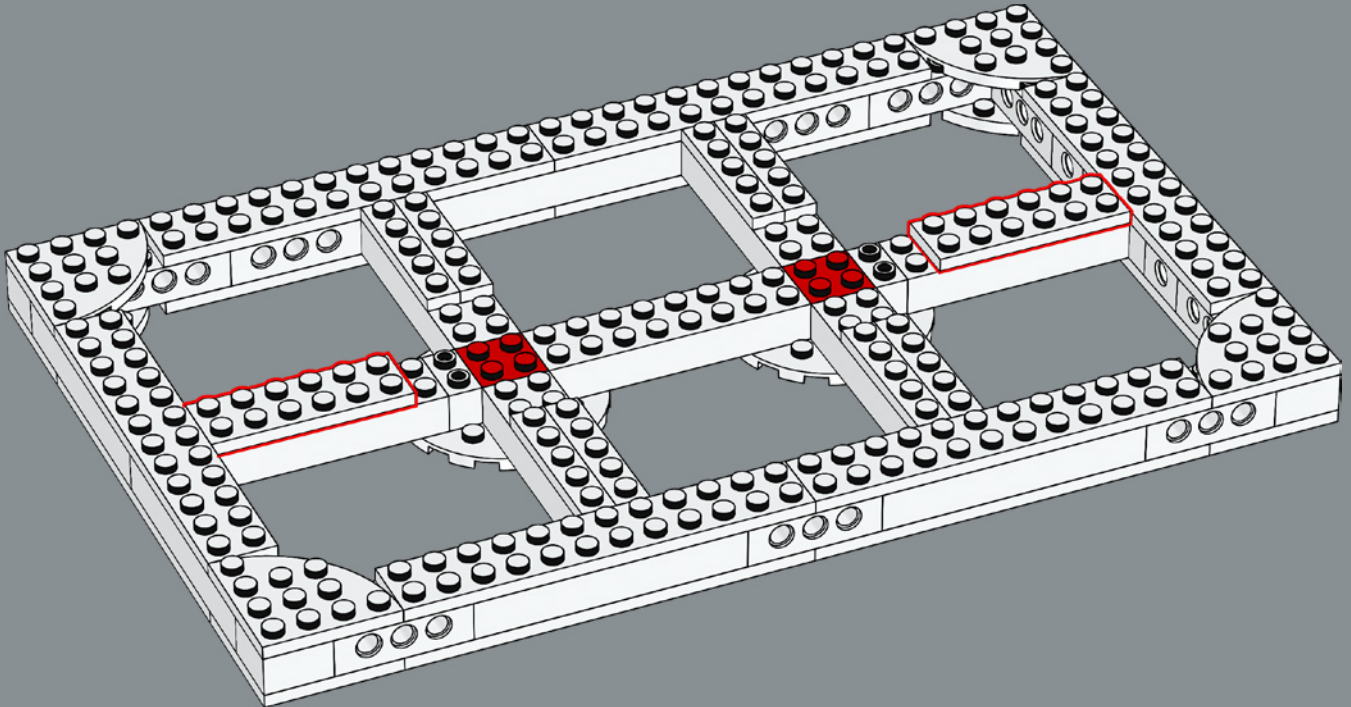

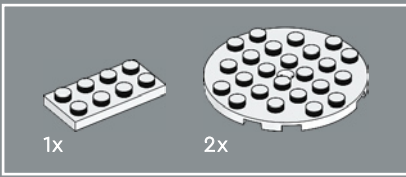

14

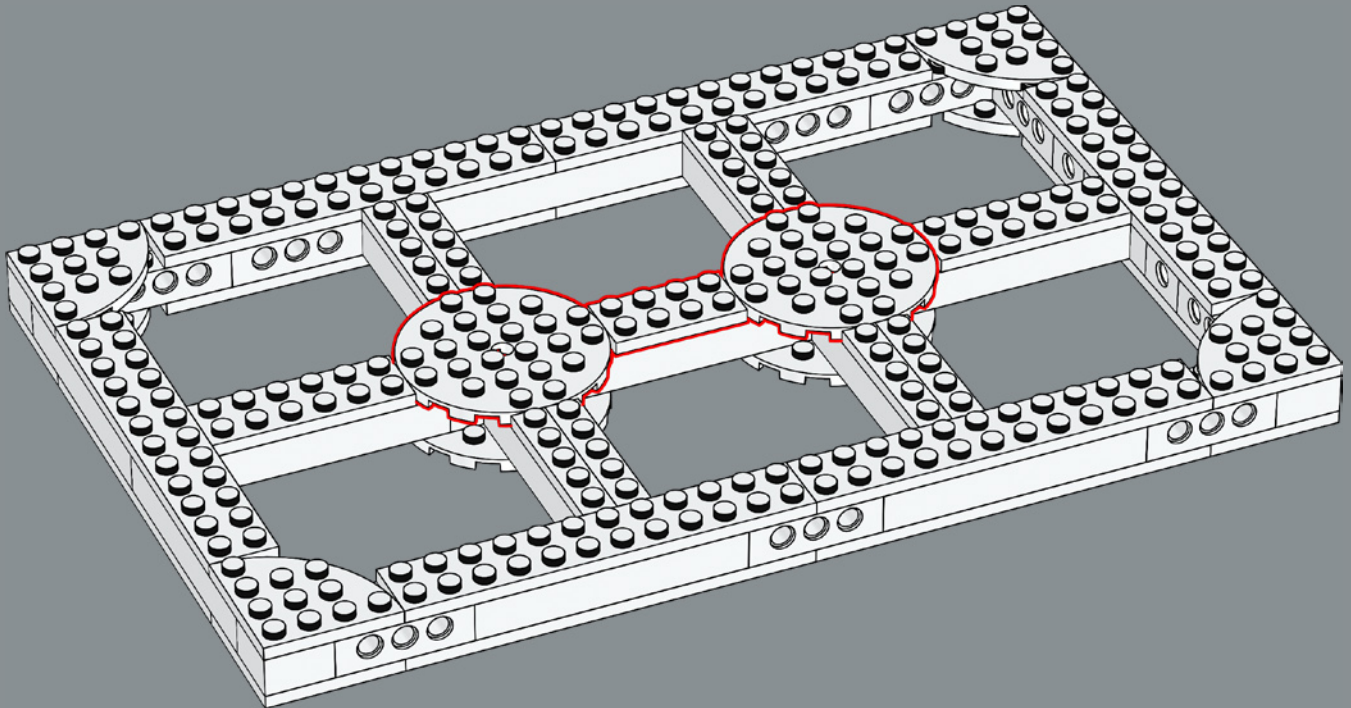



15

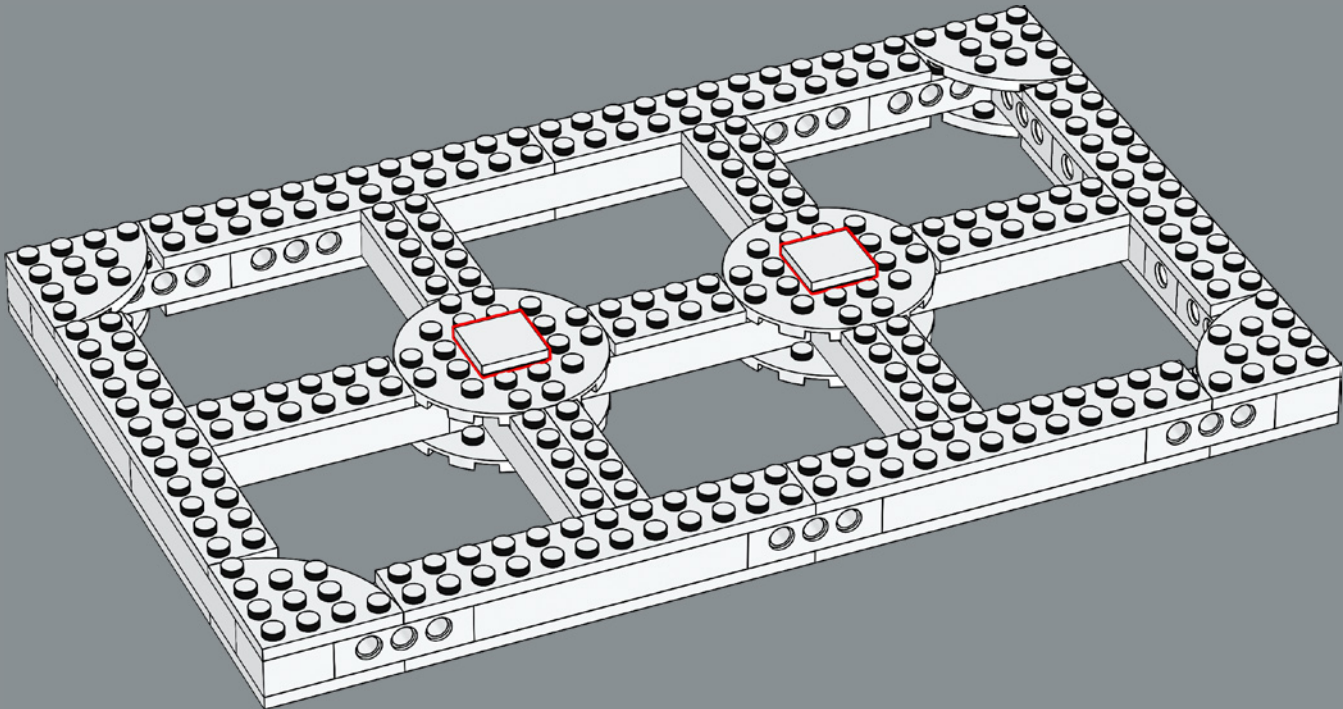

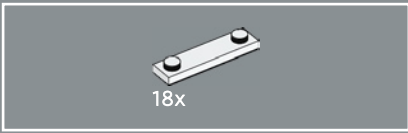

16

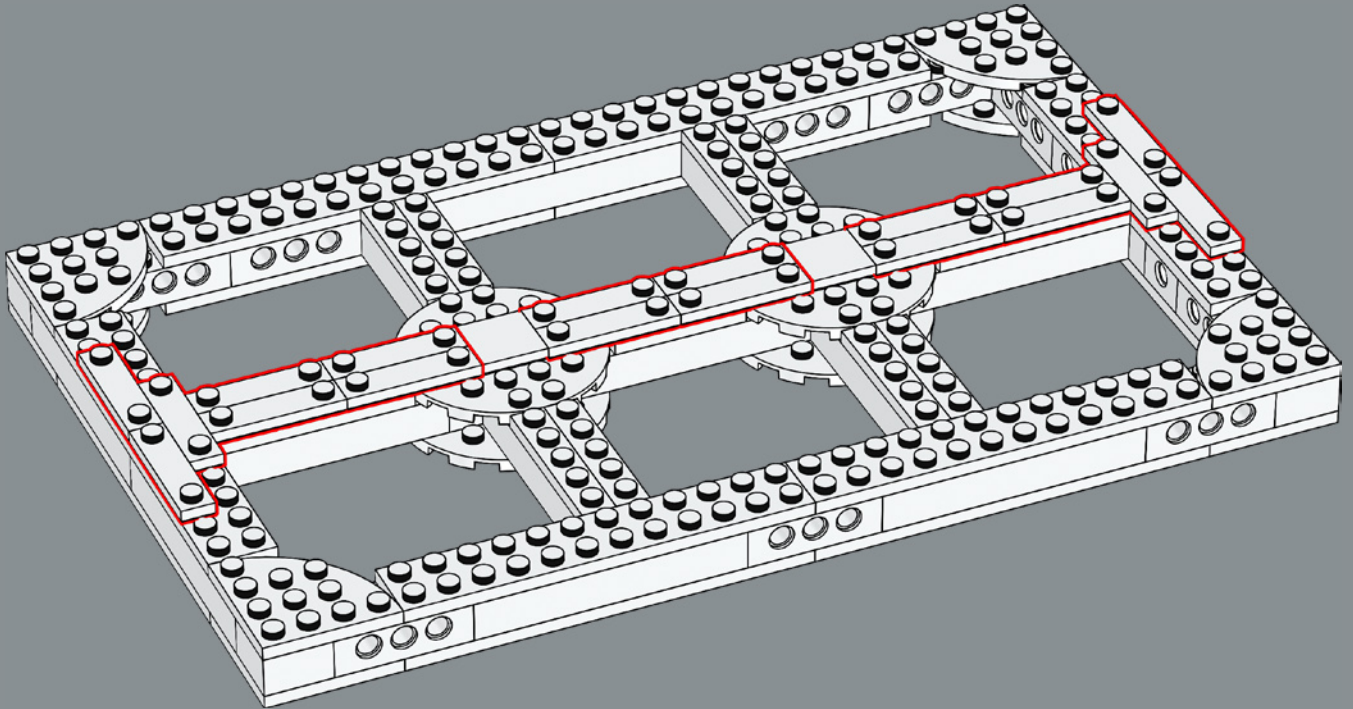

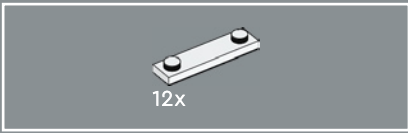

17

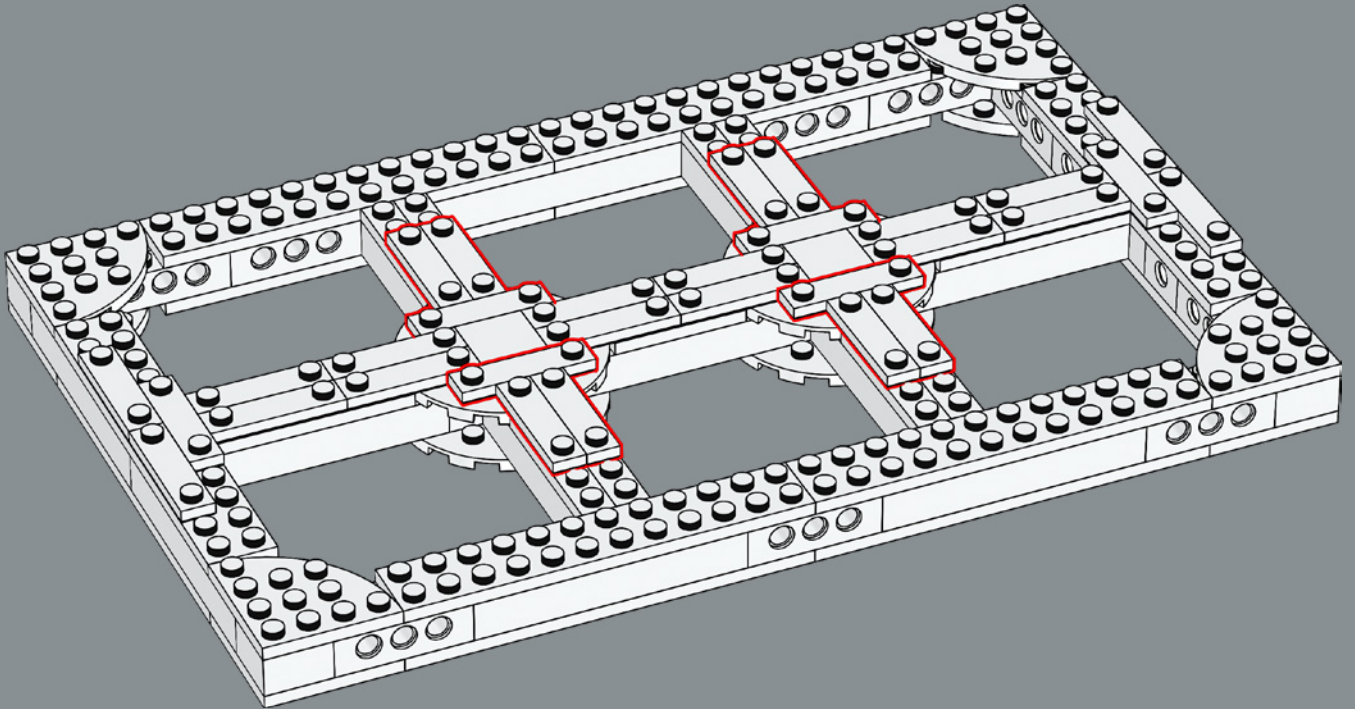

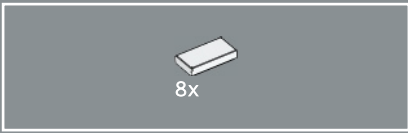

18

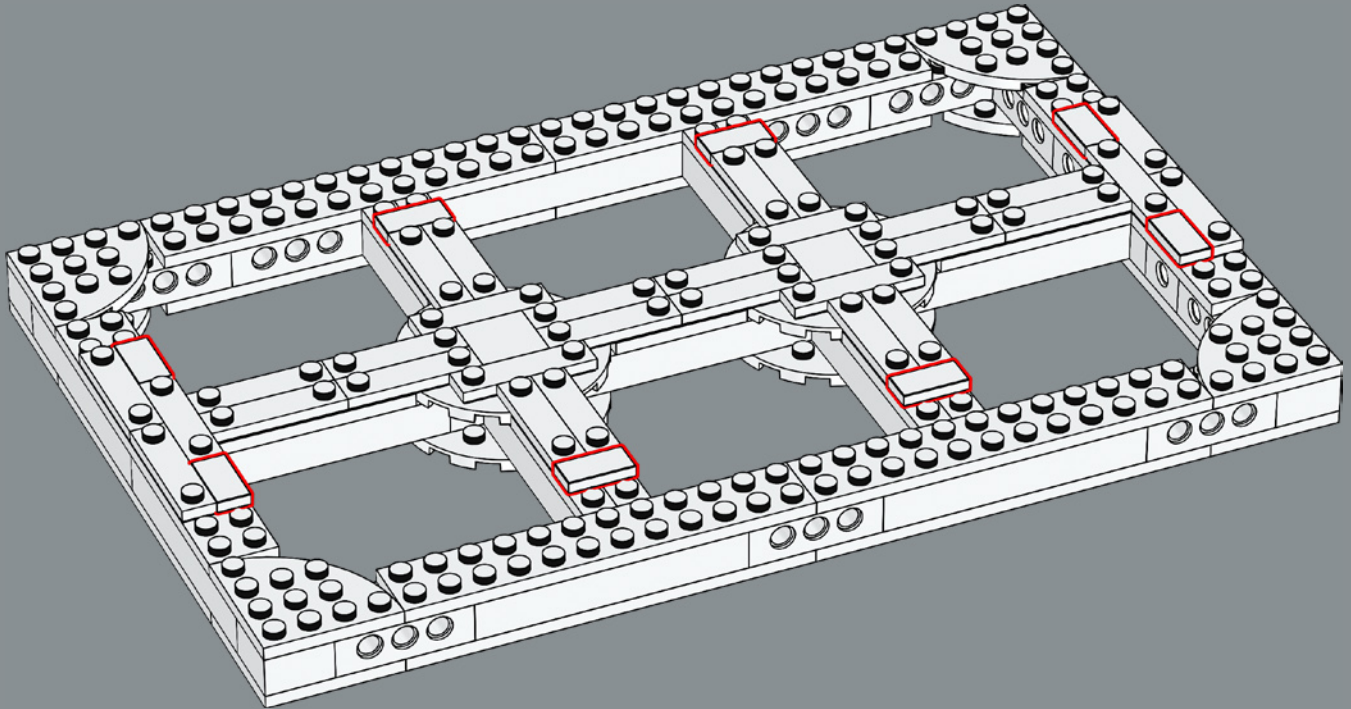

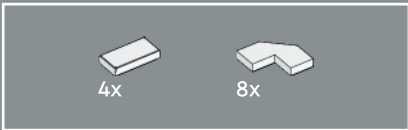

19

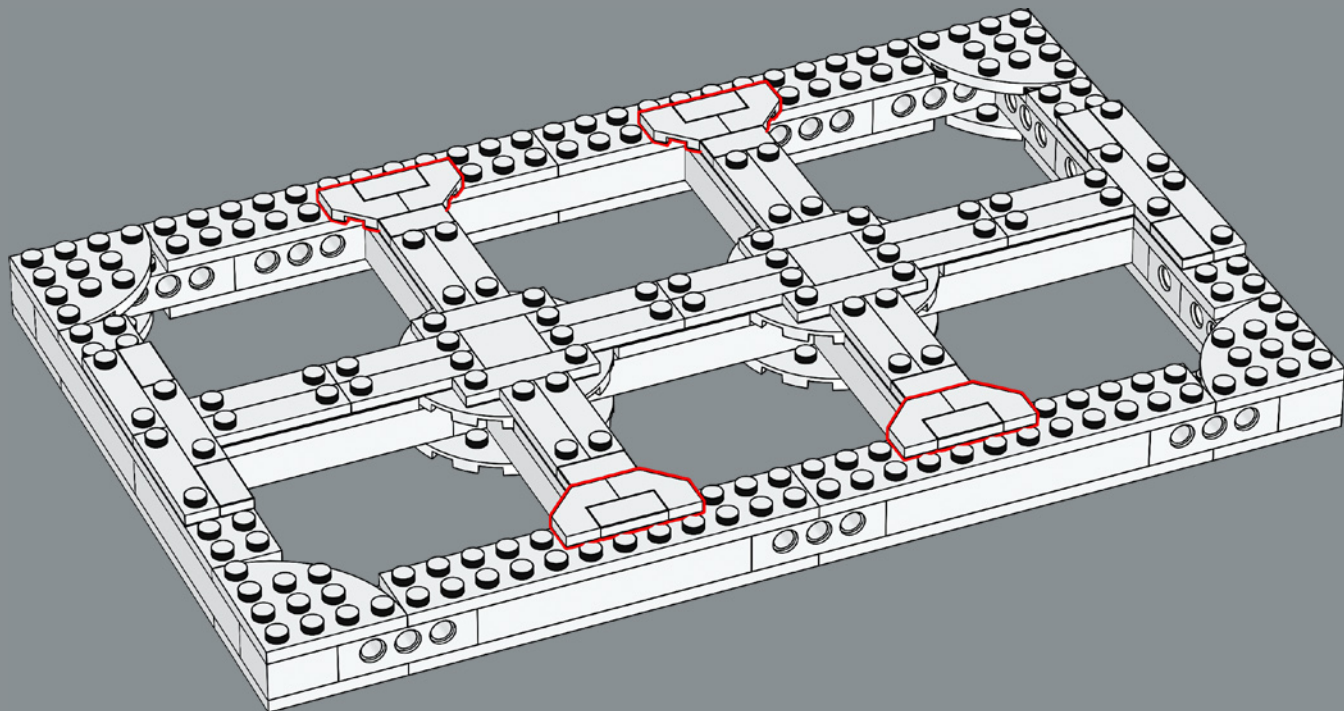



20

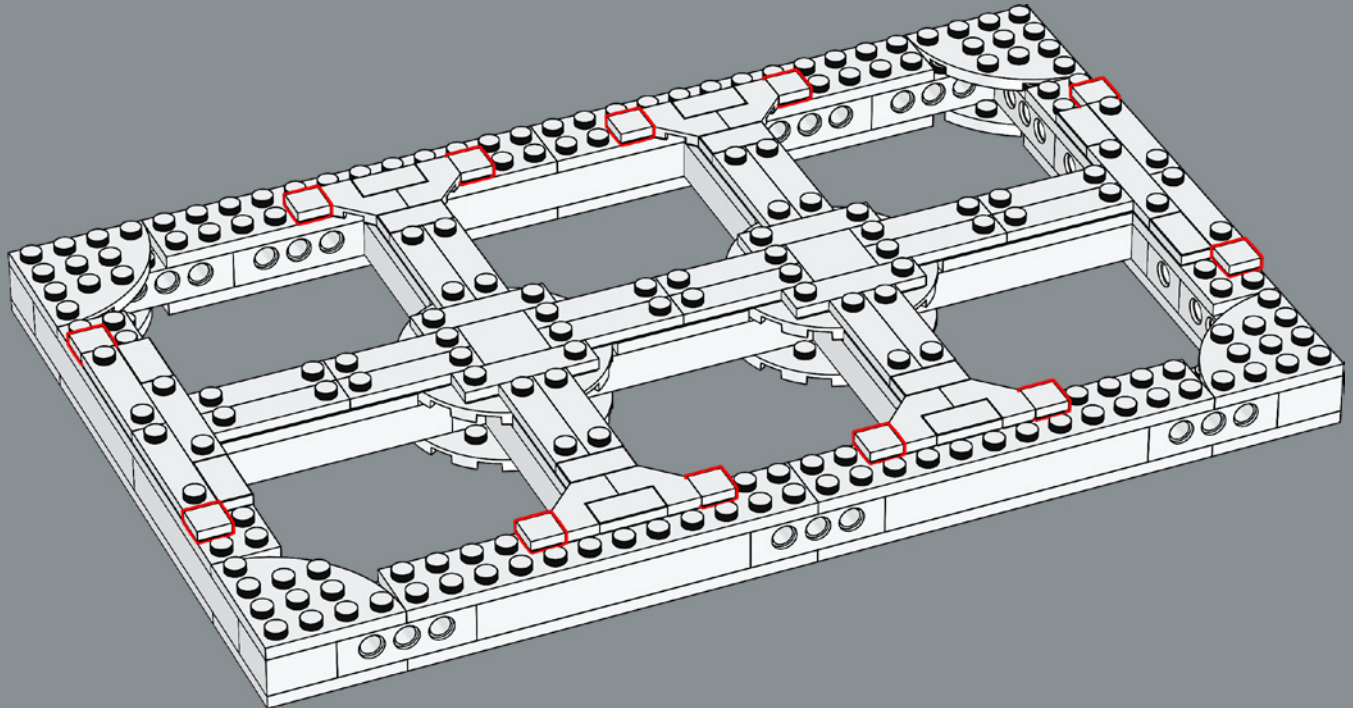

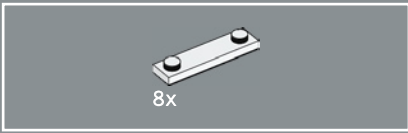

21

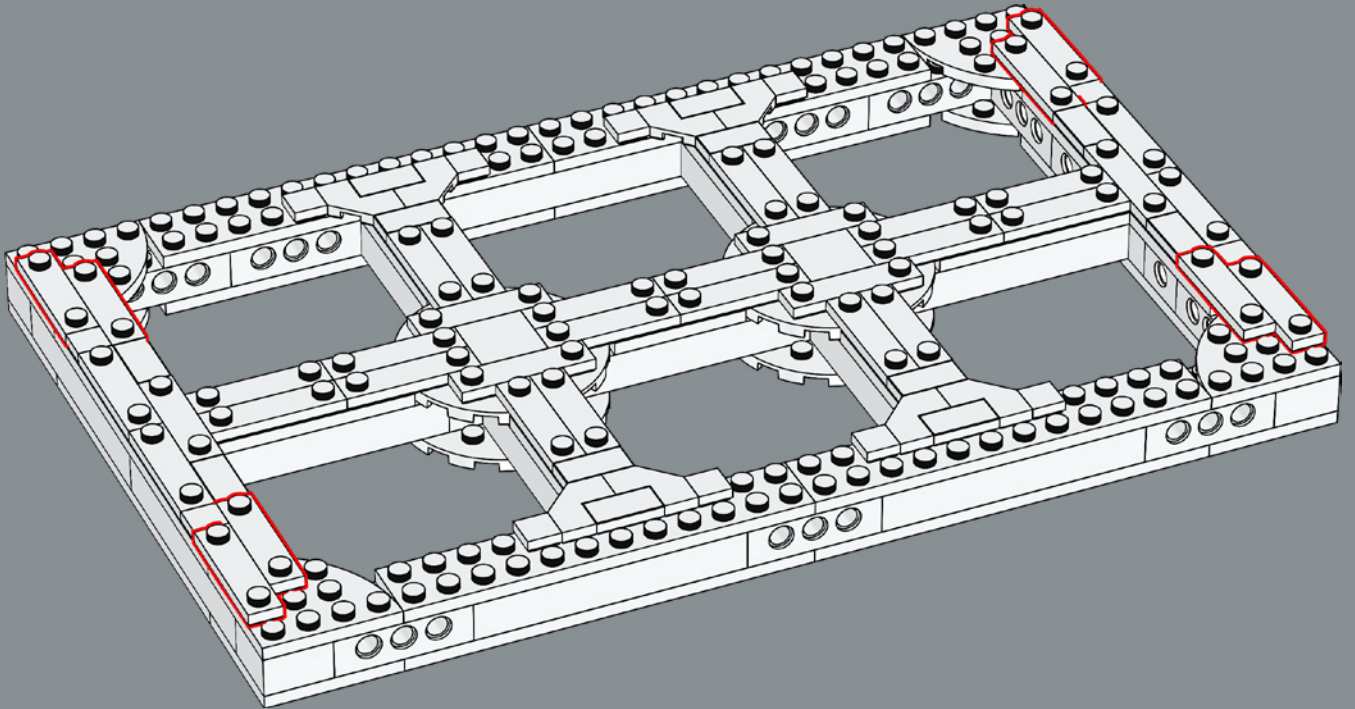

8x

22

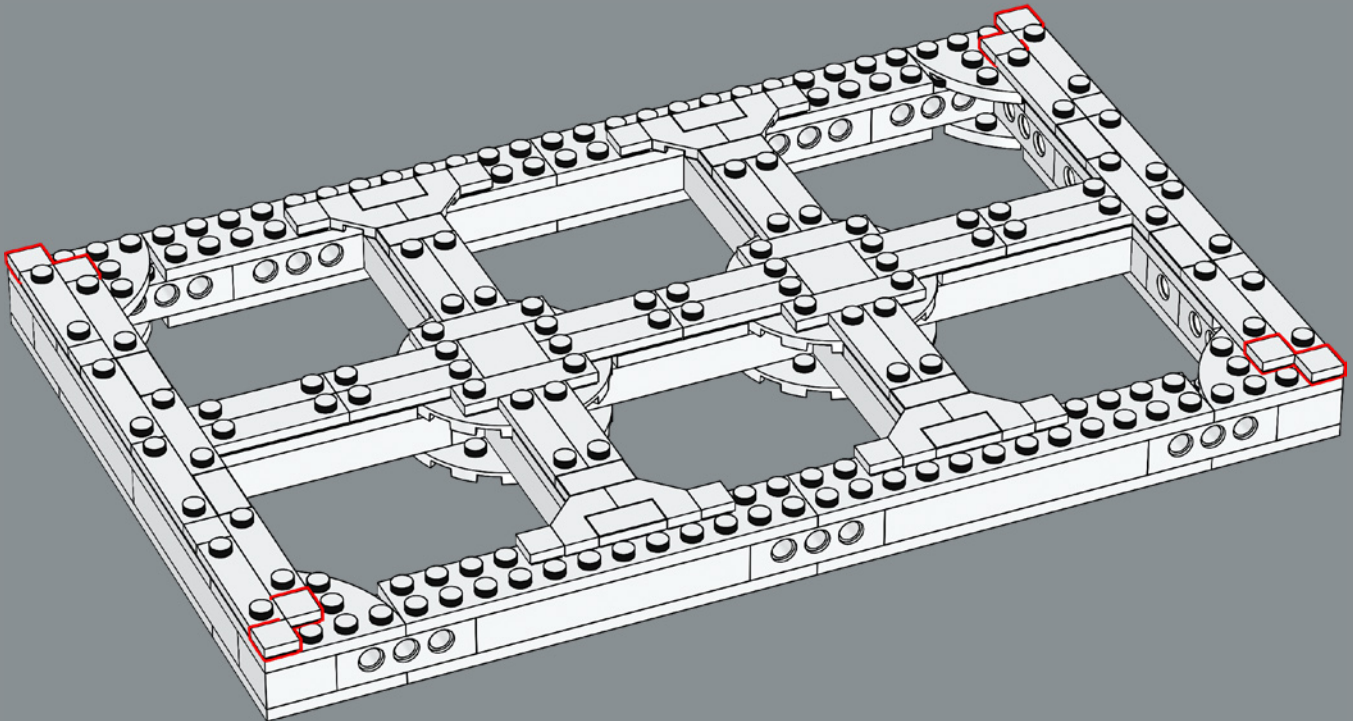

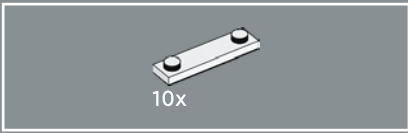

23

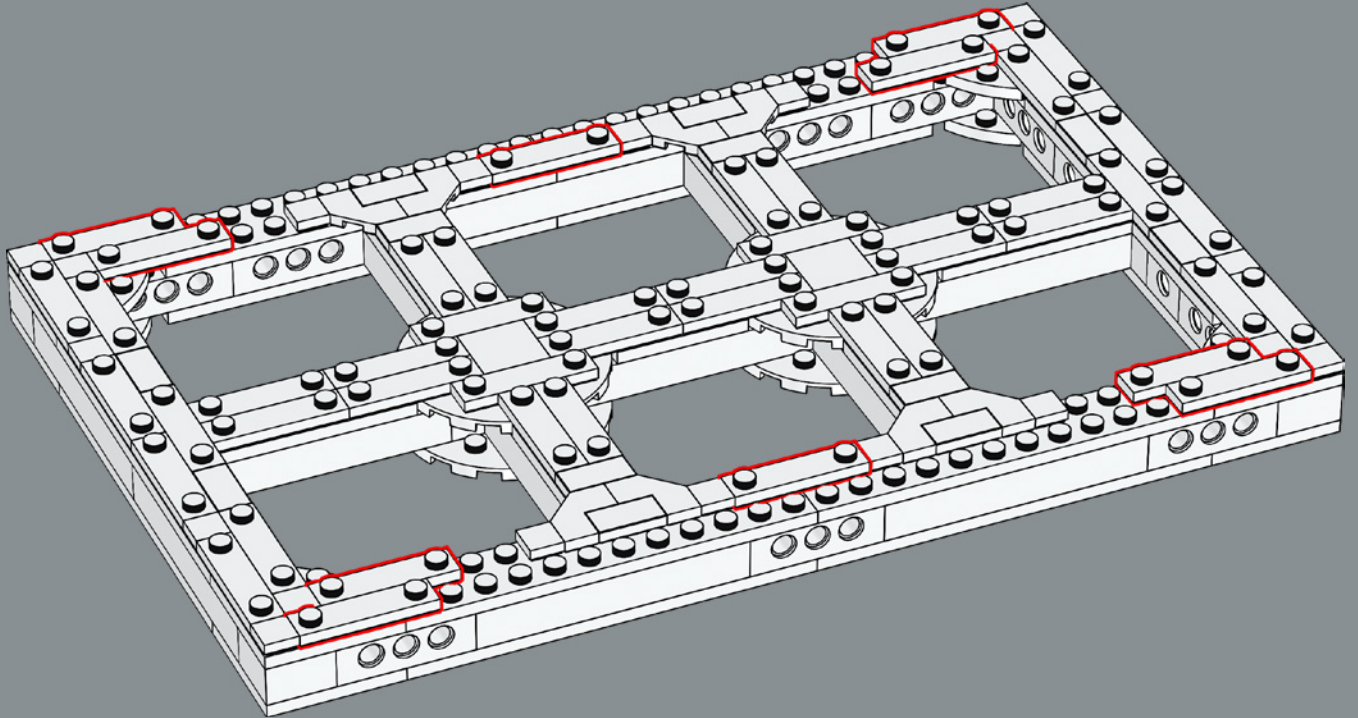

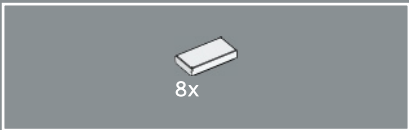

24

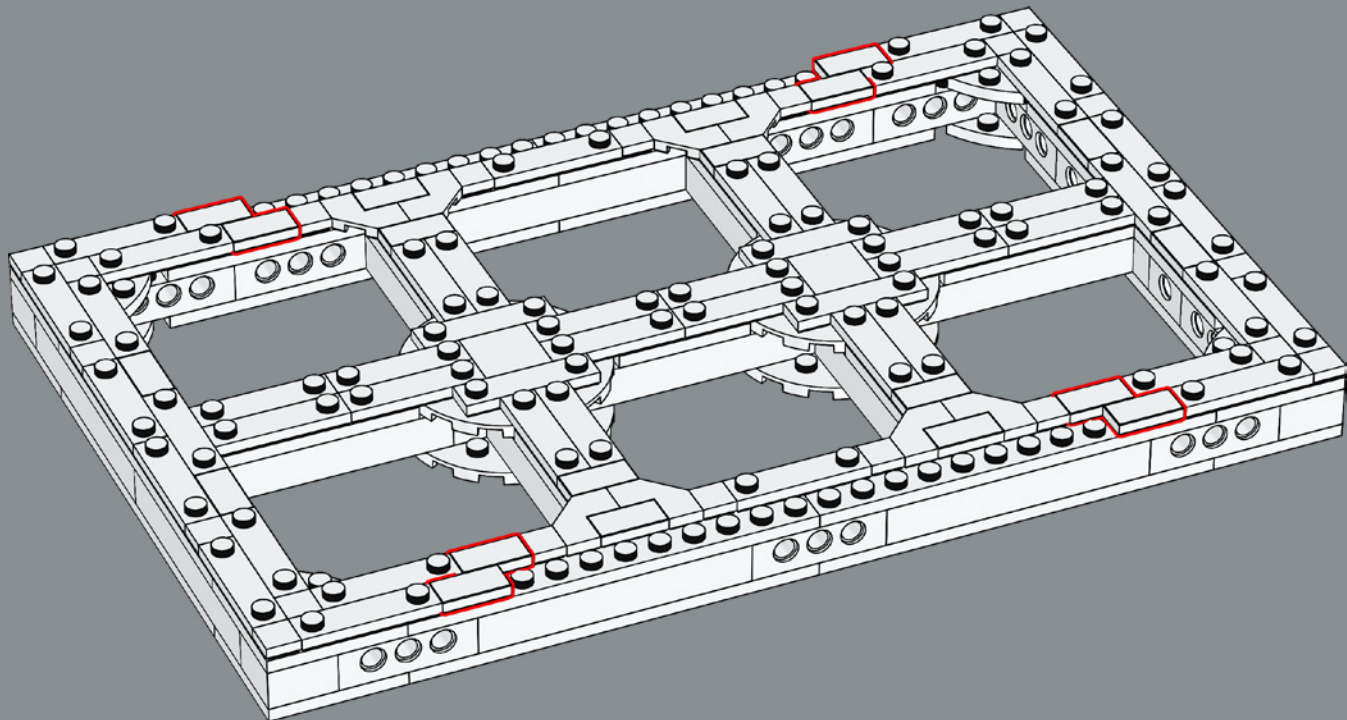

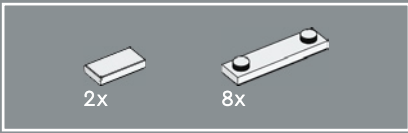

25

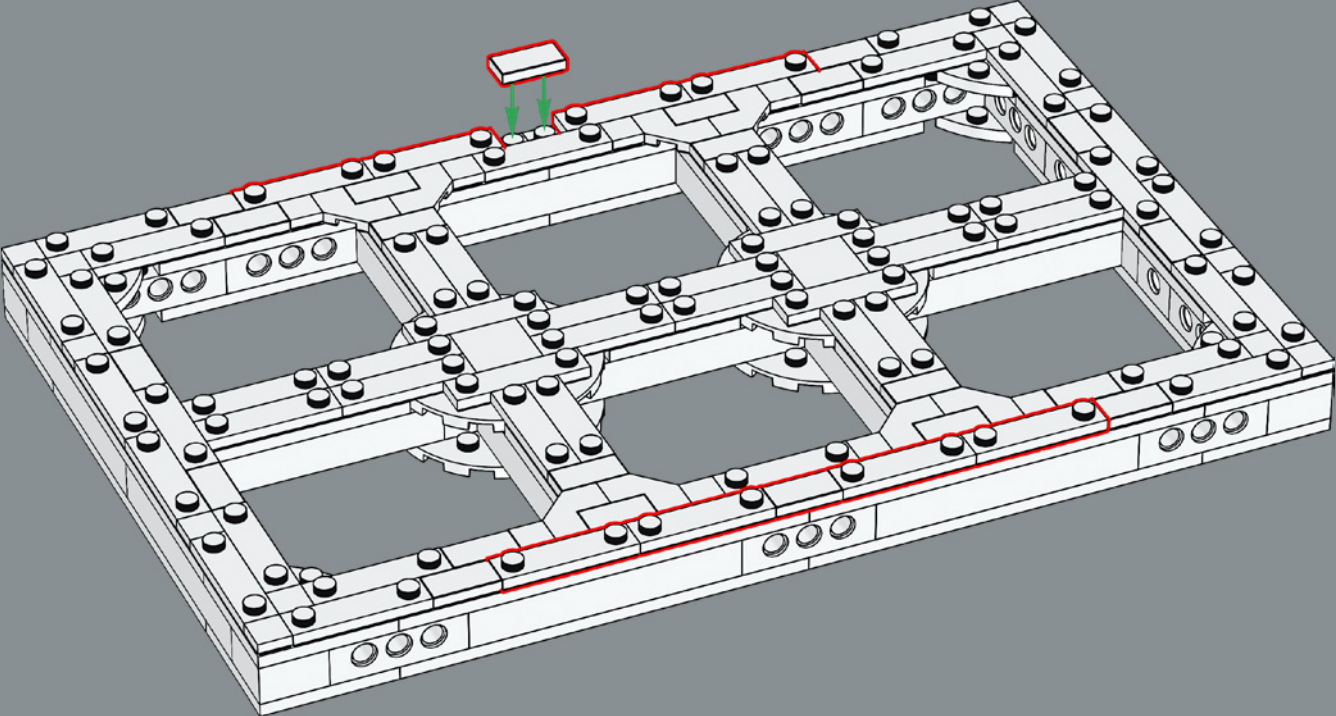



26

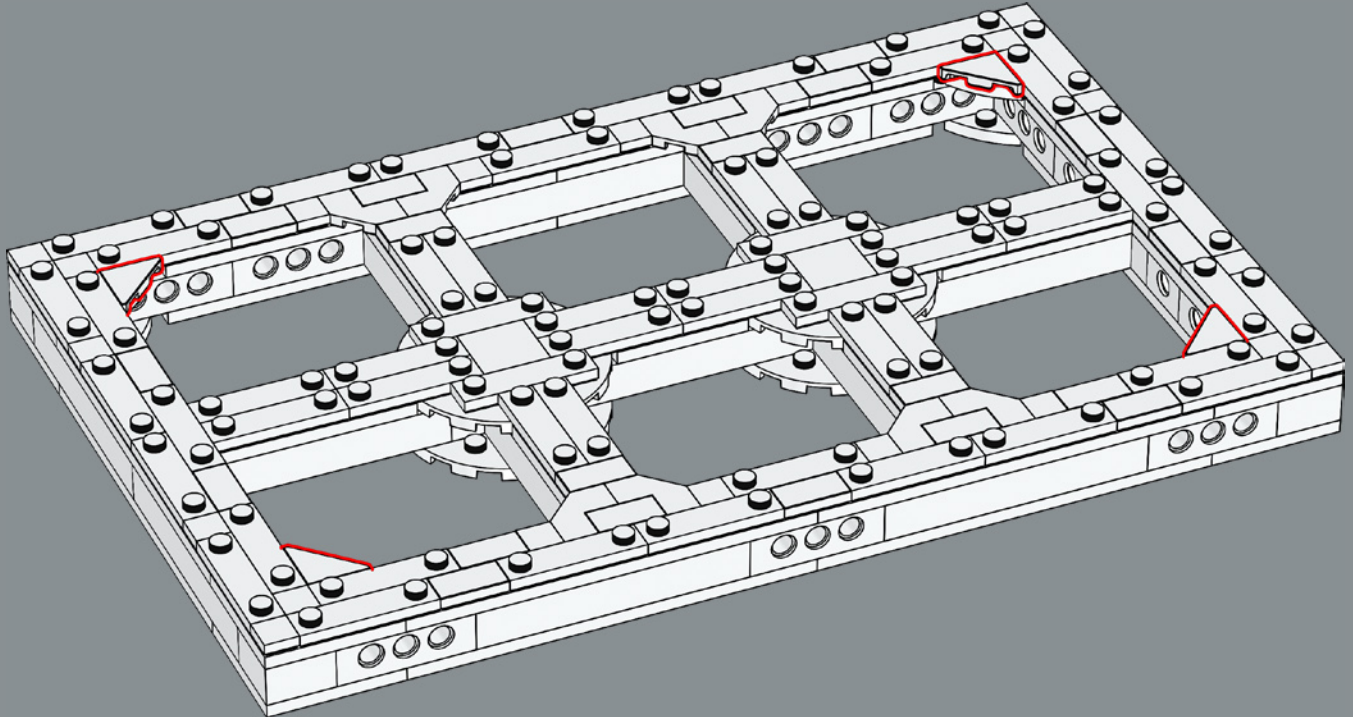

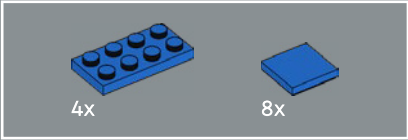
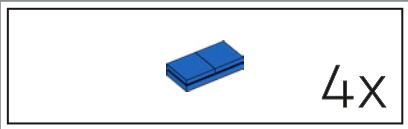
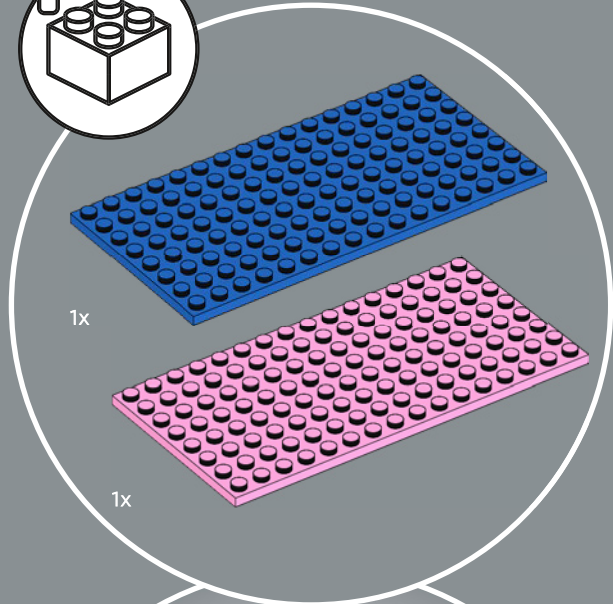
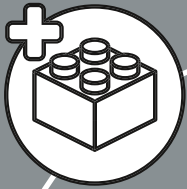

27

1

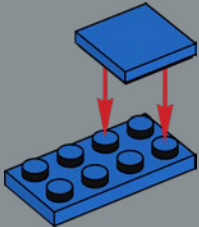

2

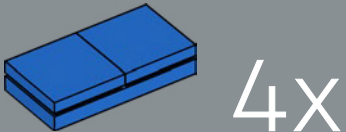

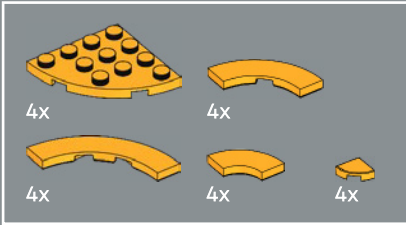
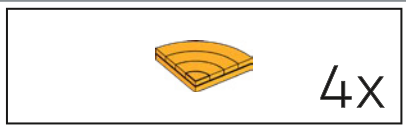

28

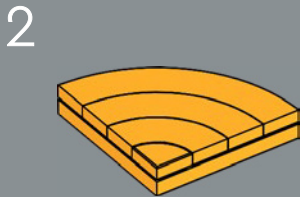
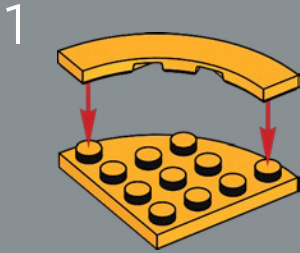

4x

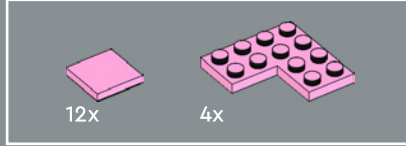
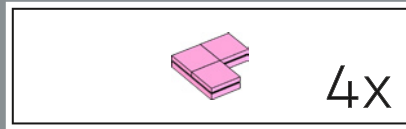

29

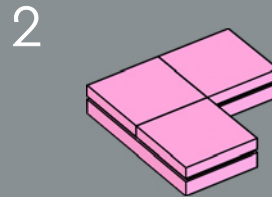
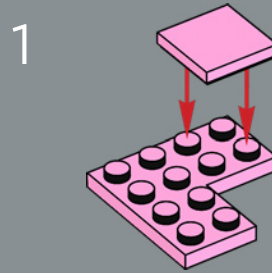

4x

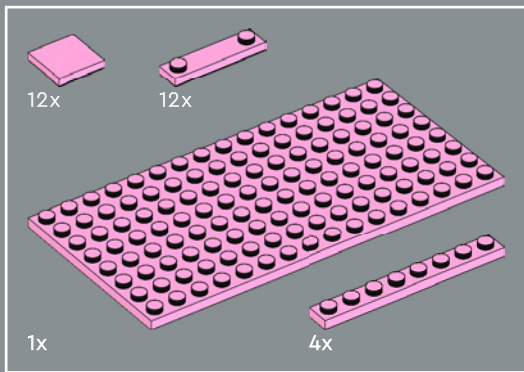

30

1

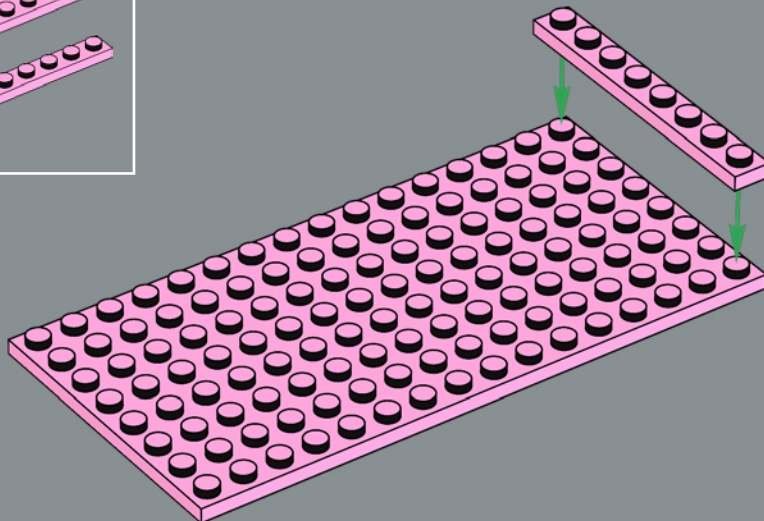

2

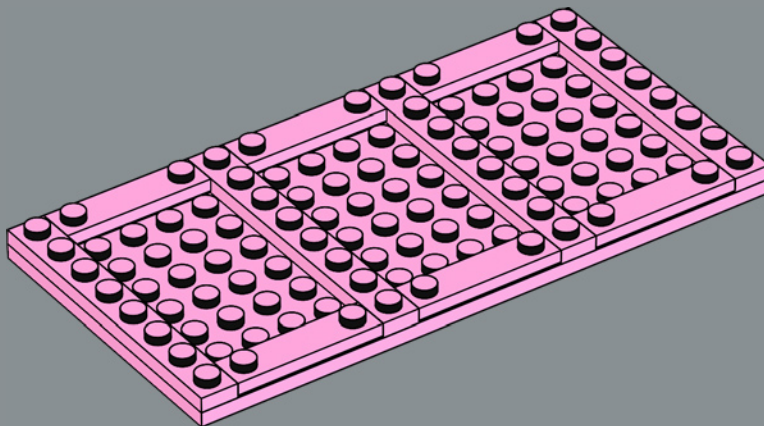

3

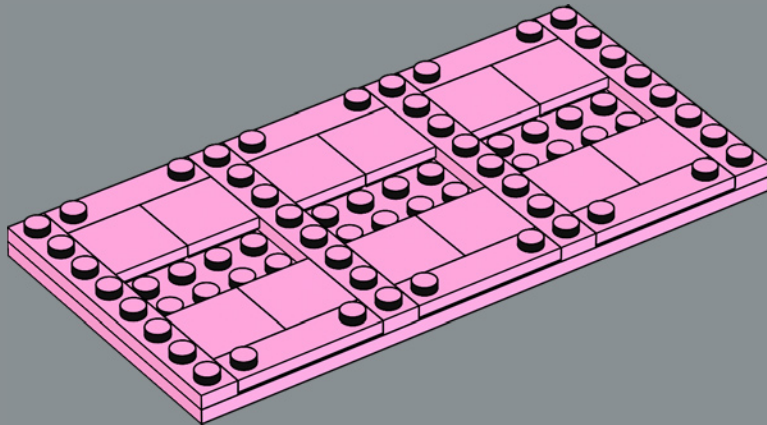

4

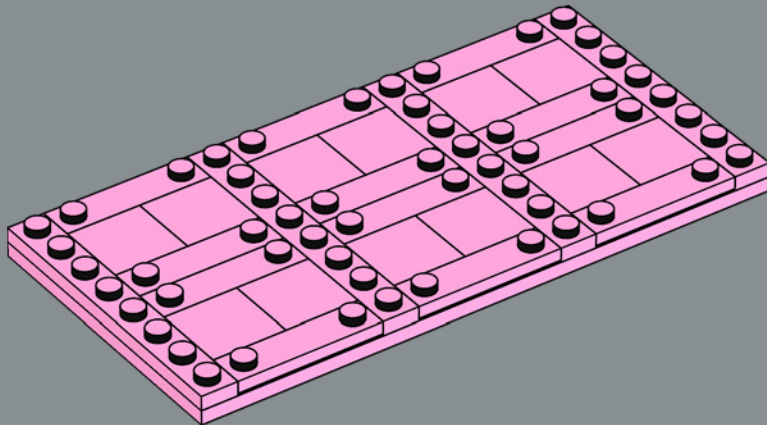

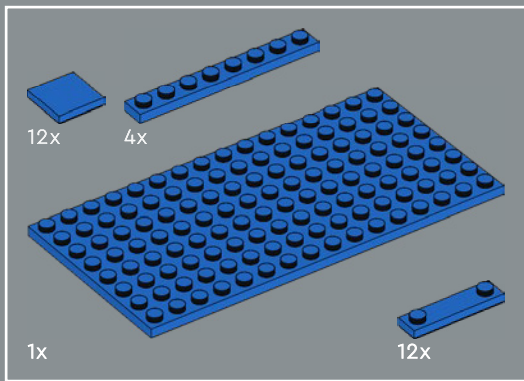

31

1

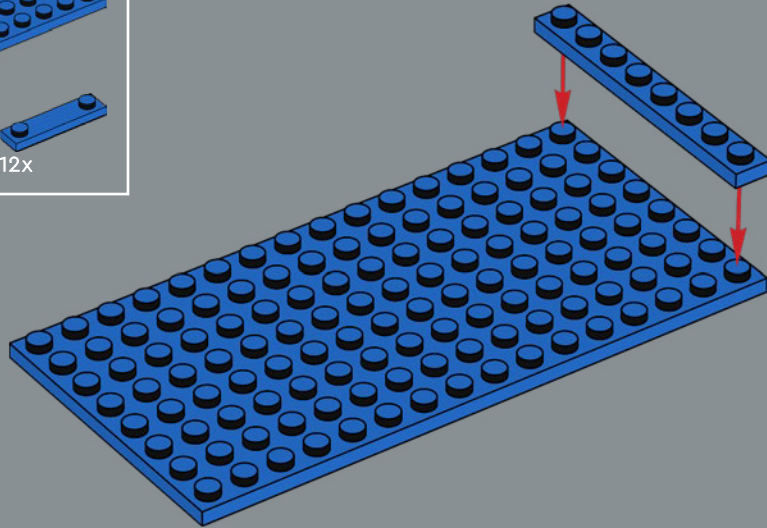

2

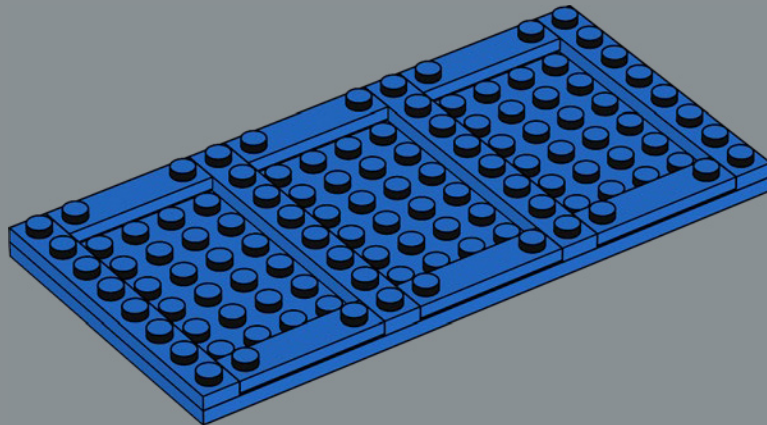

3

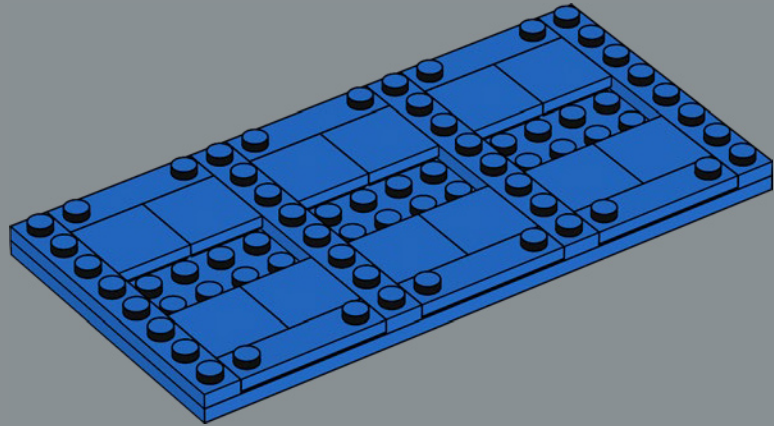

4

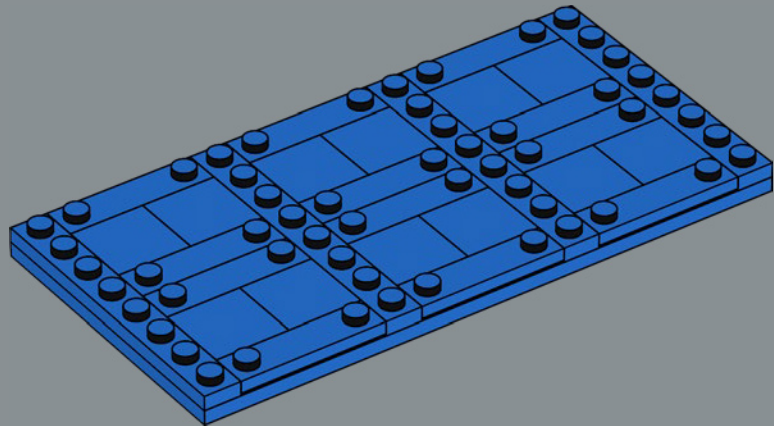

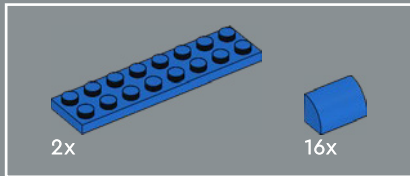
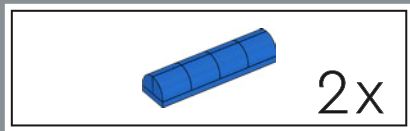

32

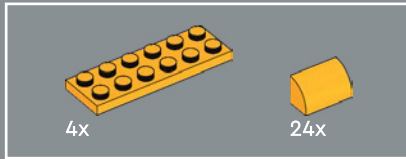
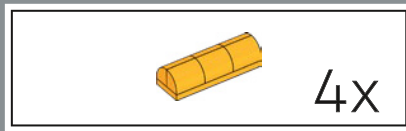
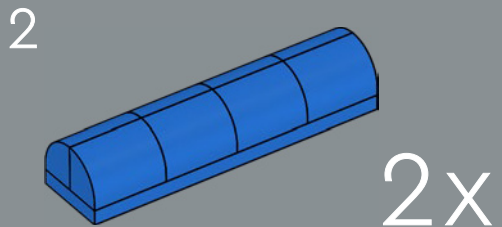
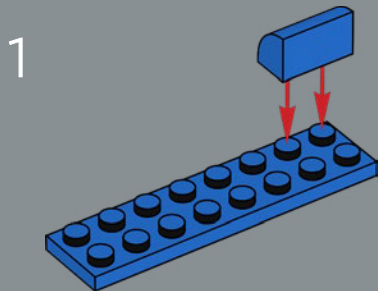

33

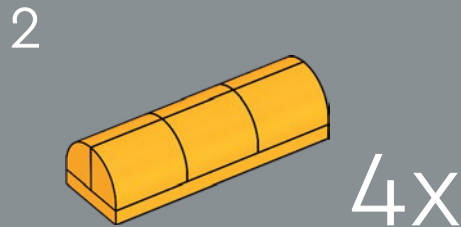
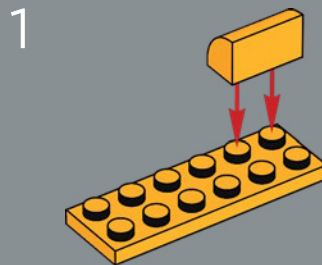

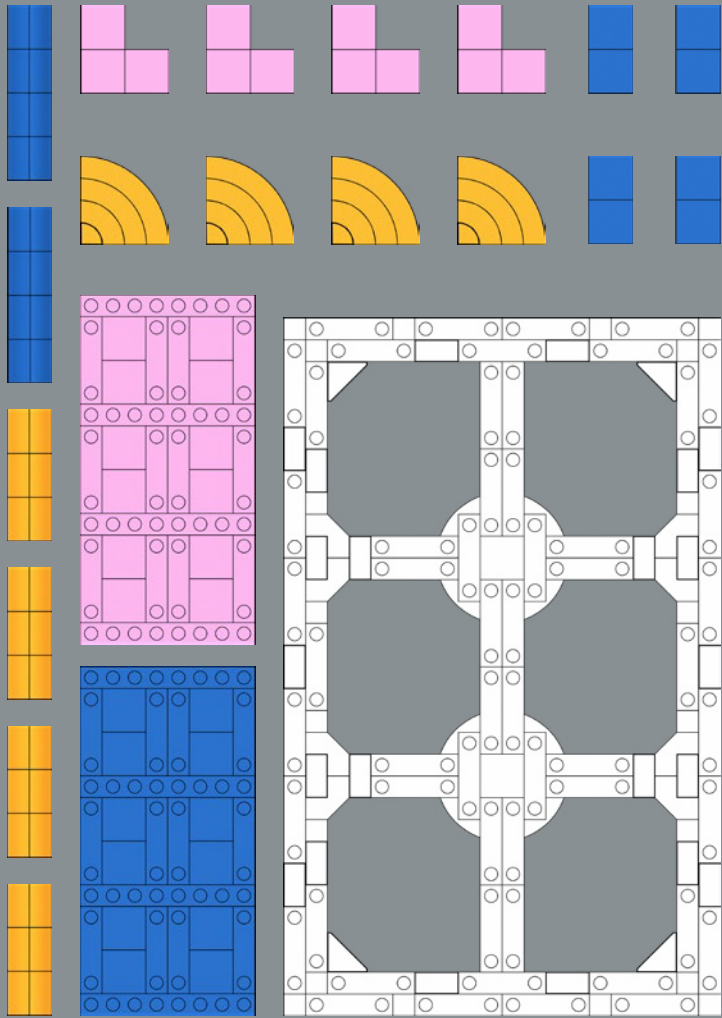

BALANCE

● Every element in your composition has a **visual weight**. By arranging elements symmetrically, or according to the **Rule of Thirds**, you can create a feeling of equilibrium.

Look for these elements in your set to help you explore this principle.

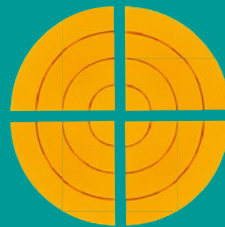

Citrus slice



Tube

Chip

Corner chip

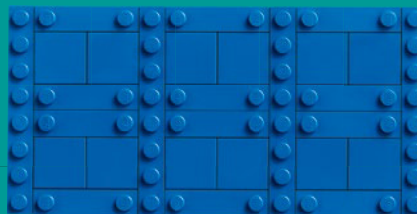
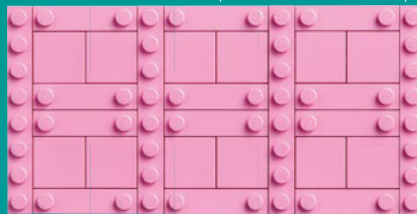

Platform



Tube

TIP THE SCALES!

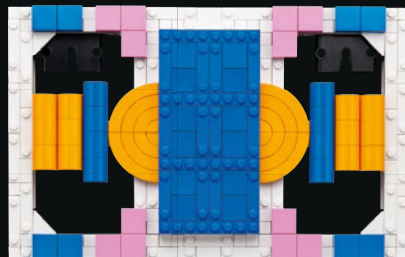
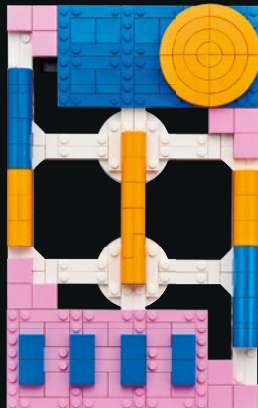
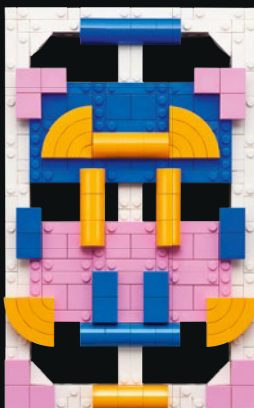

- What happens to the balance in your artwork when you shift your elements around between the top, bottom, sides and centre within the **Rule of Thirds** principle?

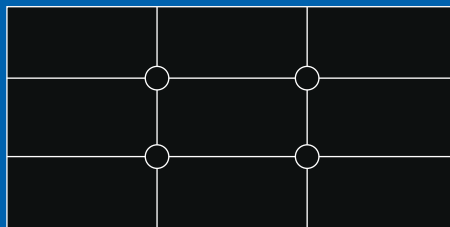
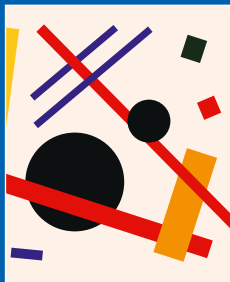

CALM OR FUN DISRUPTION?

- Unbroken, stable **Horizontal or Vertical Lines**, as well as placing "weight" in the **lower two-thirds** of your composition help create stability and calm. Want a little more drama? Add some disruption, tip the scales and find your own balance!



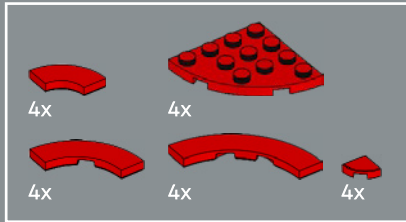
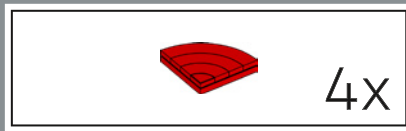

34

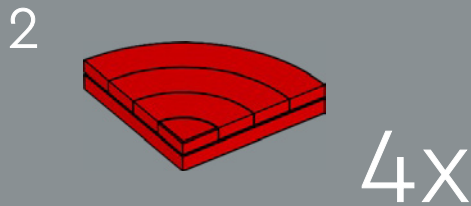
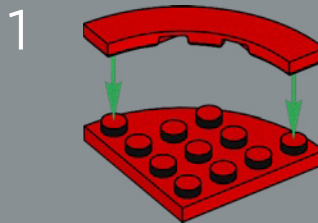

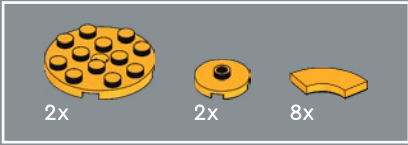
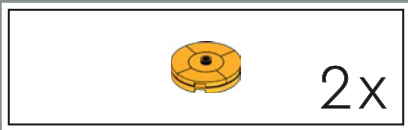

35

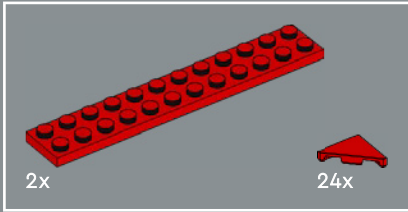
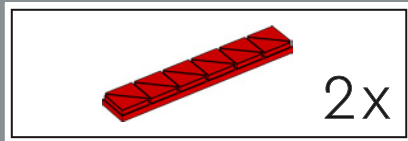
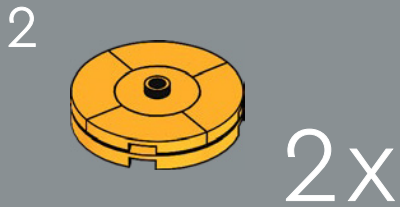
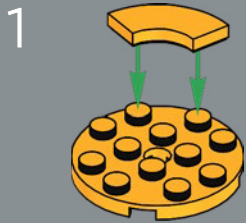

36

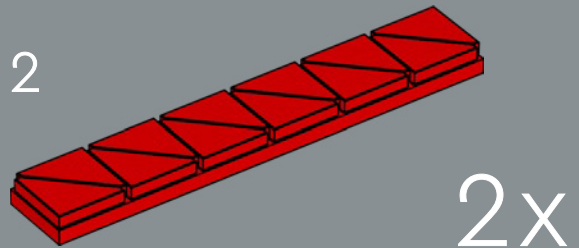
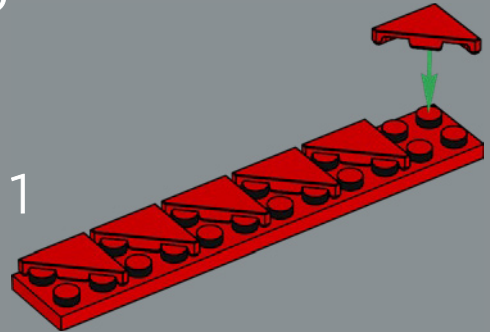

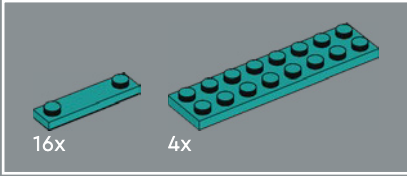
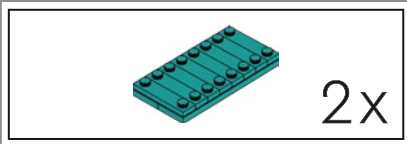

37

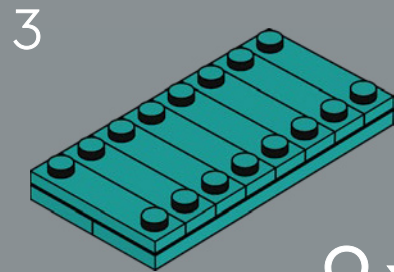
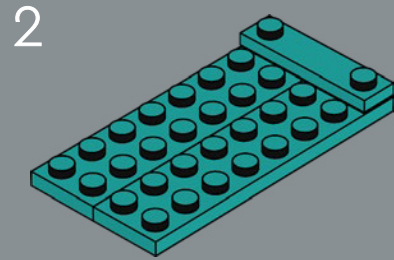
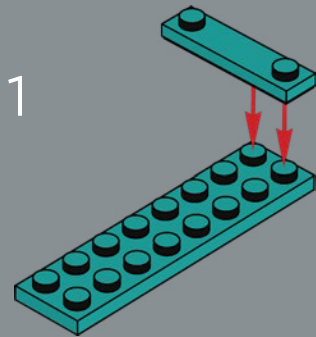

2x

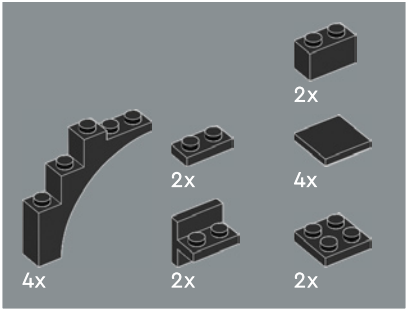
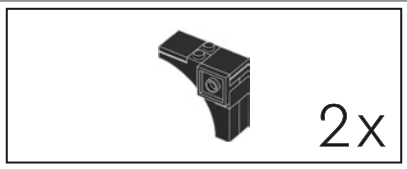

38

1

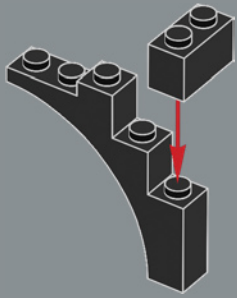

2

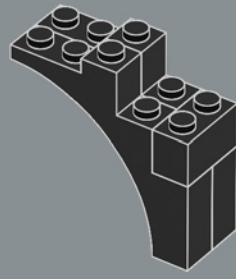

3

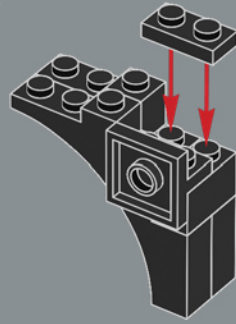

4

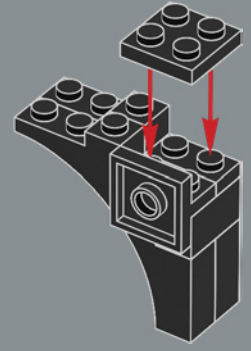

5

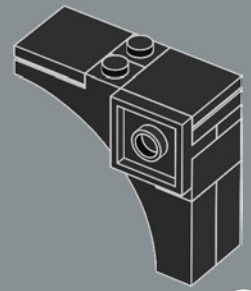

2x

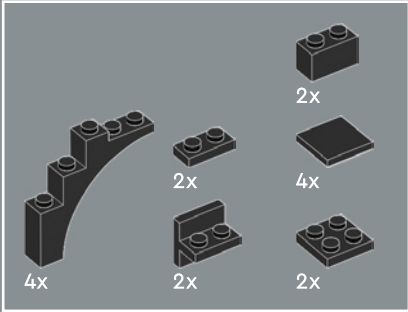
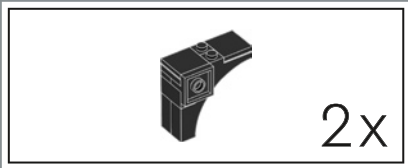

39

1

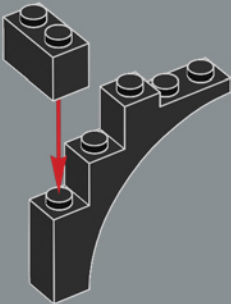

2

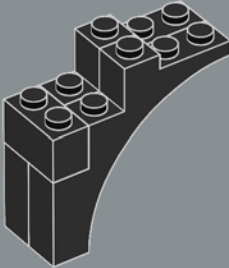

3

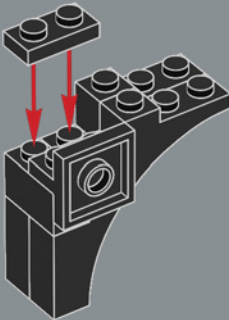

4

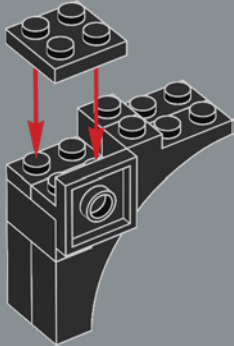

5

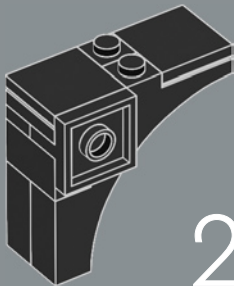

2x

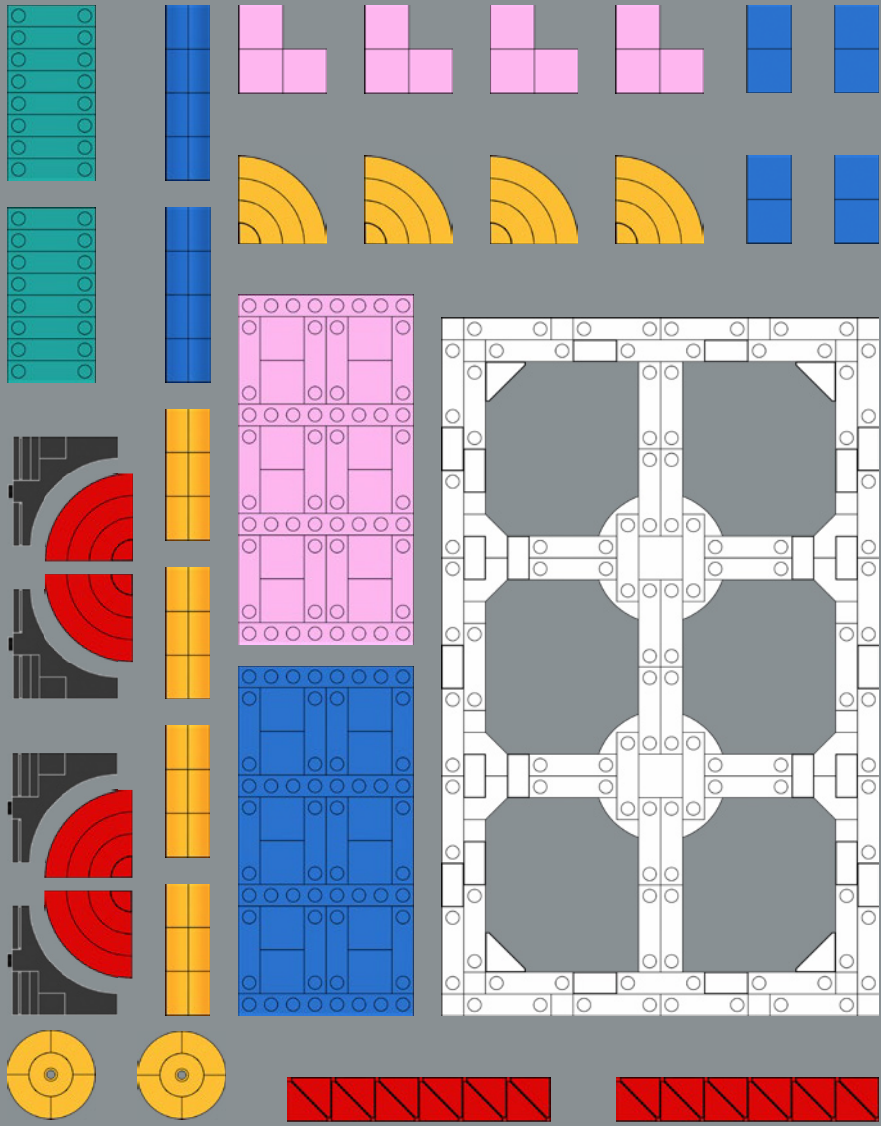

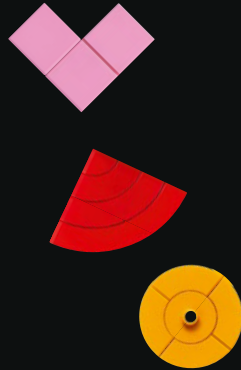
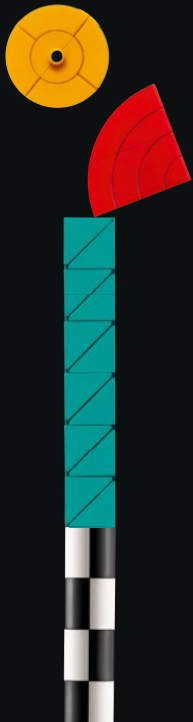

RHYTHM

● Repetition of shapes and colours create visual dynamics and tempo for the viewer's eye to follow. By making **Every Corner Unique**, you create a variety of interest points that brings the composition to life.

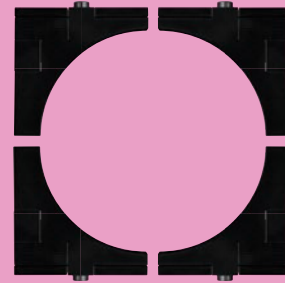

Half moon



Strip

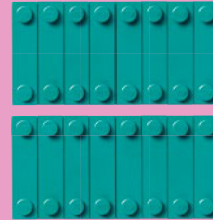

Paddle



Dot

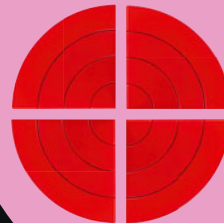

Tomato slice



CREATING COHESION

- How do you apply the **Every Corner Unique** technique? Use the elements you have built and experiment with different shapes and colours to give your artwork a sense of cohesion. Use as many or as few elements as you like!



SHAPES AND SIZES

- Organic shapes help create flow, rhythm and maybe just the right amount of chaos in a composition, whereas geometric shapes usually create a more structured, calm expression. Play with the sizes of your shapes, too, if you want to draw attention to specific elements.

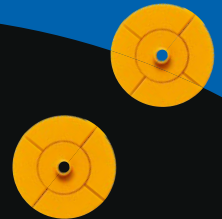

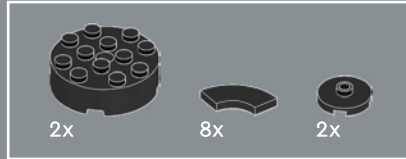

40

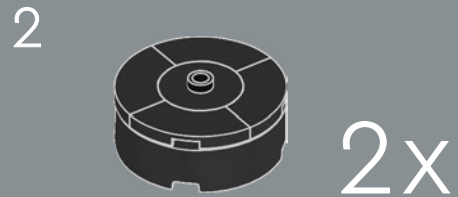
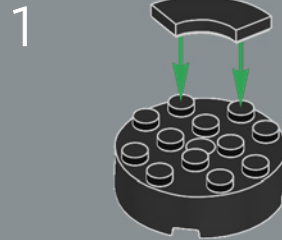

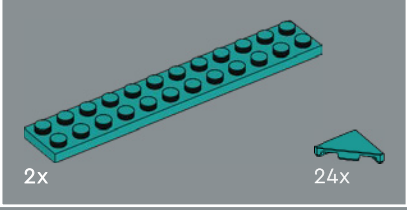
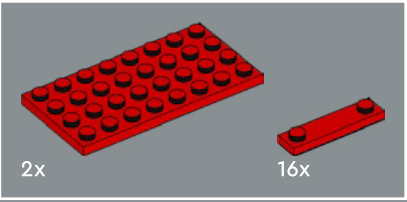
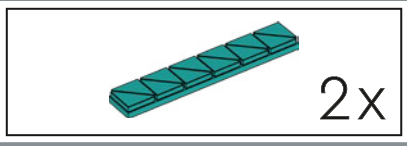
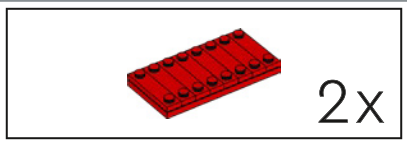

41

42

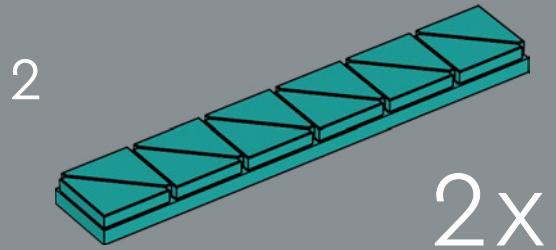
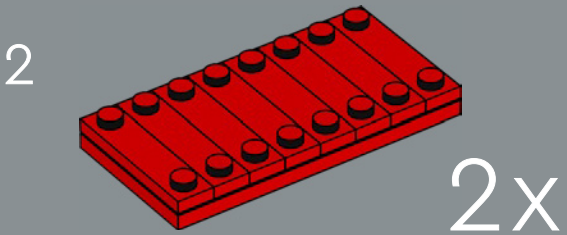
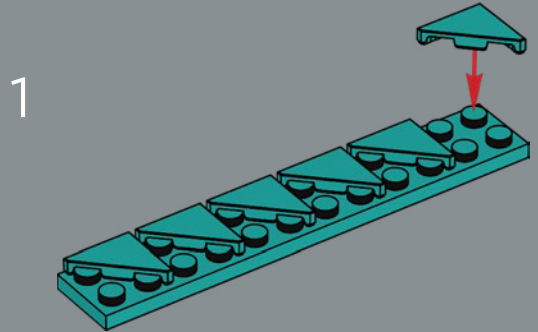
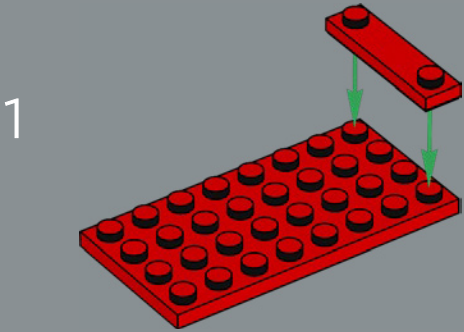

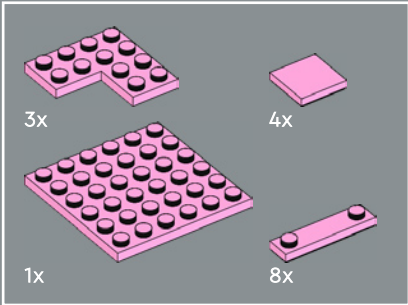
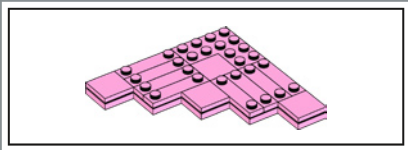

43

1

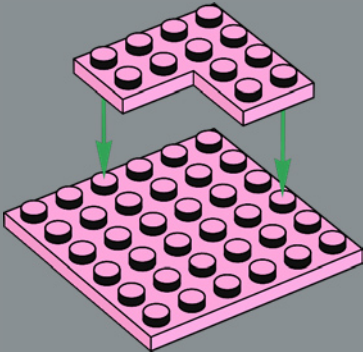

2

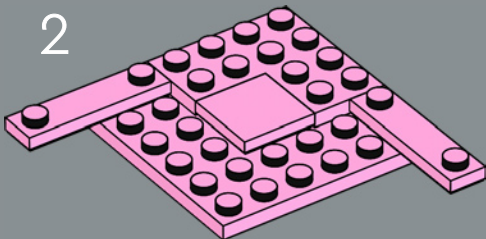

3

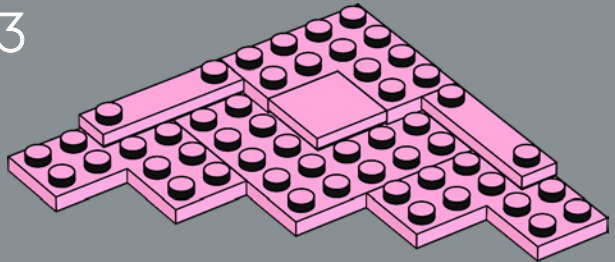

4

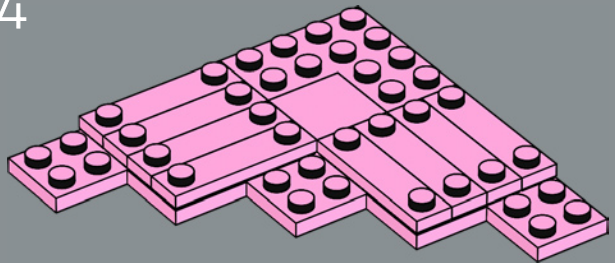

5

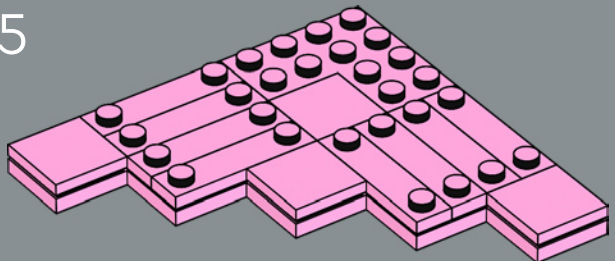

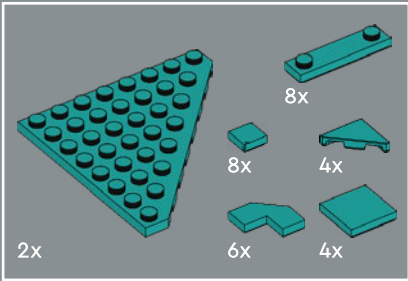
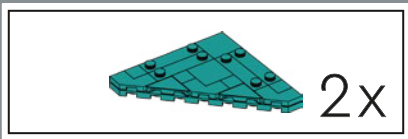

44

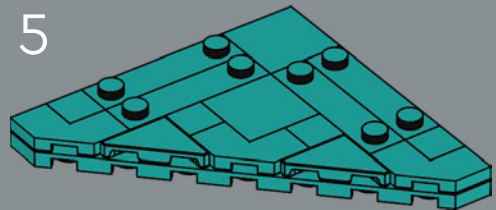
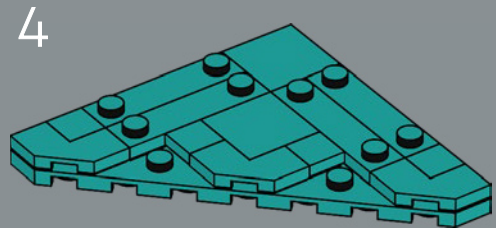
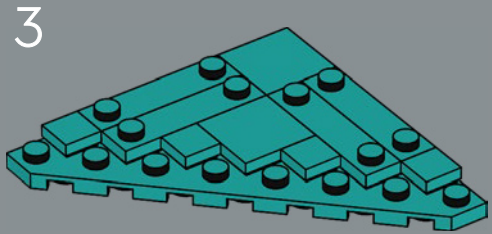
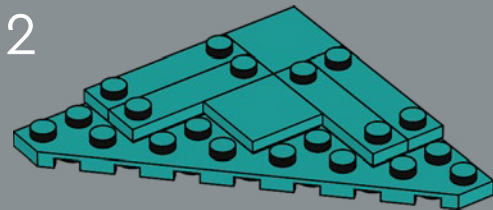
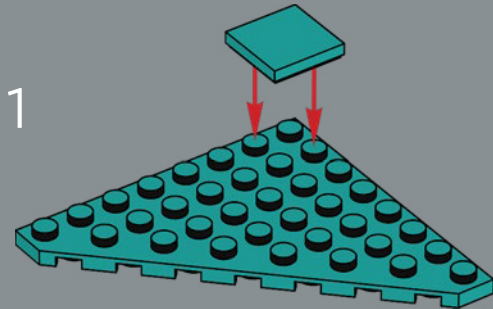

2x 63

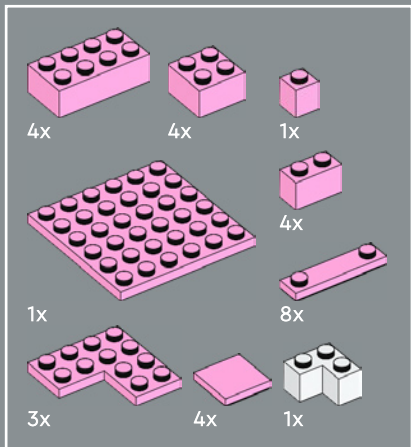
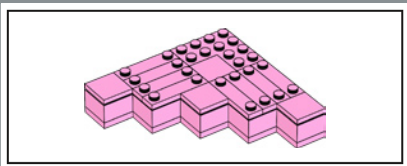

45

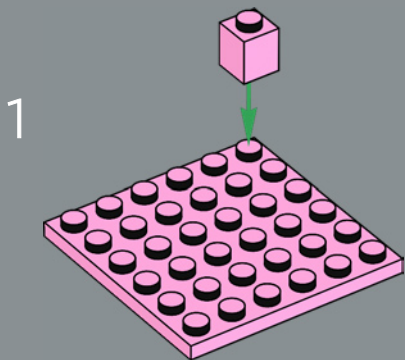

2

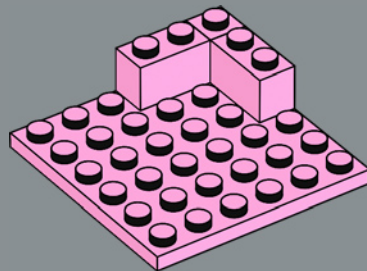

3

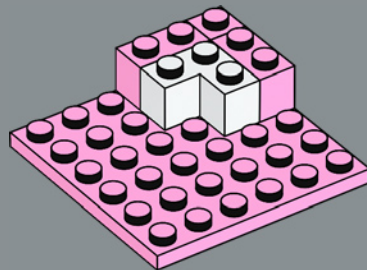

4

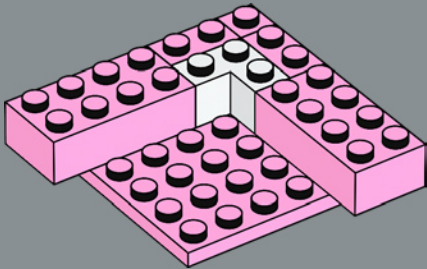

6

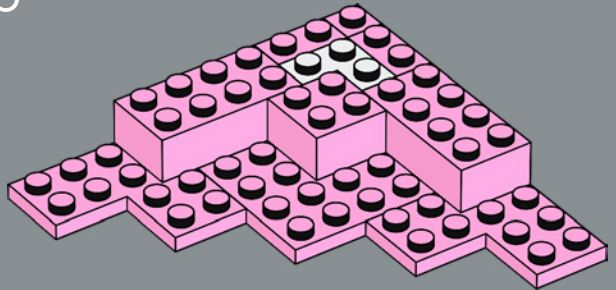

5

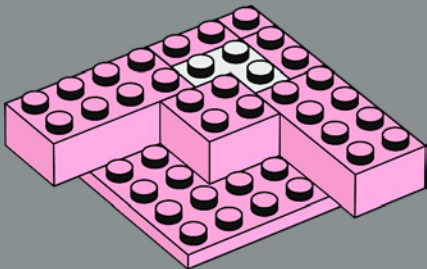

7

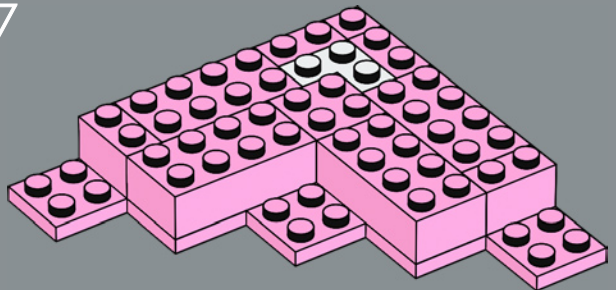

8

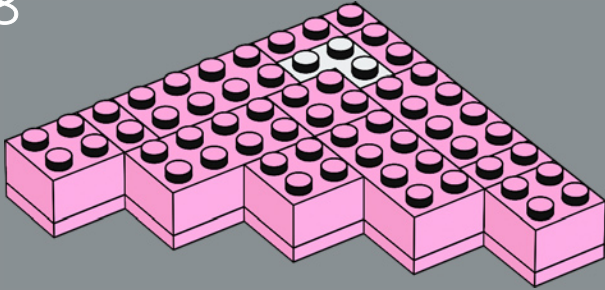

10

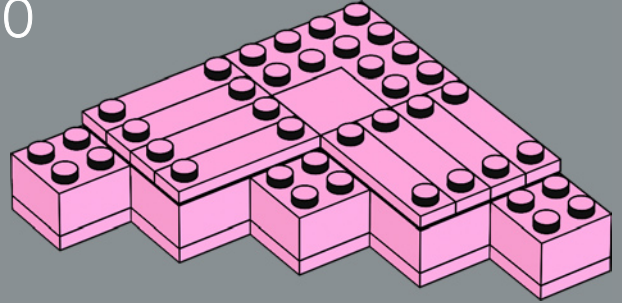

9

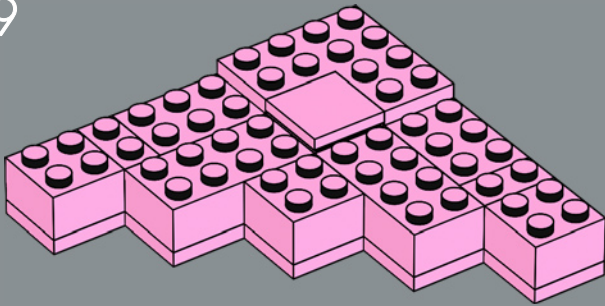

11

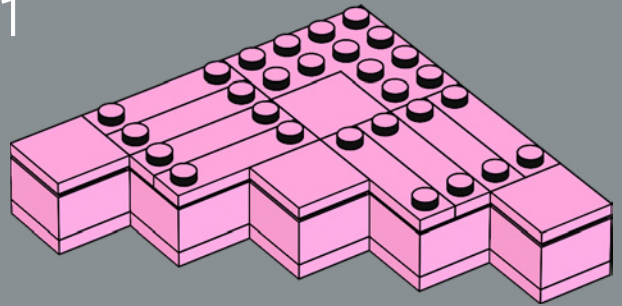

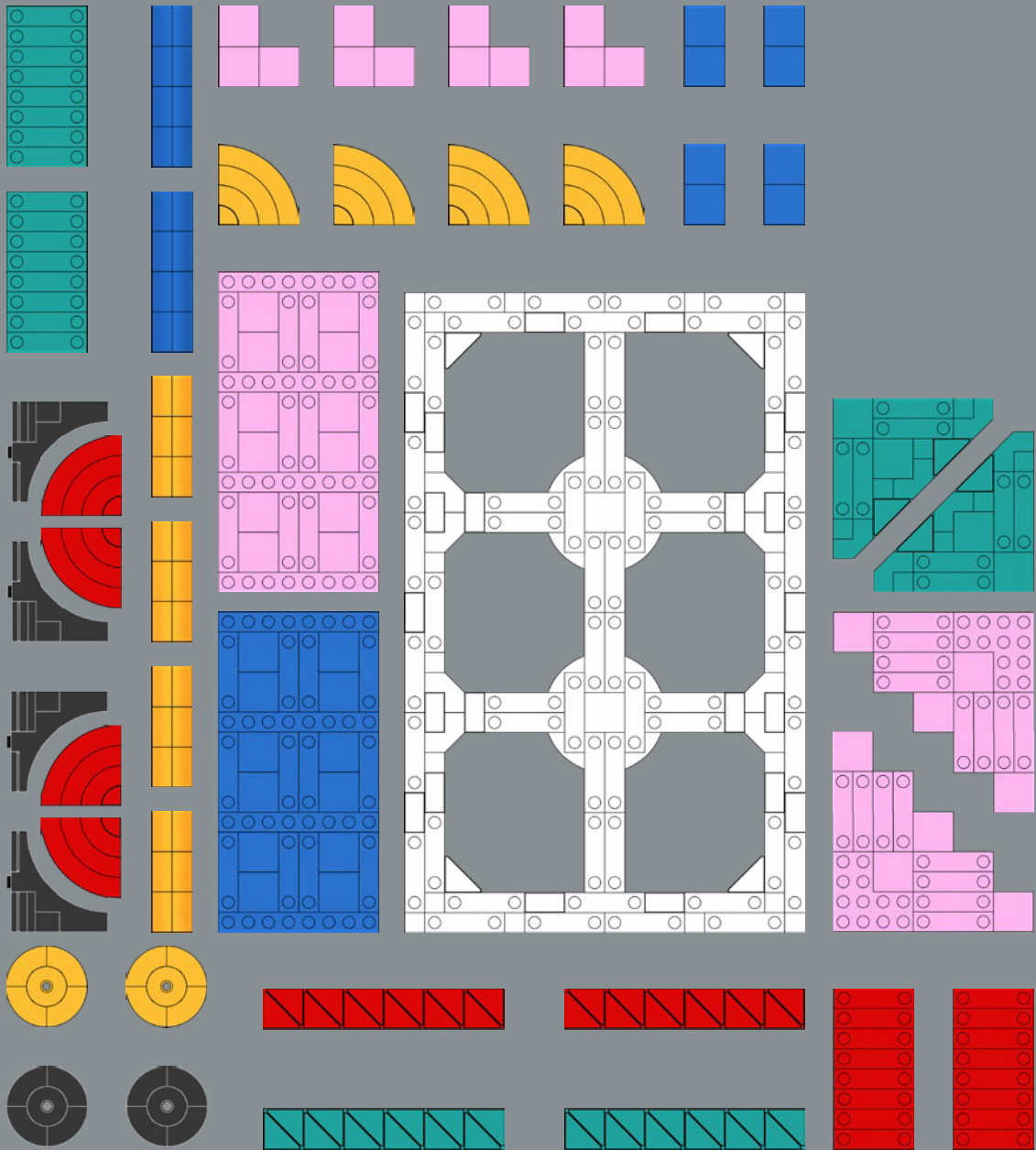

MOVEMENT

● Using your elements to create **Diagonal Lines** draws the viewer's eye and brings a sense of movement and direction to your artwork.

Whether they're explicit or more subtle lines, they can take the viewer on a journey to different destinations around the artwork.

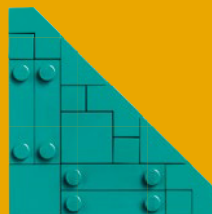
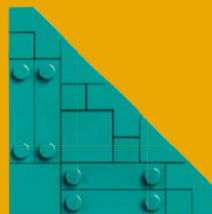

Nacho



Dot



Strip

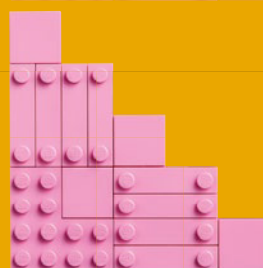
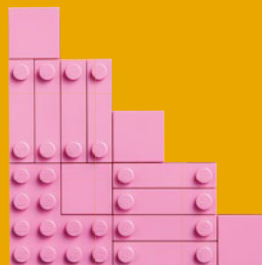

Step



Paddle

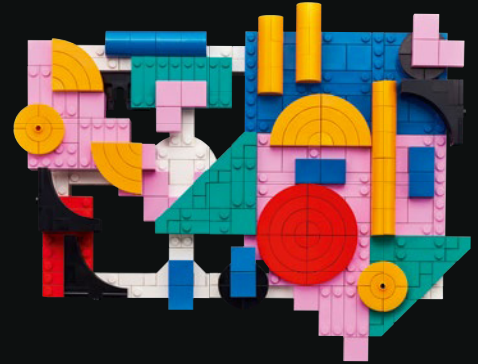
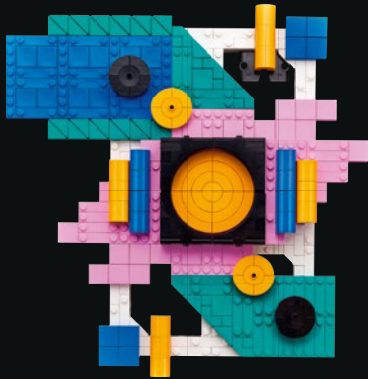

PLACEMENT AND CONTRASTS

- Use your elements to shape colourful paths and transitions between modules or through different colour blocks. What happens when you place your **Diagonal Lines** behind other elements versus in front of them? Give it a try!

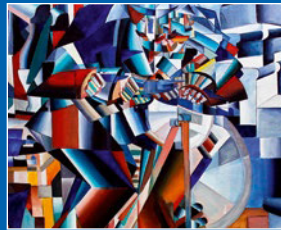

WHAT'S YOUR PERSPECTIVE?

- Colour-blocking, placement of contrasting colours and light and dark shades can help you create focal points, depth and perspective in your artwork. And now, for the final touch, give your masterpiece an intriguing name that really draws the viewer in!

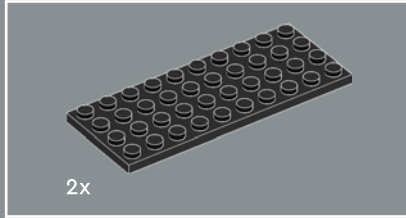
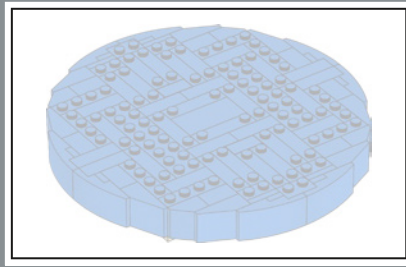

46

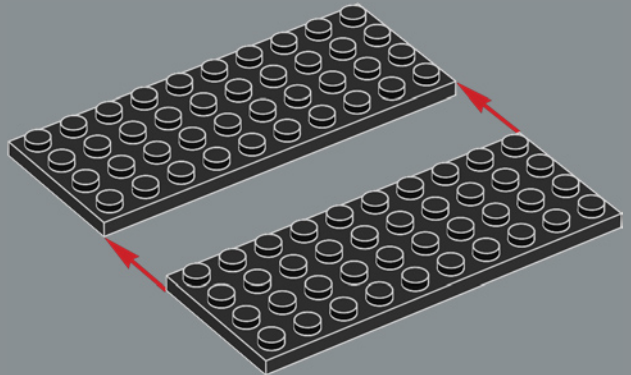

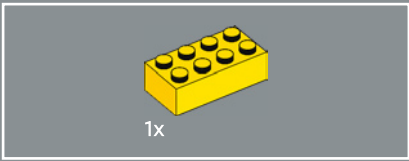

47

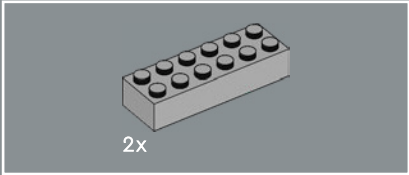
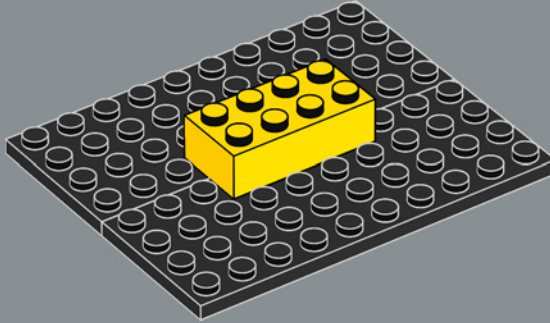

48

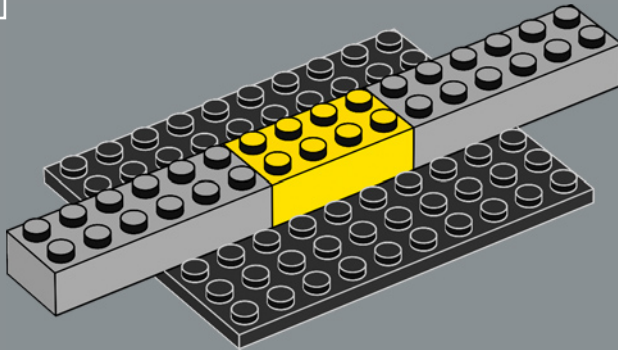

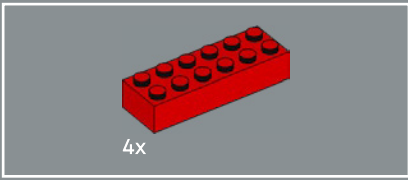

49

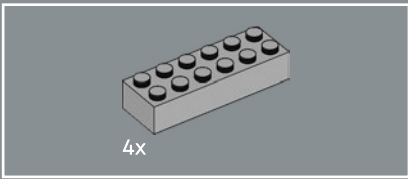
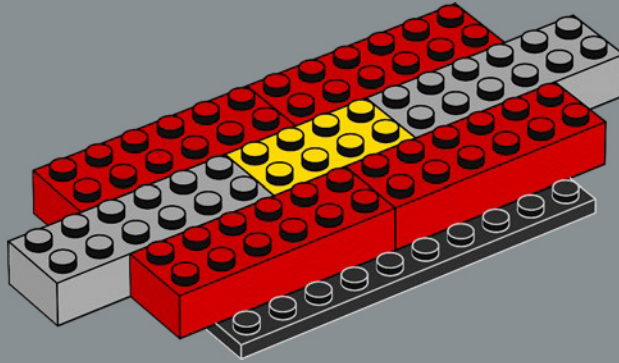

50

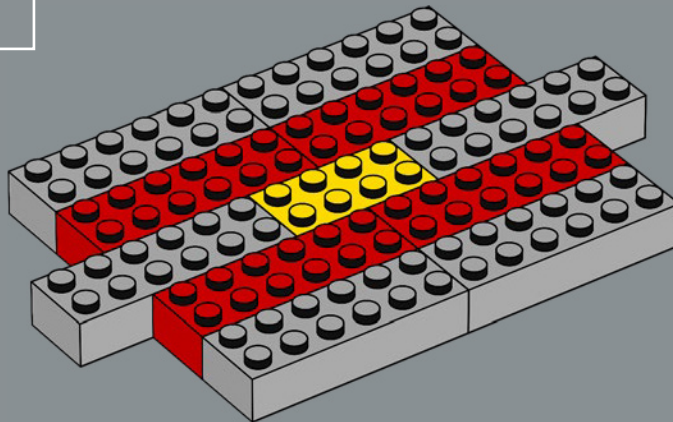

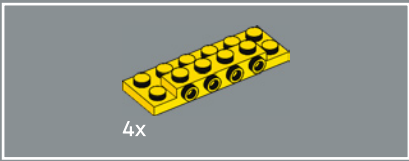

51

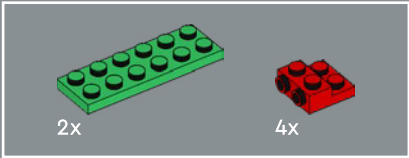
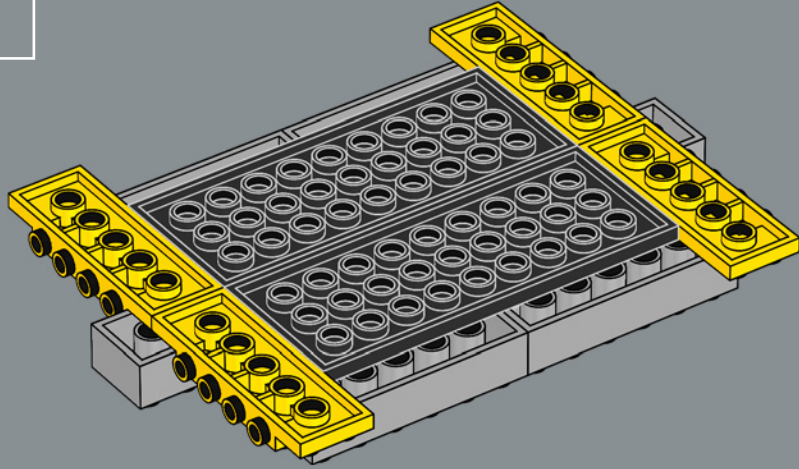

52

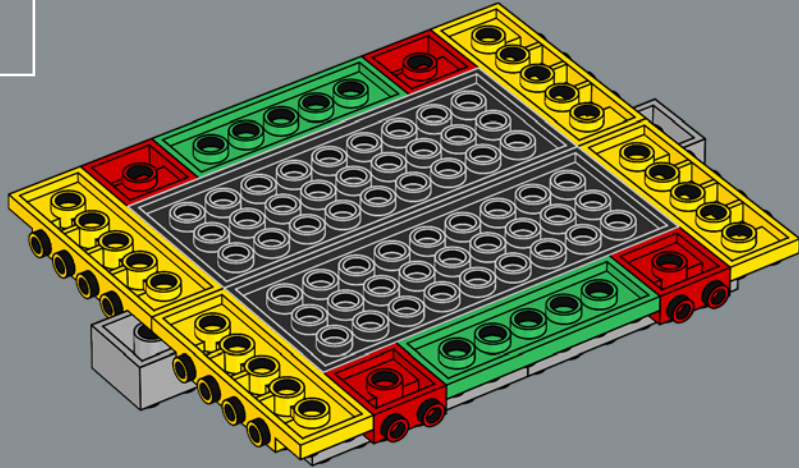

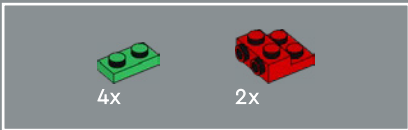

53

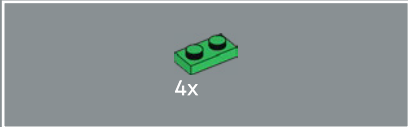
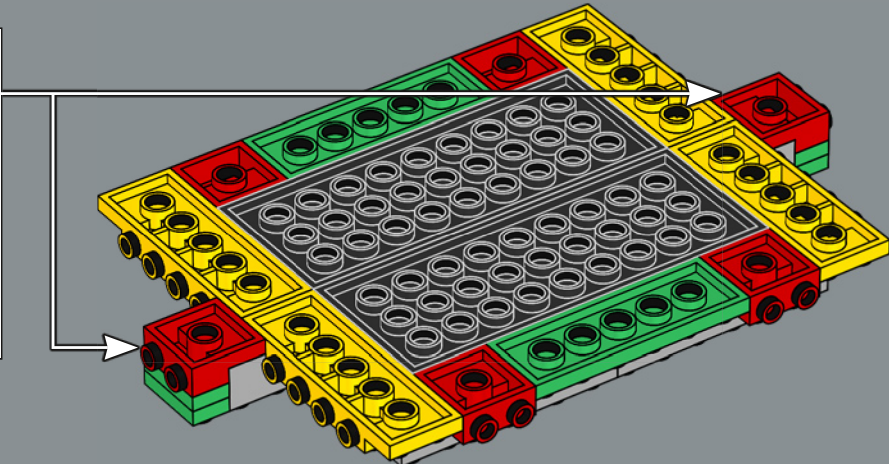
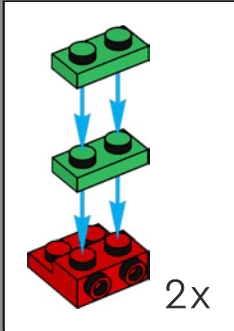

54

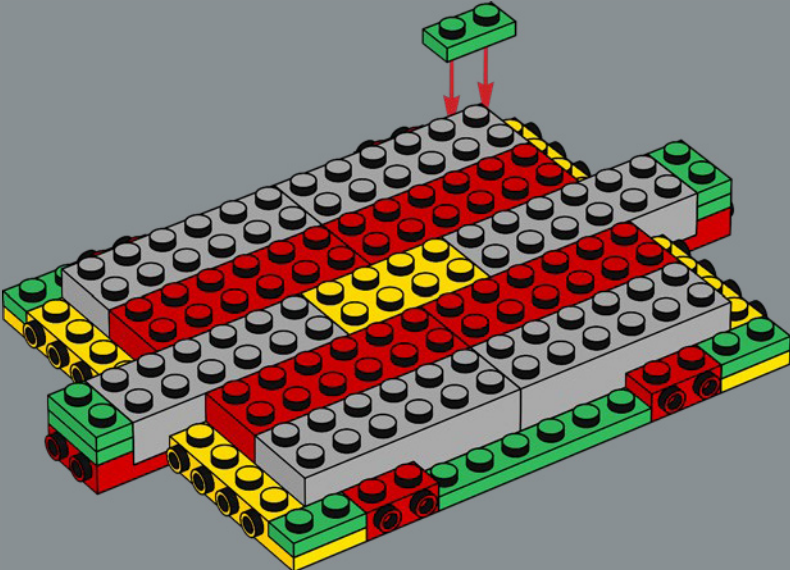

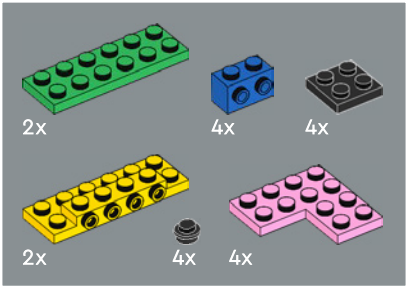
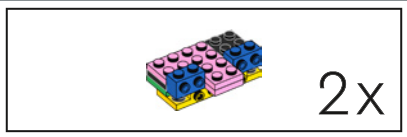

55

1

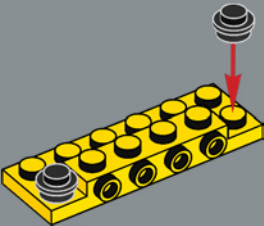

2

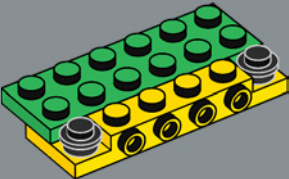

3

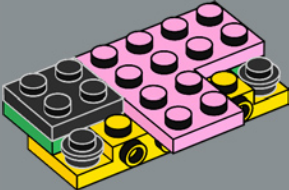

4

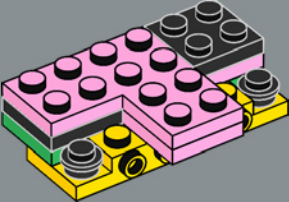

5

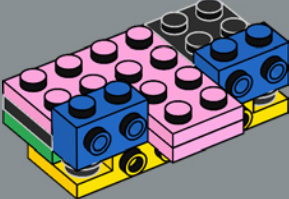

2x

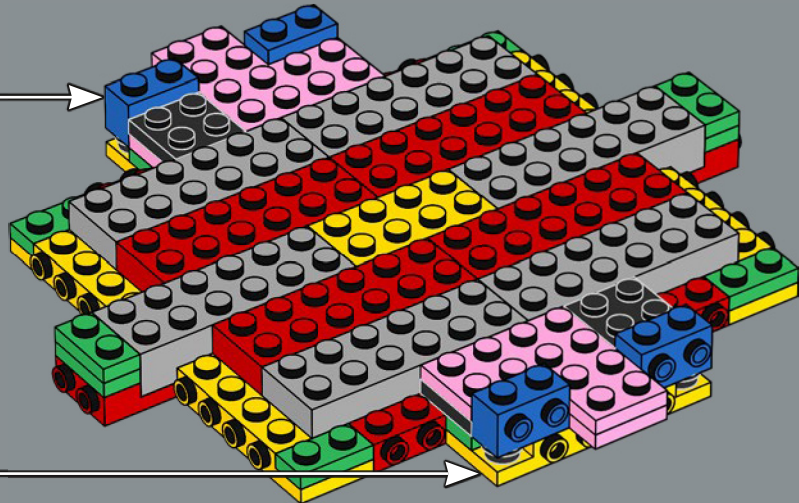

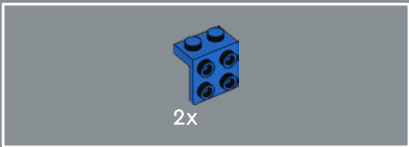

56

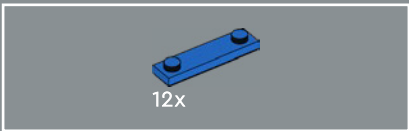
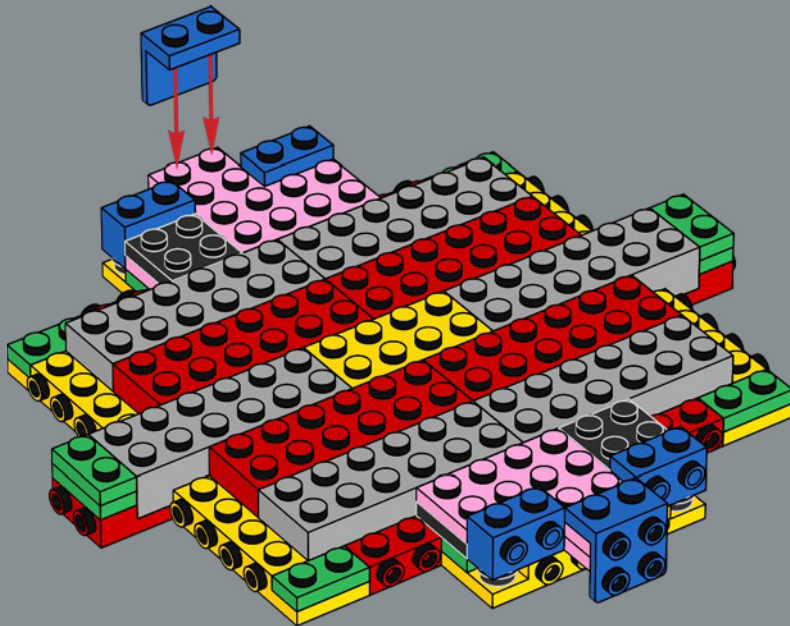

57

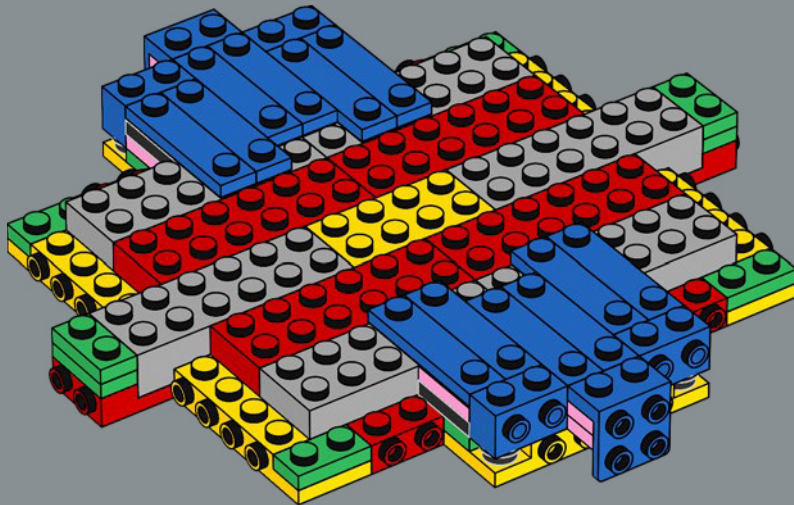

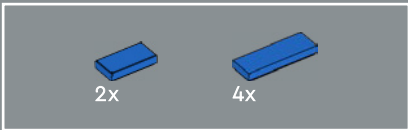

58

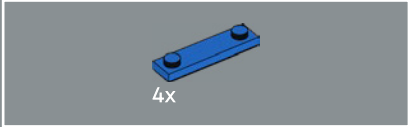
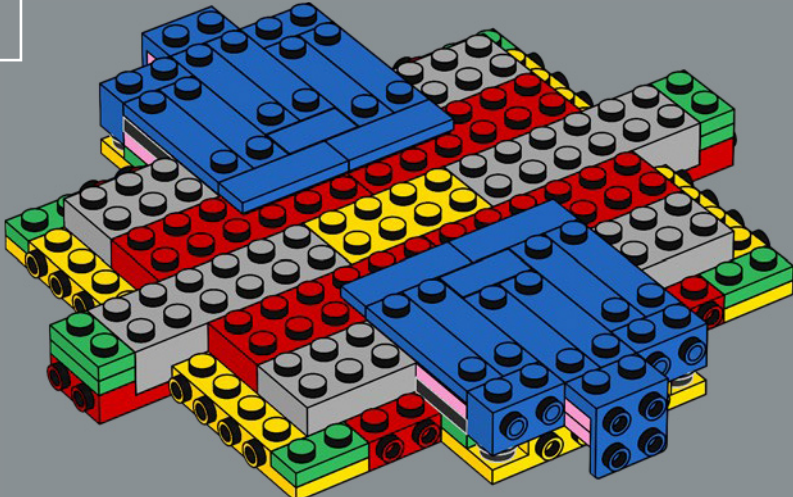

59

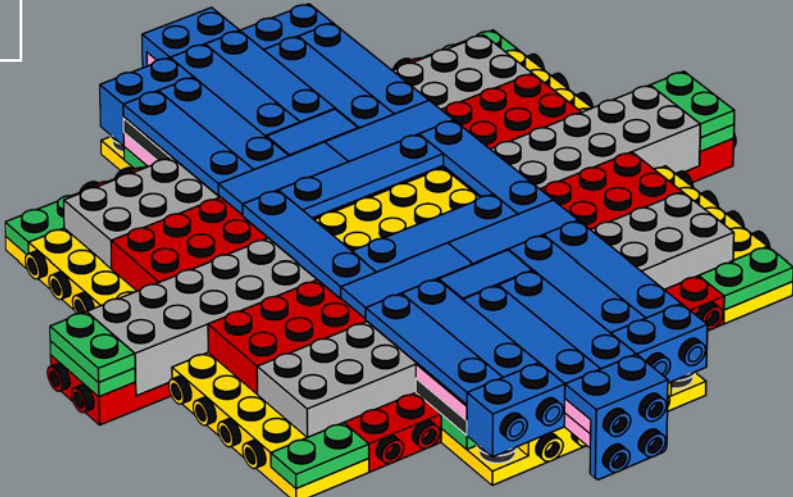

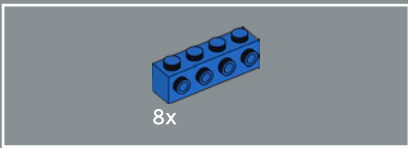

60

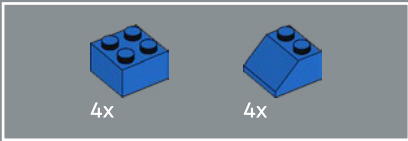
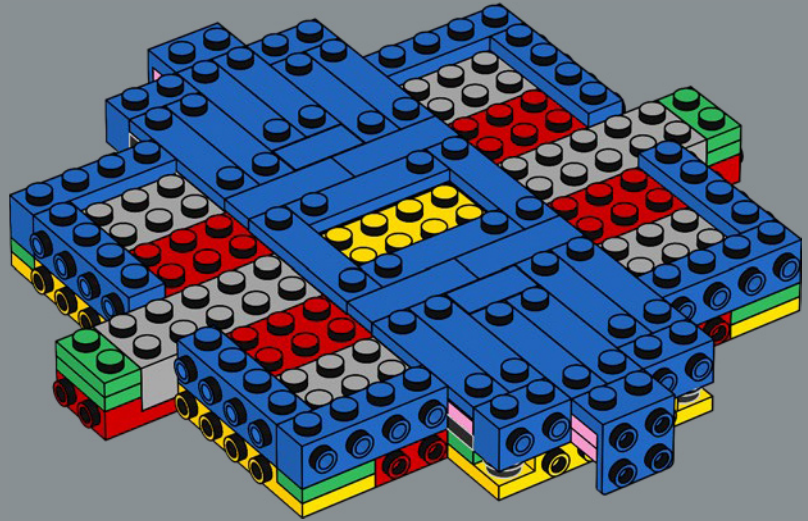

61

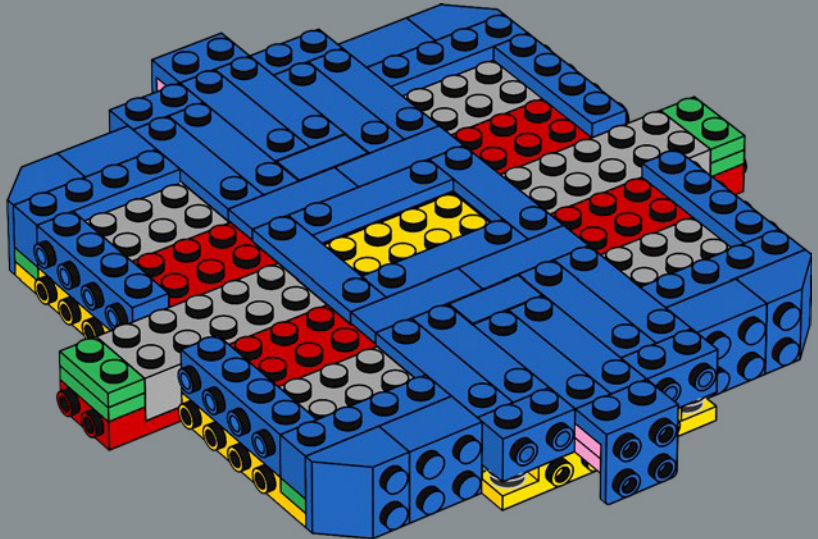

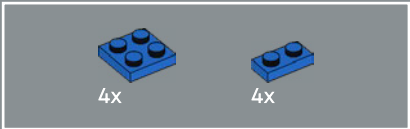

62

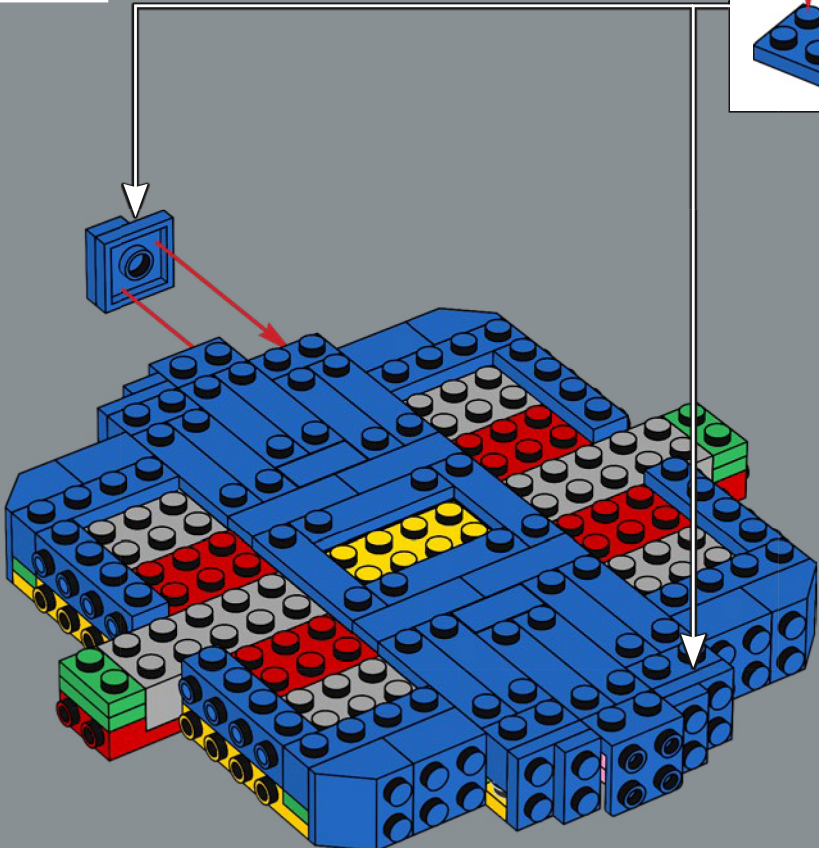
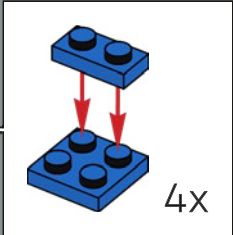

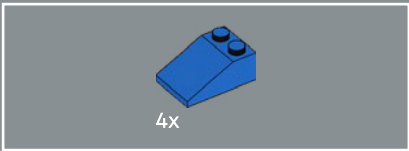

63

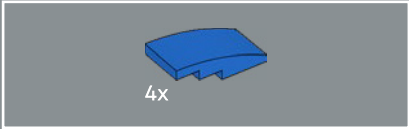
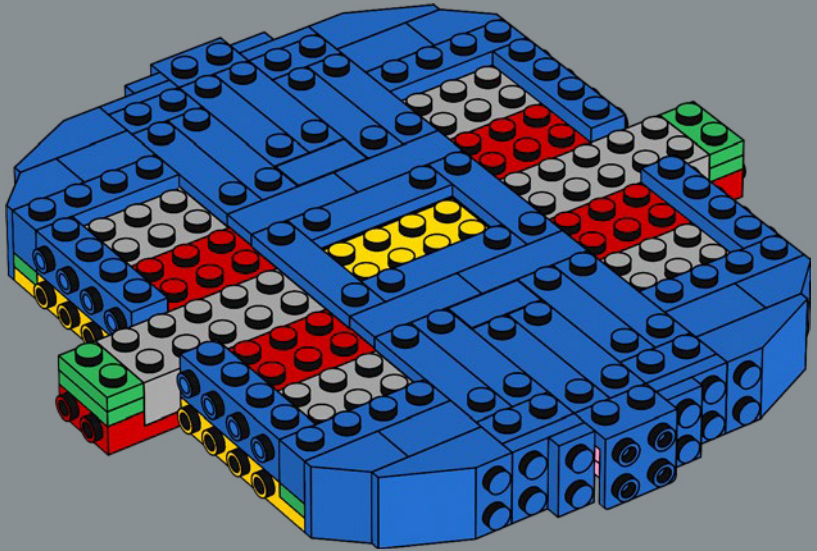

64

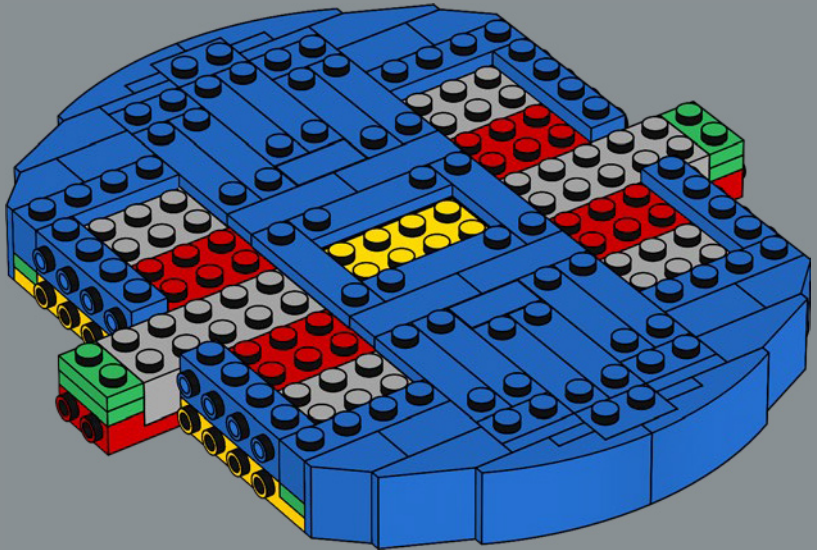

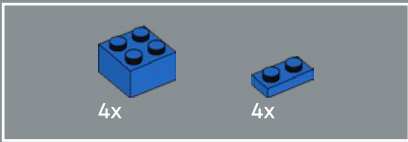

65

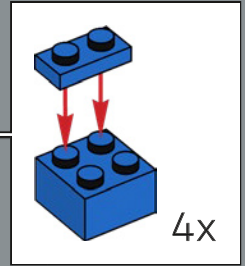
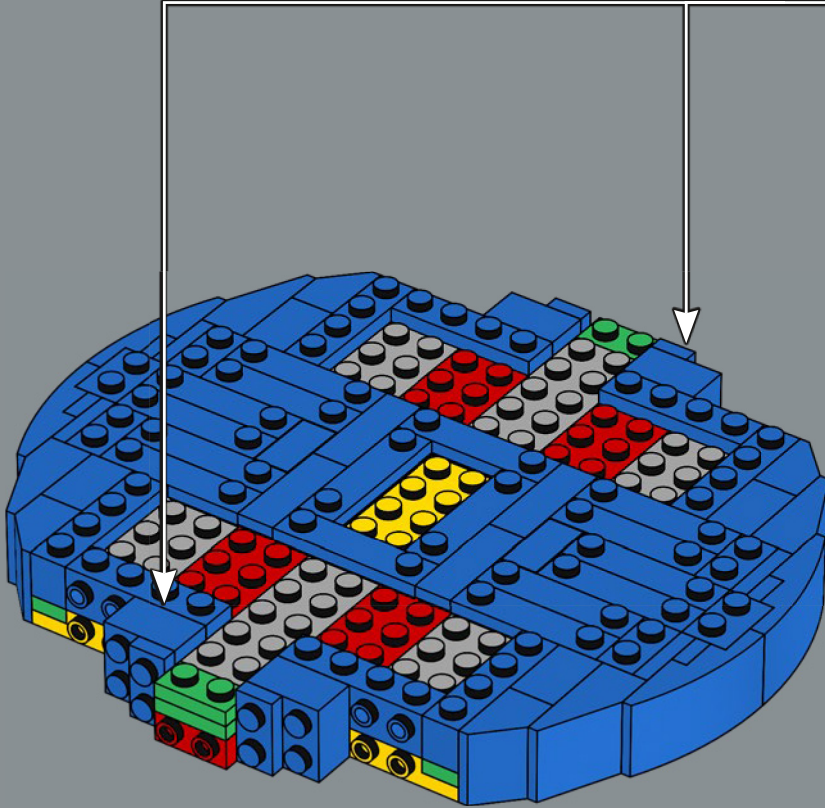

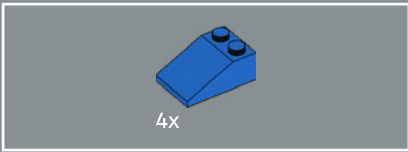

66

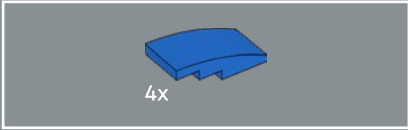
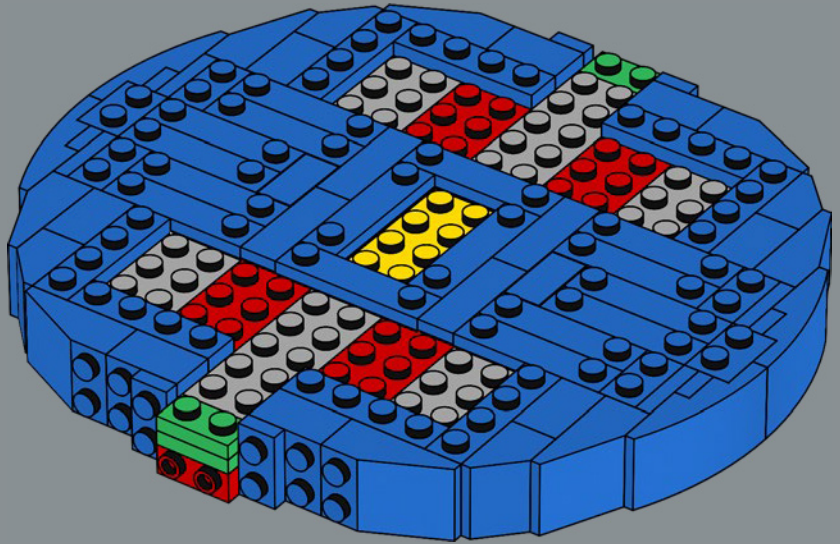

67

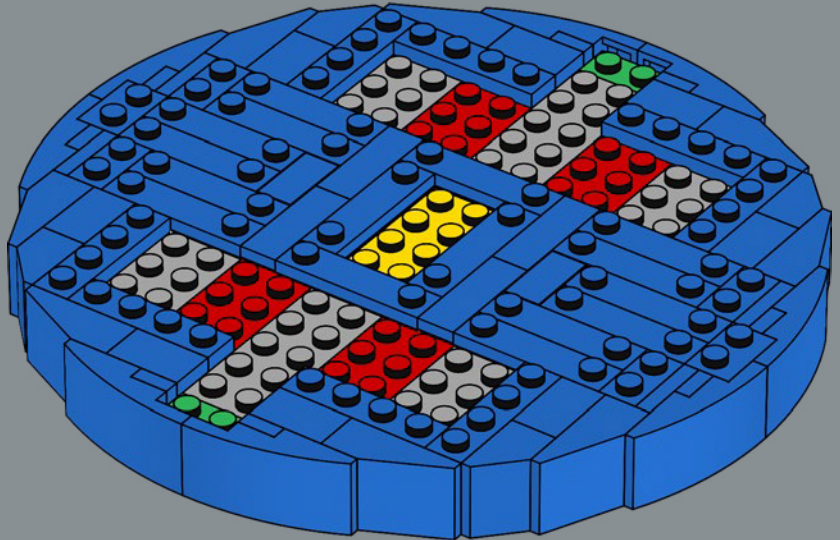

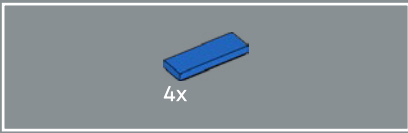

68

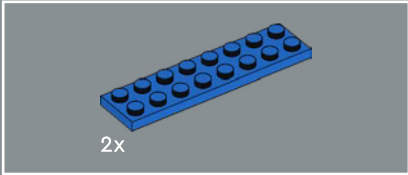
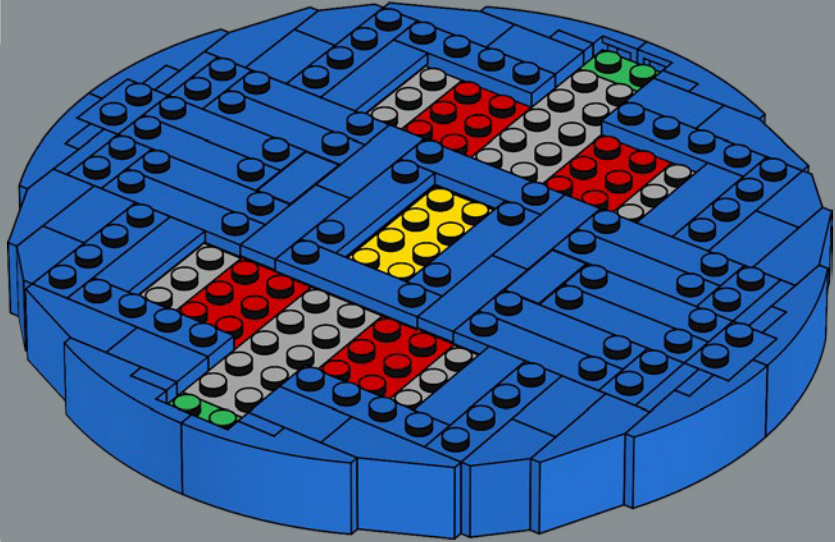

69

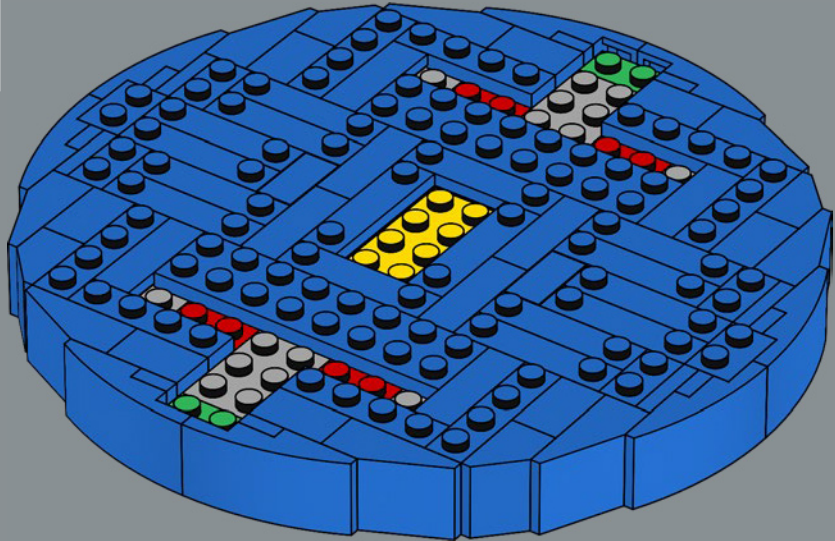

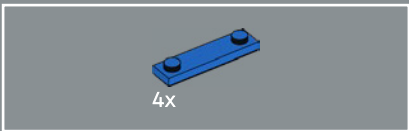

70

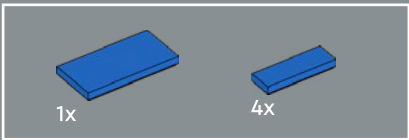
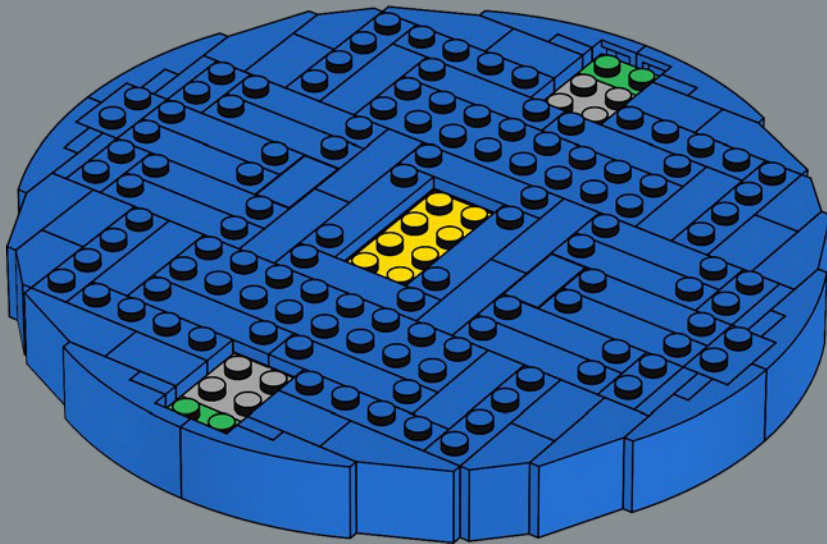

71

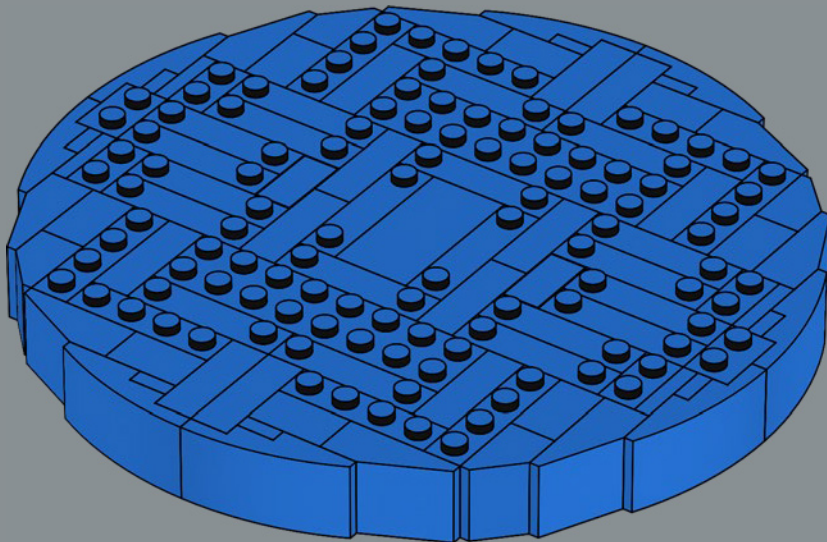

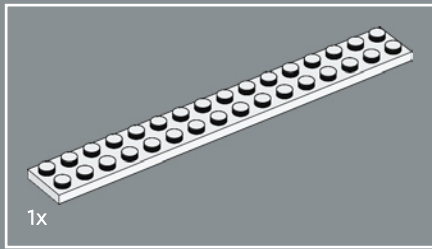

72

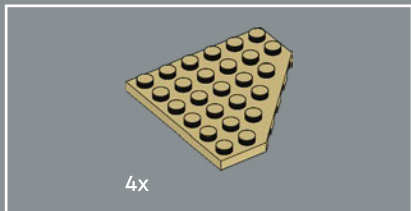
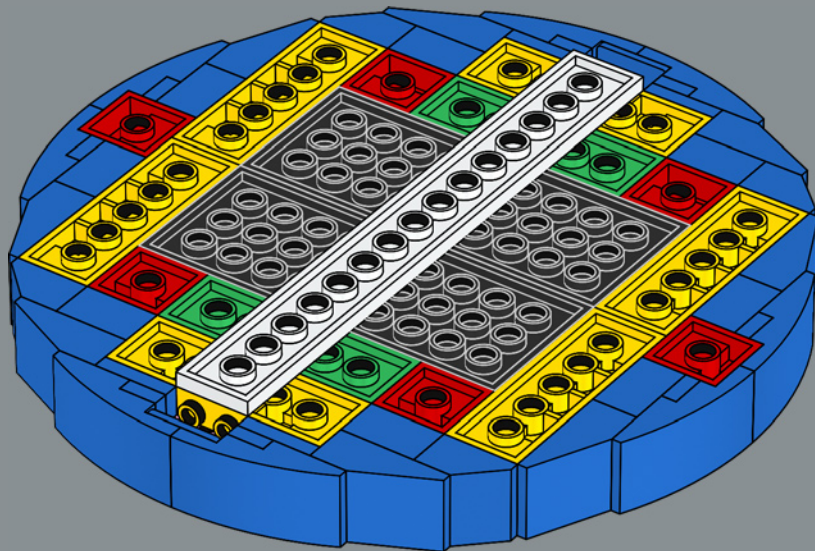

73

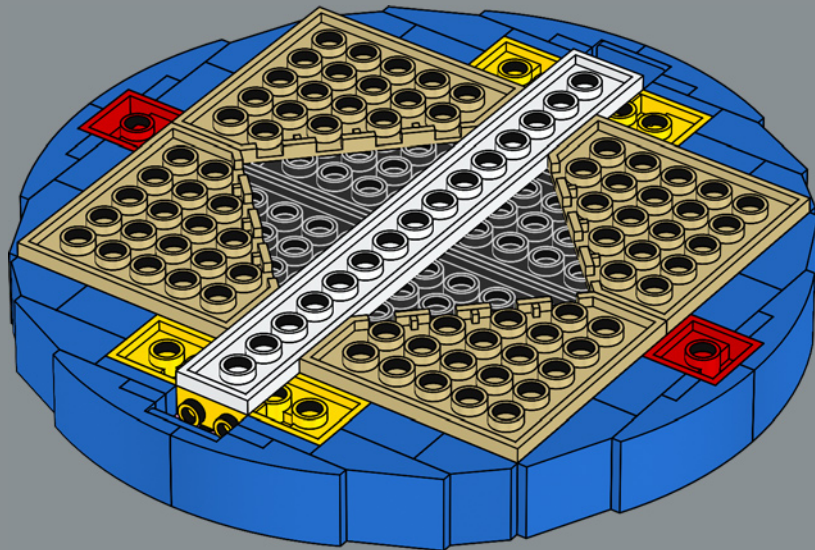

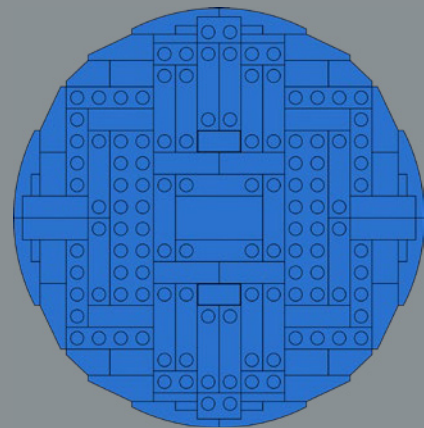
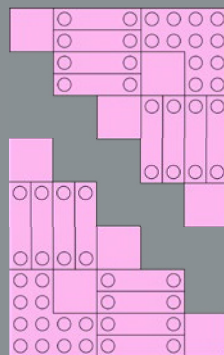
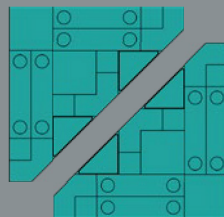
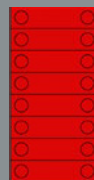
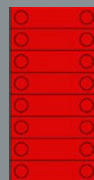
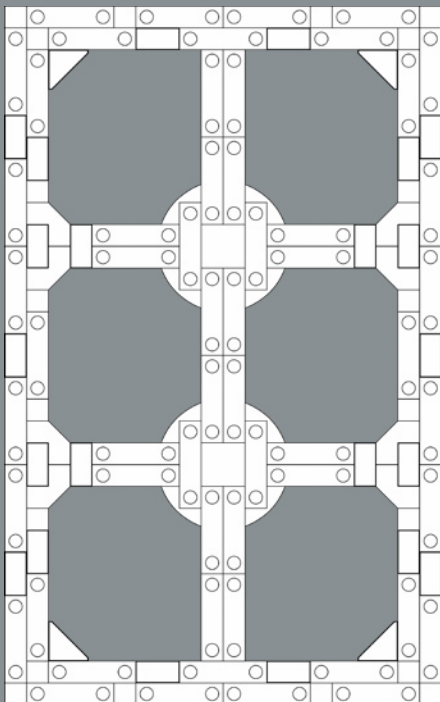
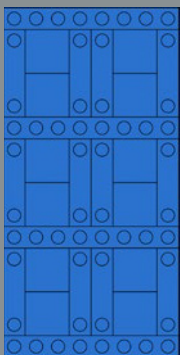
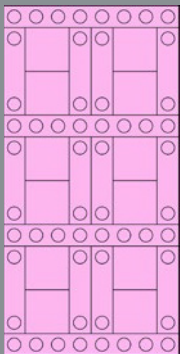
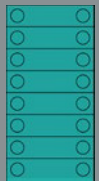
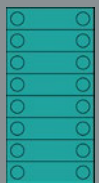

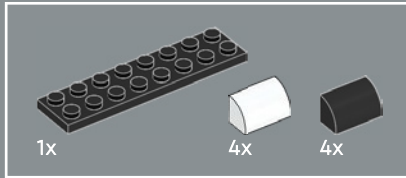
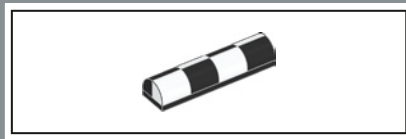

74

1

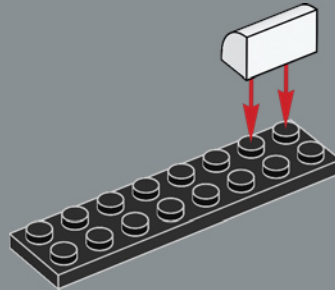

2

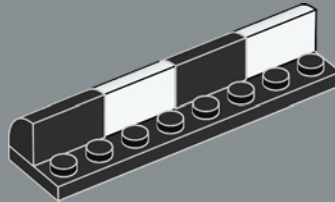

3

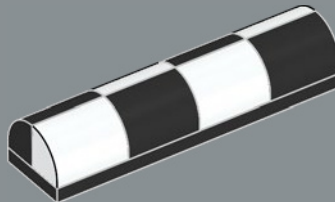

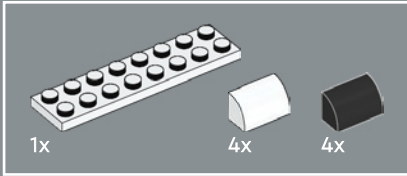
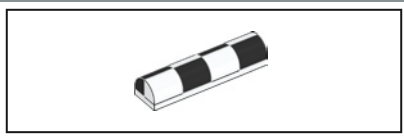

75

1

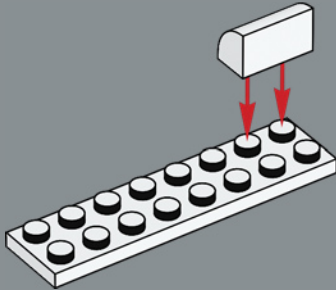

2

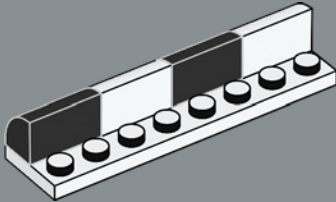

3

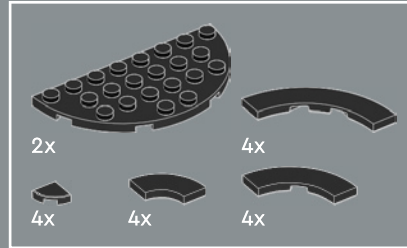
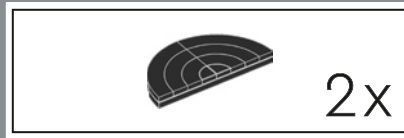
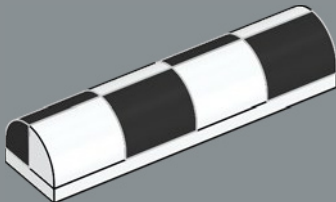

76

1

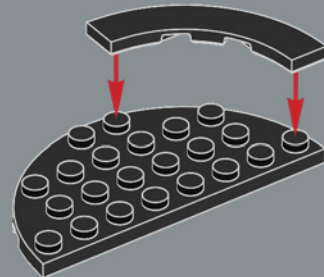

2

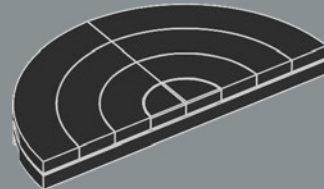

2x

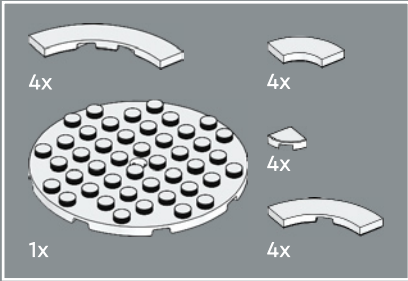
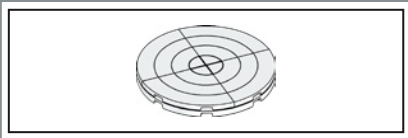

77

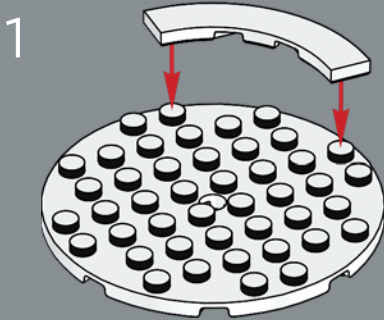

2

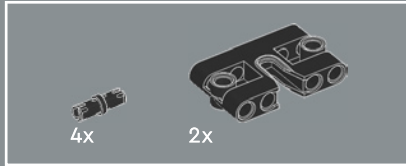
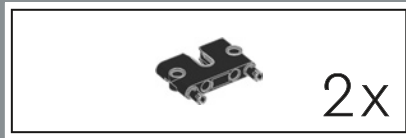
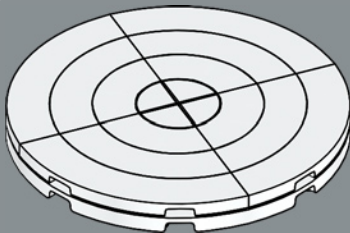

78

1

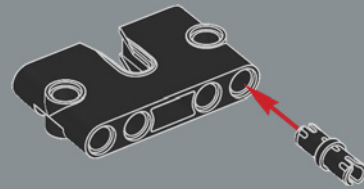

2

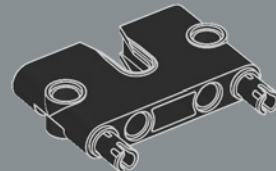

2x

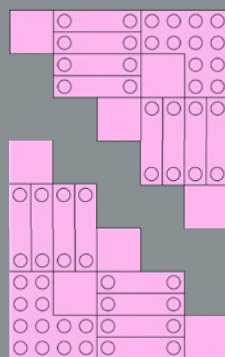
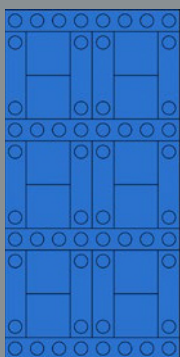
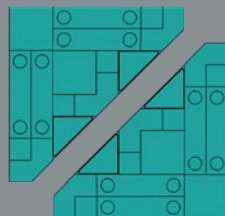
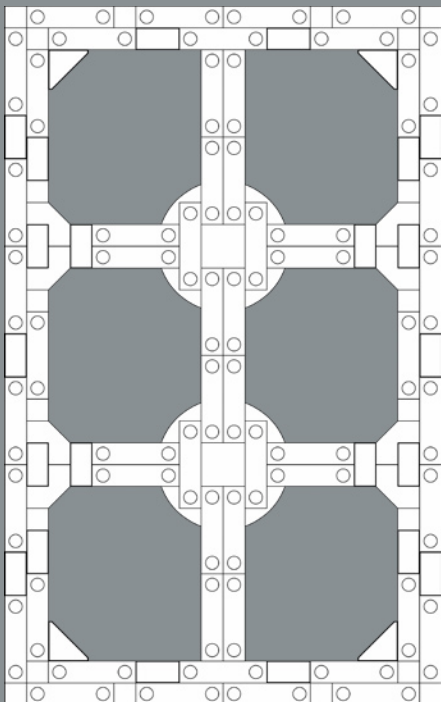
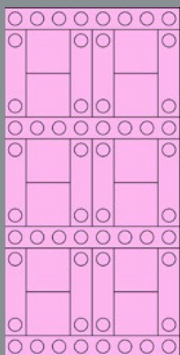
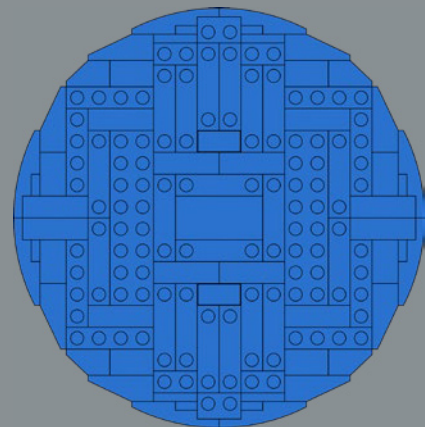
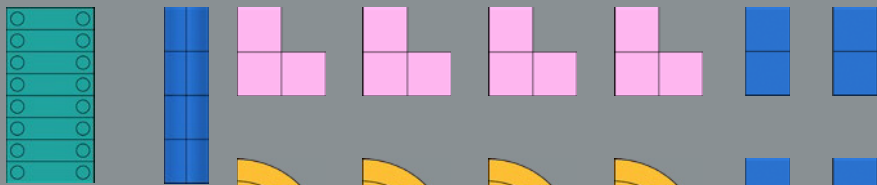

A

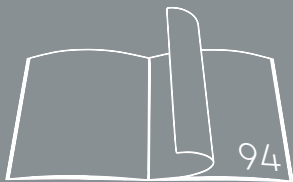

B



C

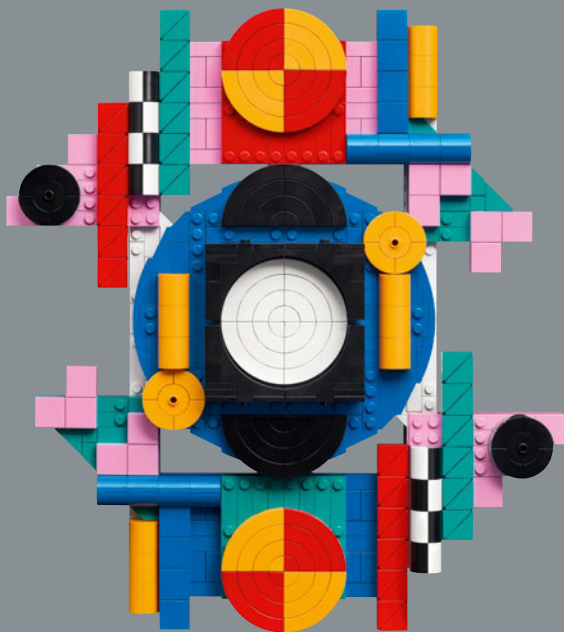

D

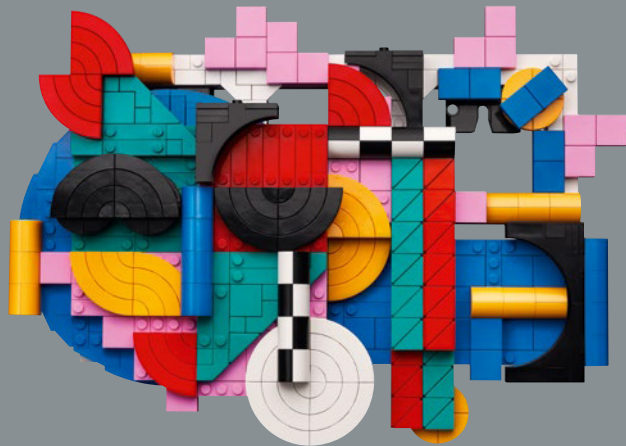





1

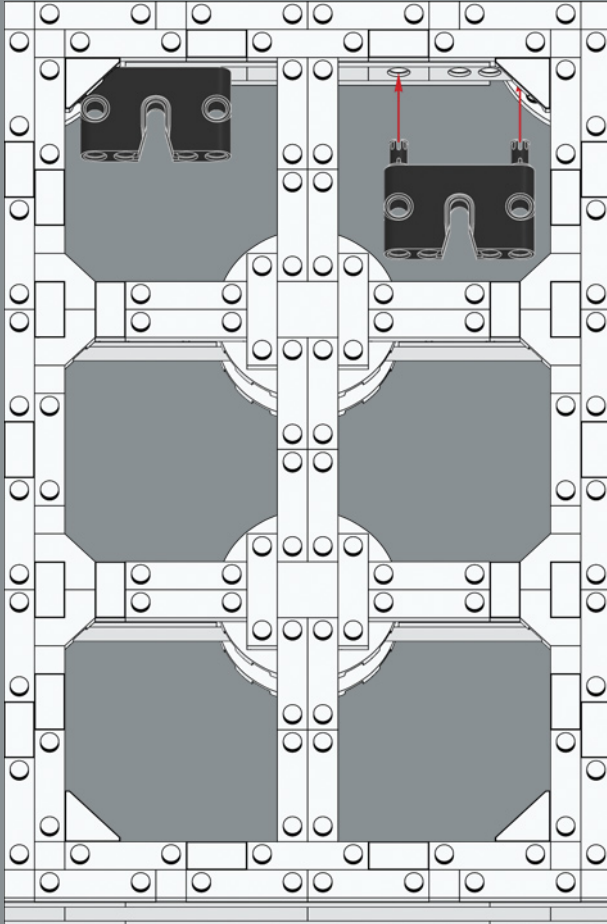

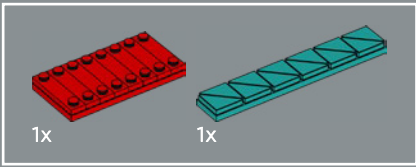

2

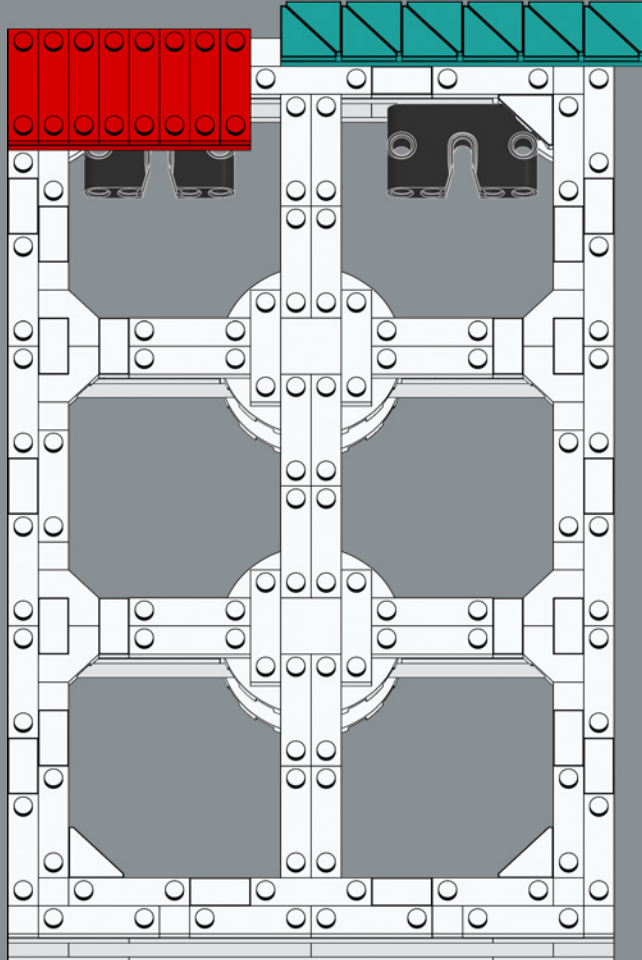

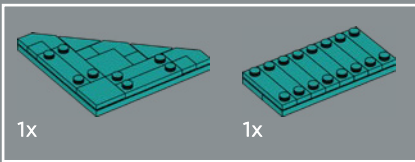

3

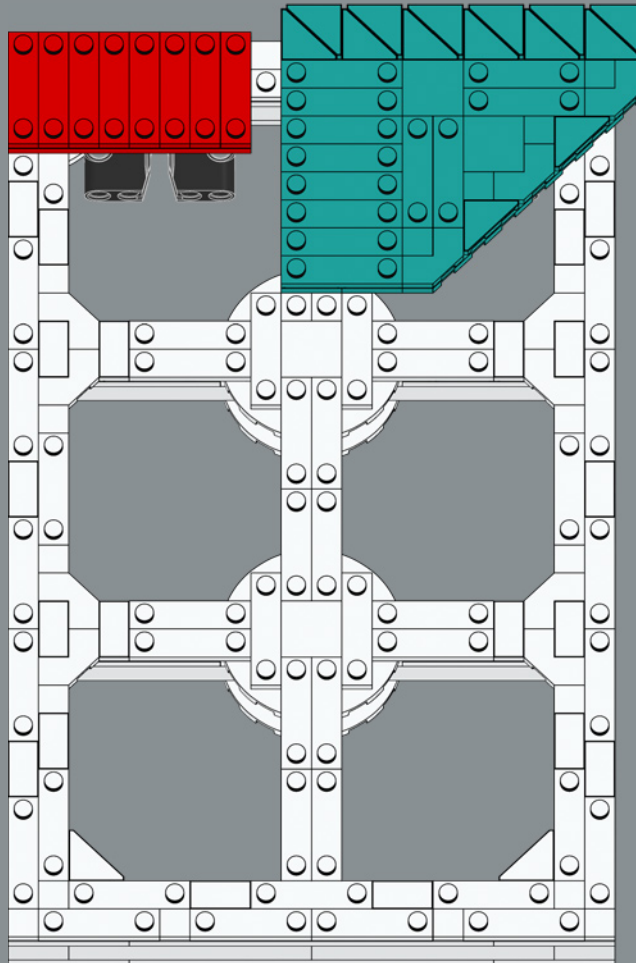

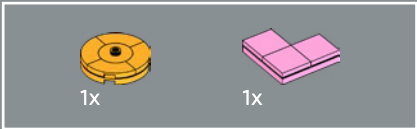

4

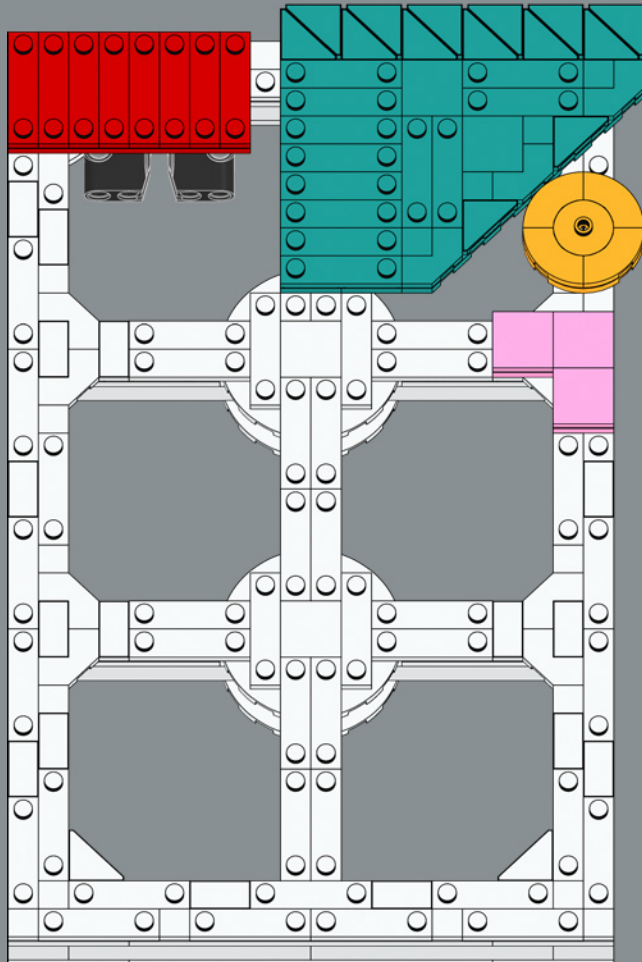

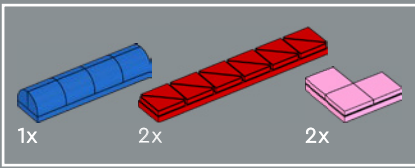

5

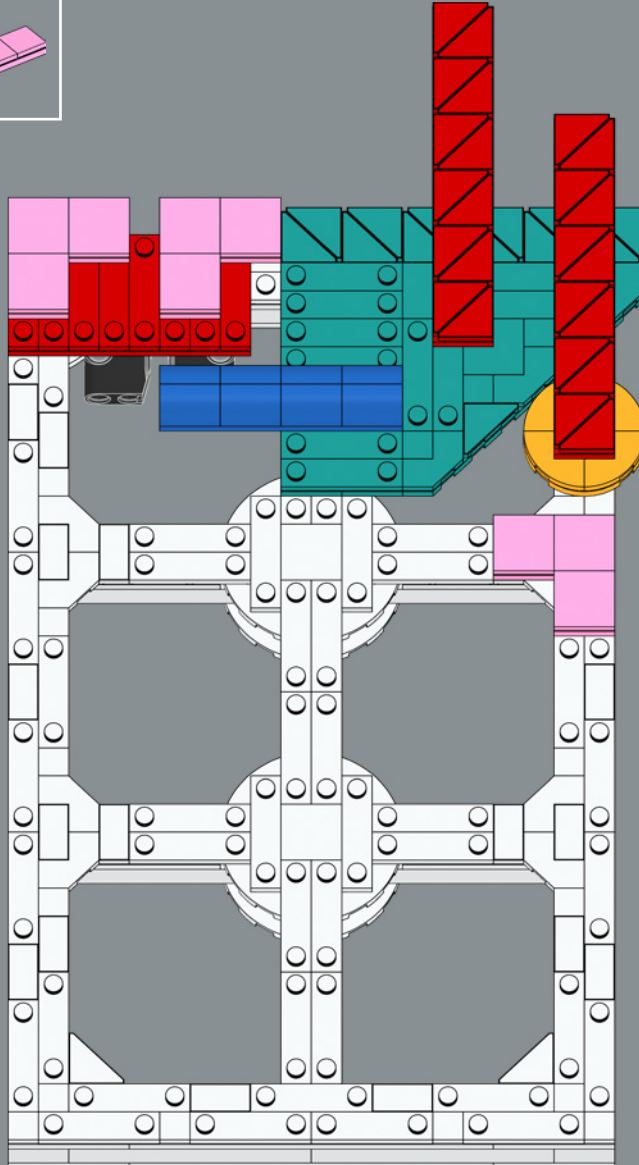

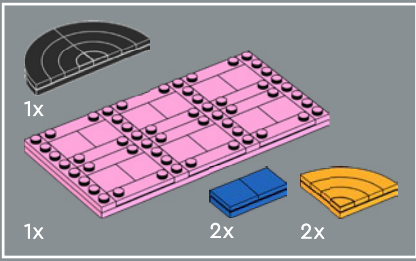

6

1

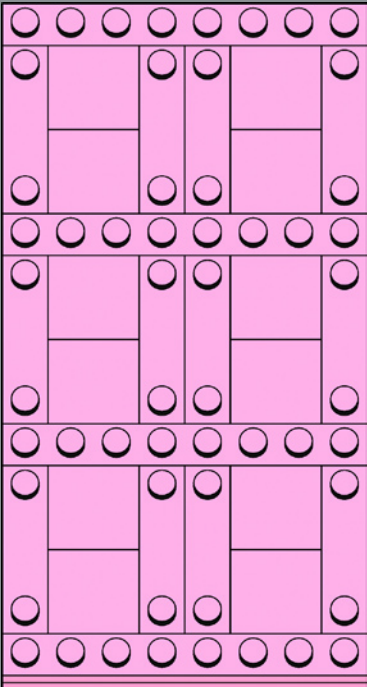

2

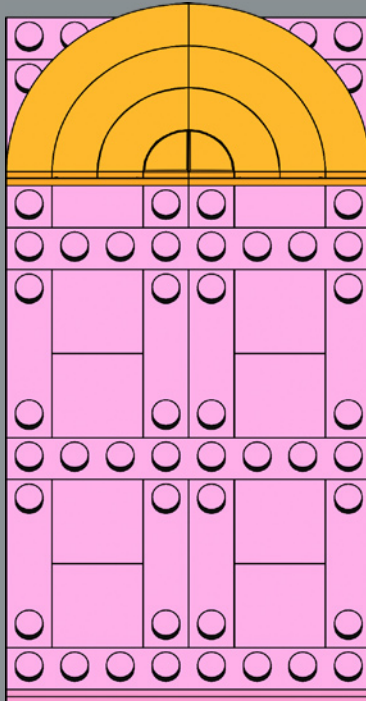

3

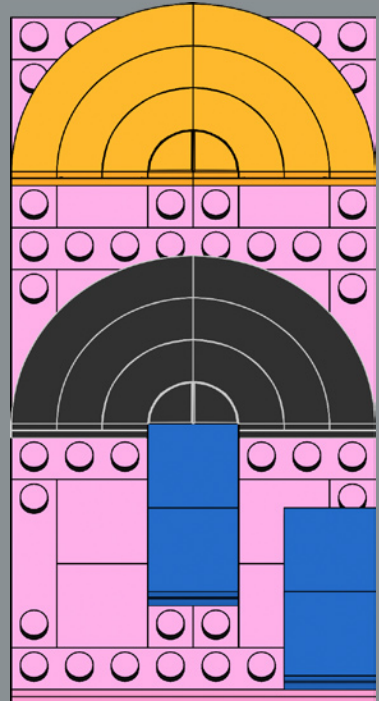

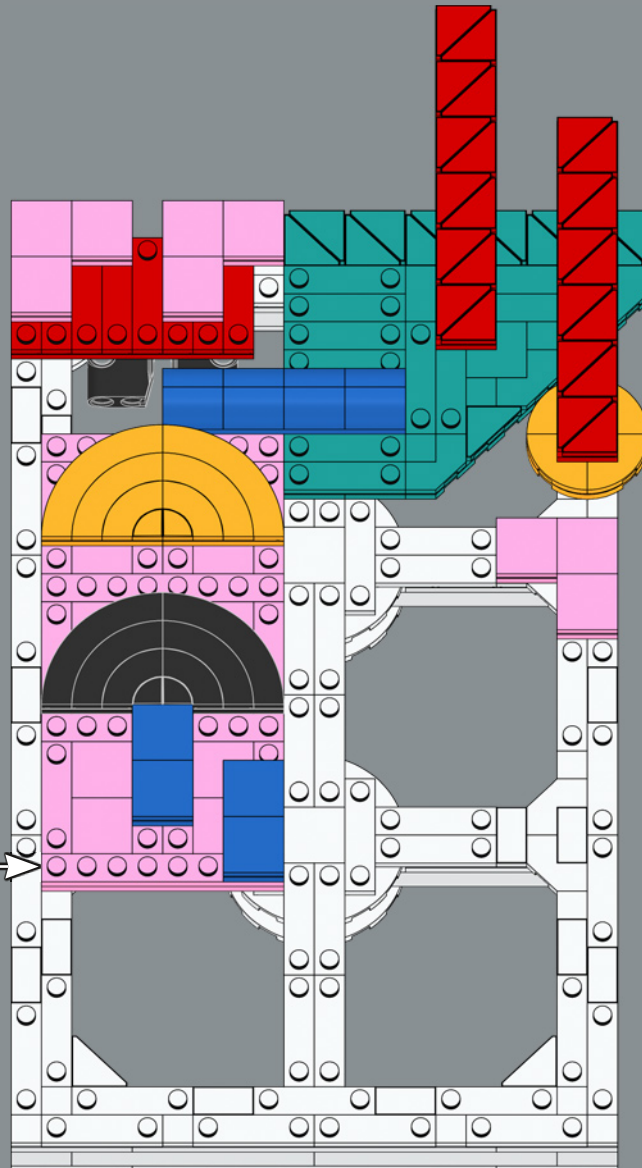



7

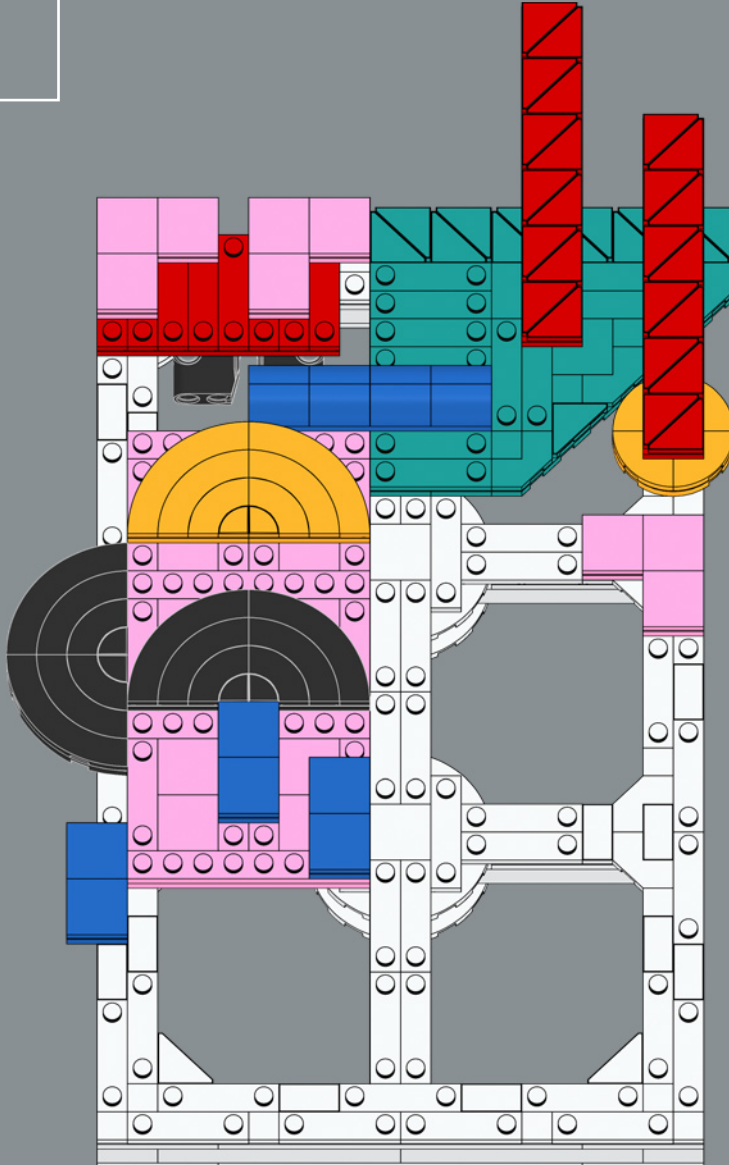

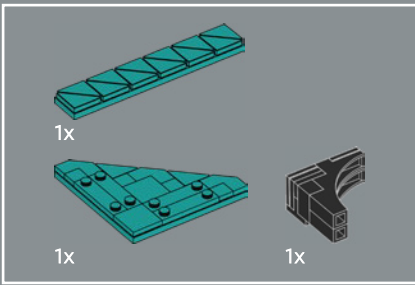

8

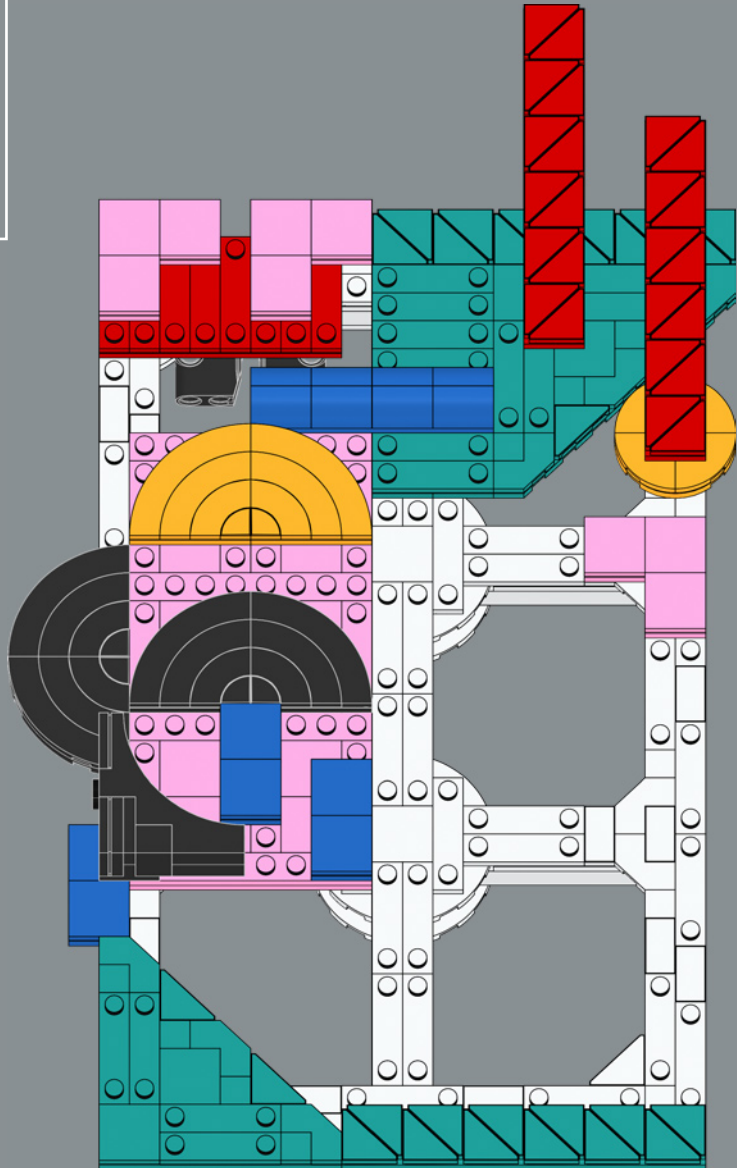

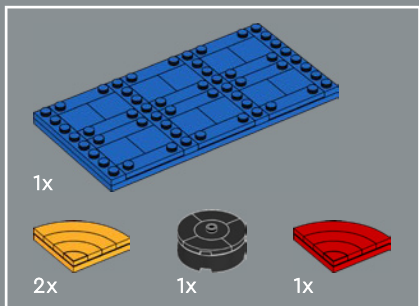

9

1

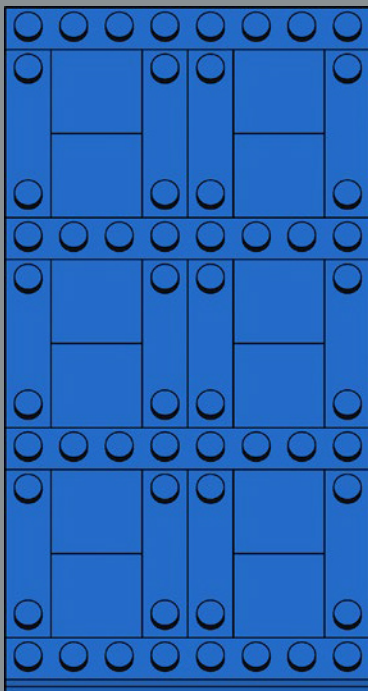

2

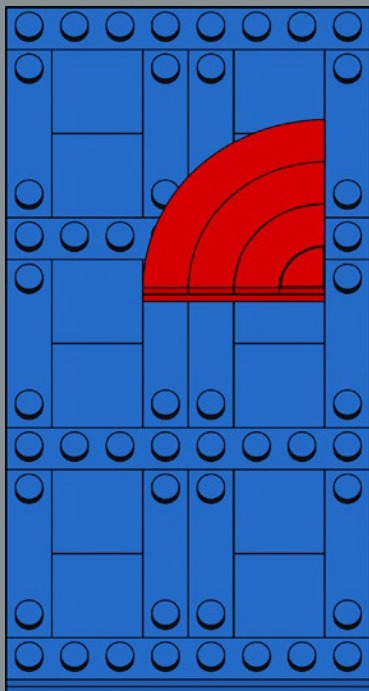

3

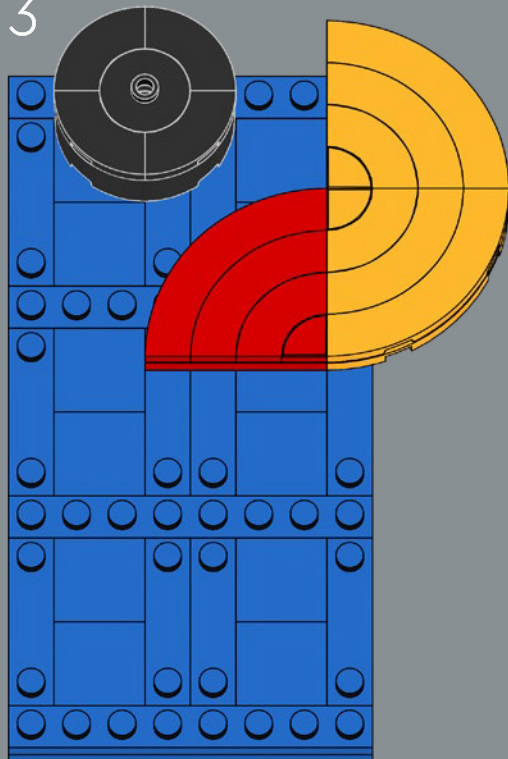

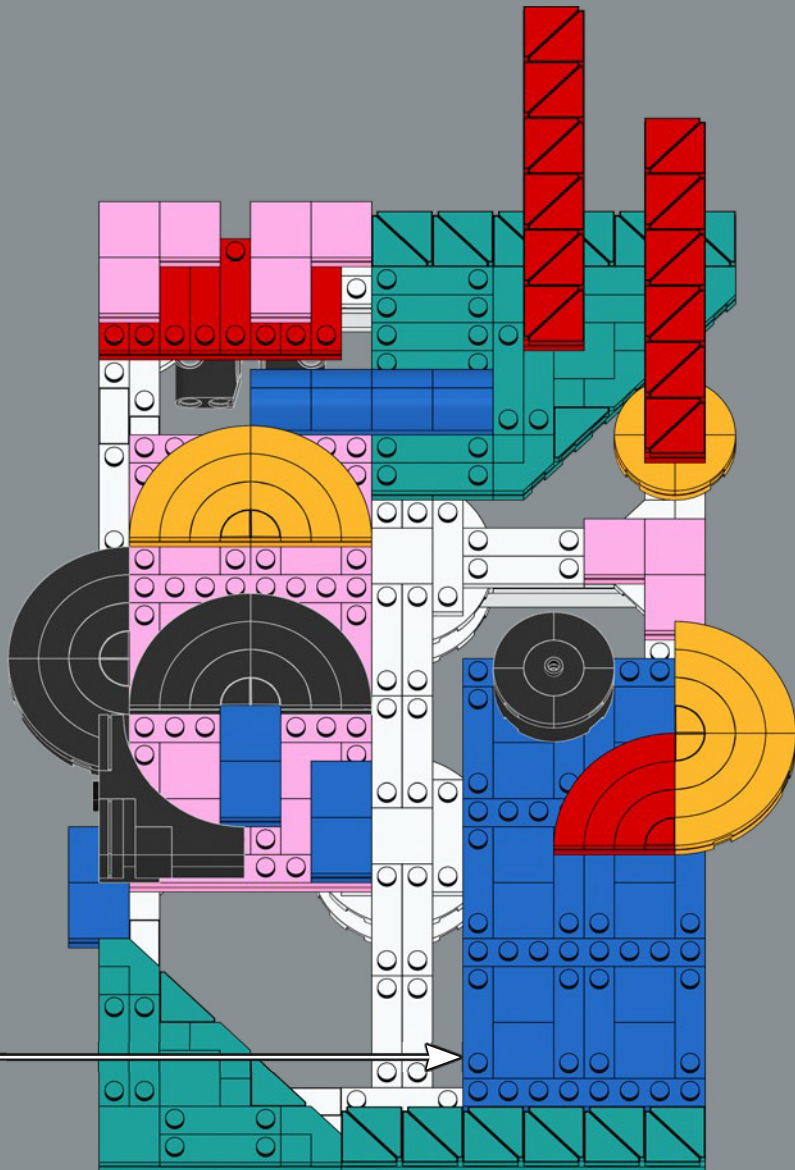

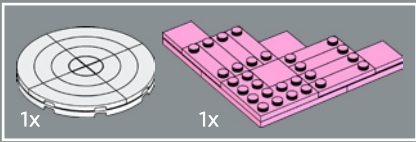

10

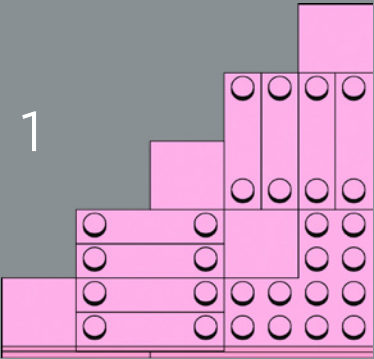

1

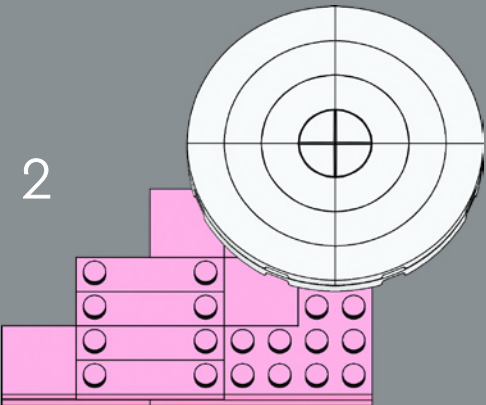

2

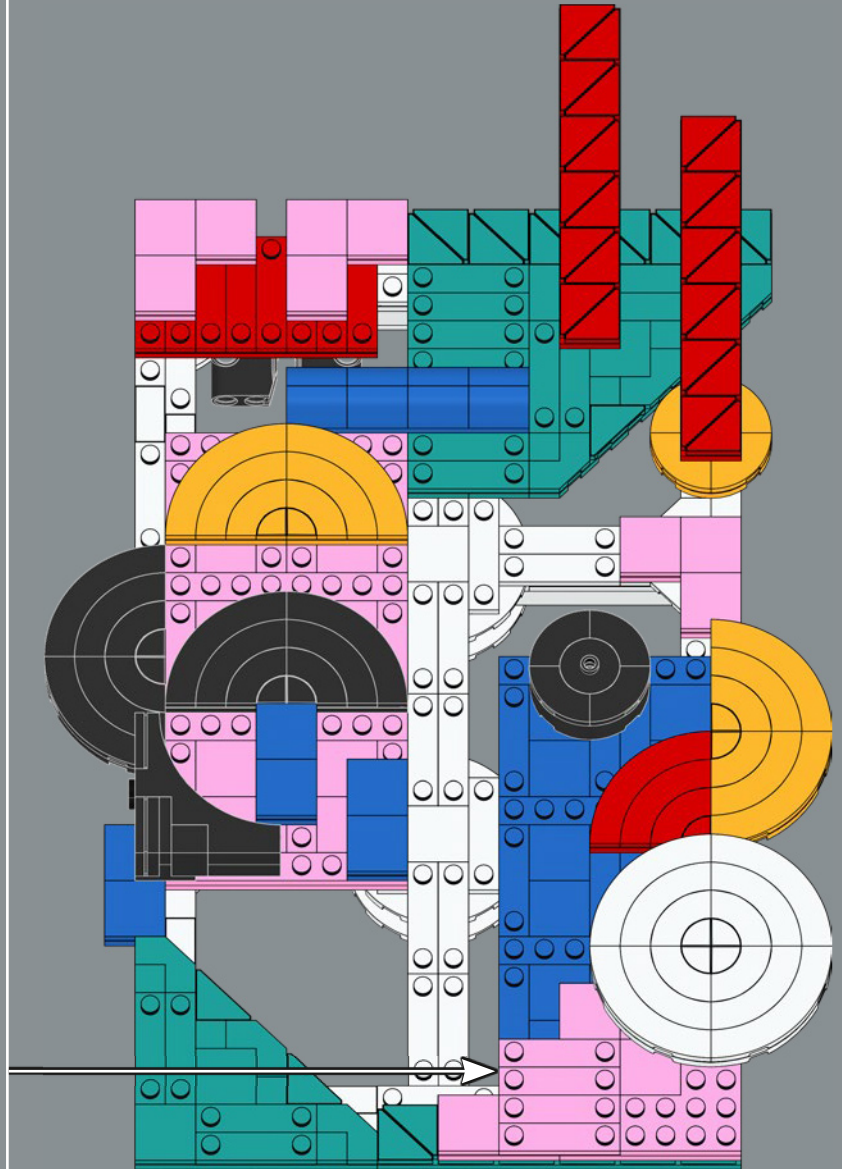

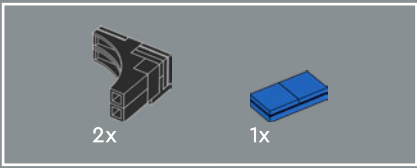

11

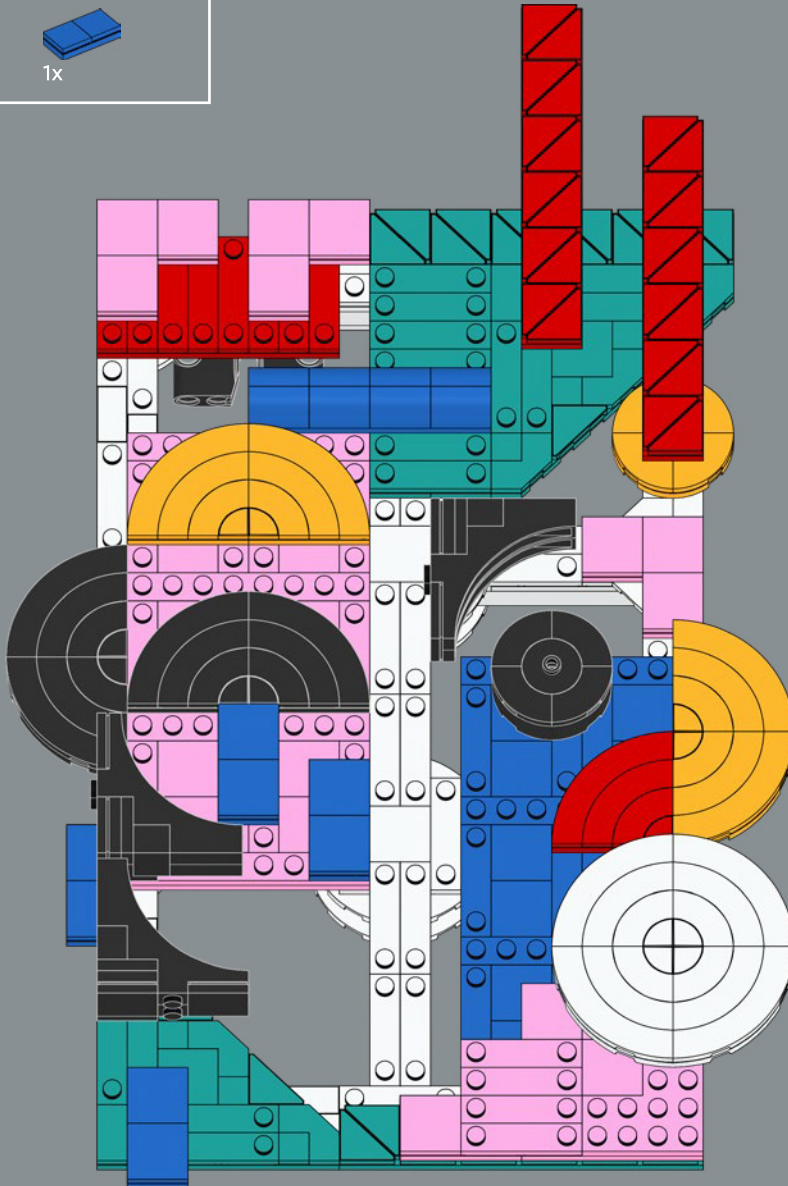

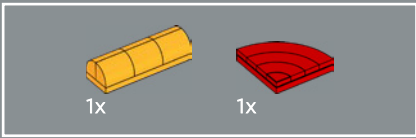

12

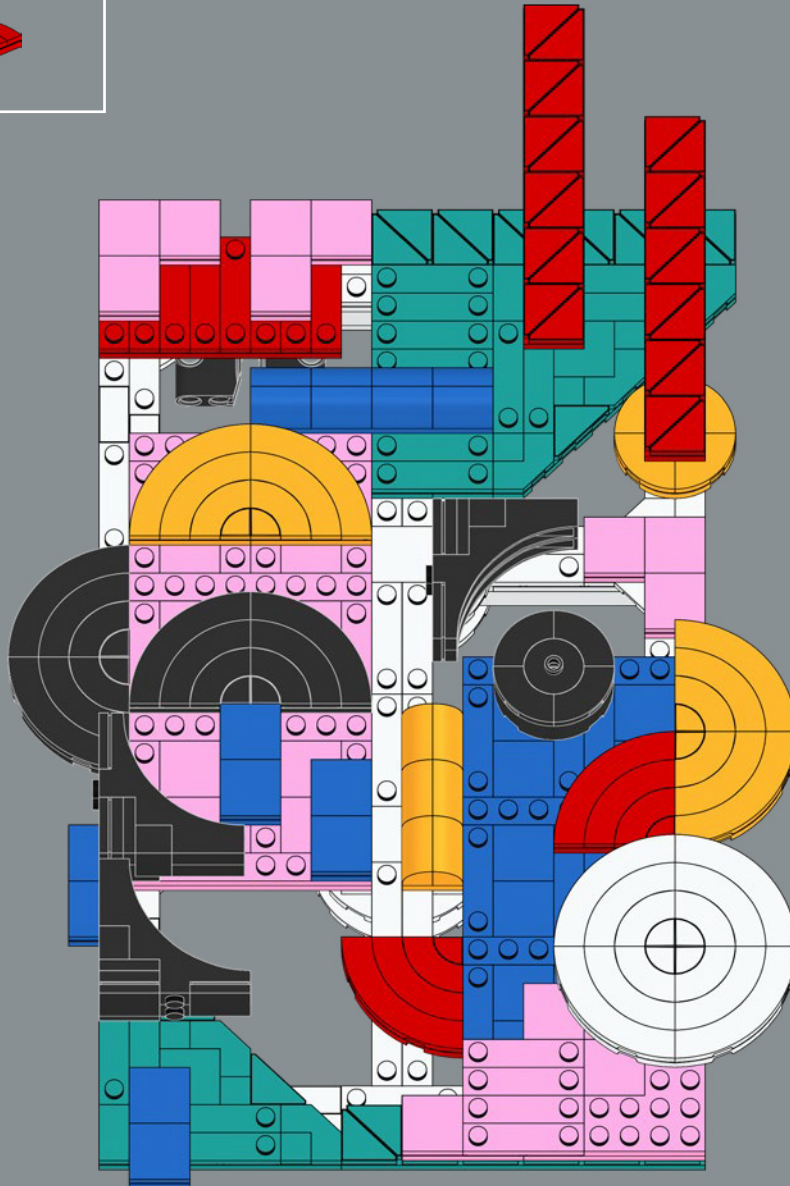

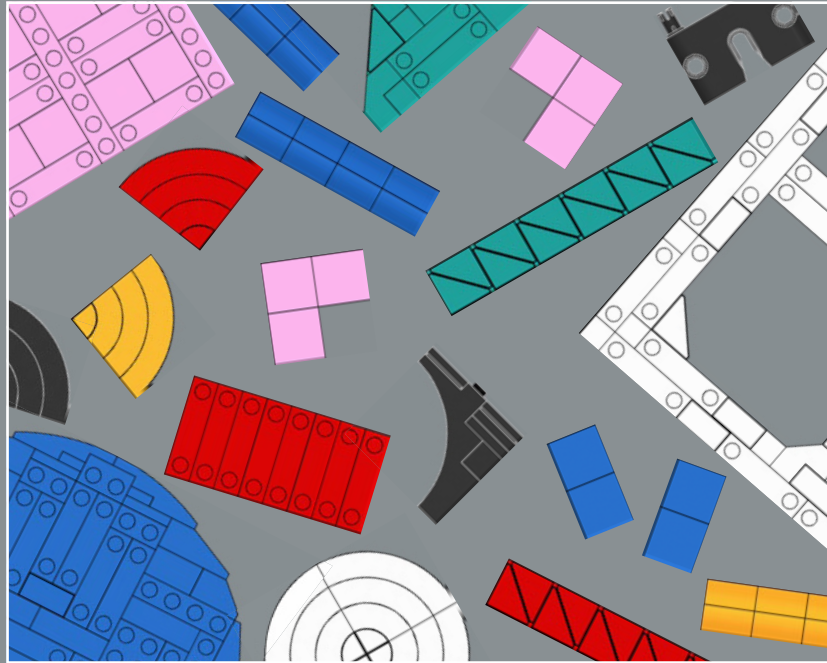

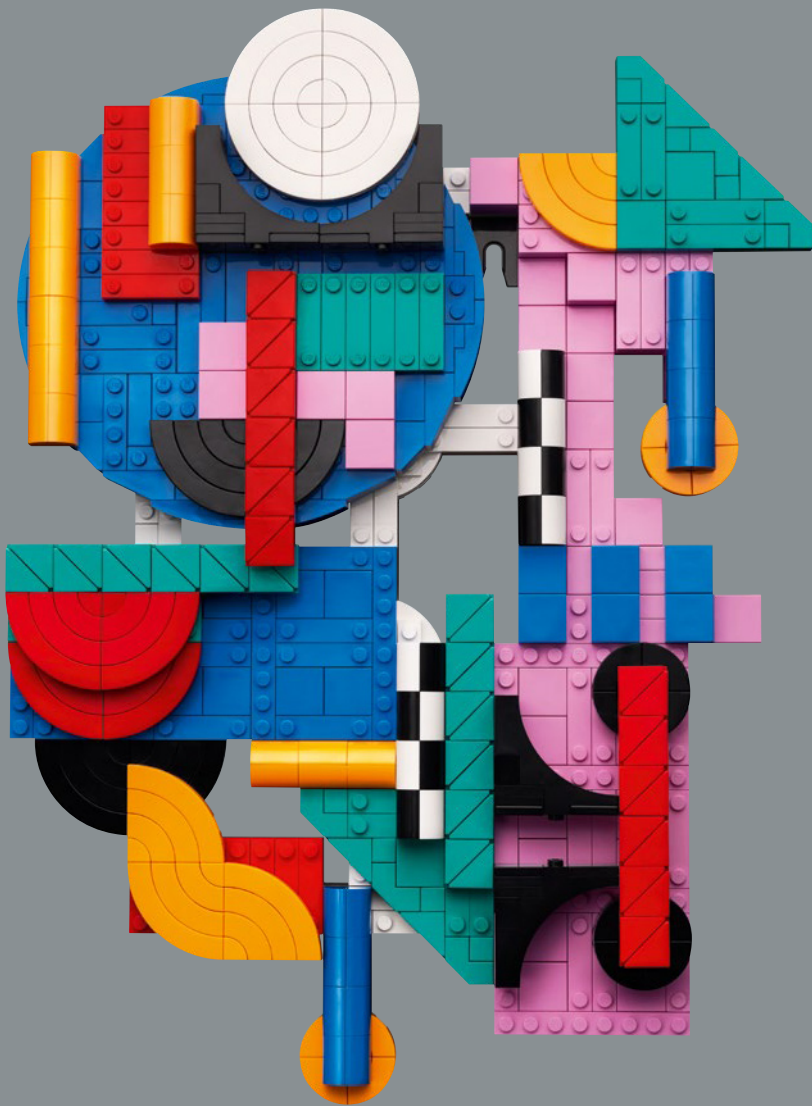



1

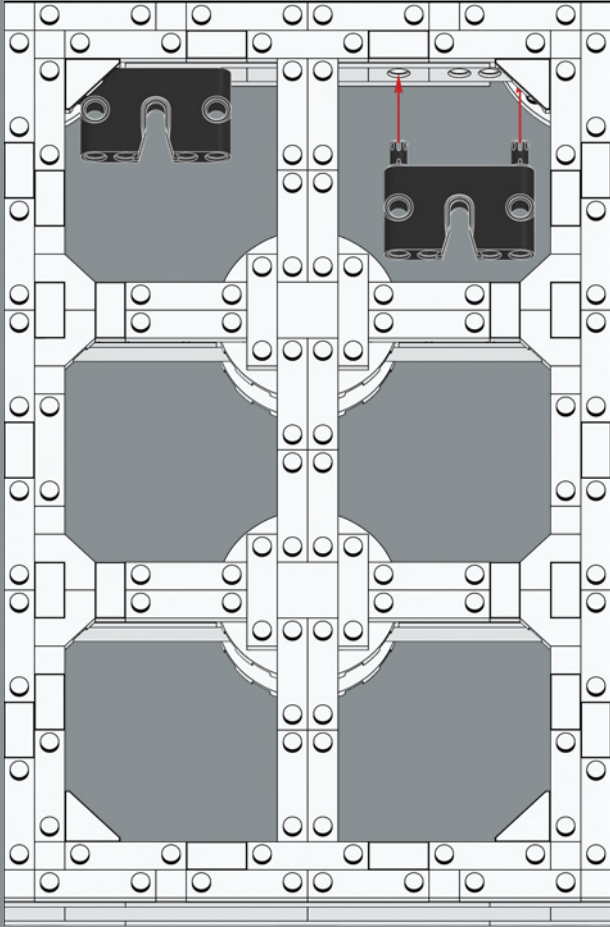

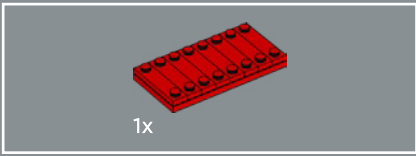

2

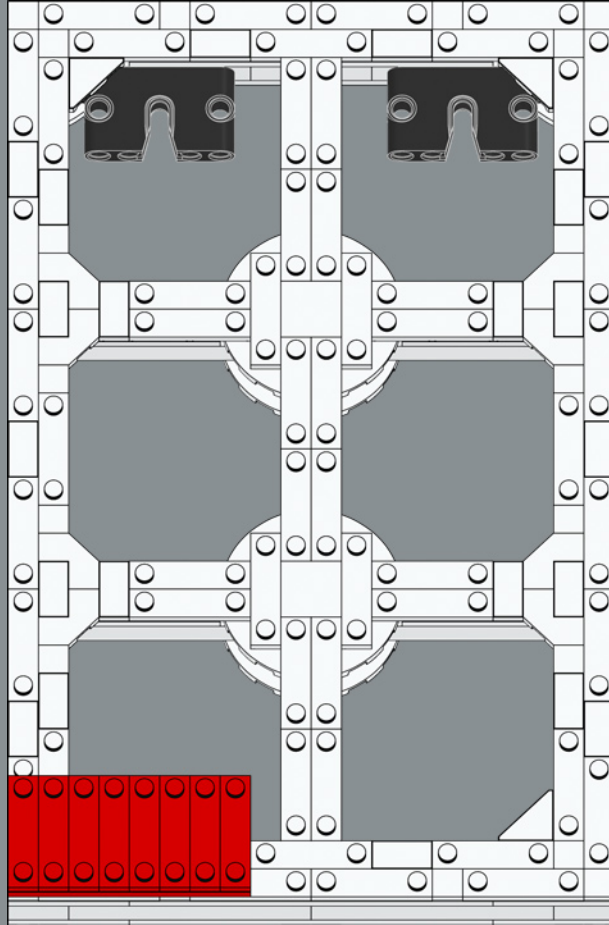

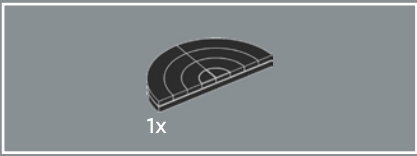

3

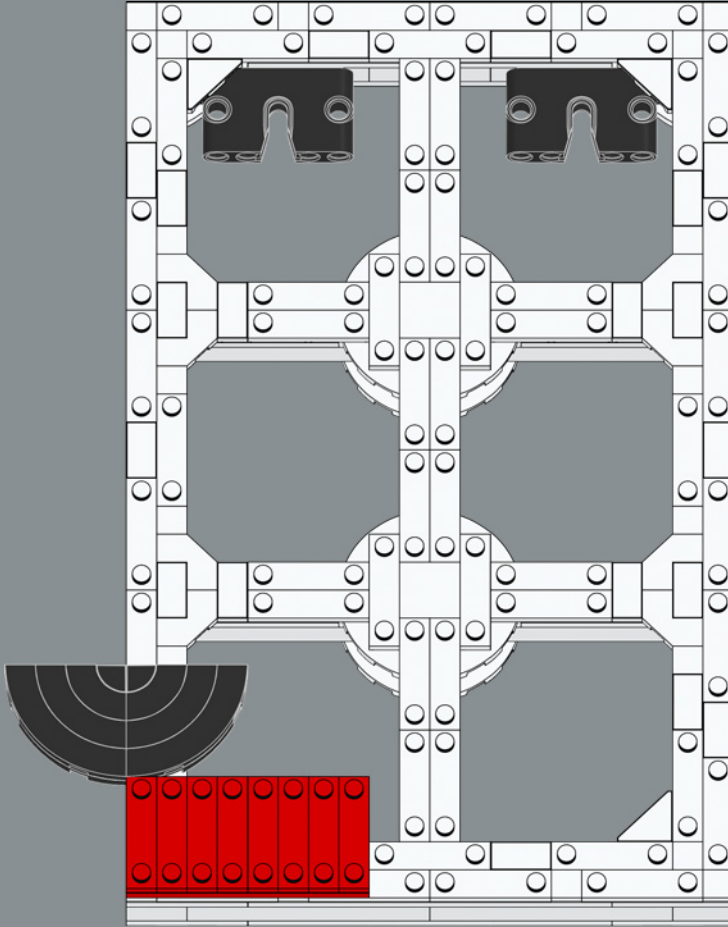

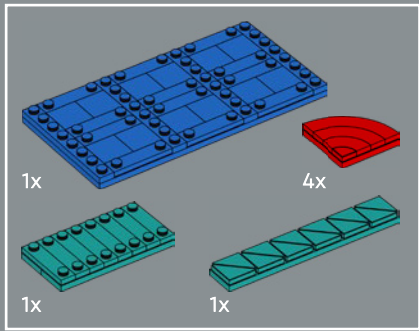

4

1

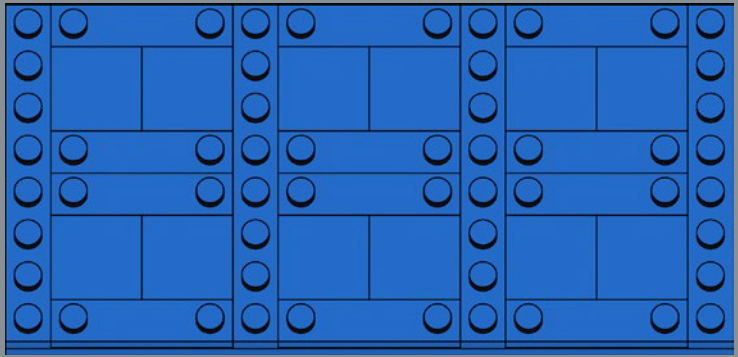

2

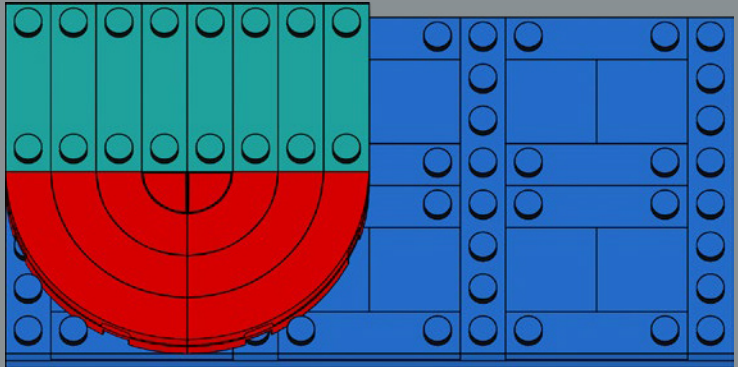

3

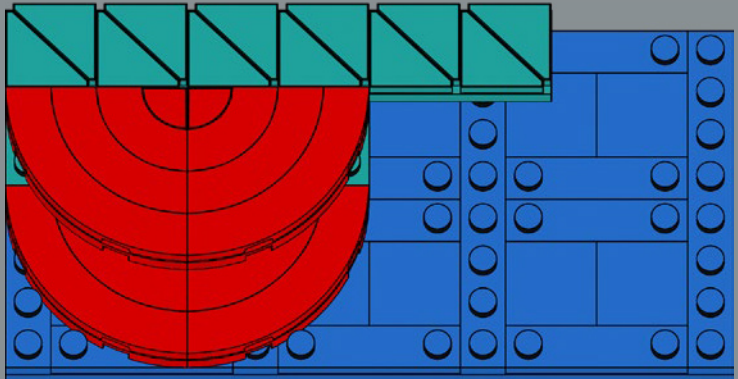

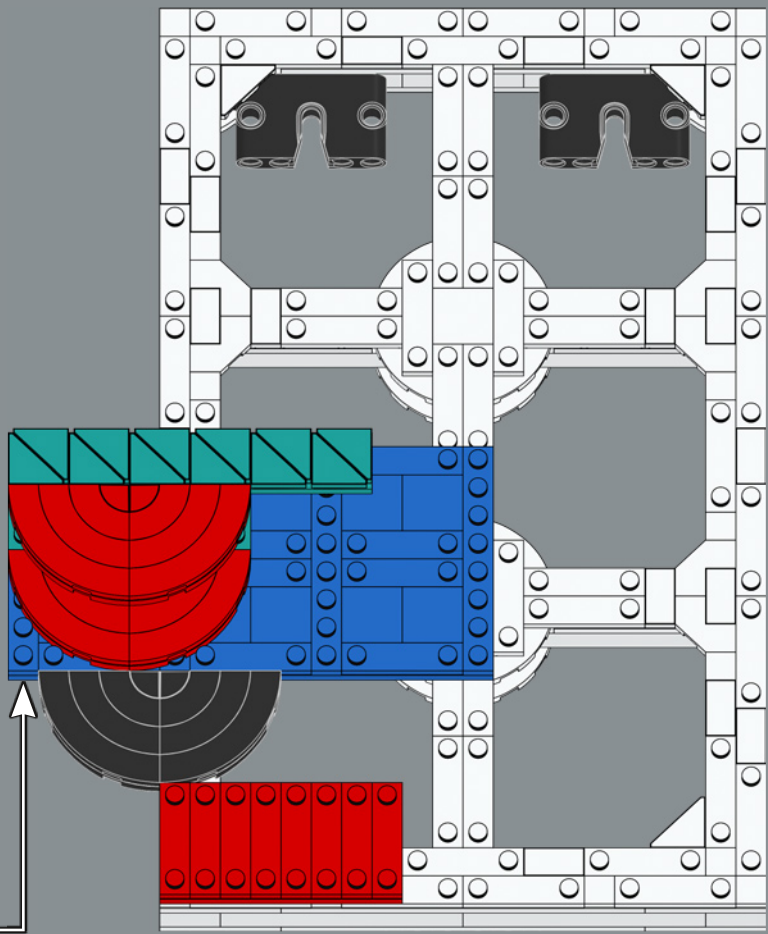

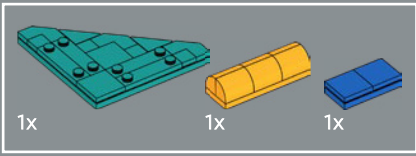

5

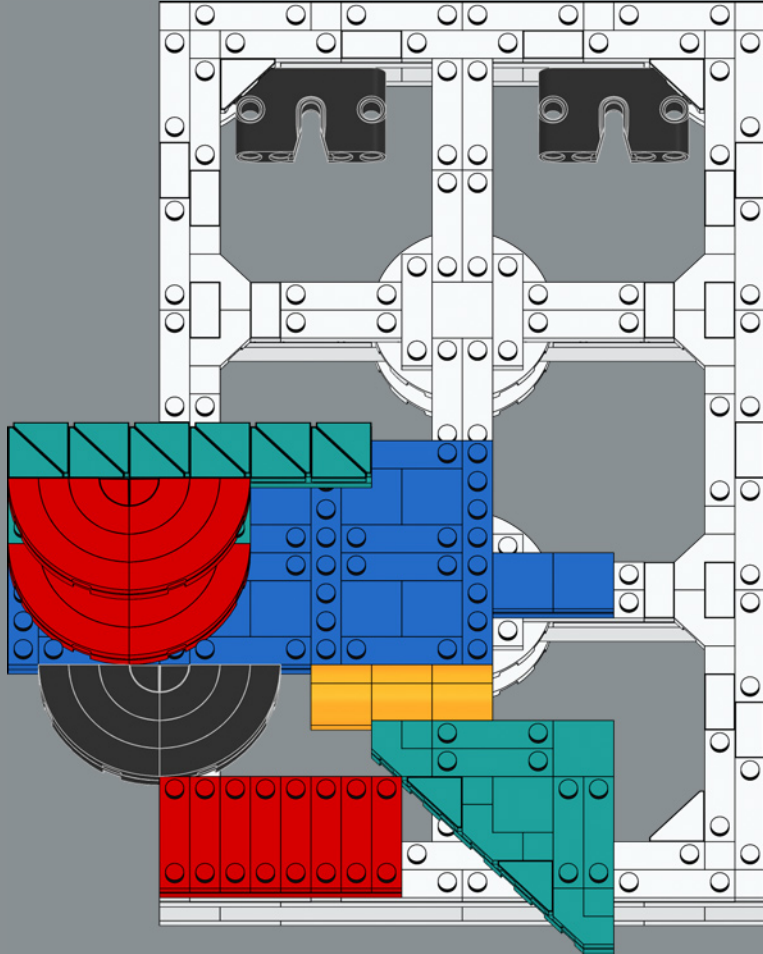

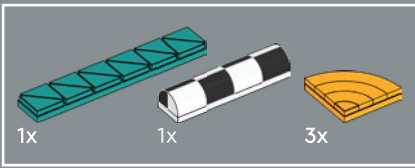

6

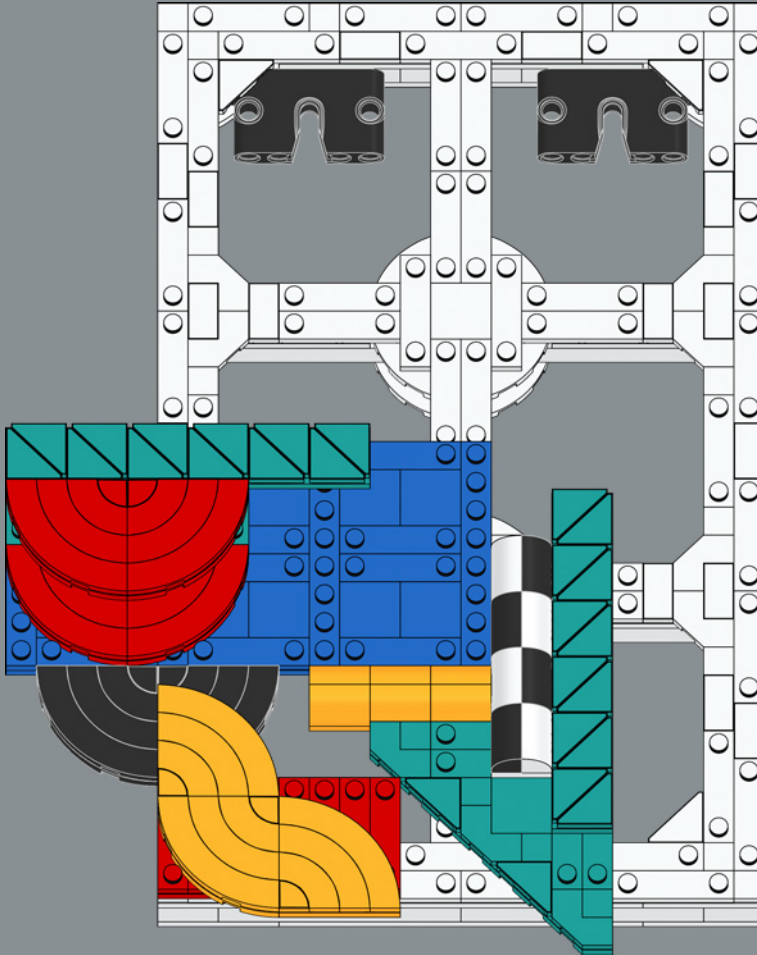

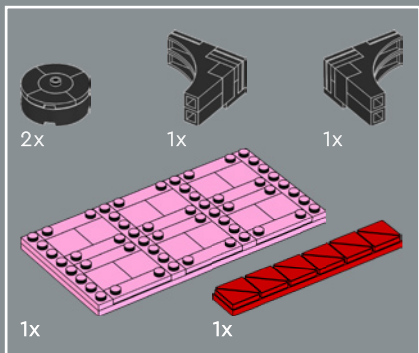

7

1

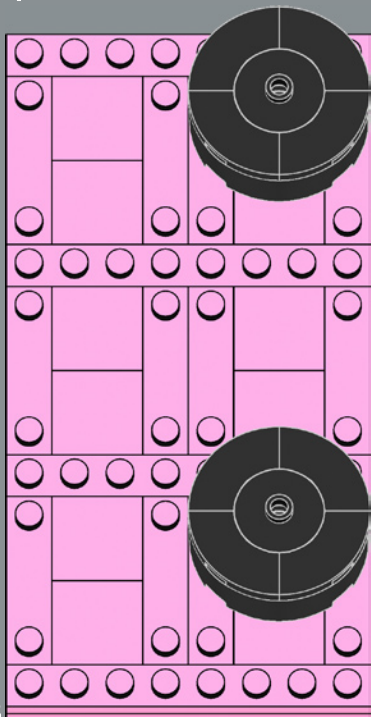

2

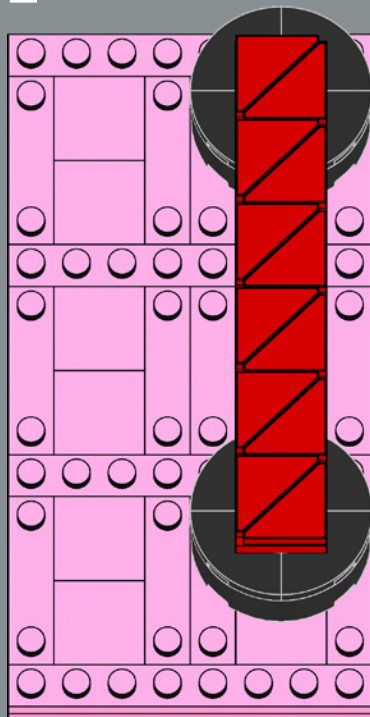

3

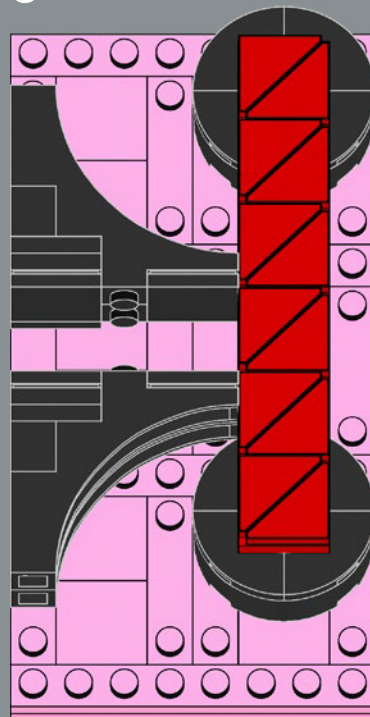

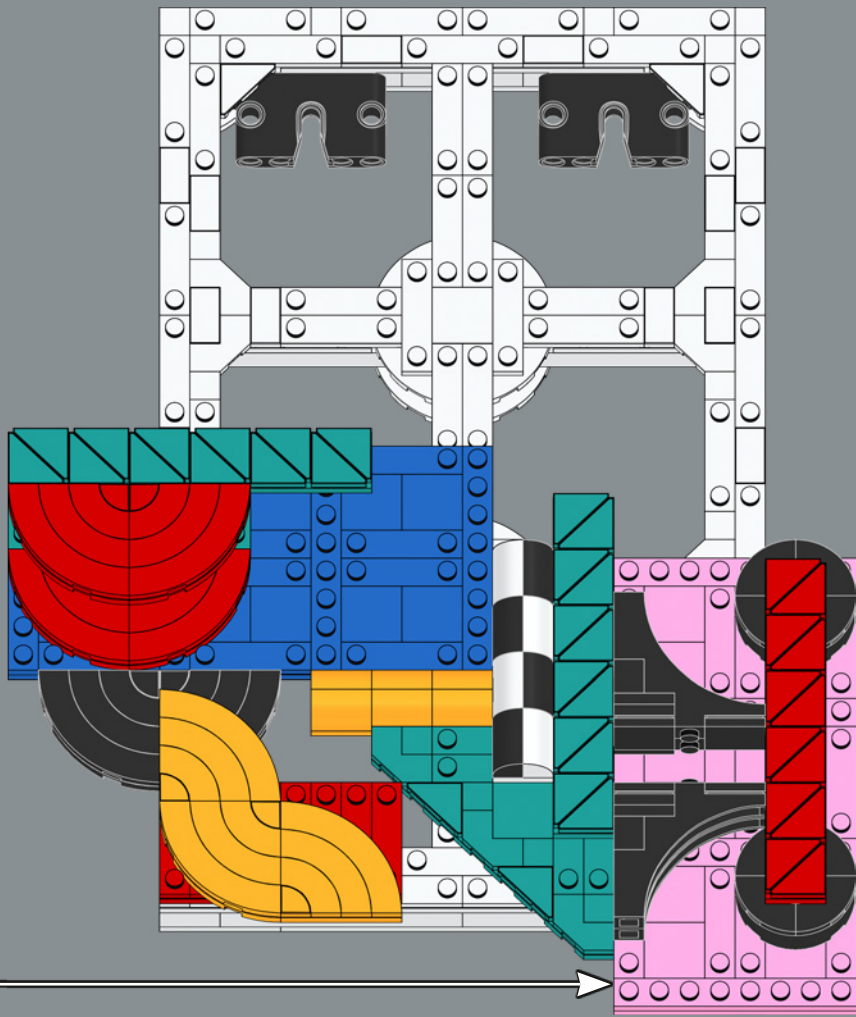

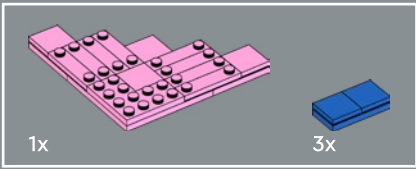

8

1

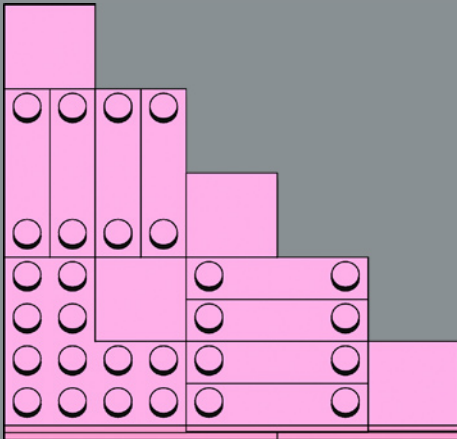

2

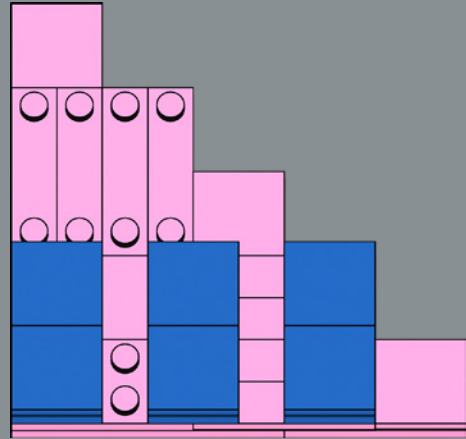

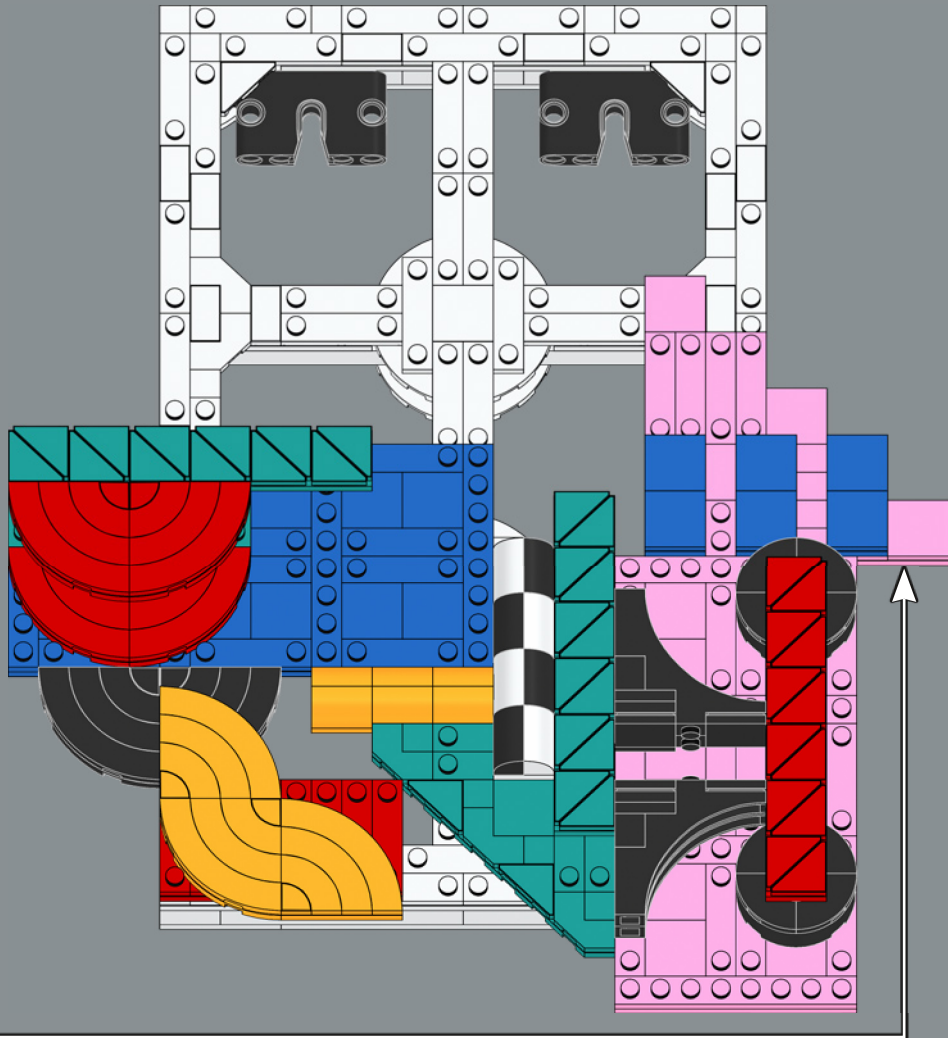

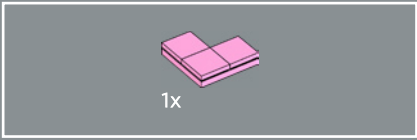

9

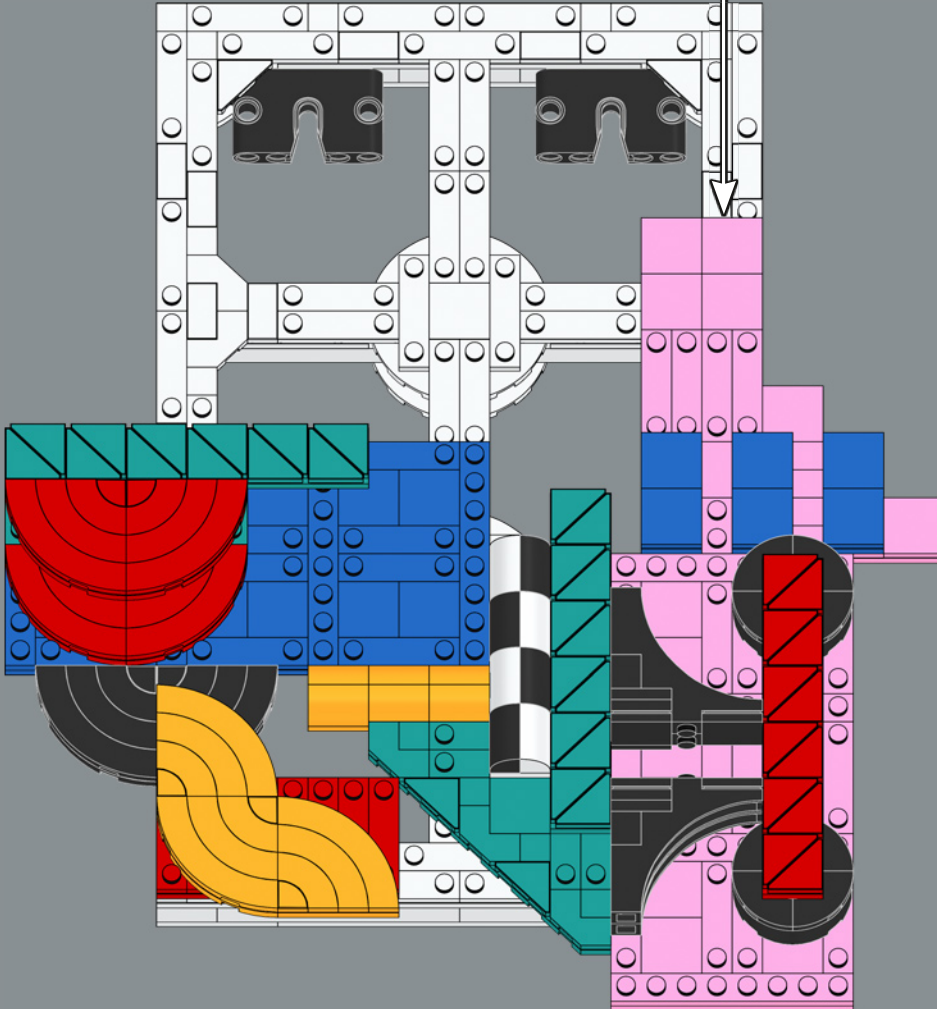
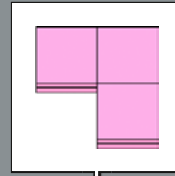

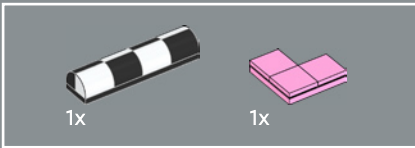

10

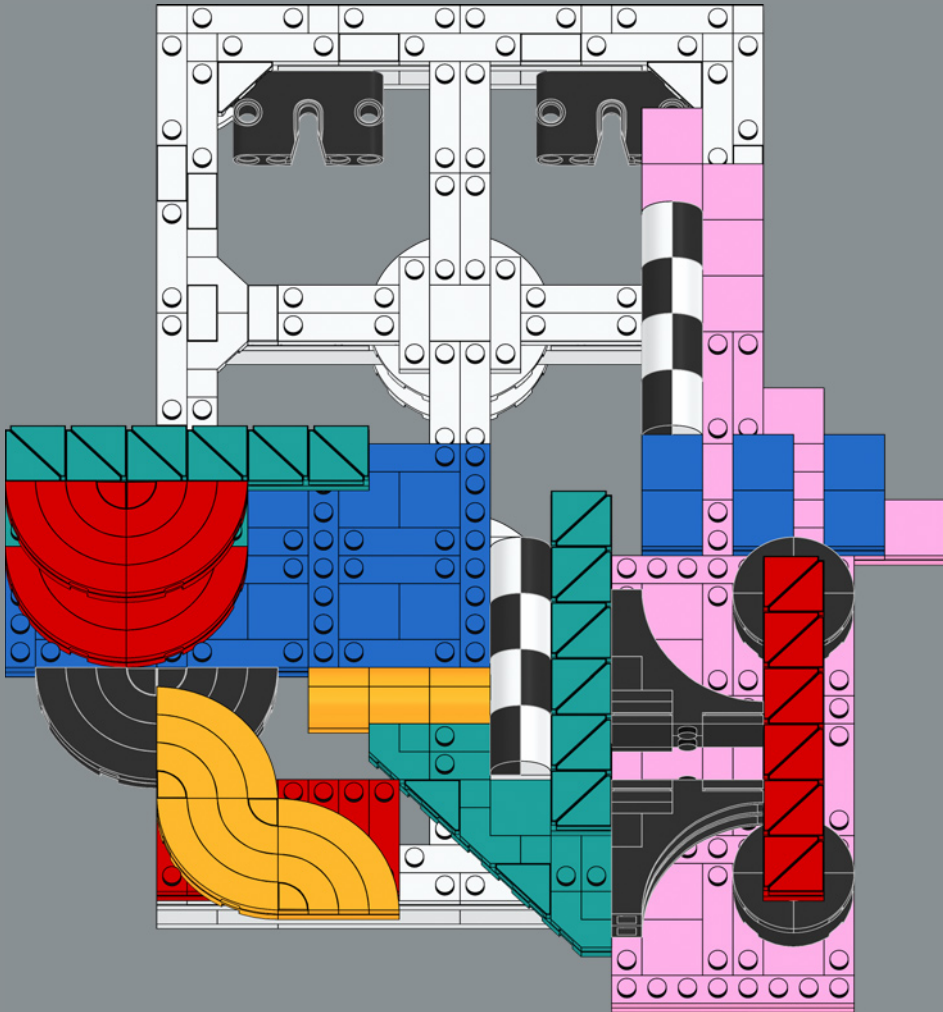

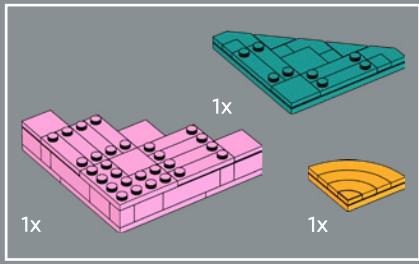

11

1

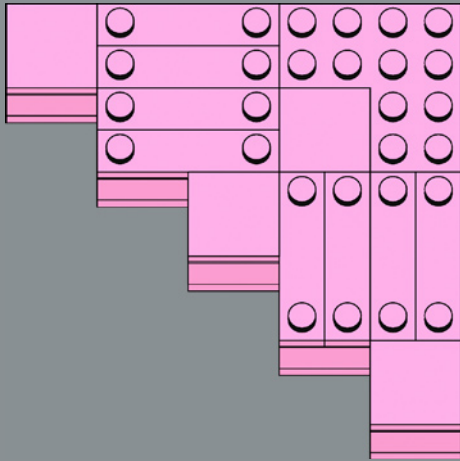

2

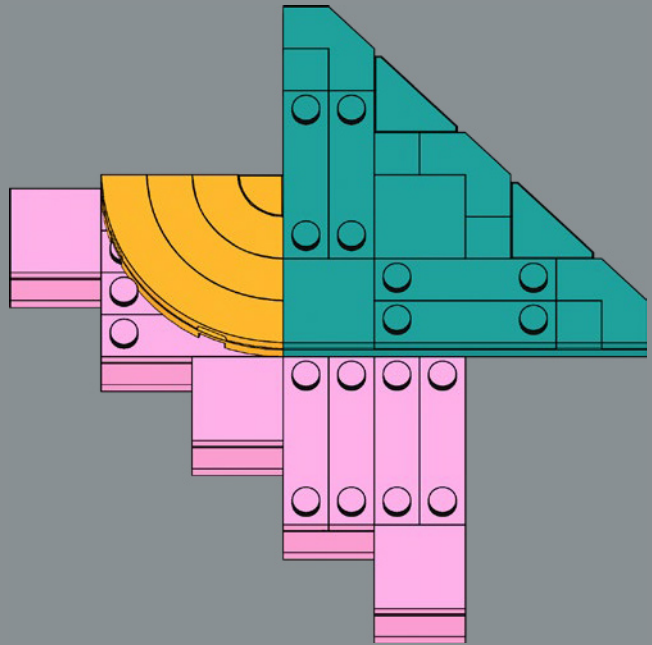

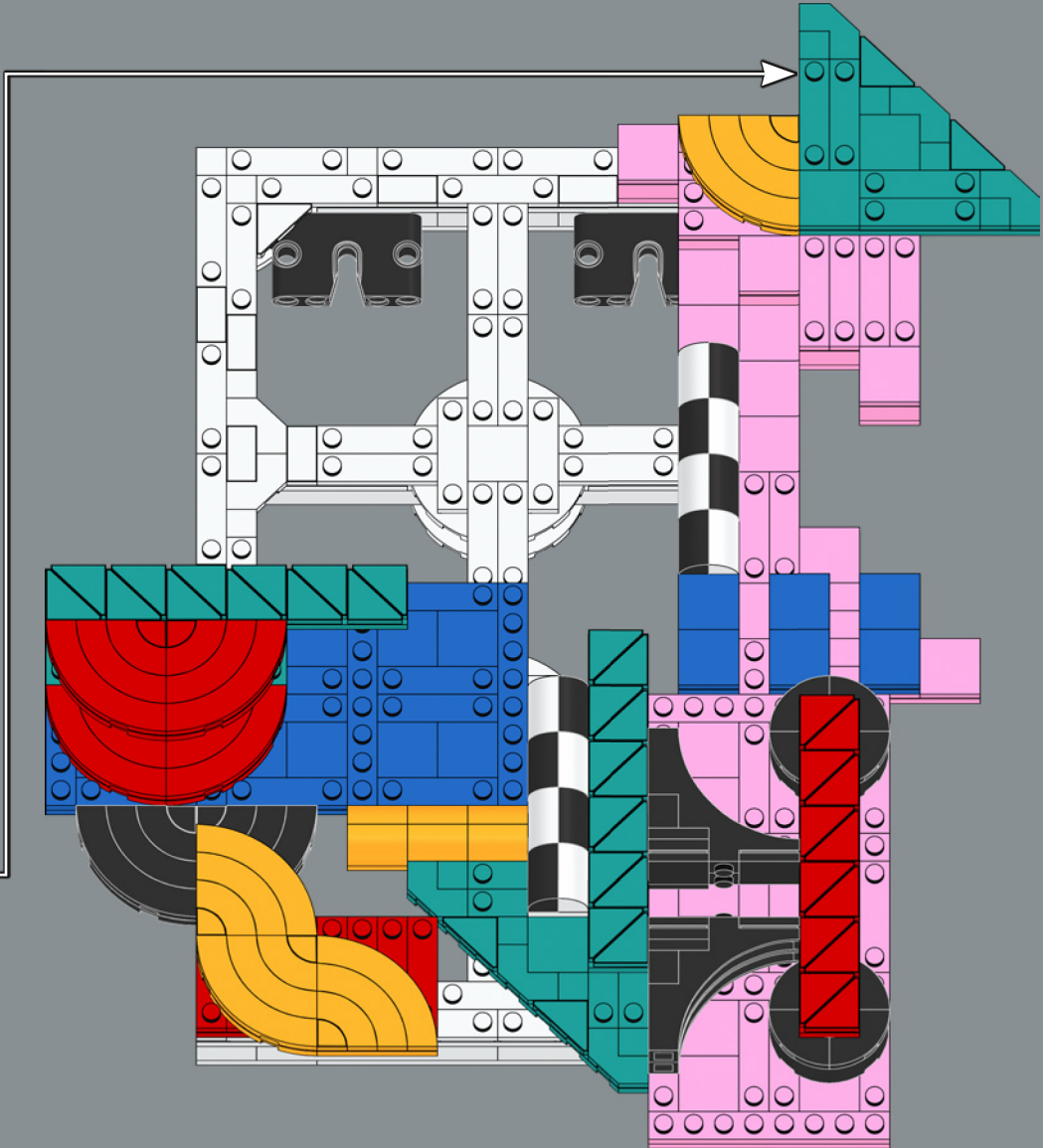

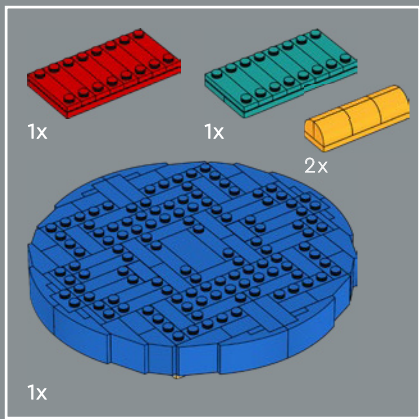

12

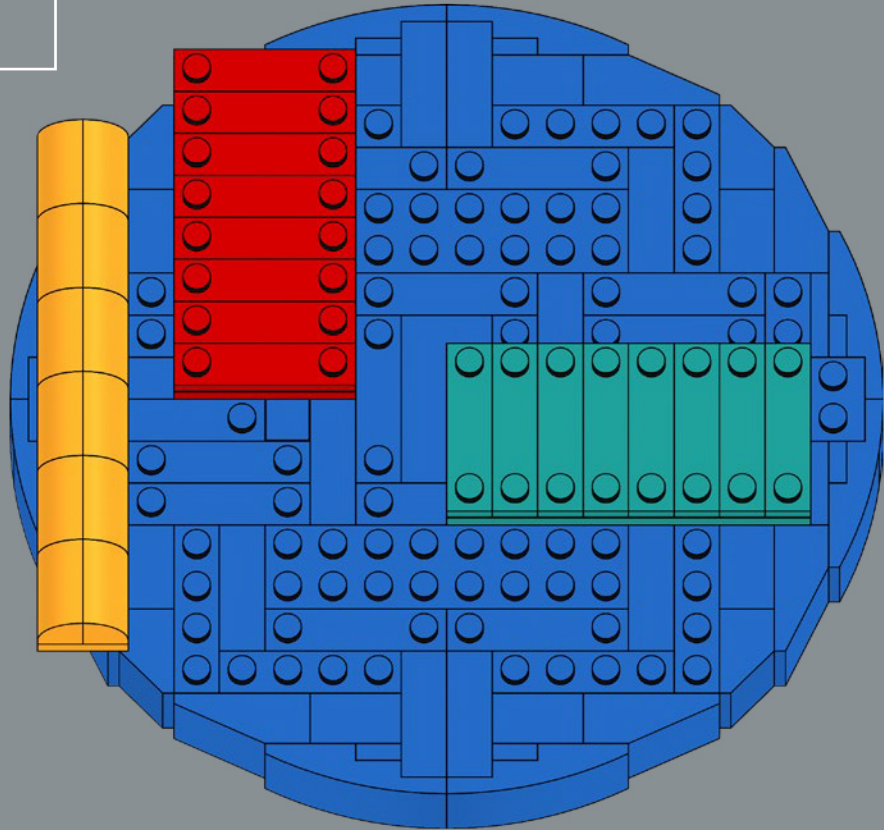

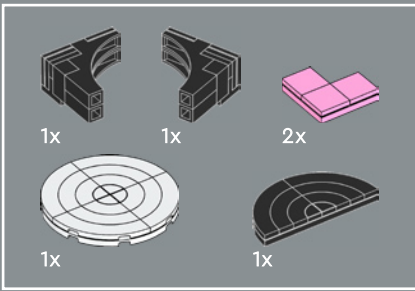

13

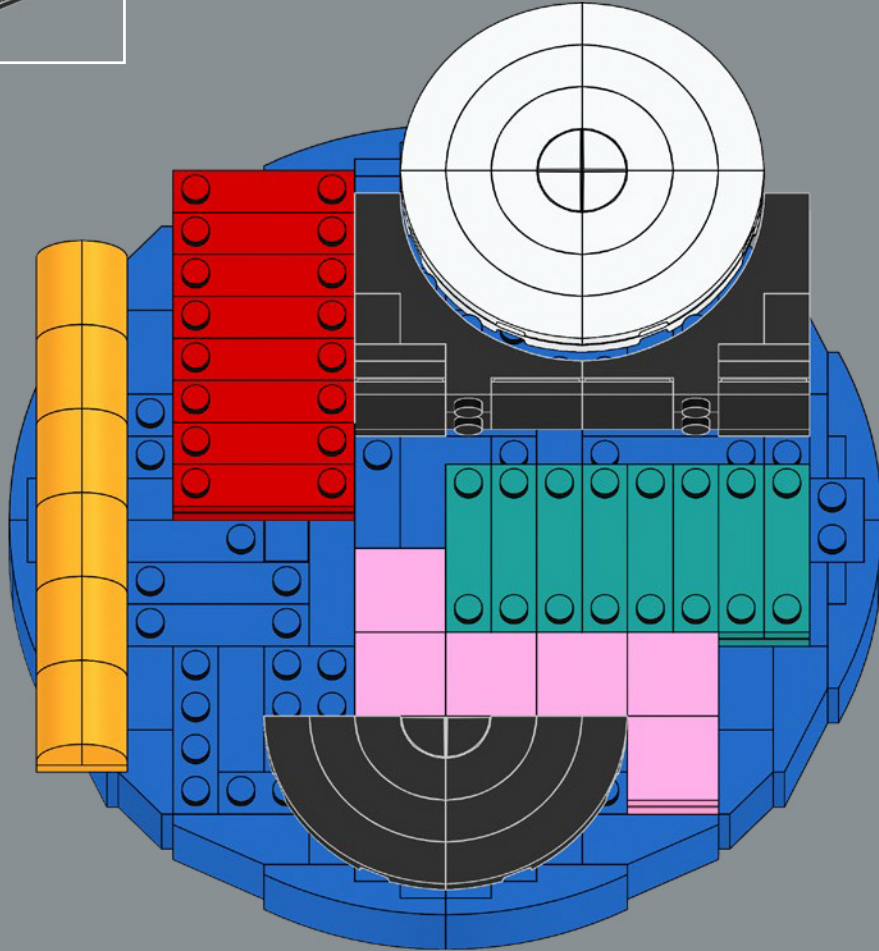

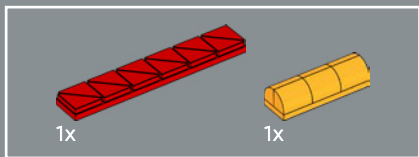

14

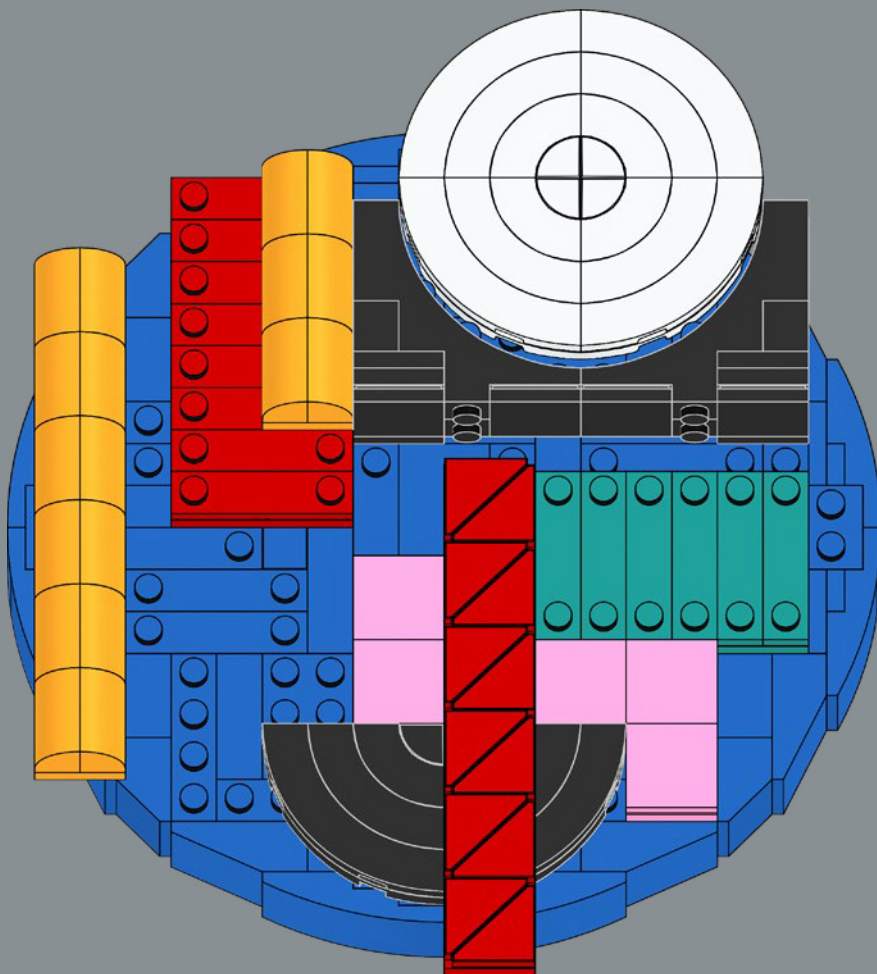

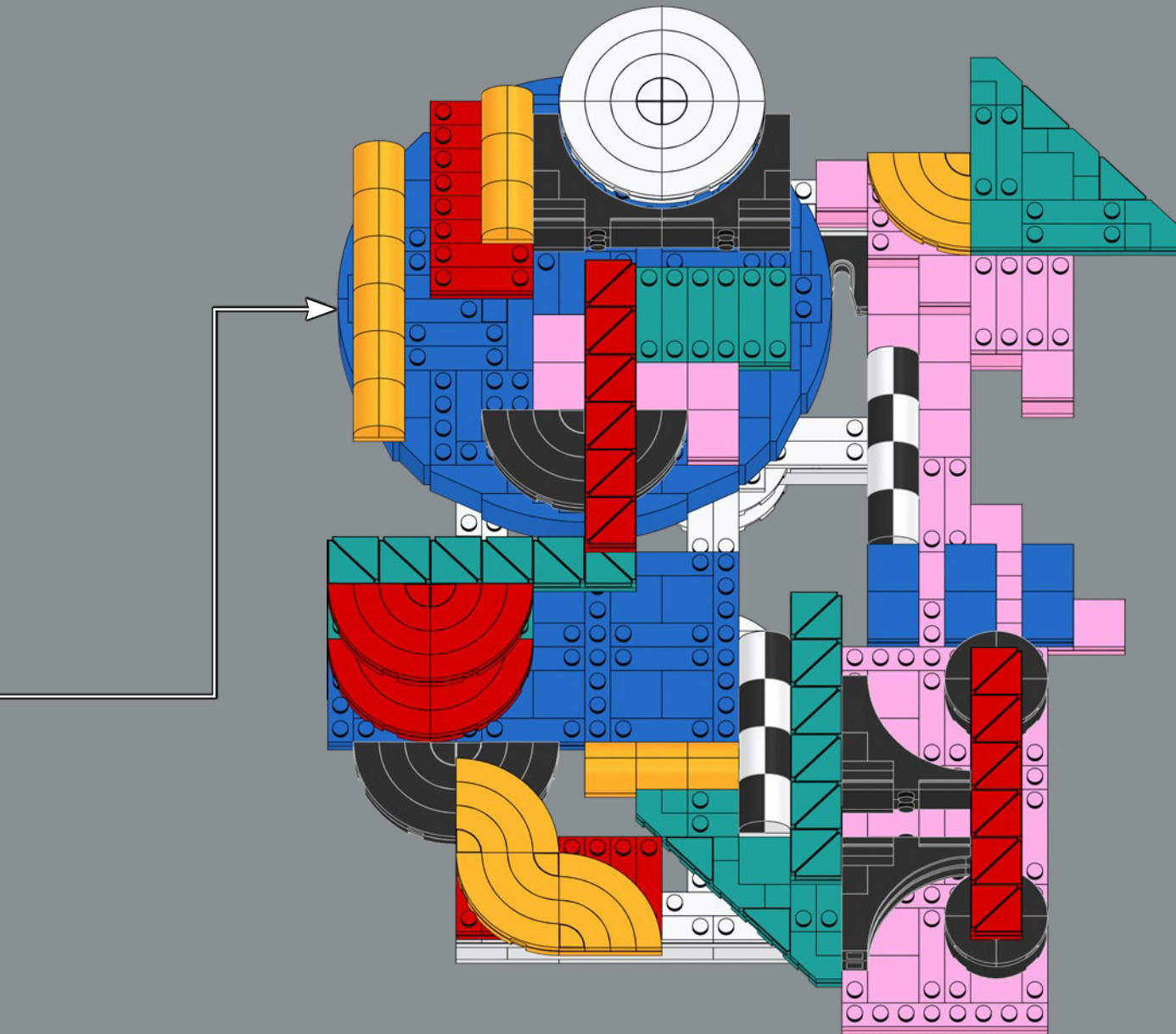

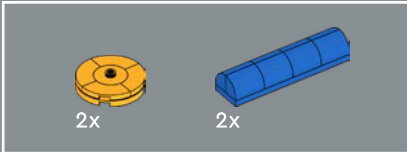
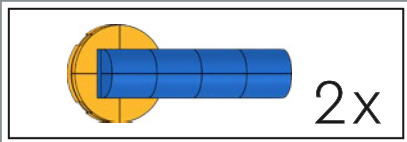

15

1

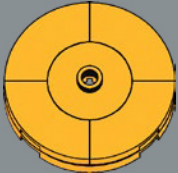

2

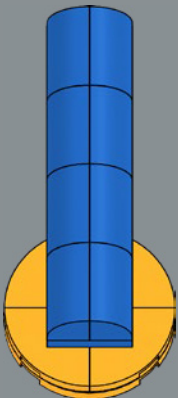

2x

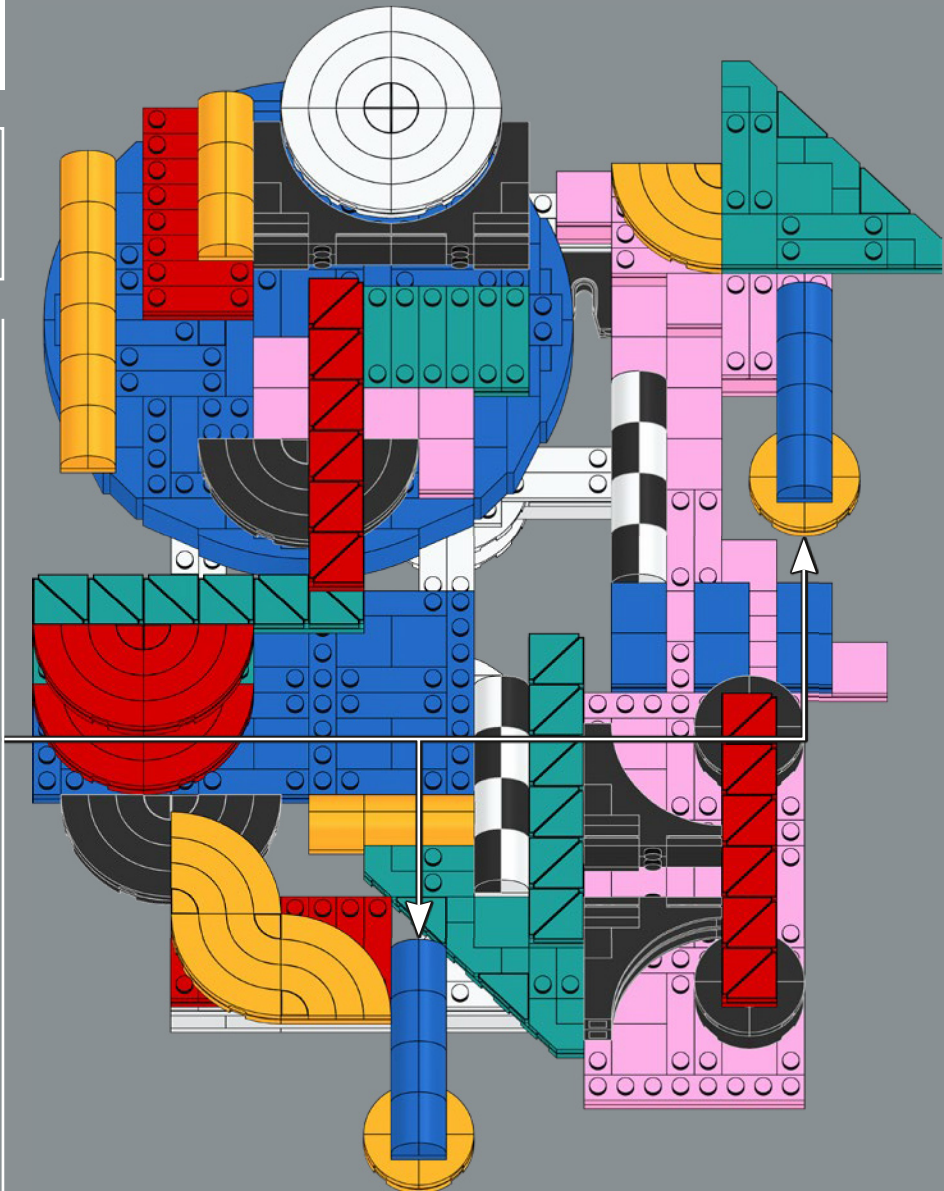

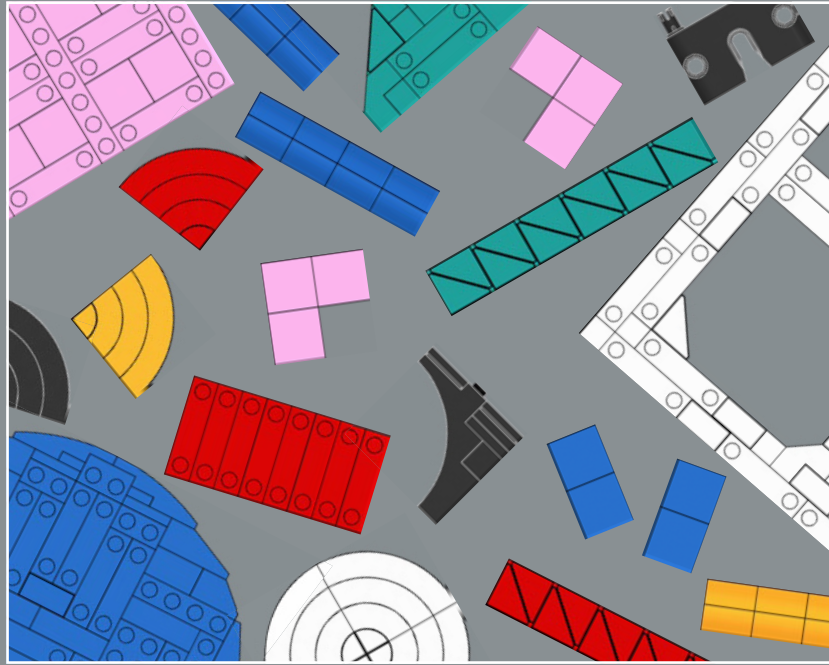

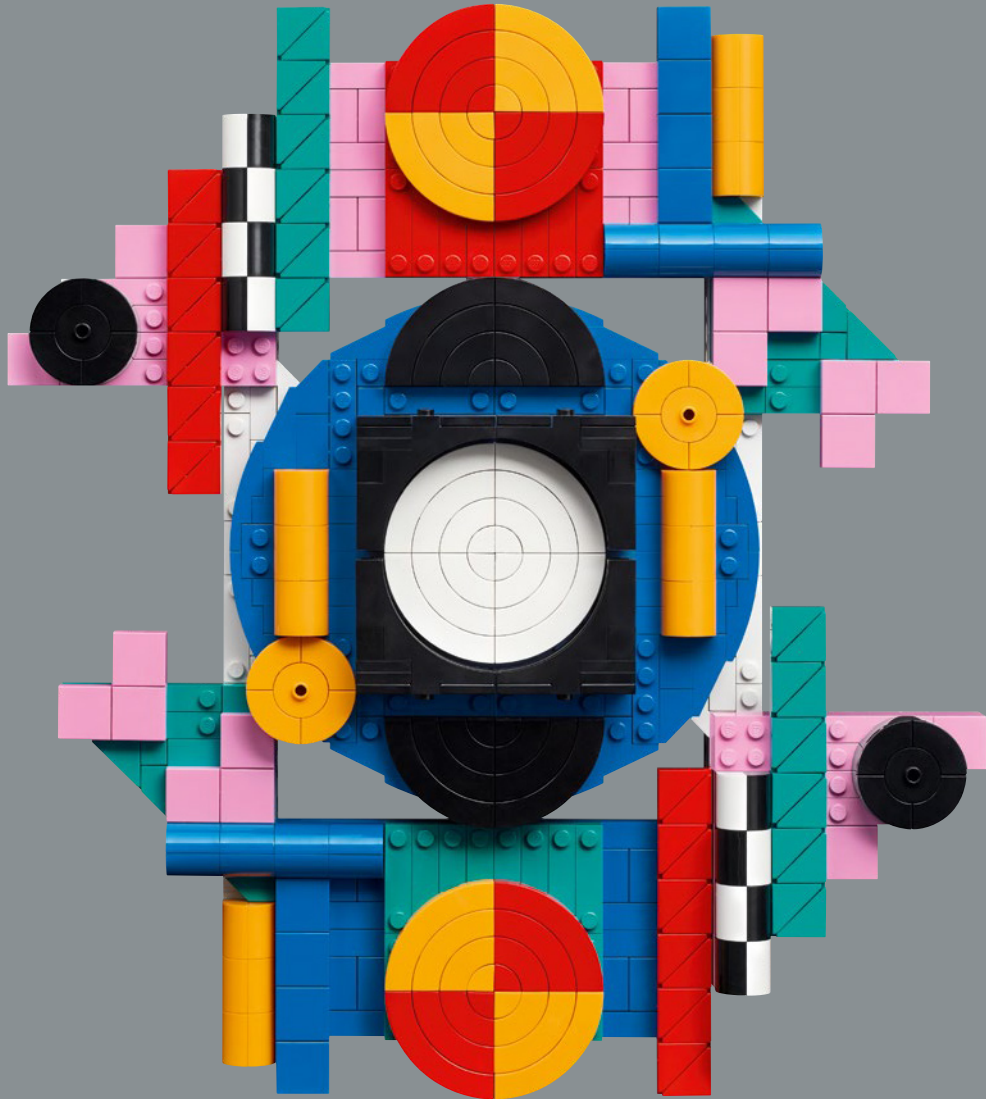



1

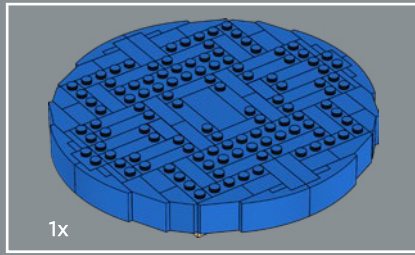
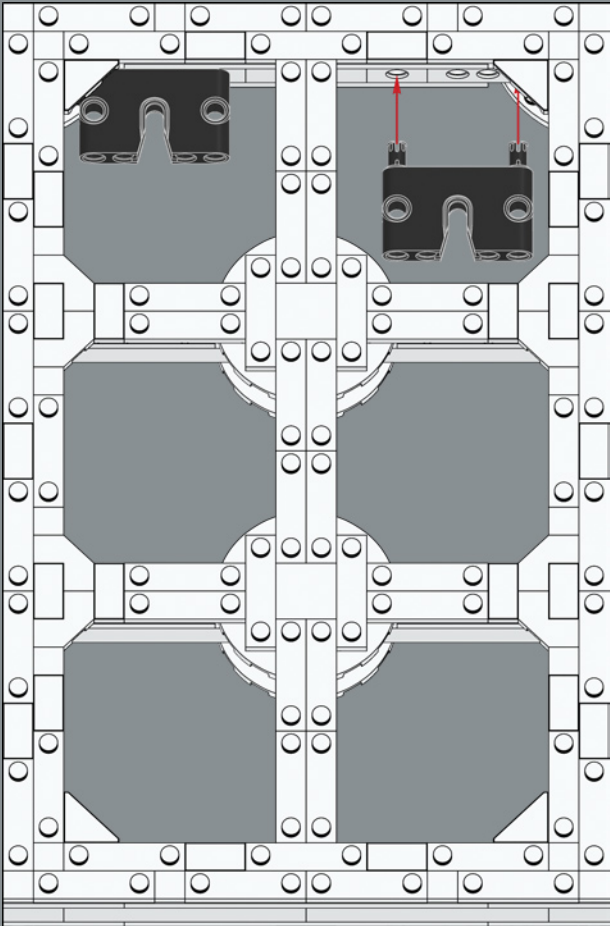

2

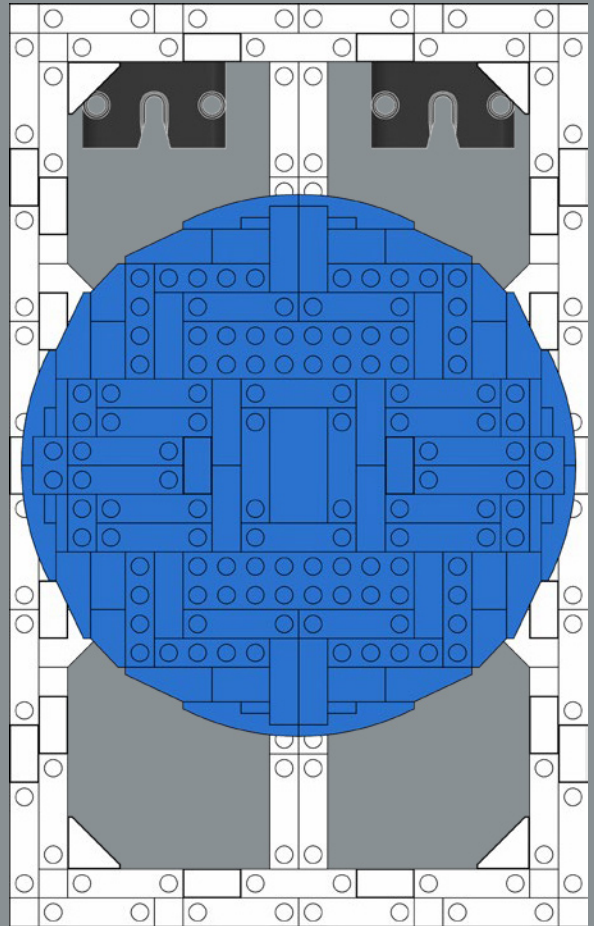

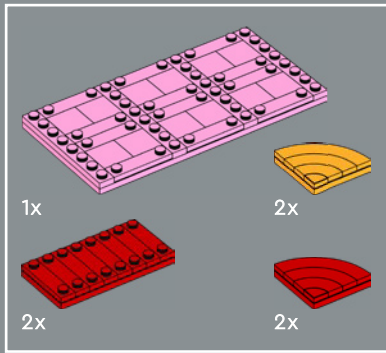

1

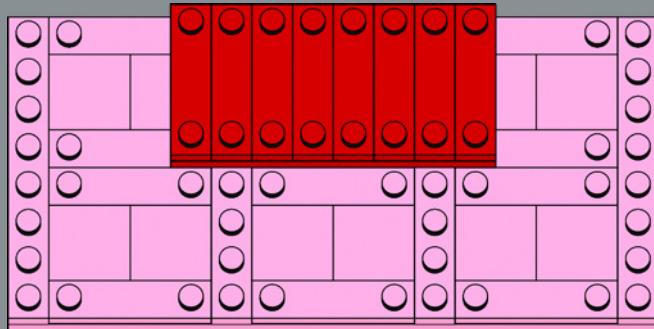

3

2

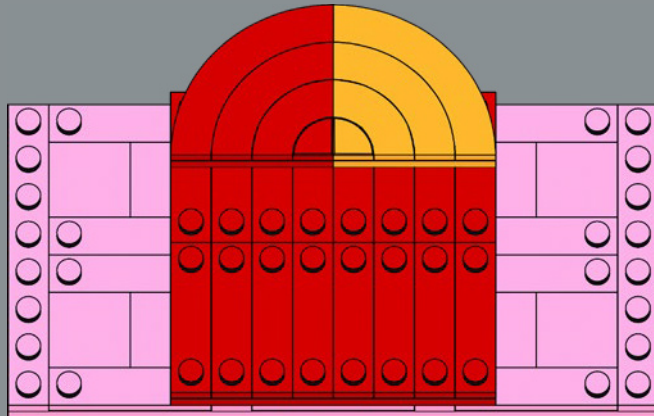

3

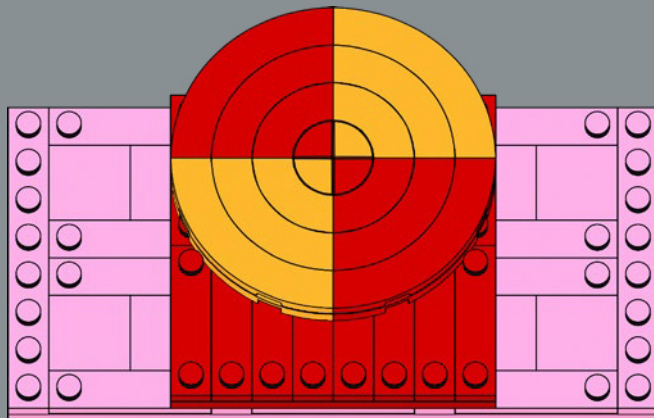

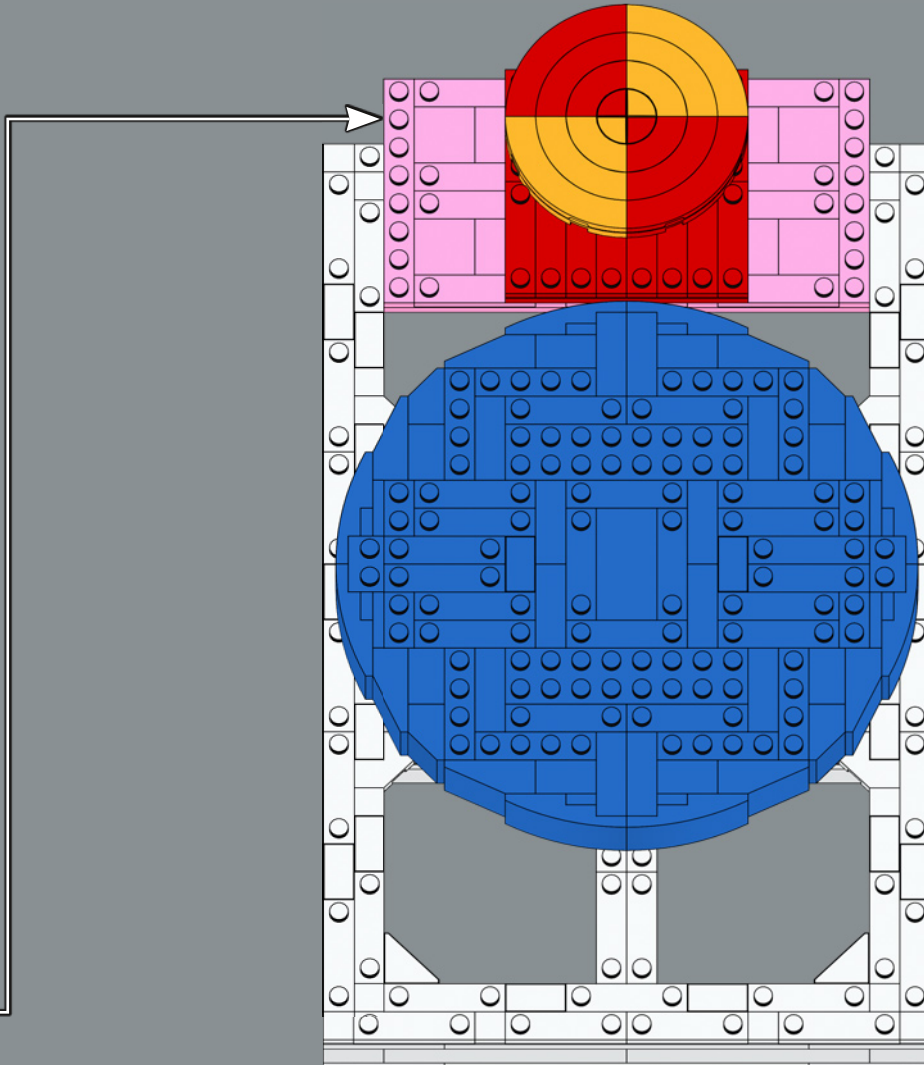

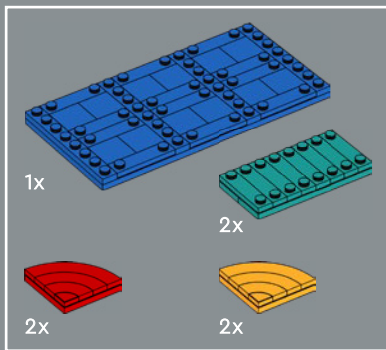

4

1

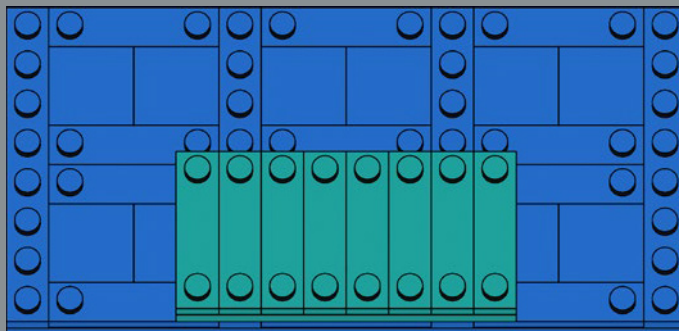

2

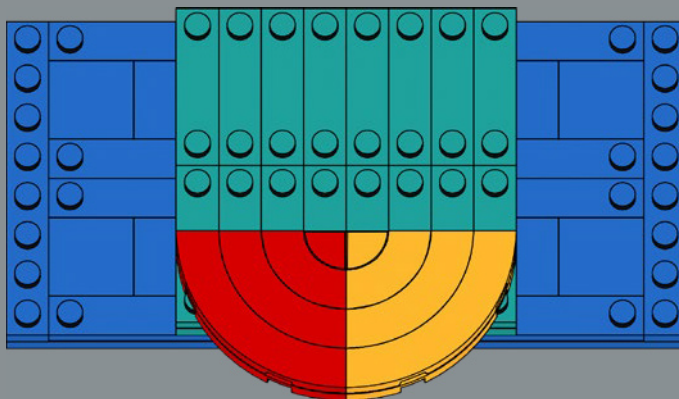

3

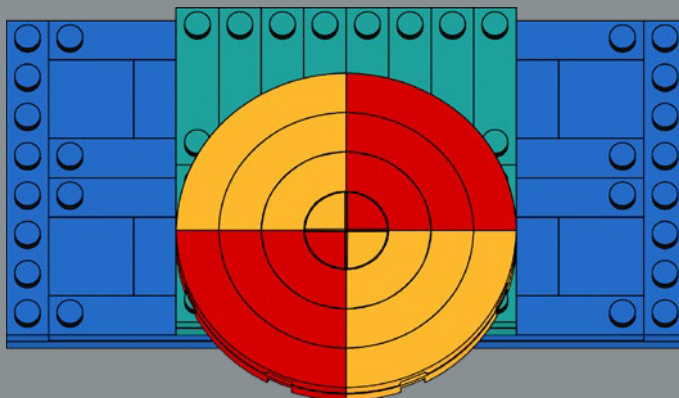

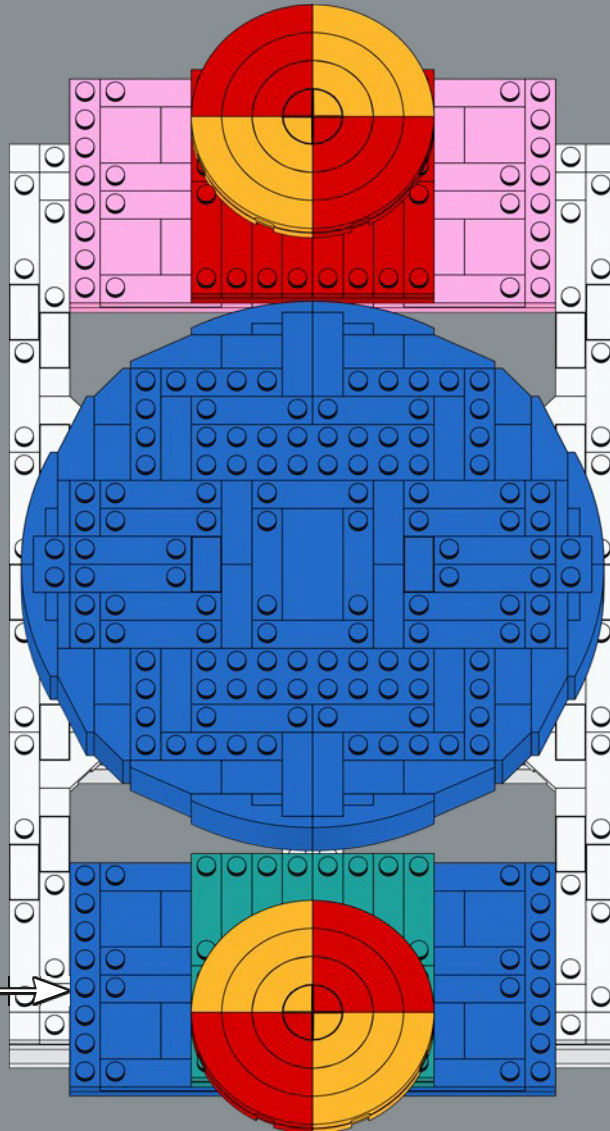

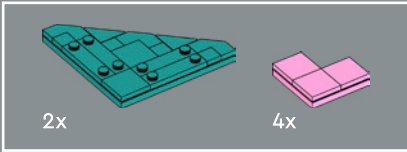
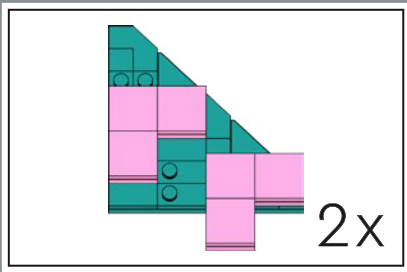

5

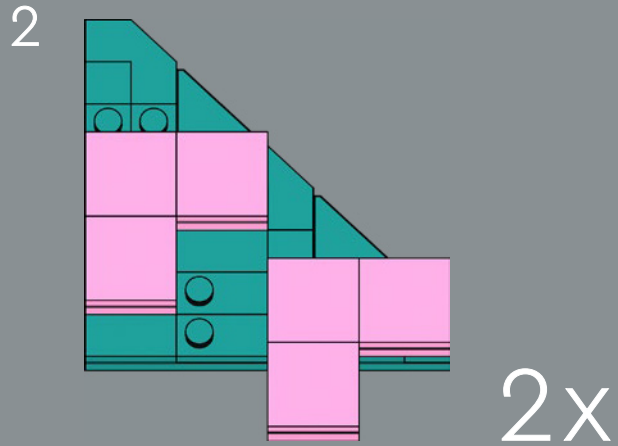
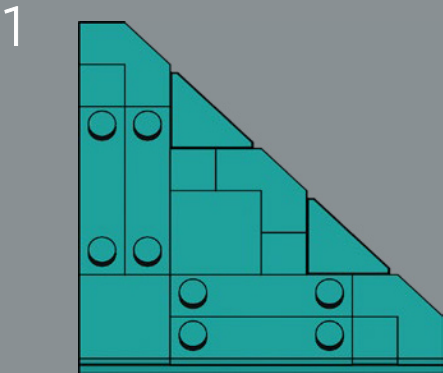

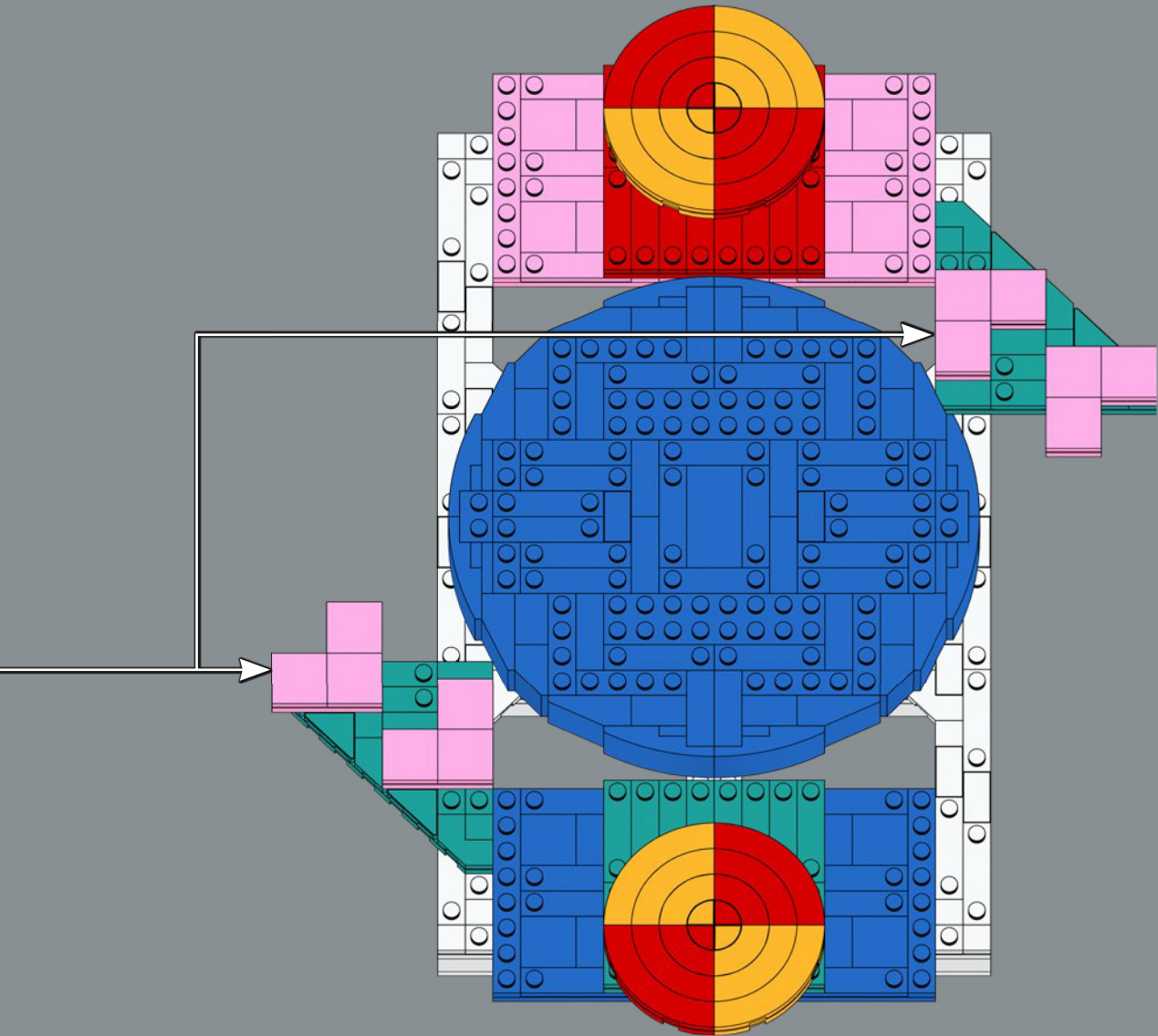

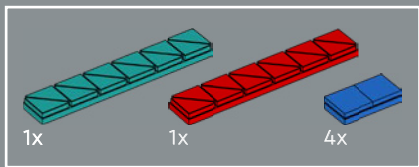

6

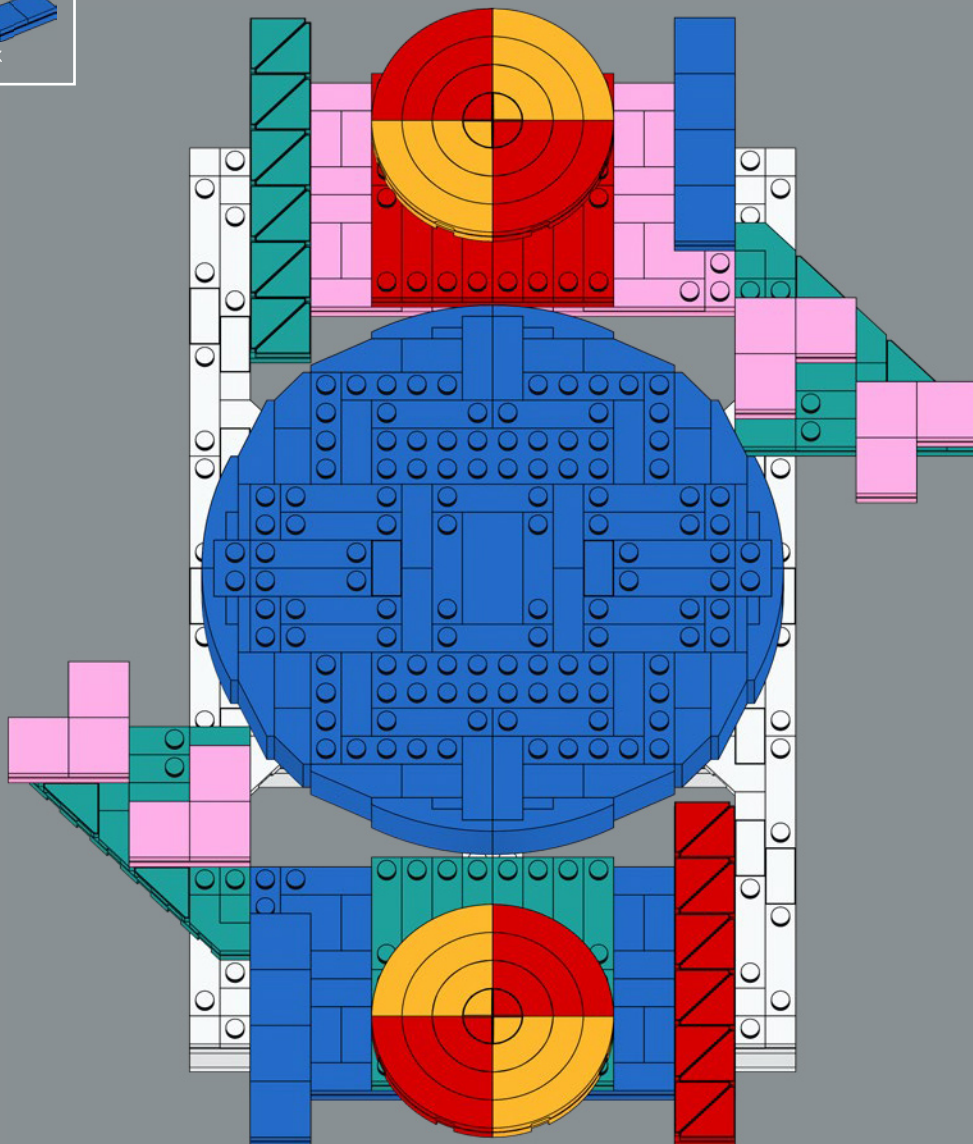

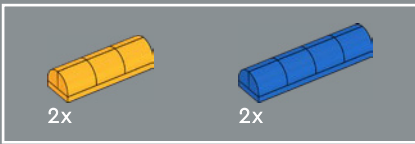

7

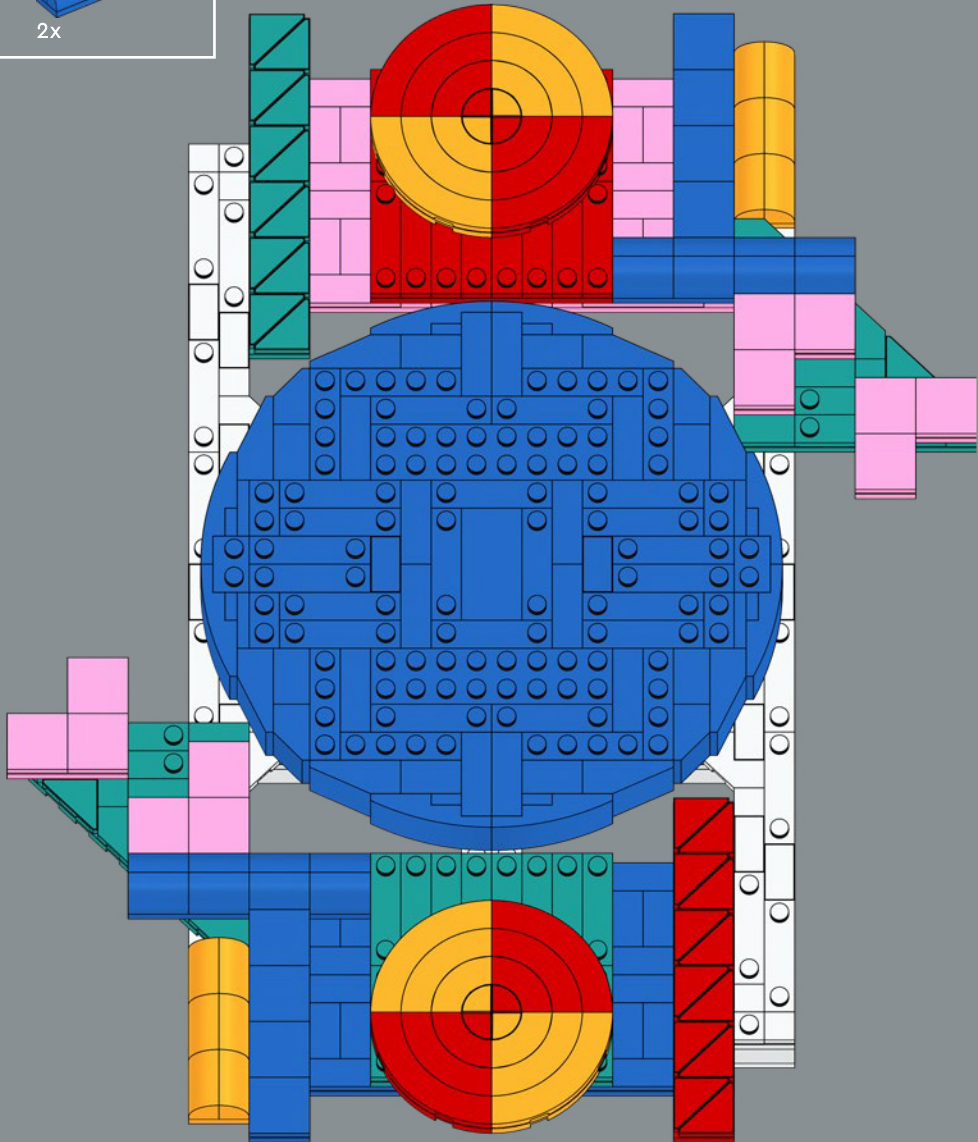

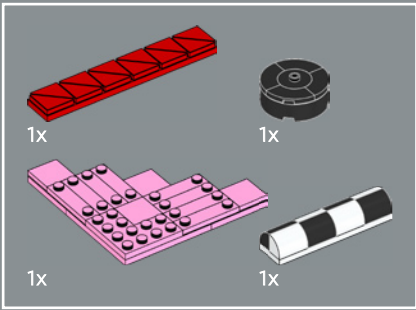

8

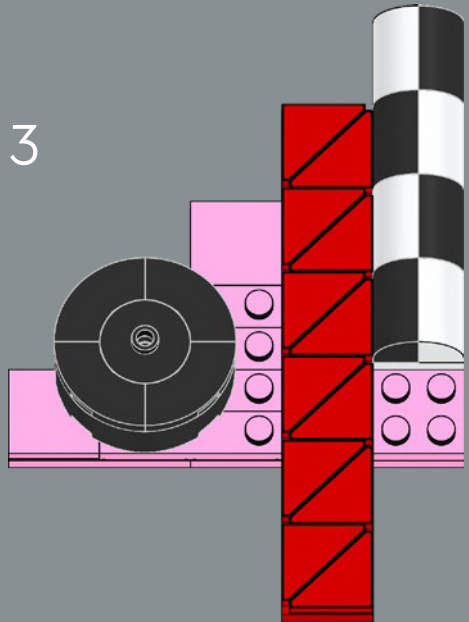
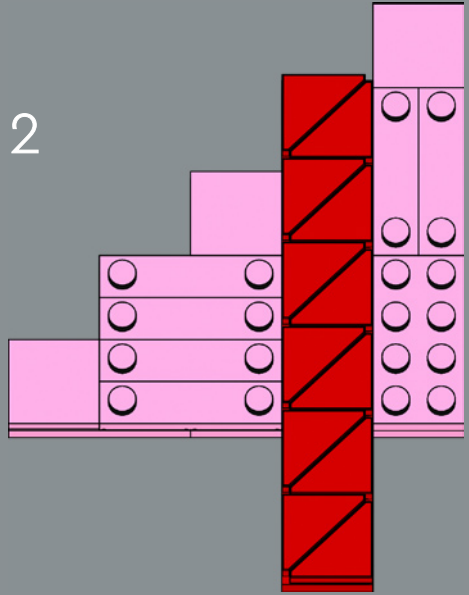
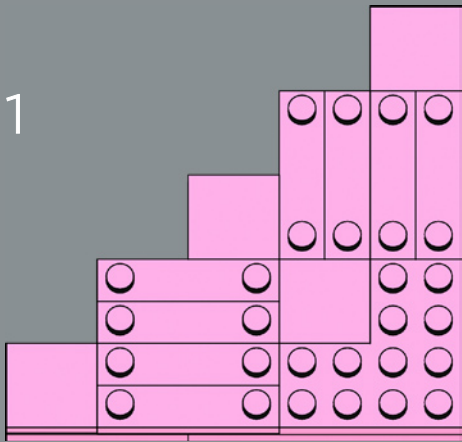

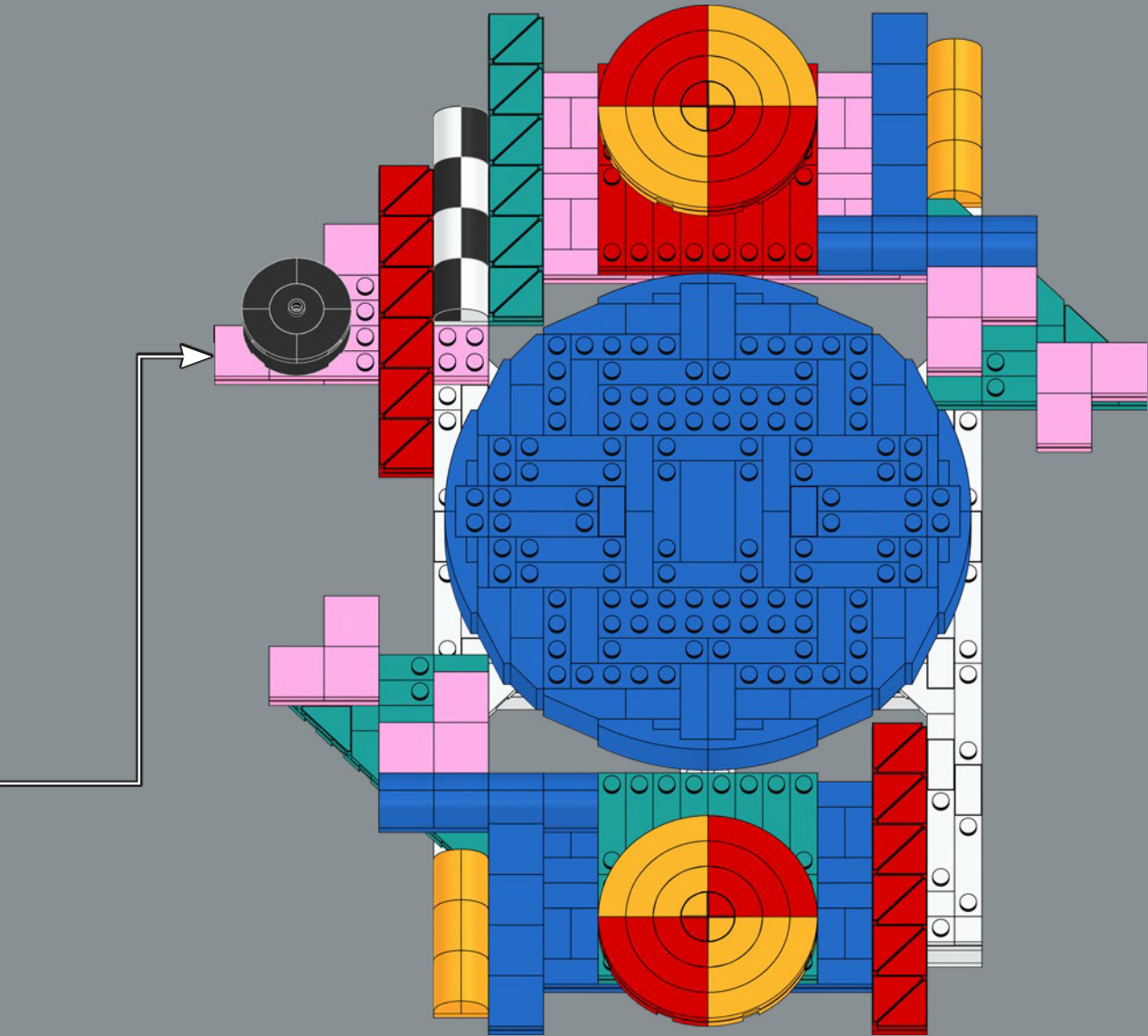

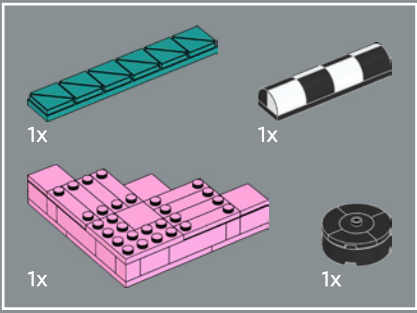

9

1

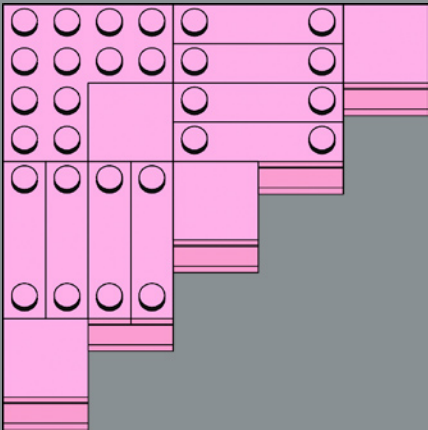

144

2

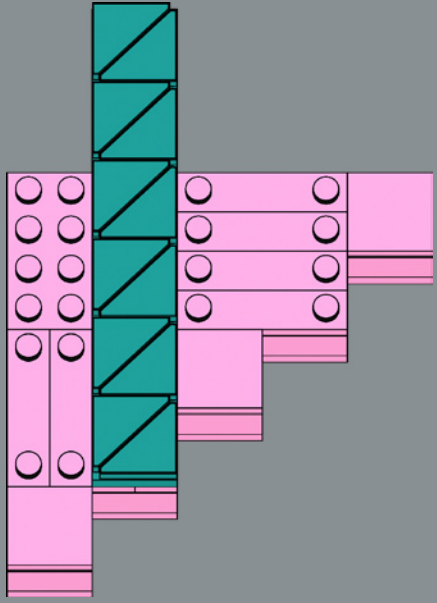

3

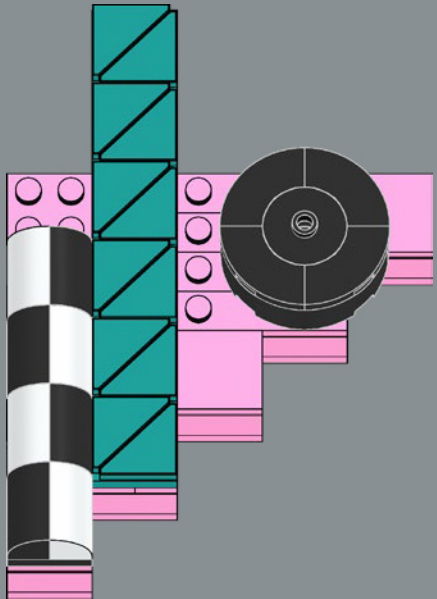

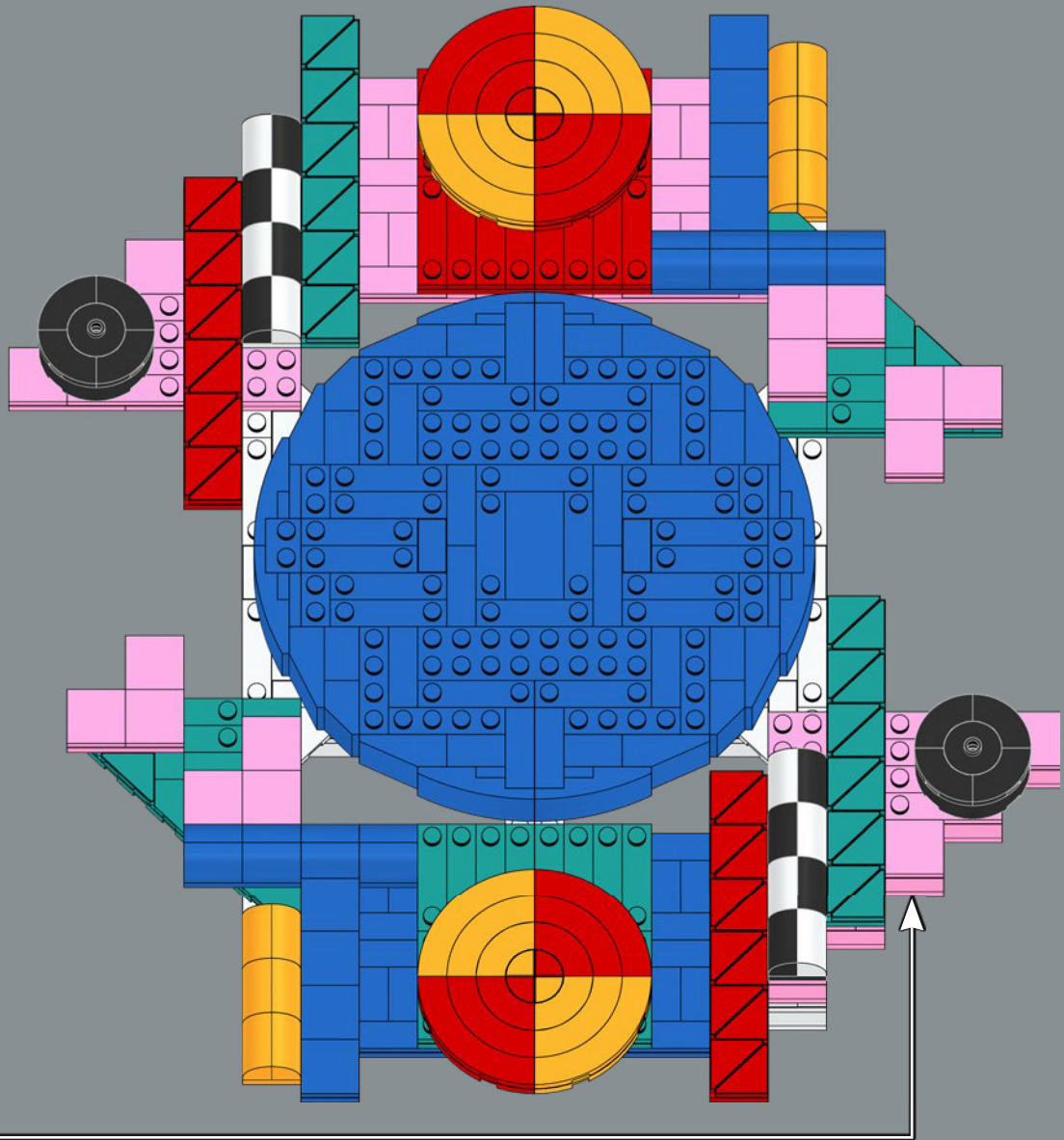

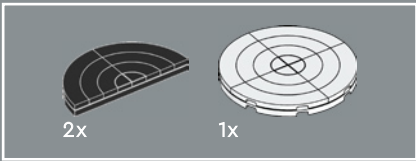

10

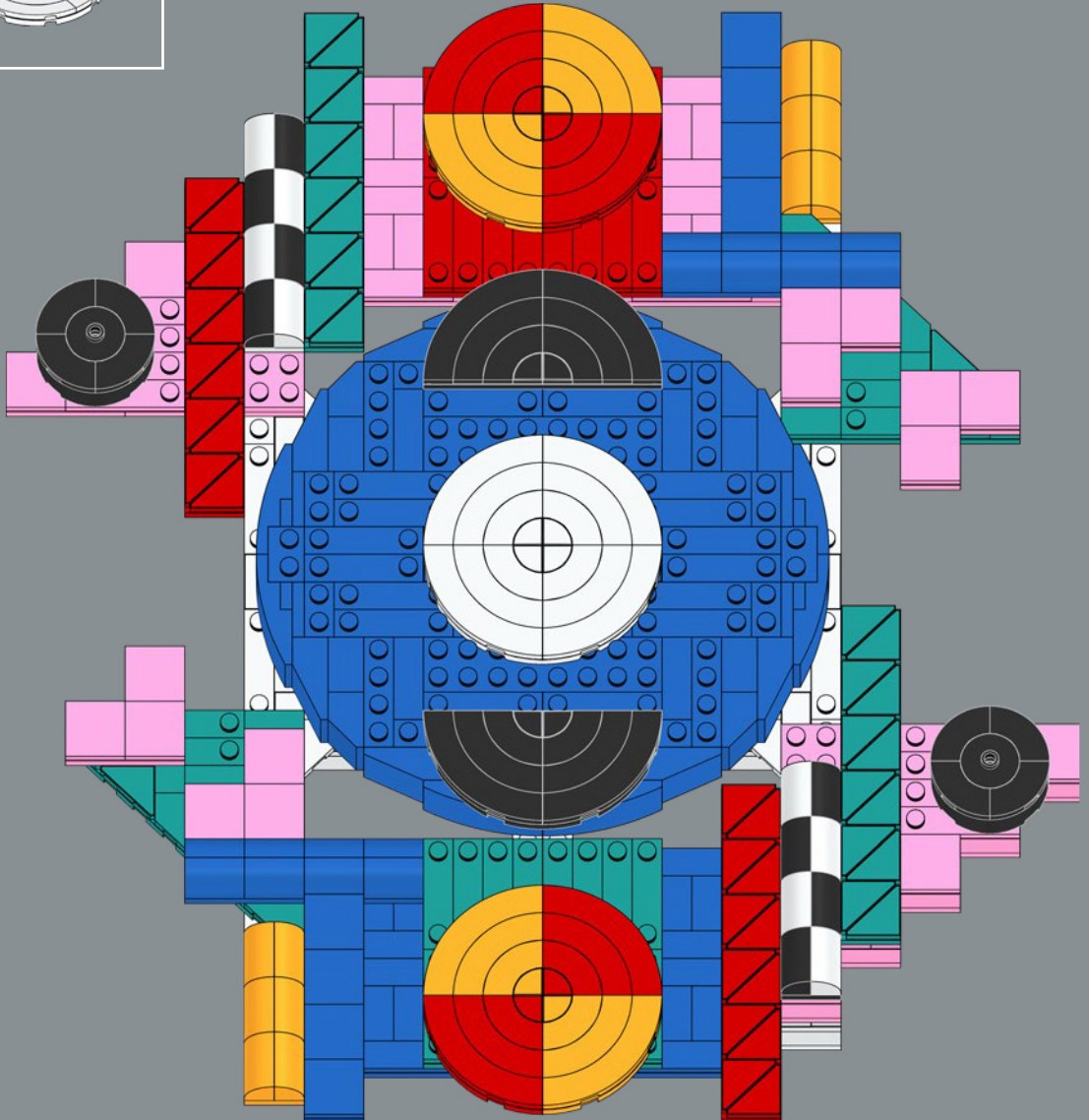

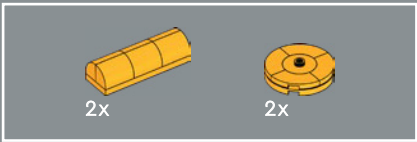

11

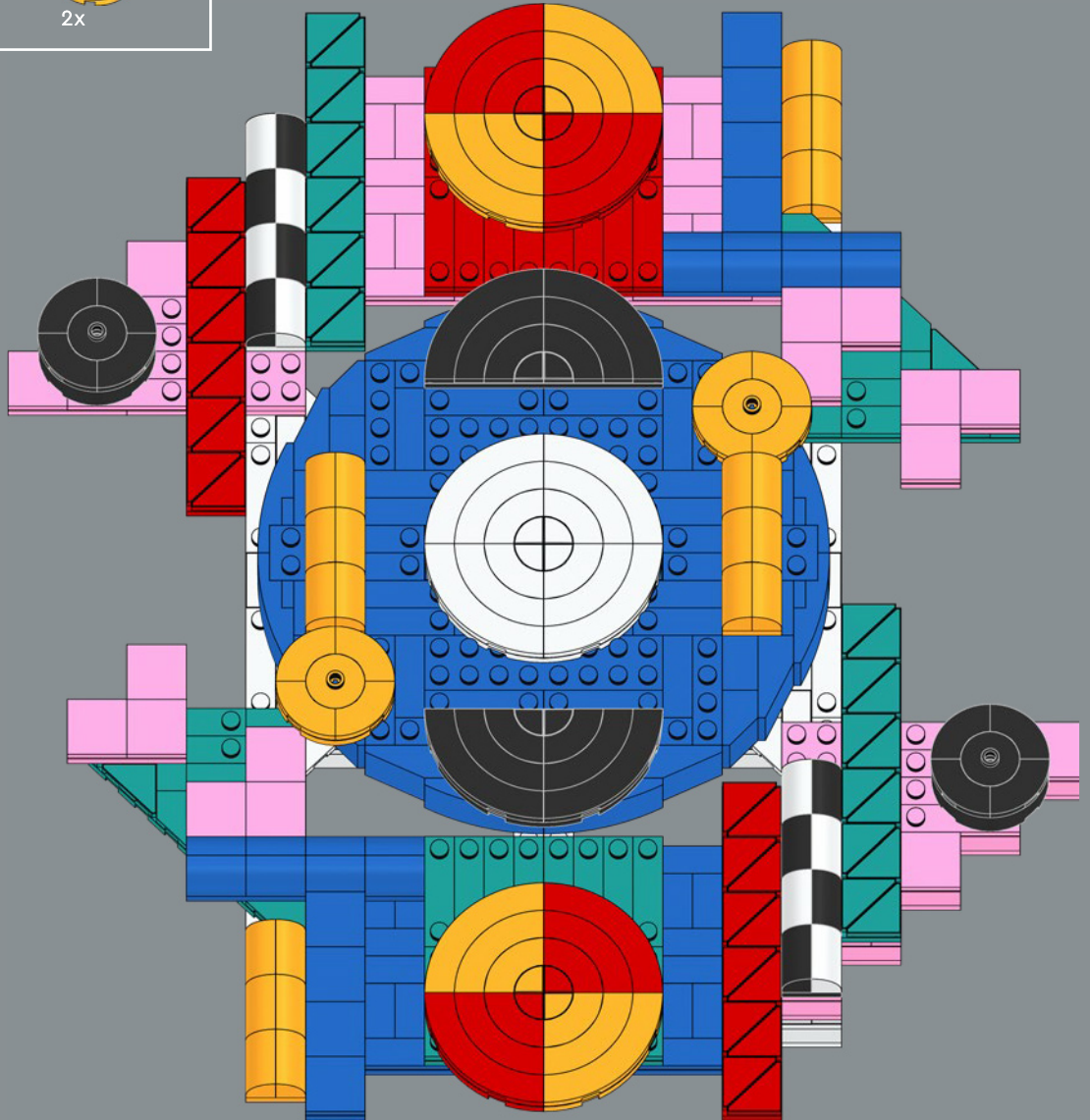

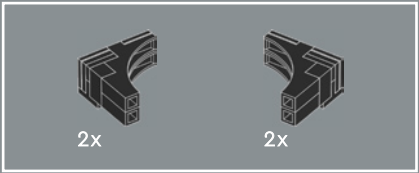

12

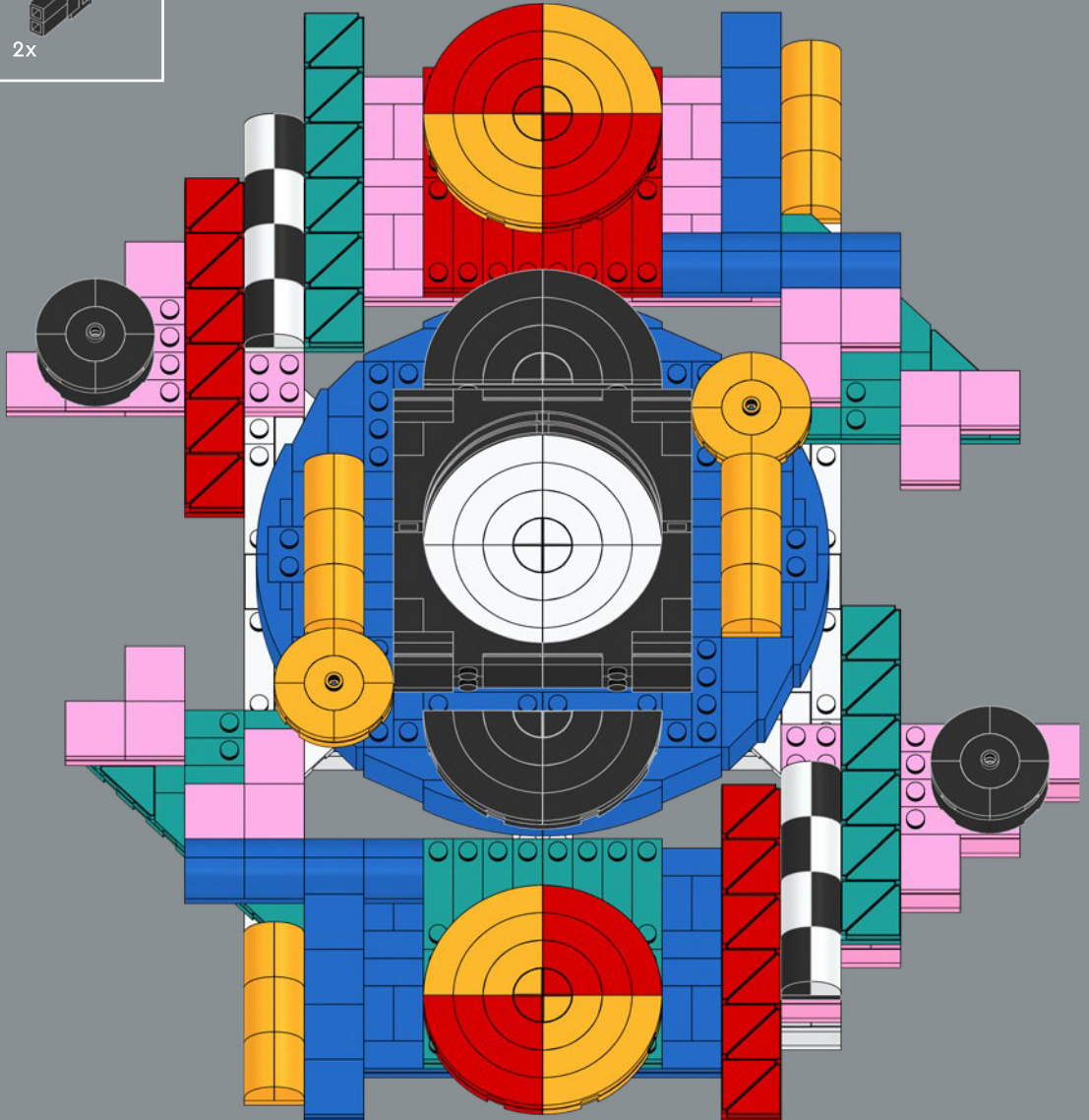

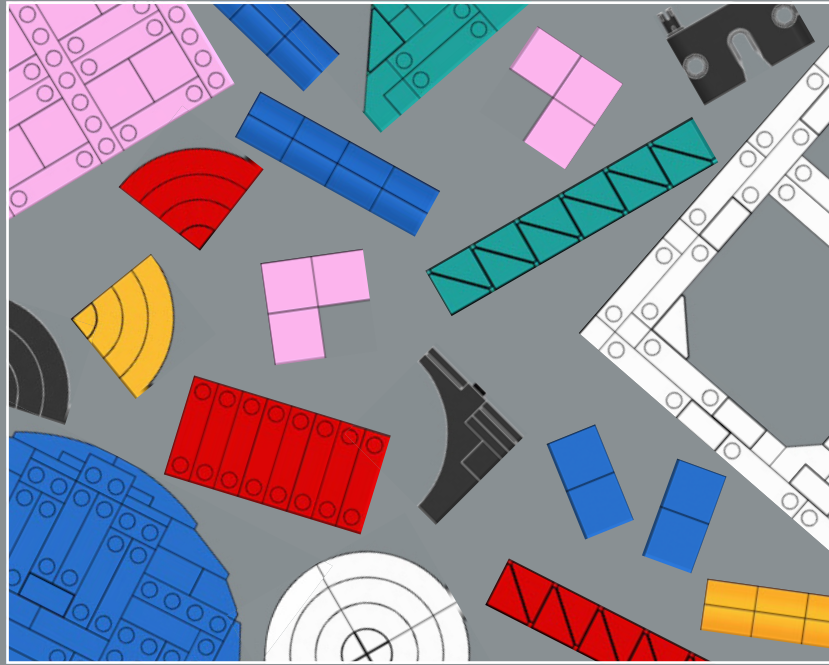

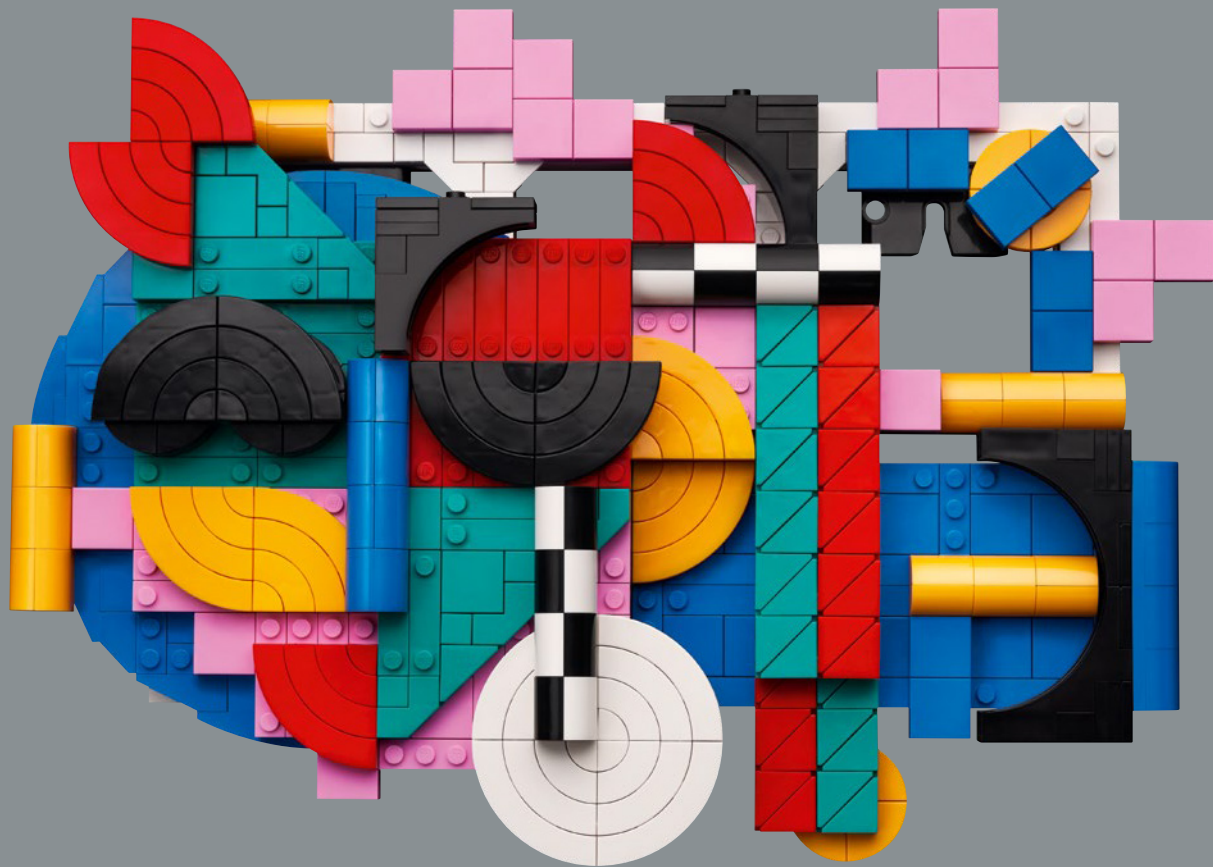



1

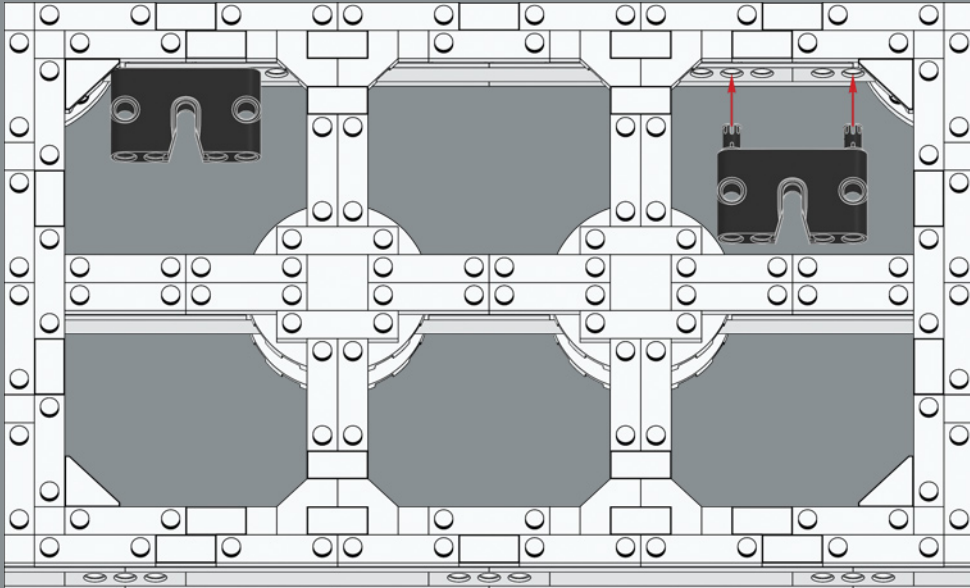

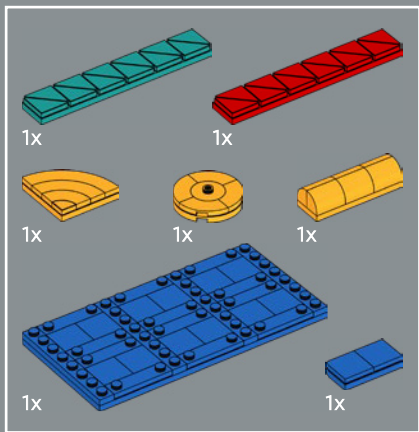

2

1

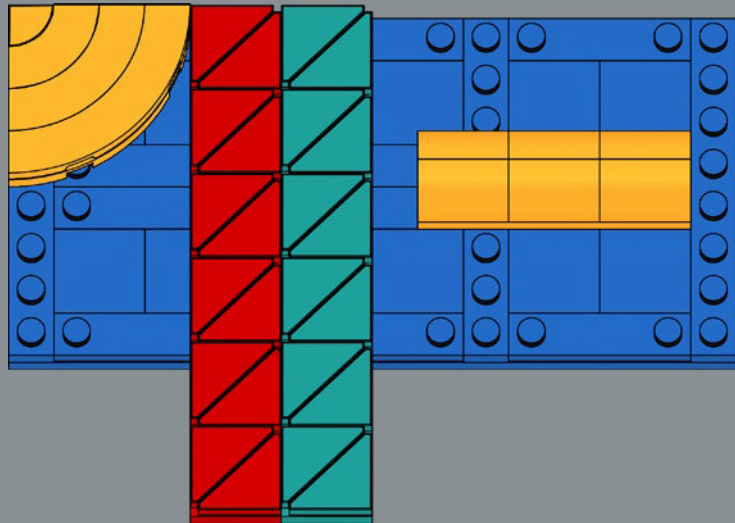

2

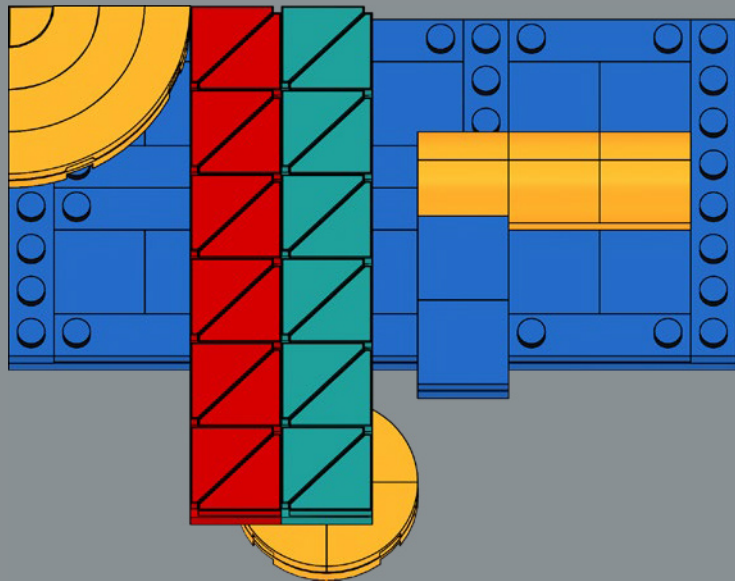

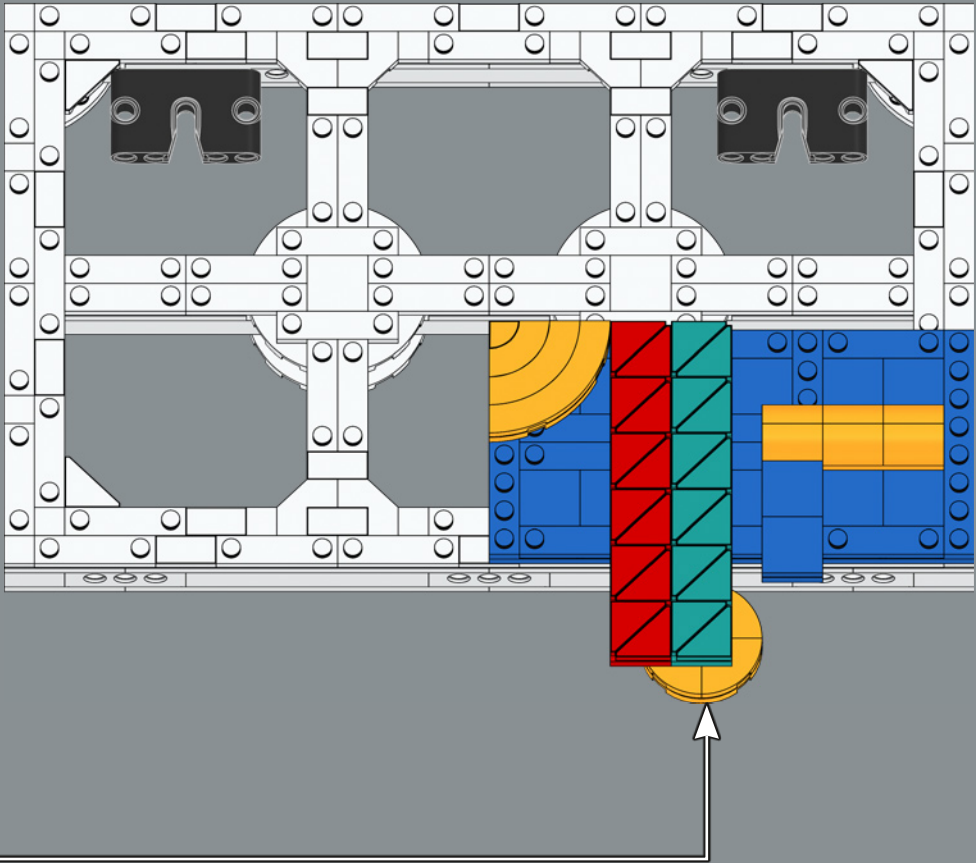

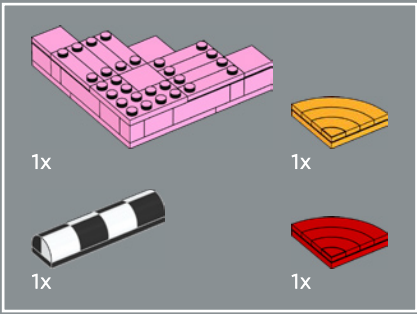

3

1

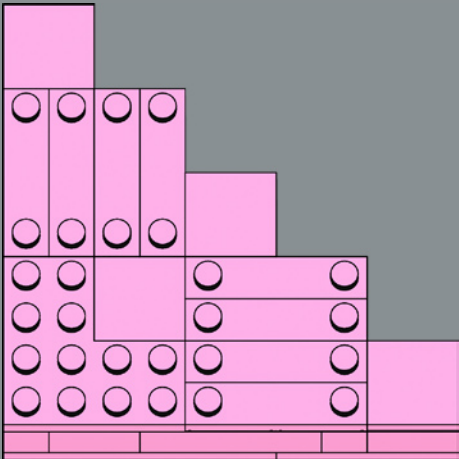

2

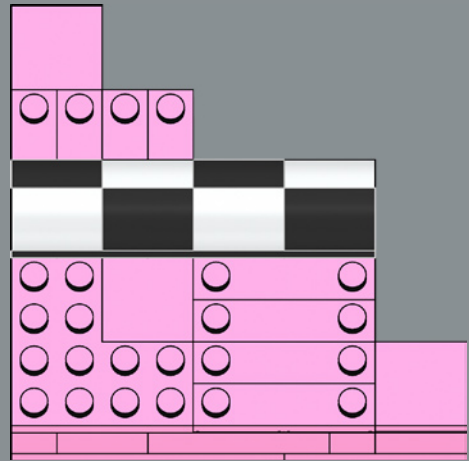

3

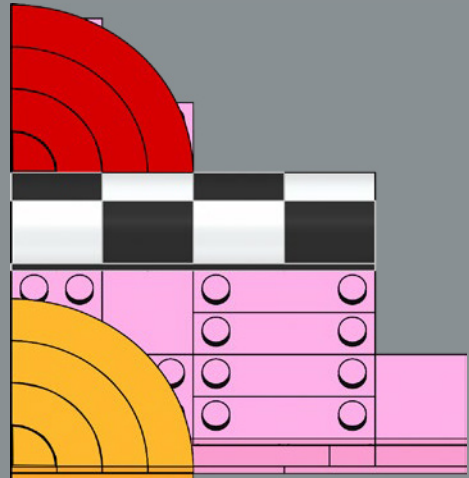

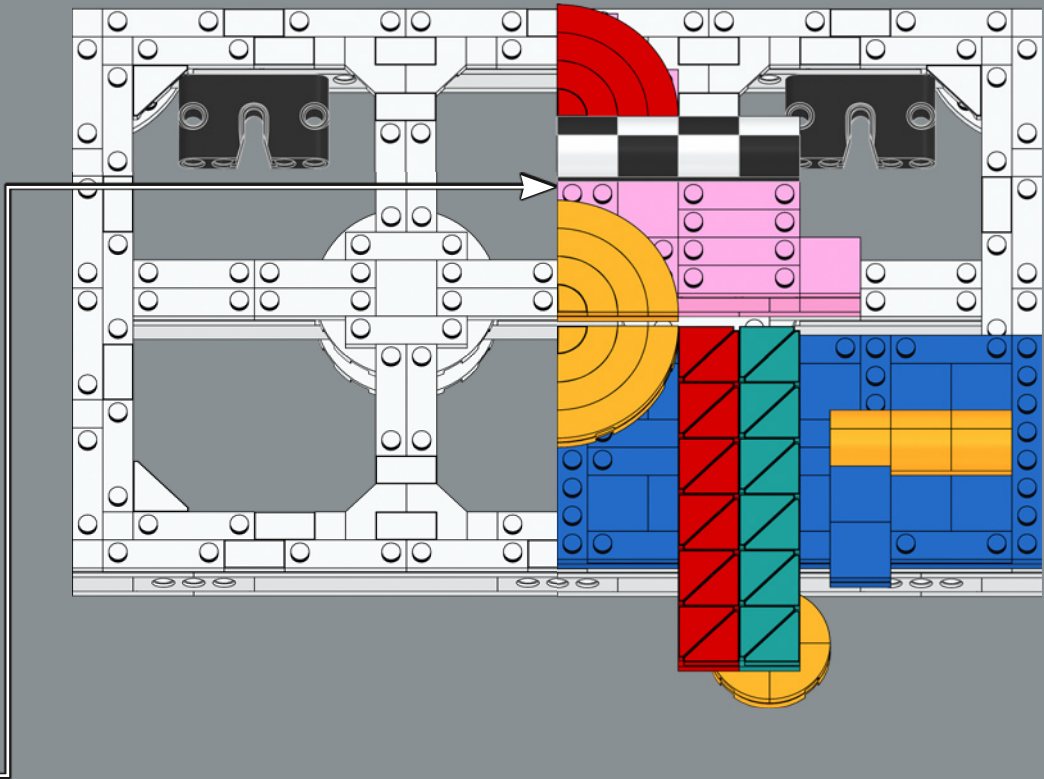

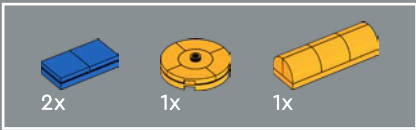

4

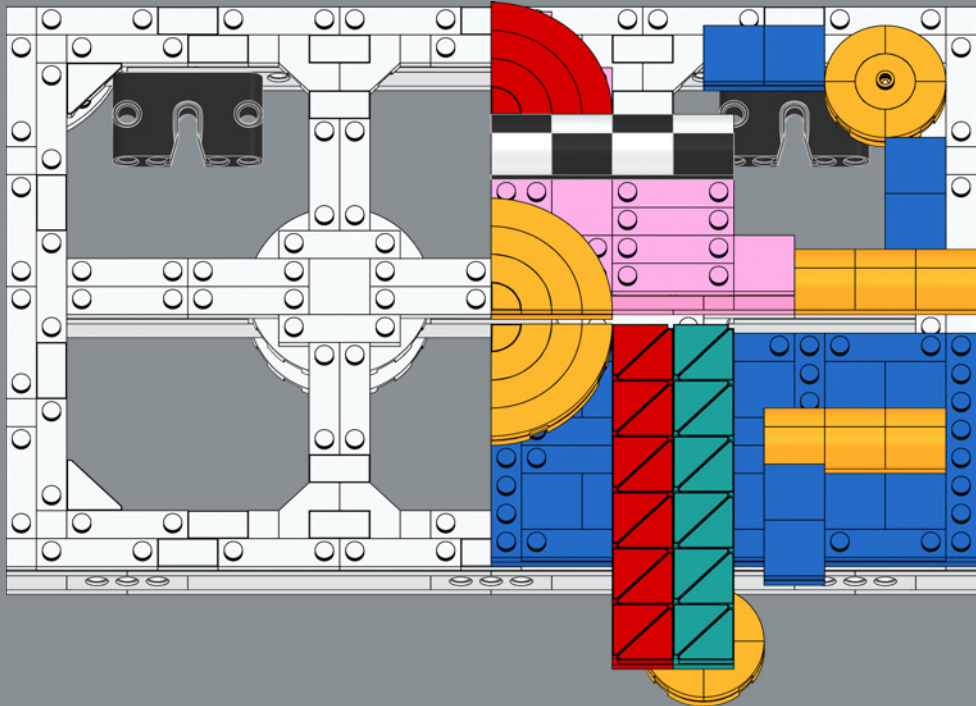

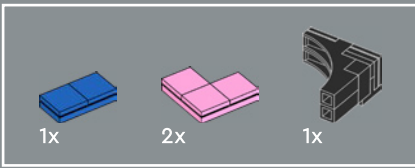

5

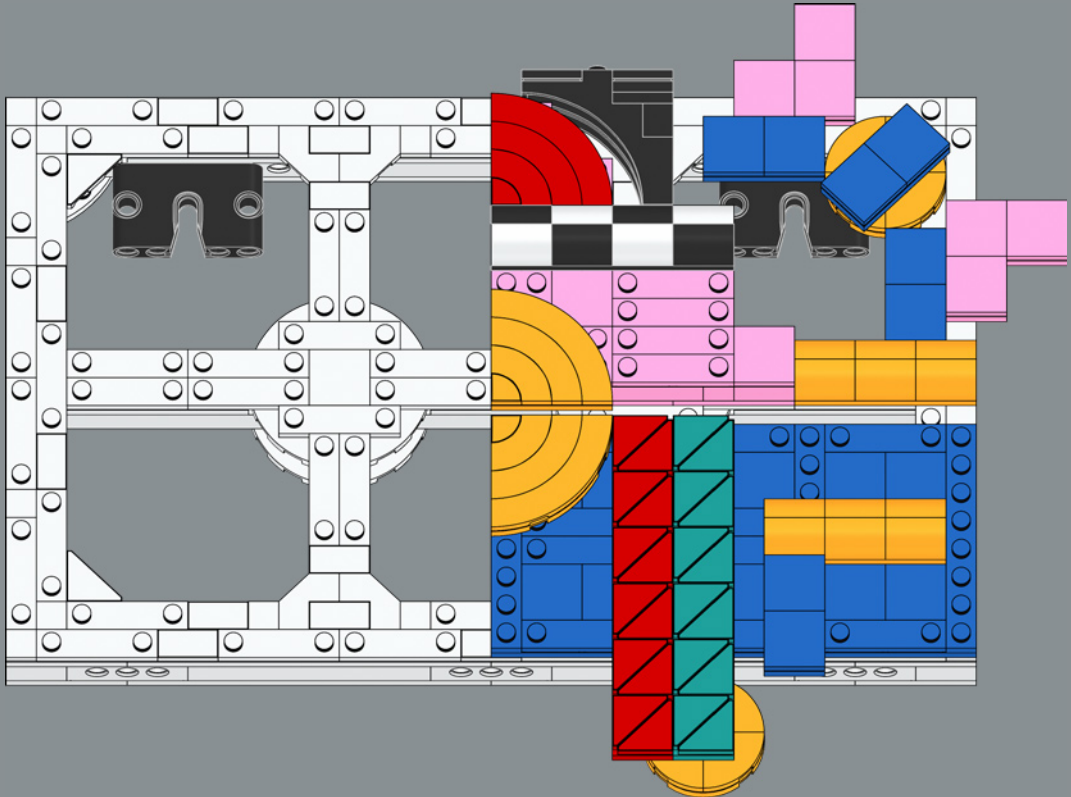

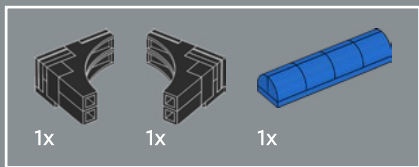

6

1

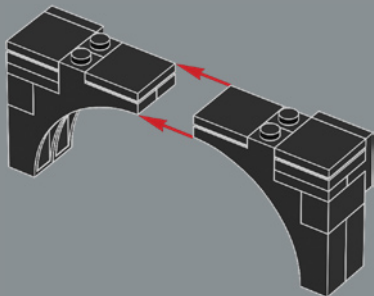

2

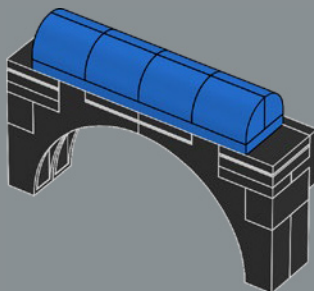

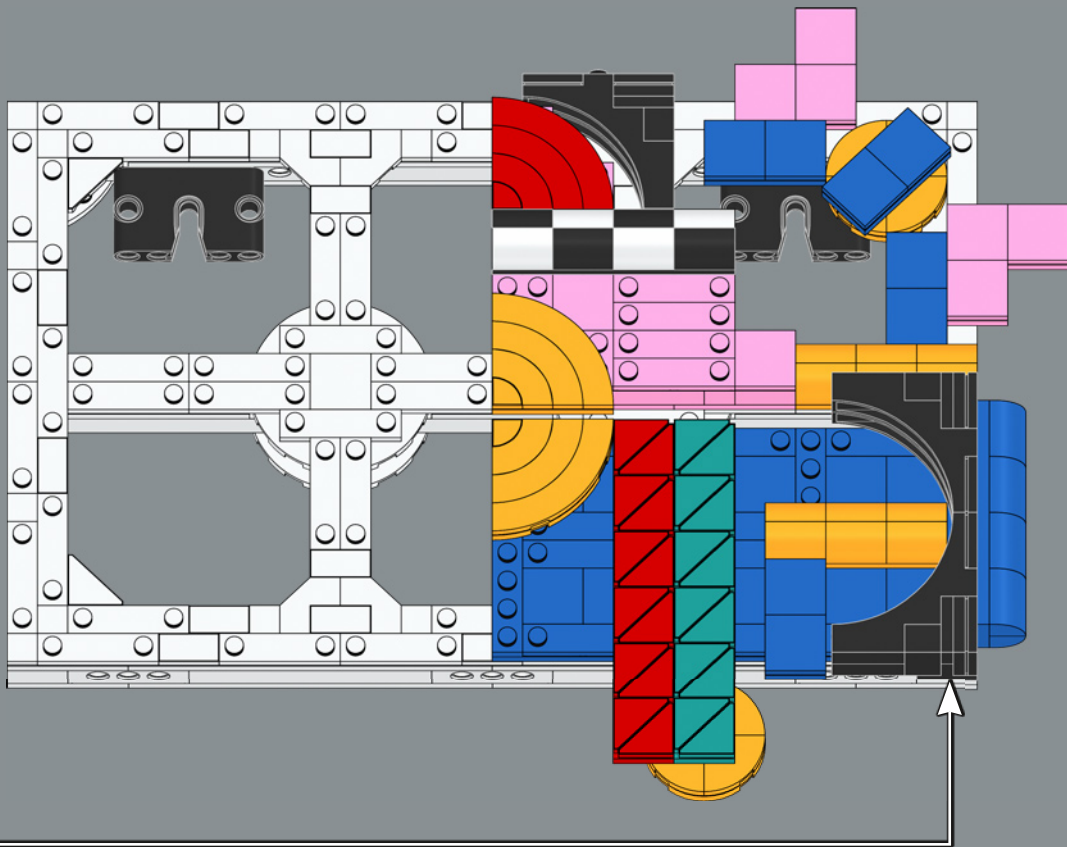

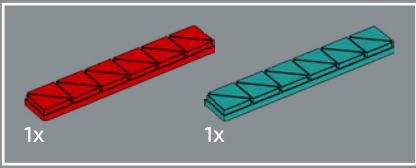

7

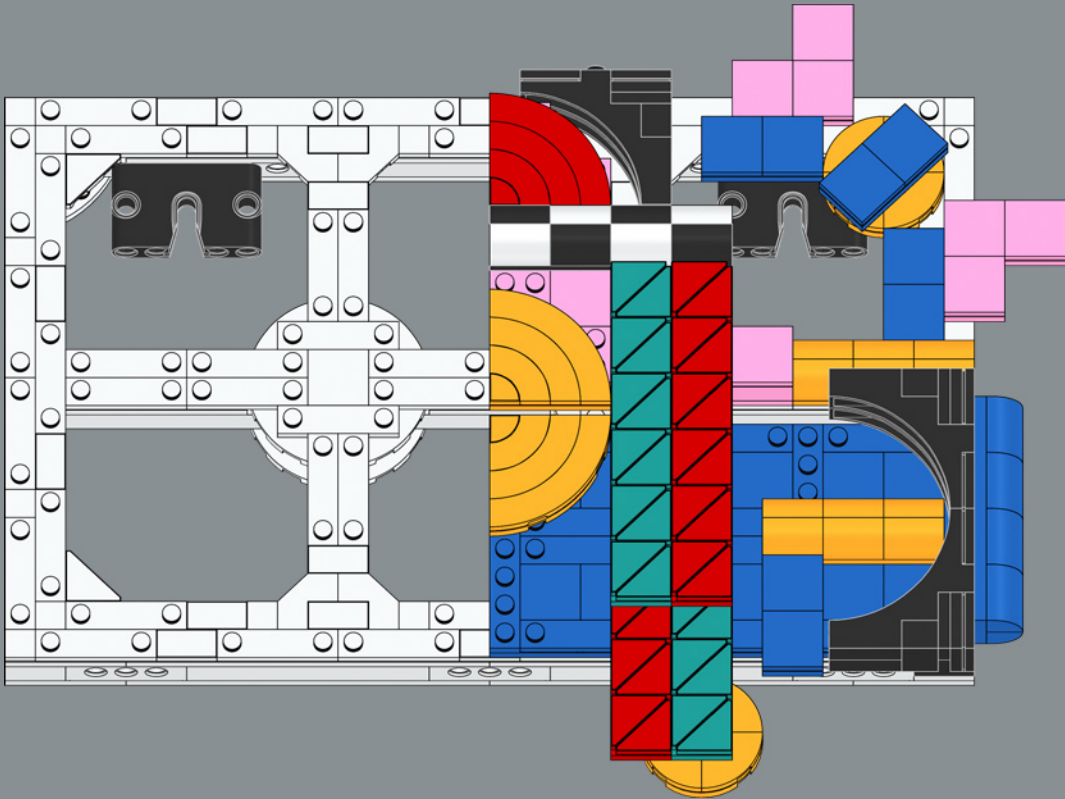

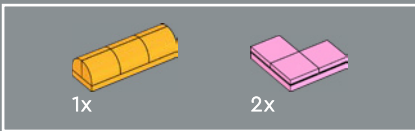

8

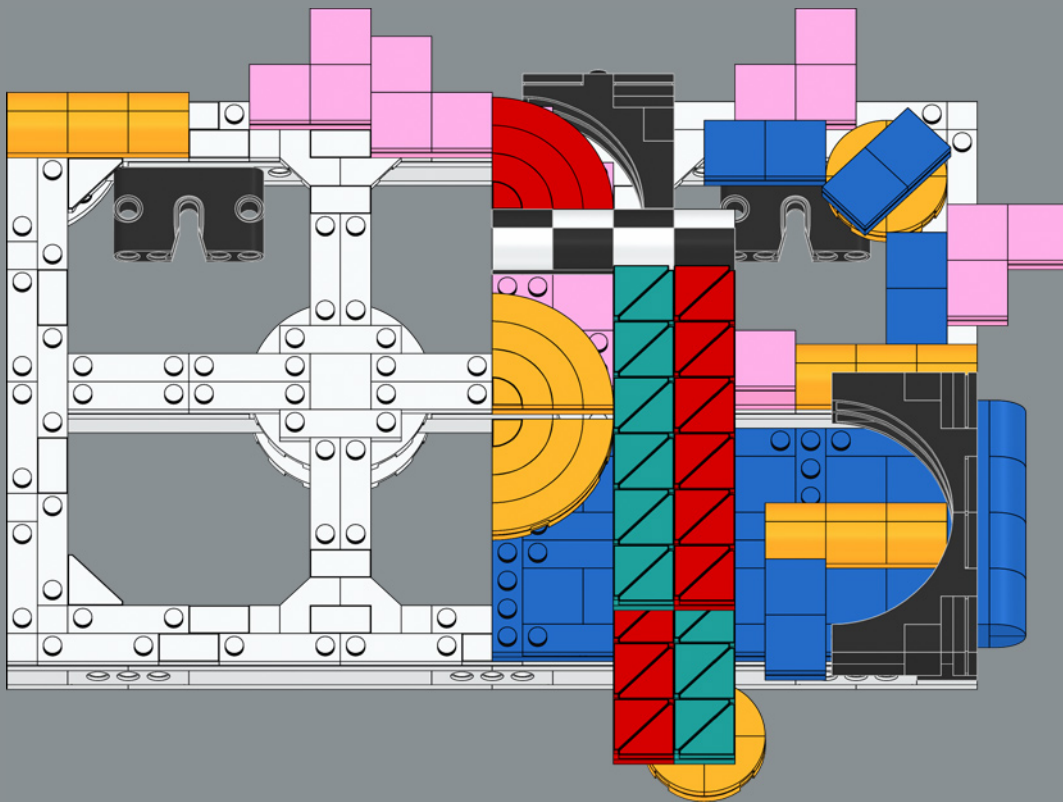

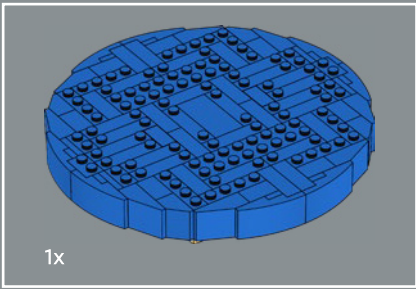

9

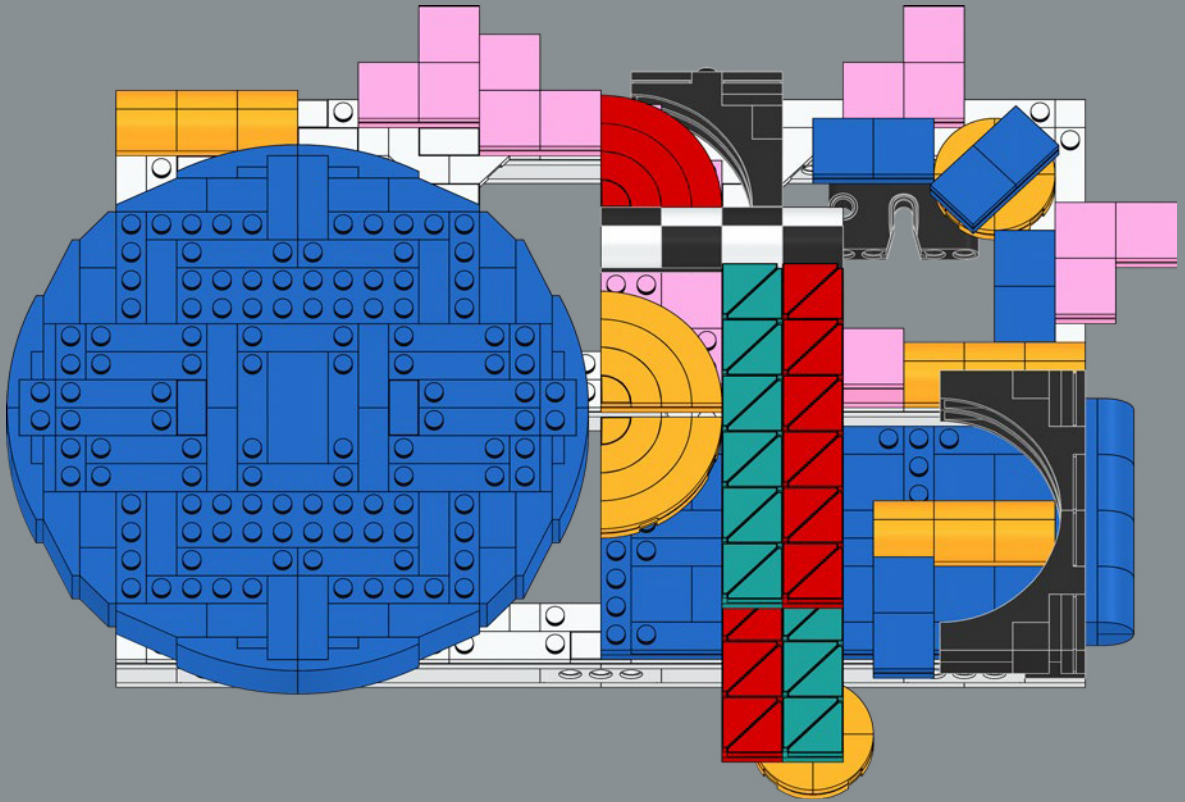

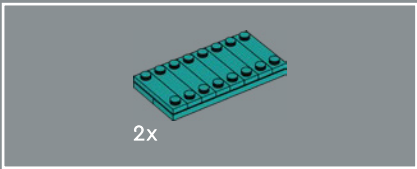

10

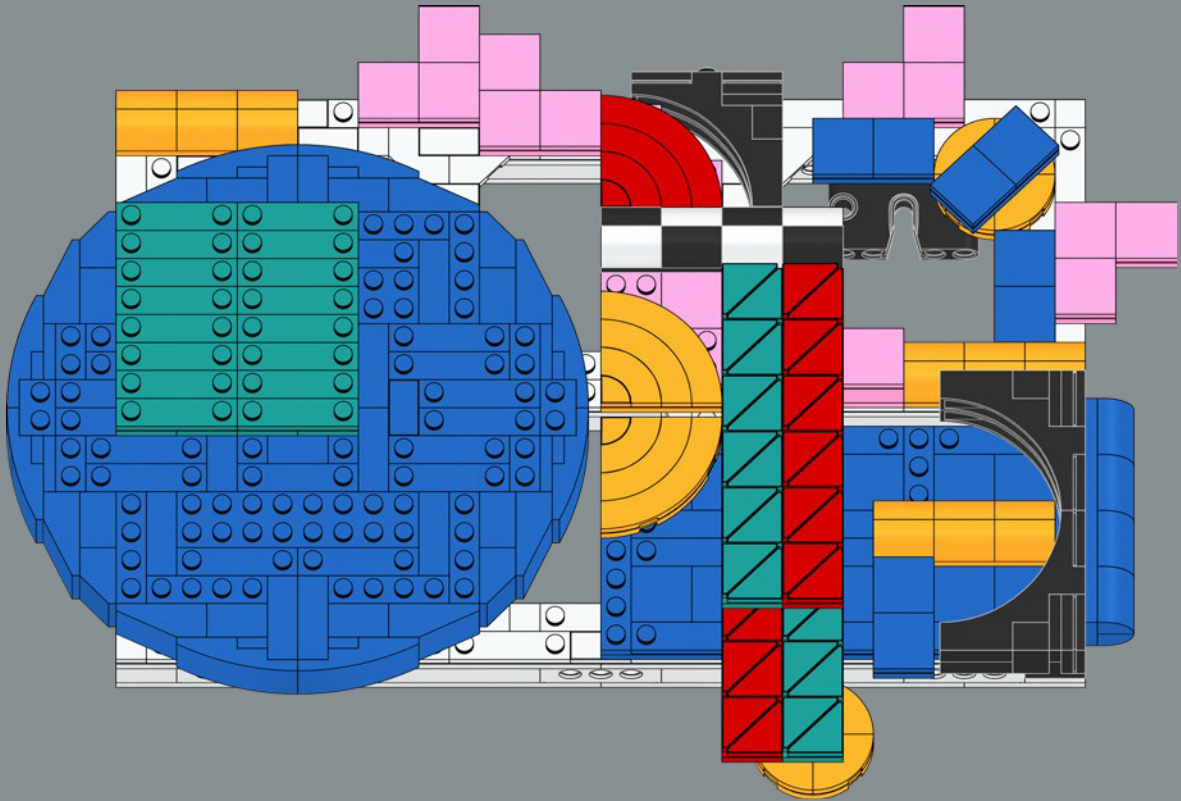

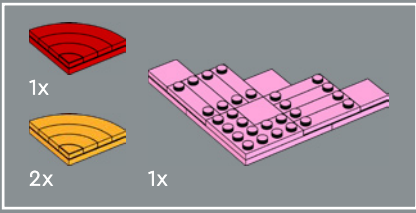

11

1

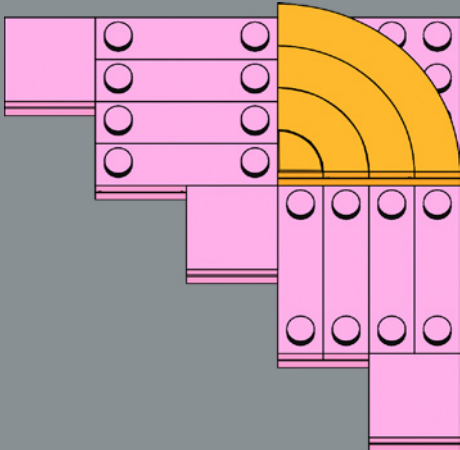

2

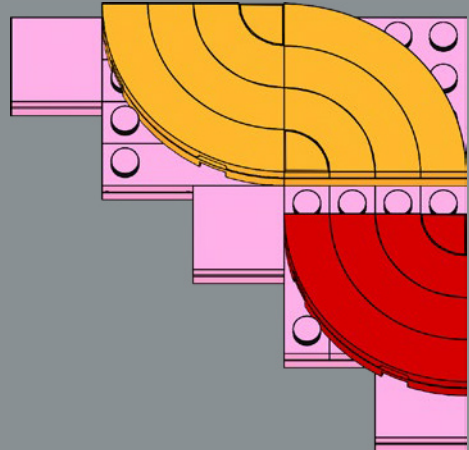

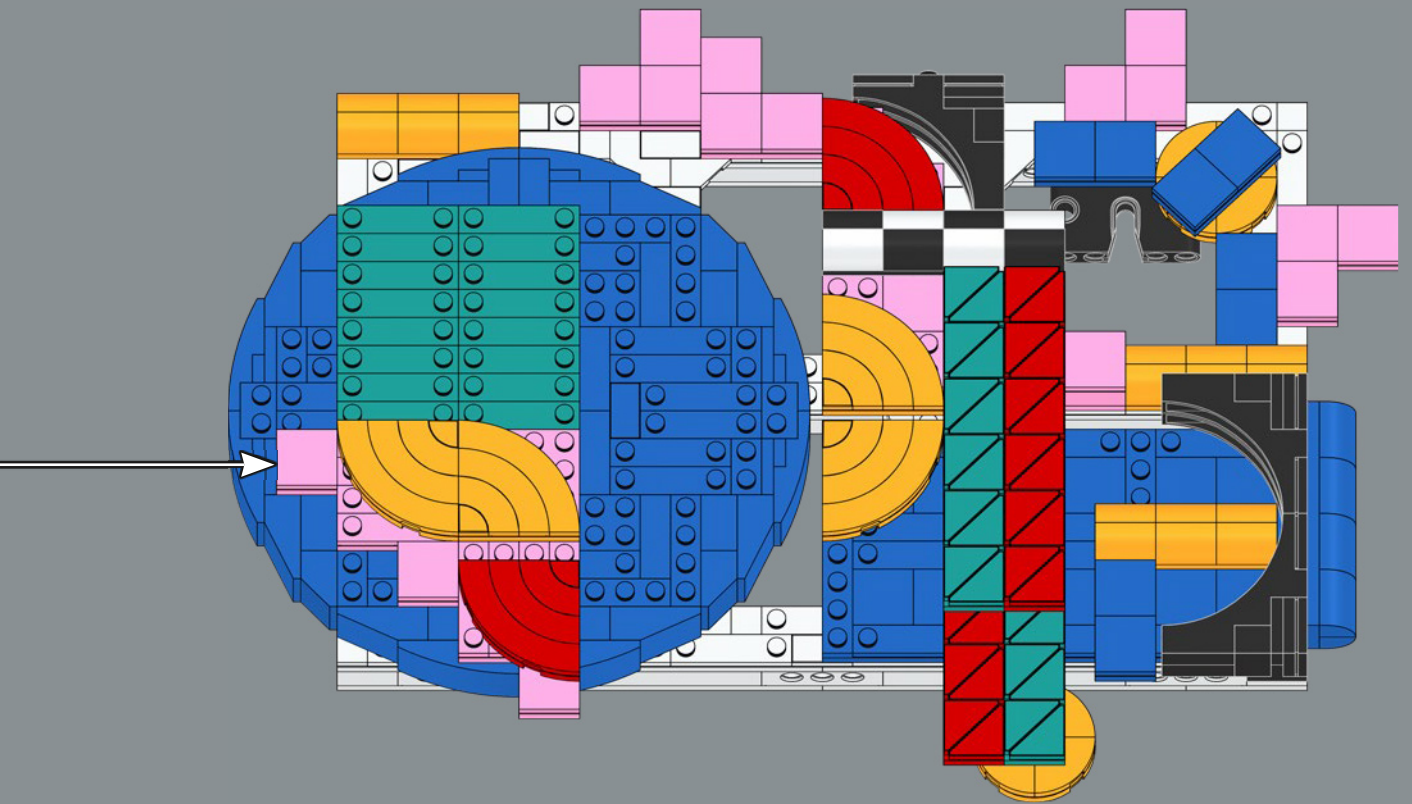

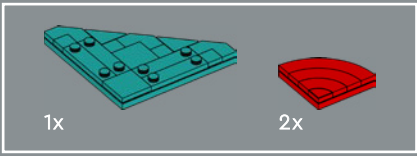

12

1

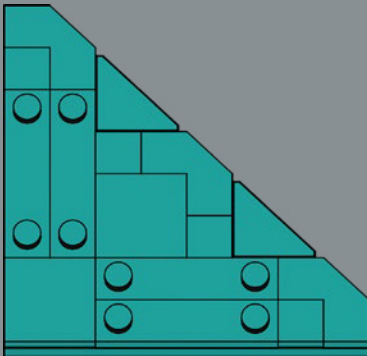

2

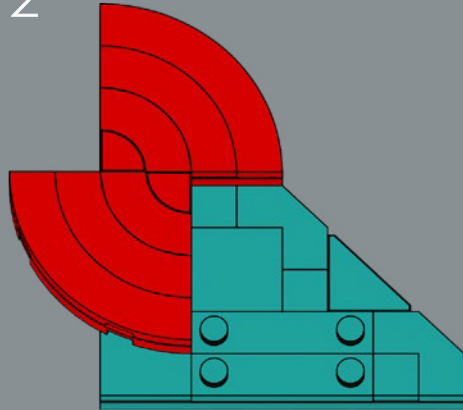

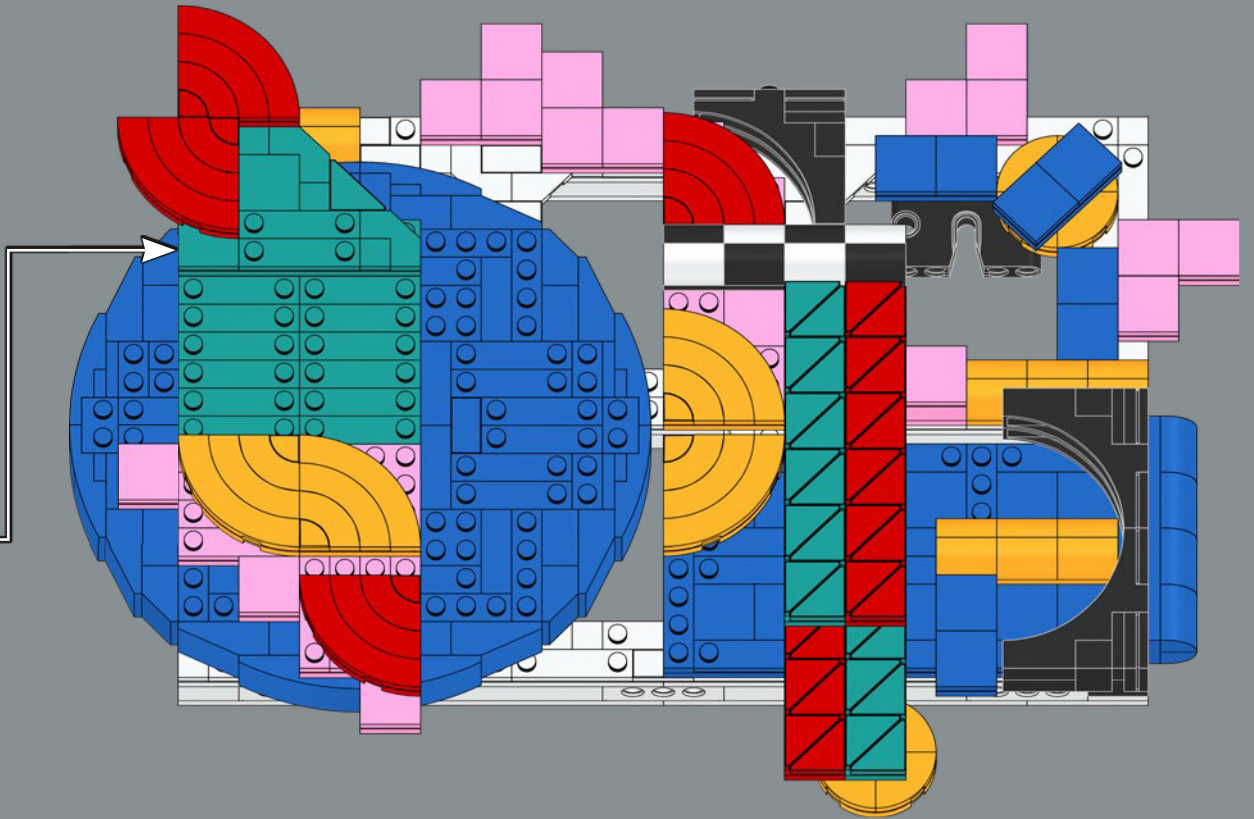

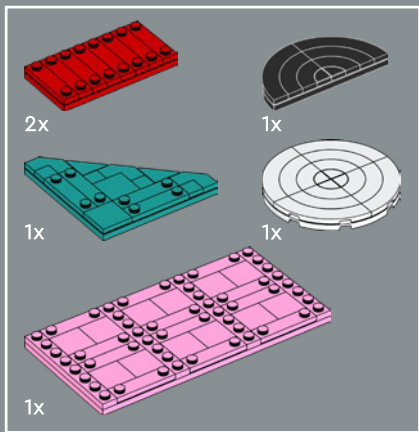

13

1

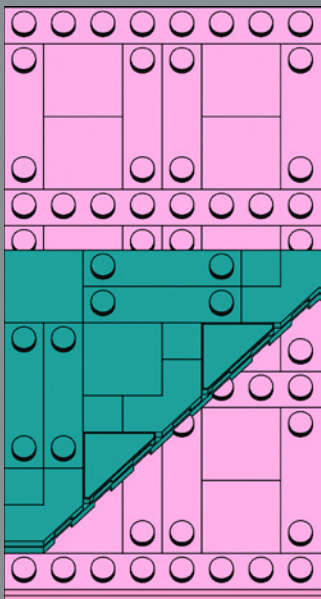

2

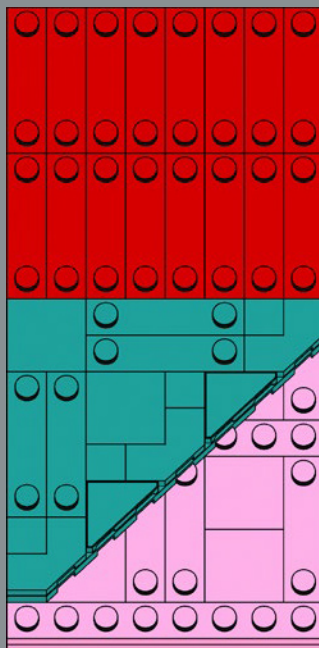

3

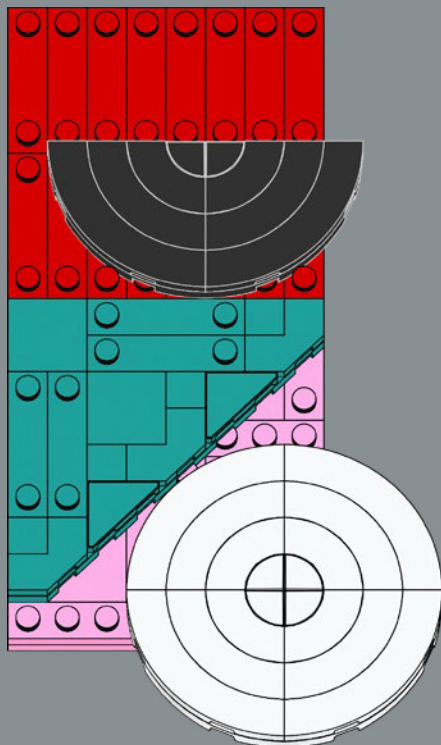

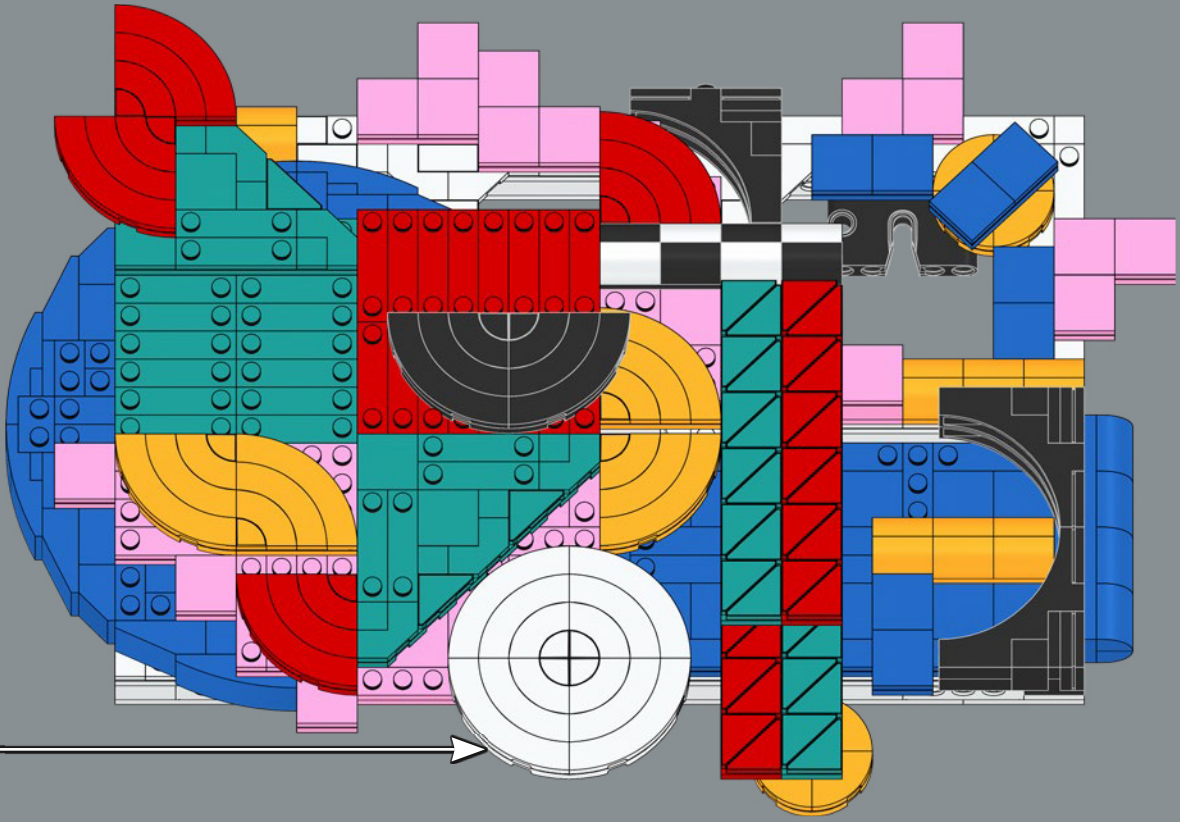



14

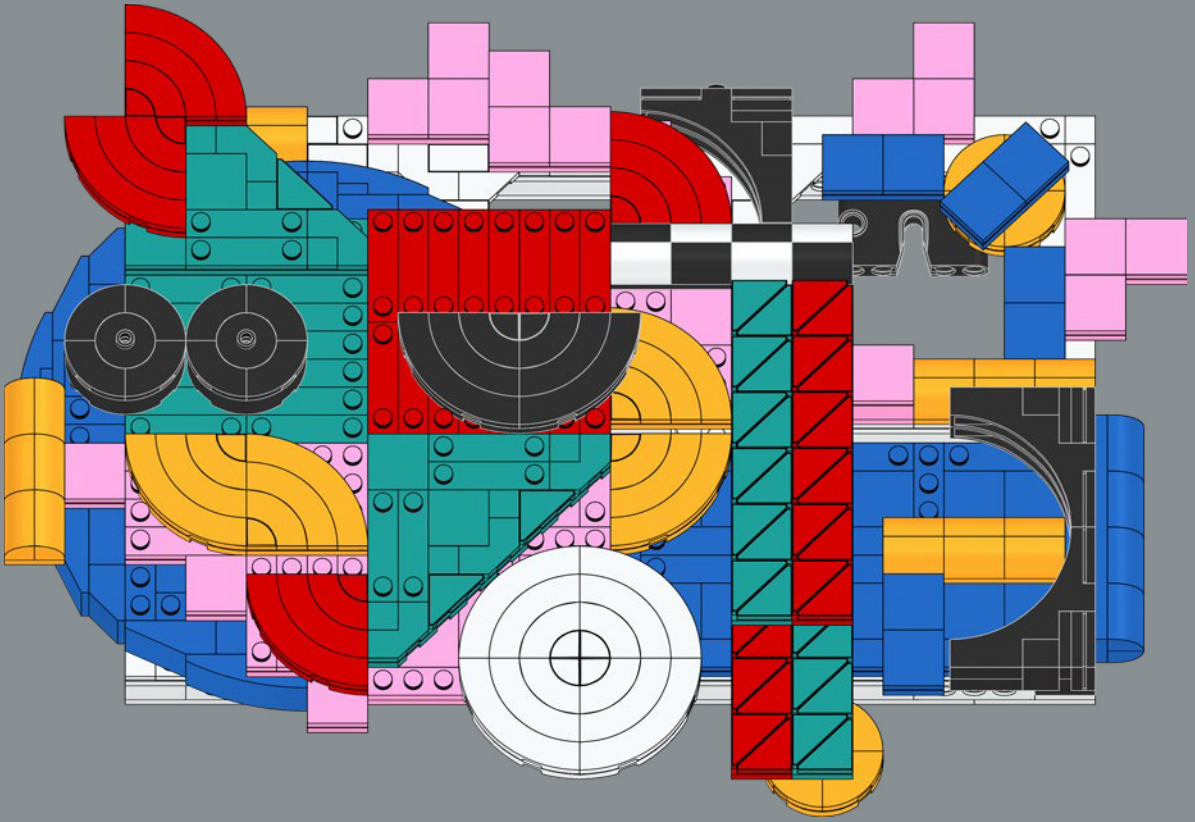

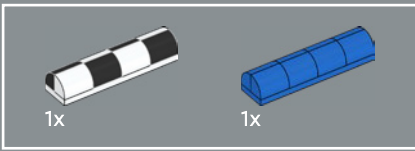

15

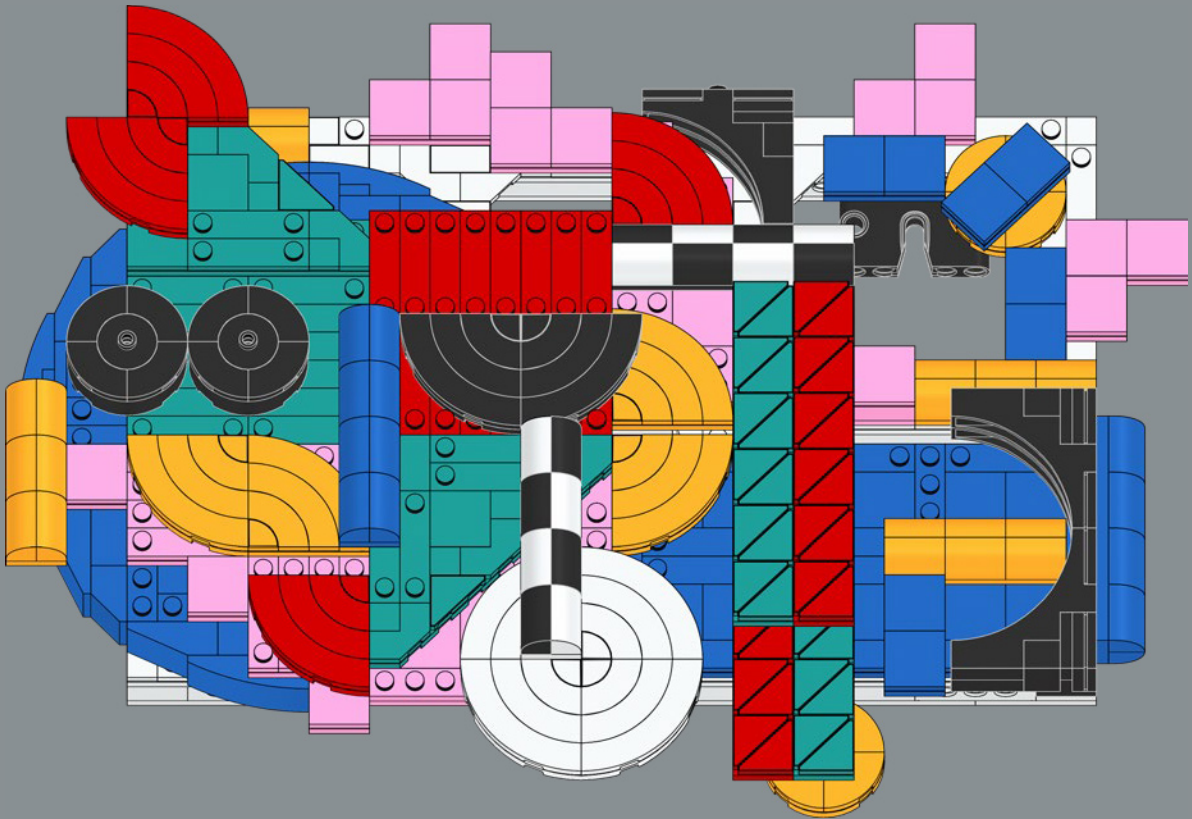

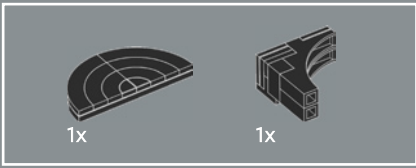

16

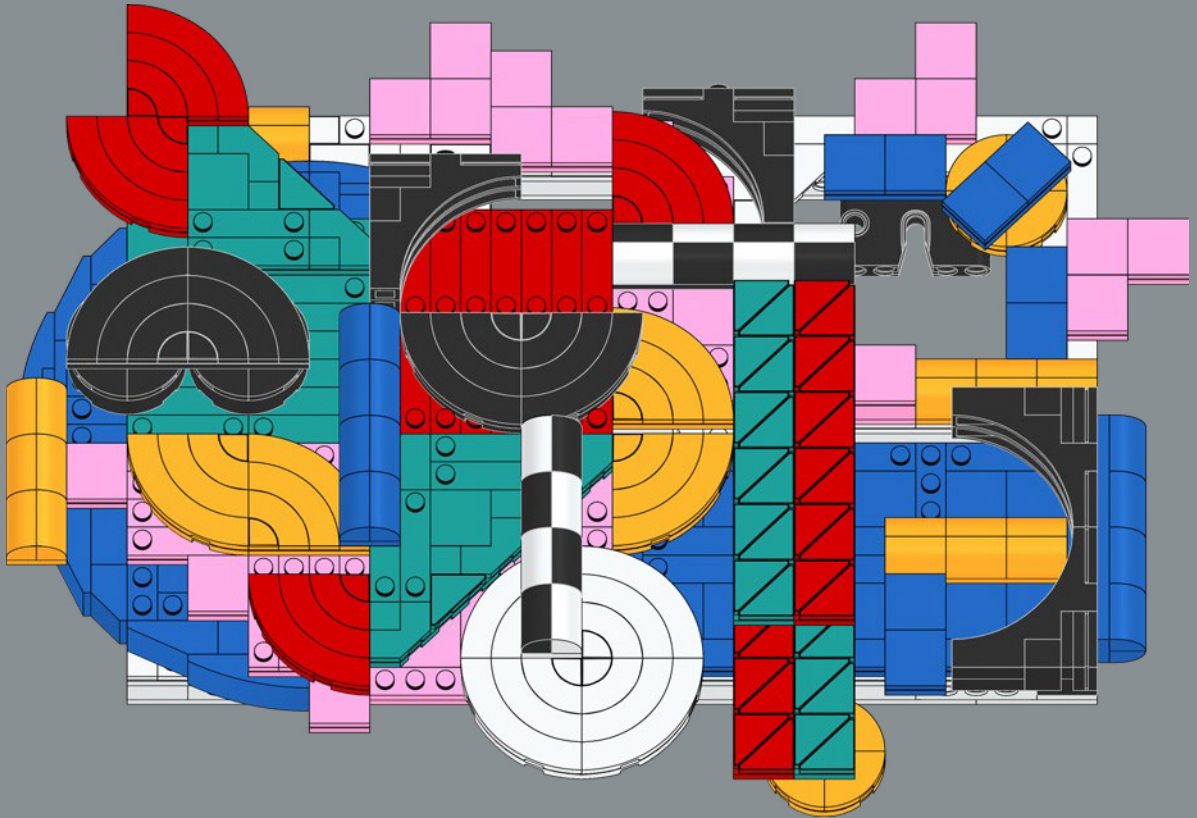

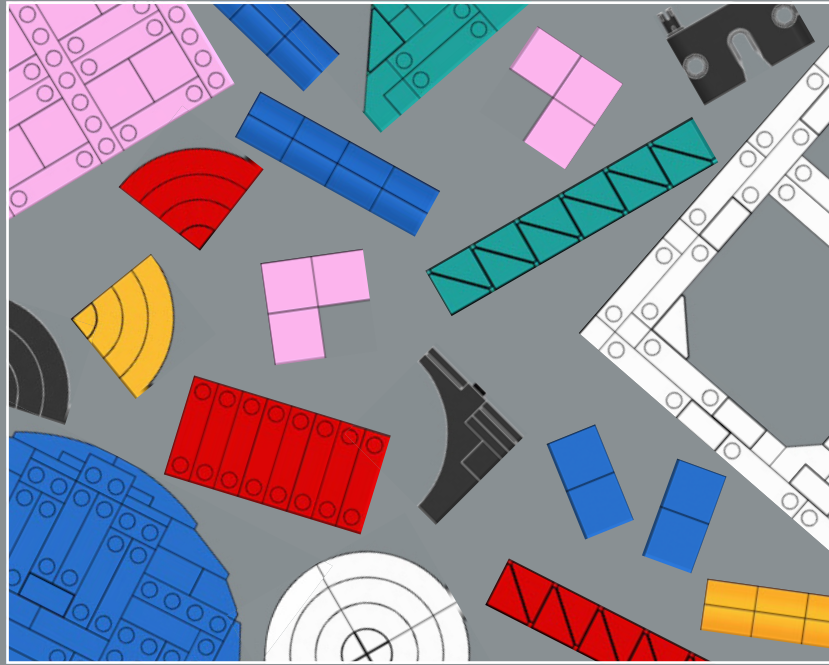

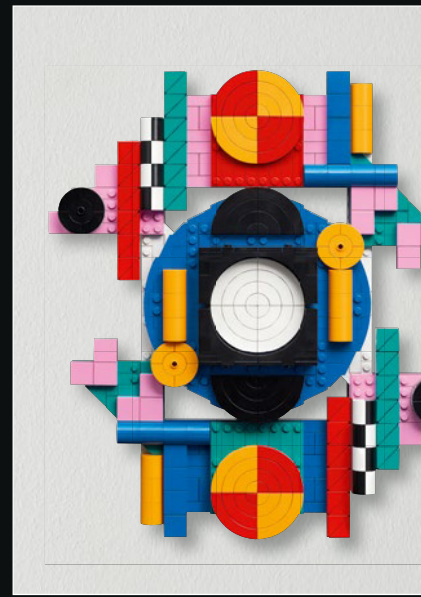
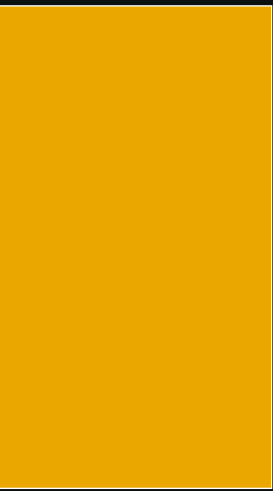

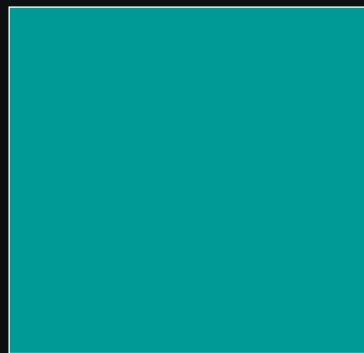
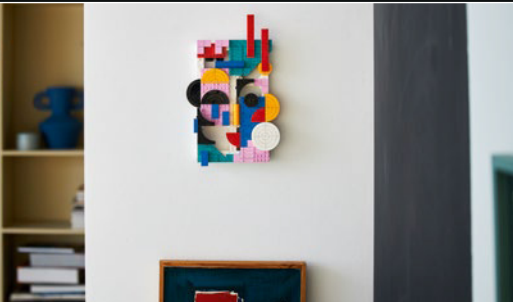

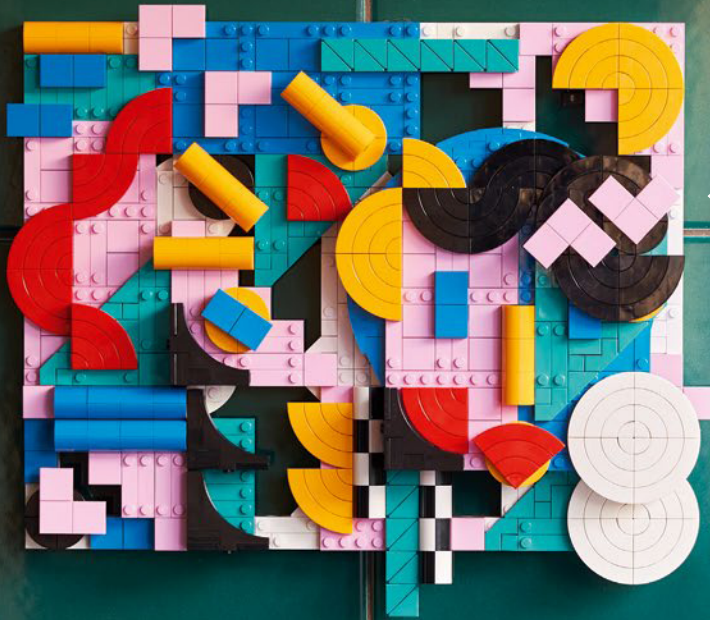

2x

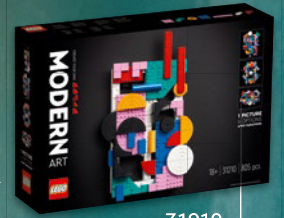

31210

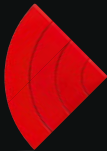

EXPAND YOUR MODERN ARTWORK
Combine 2 sets



4x
300501
20x
307001
4x
6172366
6x
370001
22x
306901
8x
6248827
4x
6217875
4x
306801
4x
300301
4x
6172674
1x
235701
8x
6168612
56x
6249091
18x
370101
4x
6373439

1x
302001
8x
6350399
4x
6457244
8x
4178429
4x
6109817
2x
379501
10x
300801
2x
6138699
7x
6033776
1x
303401

1x
6331510
12x
244501
1x
4119227
4x
6036485
4x
6170390
24x
6351892
2x
300321
4x
6310198
6x
6061711
16x
6256923
4x
6375825

4x
6458177
4x
6297811
4x
4181138
2x
303521
2x
4255035
8x
302323
4x
6189191
2x
306923
16x
6290532
2x
6117968
20x
306823
4x
303923

8x
300323
4x
302223
12x
4587840
8x
6294307
8x
4212411
32x
6292291
8x
6429287
4x
302023
1x
4560180
4x
346023
4x
303423
1x
4610354

1x
300124
6x
4567996
4x
614126
4x
6172383
6x
6279875
2x
6195325
8x
6275732
4x
302326
4x
300426
4x
6250020
12x
6191630

8x
302328

24x
6250120

8x
302226

1x
4286050

4x
6214457

4x
379528

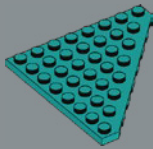

8x
306826

4x
4517993

2x
6133933

6x
4211795

2x
6430060

2x
4558957

32x
4615728

24x
6334836

8x
6213782

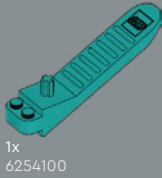

4x
6434275

4x
4550359

12x
6334203

28x
6334128

8x
6075062

28x
6253655

2x
6115115

4x
6273853

4x
6257063

4x
6458165

4x
4520632

4x
6453948

6x
6453949

2x
6453950

2x
6302094

14x
6453947

4x
6458166



2x
6133200

4x
6143789

4x
6453946

1x
303426

2x
6358030

4x
6097509

2x
303026

1x
6453953

 [LEGO.com/service](https://www.LEGO.com/service)



YOU COULD WIN

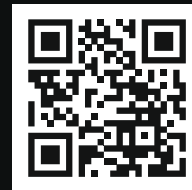

YOU COULD WIN

Your feedback will help shape the future development of this product series.

Visit:

DU KÖNNTEST GEWINNEN

Dein Feedback trägt zur Weiterentwicklung dieser Produktreihe bei.

Geh auf:

VOUS POURRIEZ GAGNER

Vos commentaires nous aideront à concevoir les futurs produits de cette gamme.

Visitez :

POTRESTI VINCERE TU

La tua opinione ci aiuterà a migliorare la creazione futura di questa linea di prodotti.

Visita:

PUEDES GANAR

Tu opinión contribuirá al futuro de esta serie de productos.

Visita:

轻松获奖

您的反馈将有助于我们在今后改进本产品系列。

请访问：

LEGO.com/productfeedback

You also have the chance to win a LEGO® set.

Terms and conditions apply.*

Außerdem hast du die Chance, ein LEGO® Set zu gewinnen.

Es gelten die Teilnahmebedingungen.*

Vous pourriez également gagner un ensemble LEGO®.

Des conditions s'appliquent.*

Hai anche la possibilità di vincere un set LEGO®.

Termini e condizioni sono applicabili.*

También tienes la oportunidad de ganar un set LEGO®.

Aplican términos y condiciones.*

您还有机会赢取乐高®套装。

条款和条件适用。*

*LEGO.com/productfeedback-terms

