



Booklet available in English on
Heft in deutscher Sprache erhältlich auf
Livret disponible en français sur
Libretto disponibile in italiano su
Folleto en español disponible en
如需中文版手册, 请访问



FR

**DONNEZ
OU
RECYCLEZ**



ASSOCIATION
OU



MAGASIN
OU



DÉCHÈTERIE

Adresses sur quefairedemesdechets.fr



LEGO.com/sustainable-packaging

LEGO® VIP

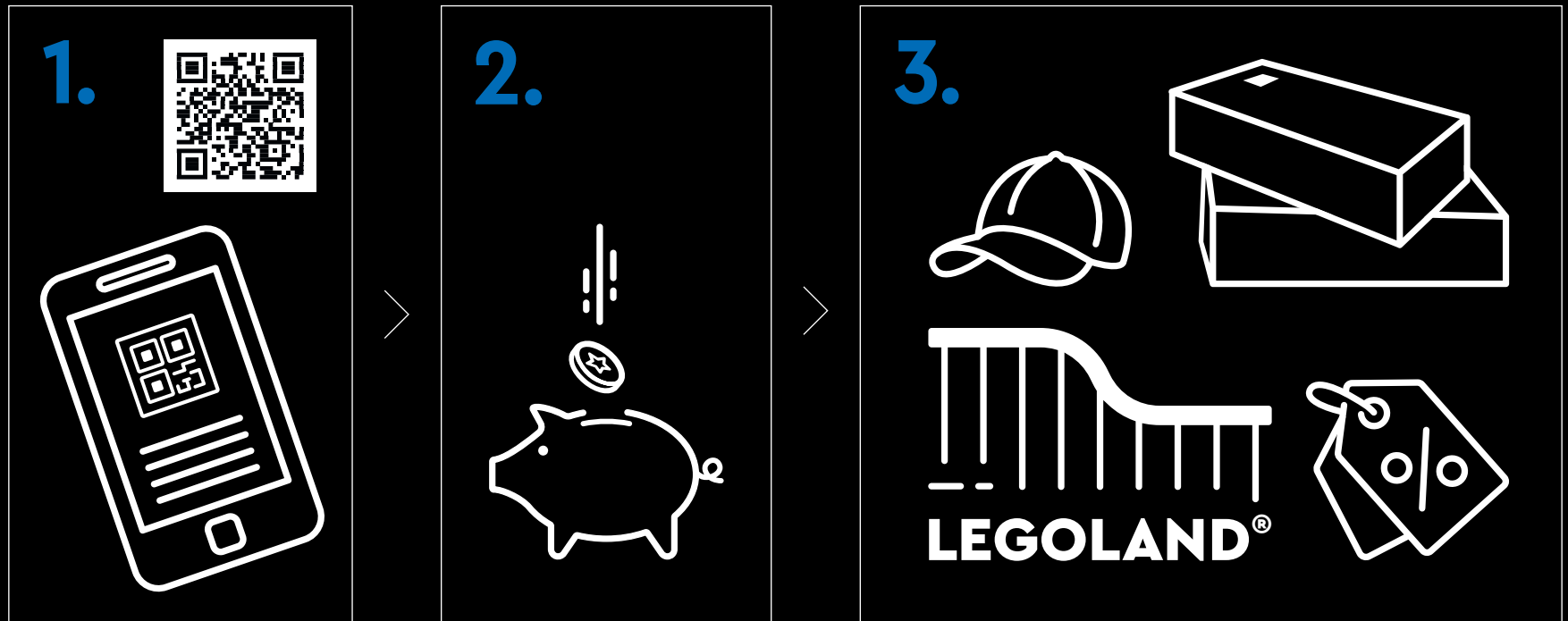

1. Sign up **2.** Earn points for purchases **3.** Redeem points for rewards, experiences, discounts & more | **1.** Melde dich an **2.** Sammle Punkte bei jedem Kauf **3.** Löse die Punkte für Belohnungen, Erlebnisse, Rabatte und Ähnliches ein | **1.** Inscrivez-vous **2.** Gagnez des points lors de vos achats **3.** Échangez vos points contre des récompenses, des expériences, des remises et bien plus encore | **1.** Iscriviti **2.** Guadagna punti con i tuoi acquisti **3.** Riscatta punti per premi, esperienze, sconti e altro ancora | **1.** Regístrate **2.** Gana puntos por tus compras **3.** Canjea puntos por recompensas, experiencias, descuentos y mucho más | **1.** Registe-se **2.** Ganhe pontos em compras **3.** Troque os pontos para prémios, experiências, descontos e muito mais | **1.** 注册 **2.** 购物赚积分 **3.** 用积分兑换奖励、体验、折扣等 | **1.** Zarejestruj się **2.** Zdobywaj punkty za zakupy **3.** Wymieniaj punkty na rabaty, przygody i inne nagrody | **1.** Zaregistrujte se **2.** Sbírejte body za nákupy **3.** Vyměňujte body za odměny, zážitky, slevy a spoustu dalšího | **1.** Zaregistrujte se **2.** Získavajte body za nákupy **3.** Uplatnite si body a získajte odmeny, rôzne zážitky, zľavy a ešte viac | **1.** Regisztrálj **2.** Szerezz pontokat minden vásárlással **3.** Váltsd be pontjaidat jutalmakra, élményekre, kedvezményekre és egyebekre | **1.** Înscric-te **2.** Câștigă puncte pentru achiziții **3.** Valorifică puncte pentru recompense, experiențe, reduceri și multe altele | **1.** Регистрируйте се **2.** Получайте точки за покупки **3.** Используйте точки за награды, услуги, отстъпки и т.н. | **1.** Reģistrējies **2.** Pelni punktus par pirkumiem **3.** Izmanto punktus, lai saņemtu balvas, izklaides iespējas, atlaides un daudz ko citu | **1.** Registreeru **2.** Teeni ostude eest punkte **3.** Lunasta punktide eest preemiad, elamused, allahindlused ja muu | **1.** Užsiregistruokite **2.** Pelnykite taškų už pirkinius **3.** Panaudokite taškus atlygiui, funkcijoms, nuolaidoms ir ne tik







姫路城

HIMEJI CASTLE / THE CASTLE OF THE WHITE HERON

🏰 Majestically overlooking the Japanese city of Himeji, the breath-taking Himeji Castle is an architectural gem on UNESCO's World Heritage list. First built as a fortress in 1333, towards the end of an era of civil wars, the castle has undergone several transformations over the centuries. In 1600 a major reconstruction began, resulting in the current structure which has been preserved in its integrity until today, initially by feudal masters and later by the Japanese government. Mazes of intricate pathways once designed to confuse and trap enemies now weave an intriguing journey for visitors. Through wars, earthquakes, fires and times of peace, the Castle of the White Heron stands as a serene monument to Japanese culture. Discover the intricate details of the Main Keep and the history of the castle as you build.

CHRIS MCVEIGH
LEGO® Senior Designer

A TRIBUTE TO A REVERED LANDMARK

🍷 '2023 marks the 30th anniversary of Himeji Castle's inscription to UNESCO's World Heritage list, and its architecture and history are still like a mystery to decode. We created the Main Keep as a natural focal point and played with proportions and scales to make it stand out. If you have visited the castle you may recognise some of the interiors, and if you haven't seen it in person, we hope it sparks your imagination and curiosity.'



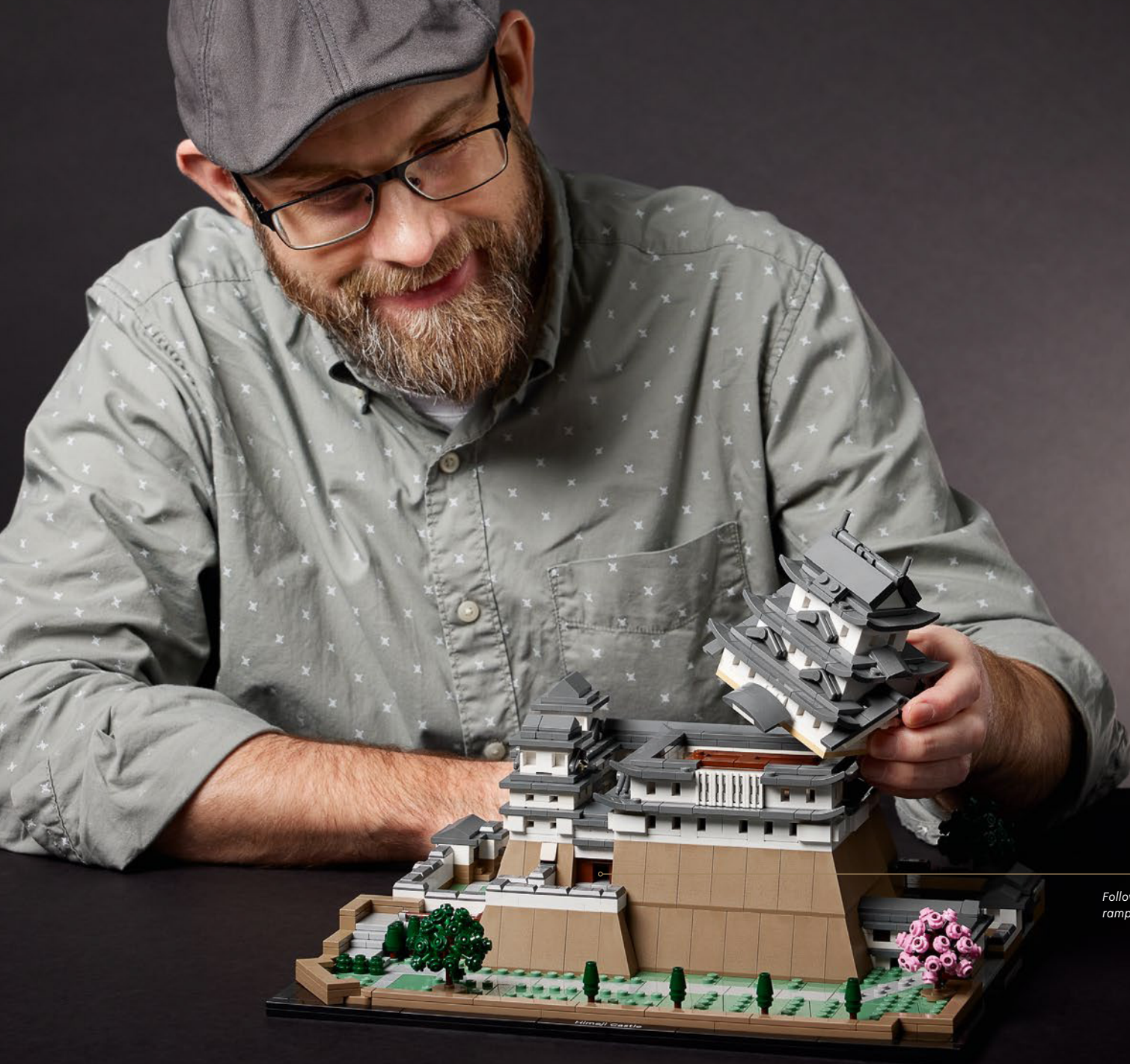

Follow some of the intricate pathways, ramps and stairways through the castle.



AN OPTICAL ILLUSION

🍷 Himeji Castle's roofing method uses interlocking black rectangular and semi-circular tiles. Several layers of white clay line the tiles, giving the roofing a high-contrast, mesh-like appearance up close. However, at a distance, the mesh pattern appears grey. The roof tiles in this set are *Dark Stone Grey* to reflect the aging of the tiles.



Peek inside after the model is built.



Each tower is constructed differently – even their heights.

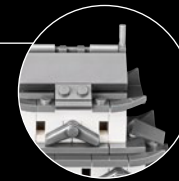

A mesh of black tiles and white clay makes the roof appear grey from a distance.

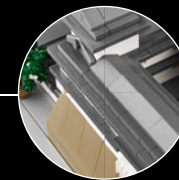

Each layer or floor in the Main Keep evokes the actual structure of the castle.

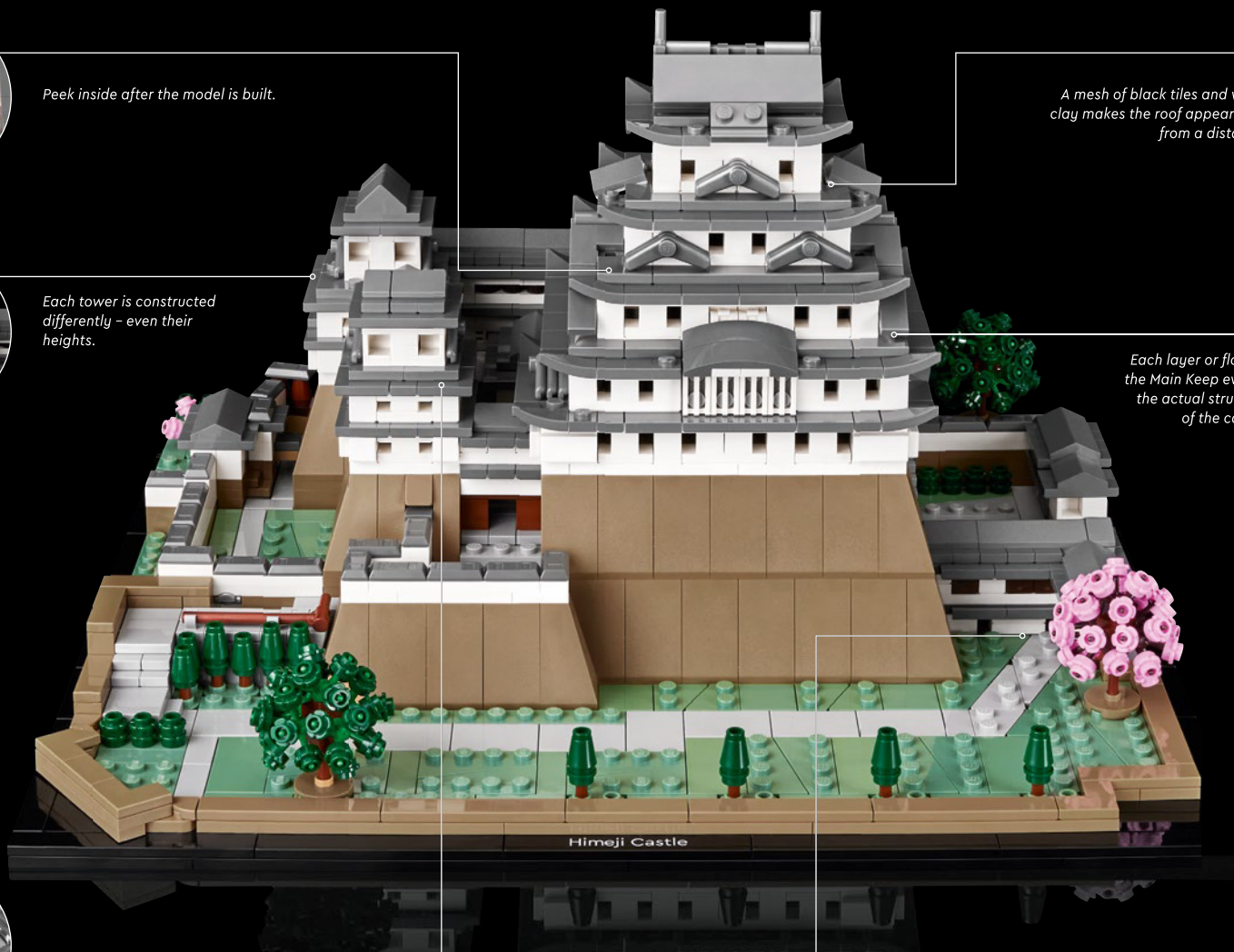

Himeji Castle

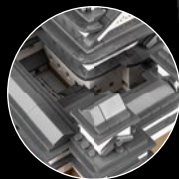

Irregular angles are predominant throughout the castle and walls.



Decorate the cherry trees with pink blossoms or green leaves.

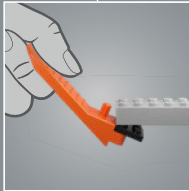
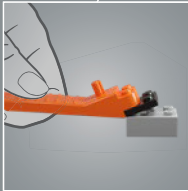
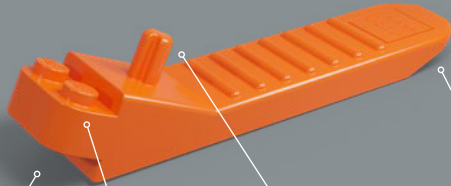

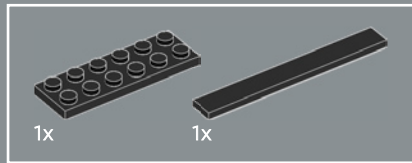

1

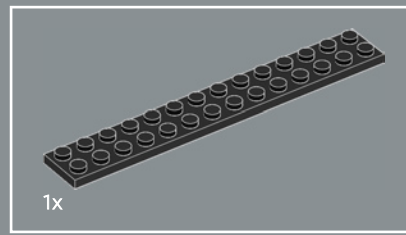
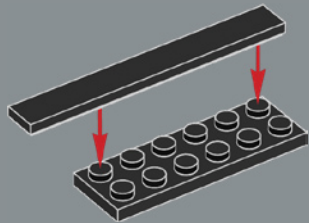

2

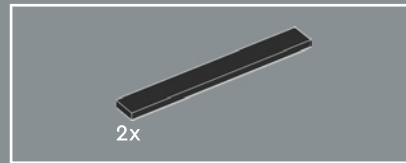
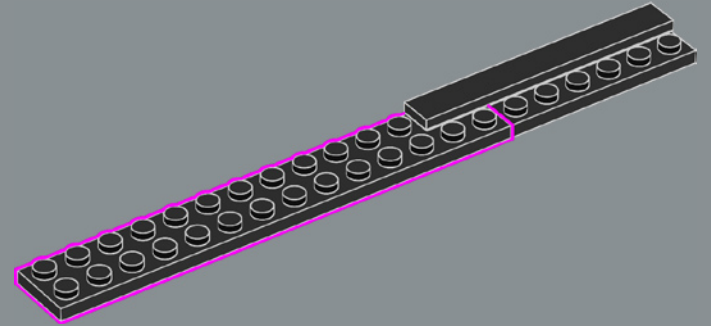

3

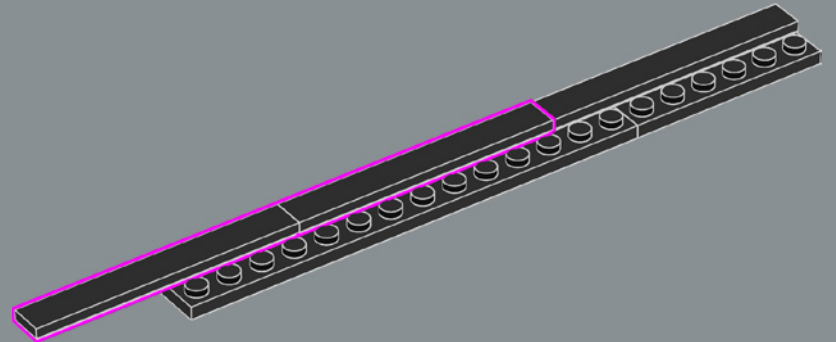

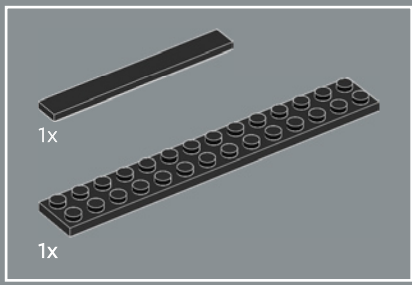

4

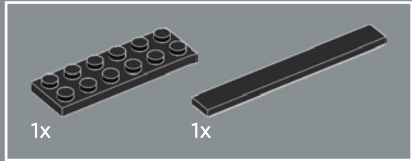
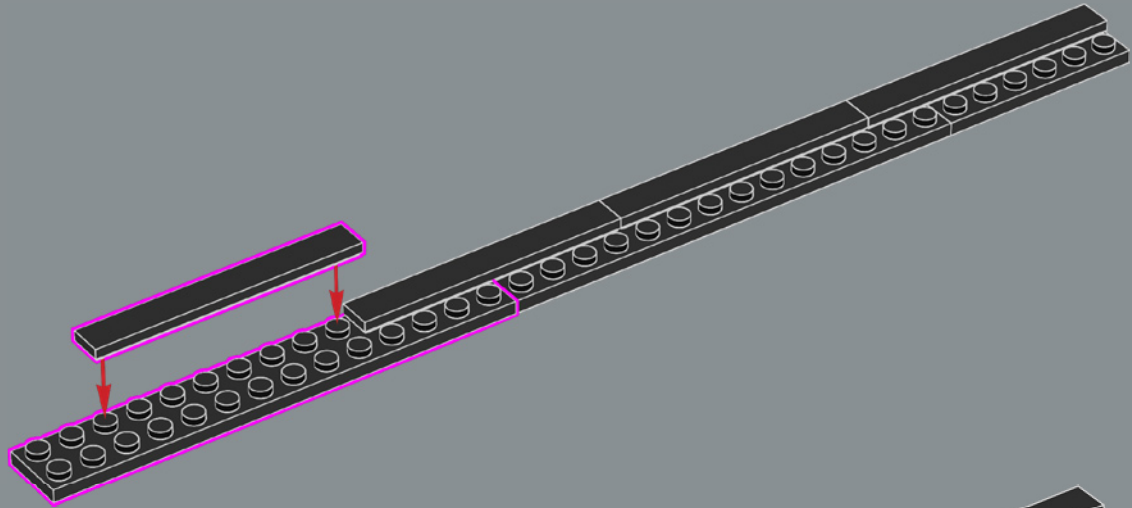

5

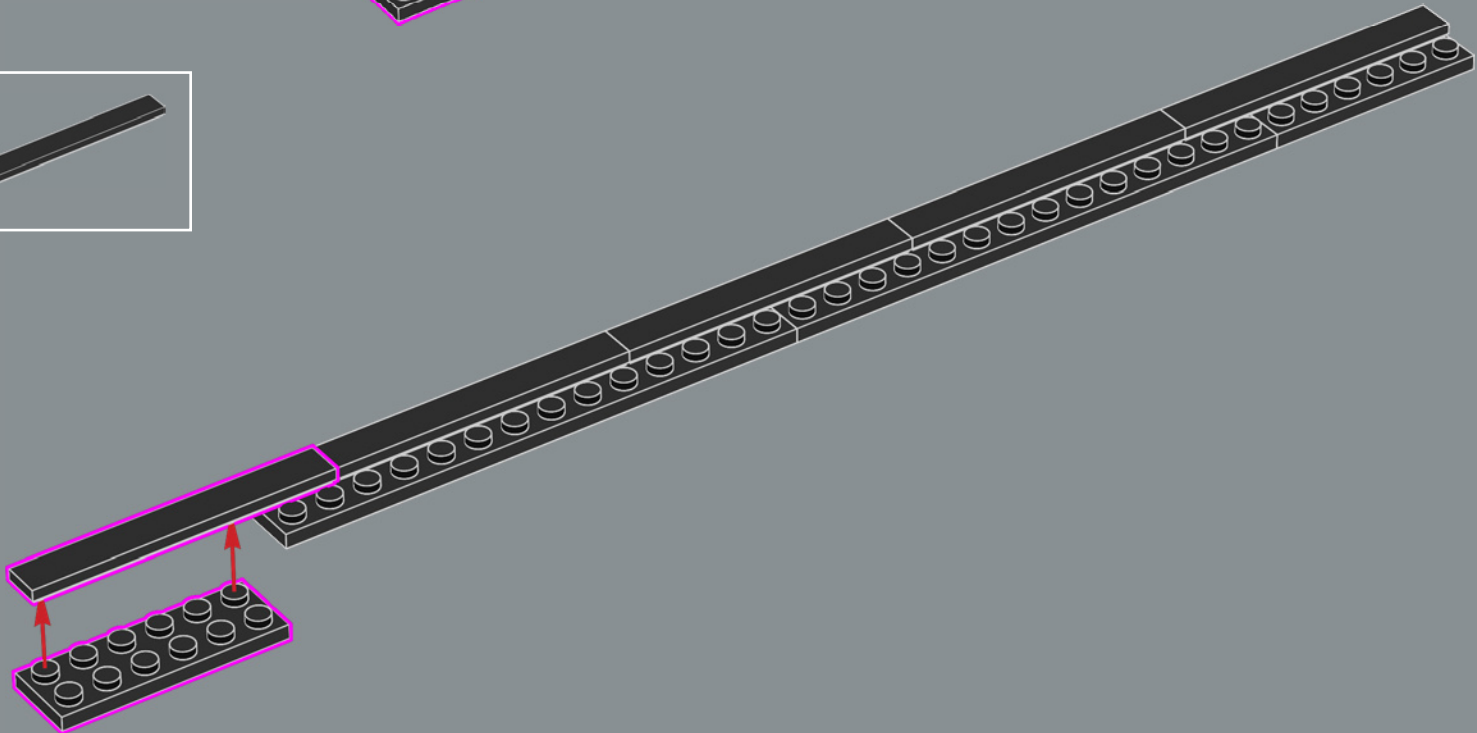

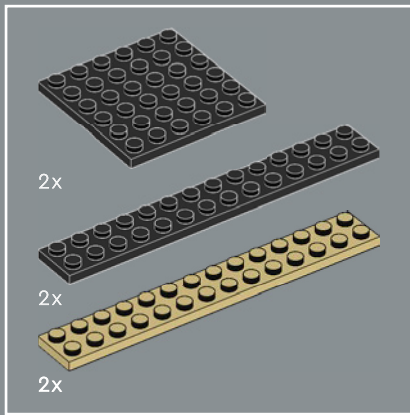

6

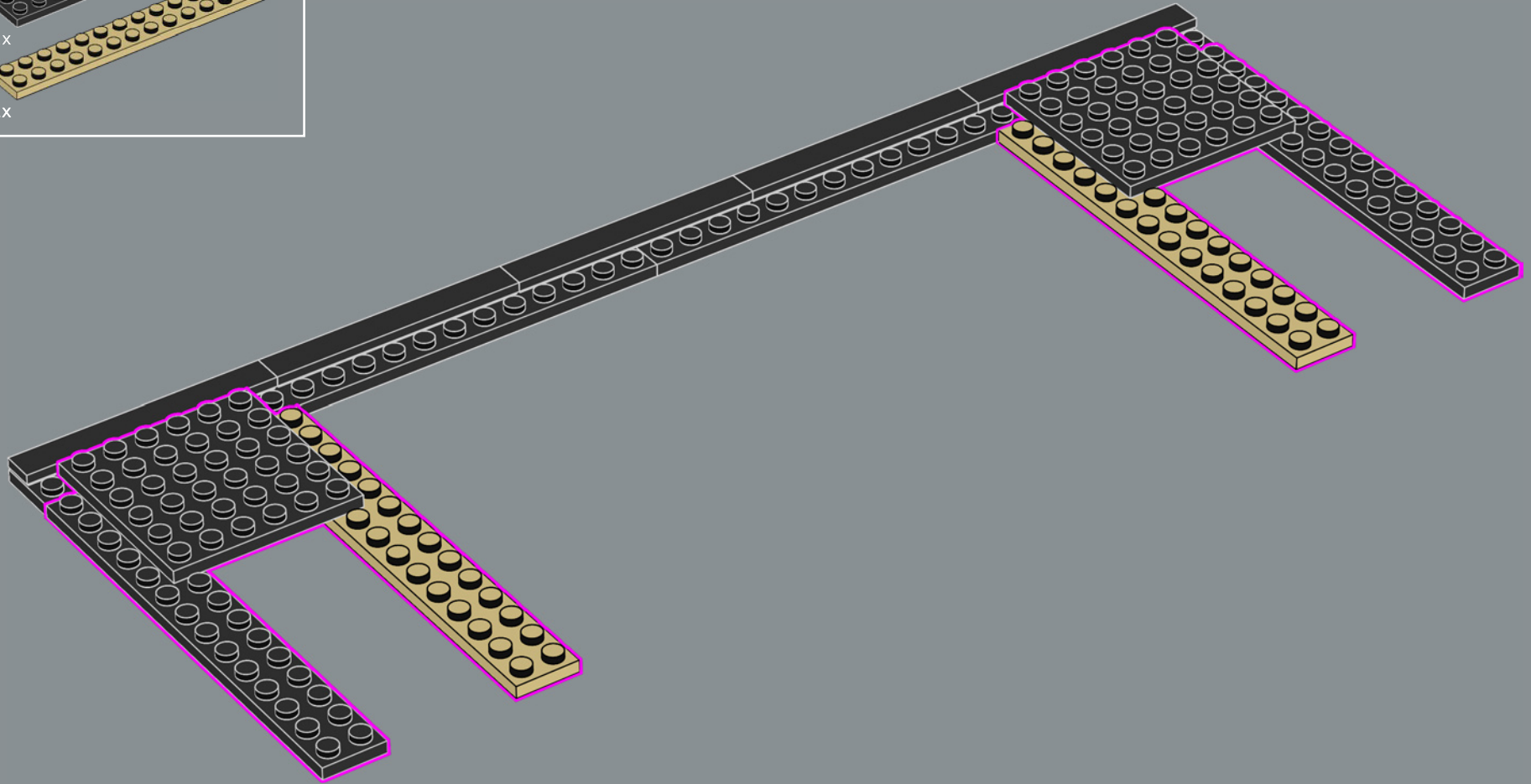

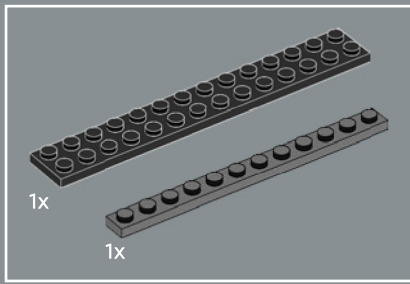

8

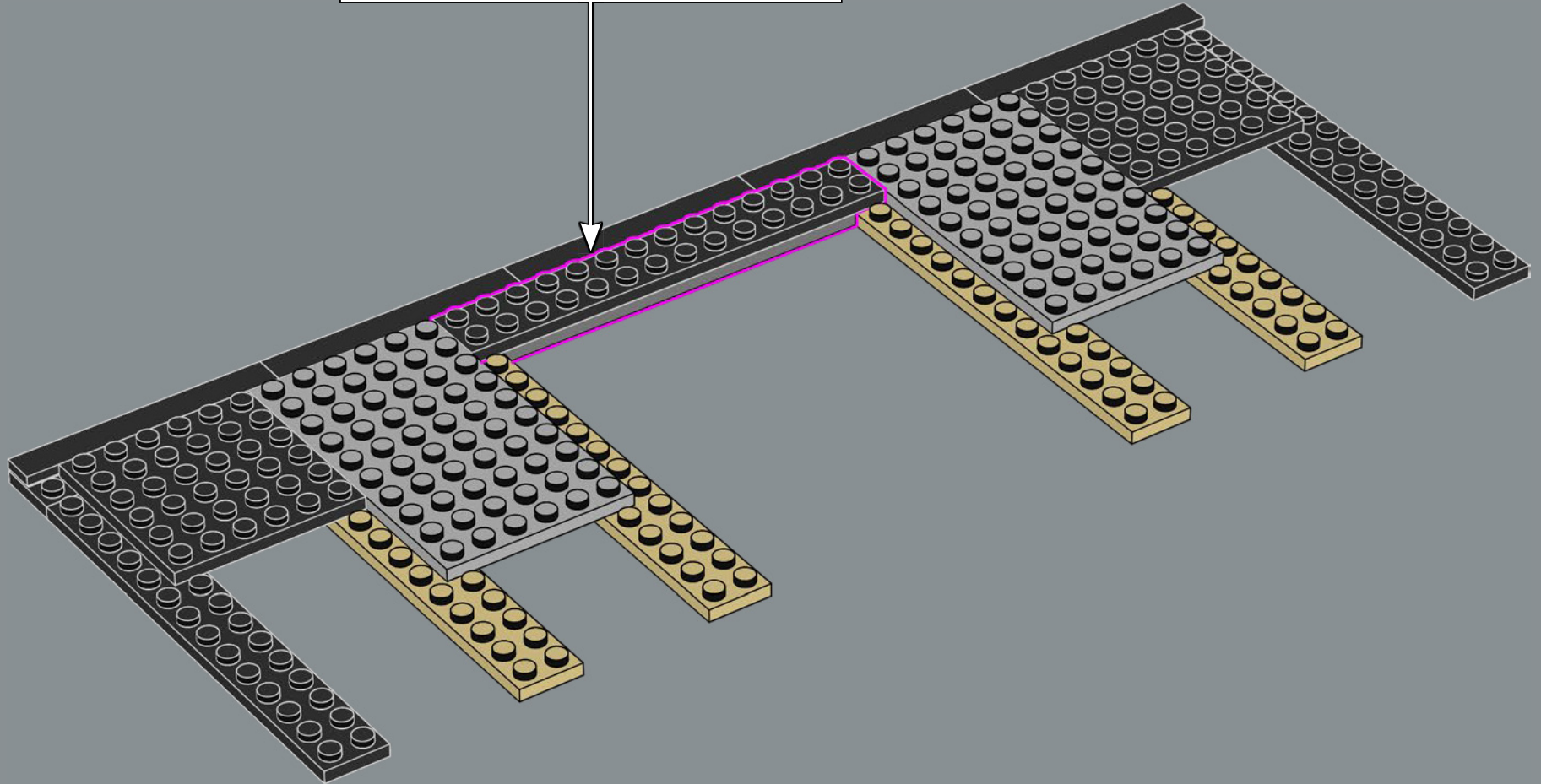
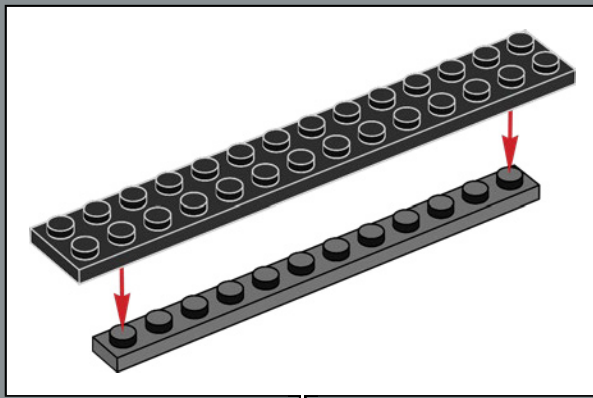

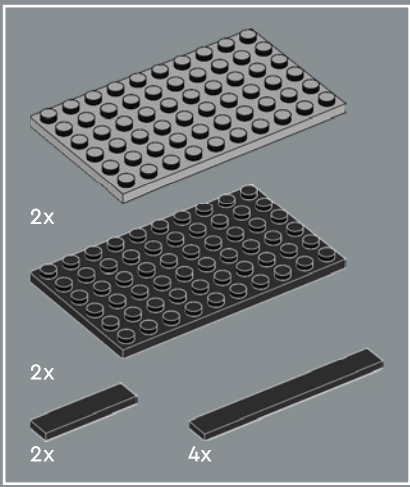

9

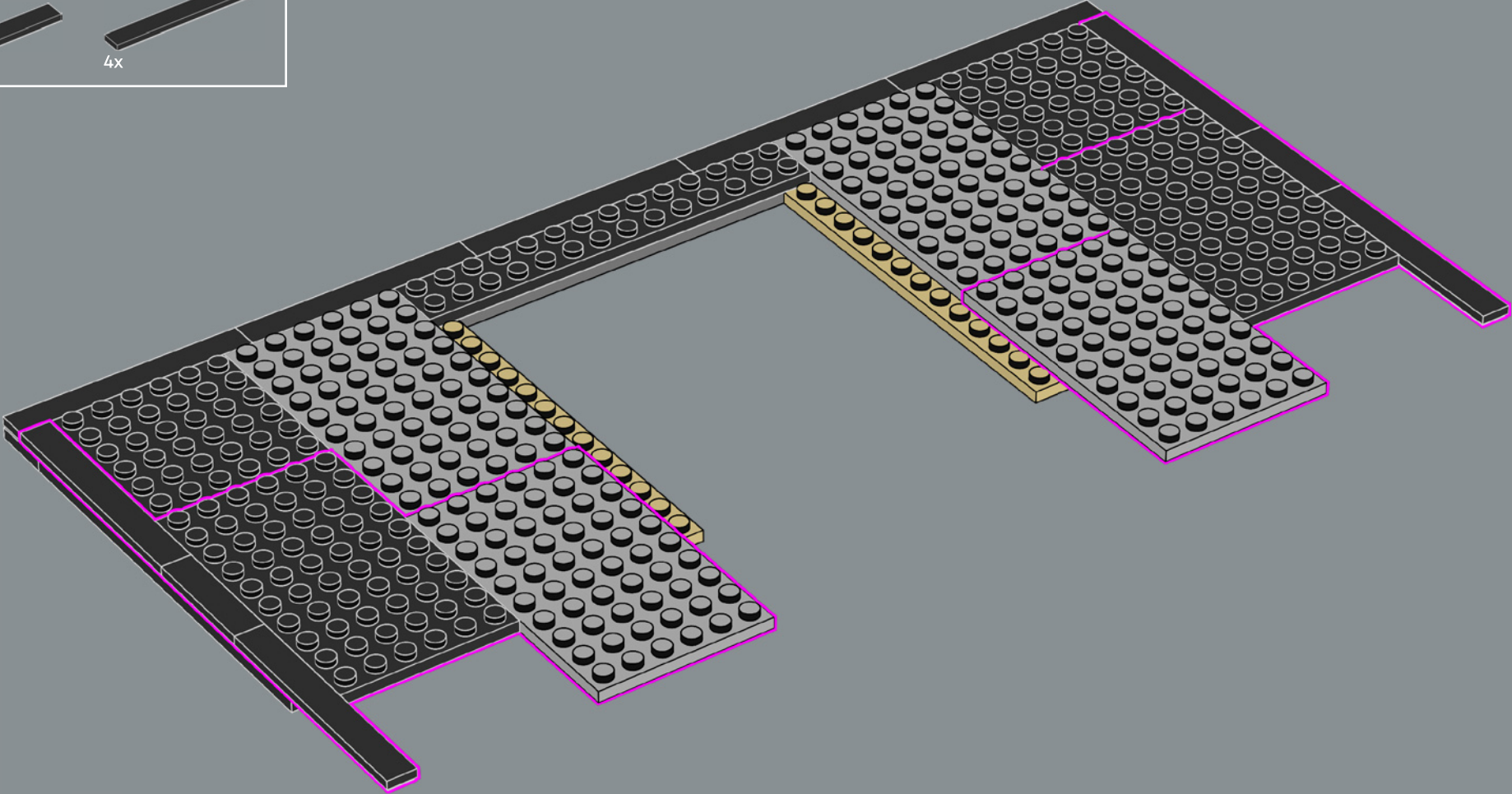

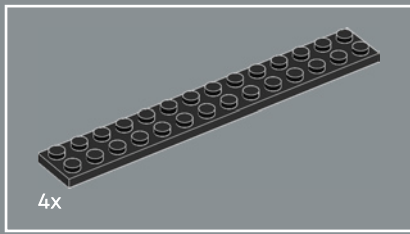

10

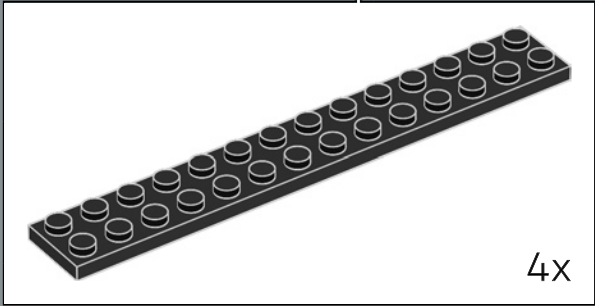
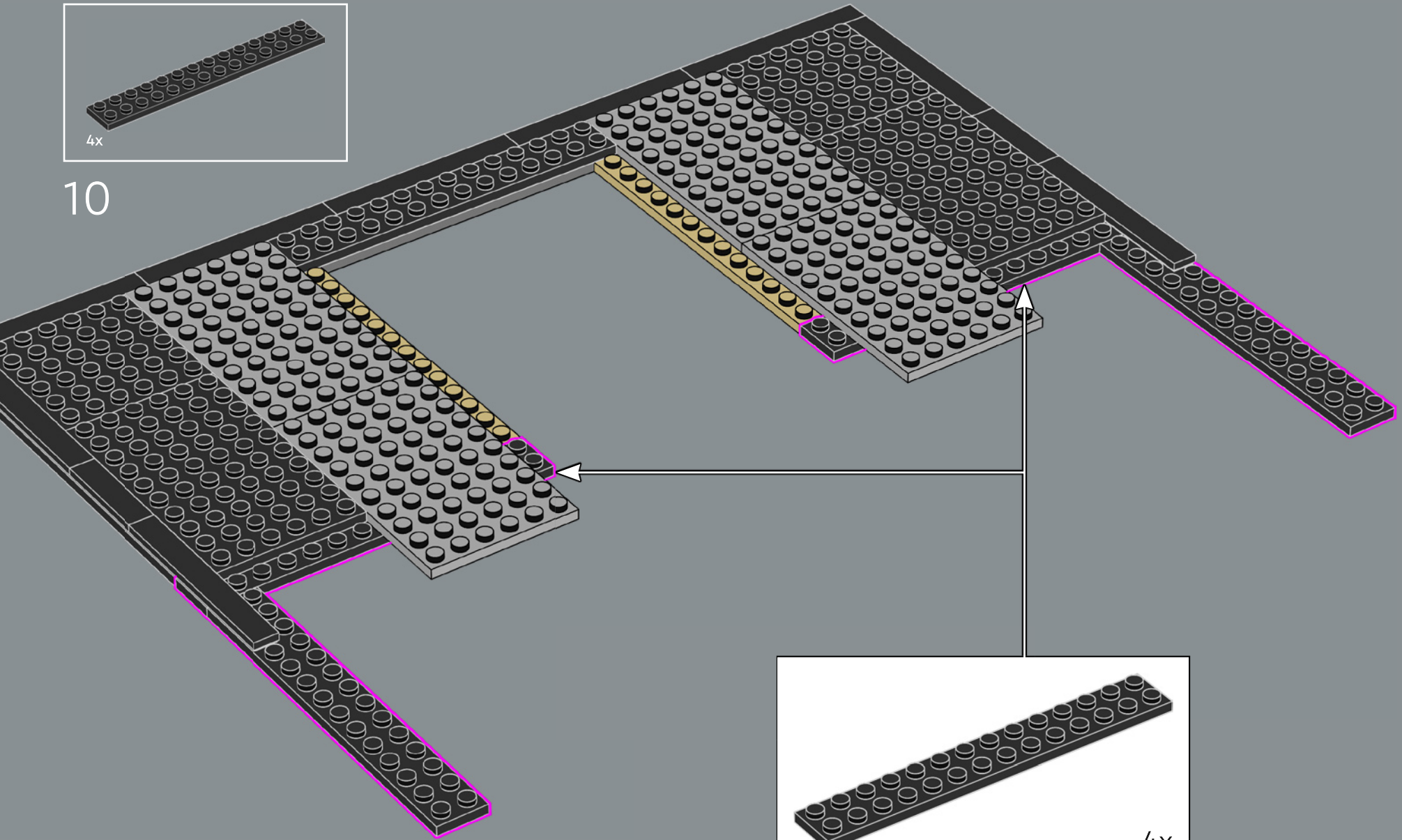

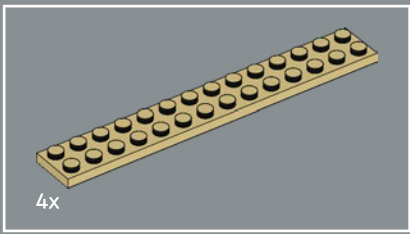

11

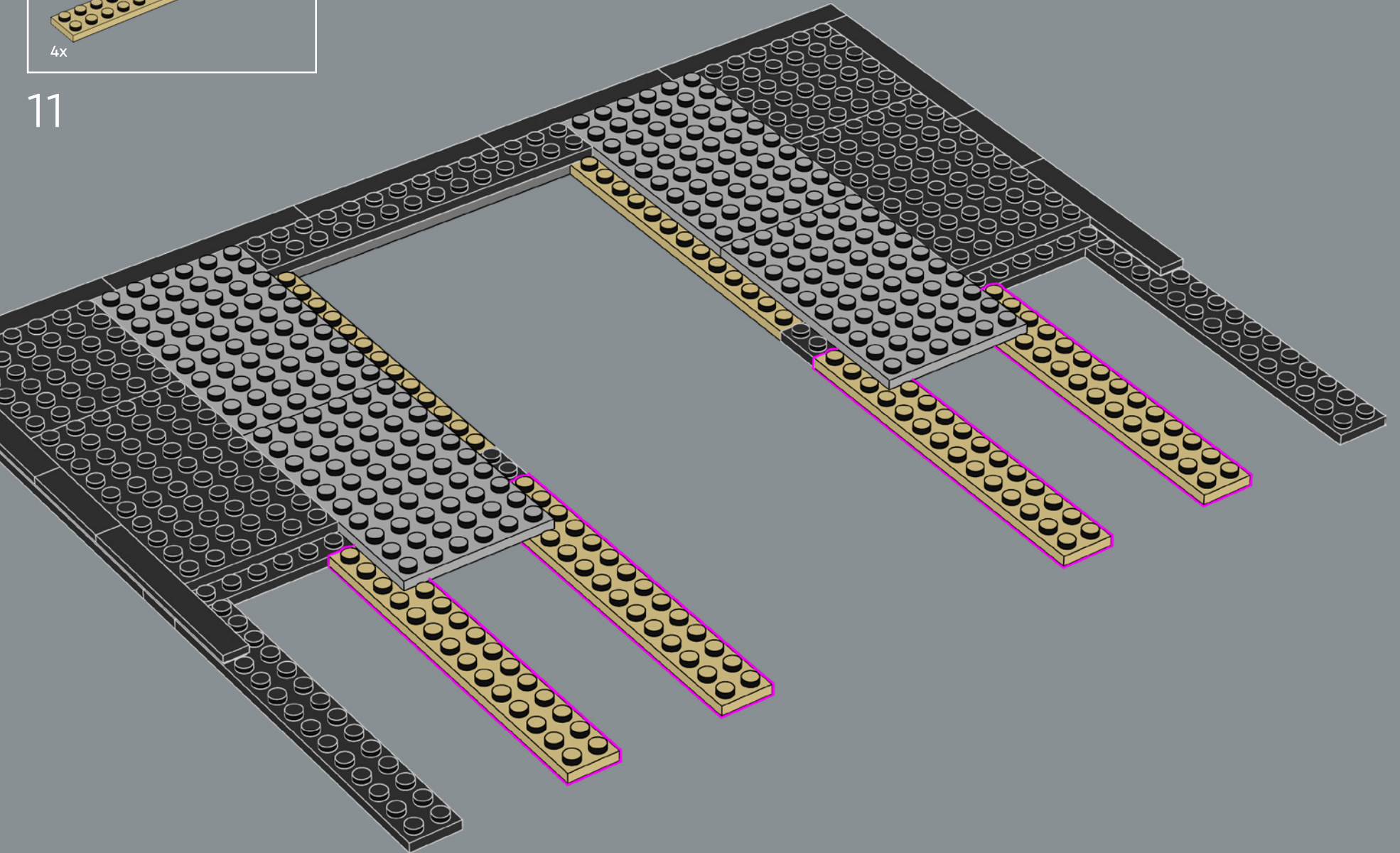

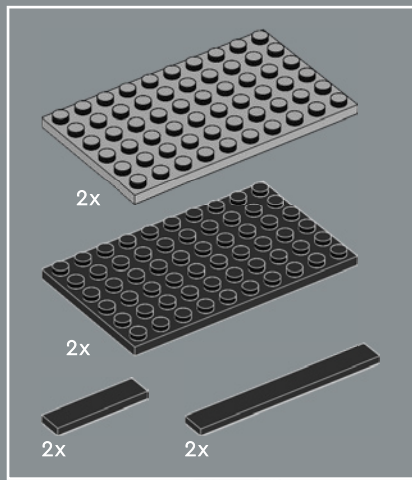

12

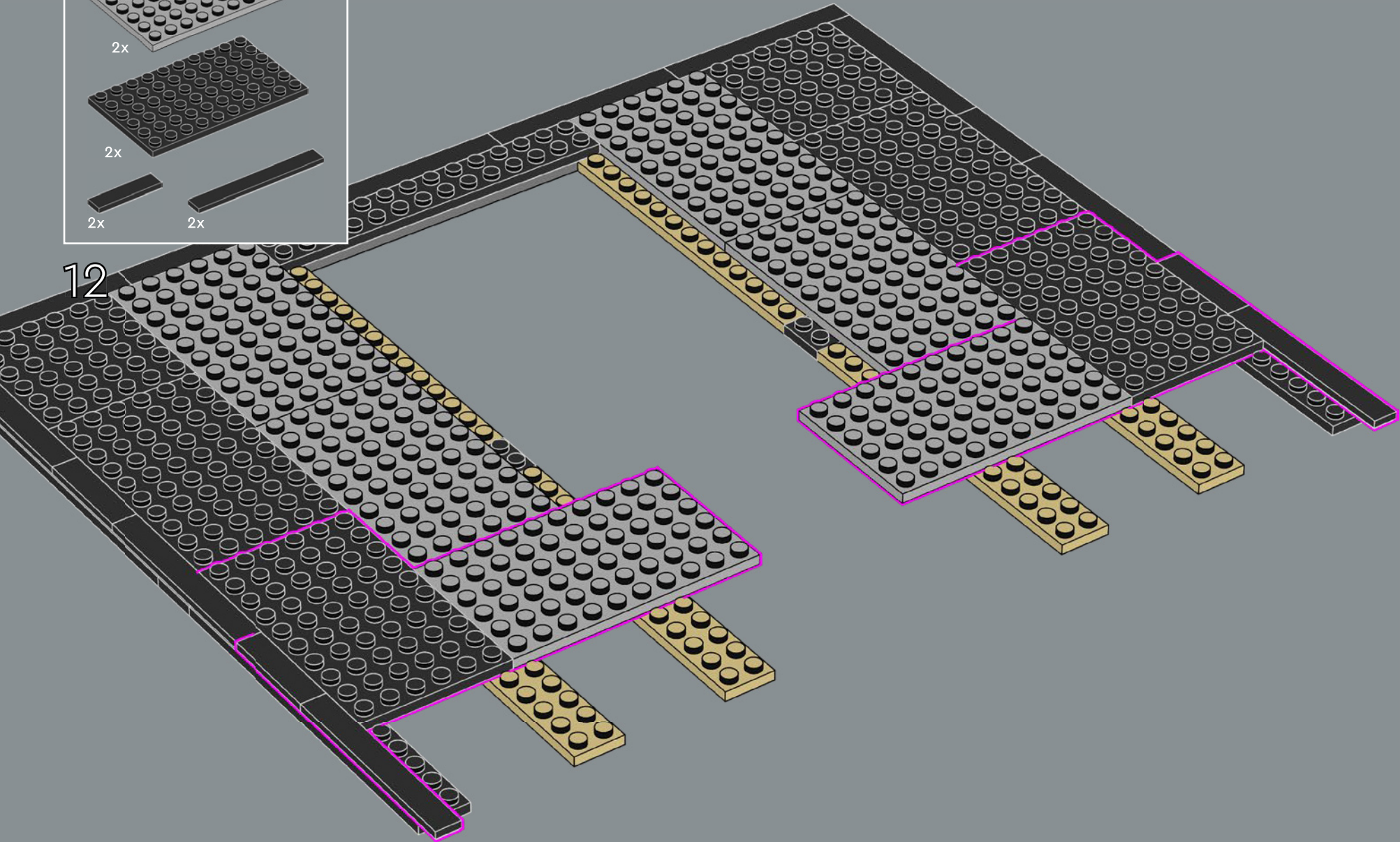

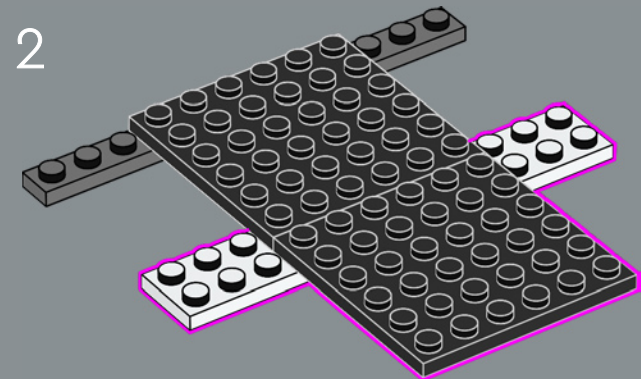
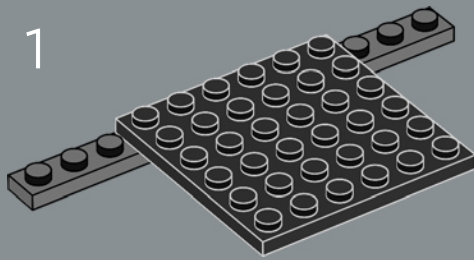
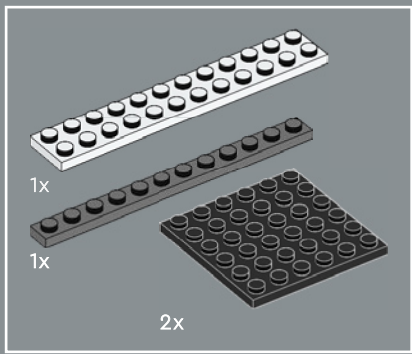

13

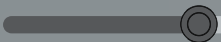
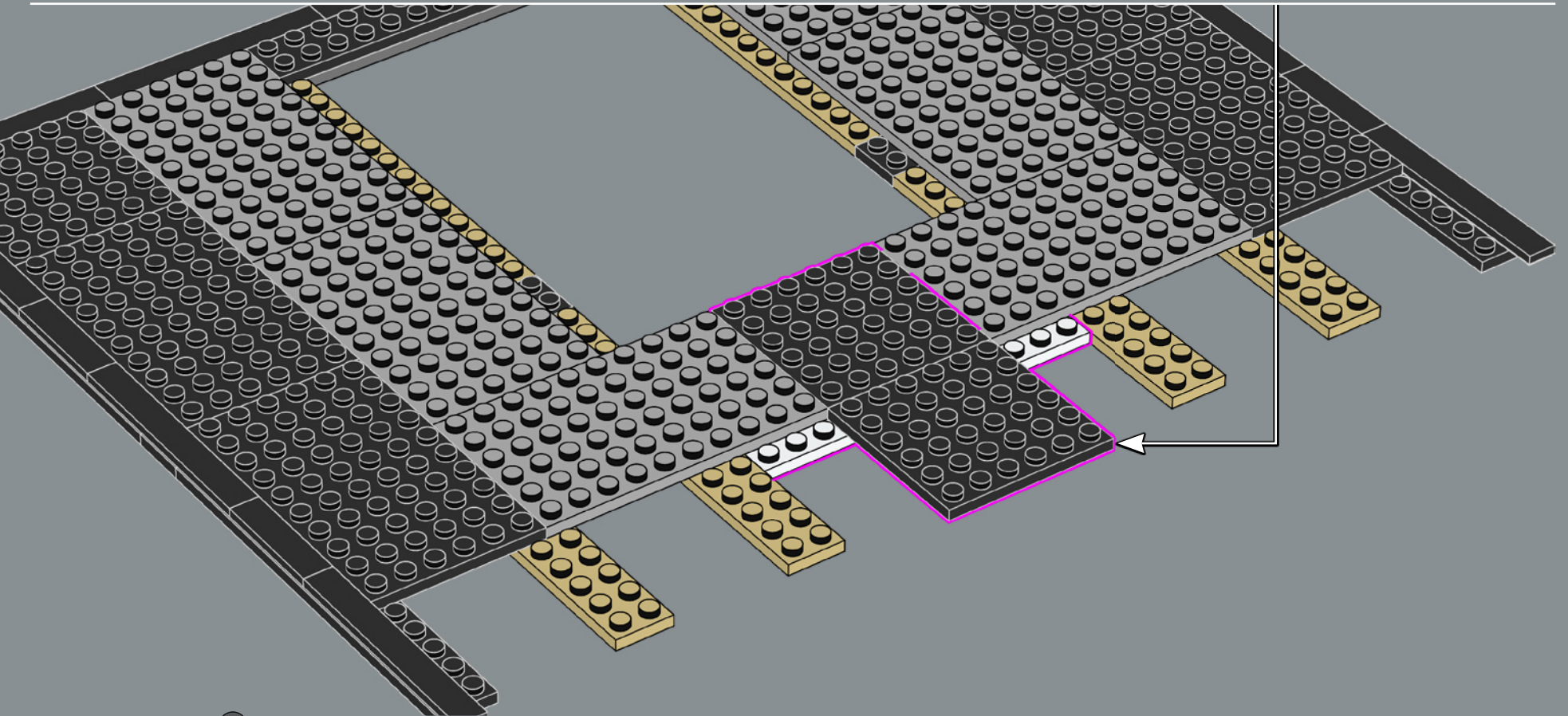

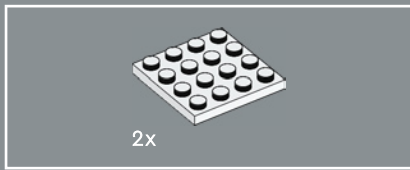

14

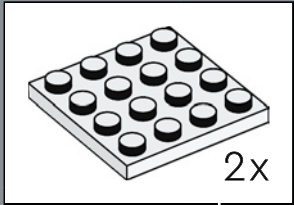
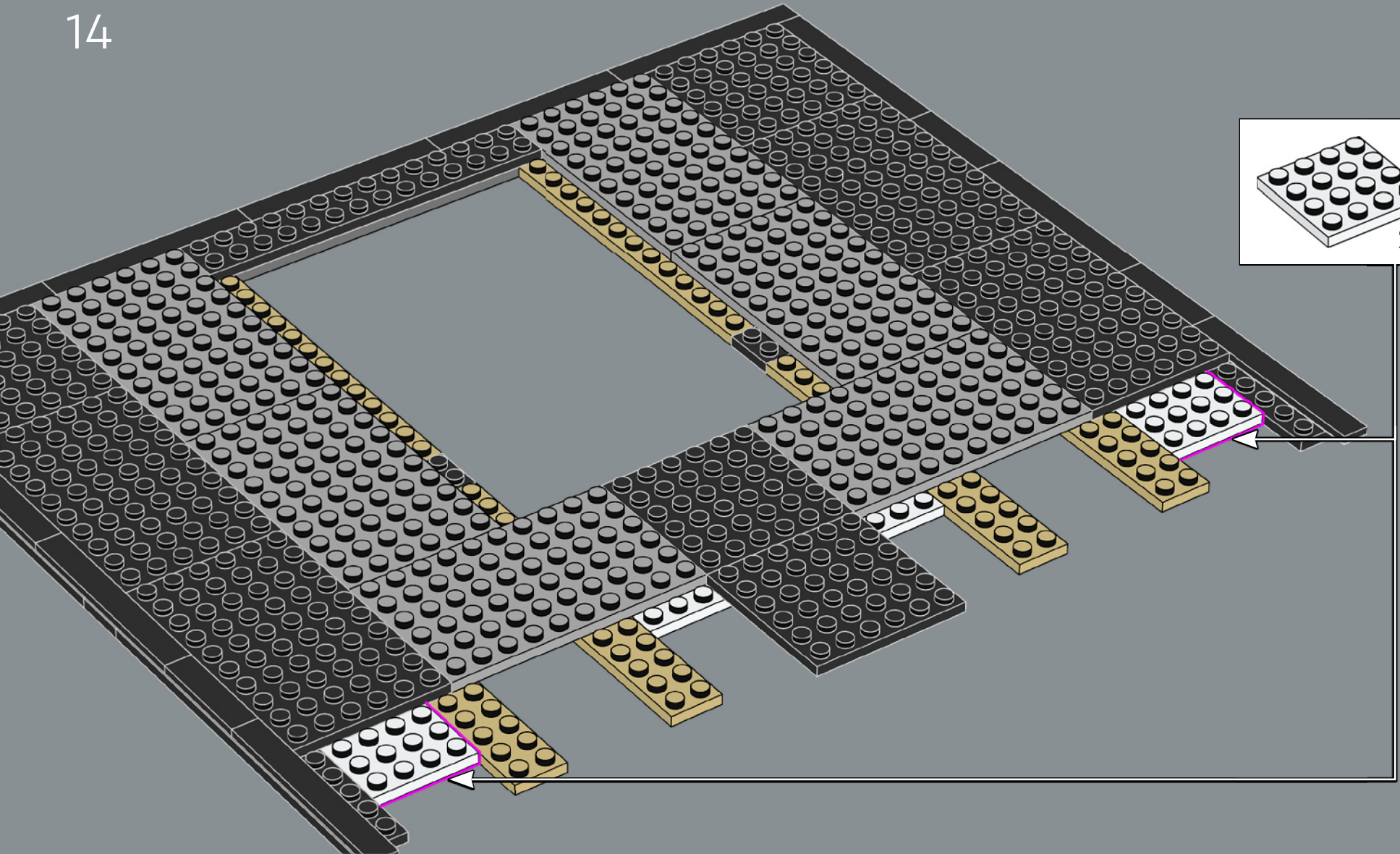

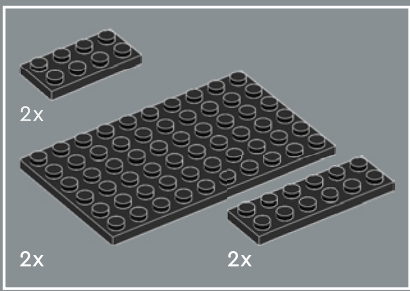

15

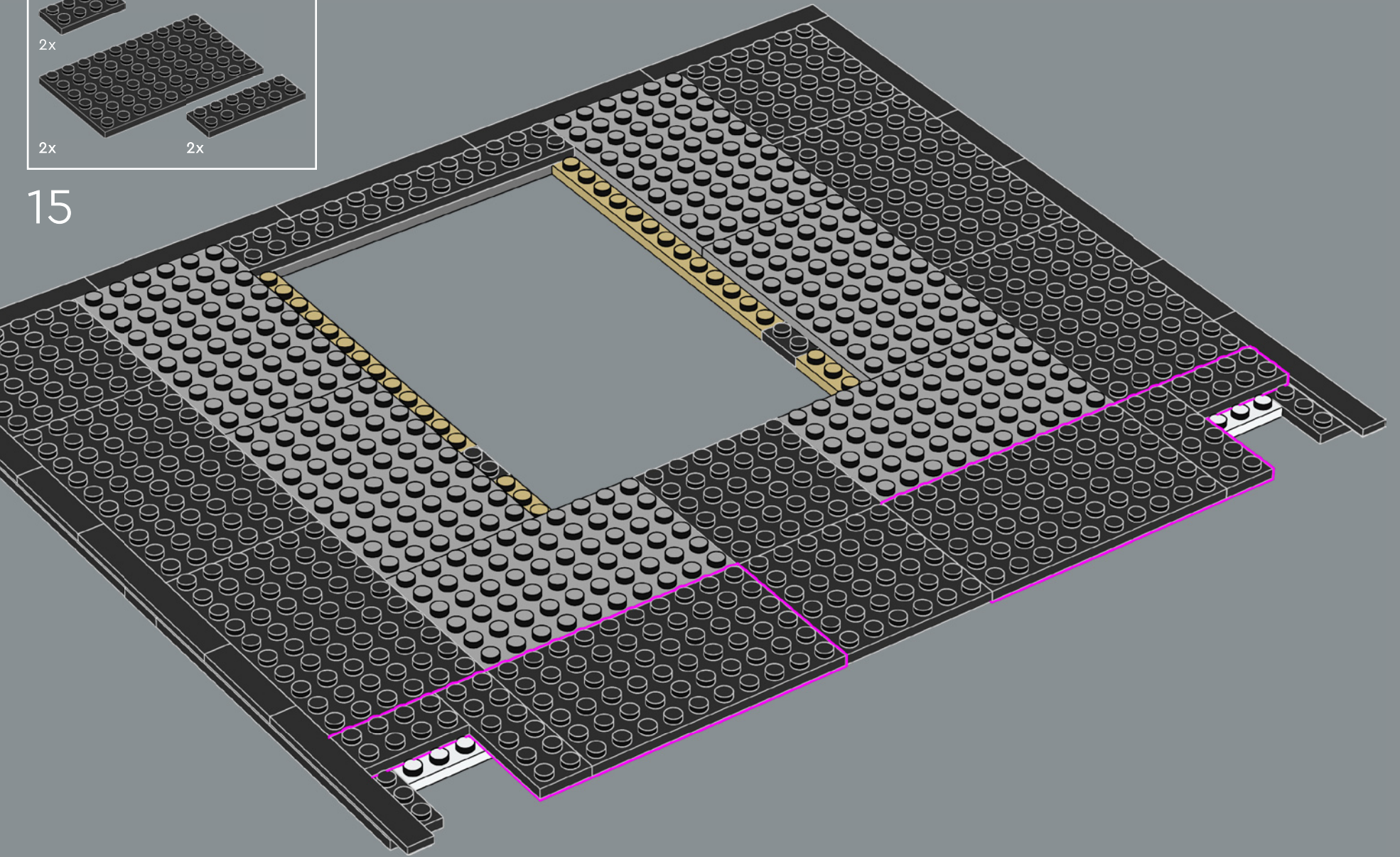

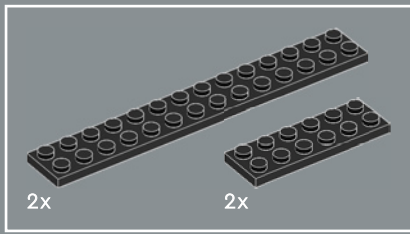

16

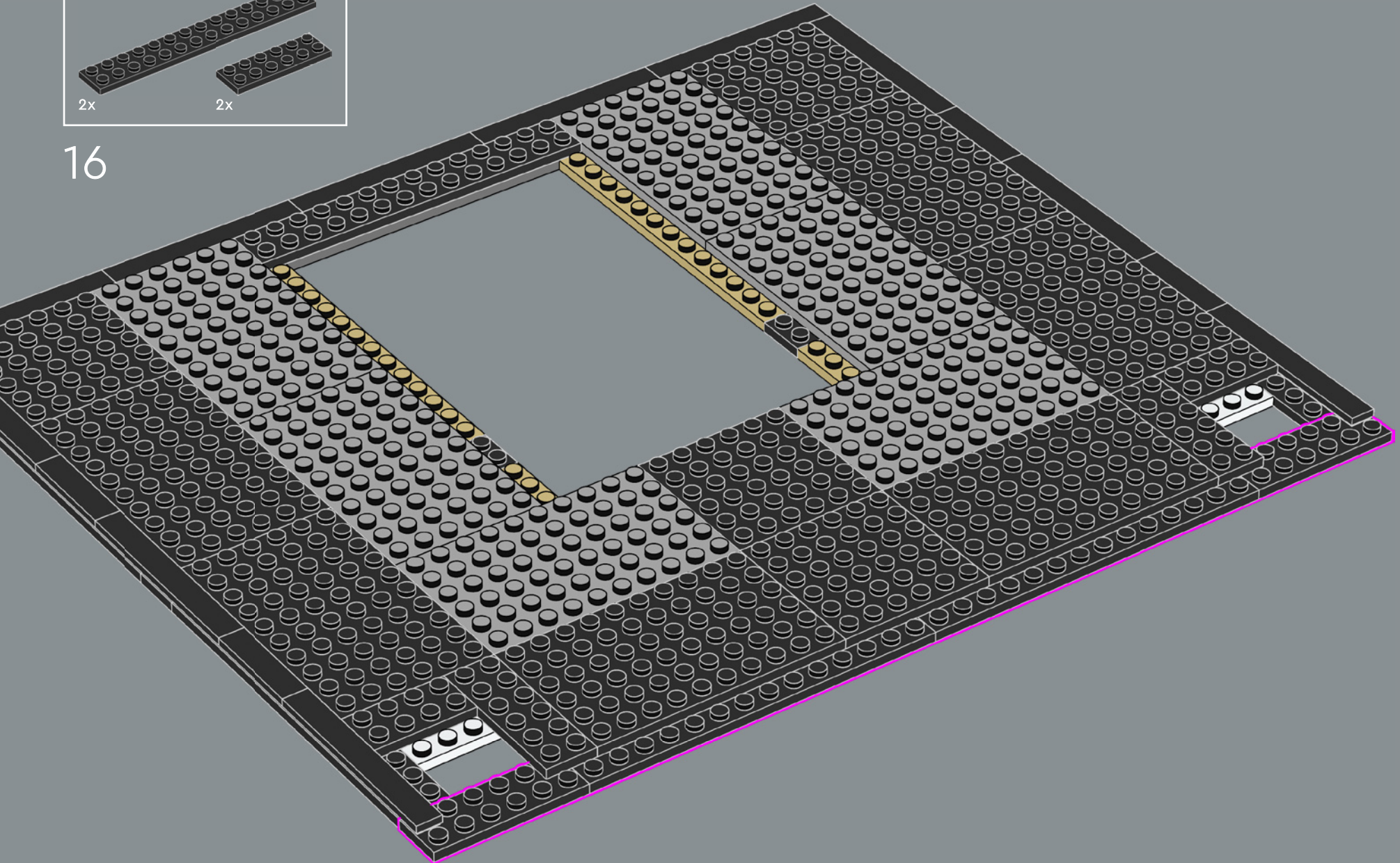

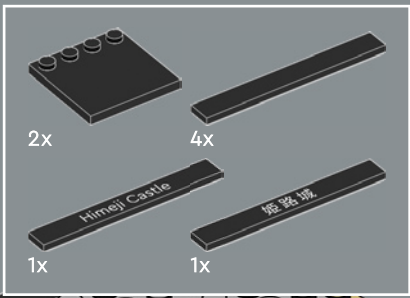

17

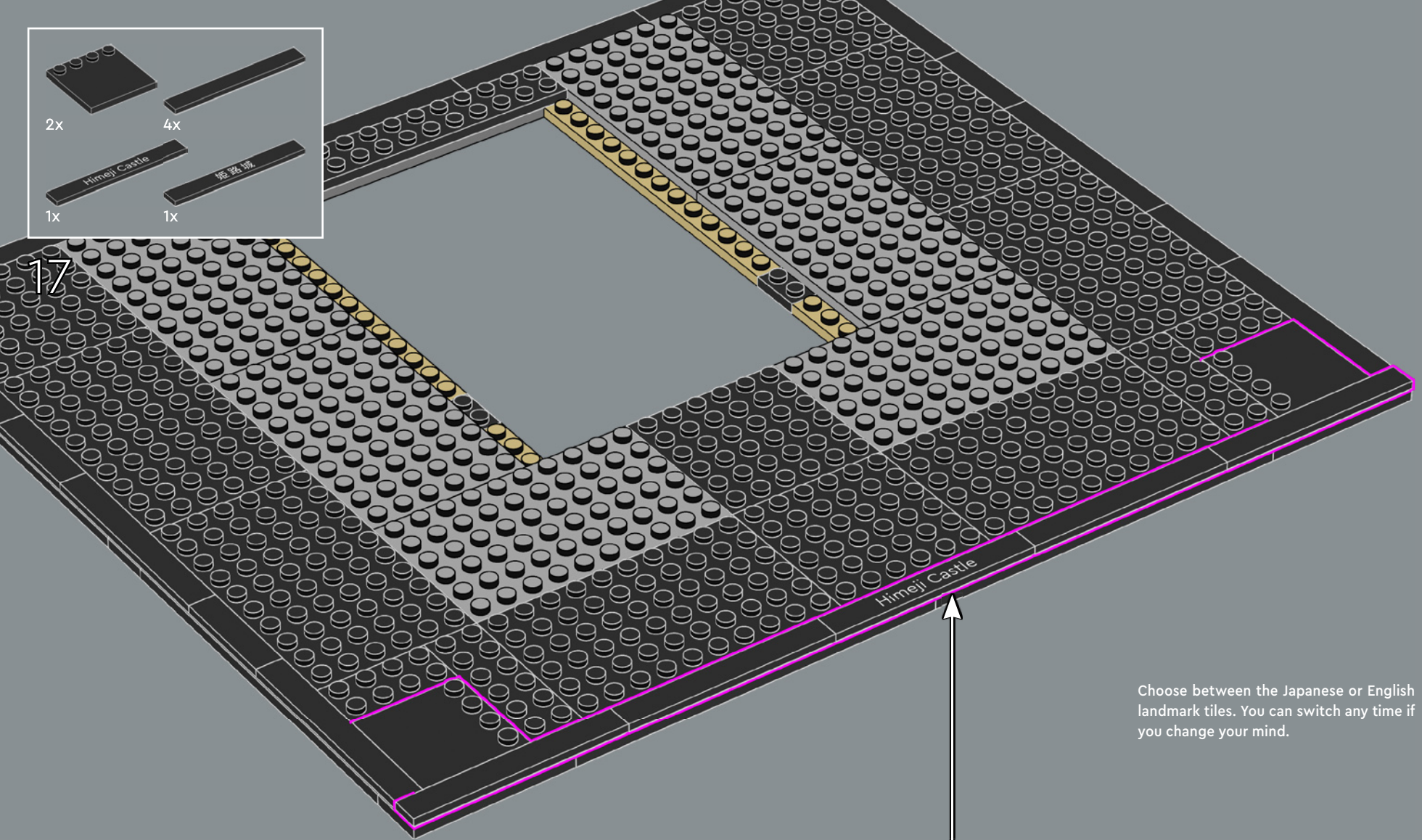

Choose between the Japanese or English landmark tiles. You can switch any time if you change your mind.

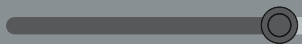
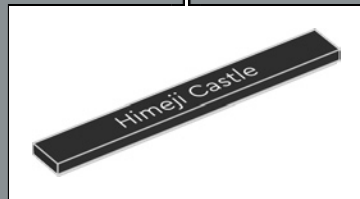

In 1993, Himeji Castle was inscribed on UNESCO's World Heritage list, honouring the landmark as a masterpiece and the culmination of Japanese castle architecture in wood.

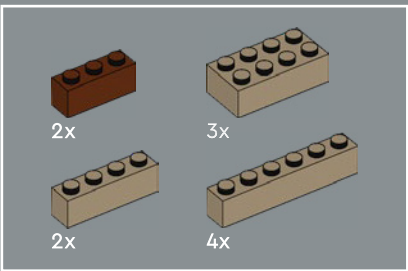

18

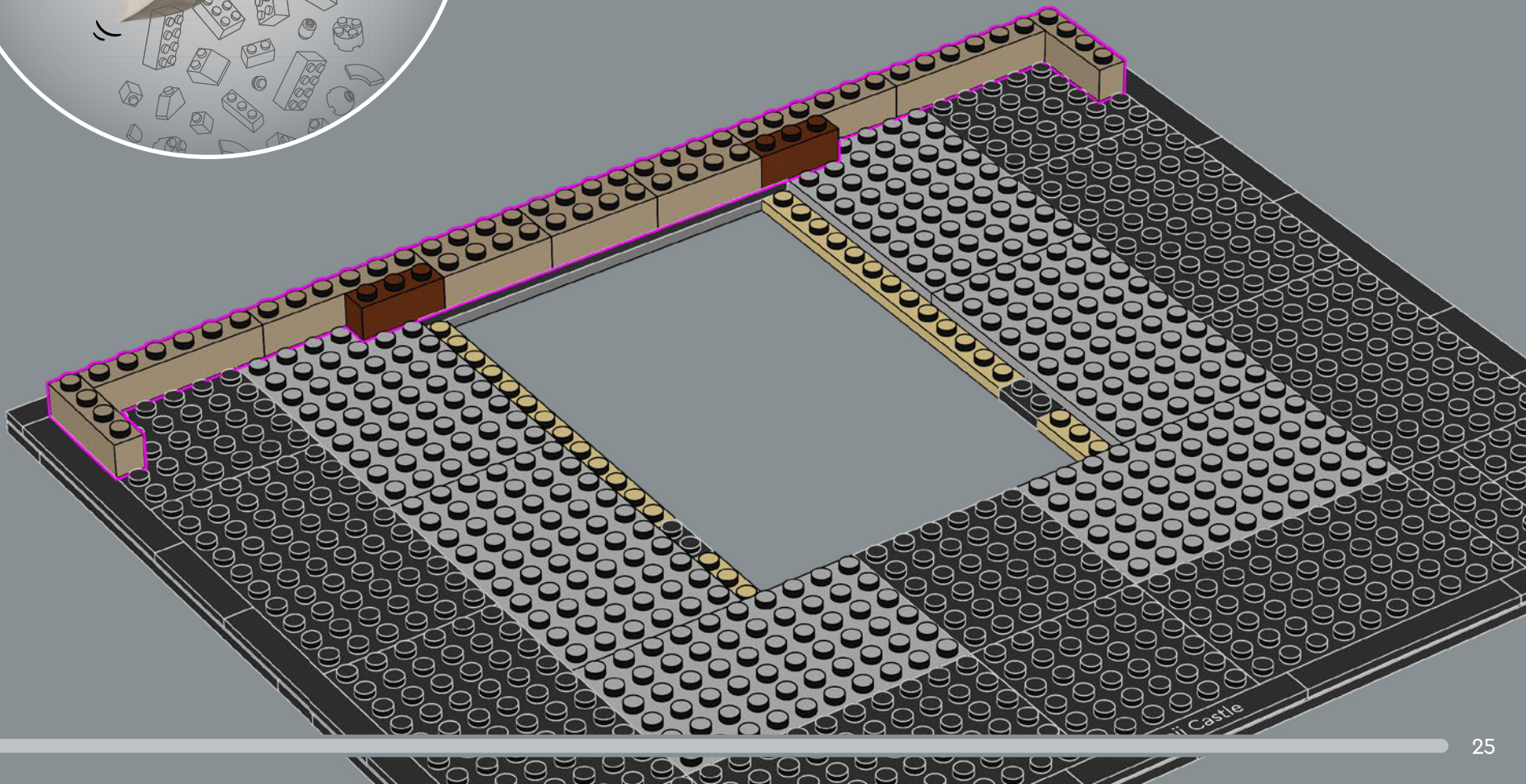

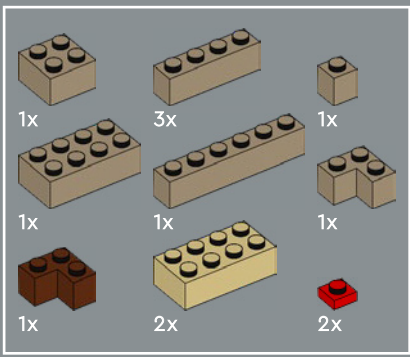

19

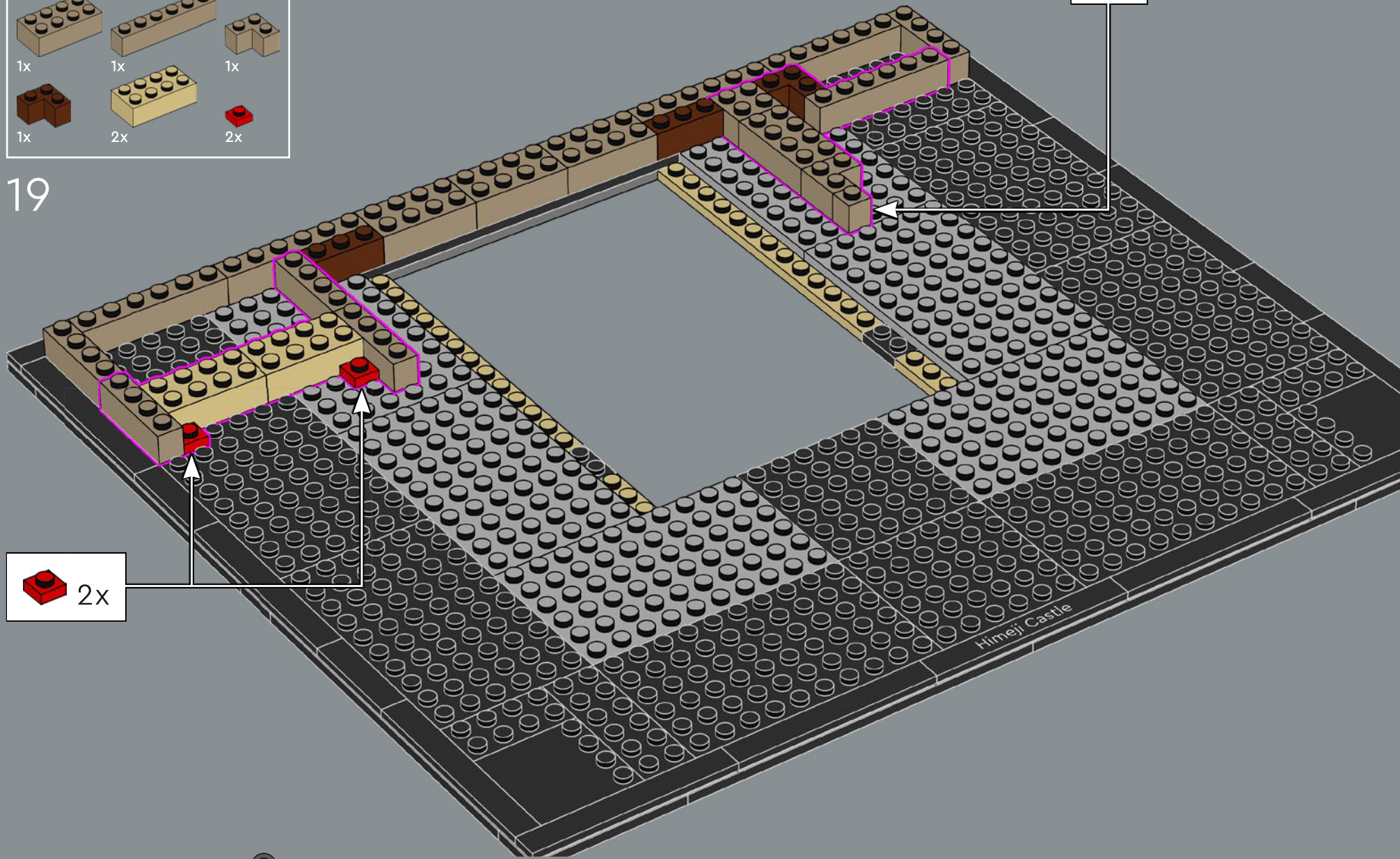
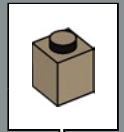

Himeji Castle

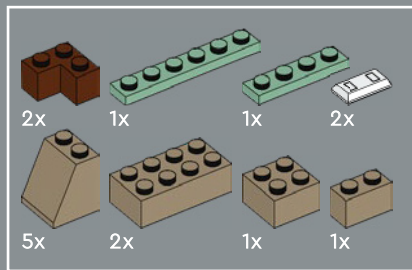

20

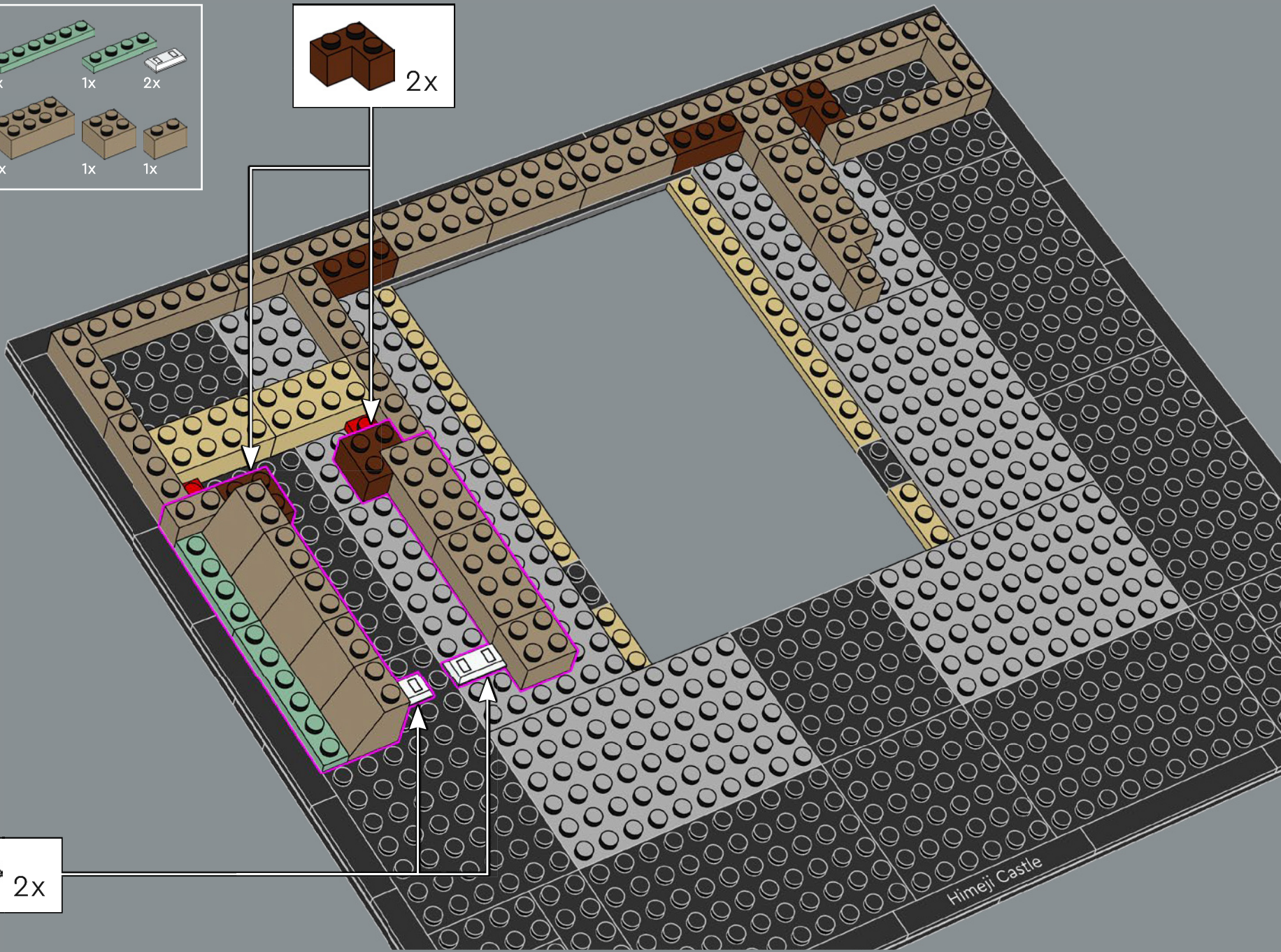

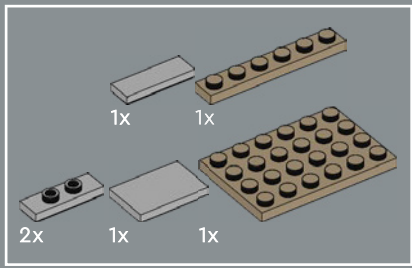



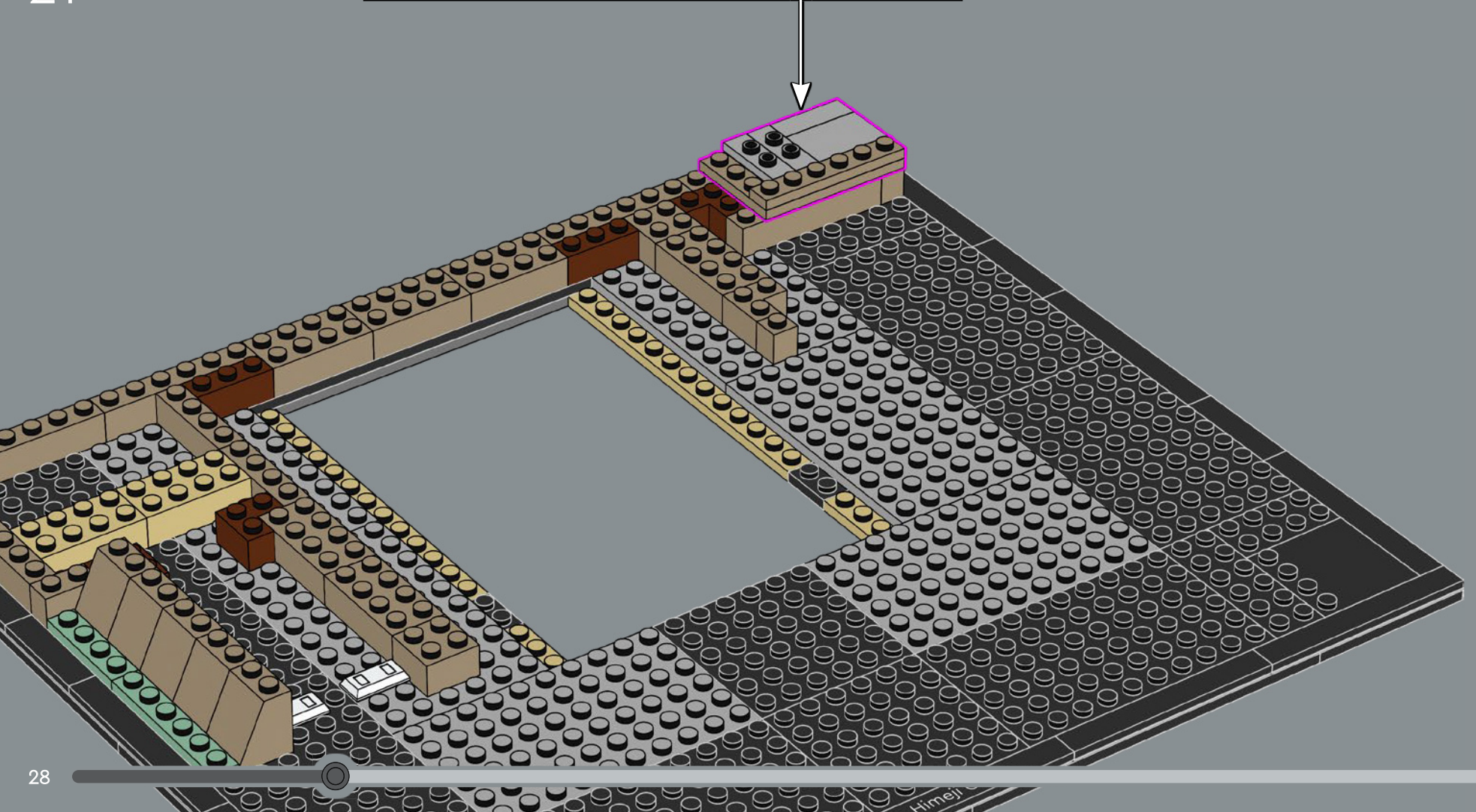
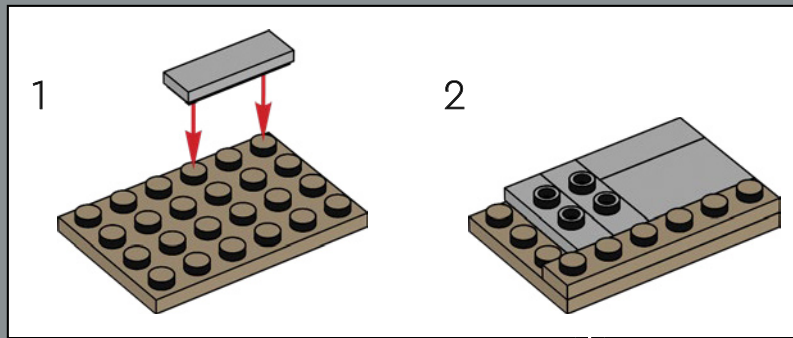

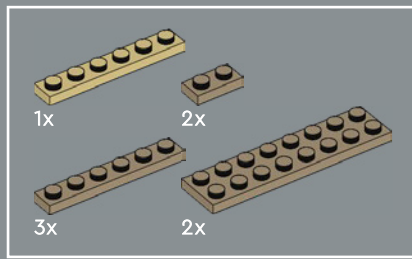

21

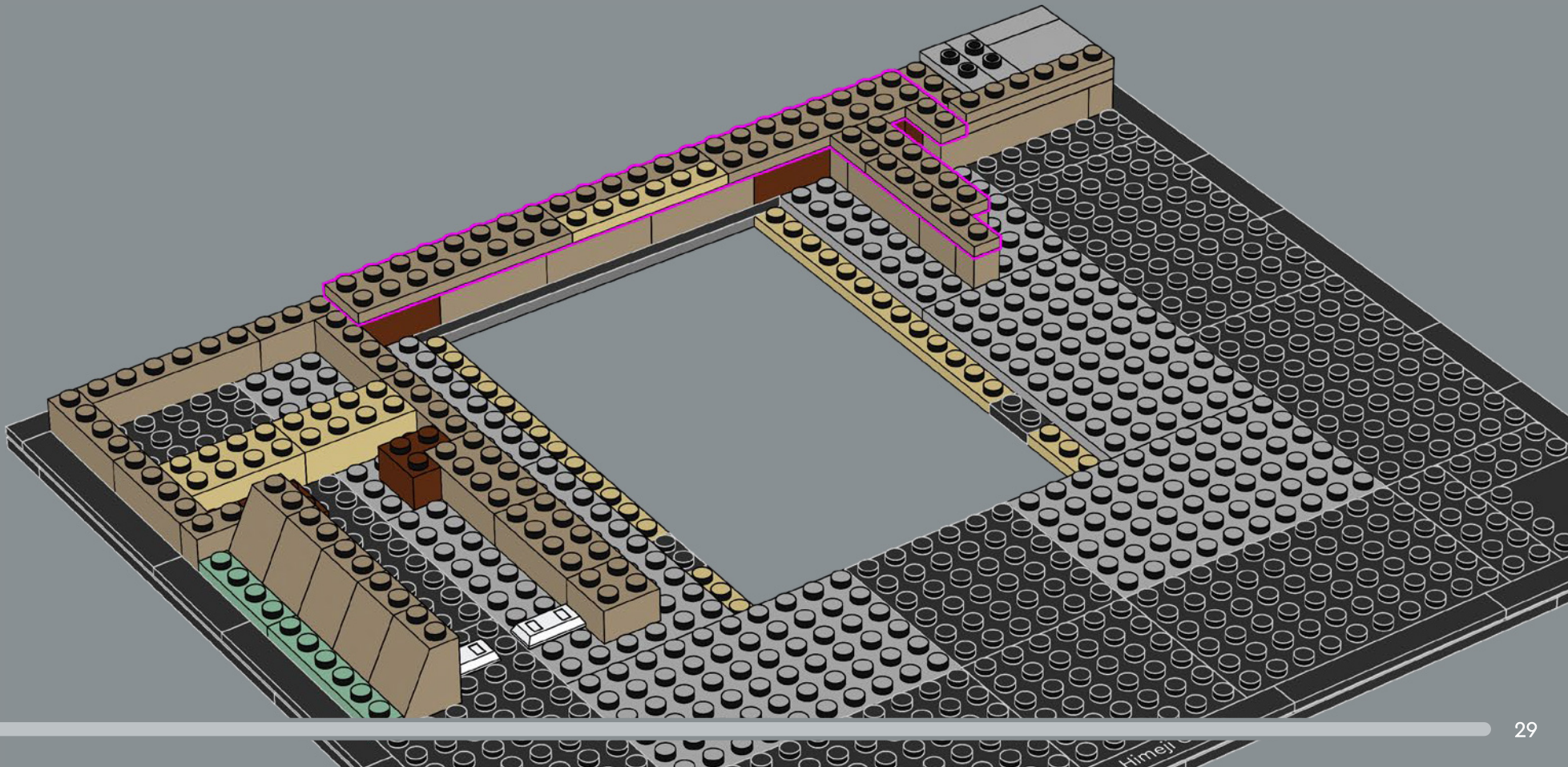



22



- 1x 
- 1x 
- 2x 
- 2x 
- 1x 

23

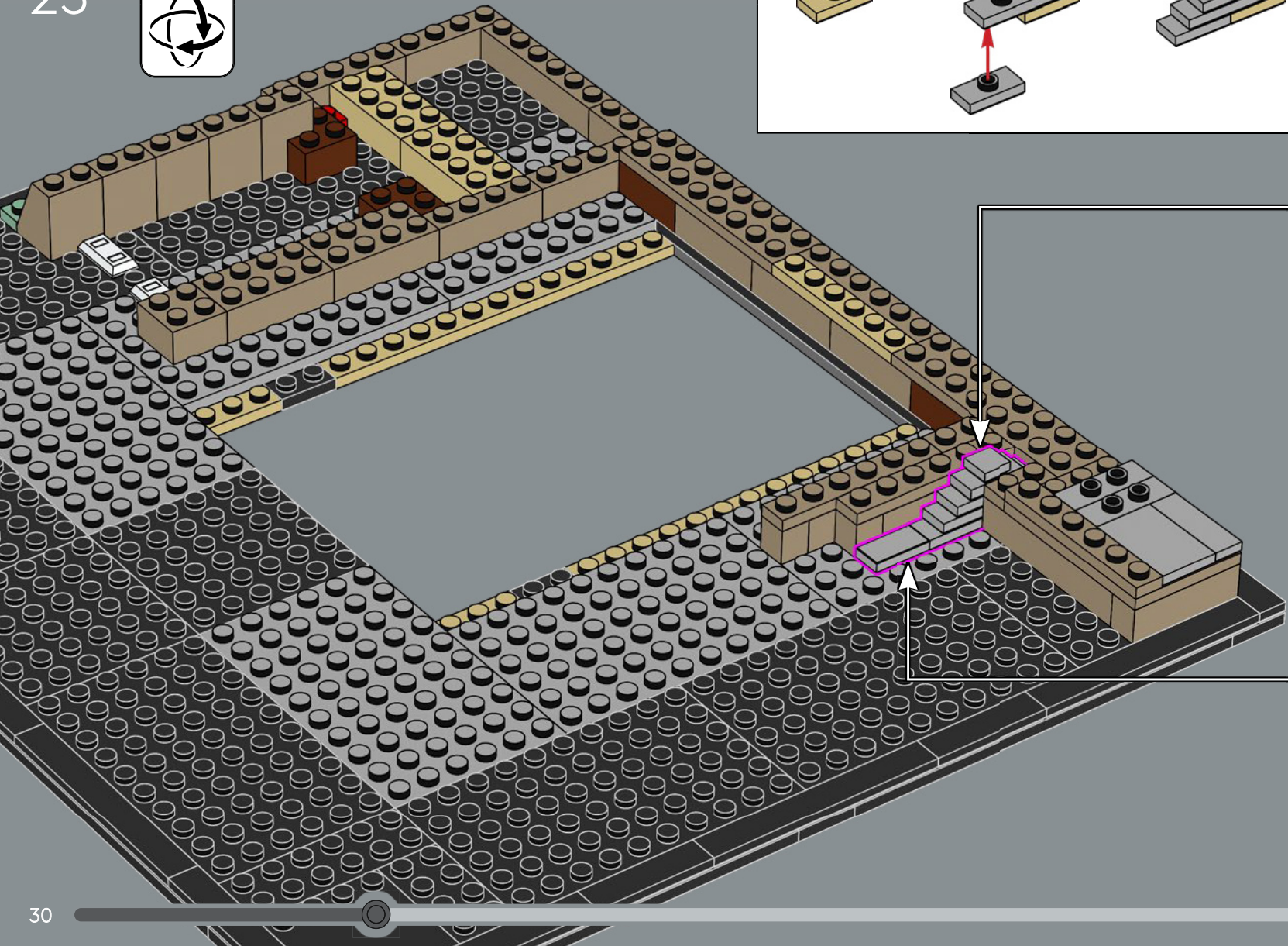
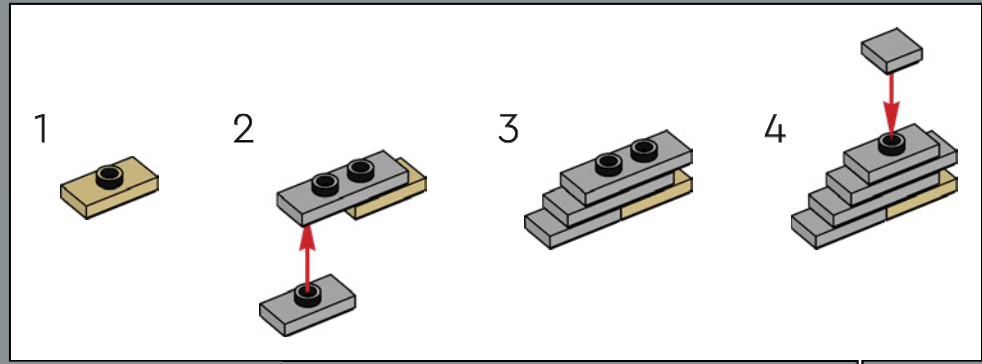

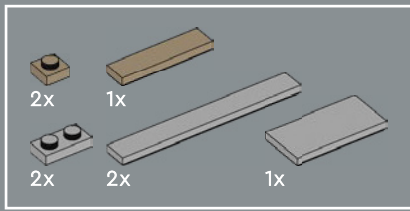

24

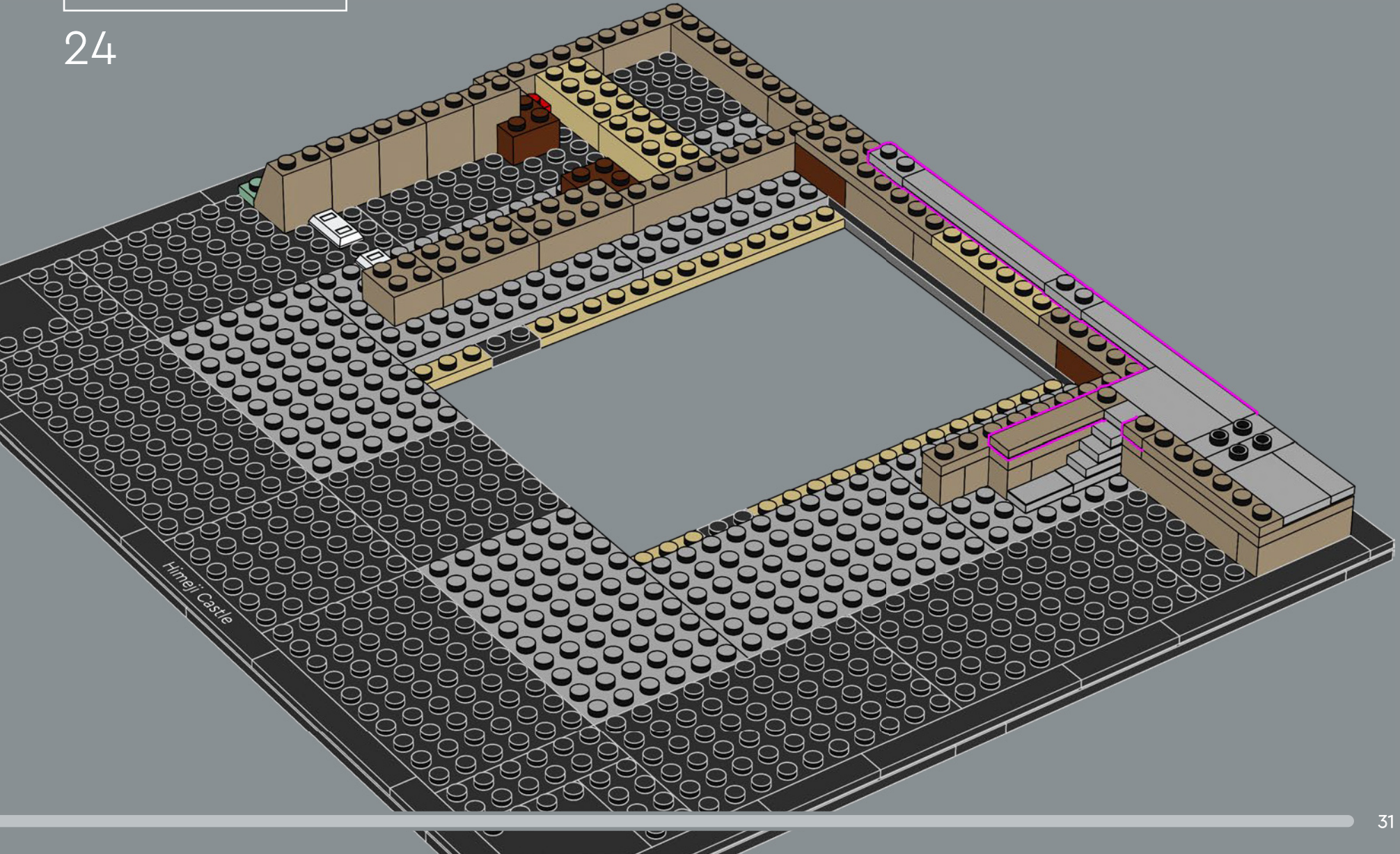

1x  4x  1x 

25

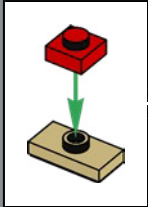
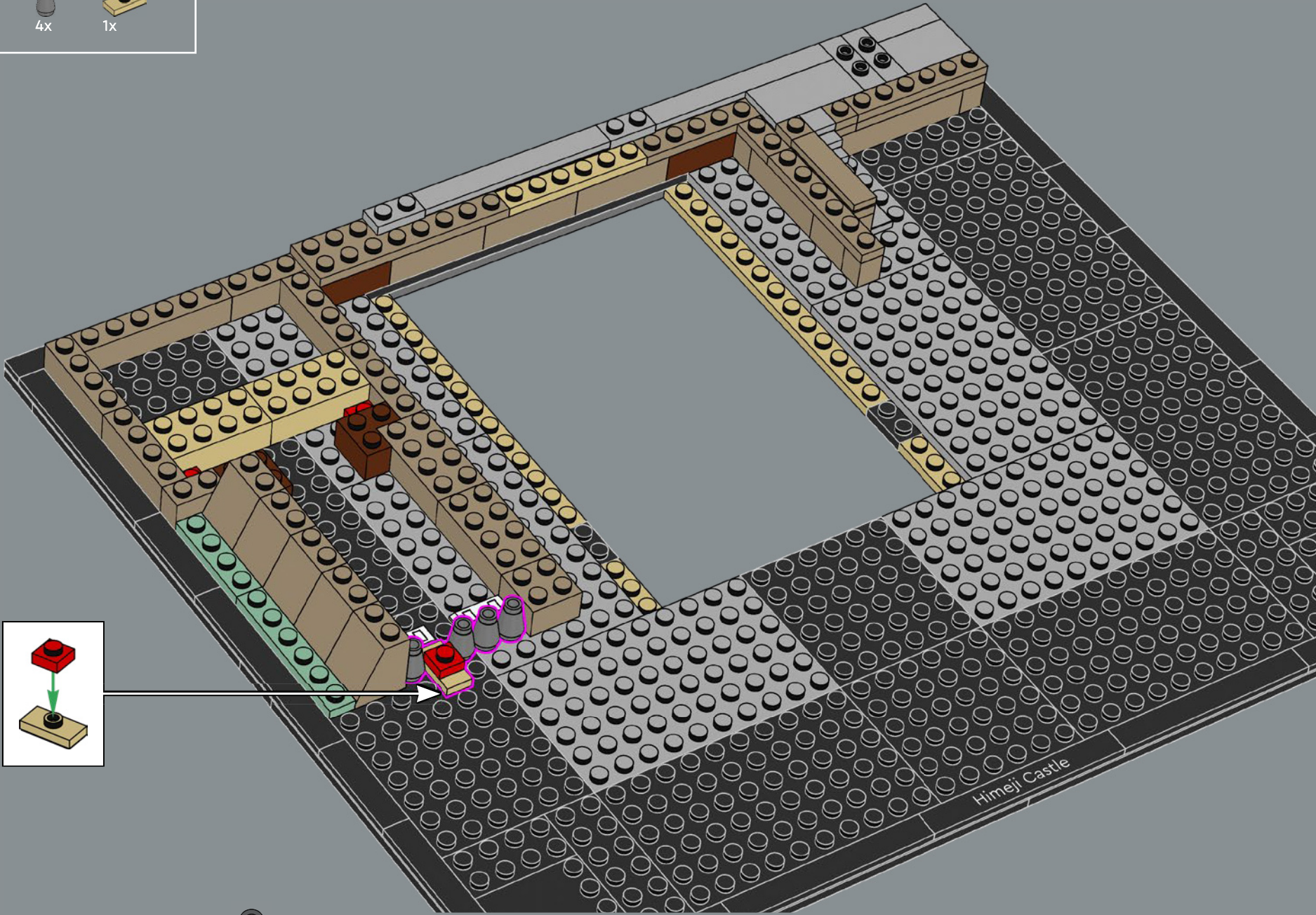

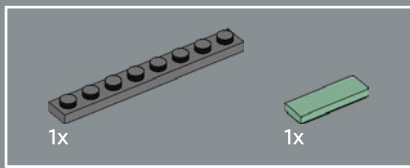

26

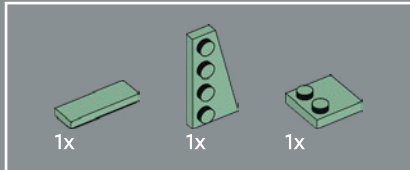
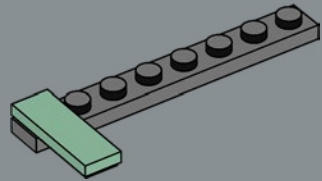

27

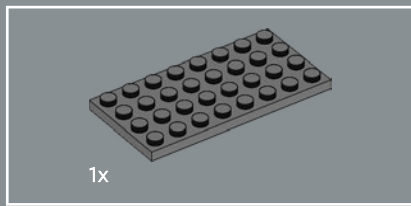
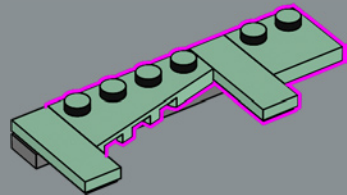

28

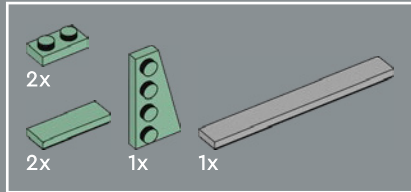
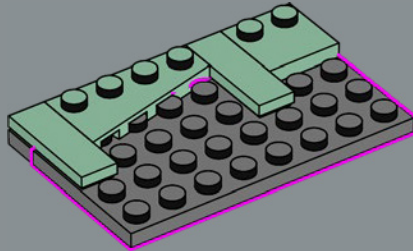

29

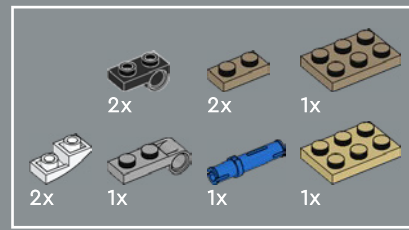
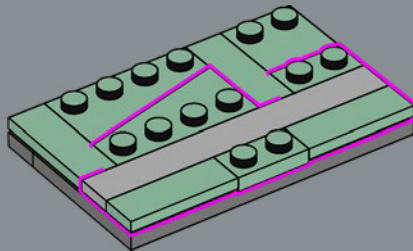

30

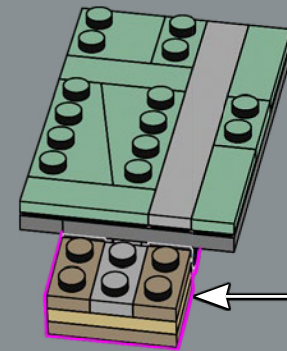
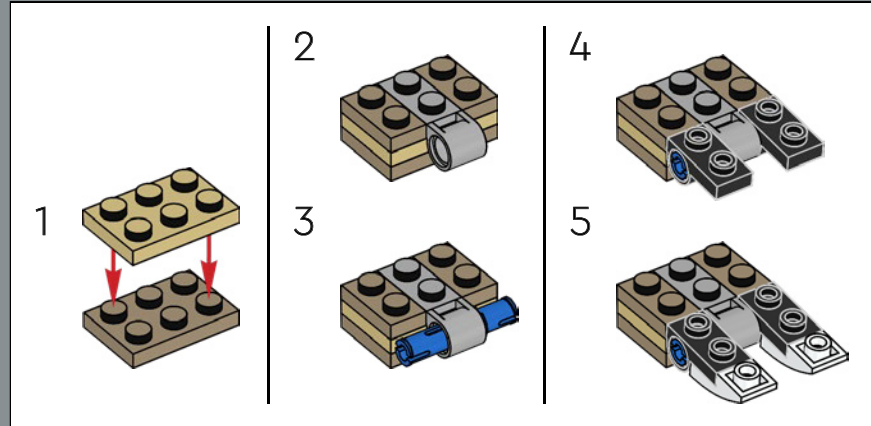

31

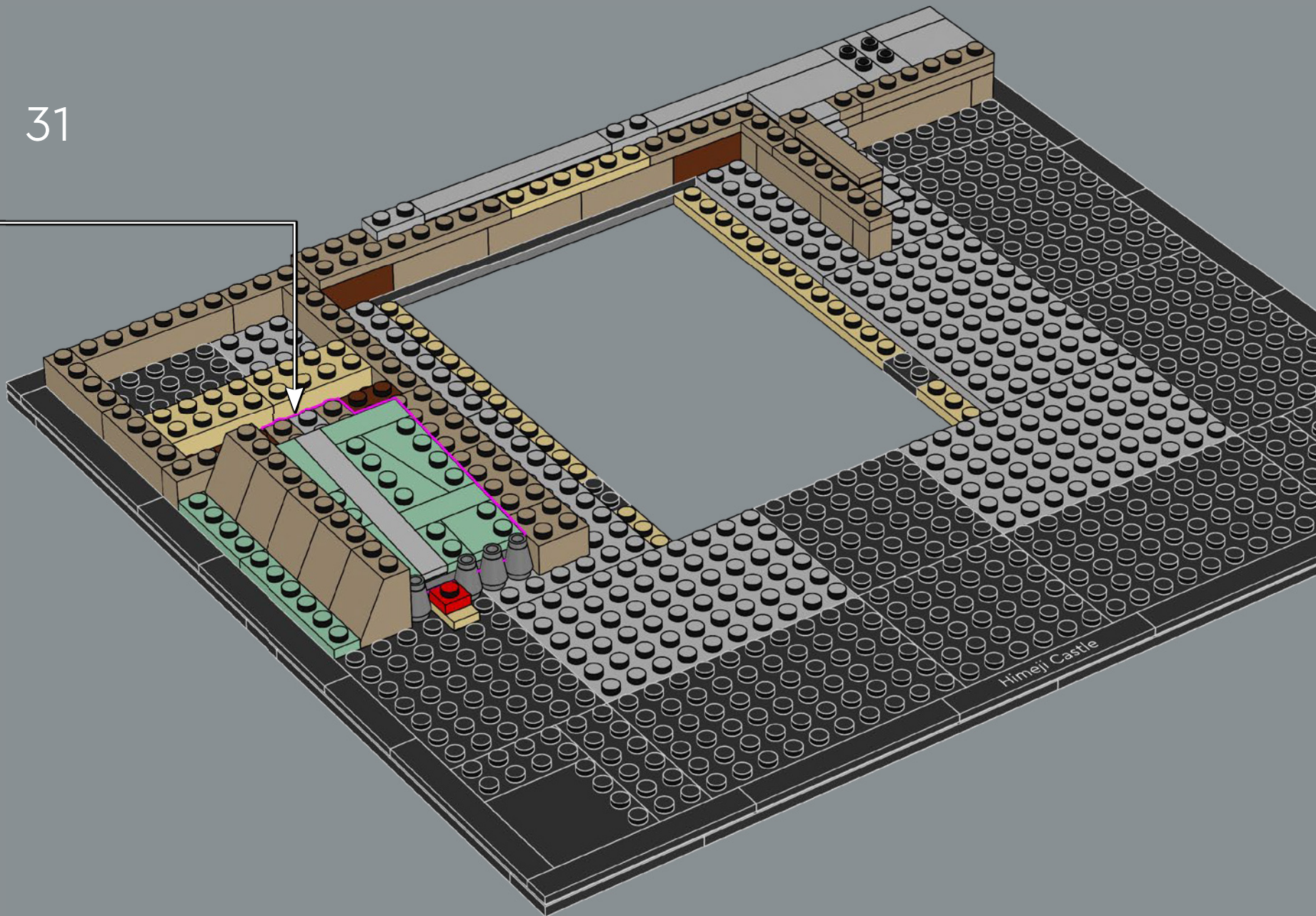

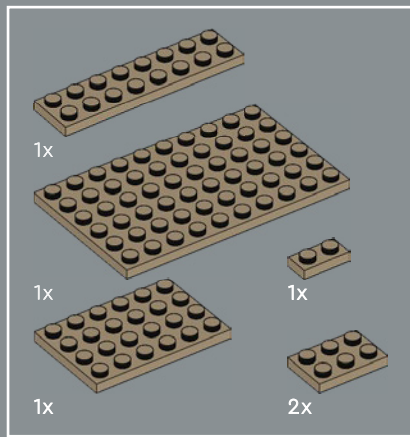

32

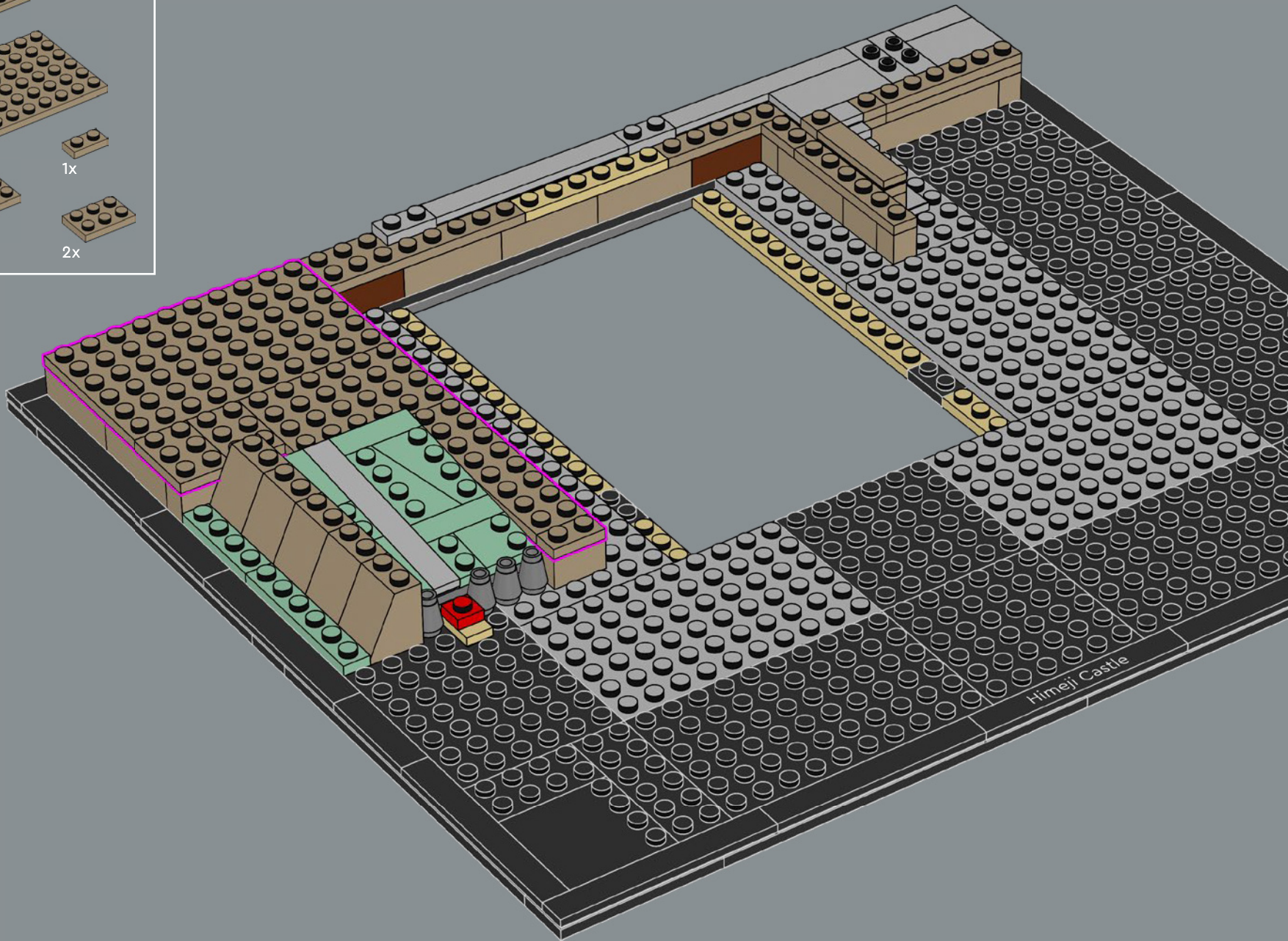

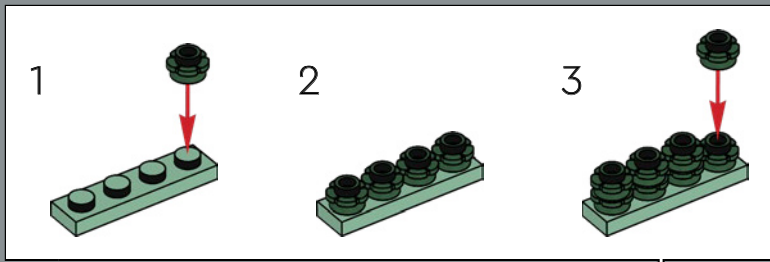
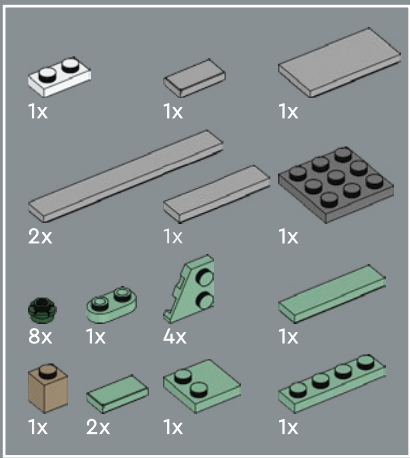

33

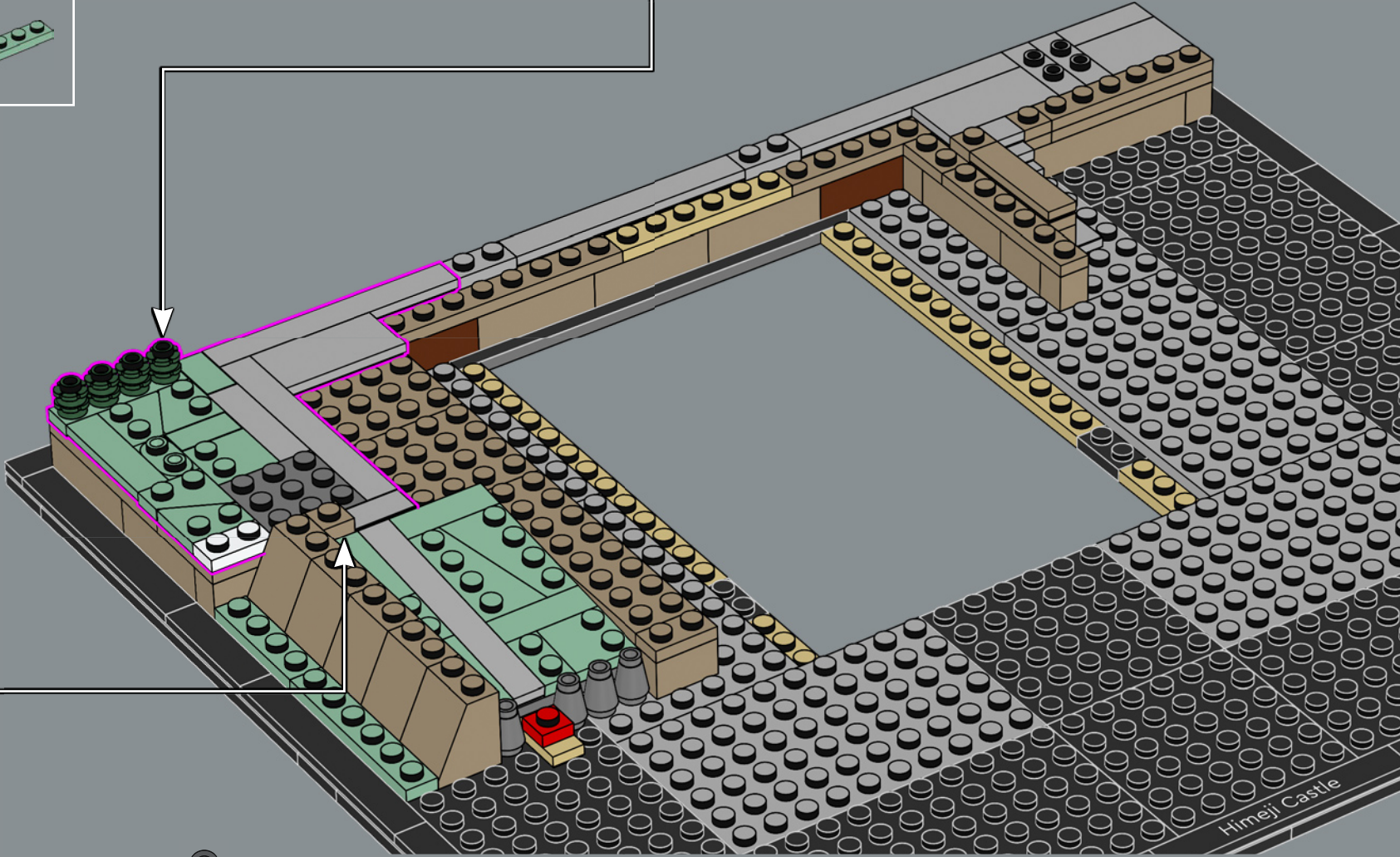

Himeiji Castle

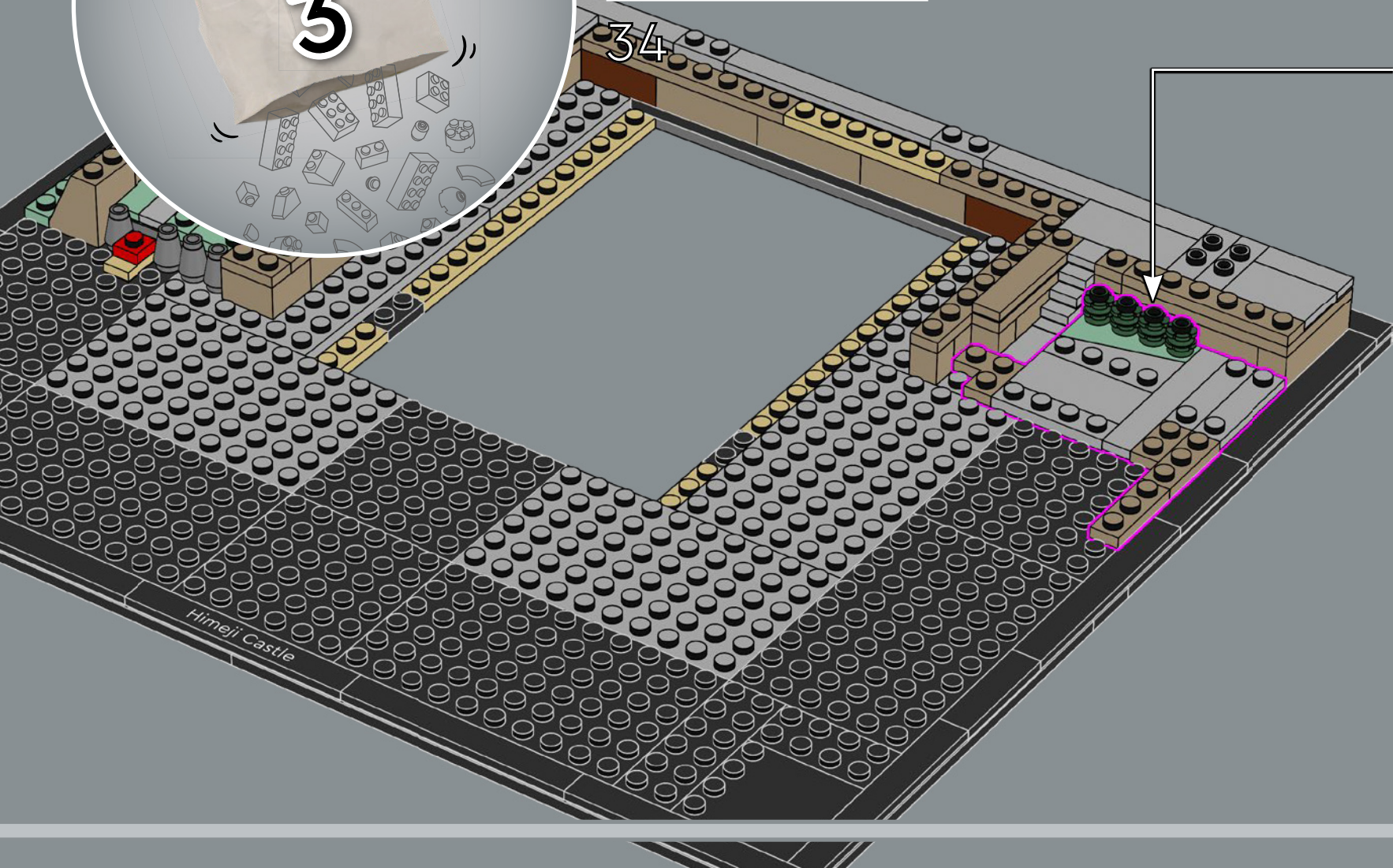
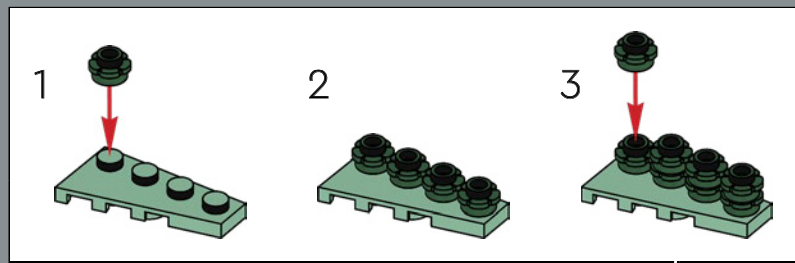
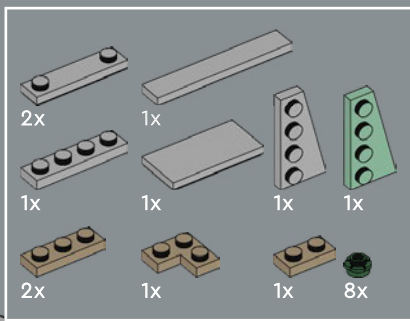

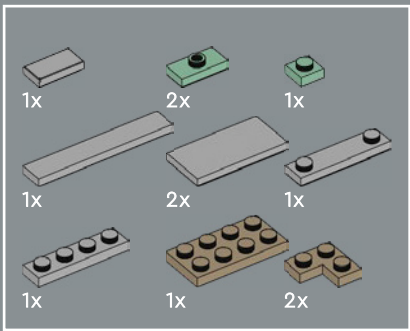

35

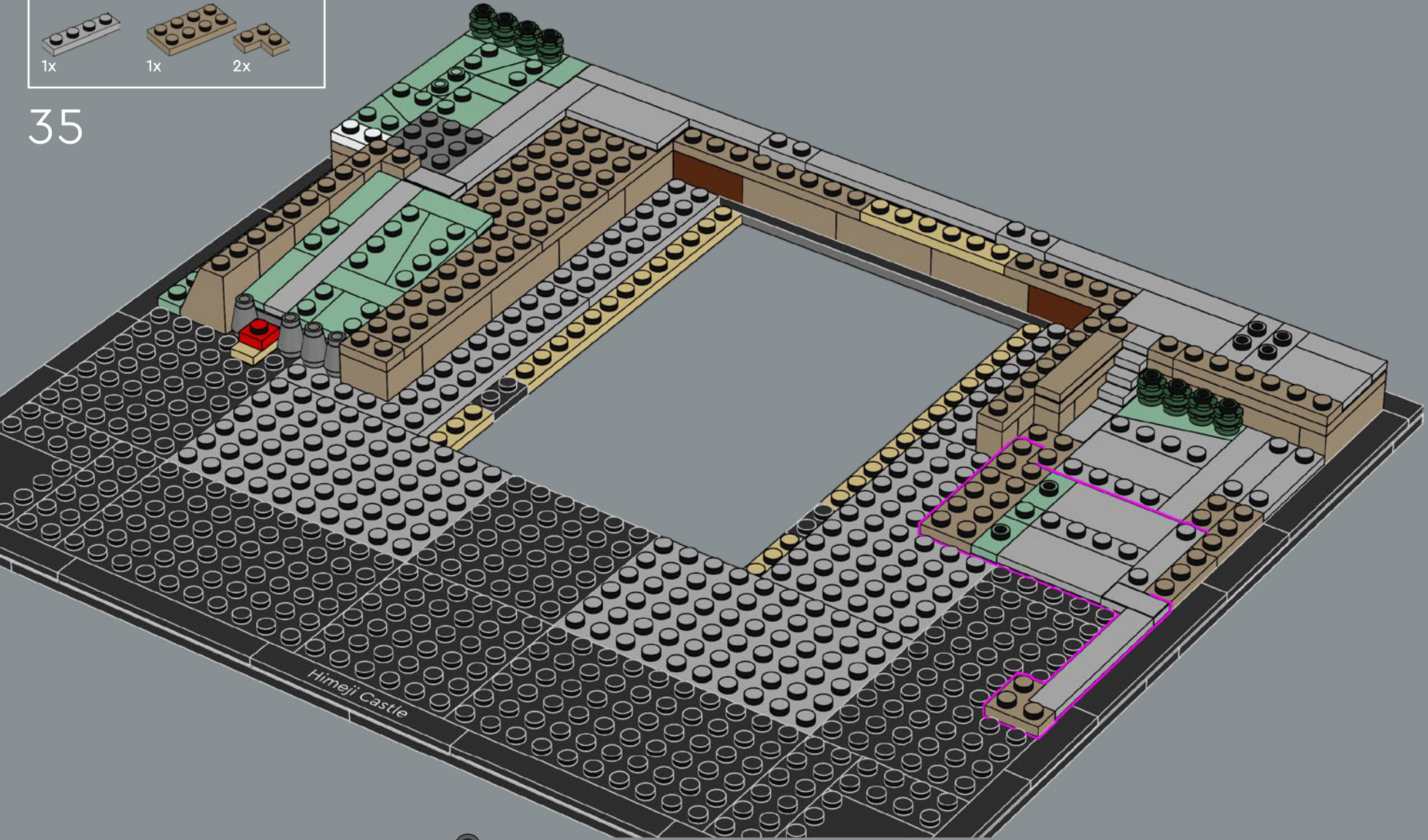

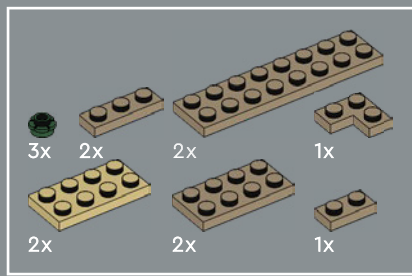

36

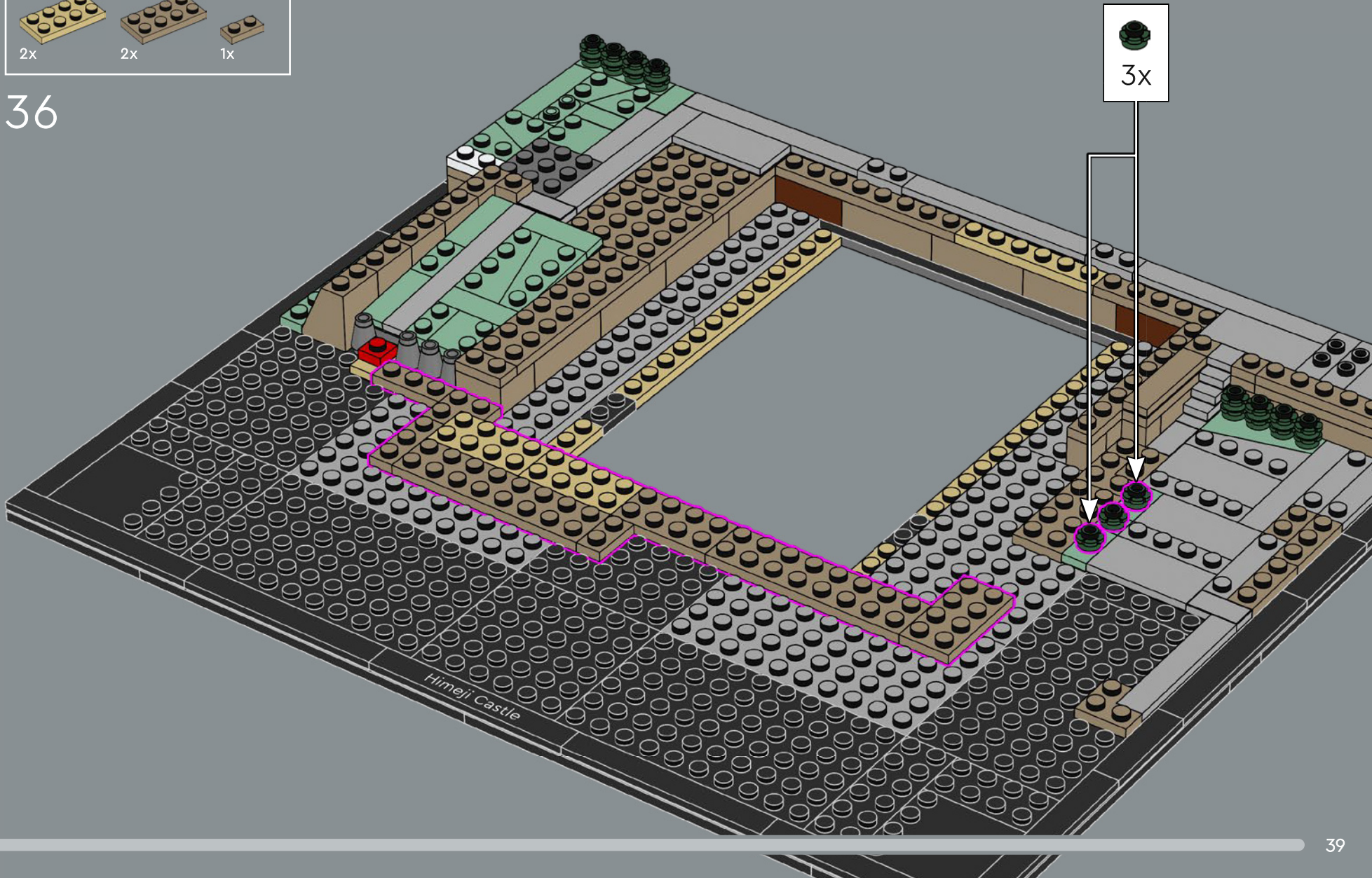

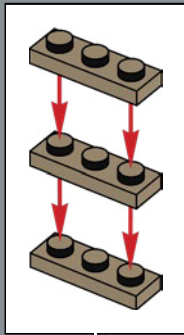
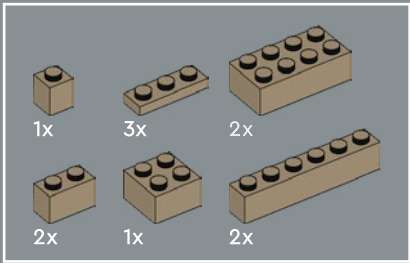

37

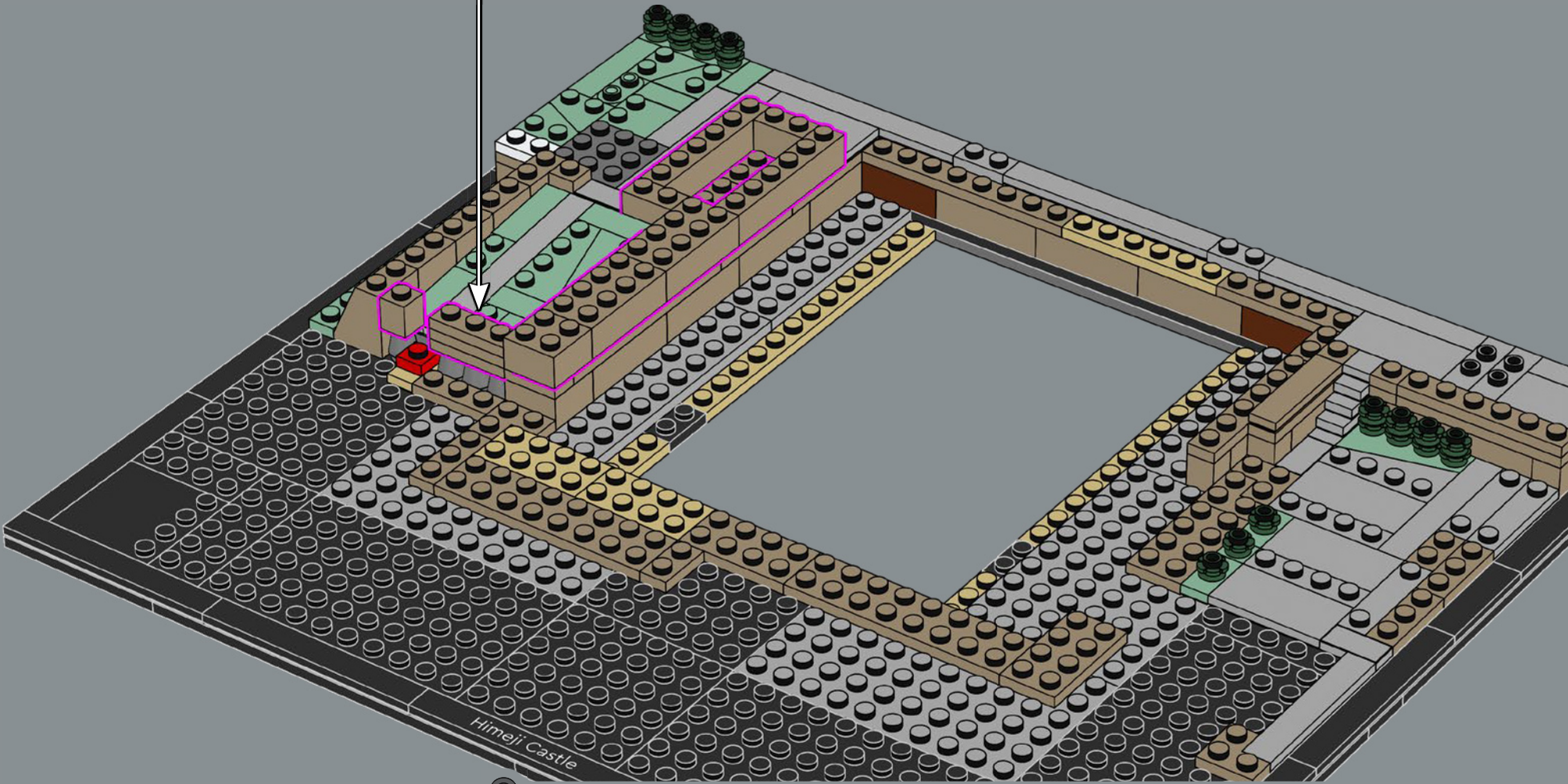

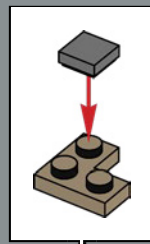
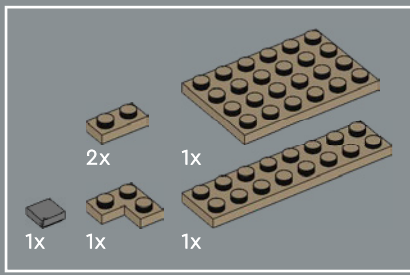

38

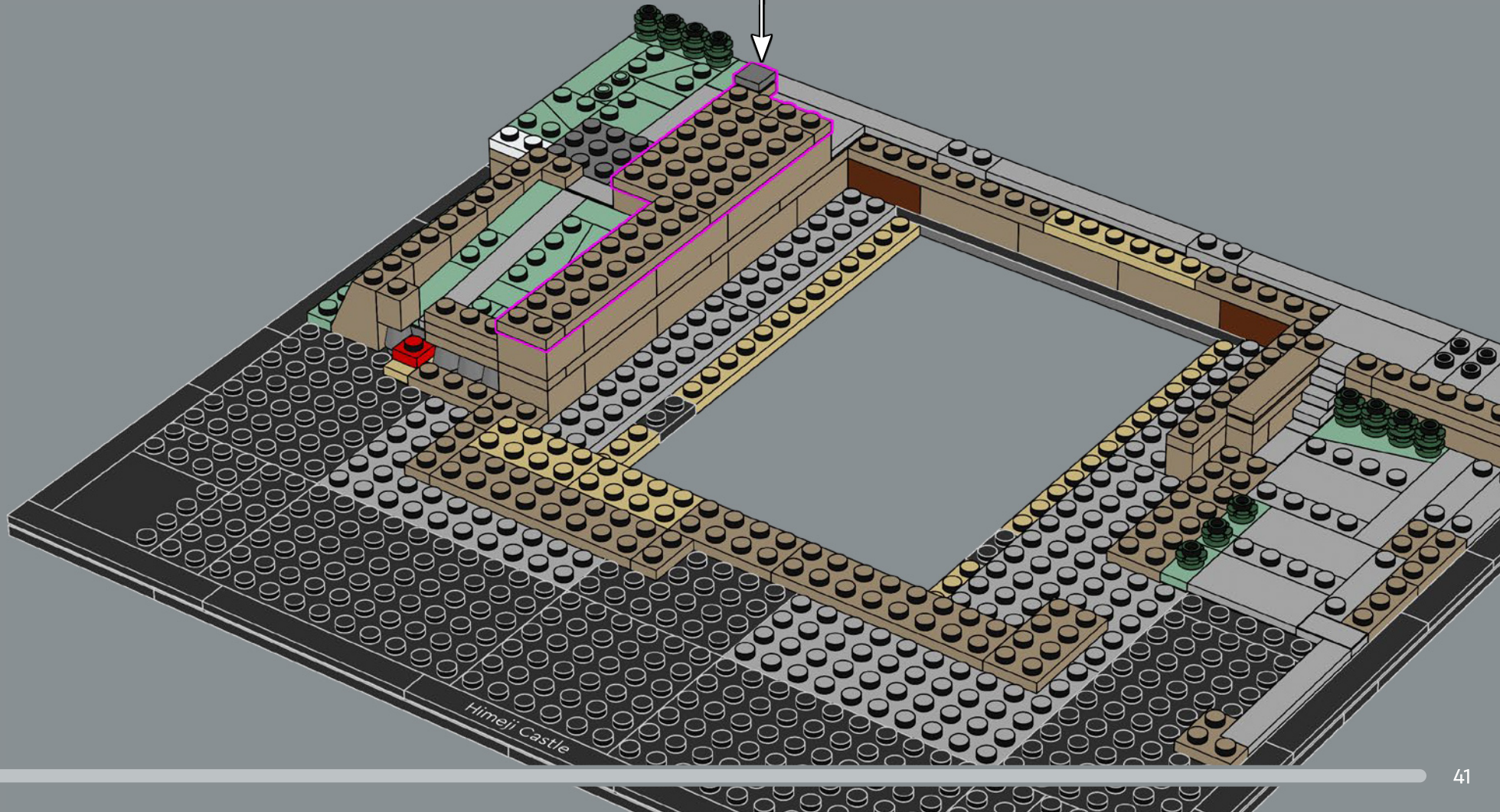

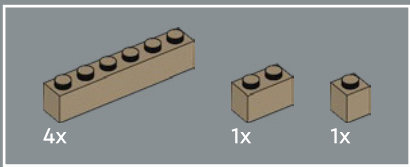

39

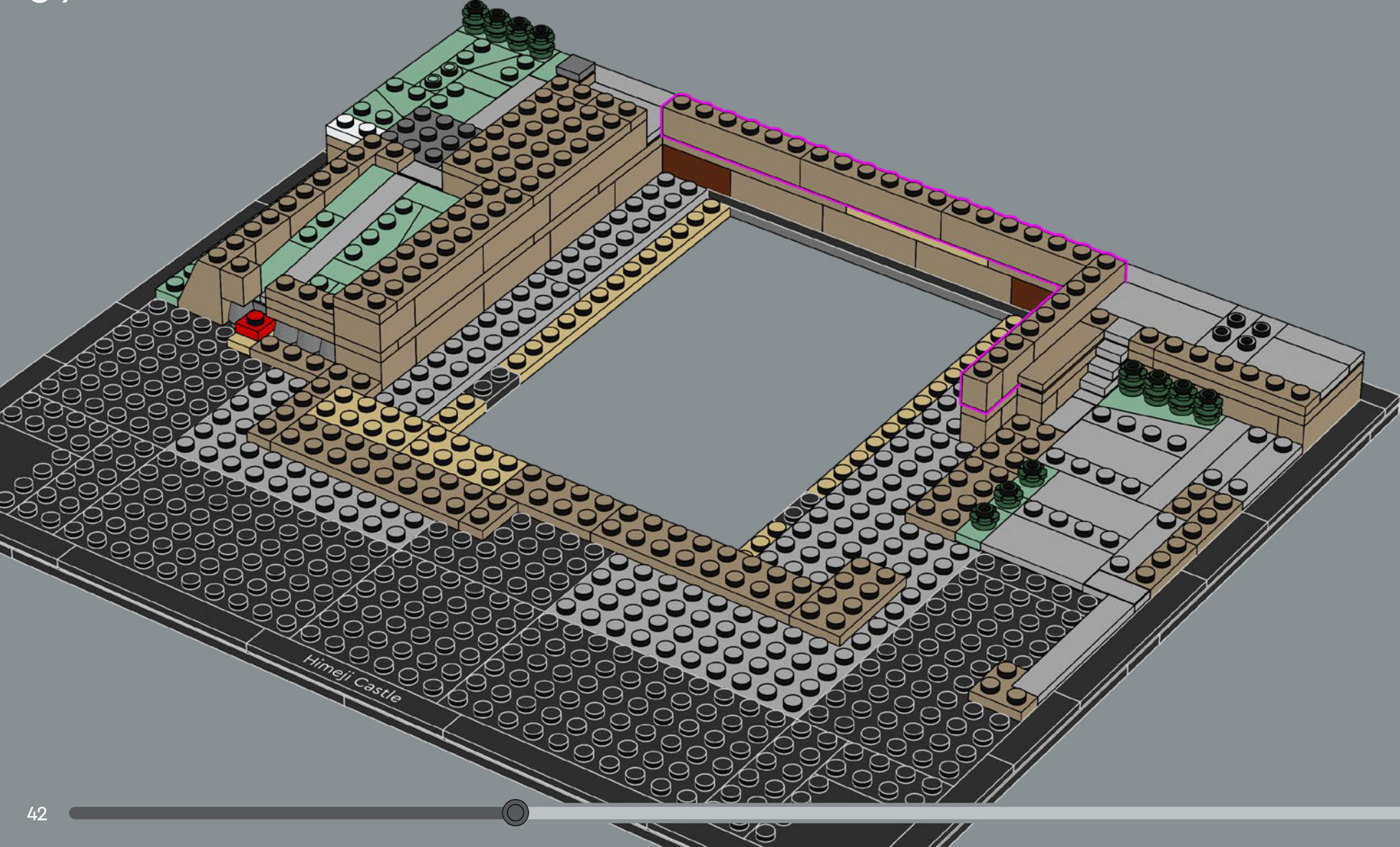

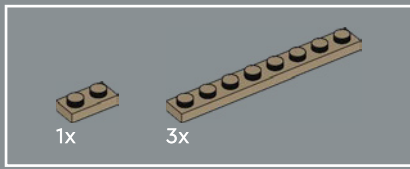

40

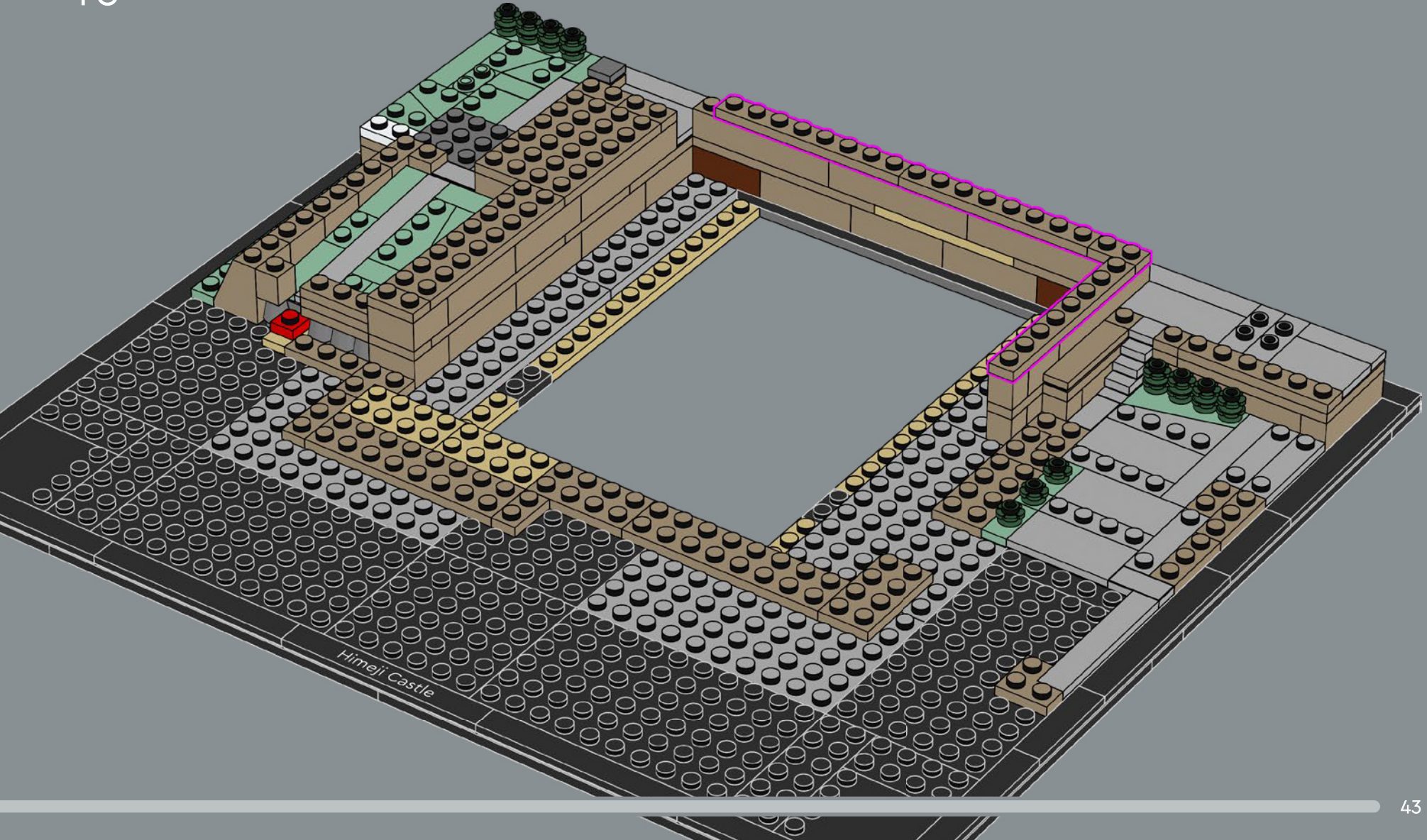

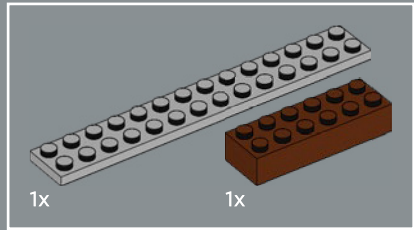
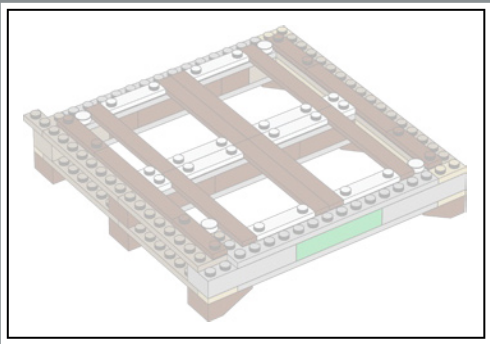

41

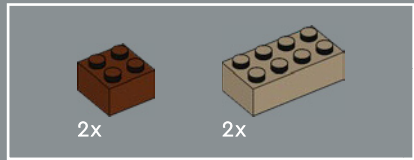
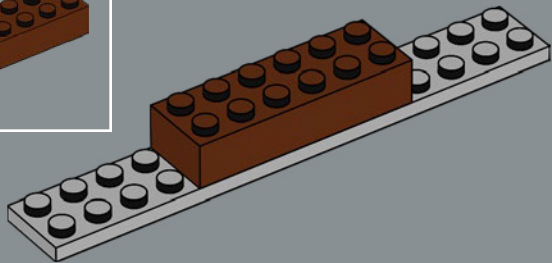

42

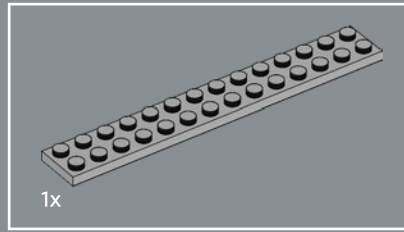
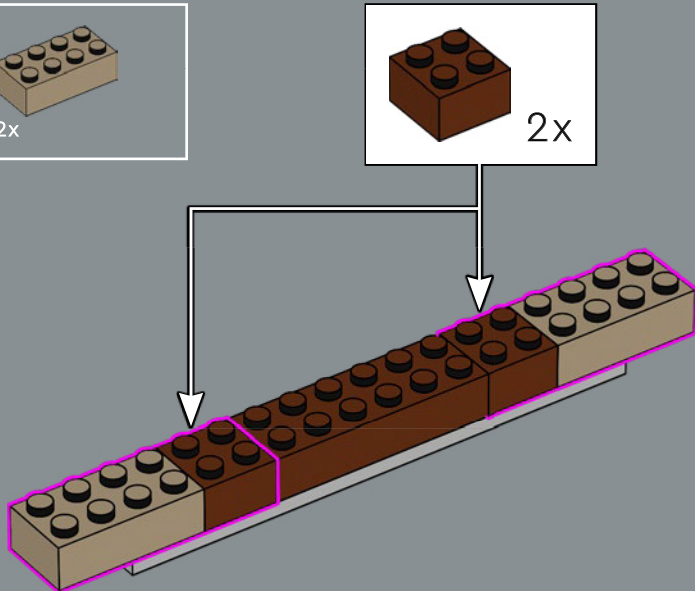

43

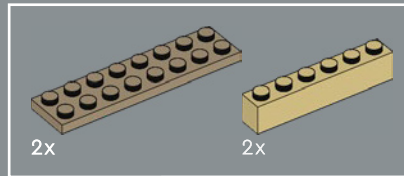
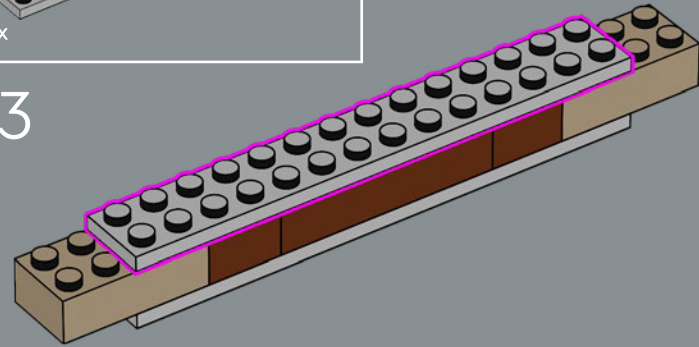

44

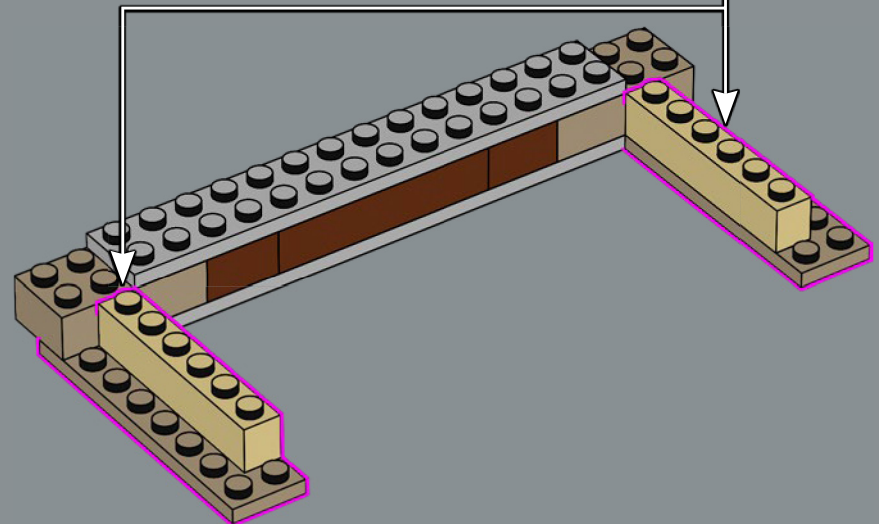
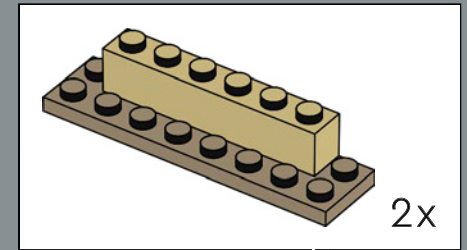

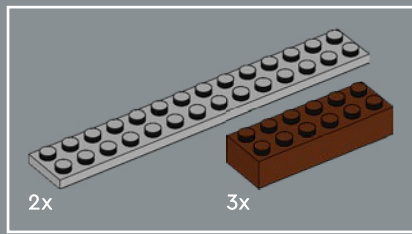

45

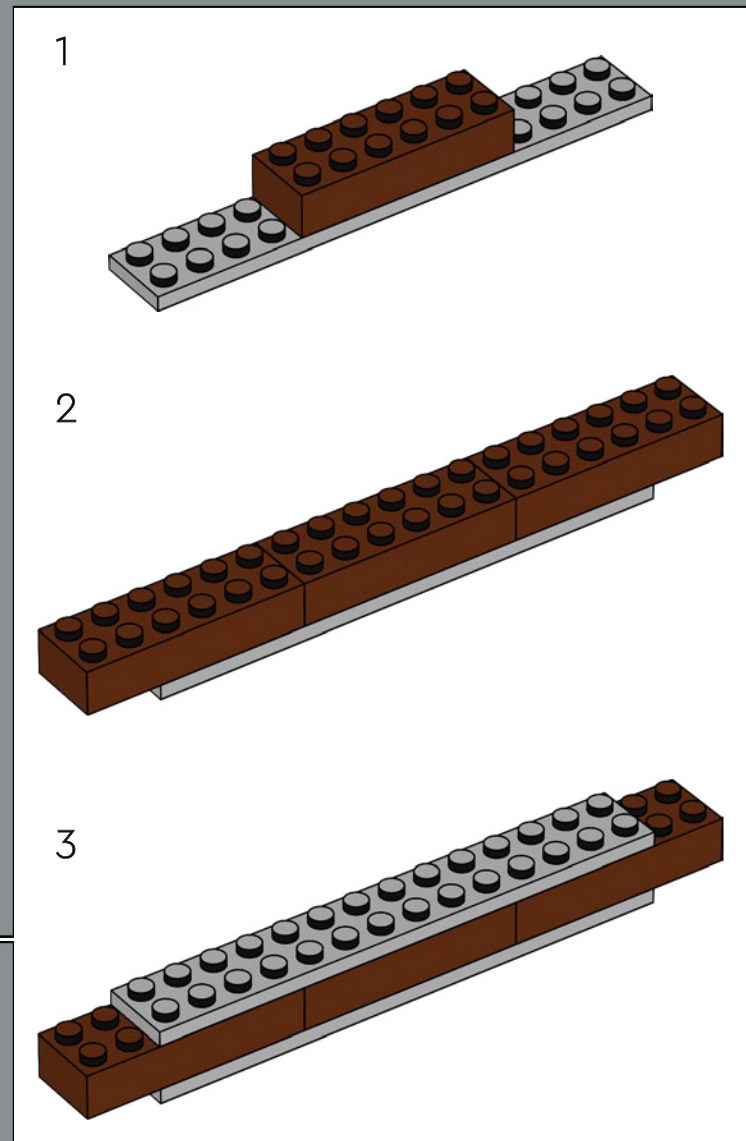
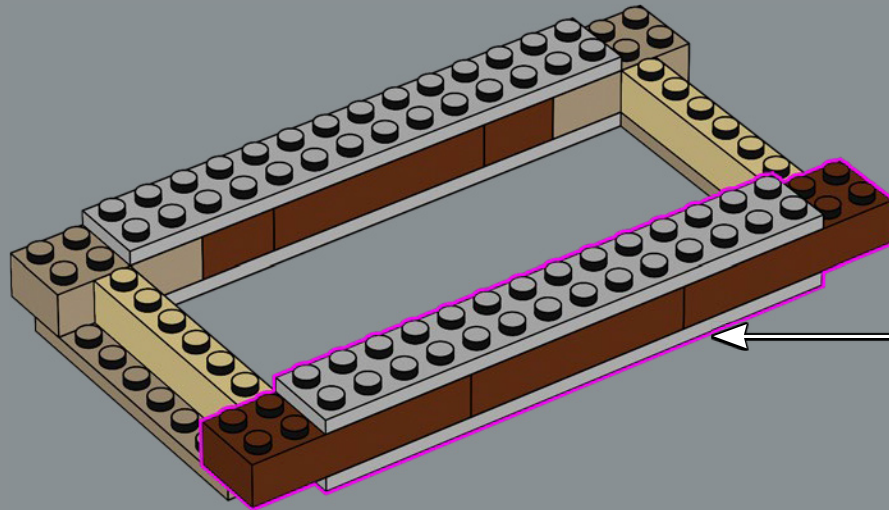

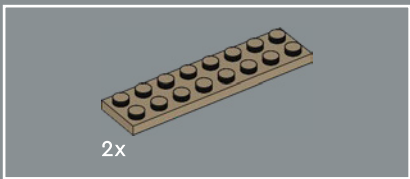

46

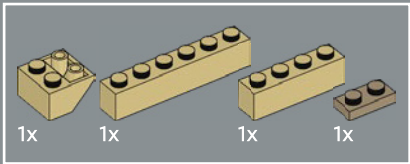
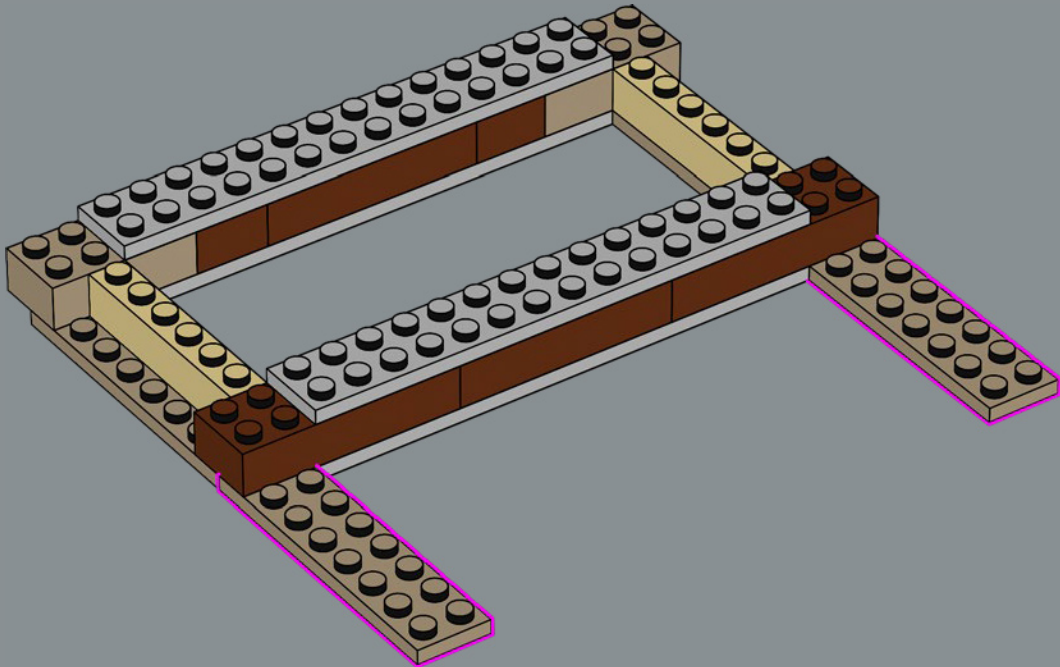

47

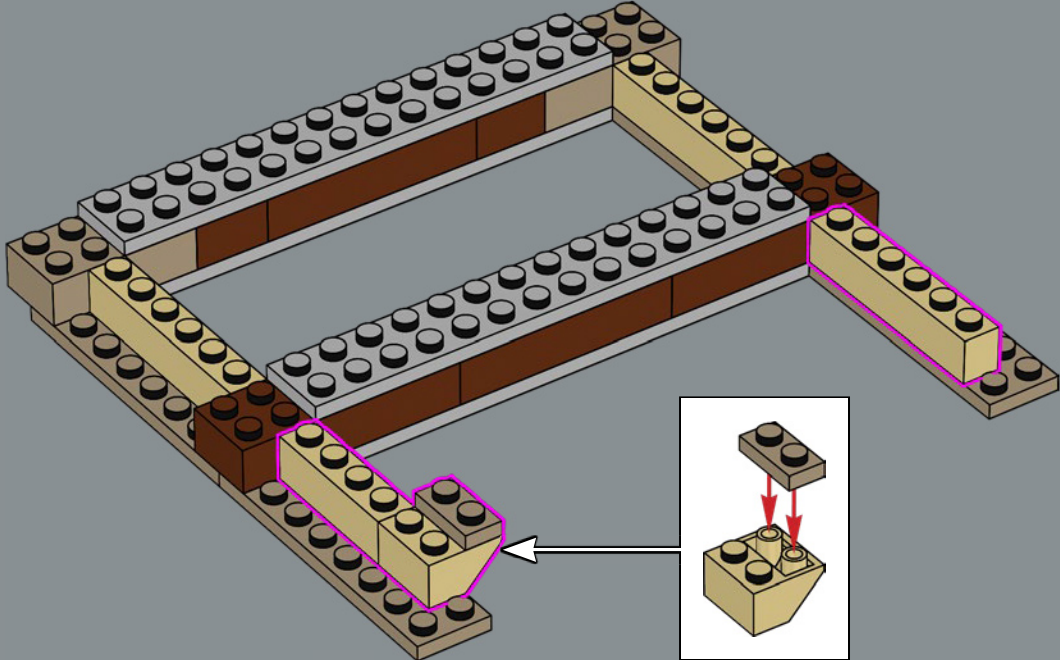

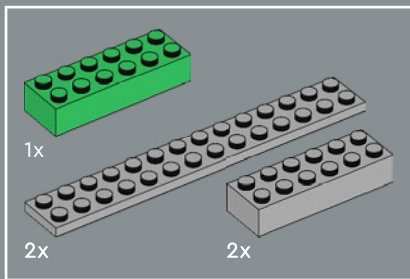

48

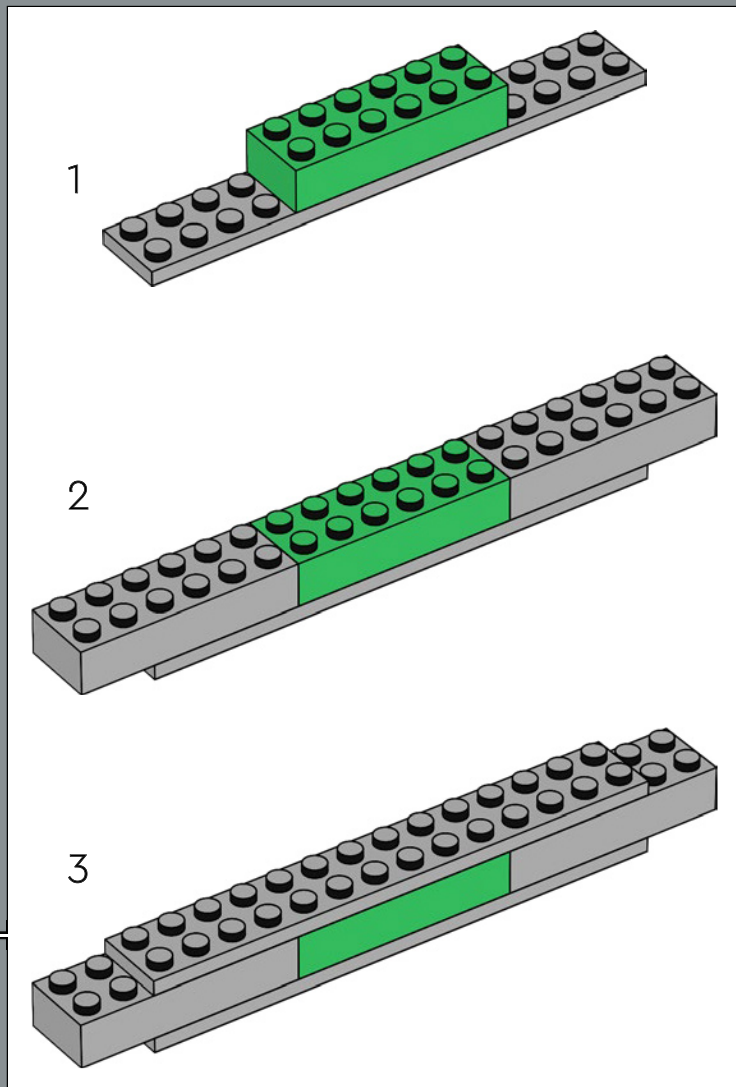
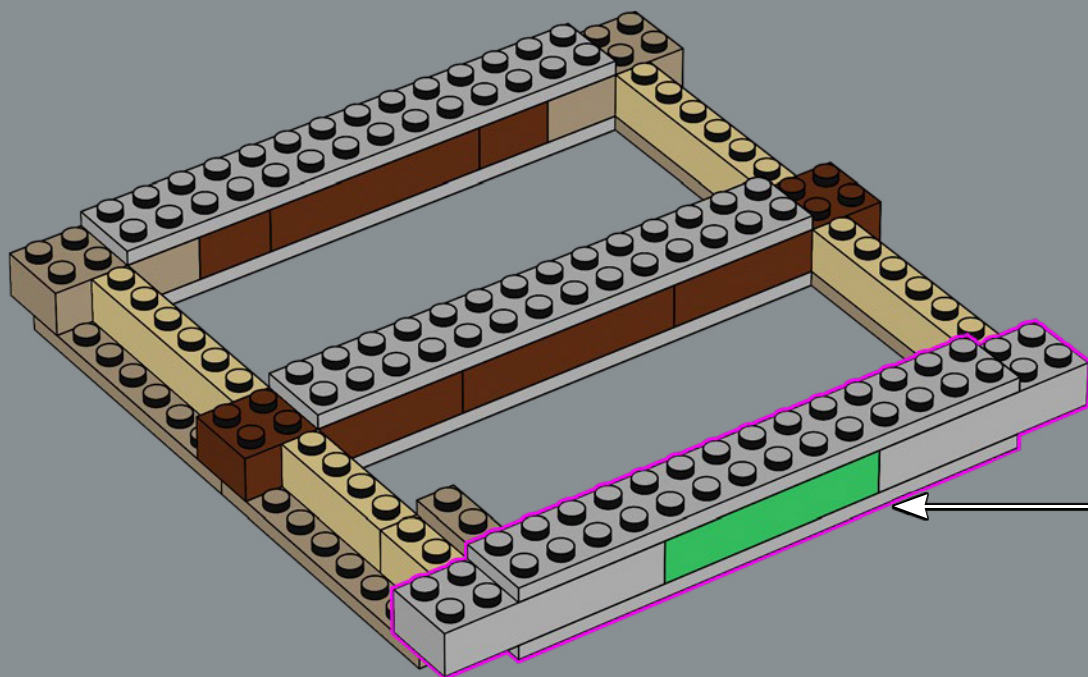

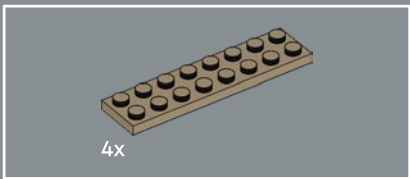

49

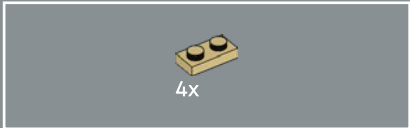
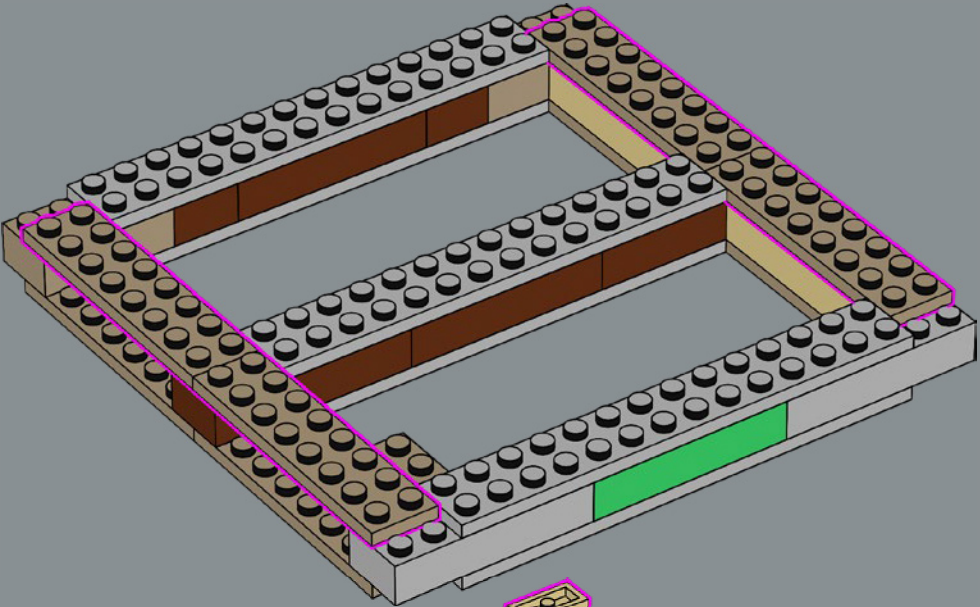

50

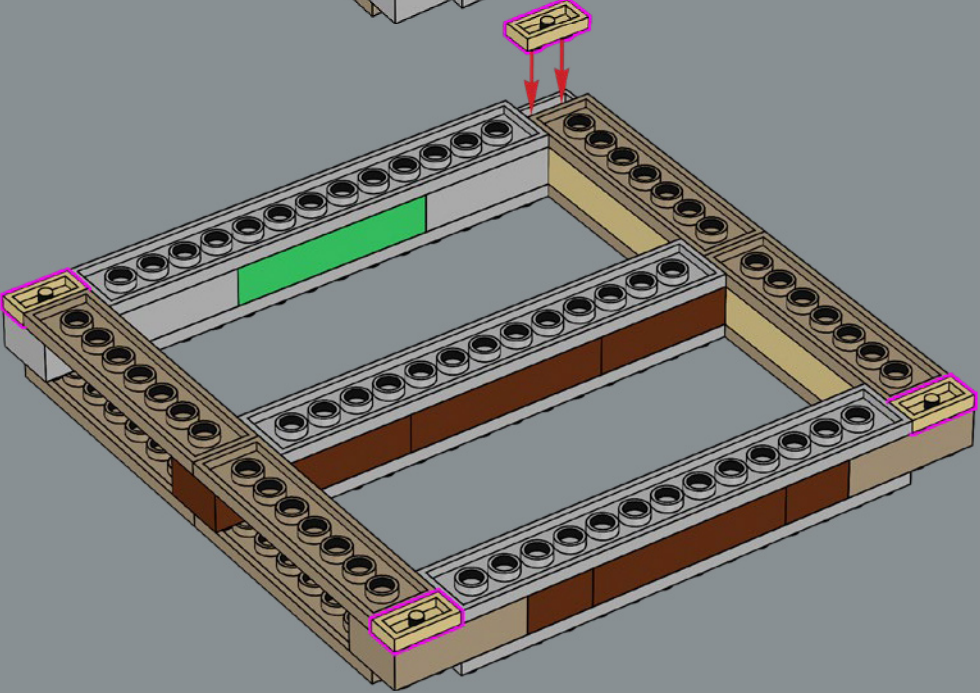



51

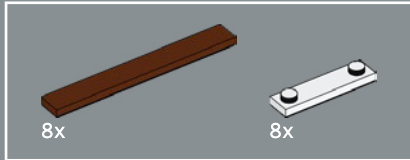
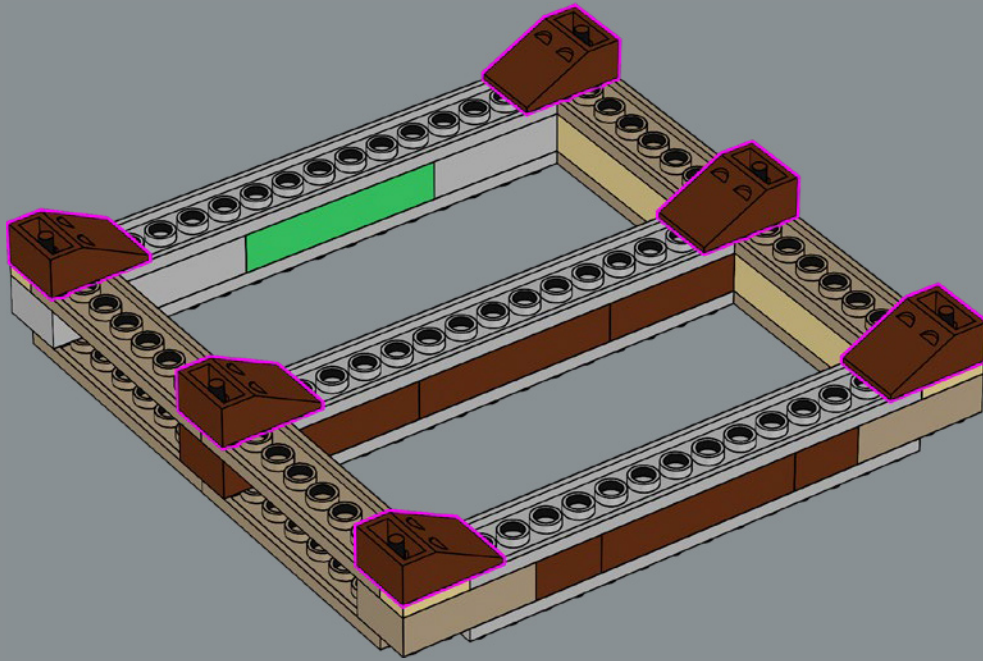

52

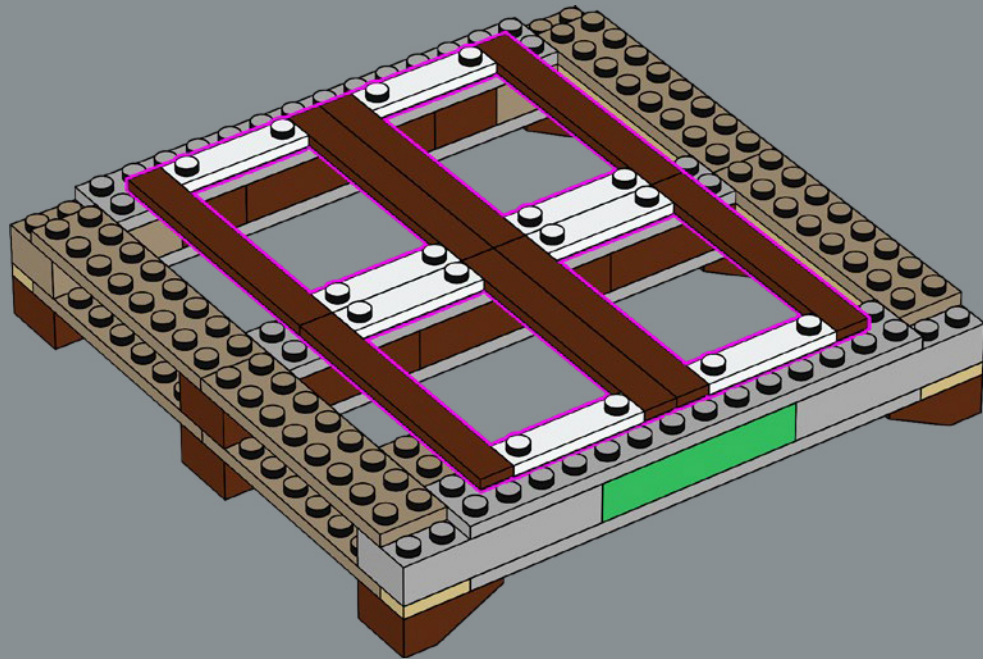

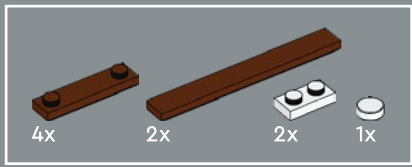

53

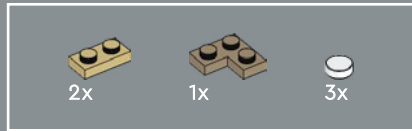
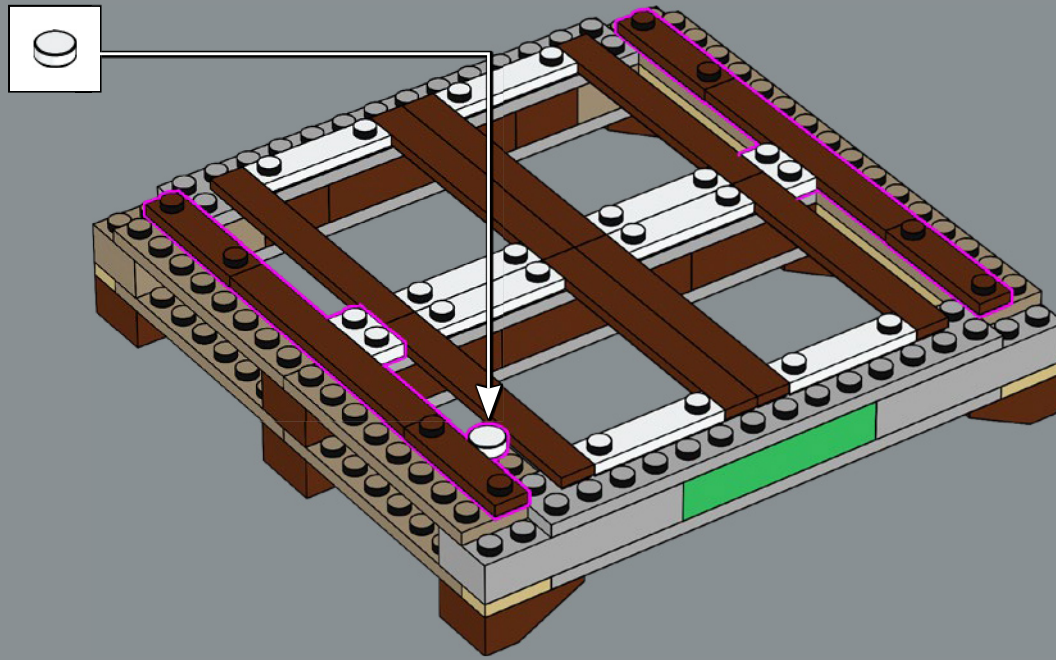

54

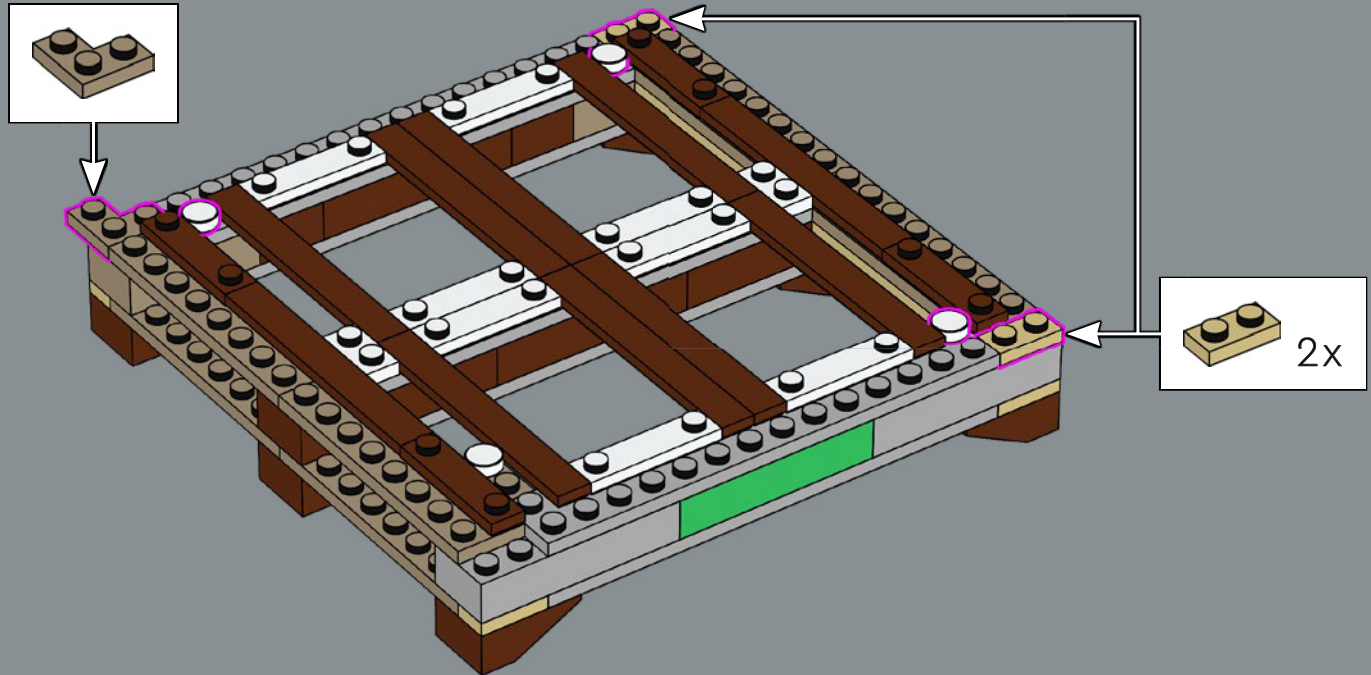

55

The castle in the model is supported by a brick-built tray, which was designed to evoke the brown and white decor seen throughout the castle interior.

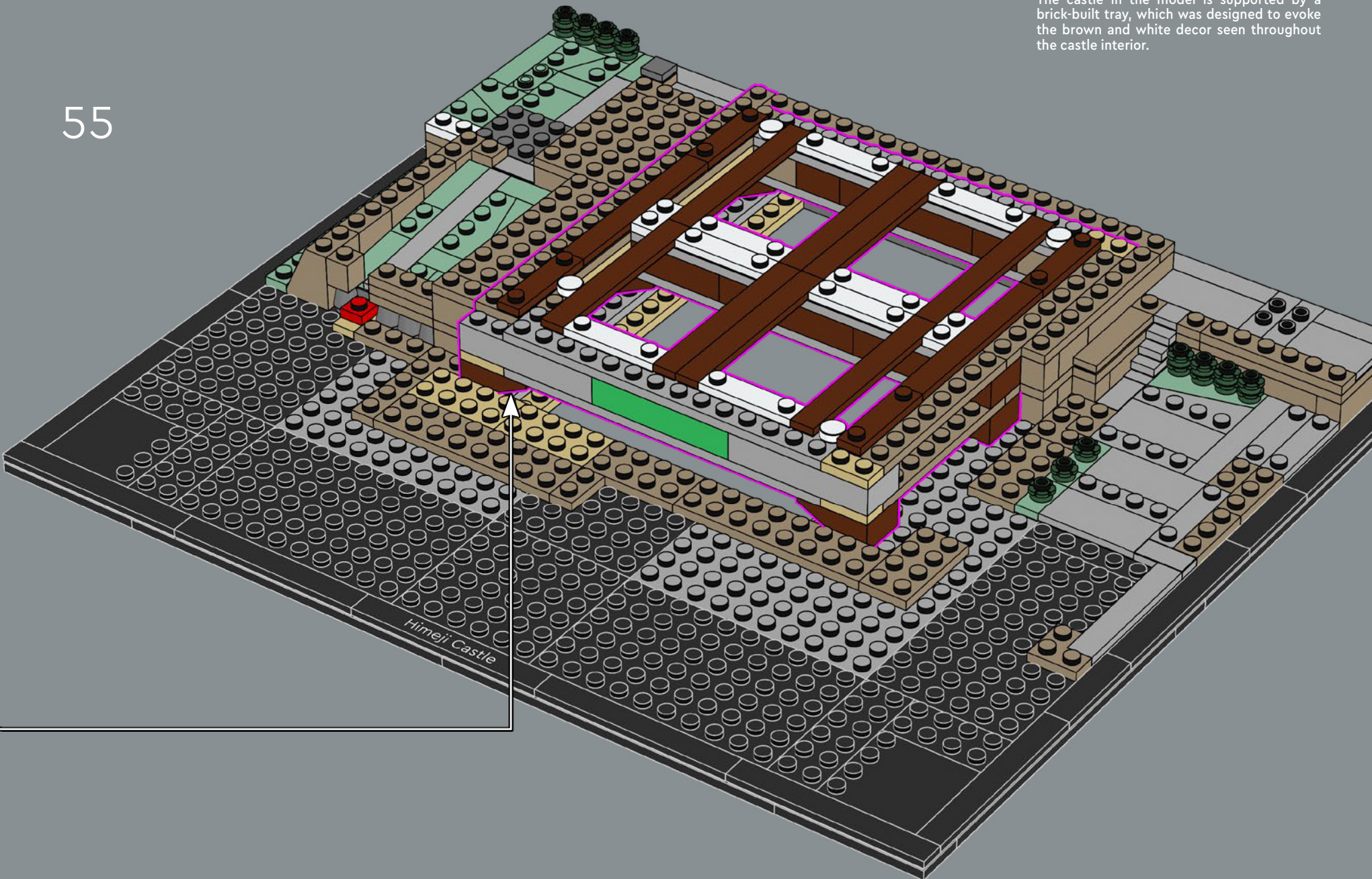

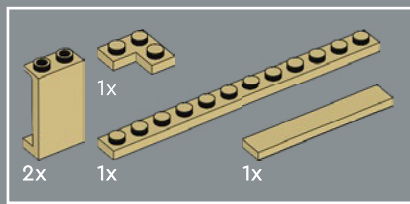

56

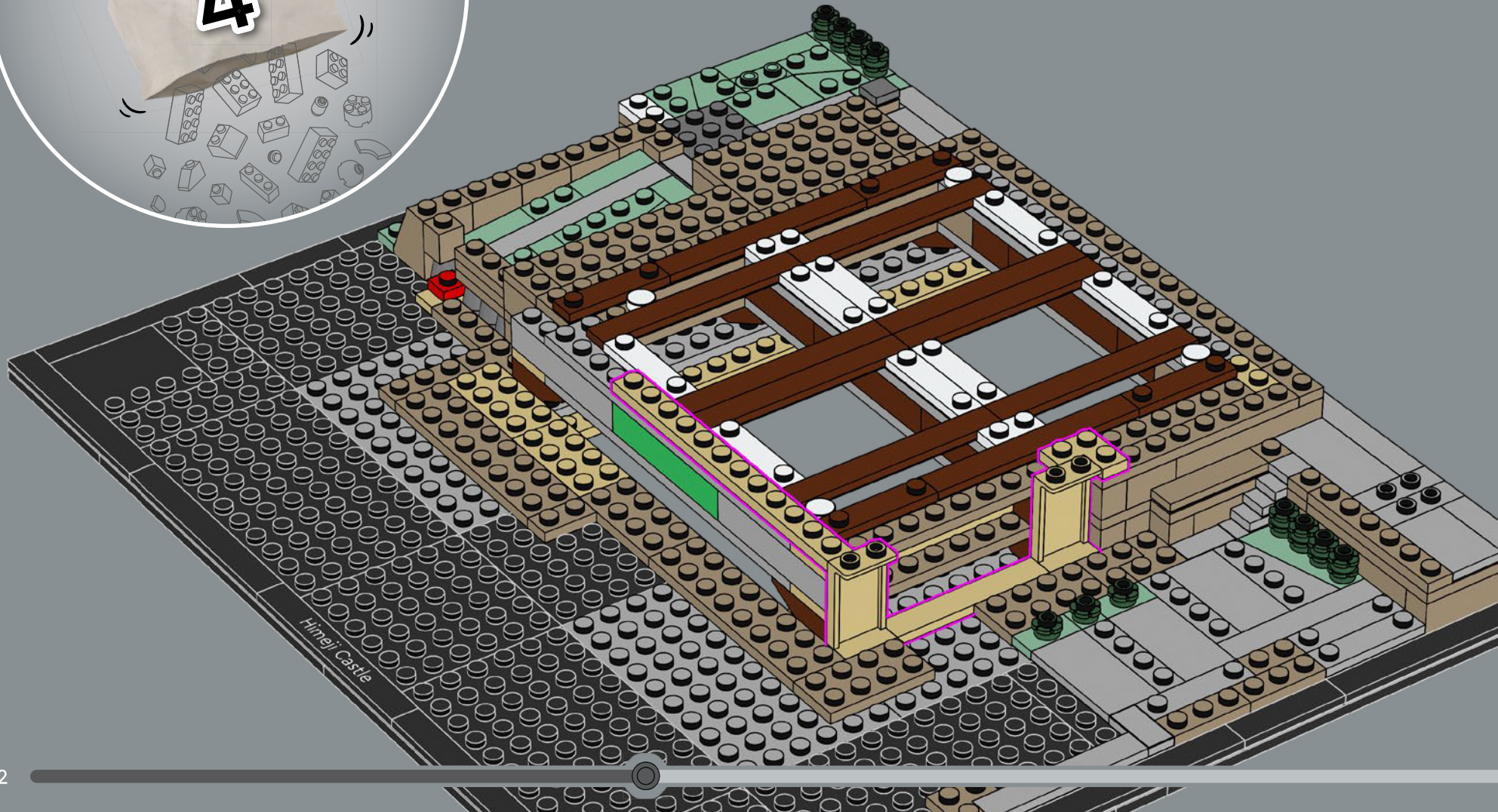

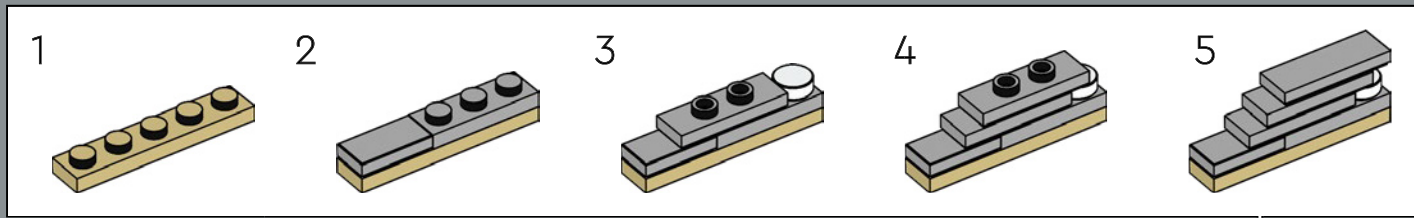
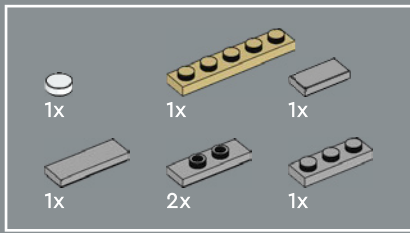

57

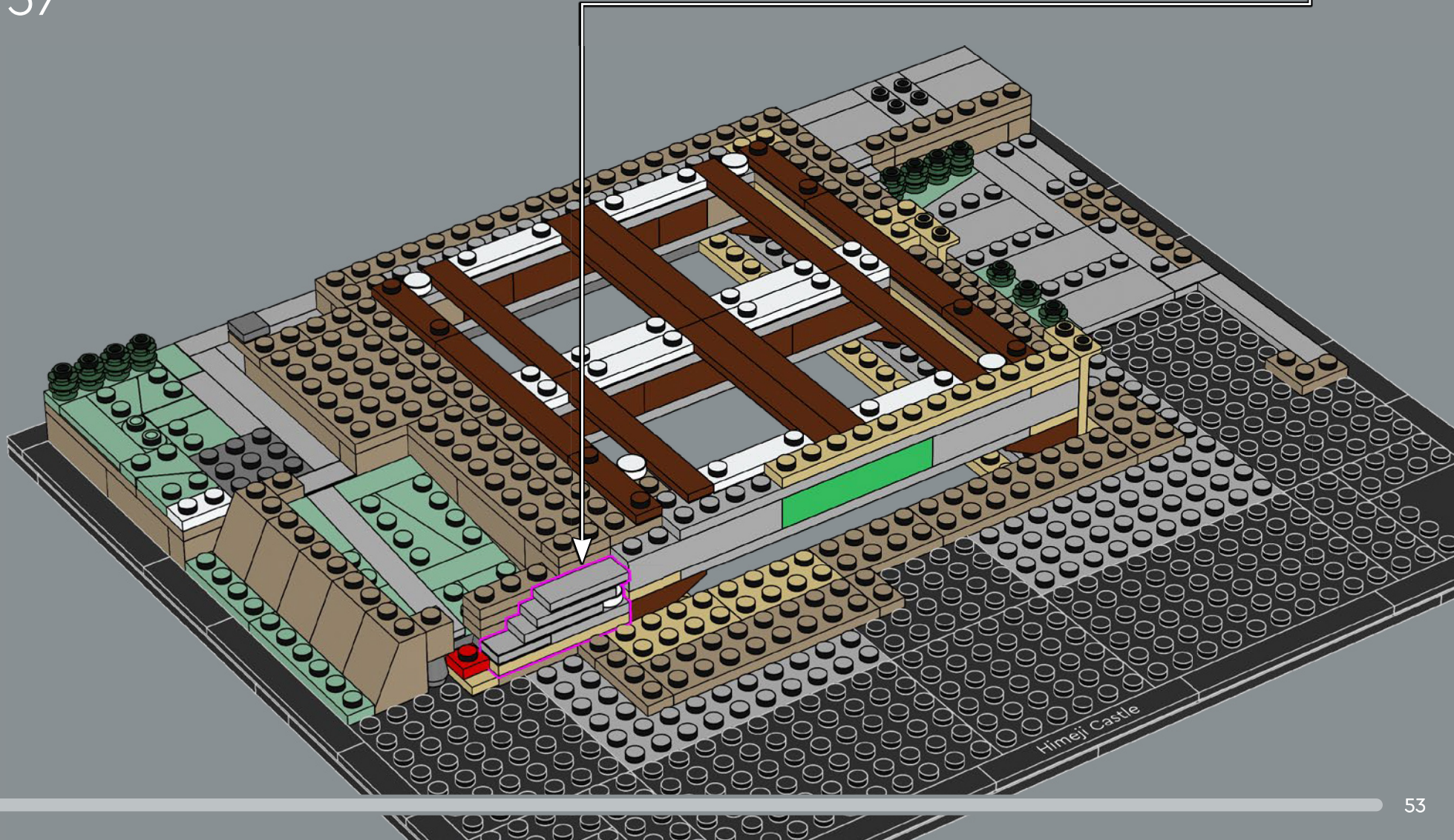

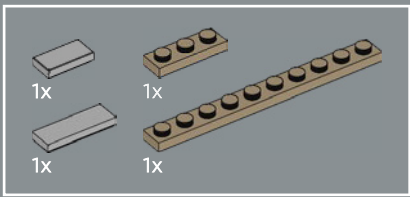

58

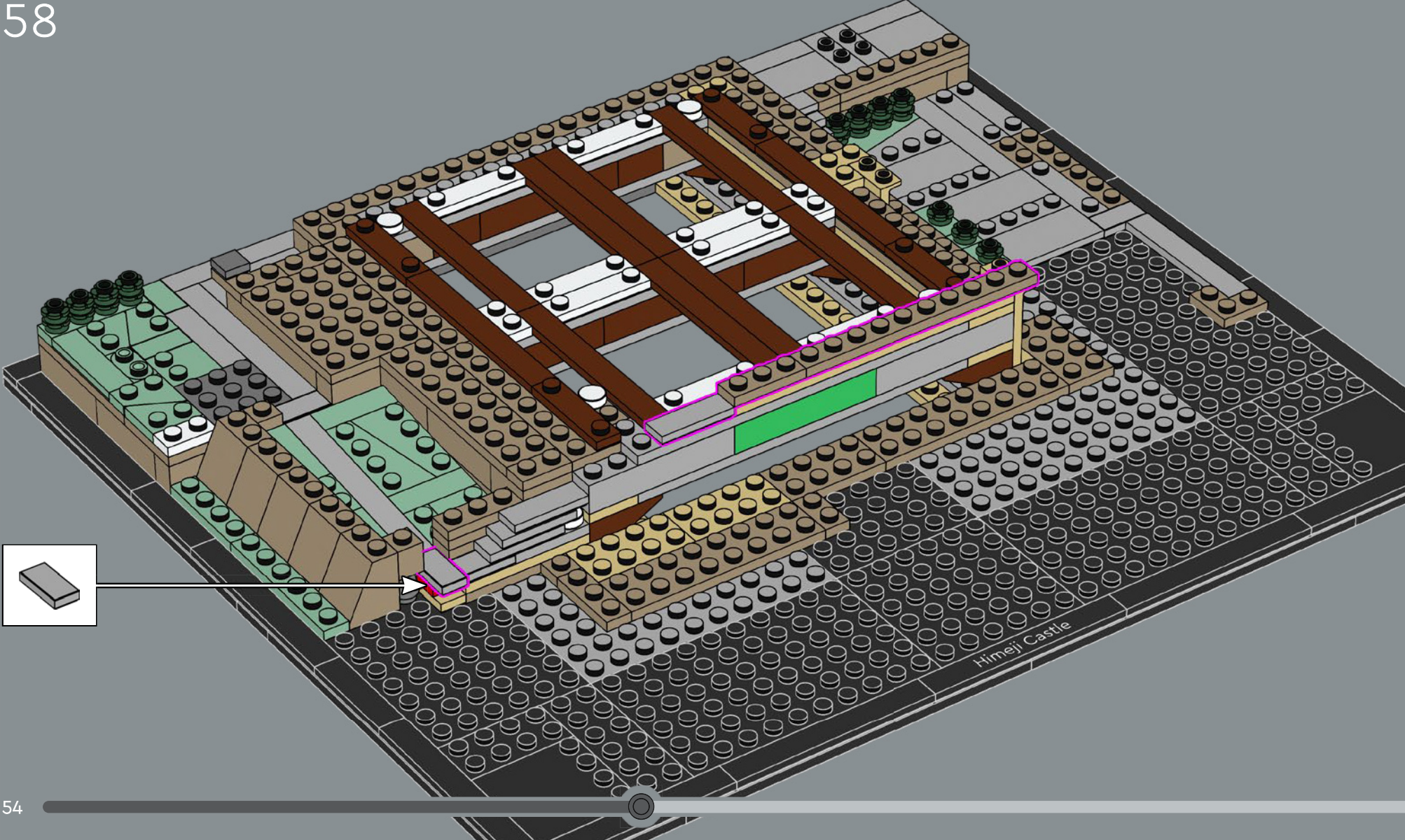

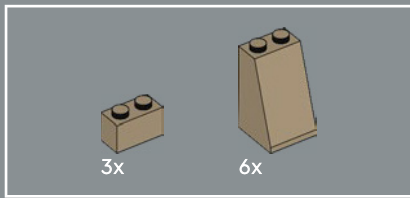

59

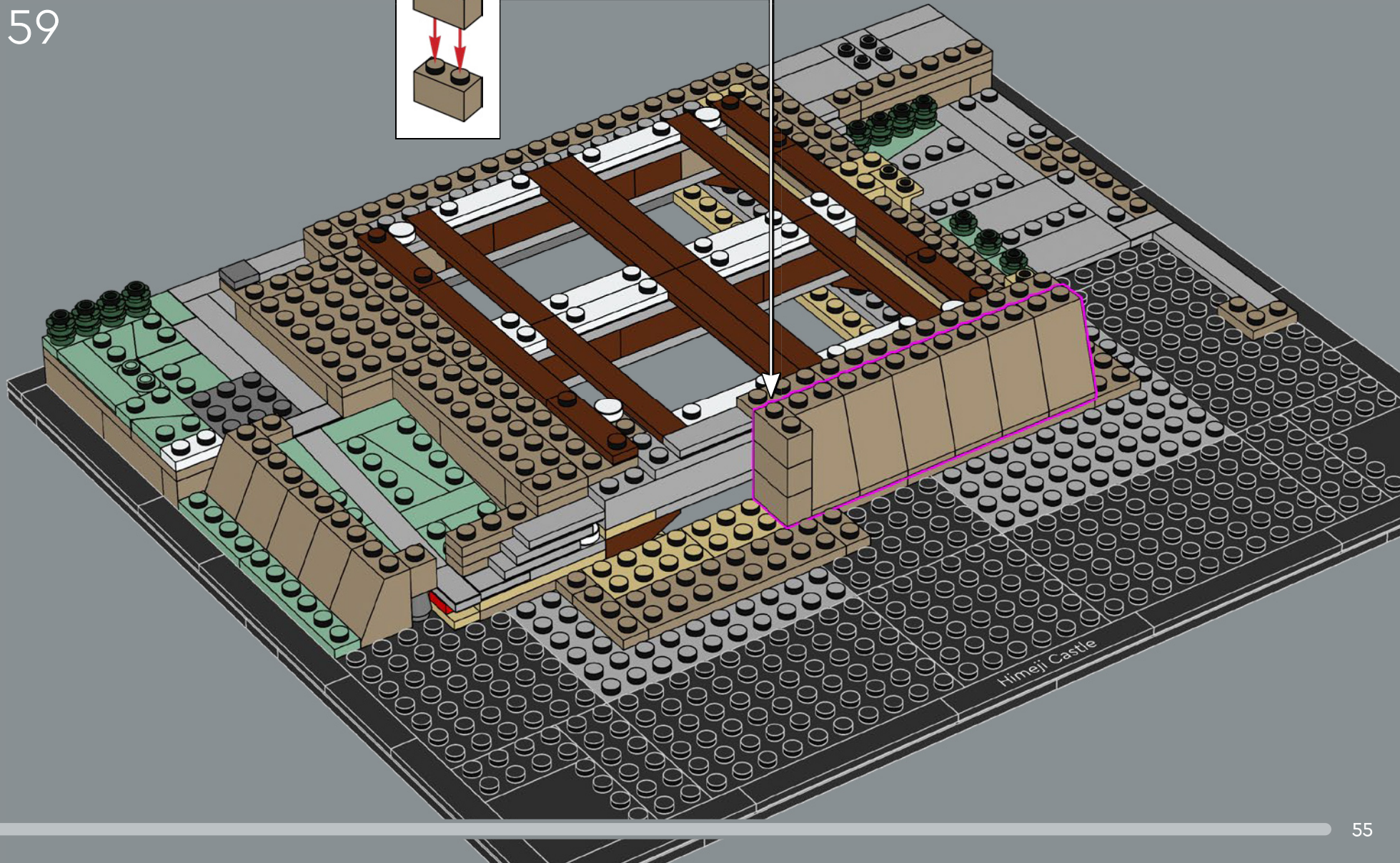
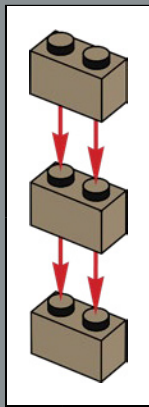

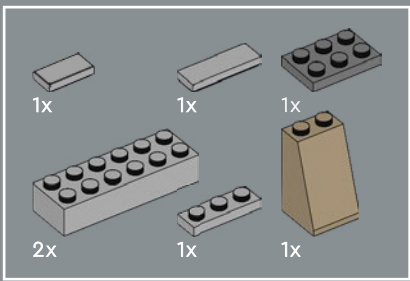

60

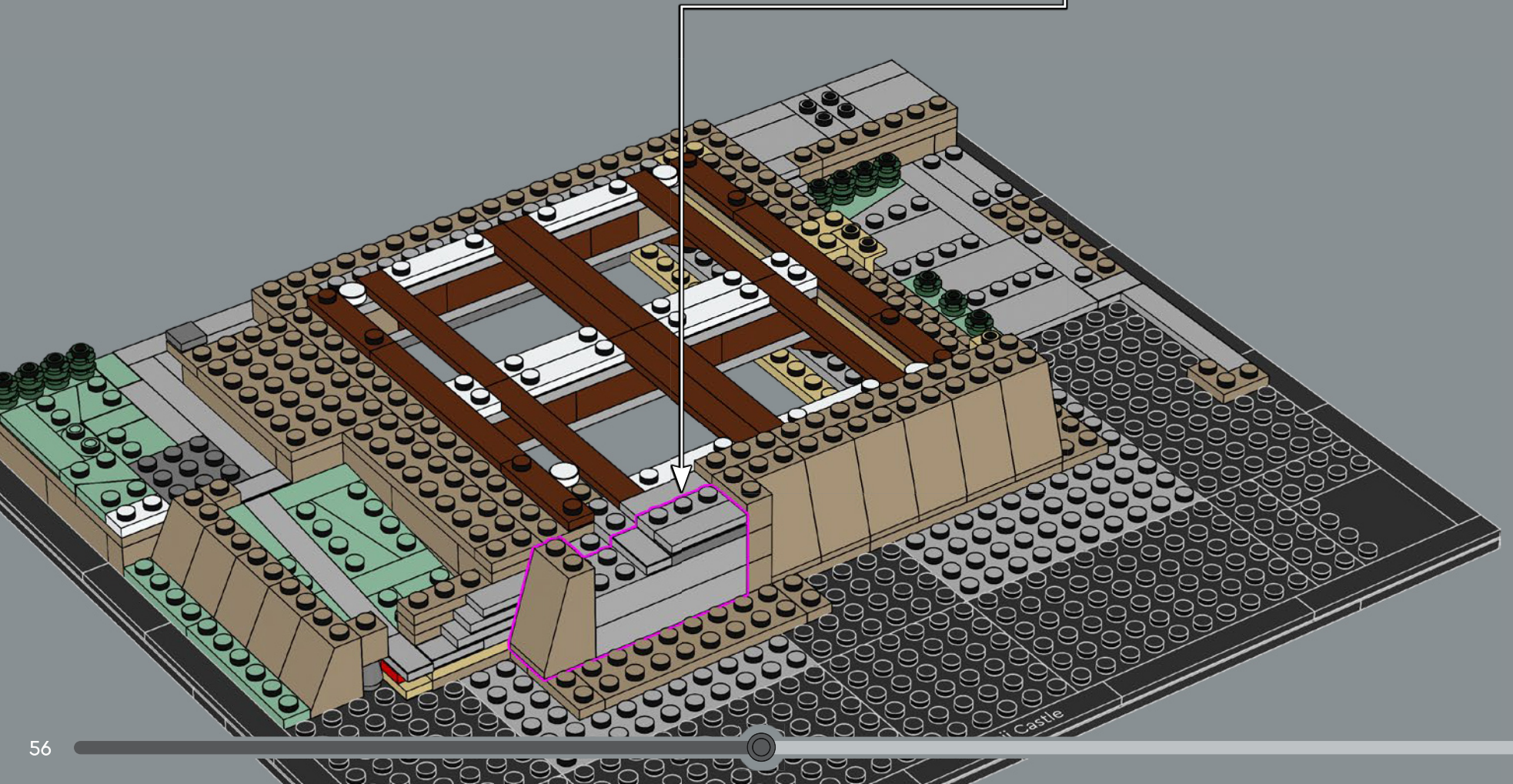
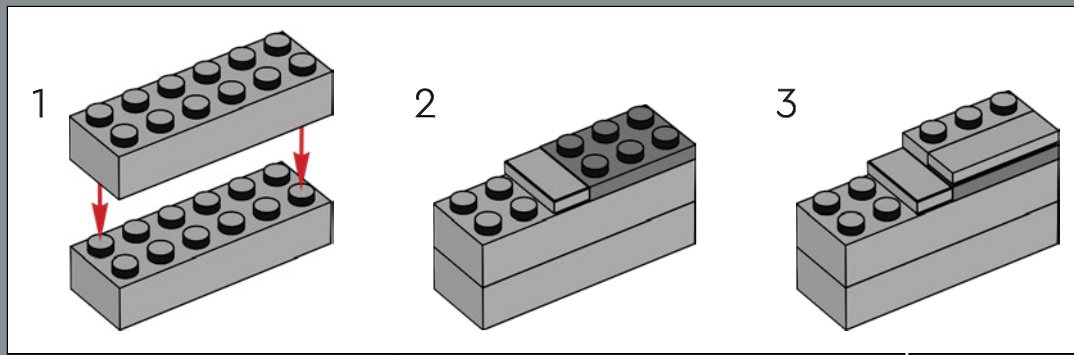

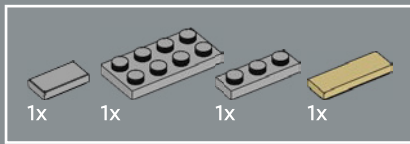

61

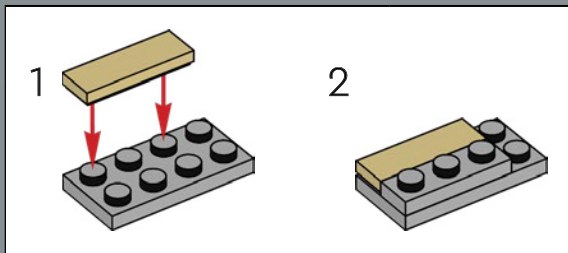
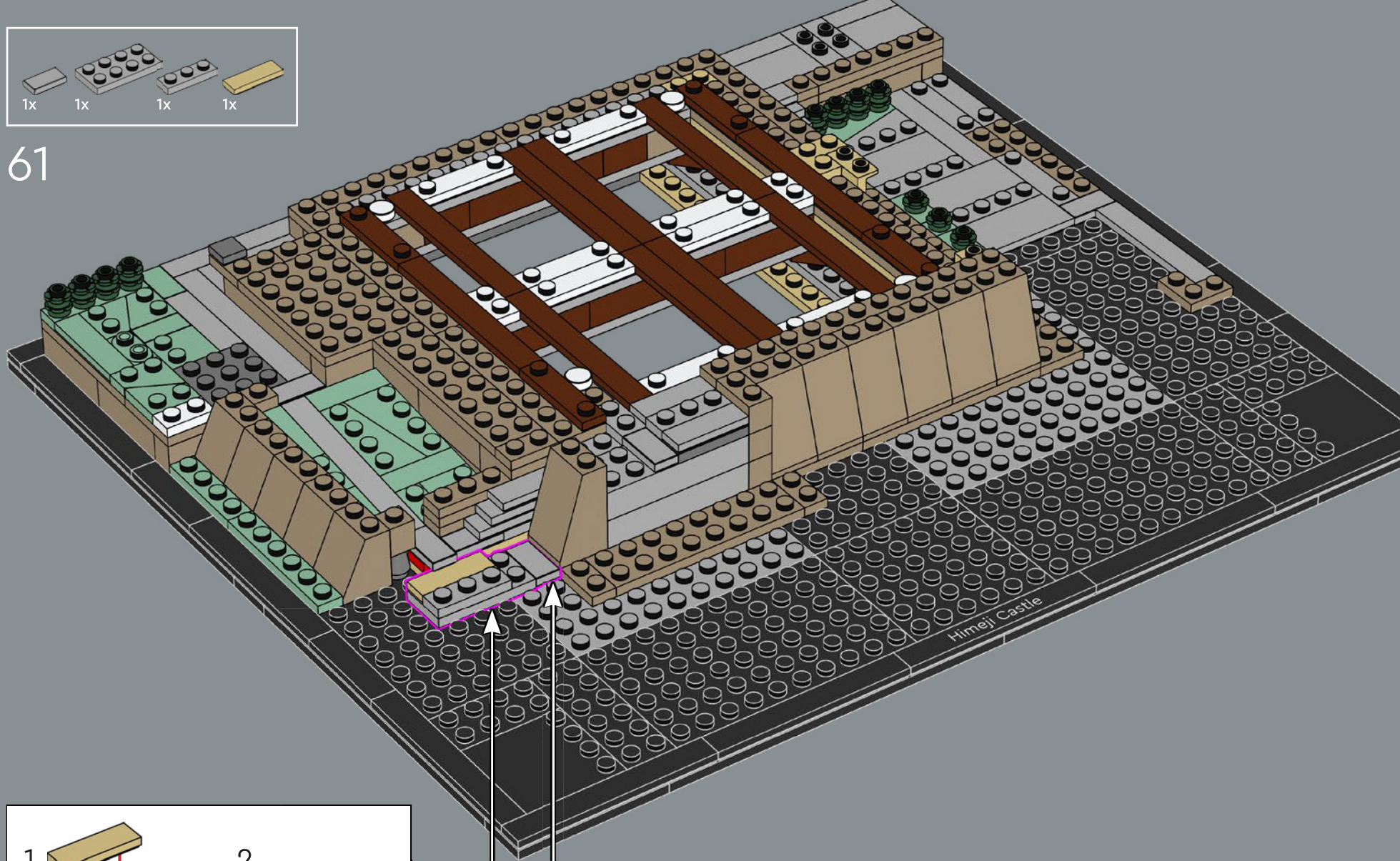

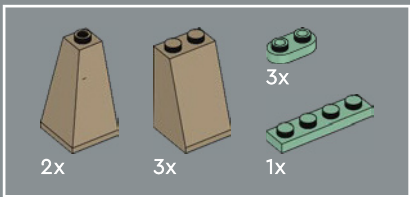

62

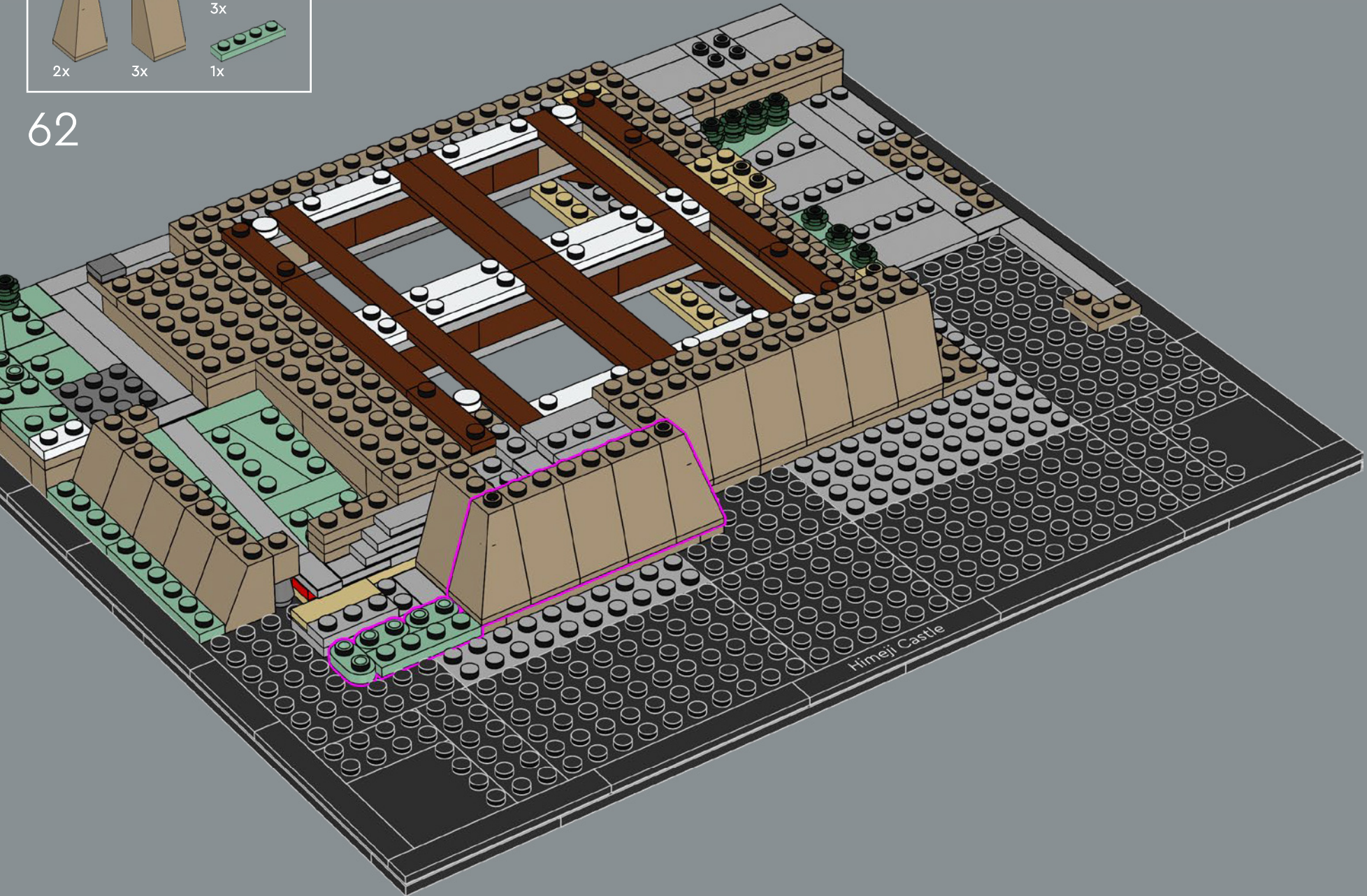

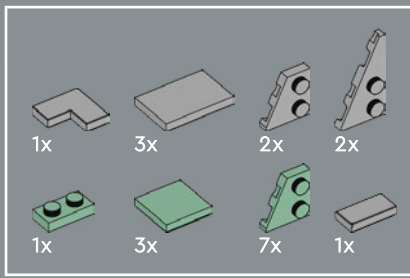

63

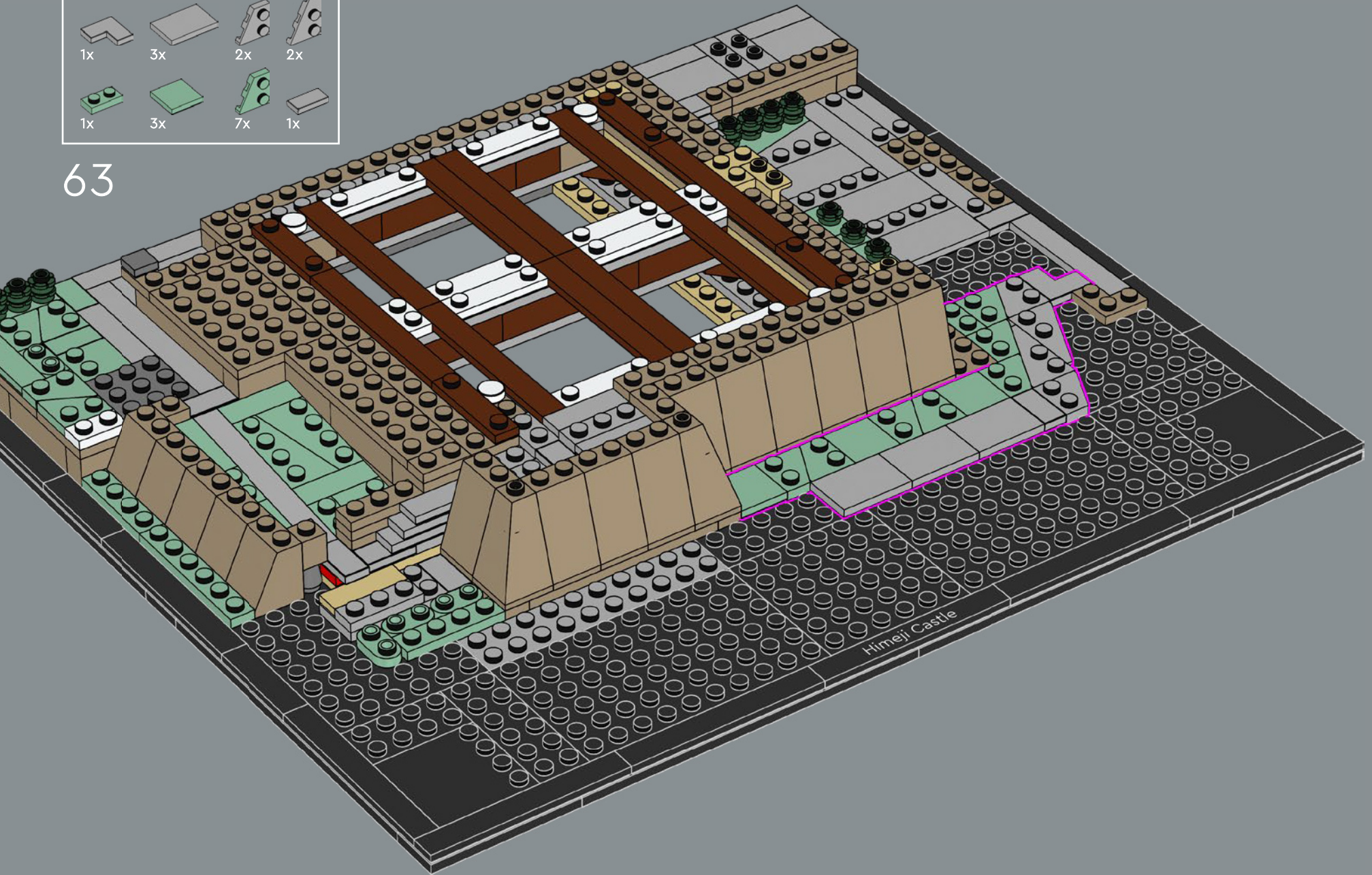

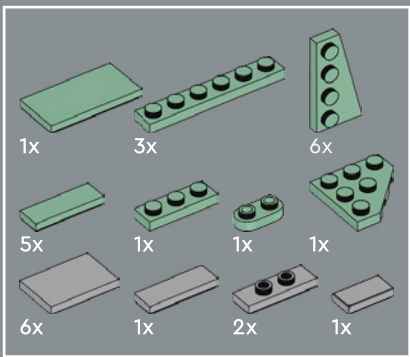

64

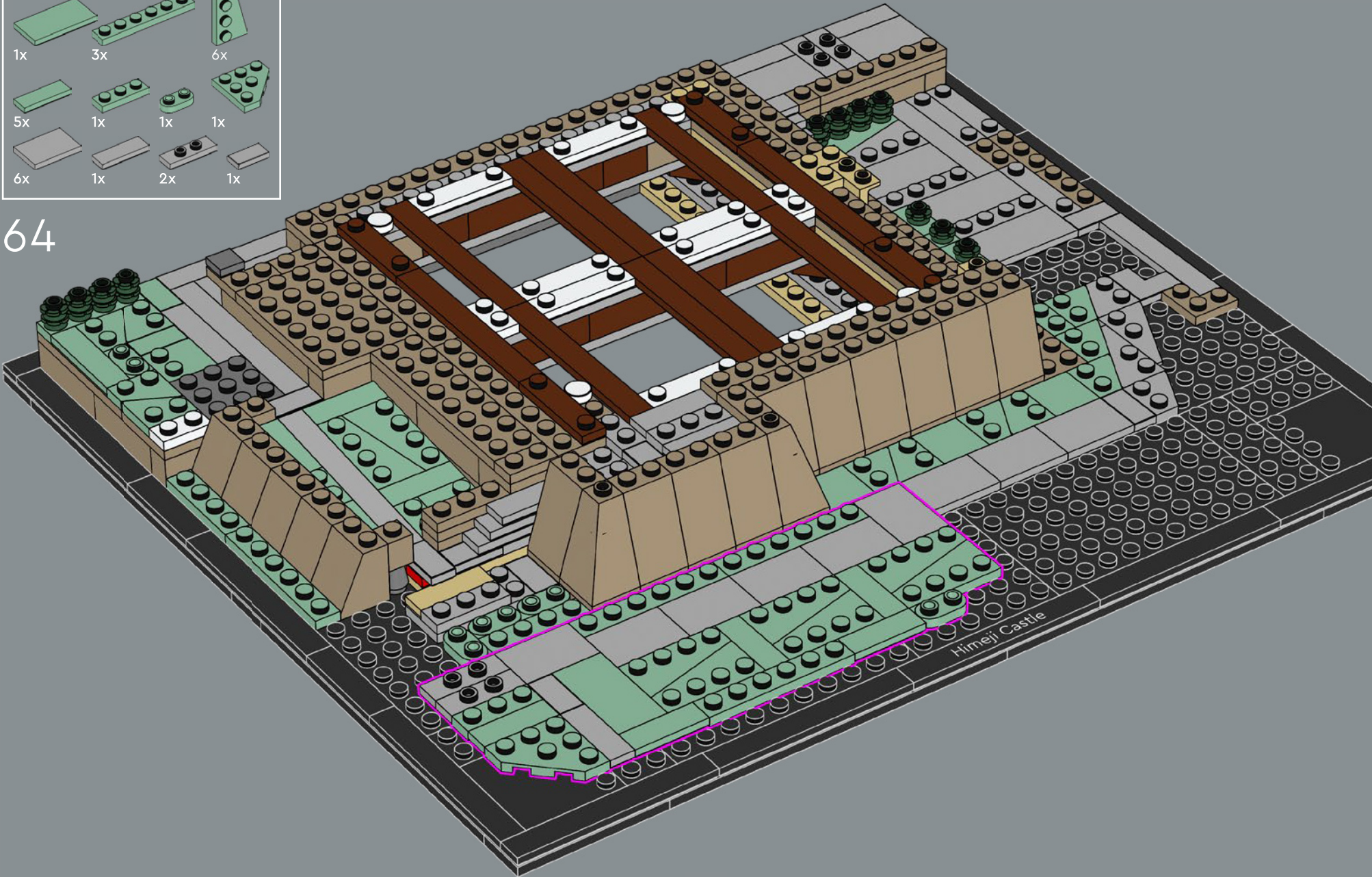

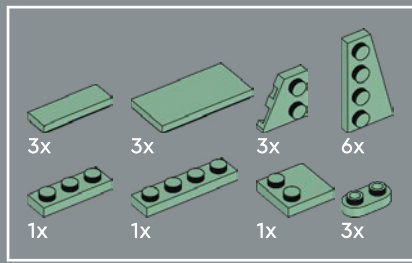

65

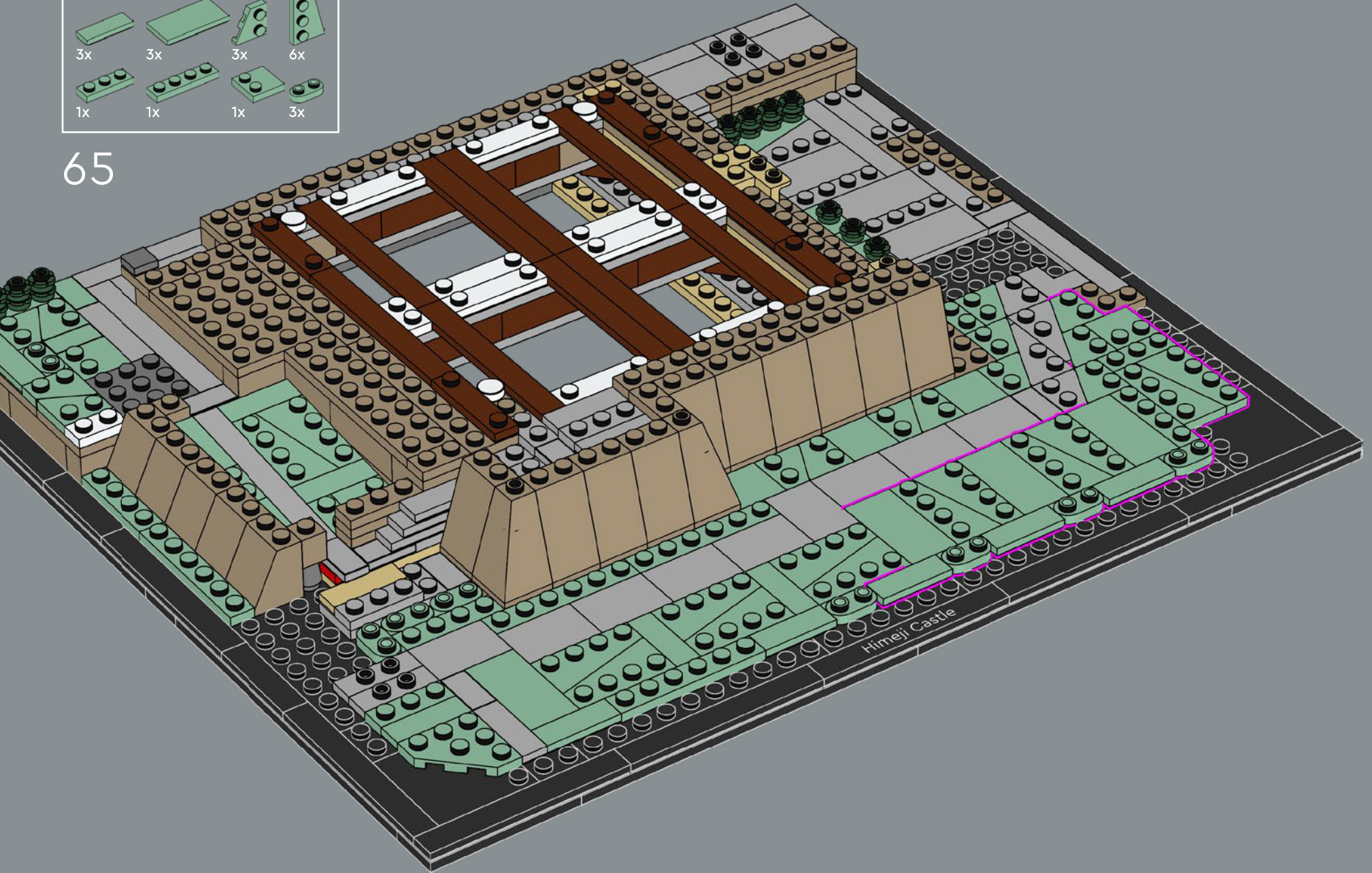

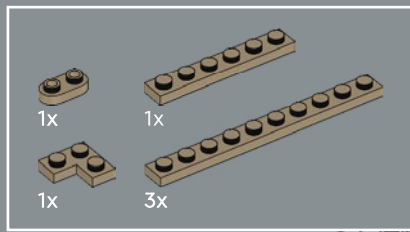

66

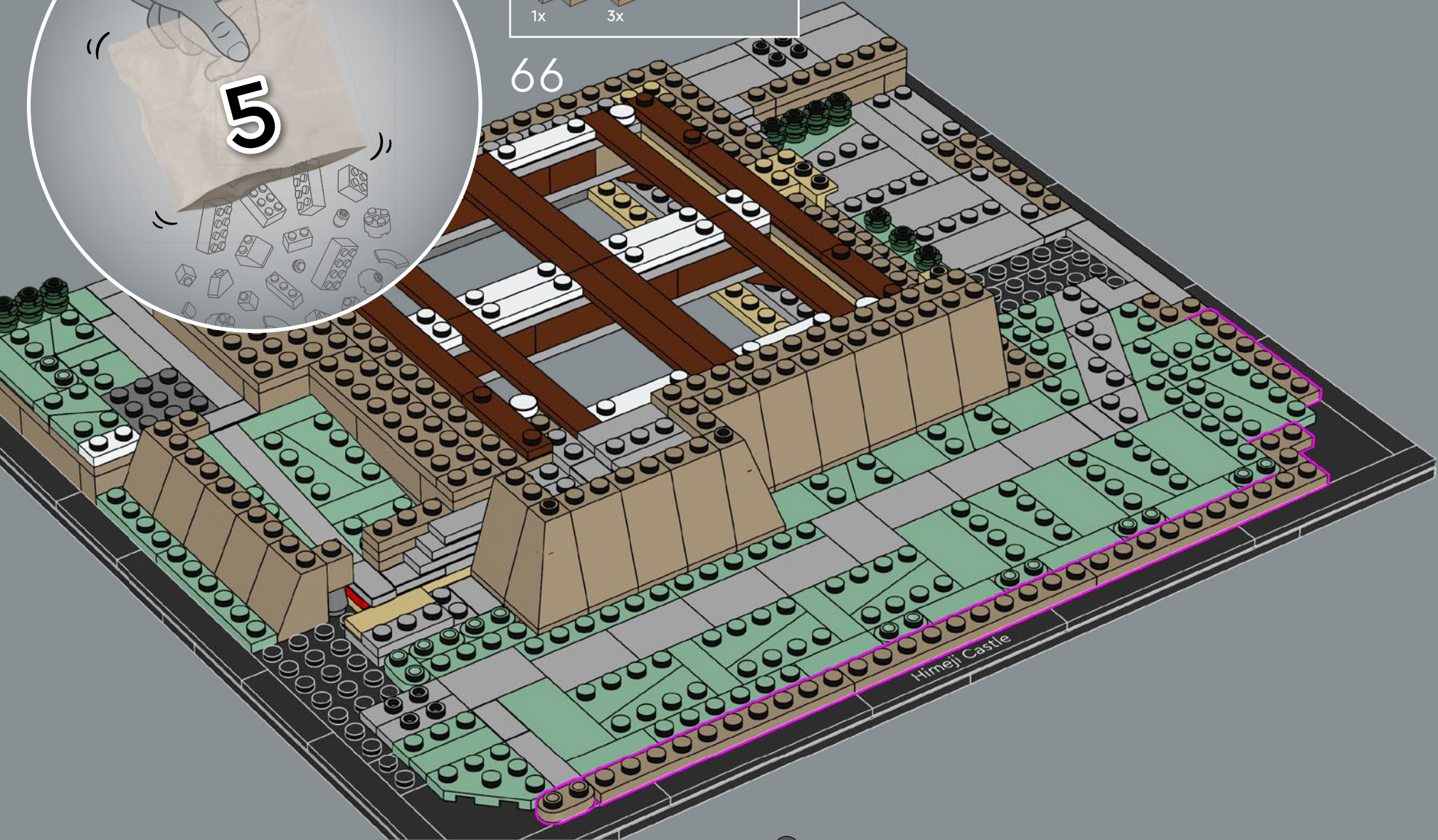

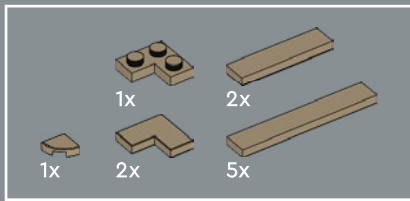

67

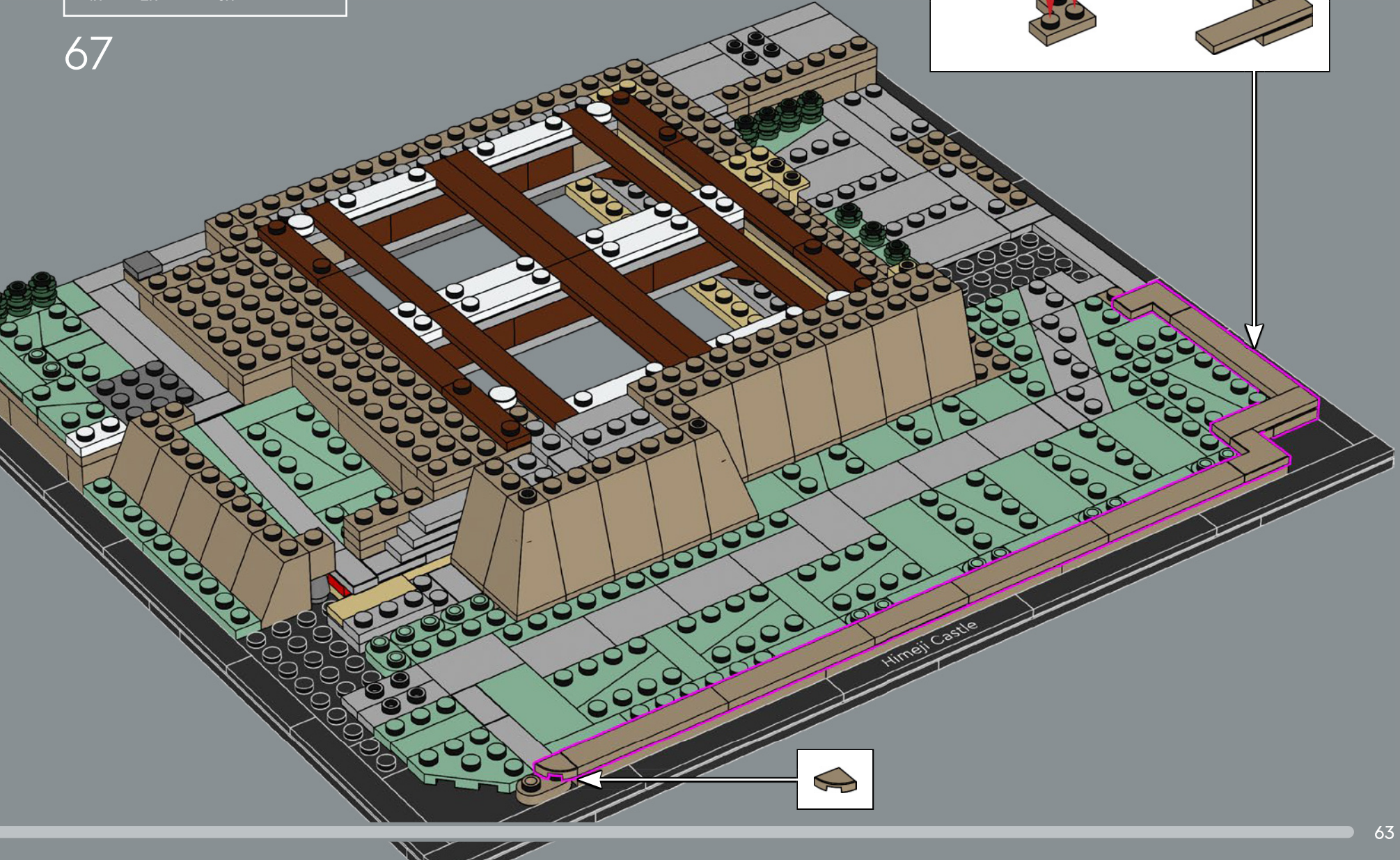
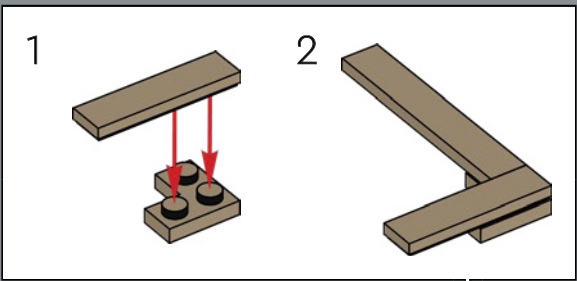

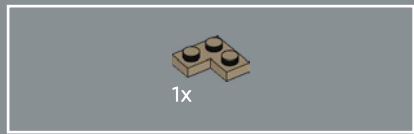

68

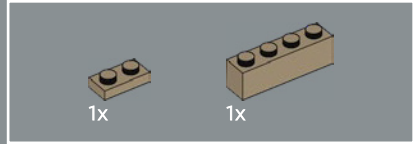

69

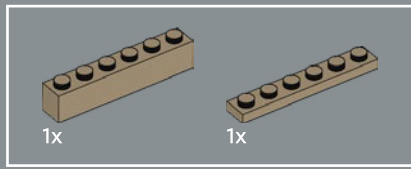
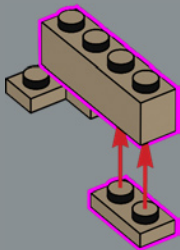

70

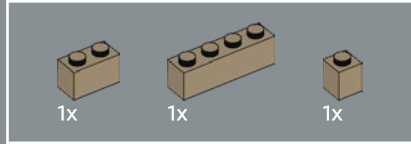
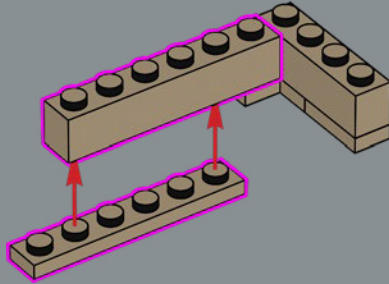

71

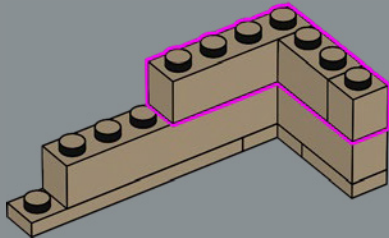

72

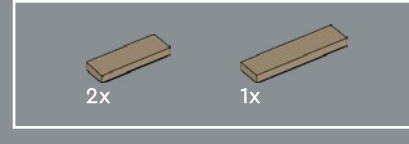
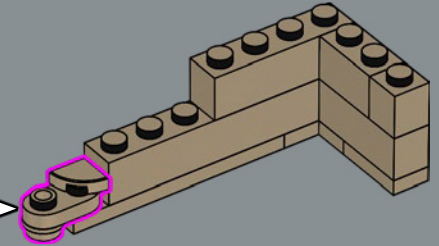
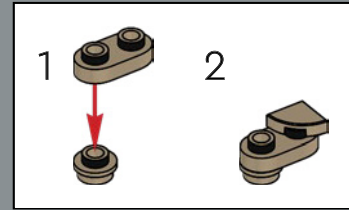

73

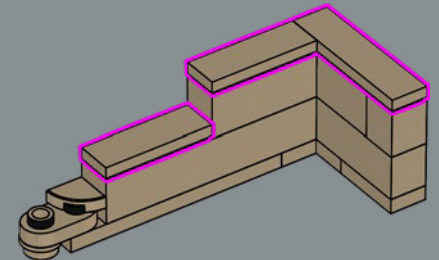

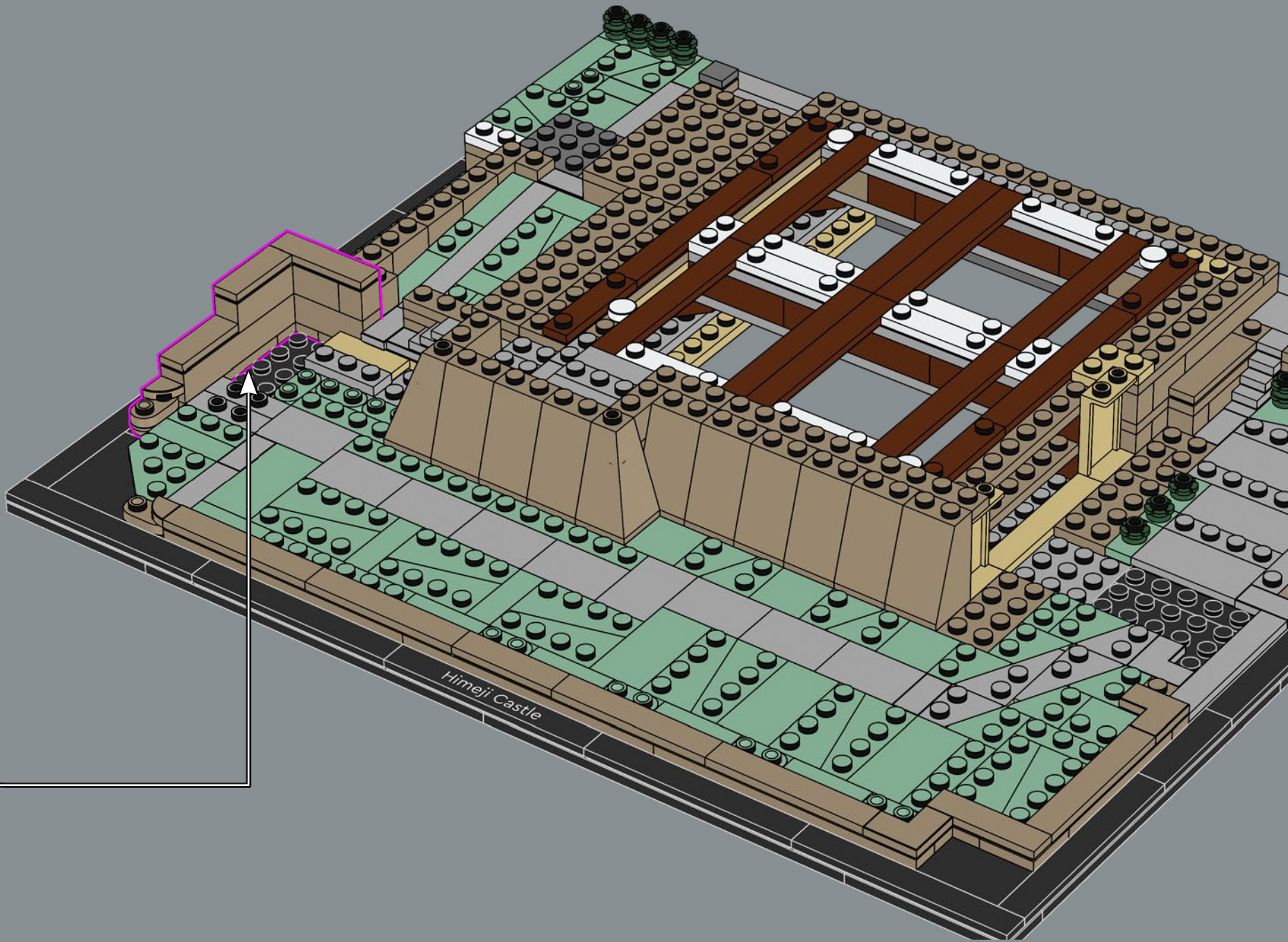

Himeji Castle

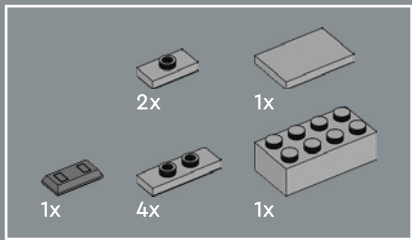

75

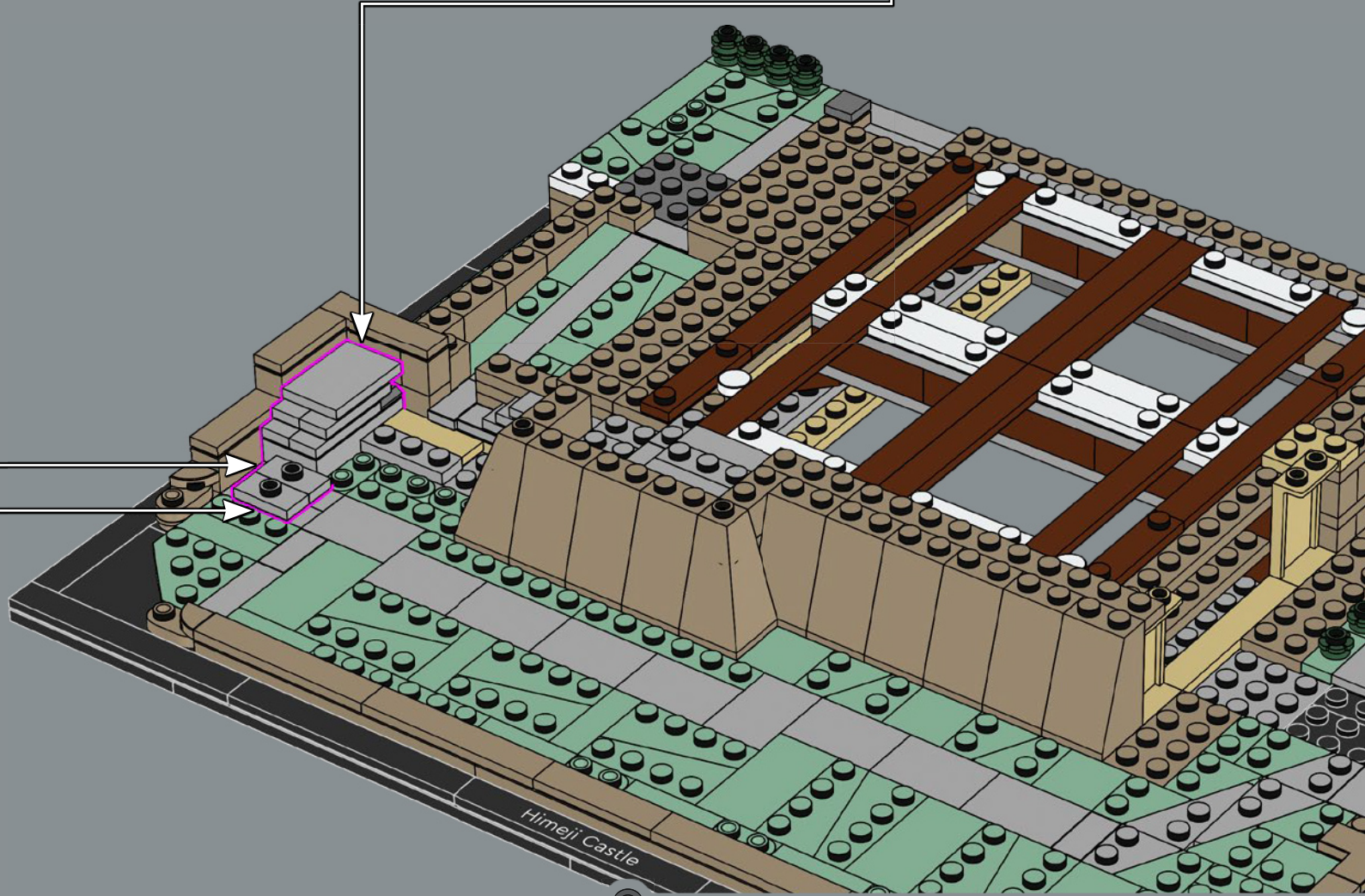
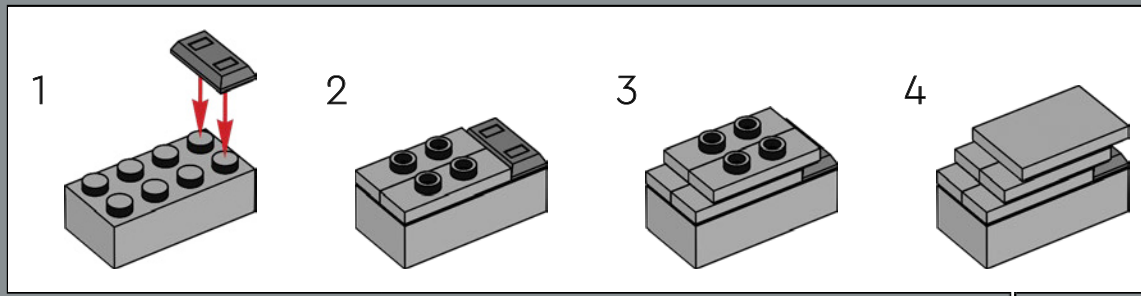

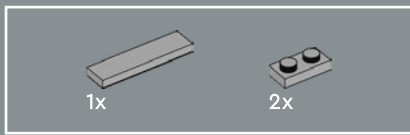

76

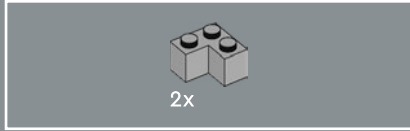
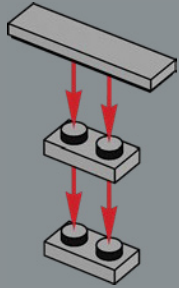

77

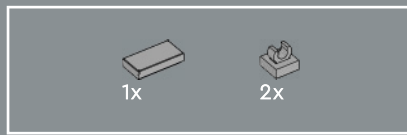
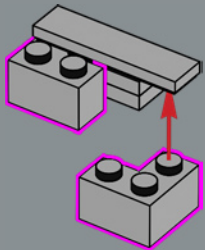

78

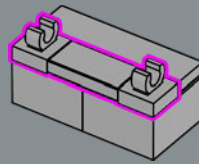

79

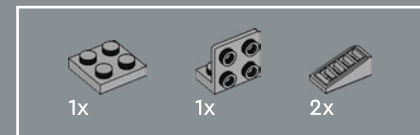
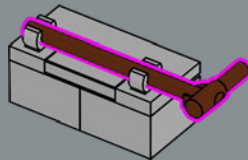

80

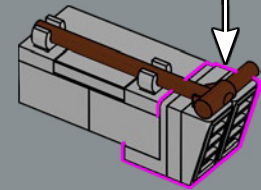
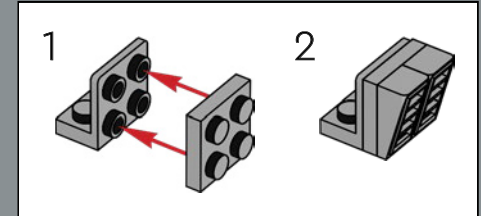

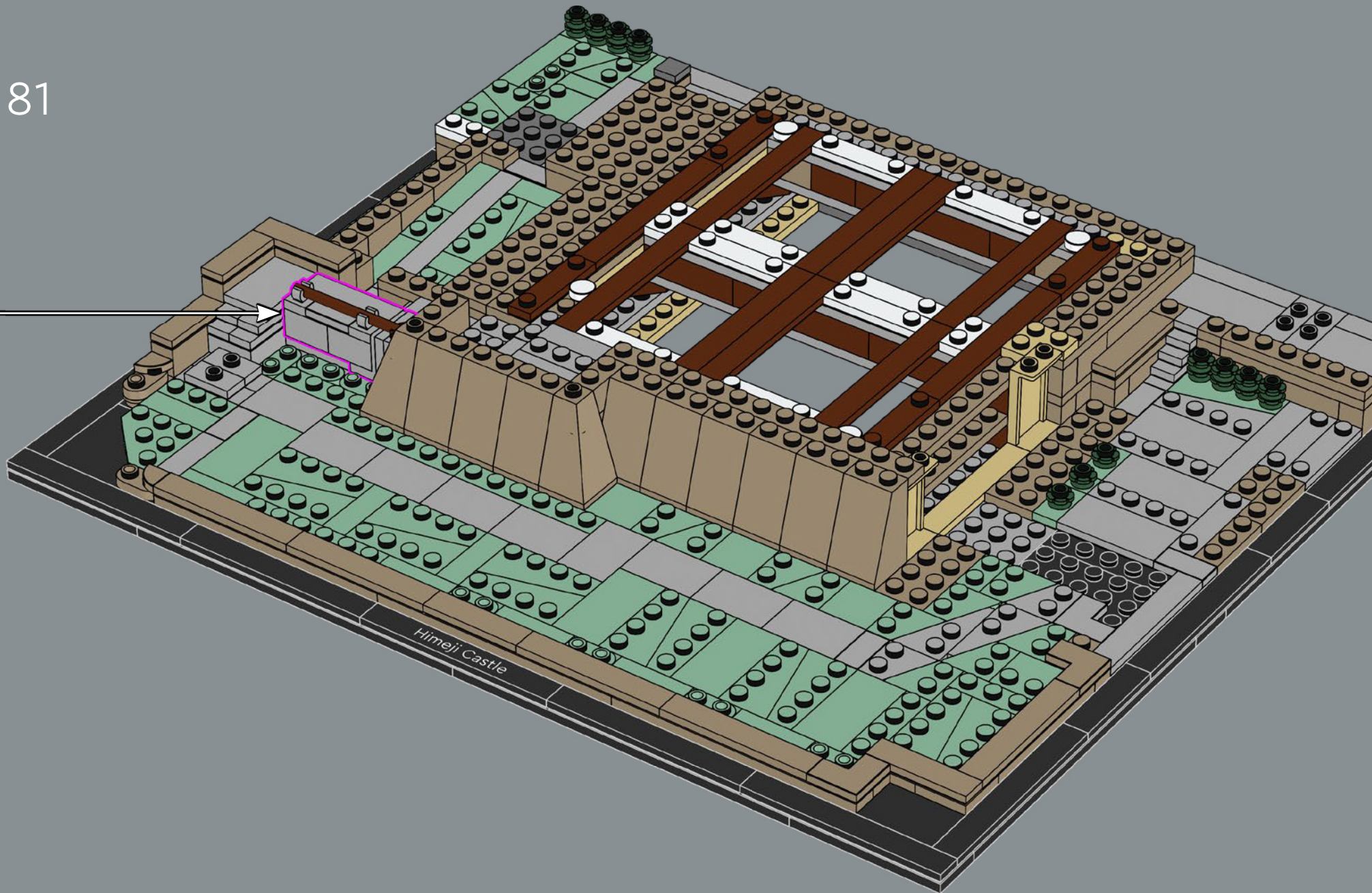

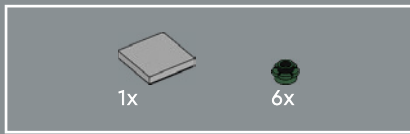

82

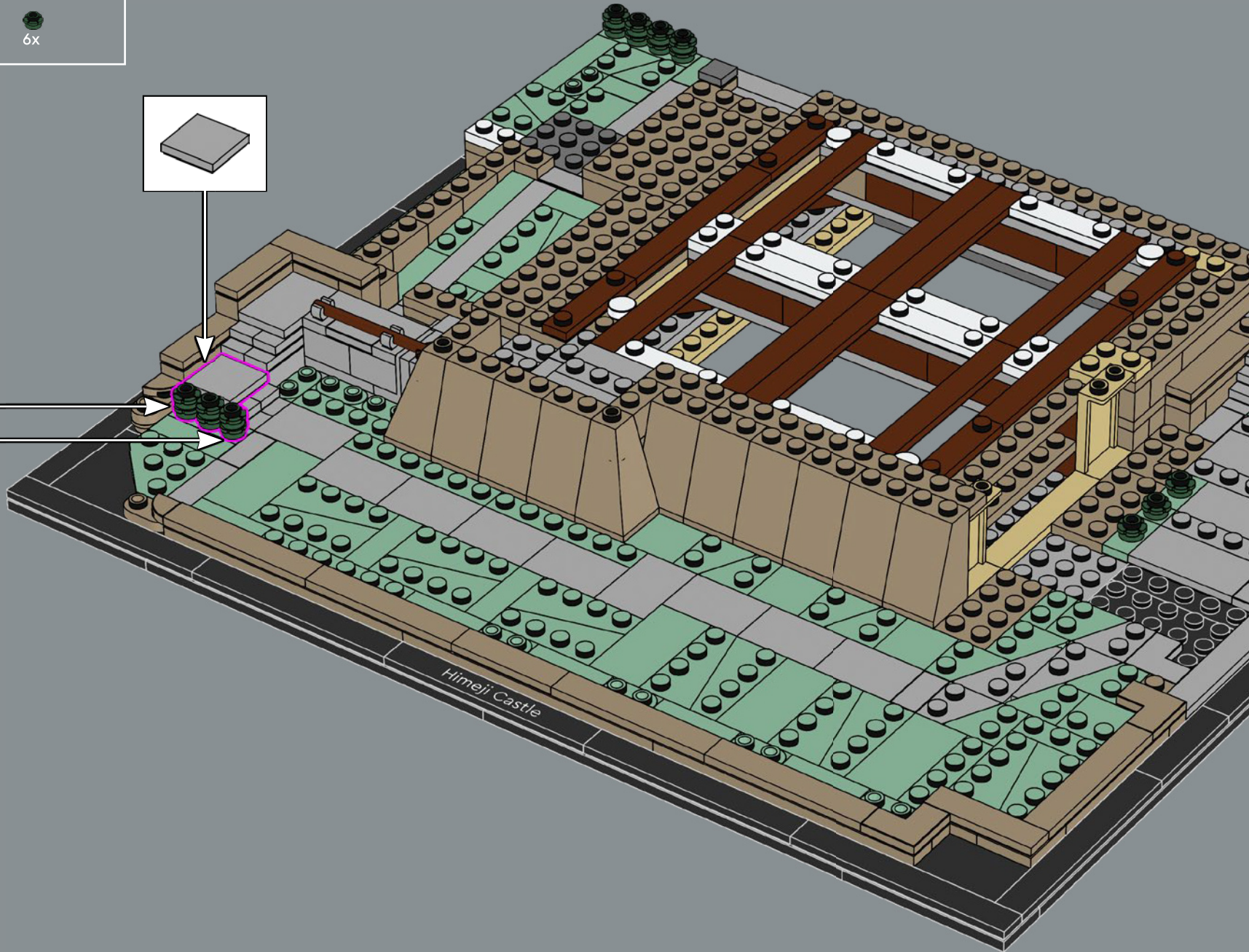
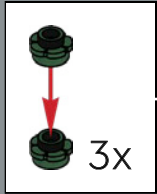
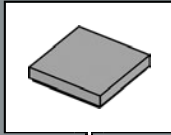

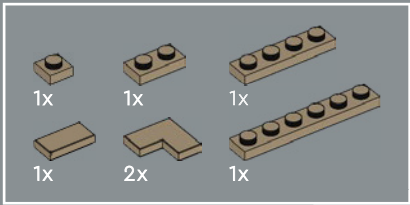

83

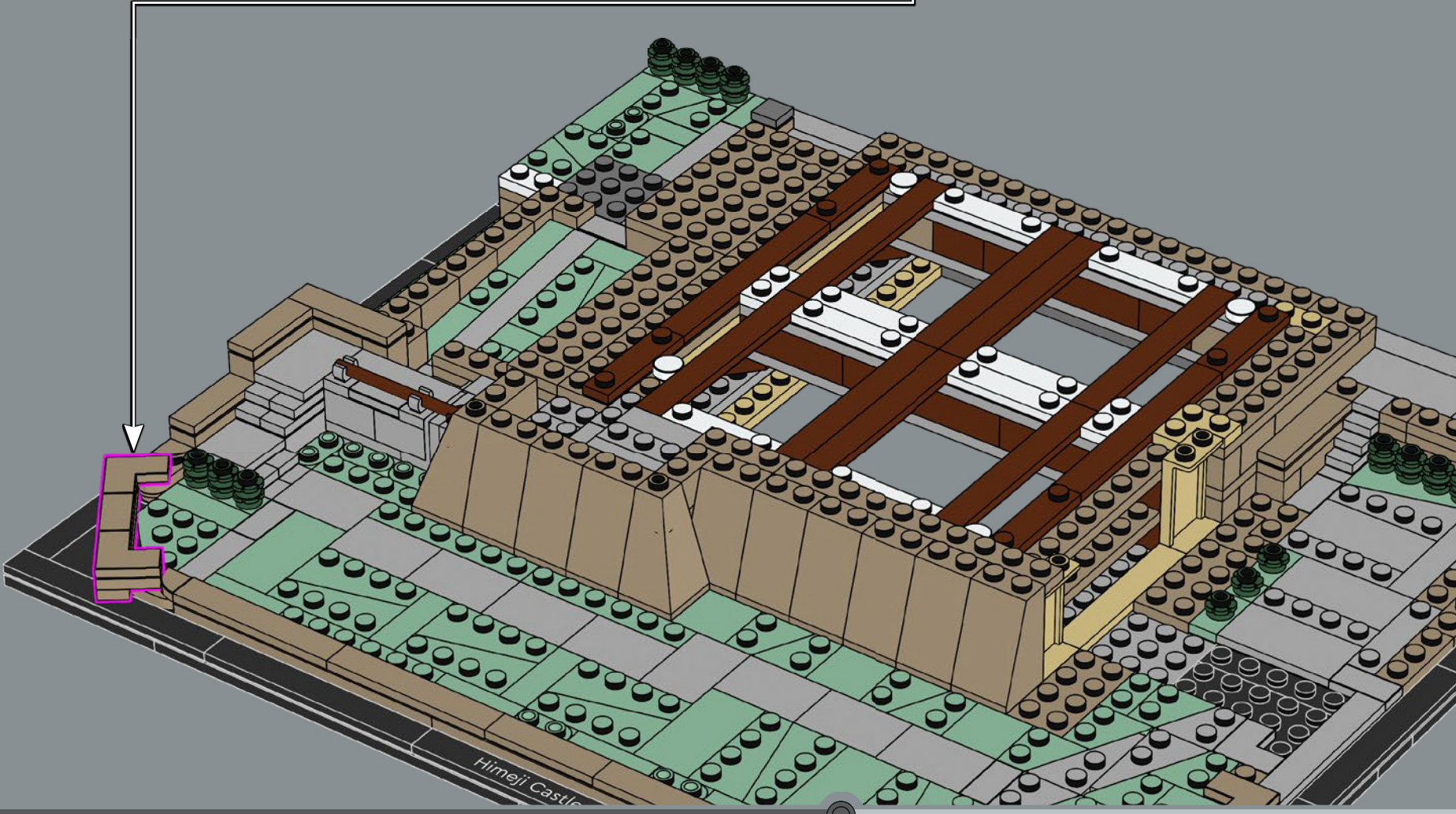
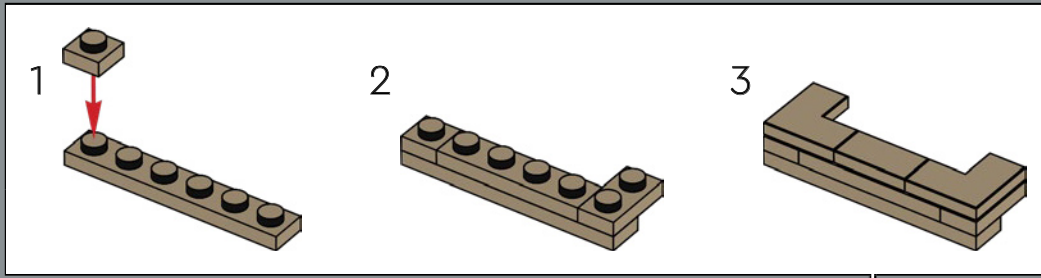

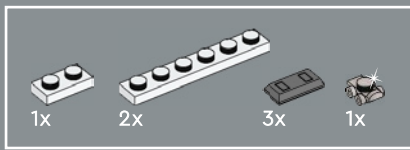

84

1

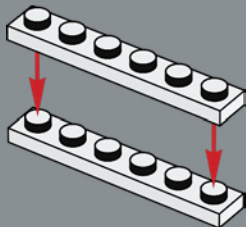

2

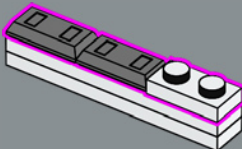

3

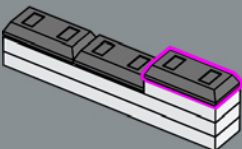

4



1:1

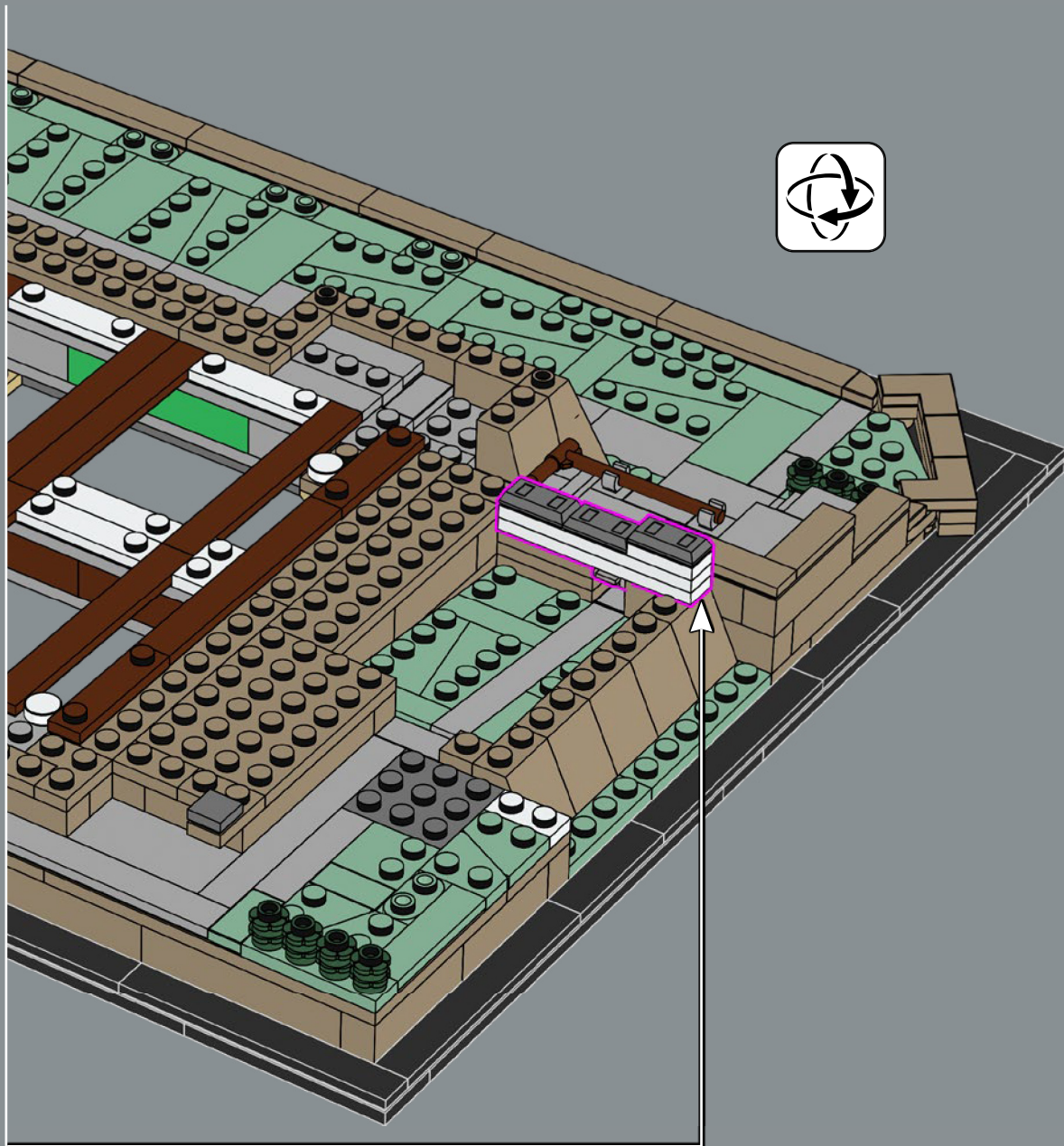
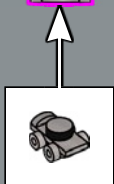

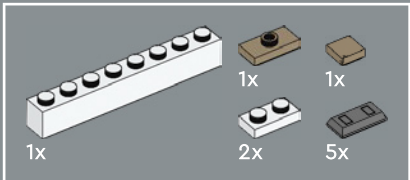

85

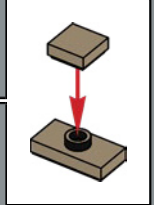
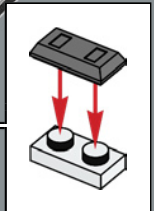
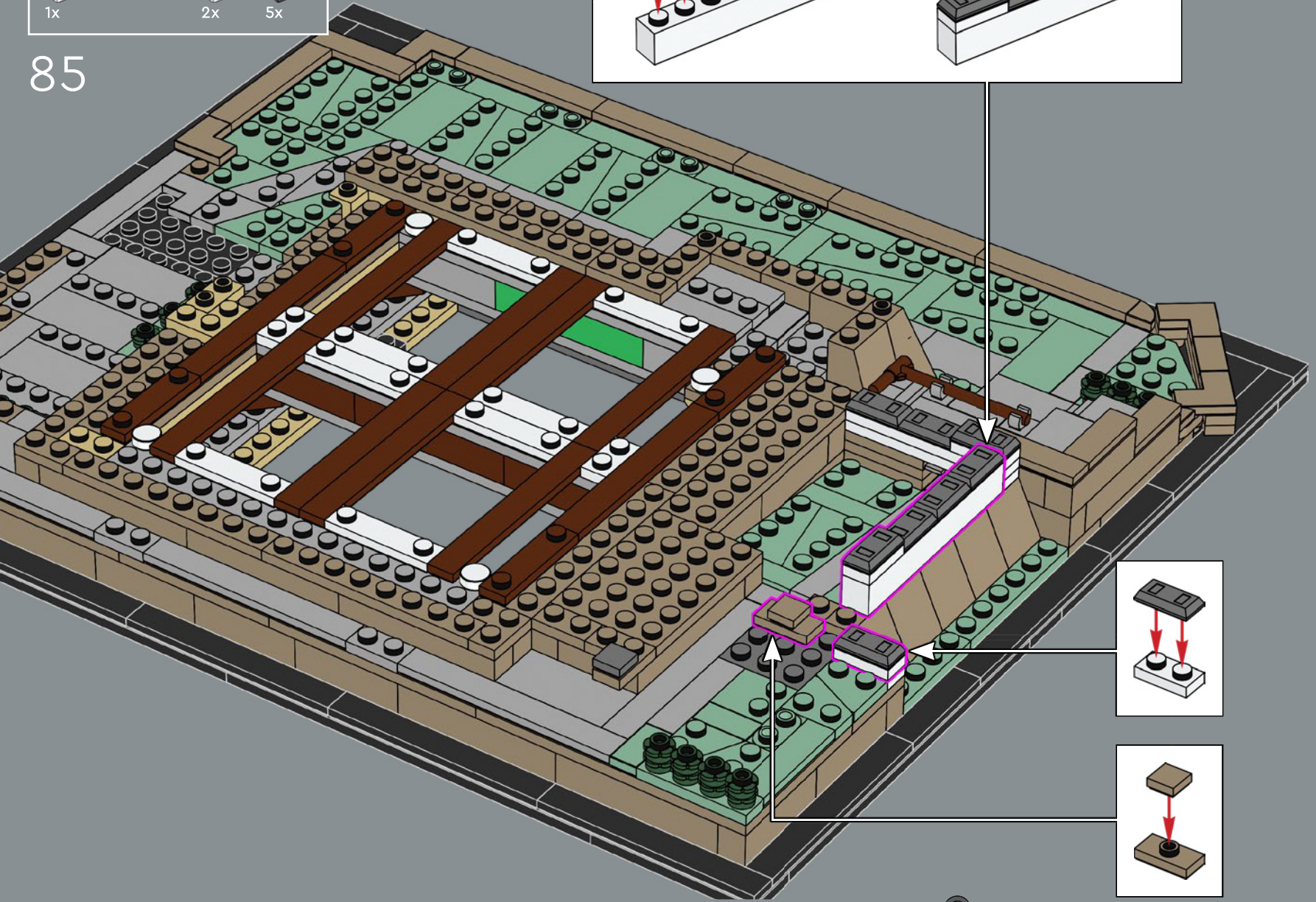
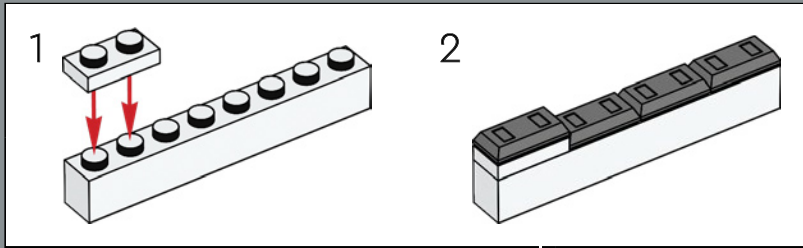

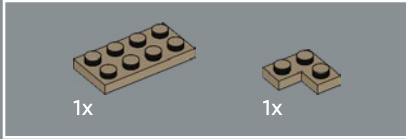
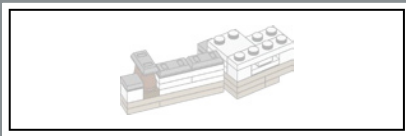

86

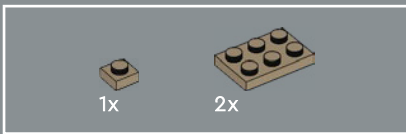
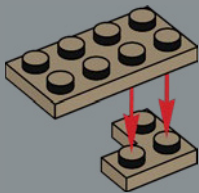

87

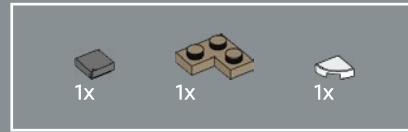
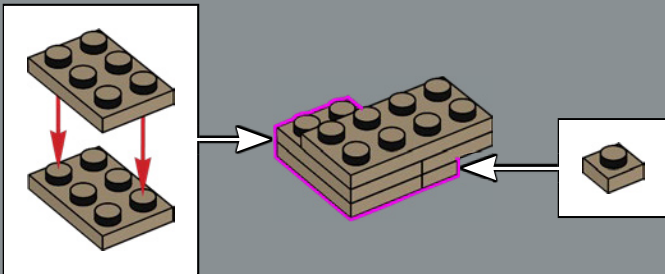

88

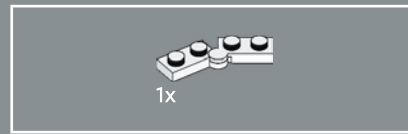
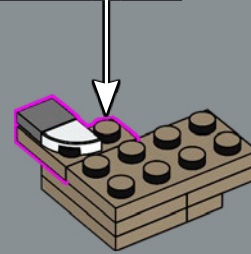
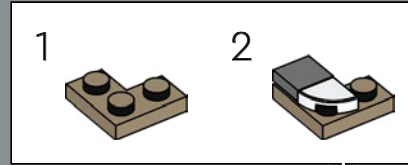

89

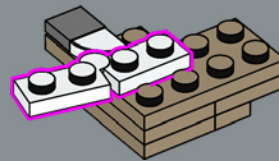

90

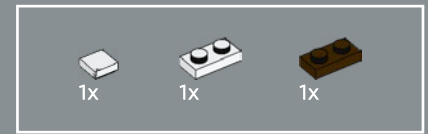
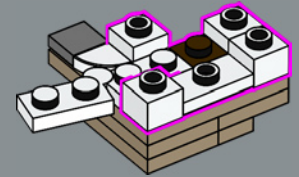

91

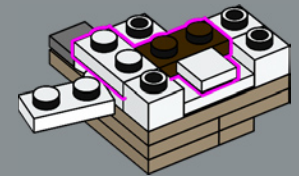

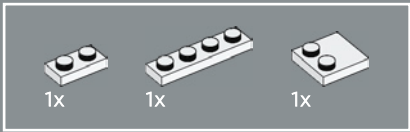

92

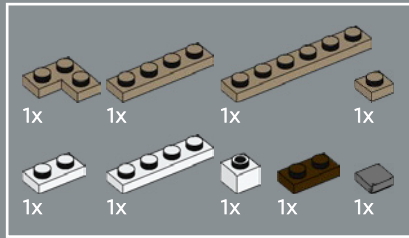
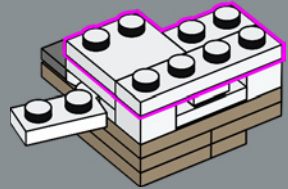

93

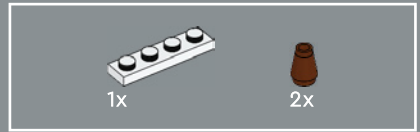
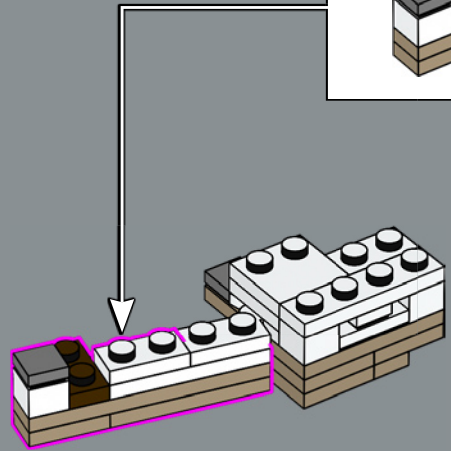
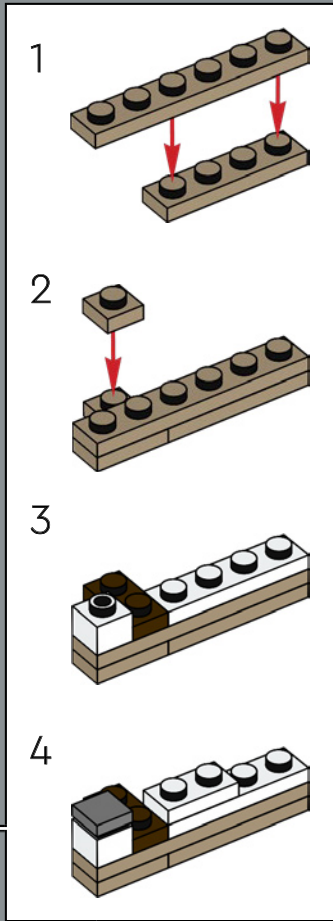

94

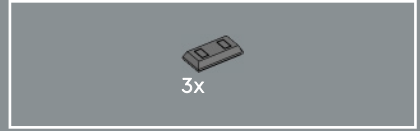
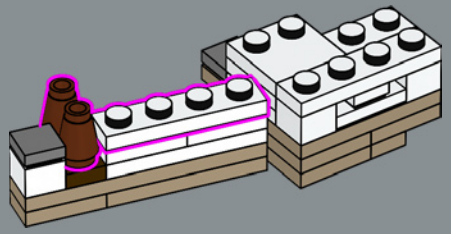

95

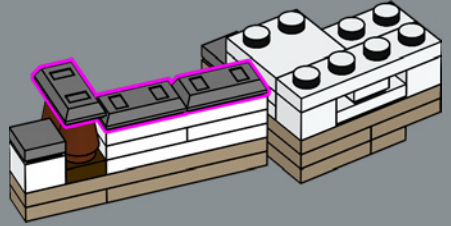

One of the features that make the castle's architecture so interesting is that many of the walls, towers and pathways are placed at irregular angles.

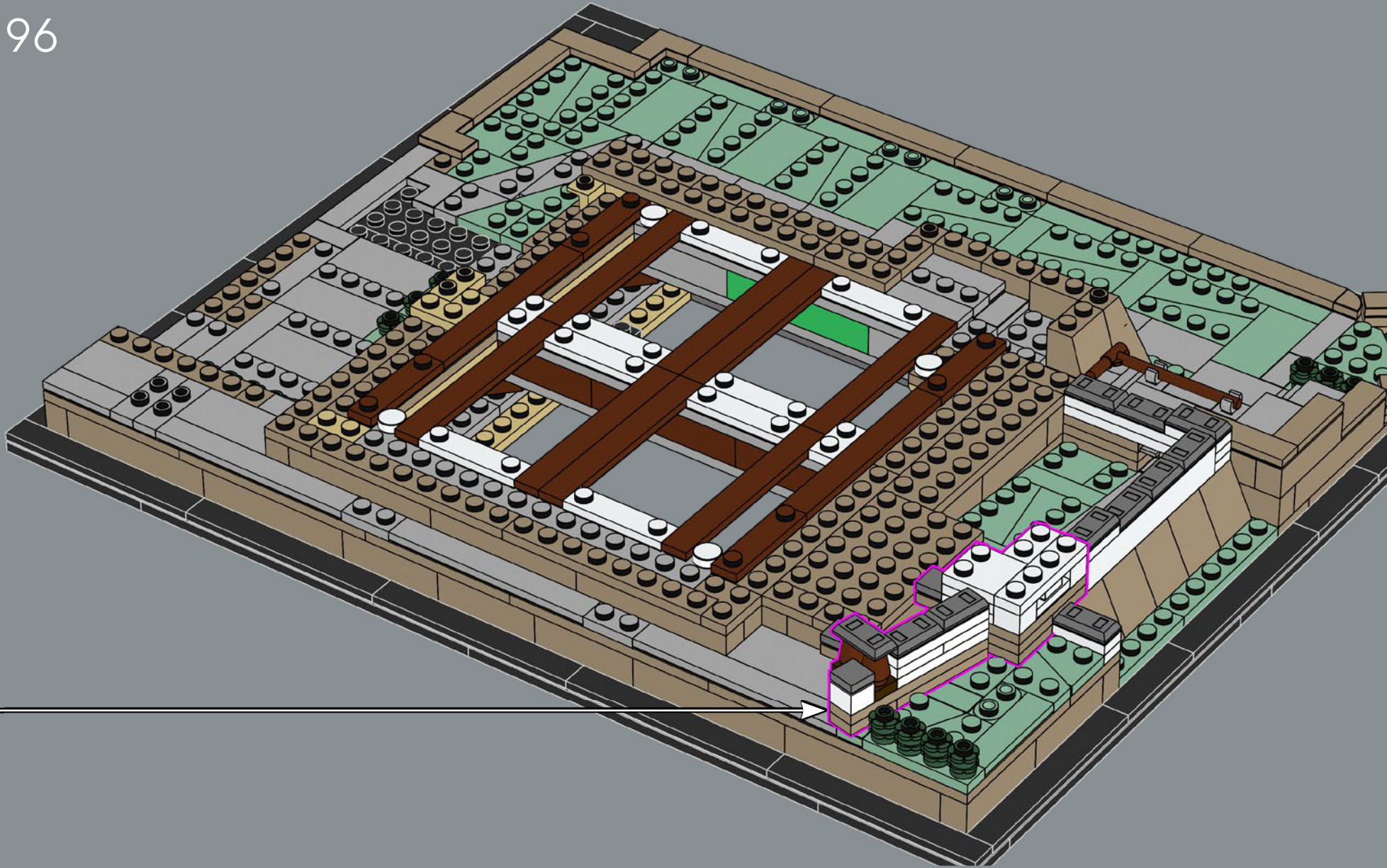

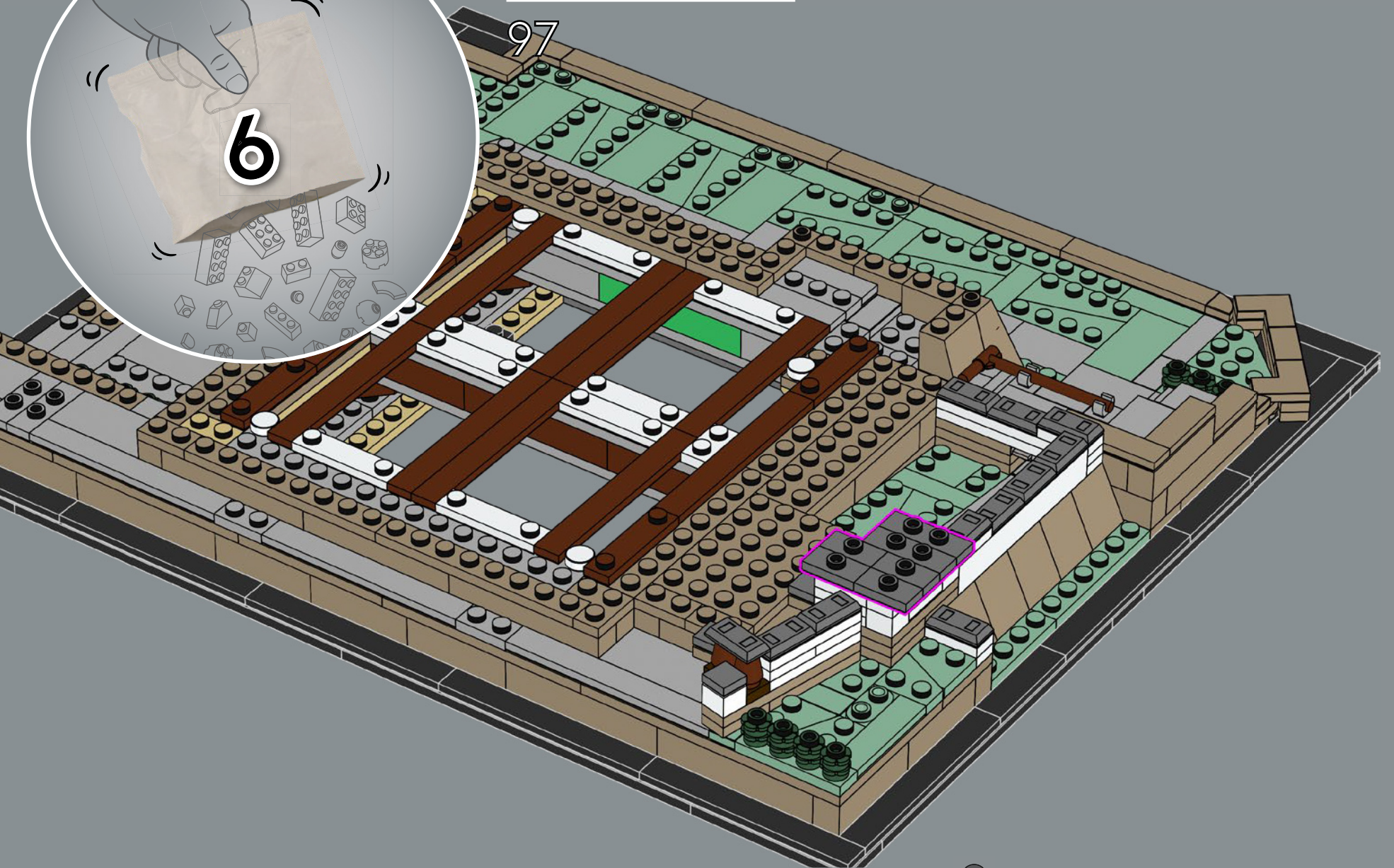
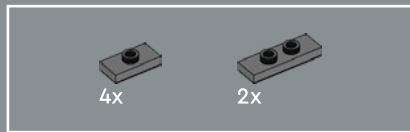

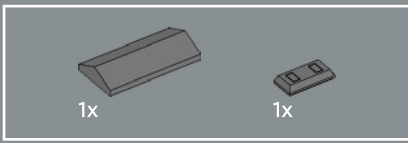

98

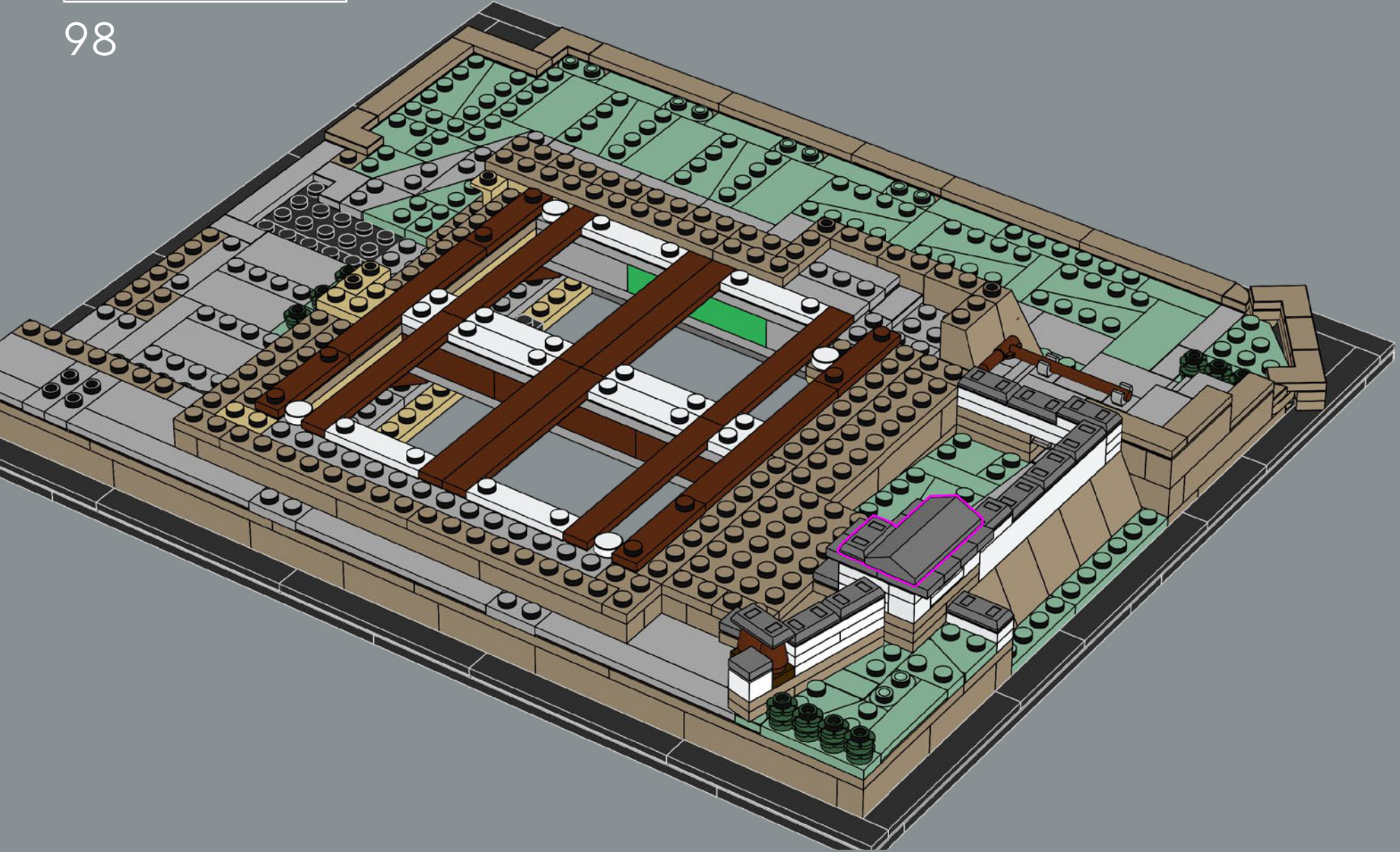

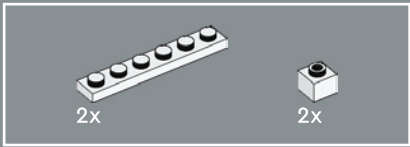

99

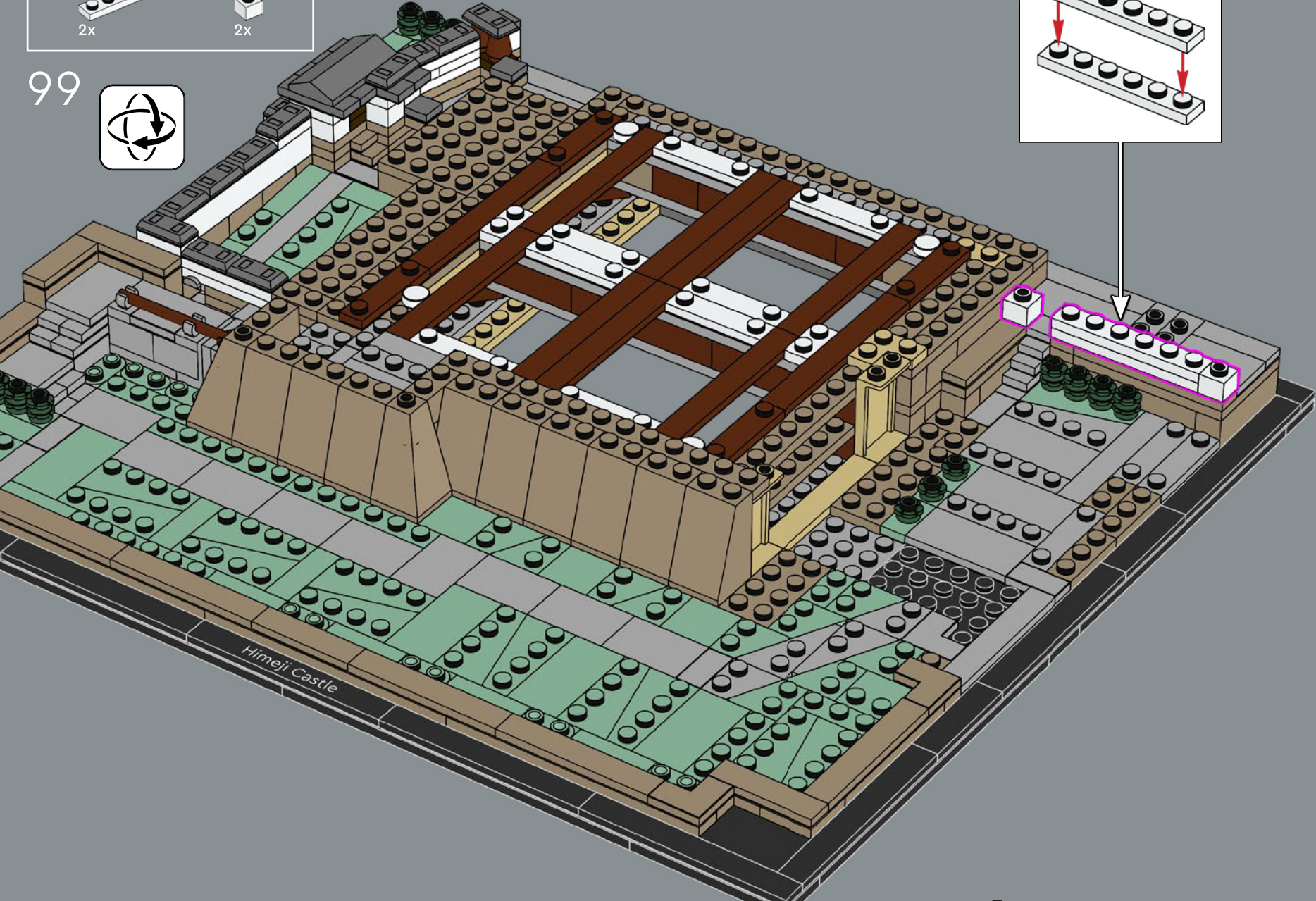
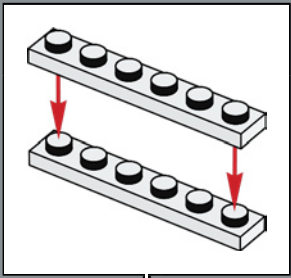

Himeji Castle



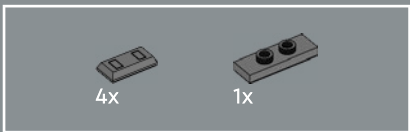

100

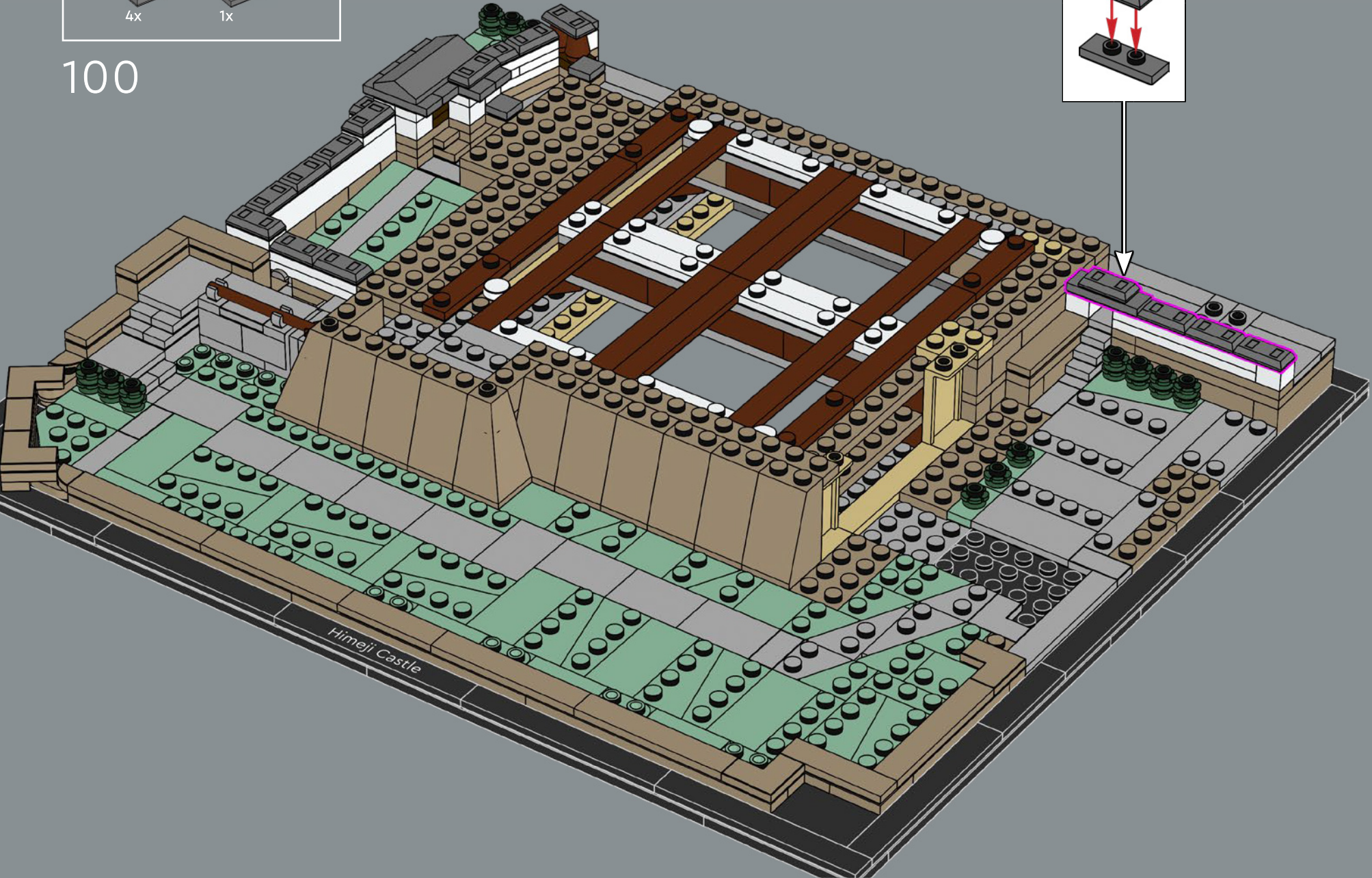
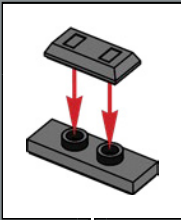

Himeji Castle

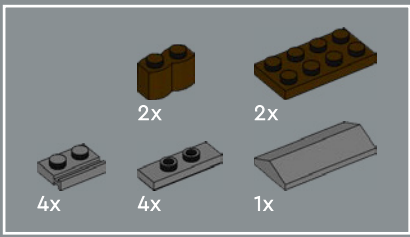

101

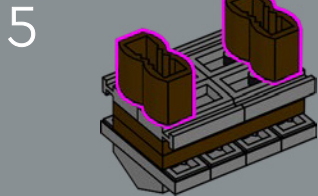
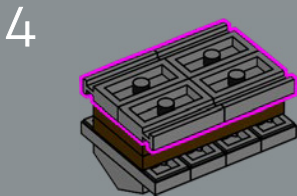
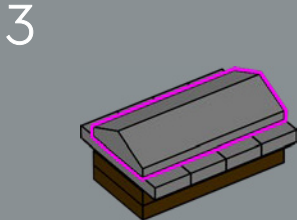
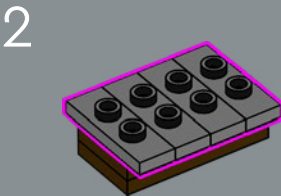
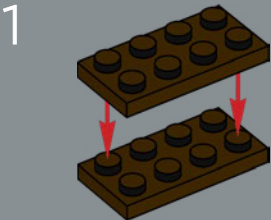

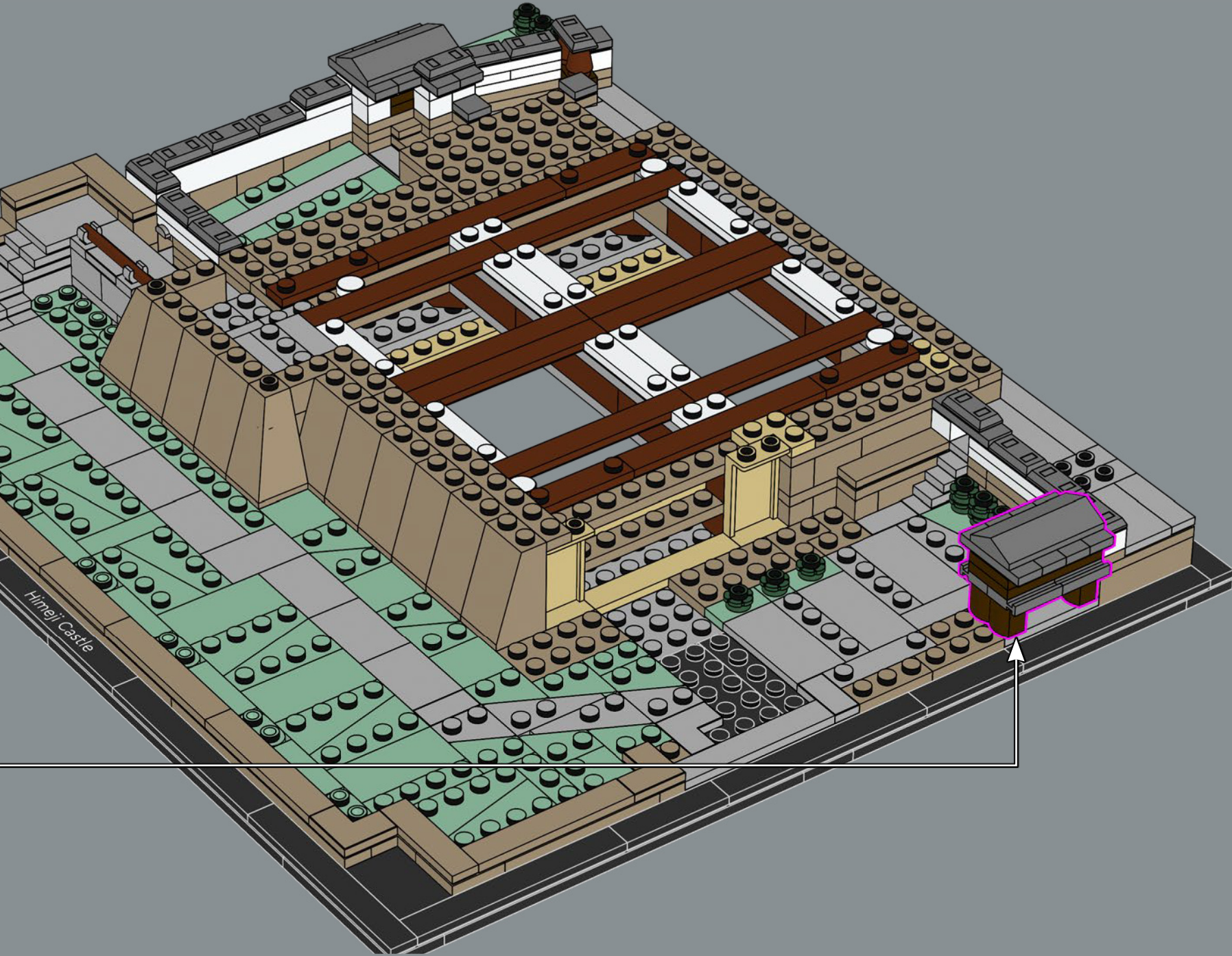

Himeji Castle

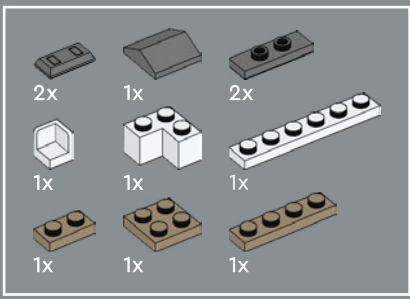

102

1

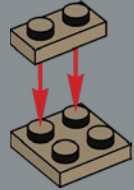

2

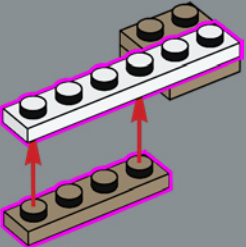

3

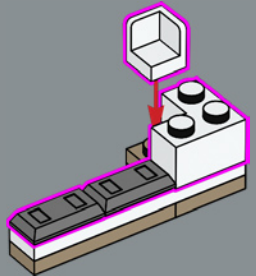

4

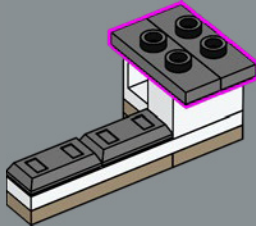

5

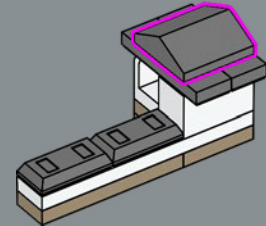

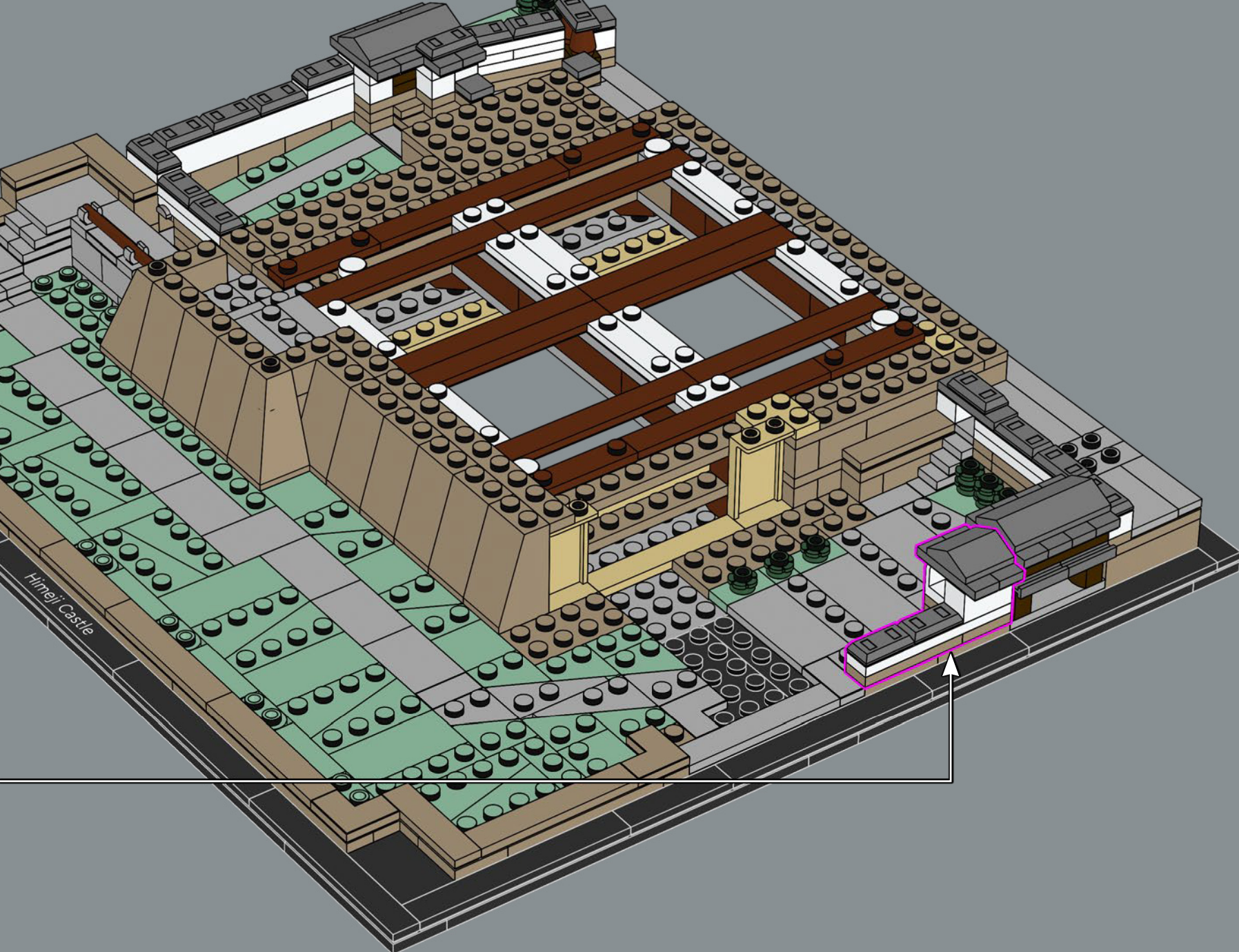

Himeji Castle

		
1x	2x	1x

103

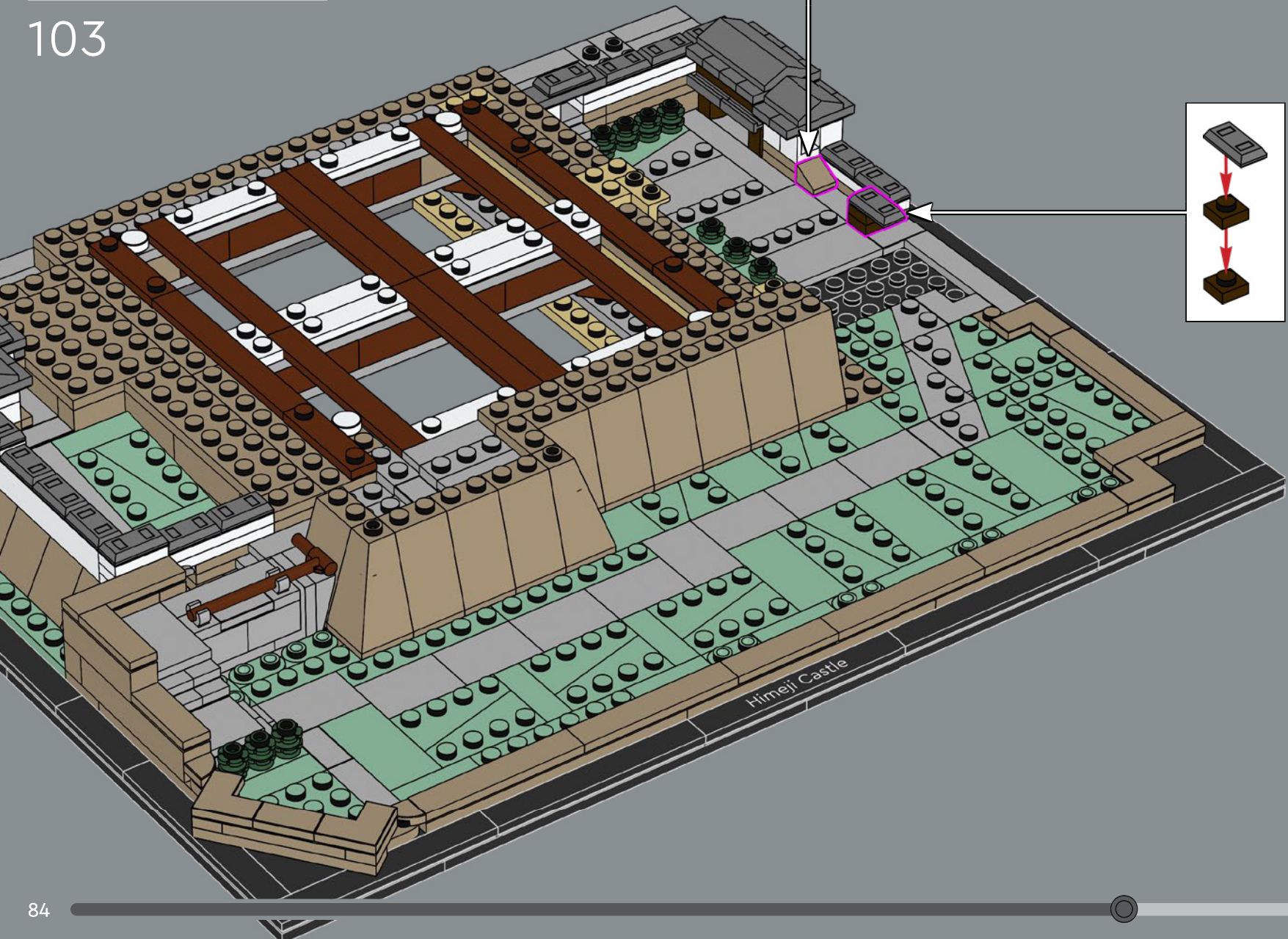
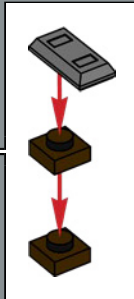

Himeji Castle



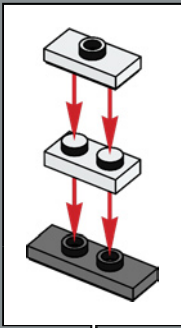
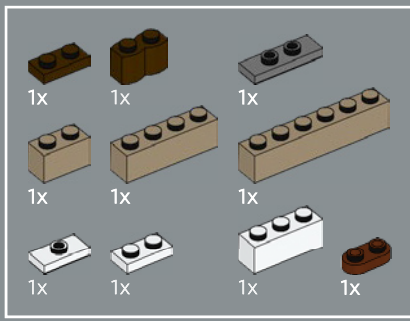

104

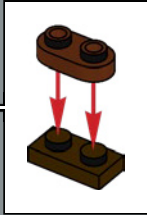
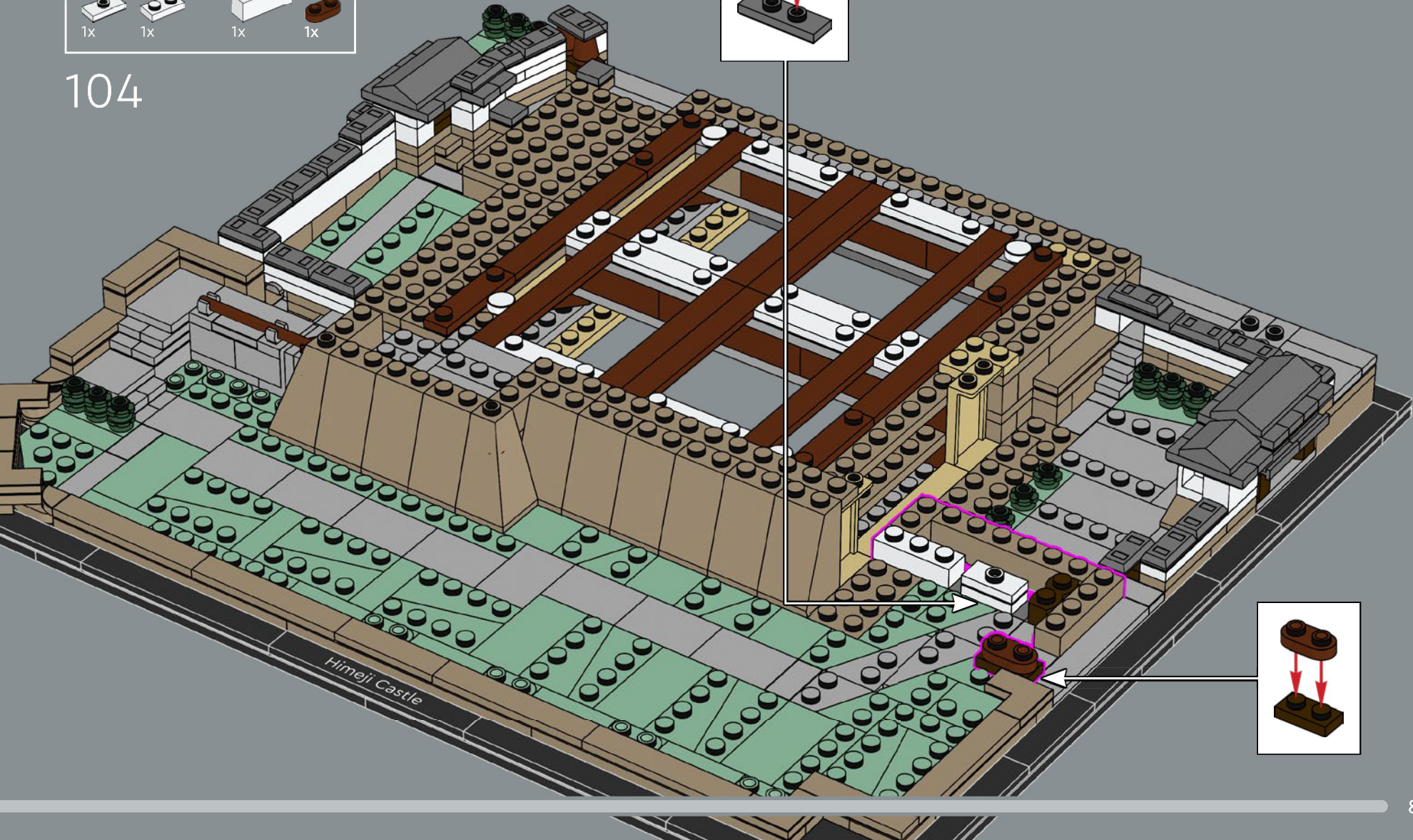

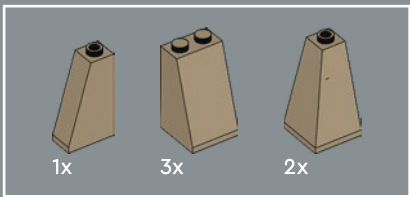

105

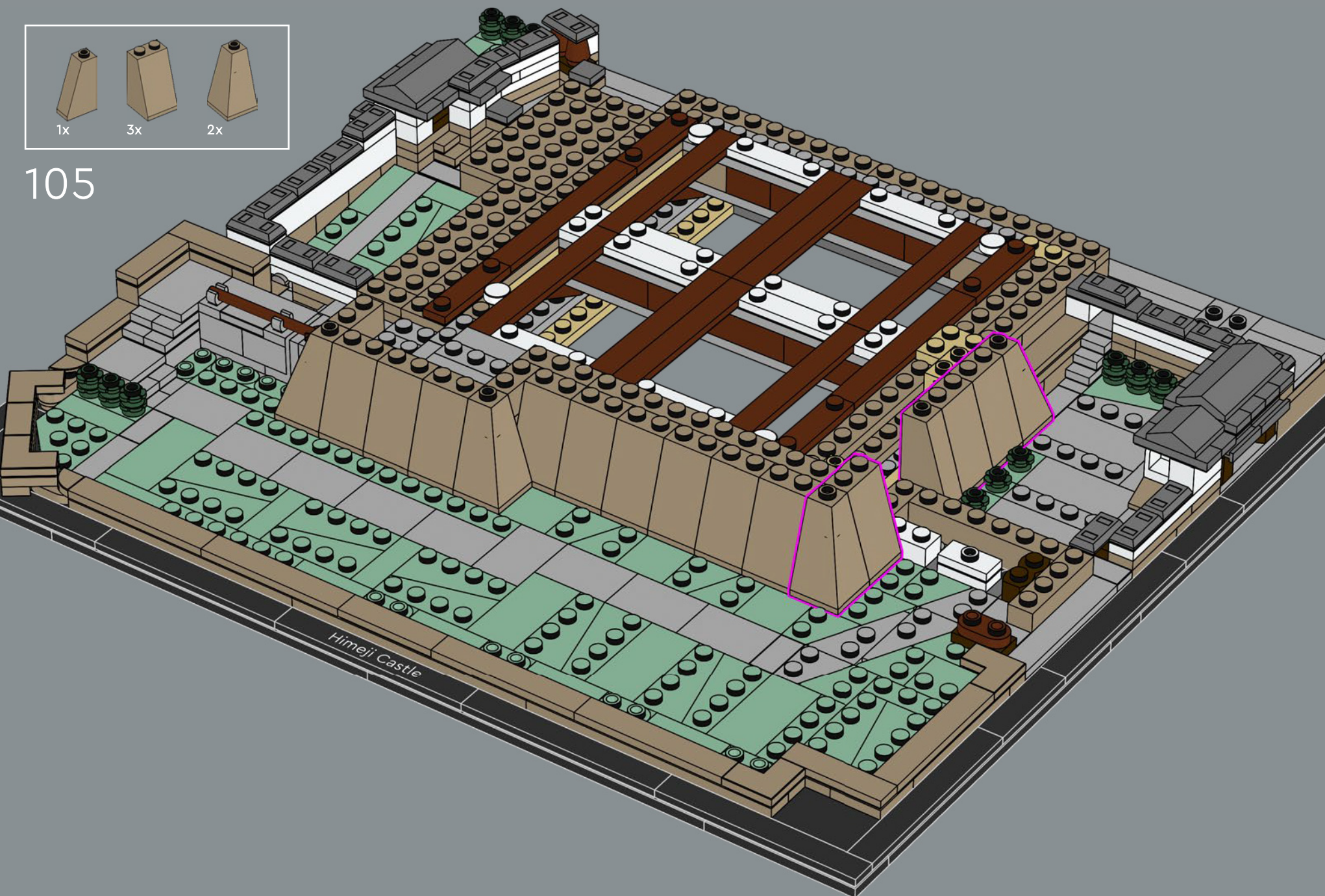

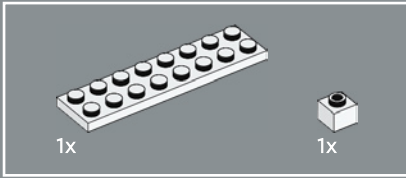
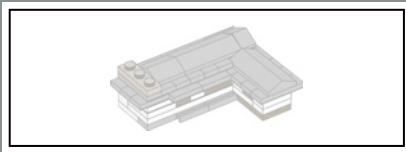

106

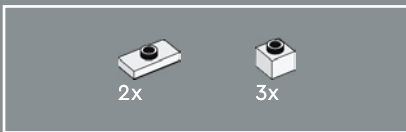
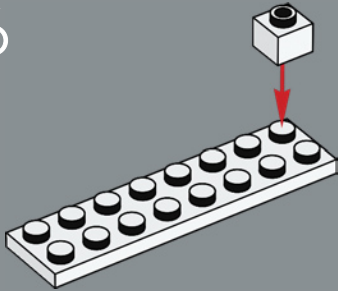

107

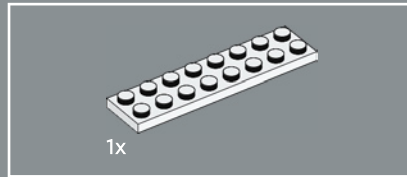
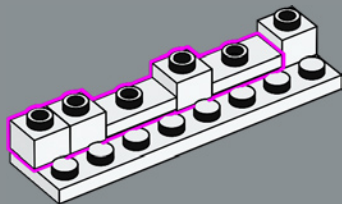

108

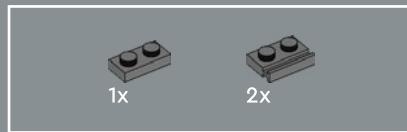
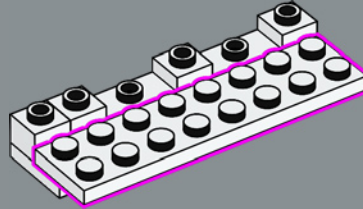

109

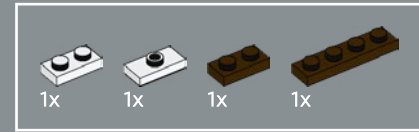
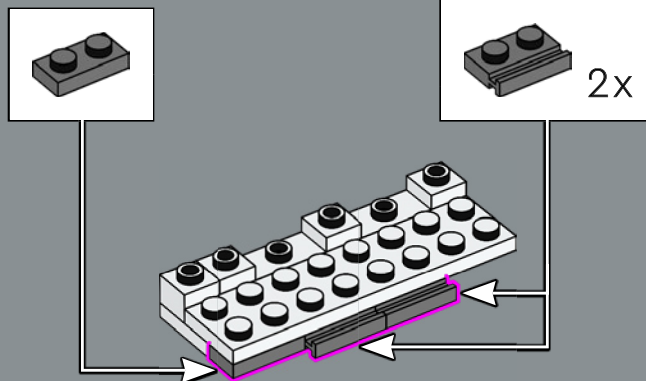

110

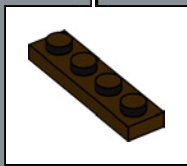
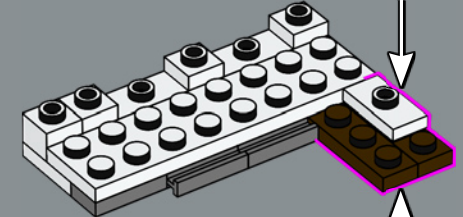
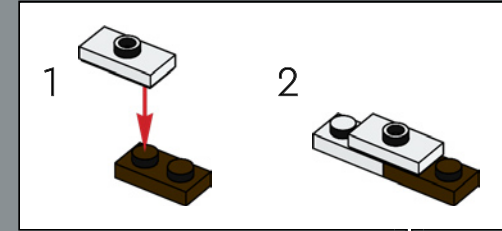

111

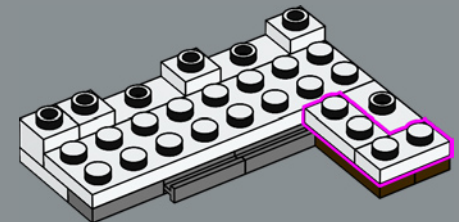

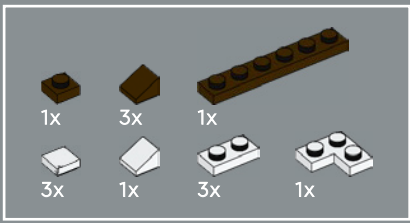

112

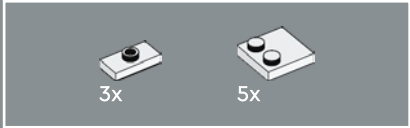
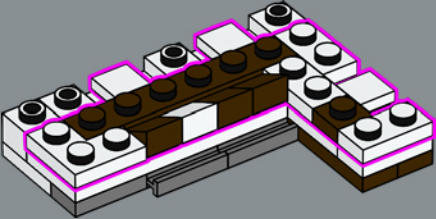

113

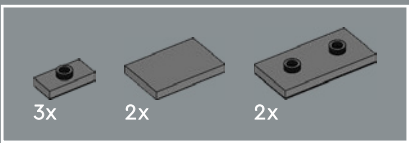
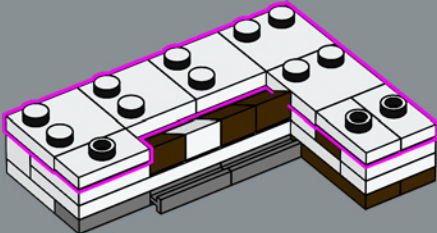

114

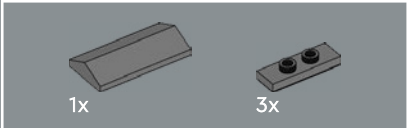
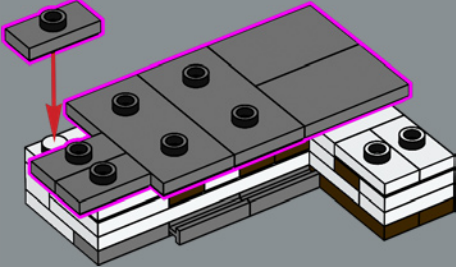

115

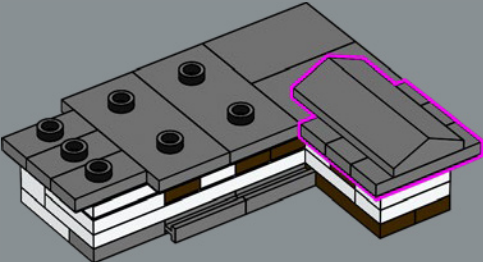
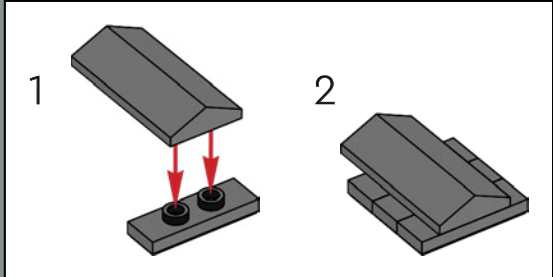

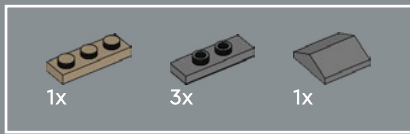

116

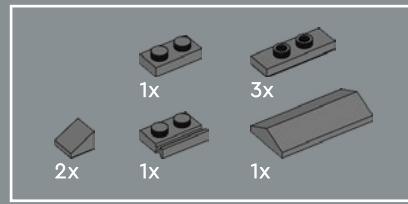
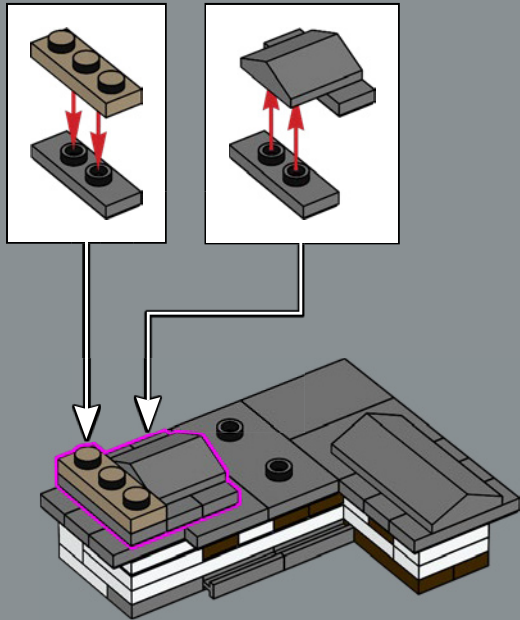

117

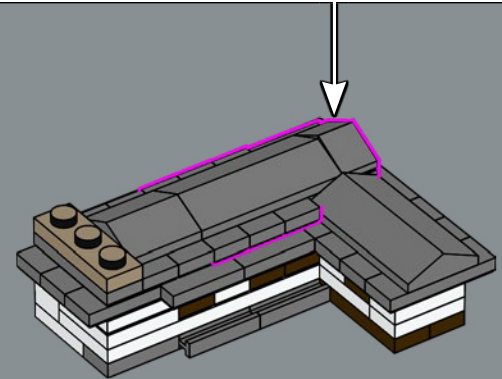
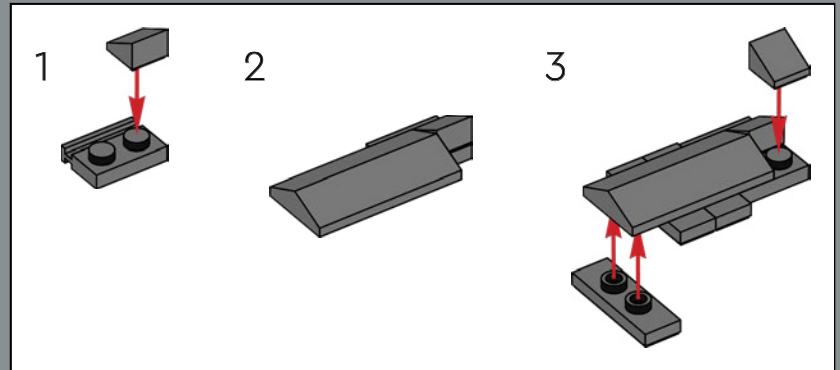

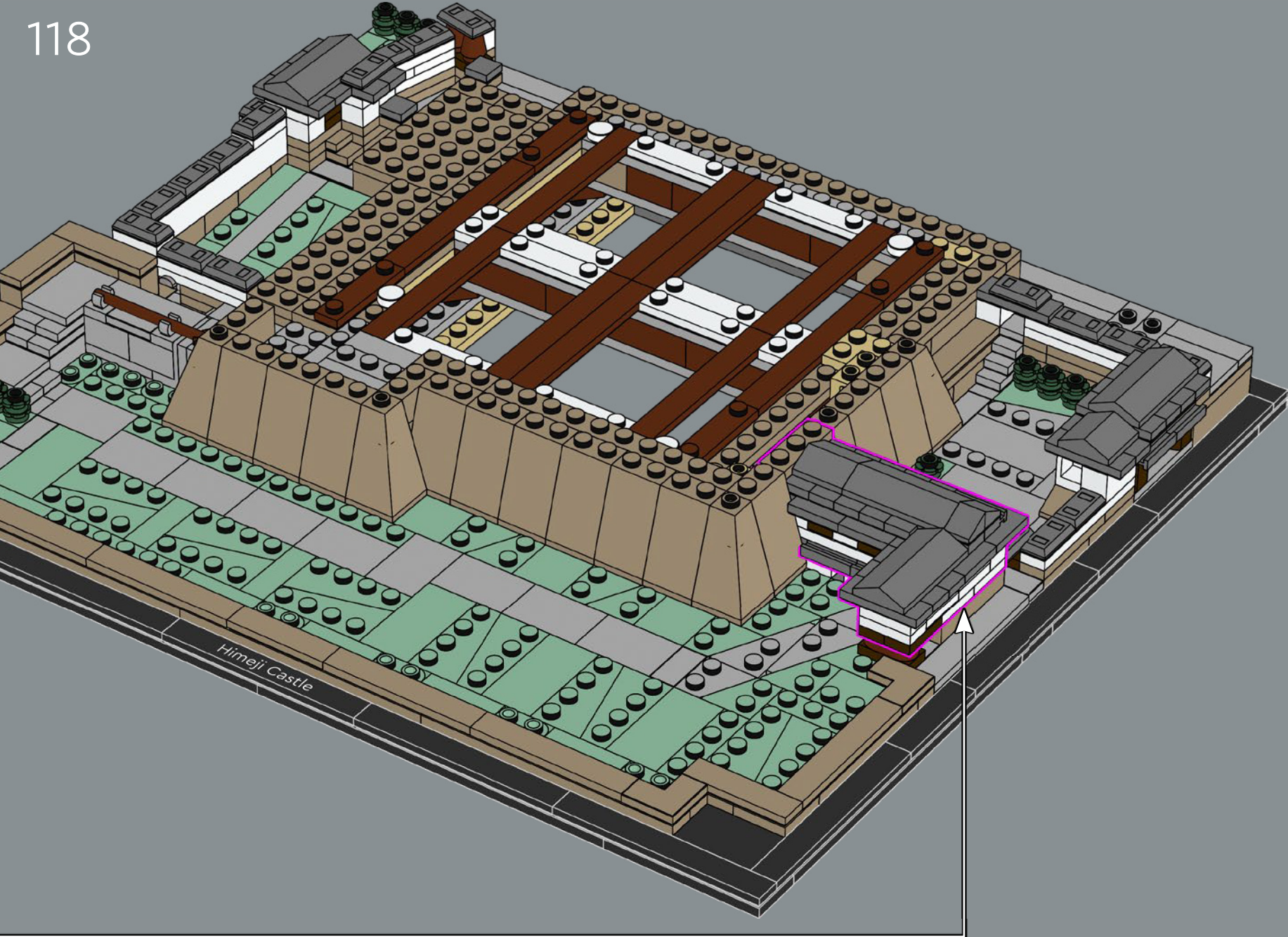

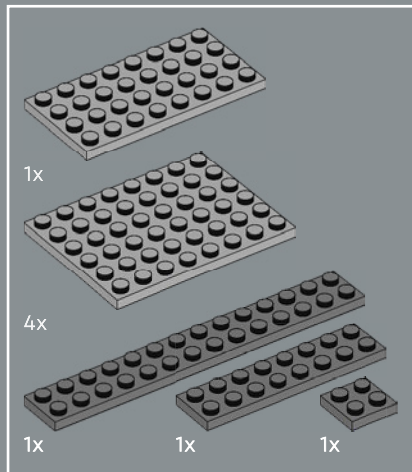

119

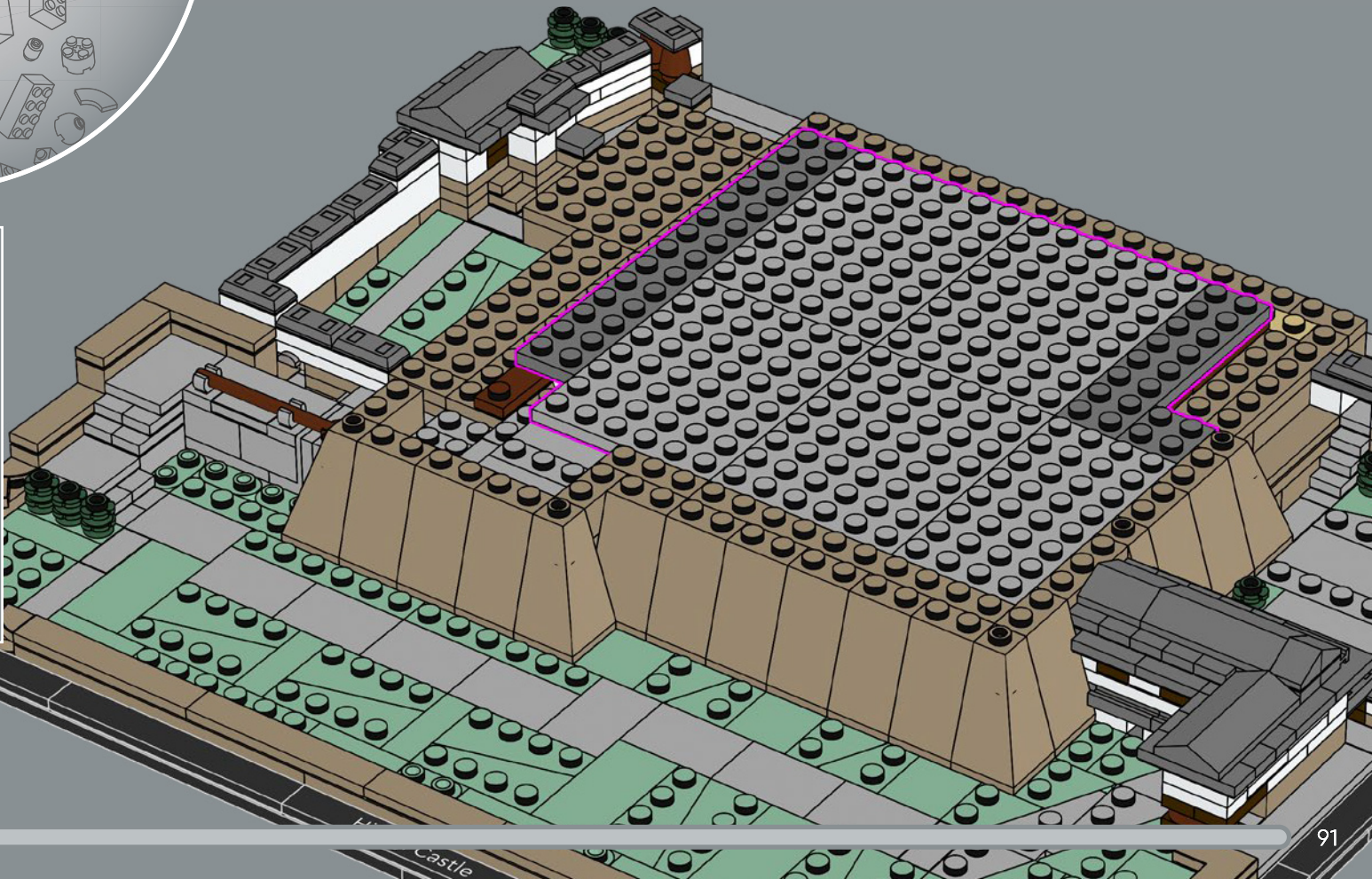

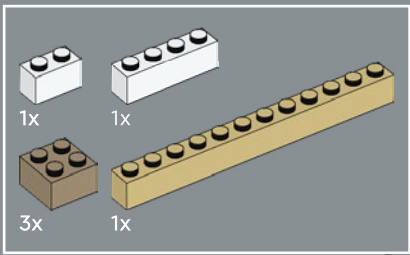

120

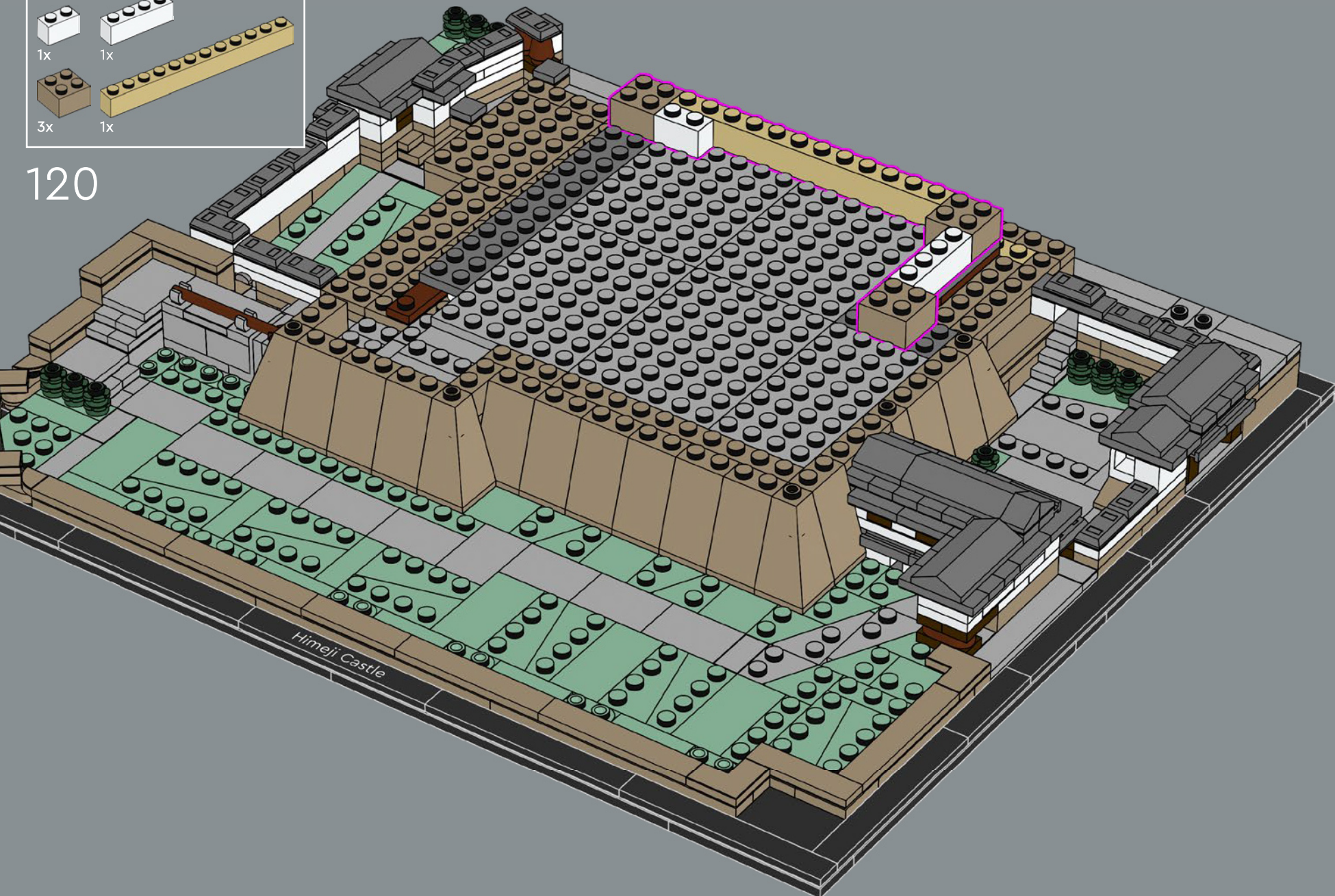

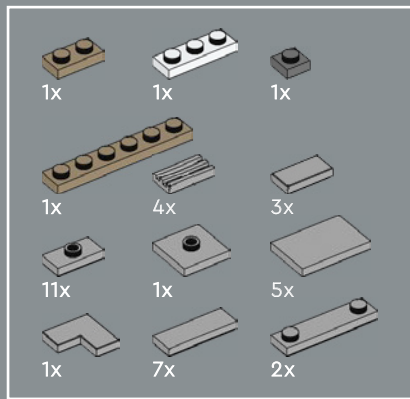

121

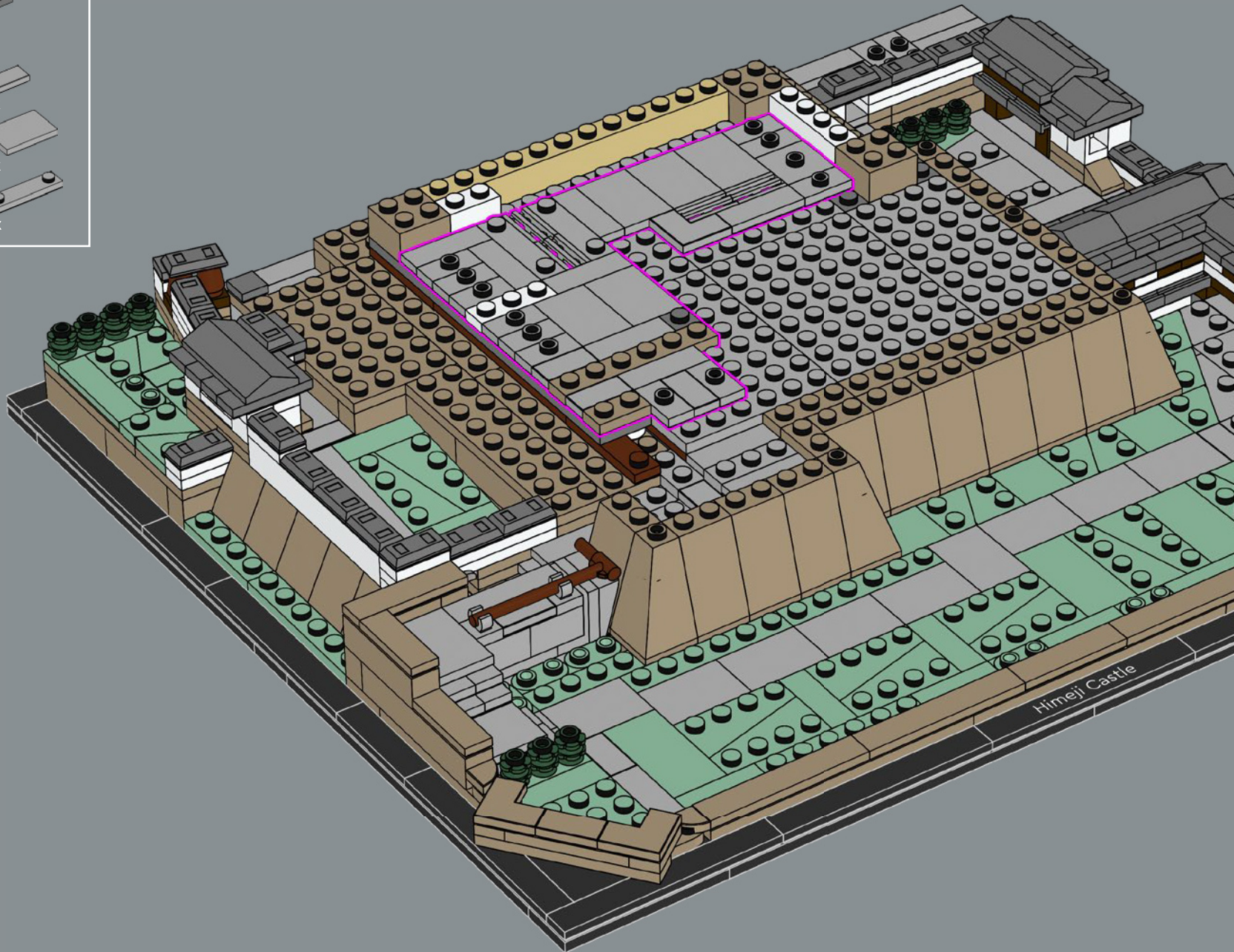

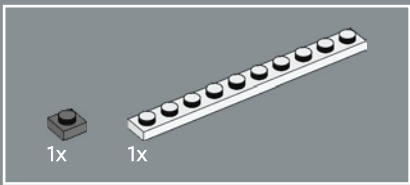

122

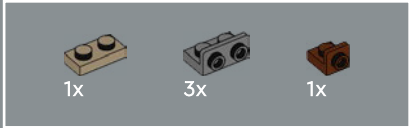
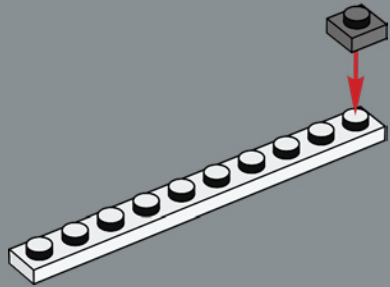

123

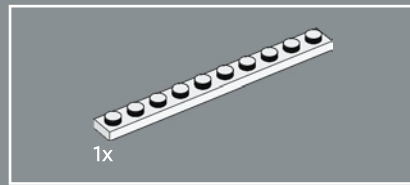
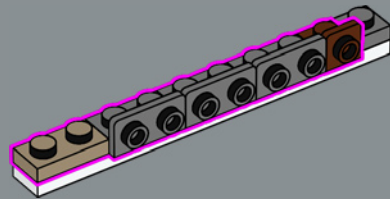

124

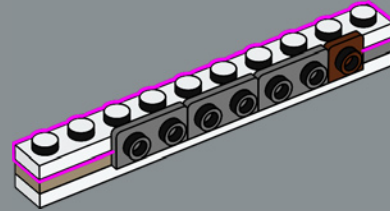

125

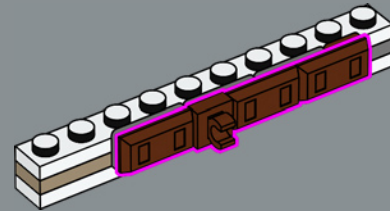

126

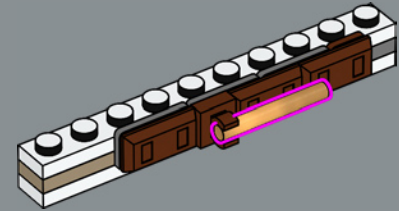

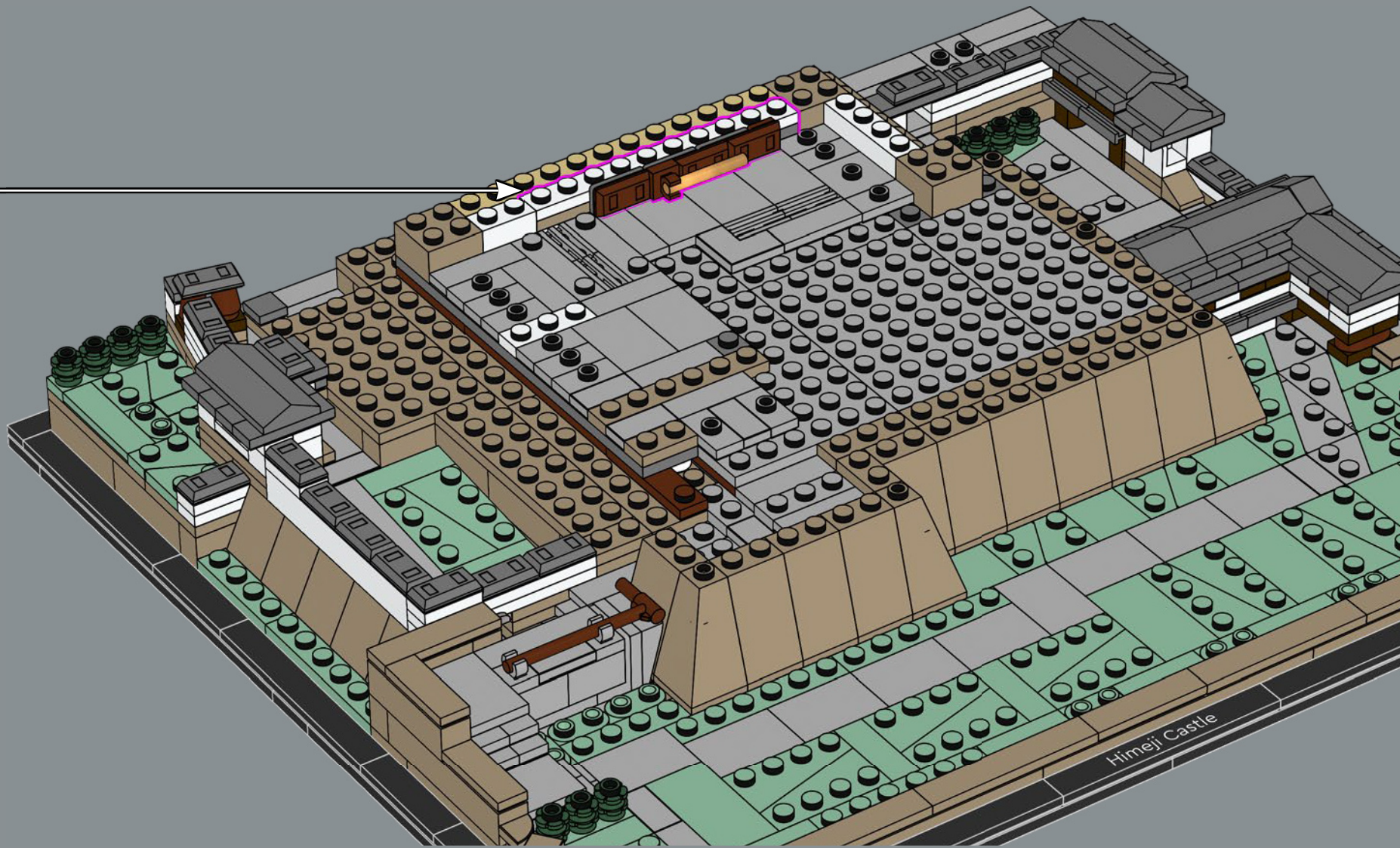

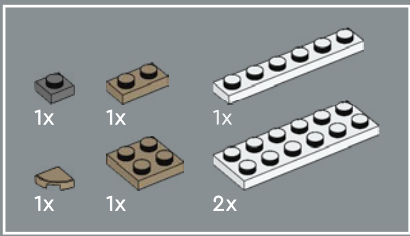

128

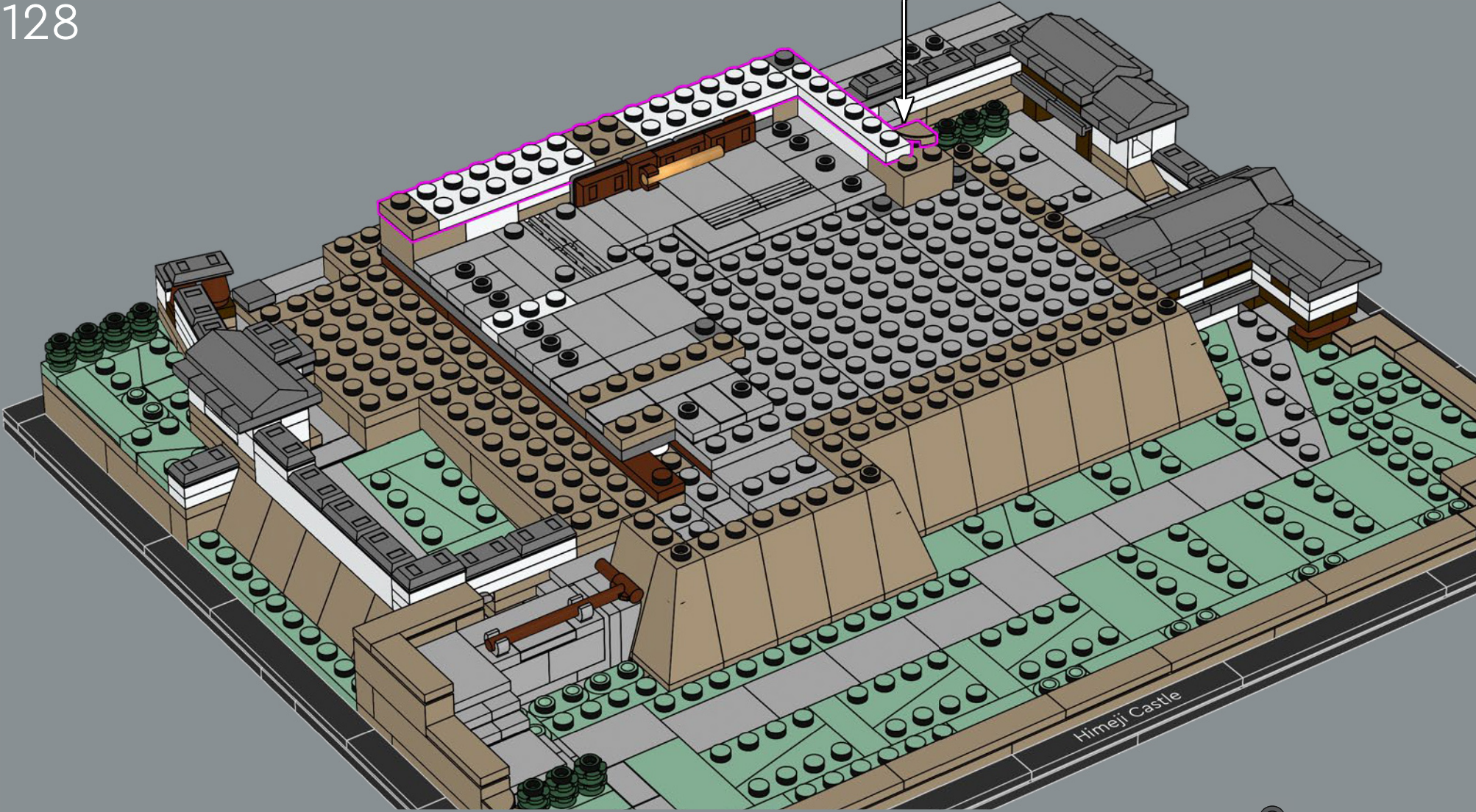

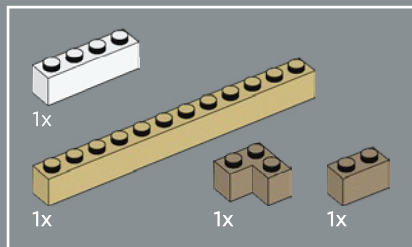

129

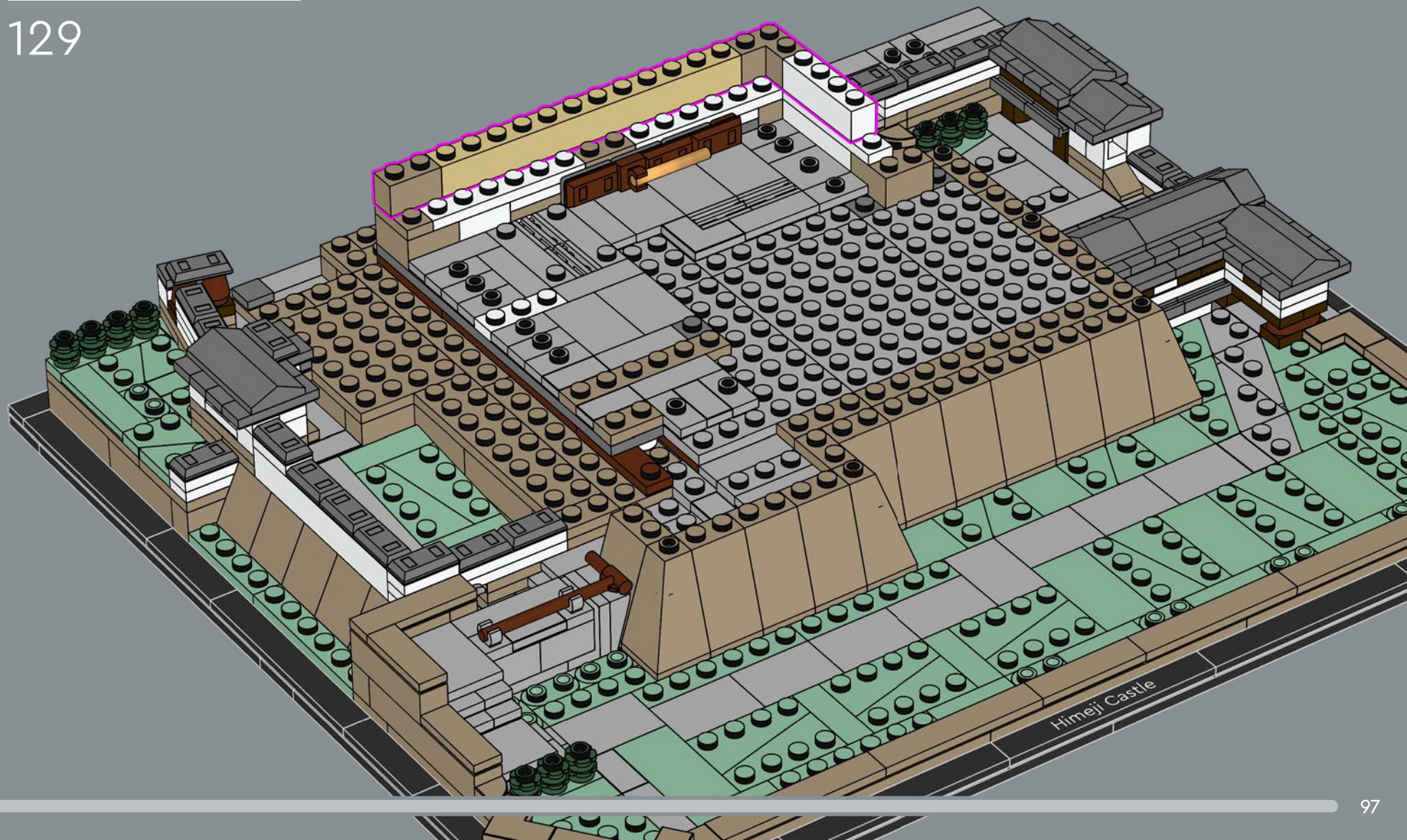

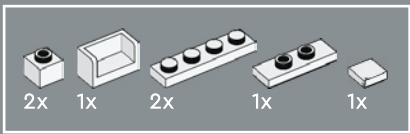

130

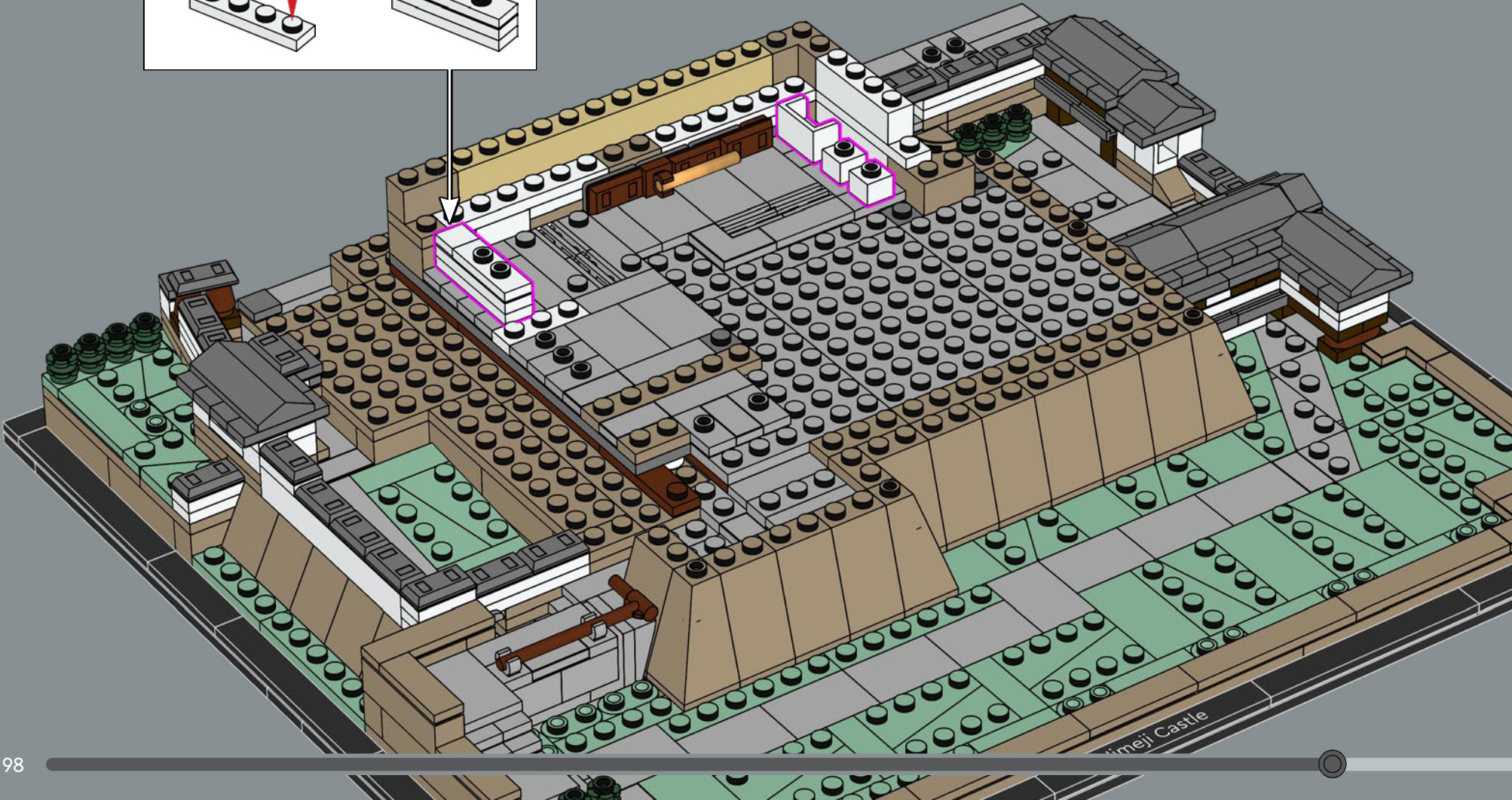
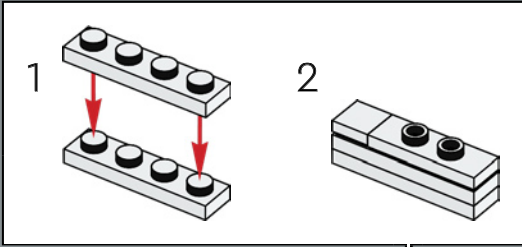

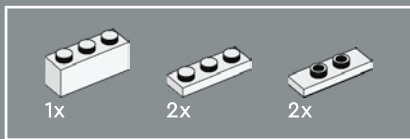

131

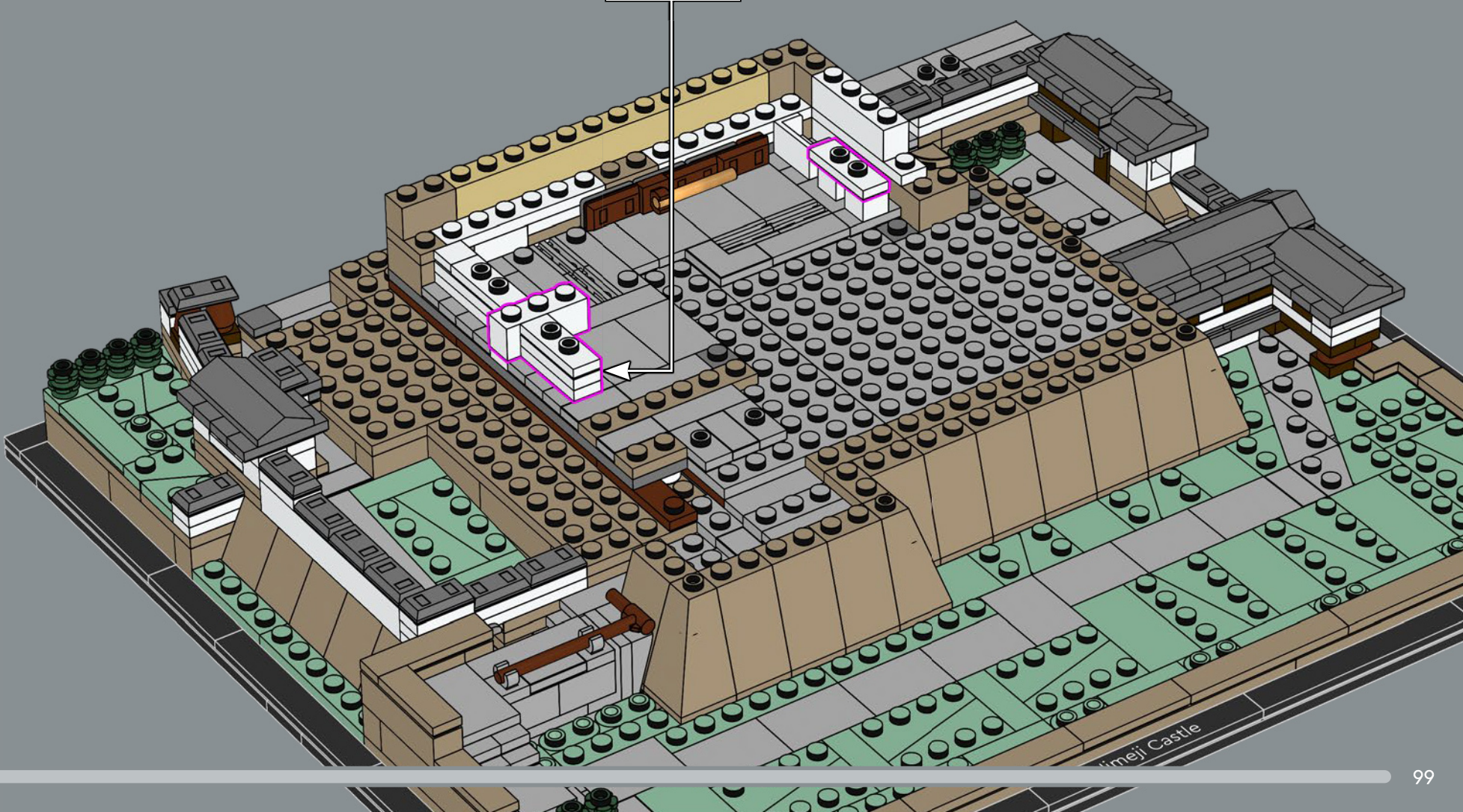
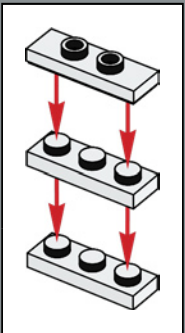

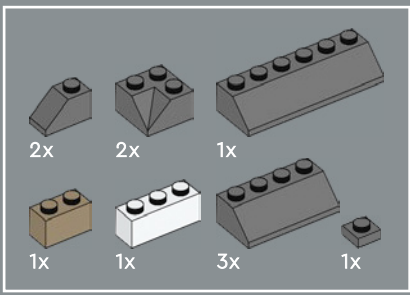

132

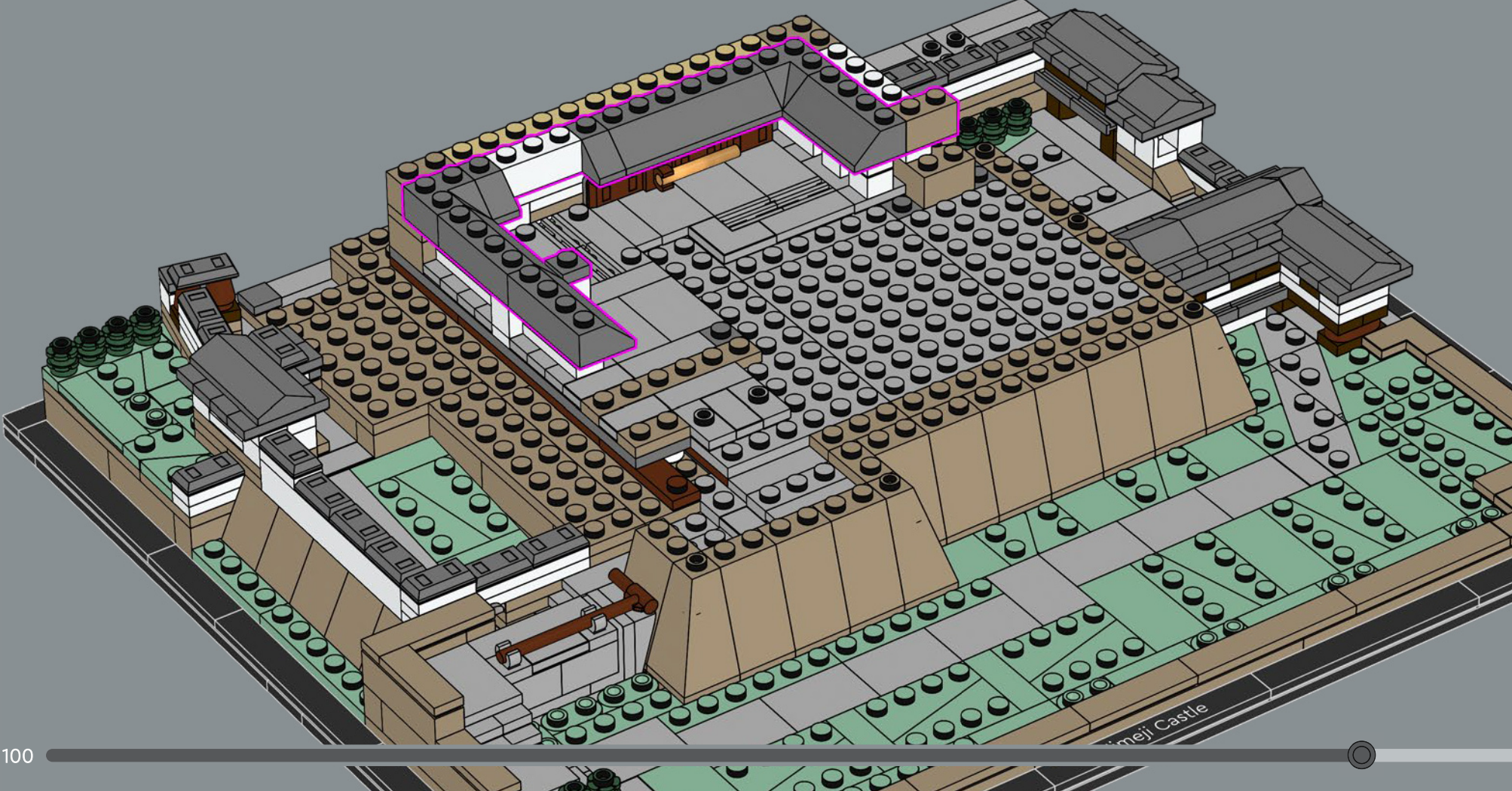

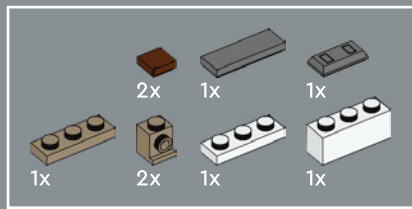

133

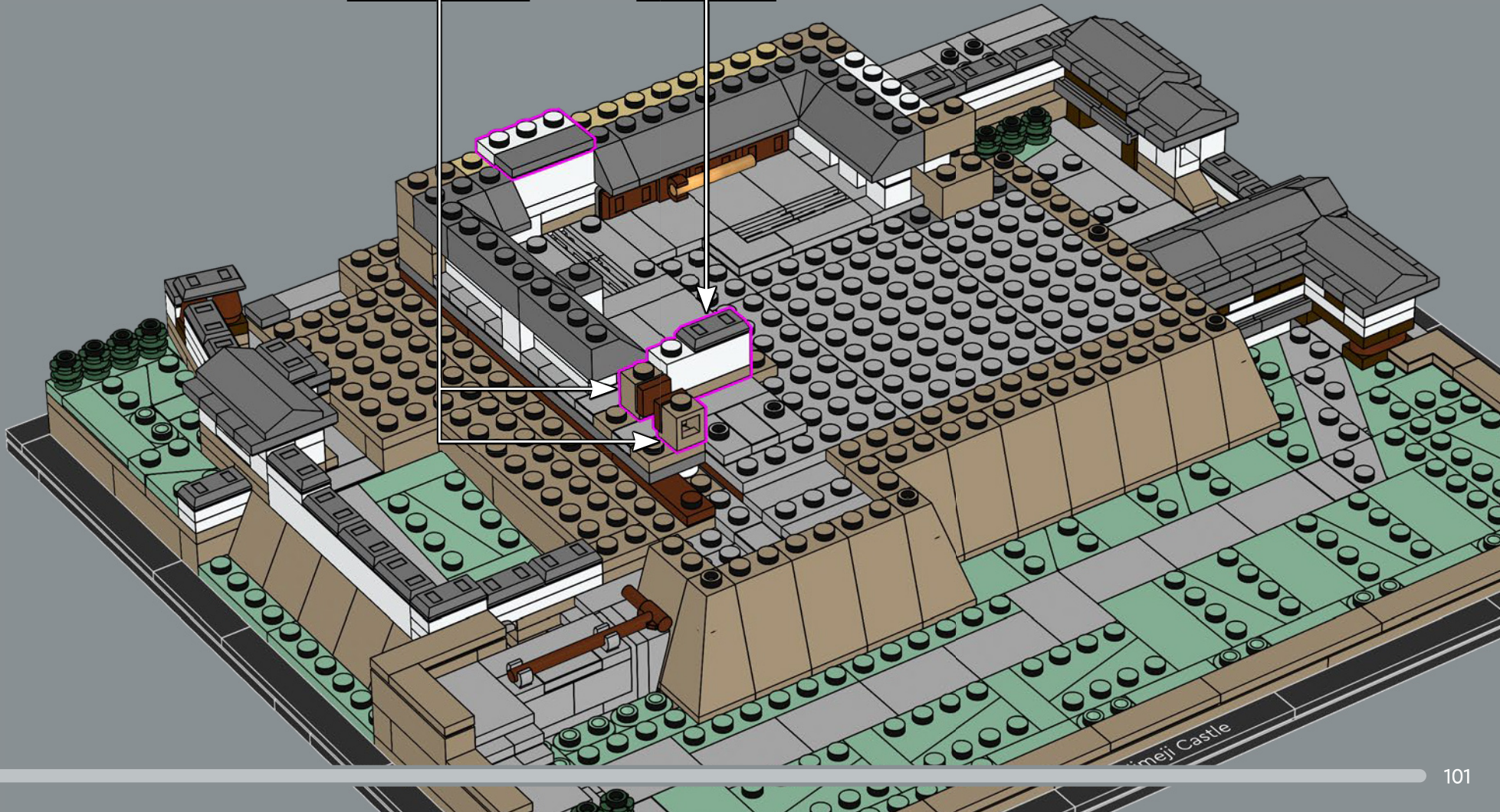
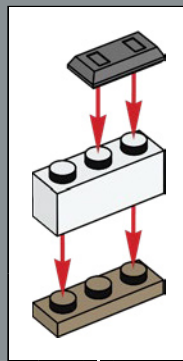
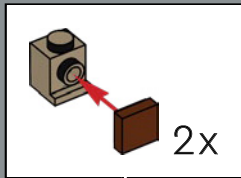

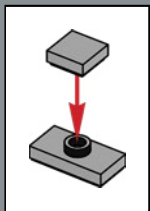
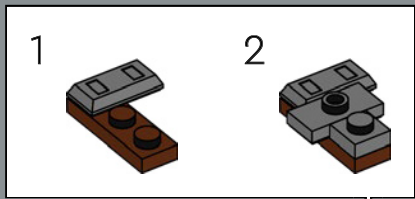
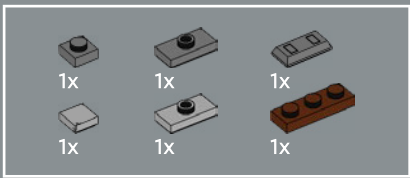

134

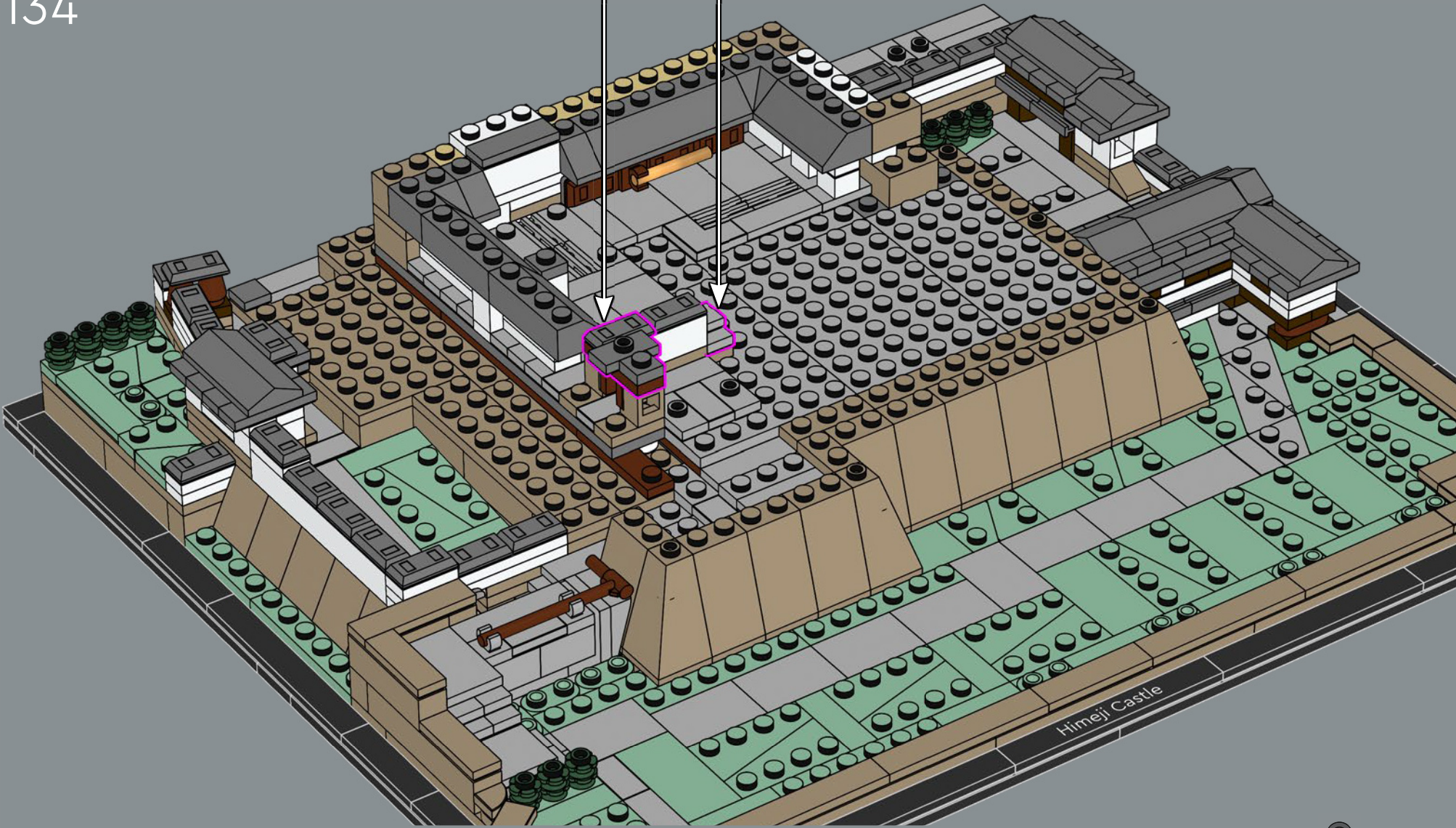

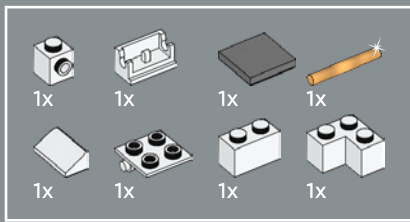

135

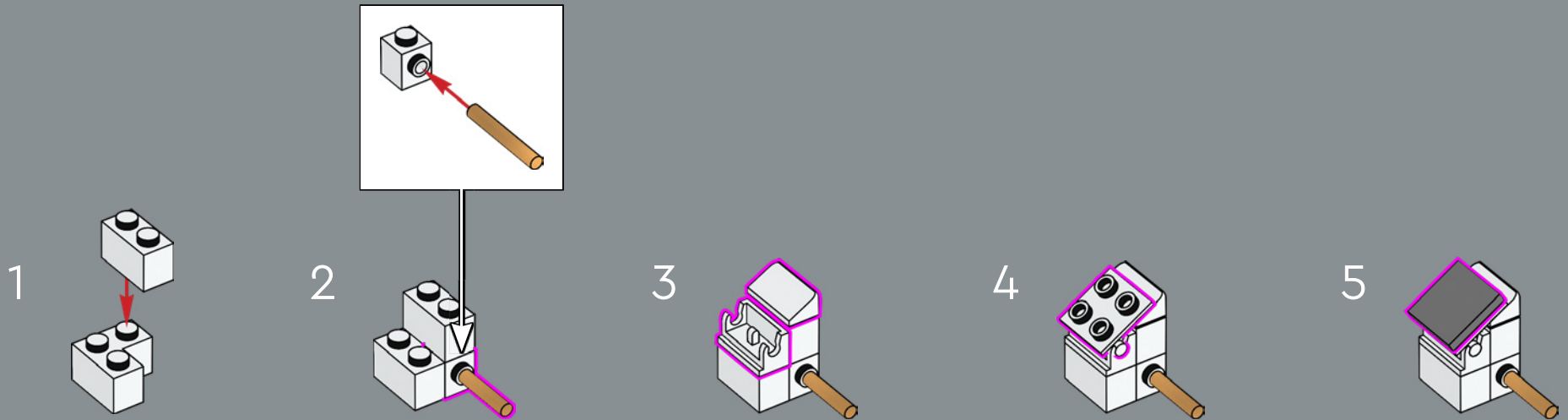

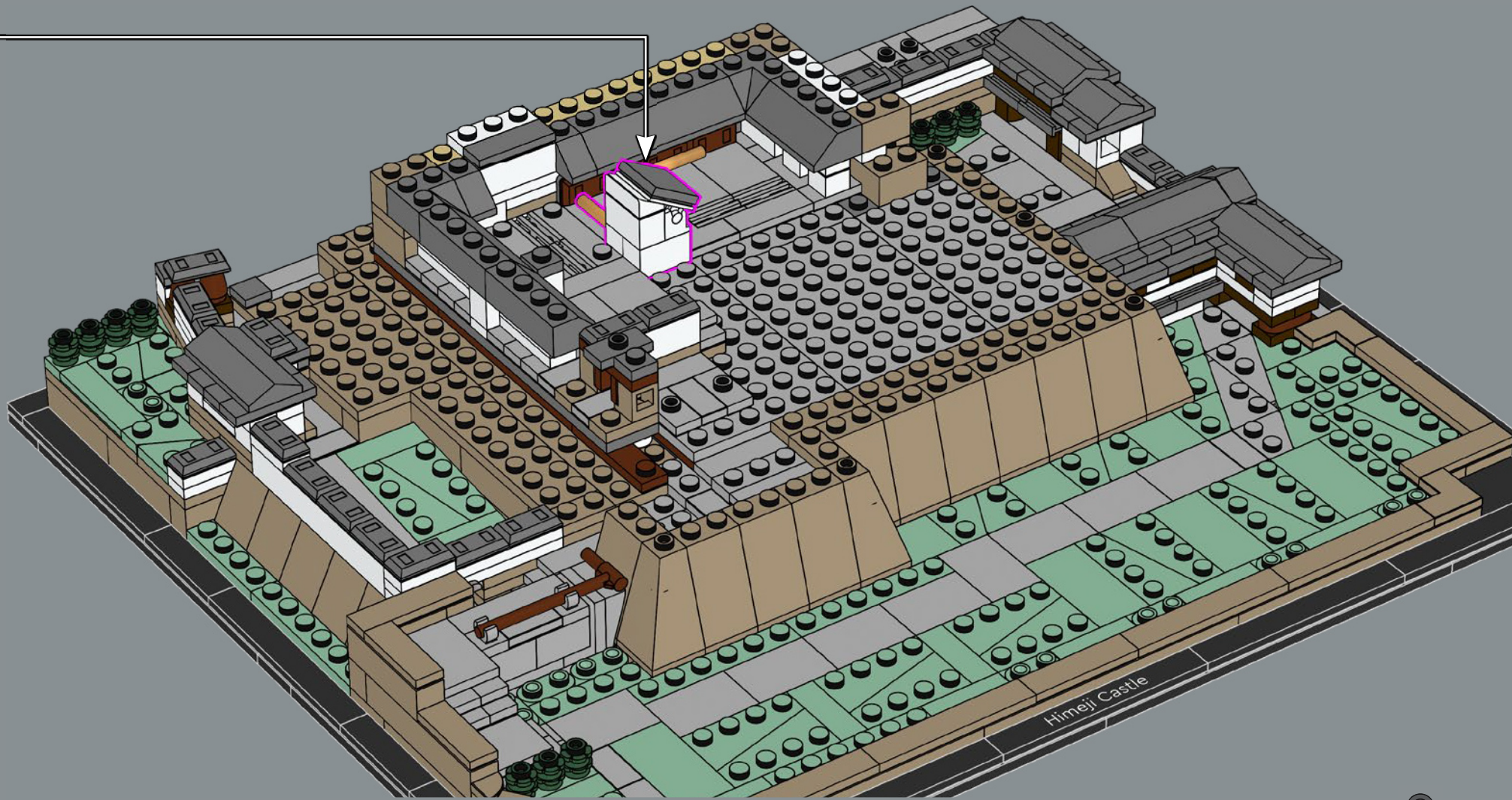

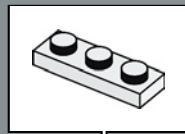
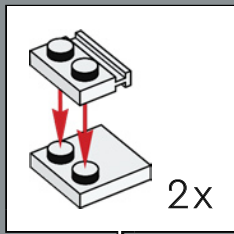
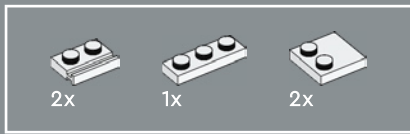

136

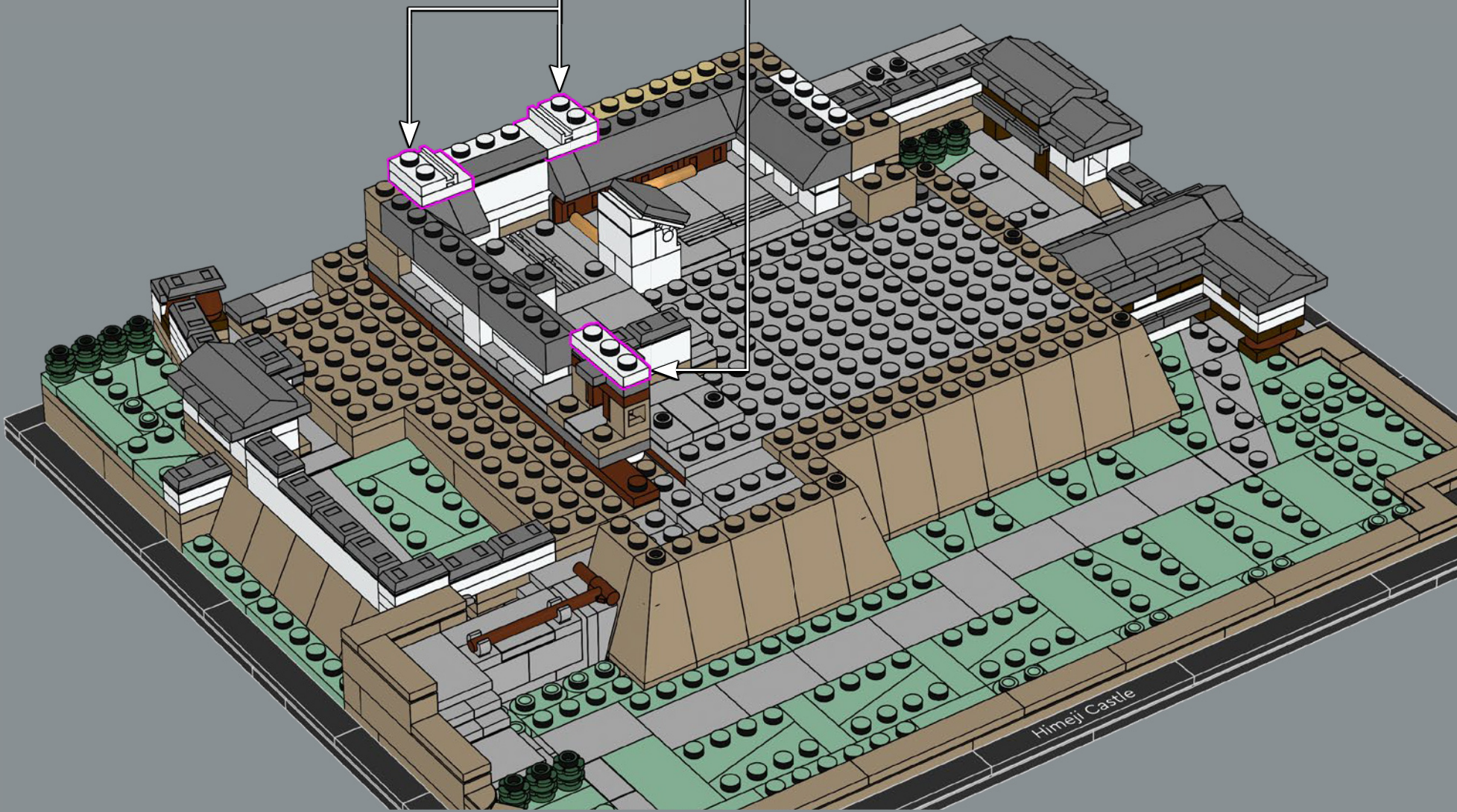

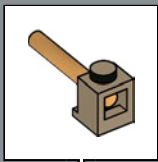
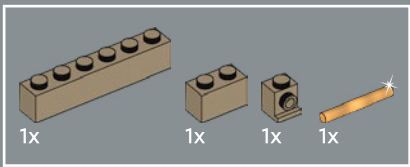

137

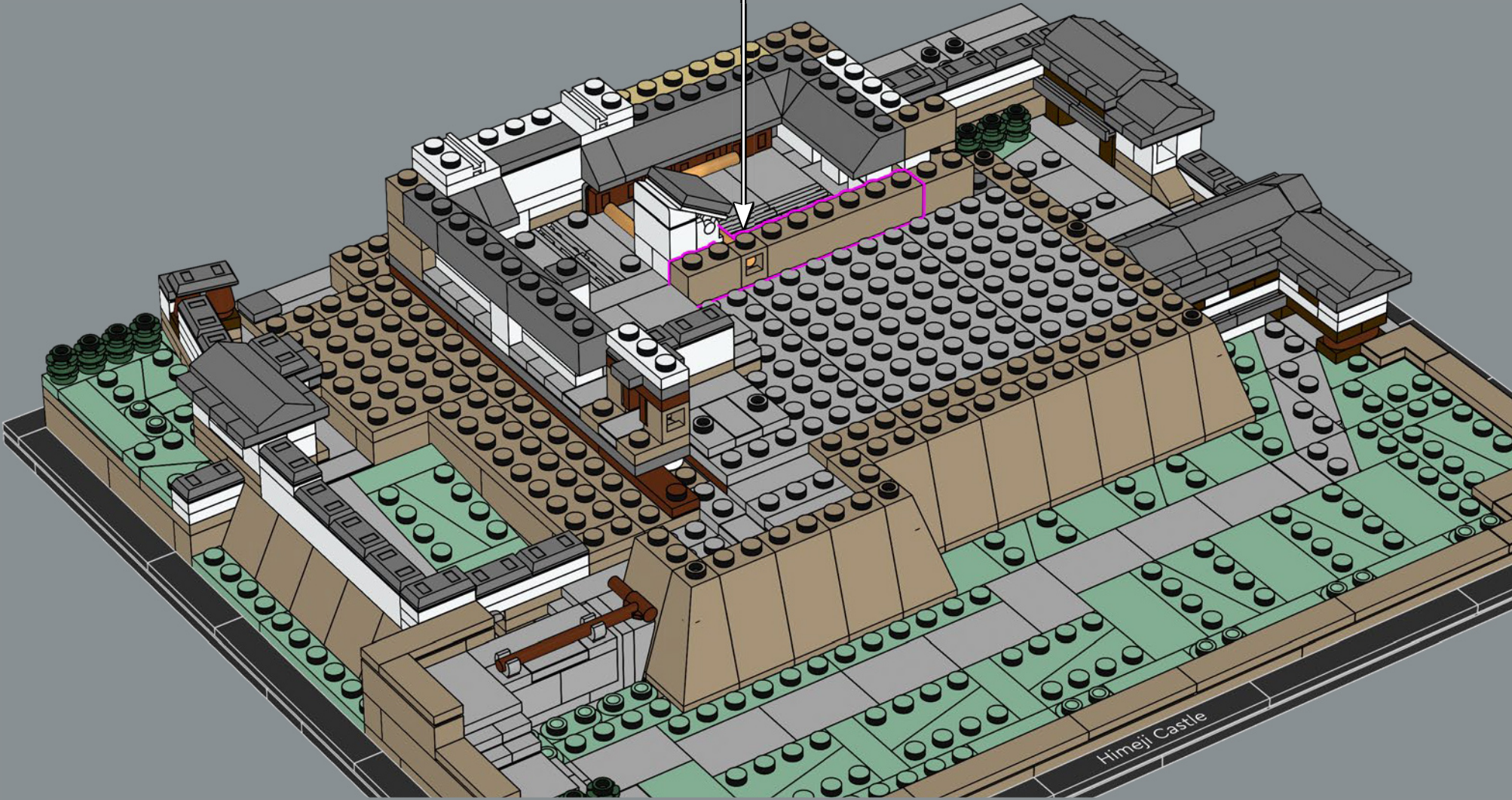

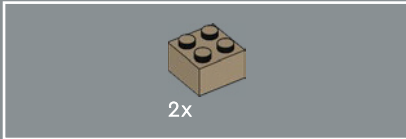
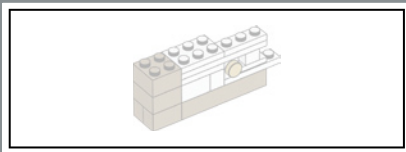

138

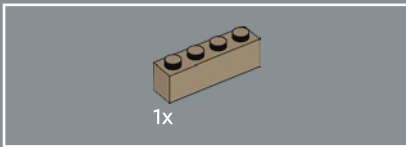
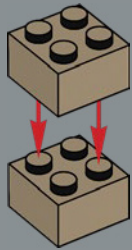

139

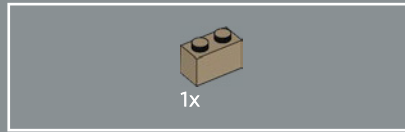
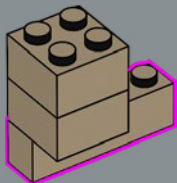

140

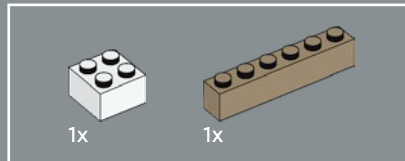
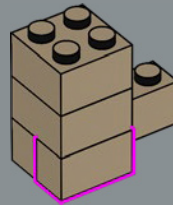

141

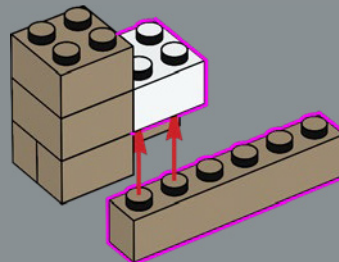

142

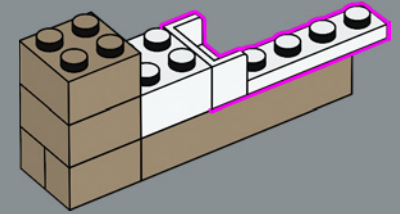

143

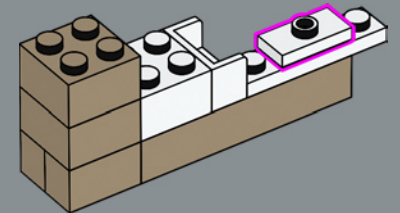

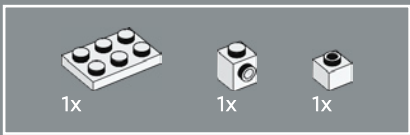

144

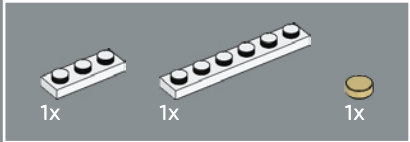
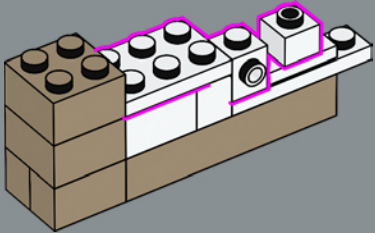

145

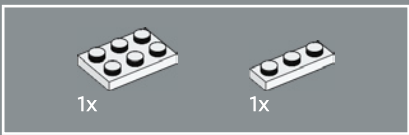
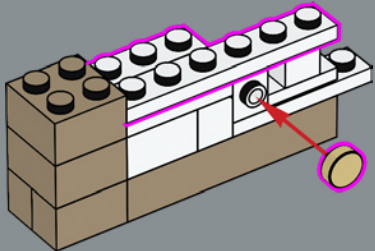

146

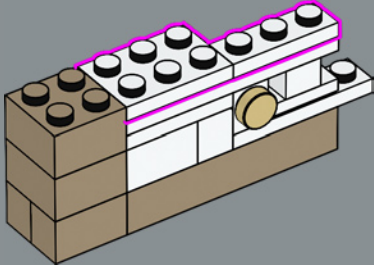

147

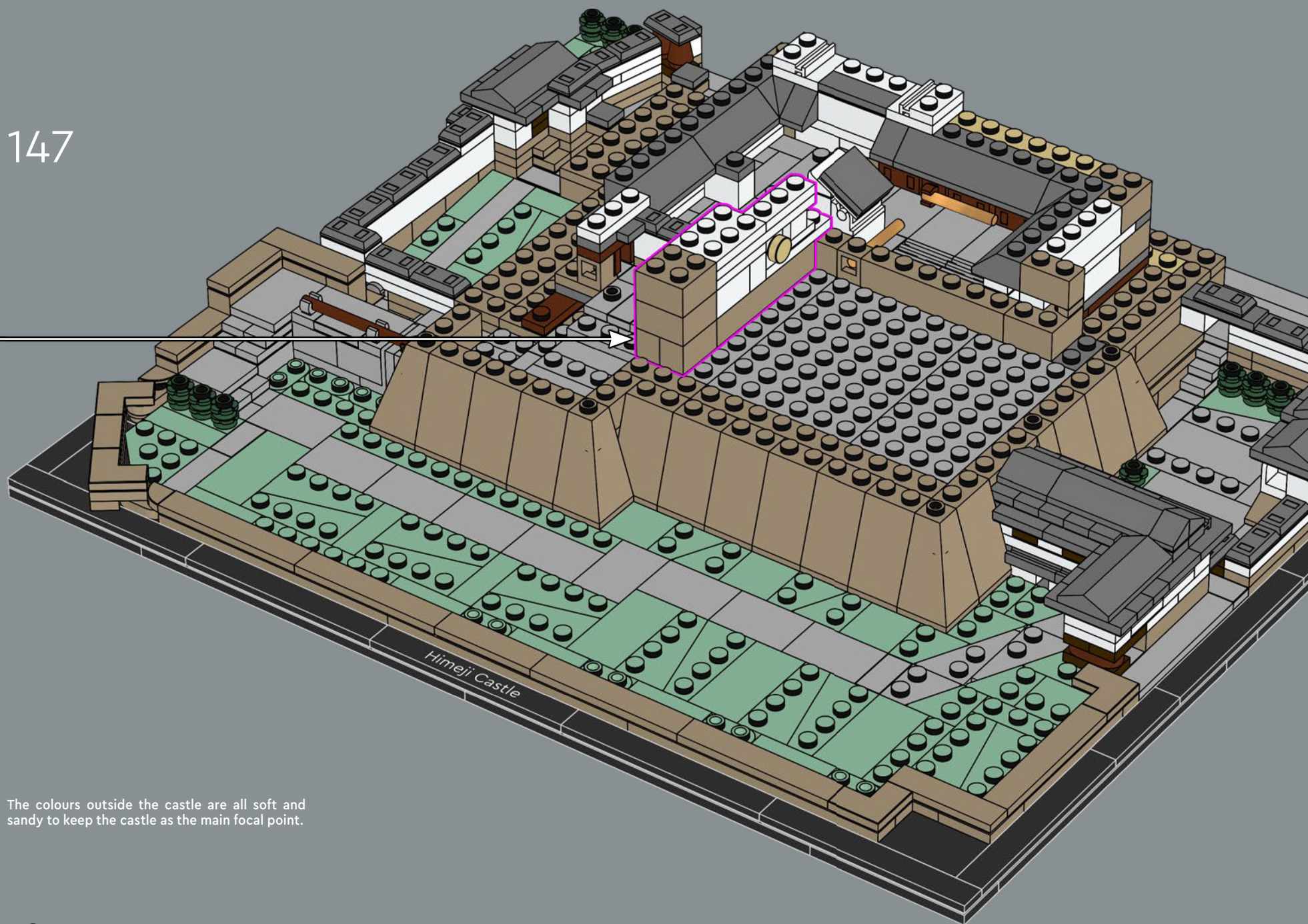

The colours outside the castle are all soft and sandy to keep the castle as the main focal point.



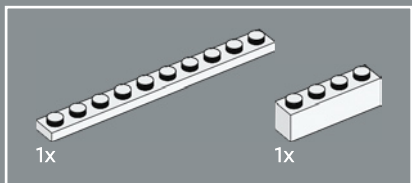

148

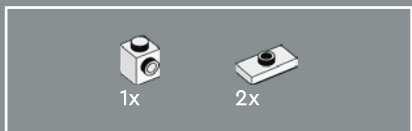
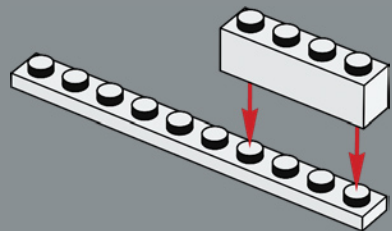

149

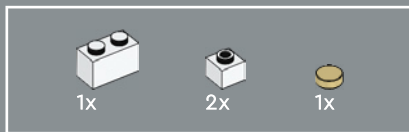
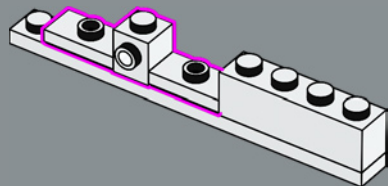

150

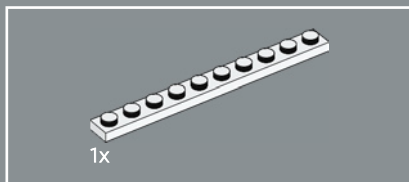
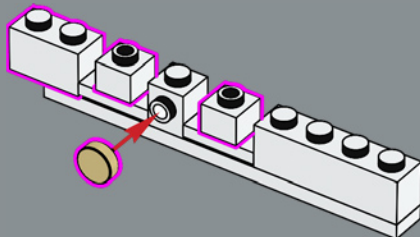

151

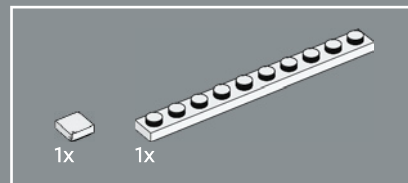
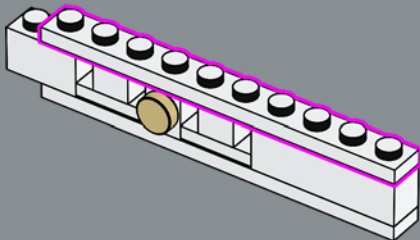

152

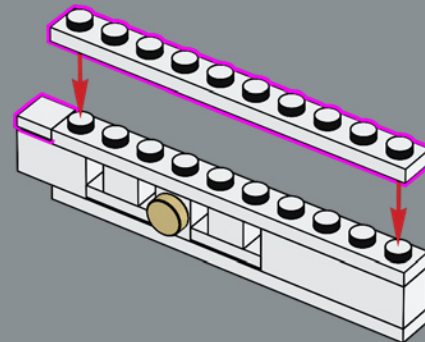

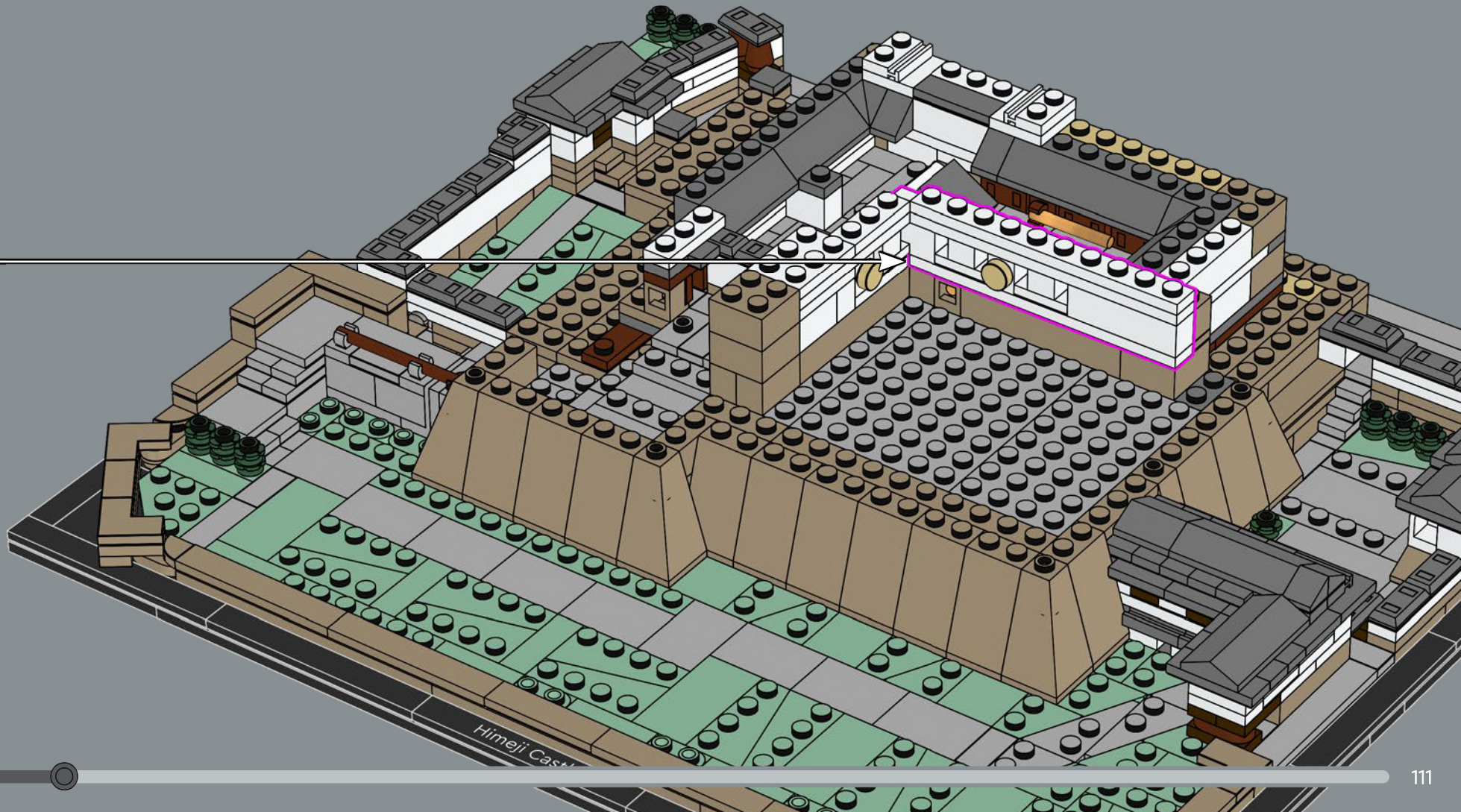

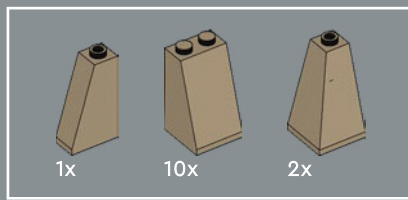

154

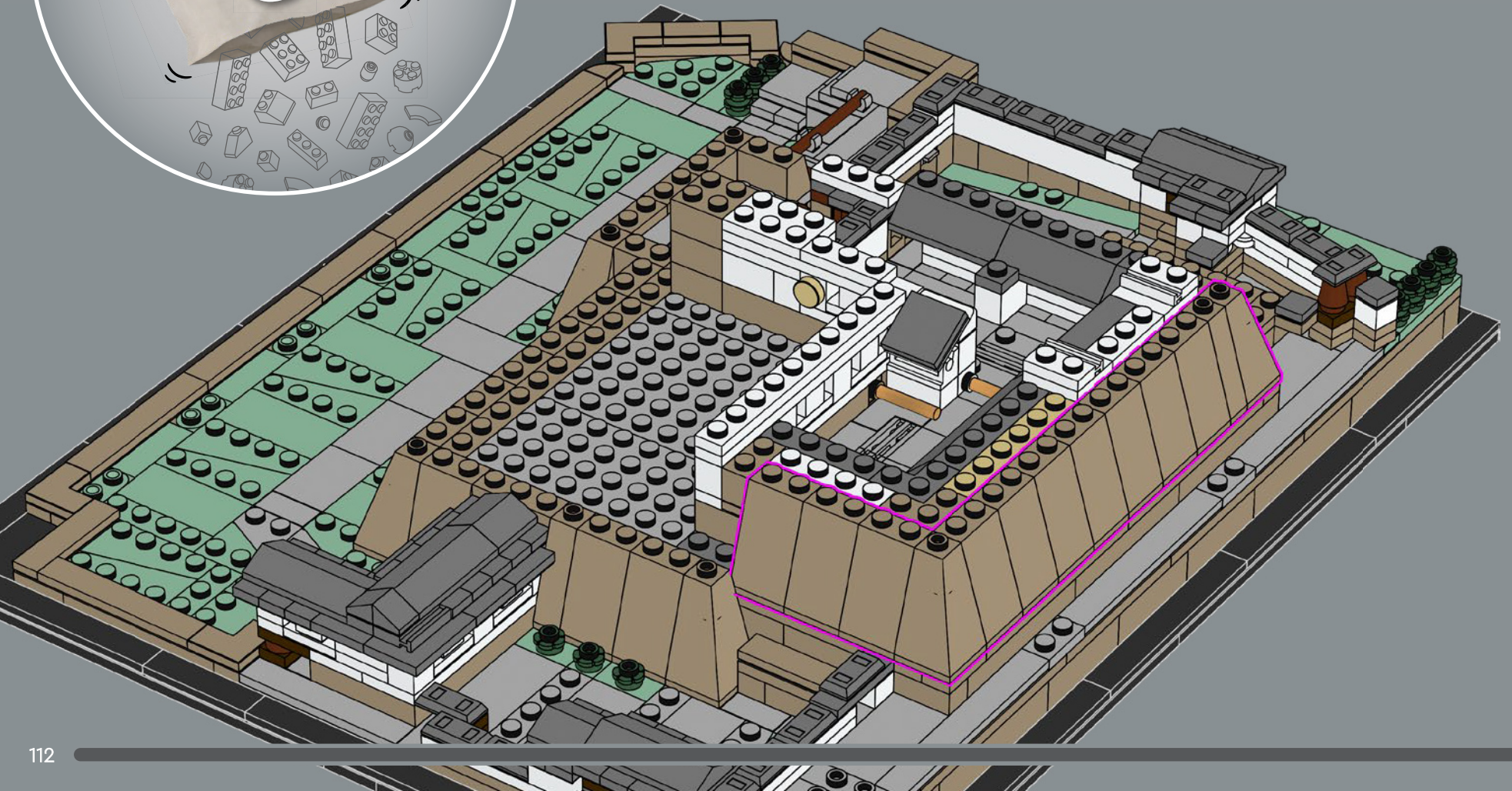

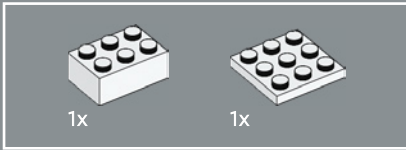

155

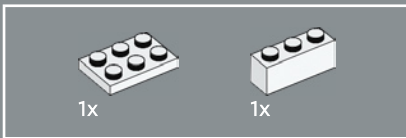
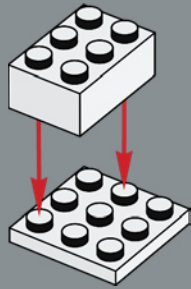

156

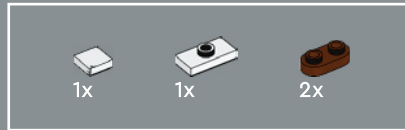
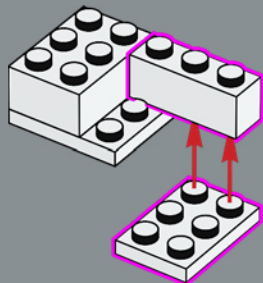

157

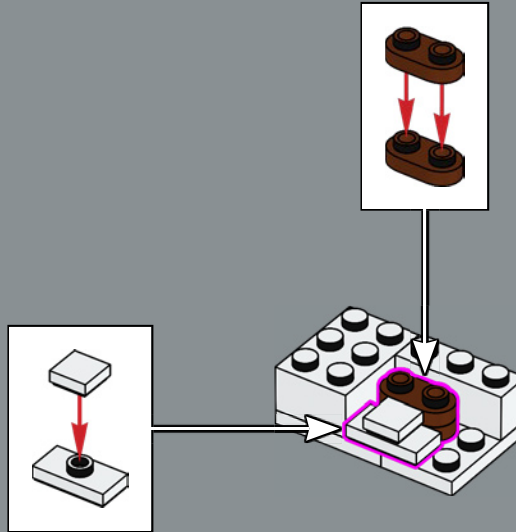

158

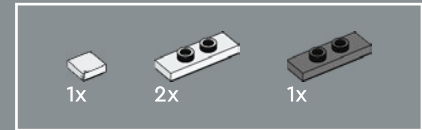
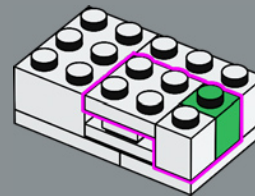

159

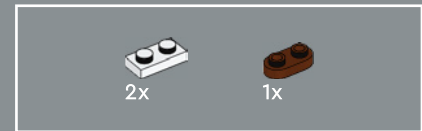
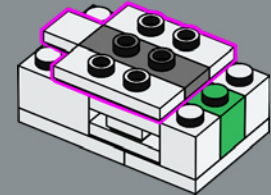

160

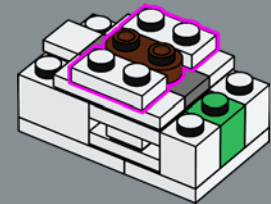

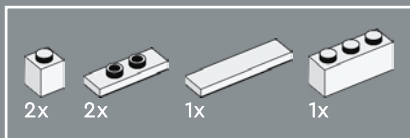

161

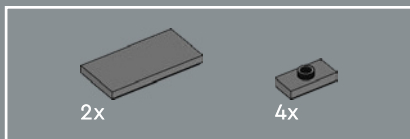
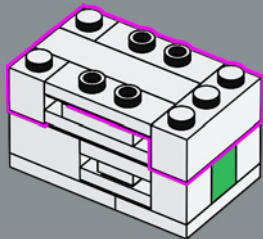

162

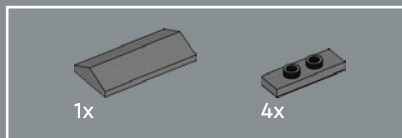
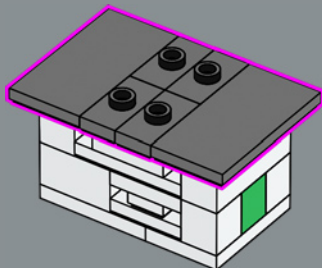

163

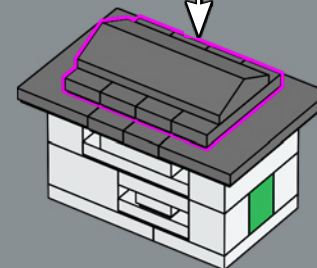
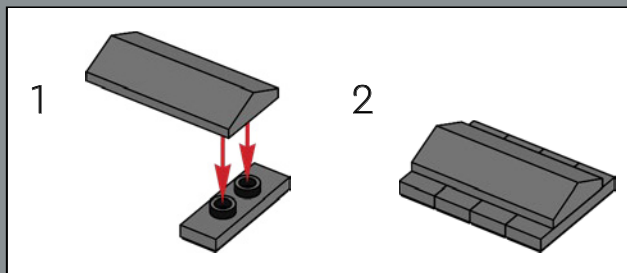

164



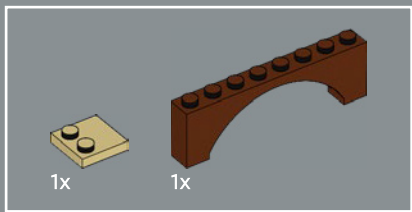

165

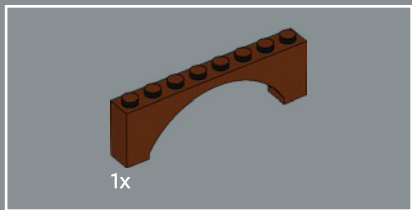
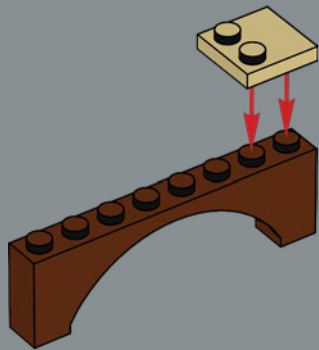

166

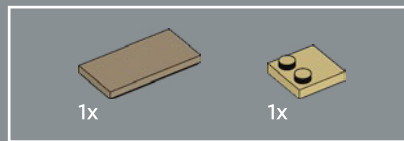
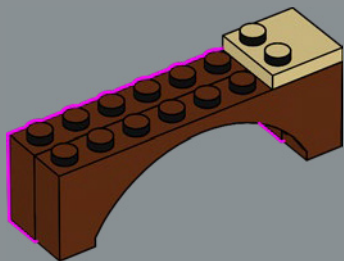

167

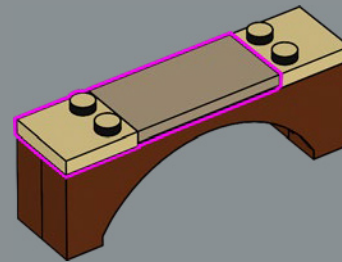

168

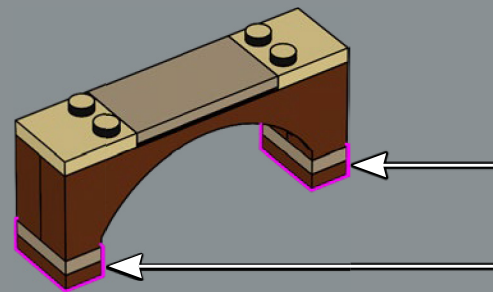
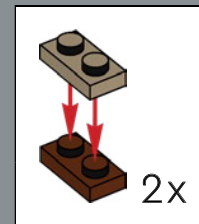

169

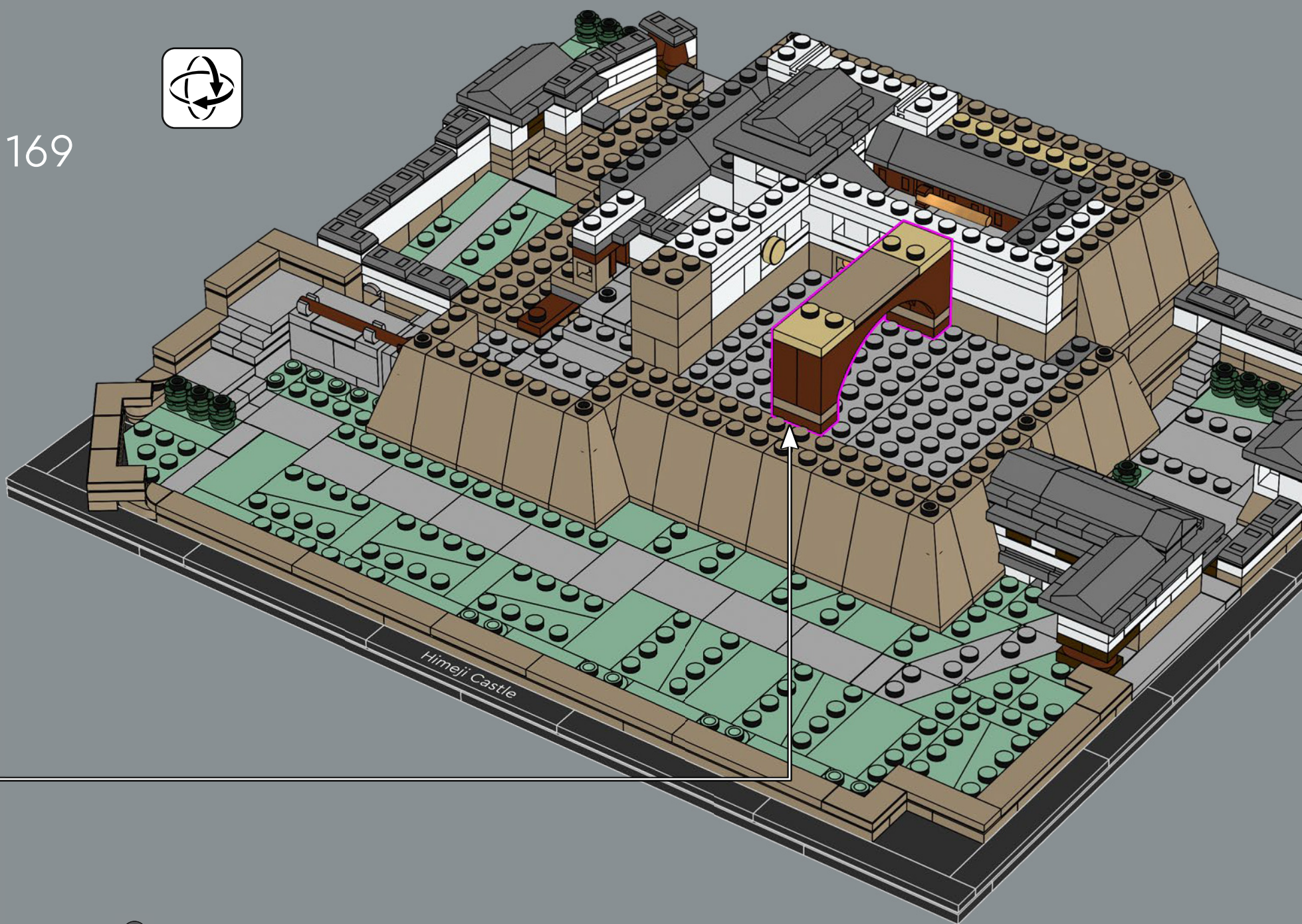

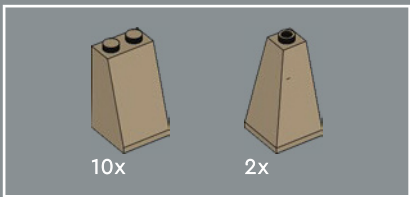

170

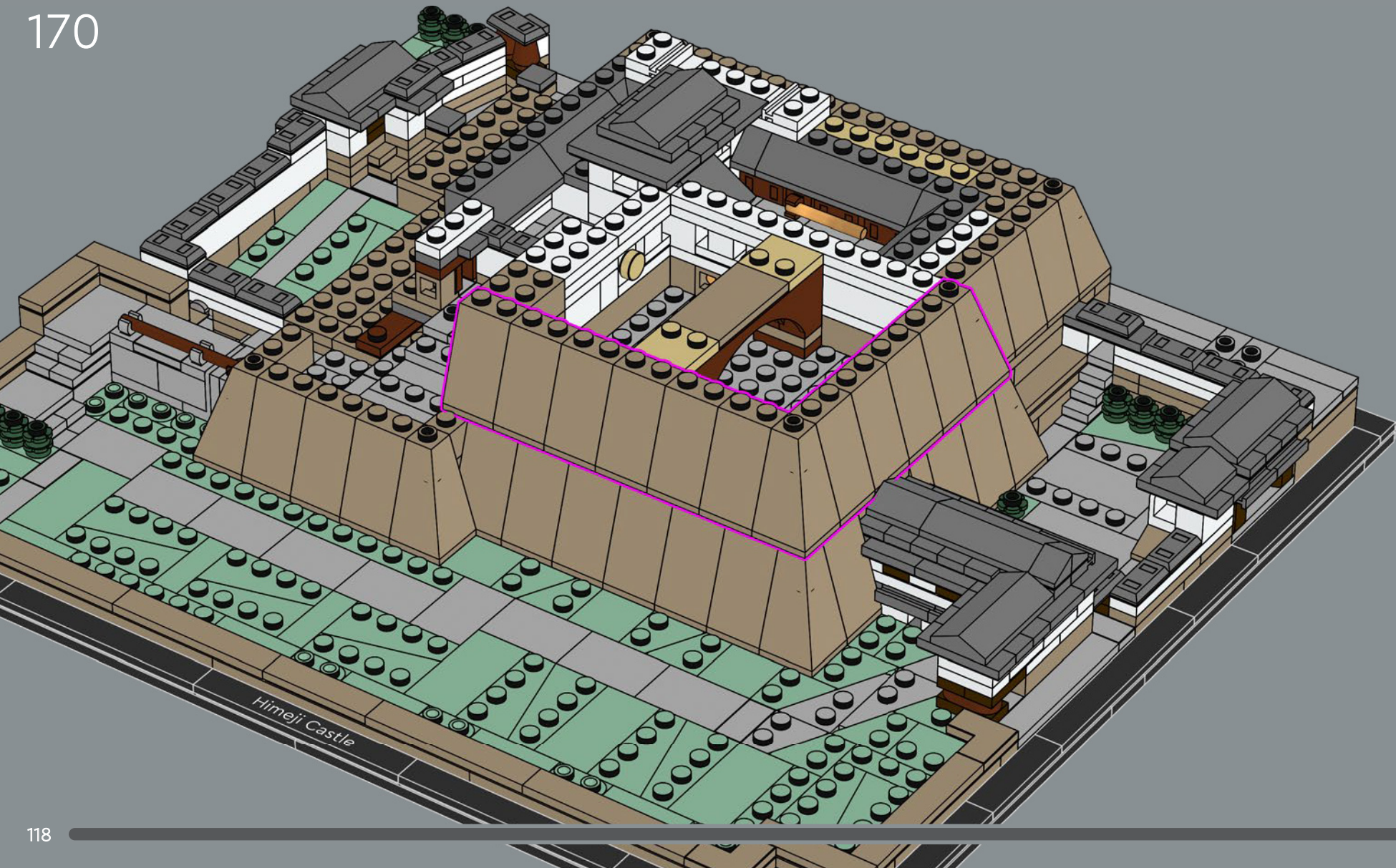

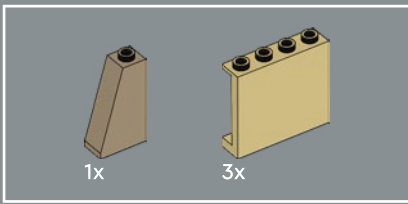

171



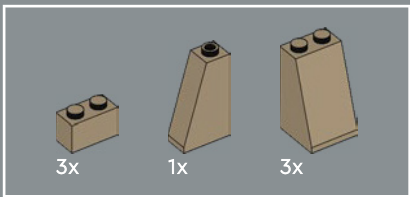

172

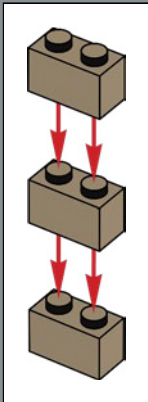

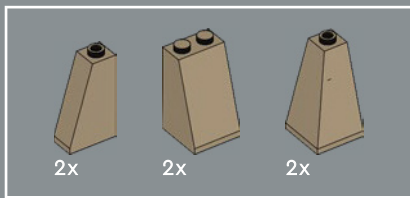

173



Himeji Castle

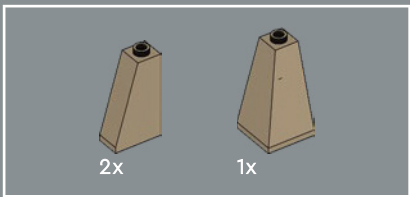

174

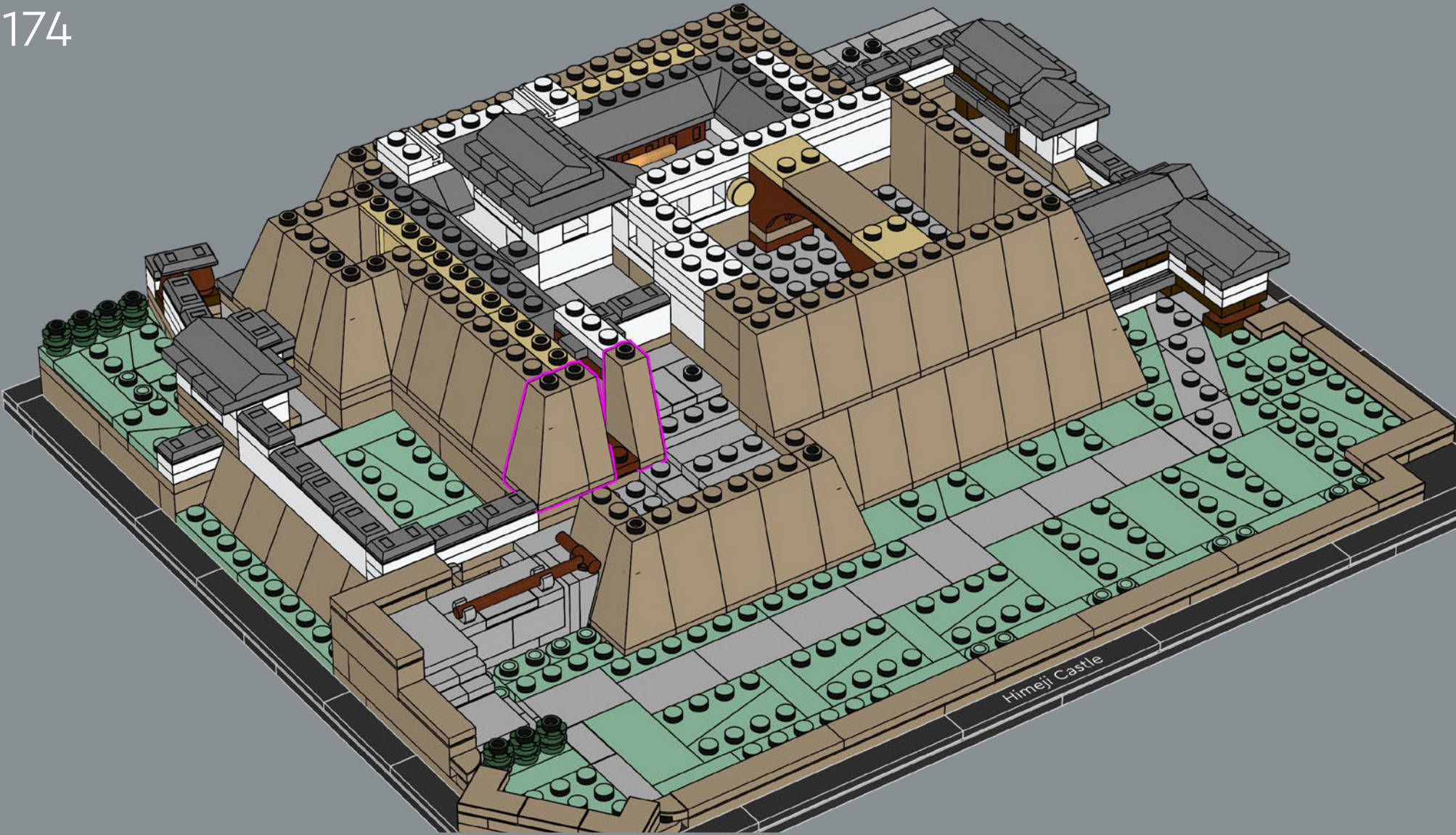

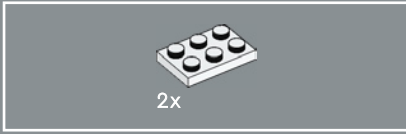
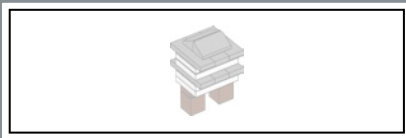

175

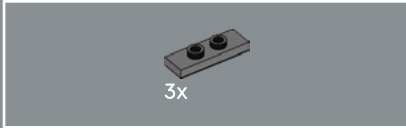
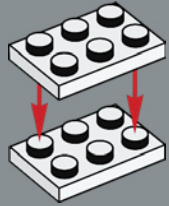

176

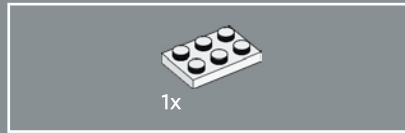

177

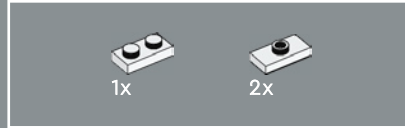
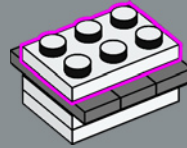

178

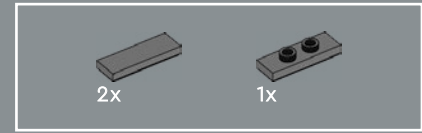
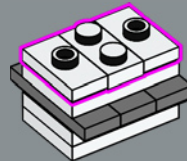

179

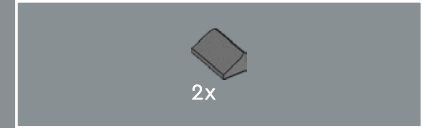
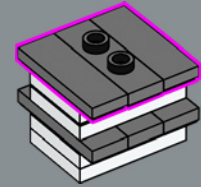

180

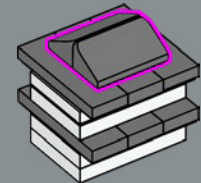

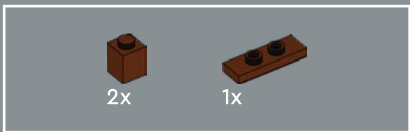

181

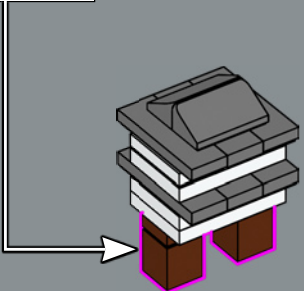
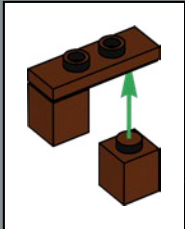

182



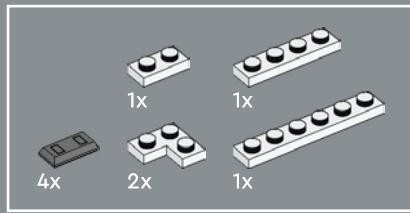

183

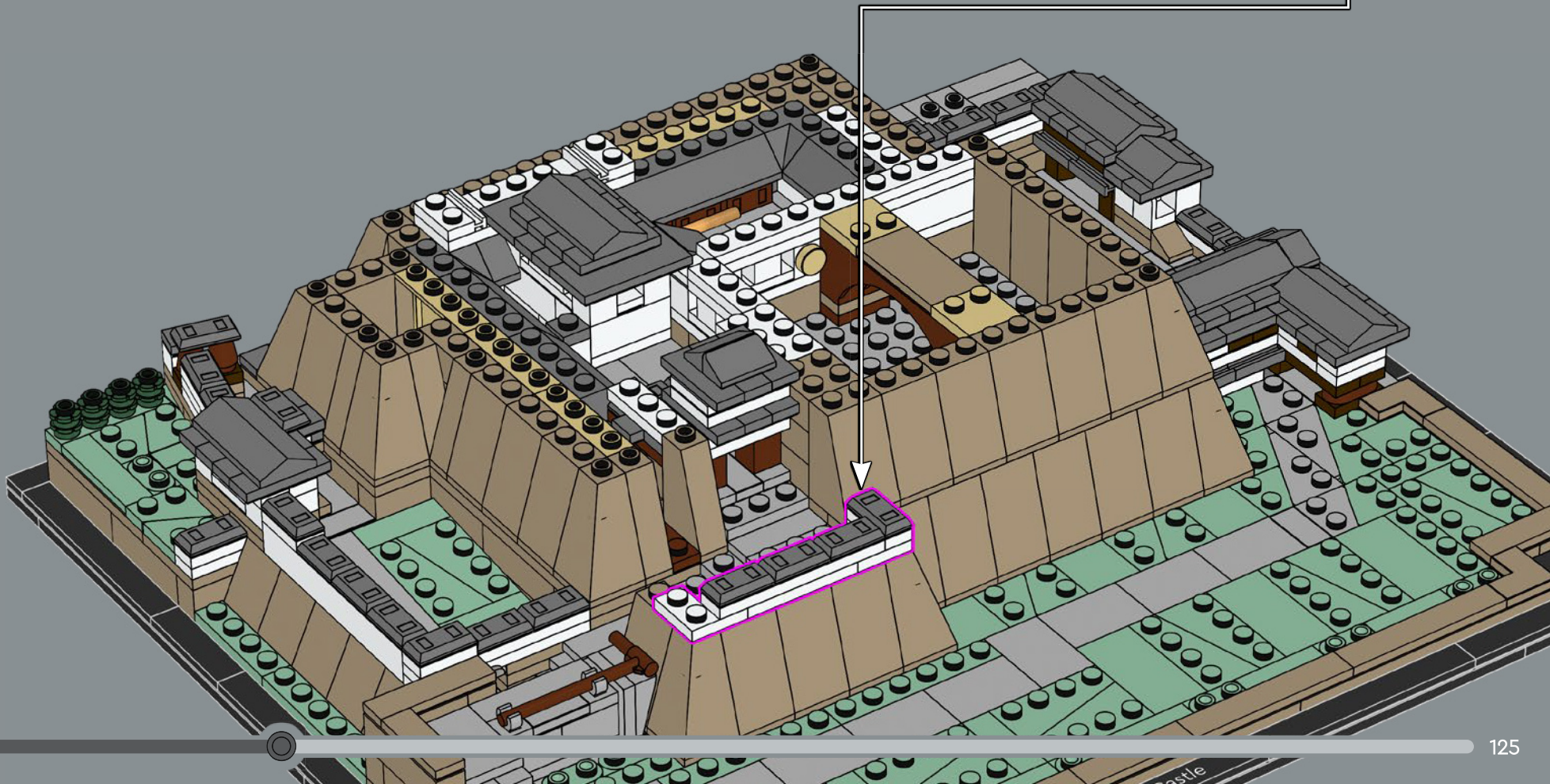
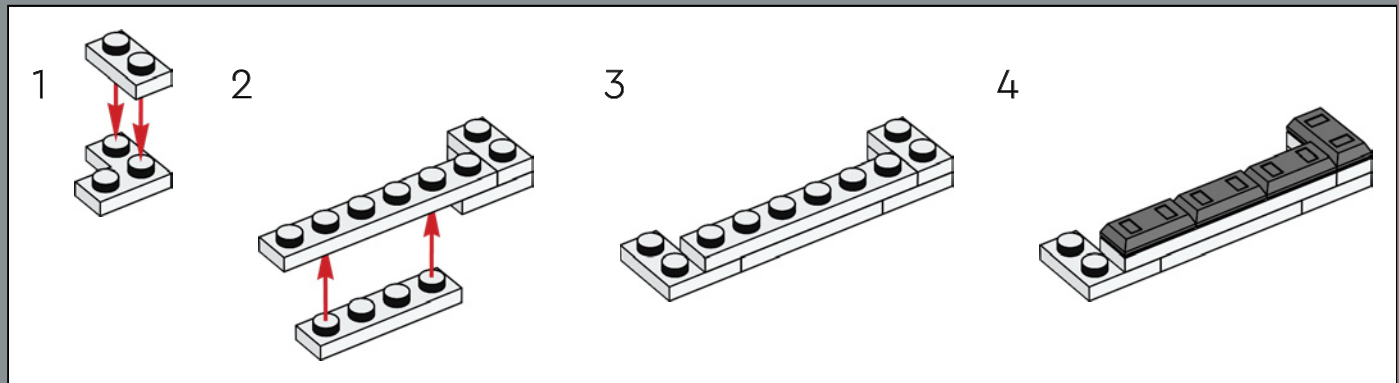

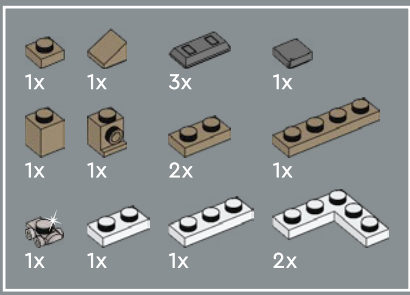

184

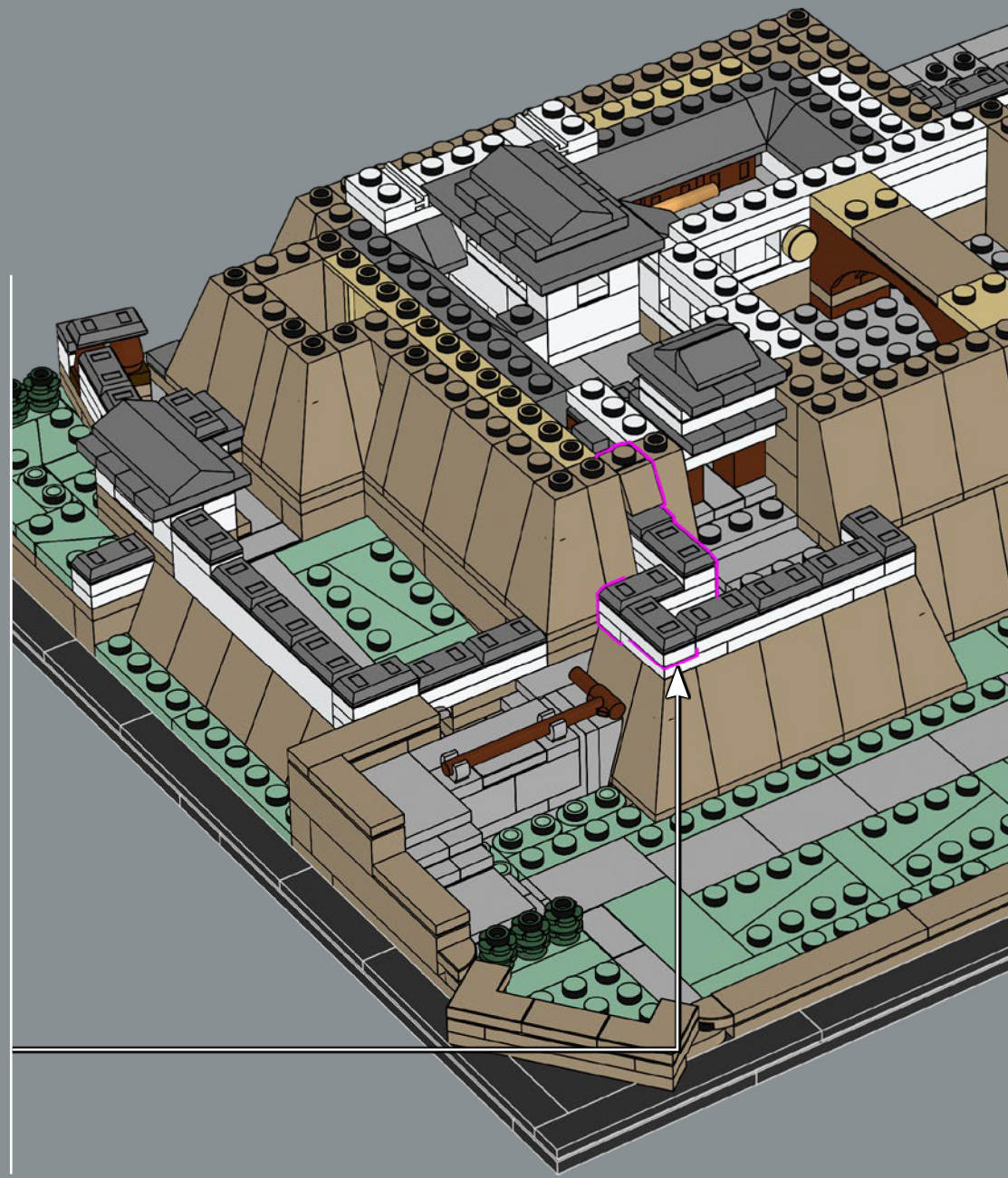
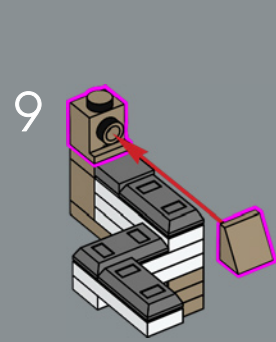
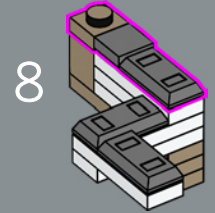
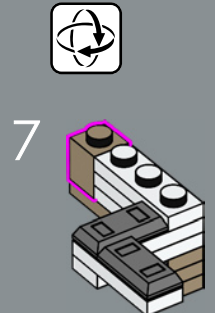
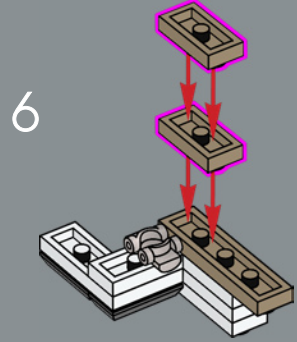
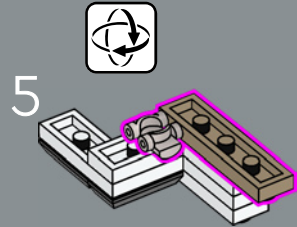
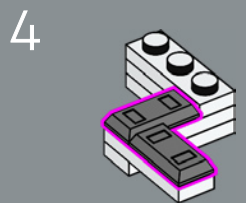
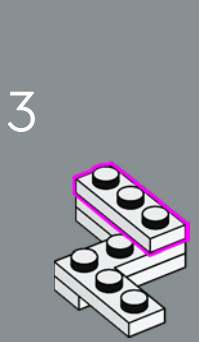
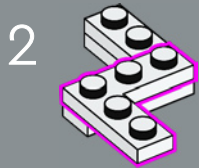
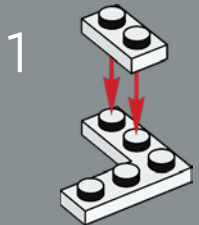

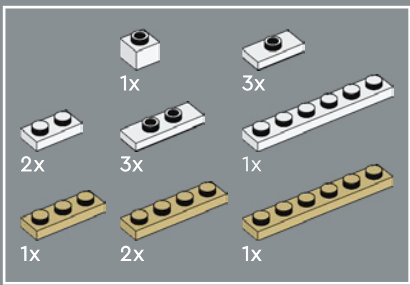

186

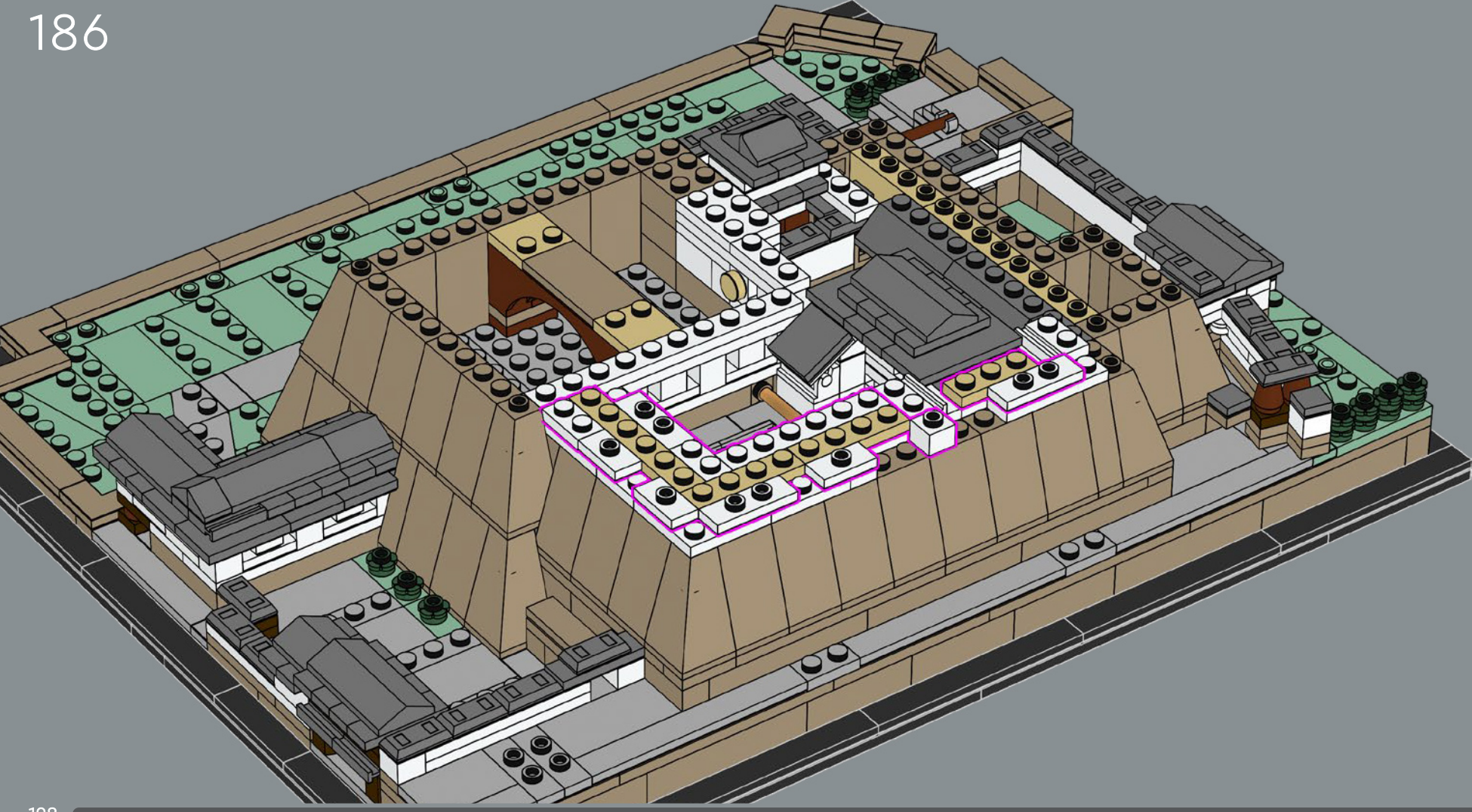

During the 2009–2015 renovation, several sides of the exterior scaffolding had line art drawings of the castle to keep the iconic landmark visible on the Himeji skyline.

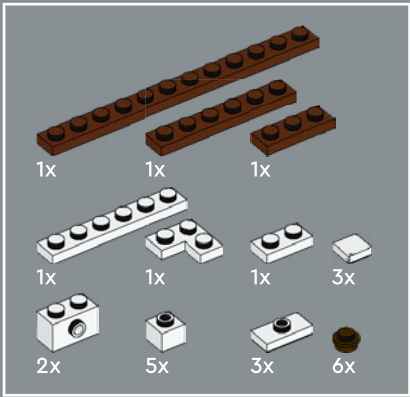

187

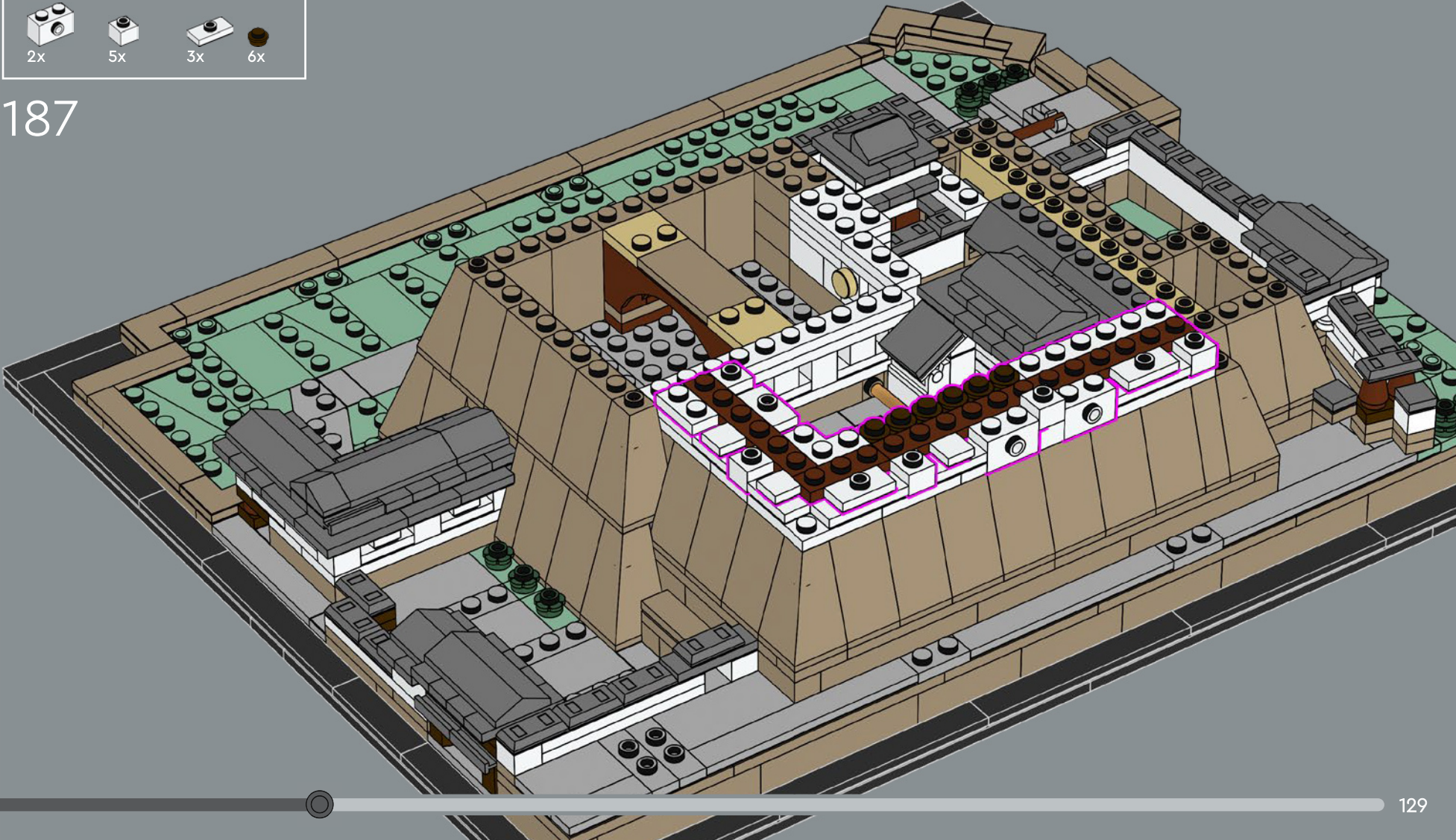

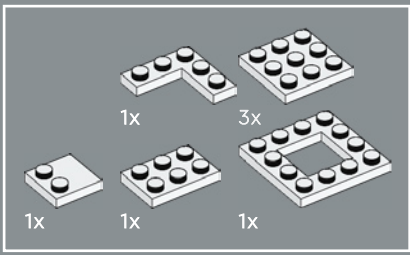

188

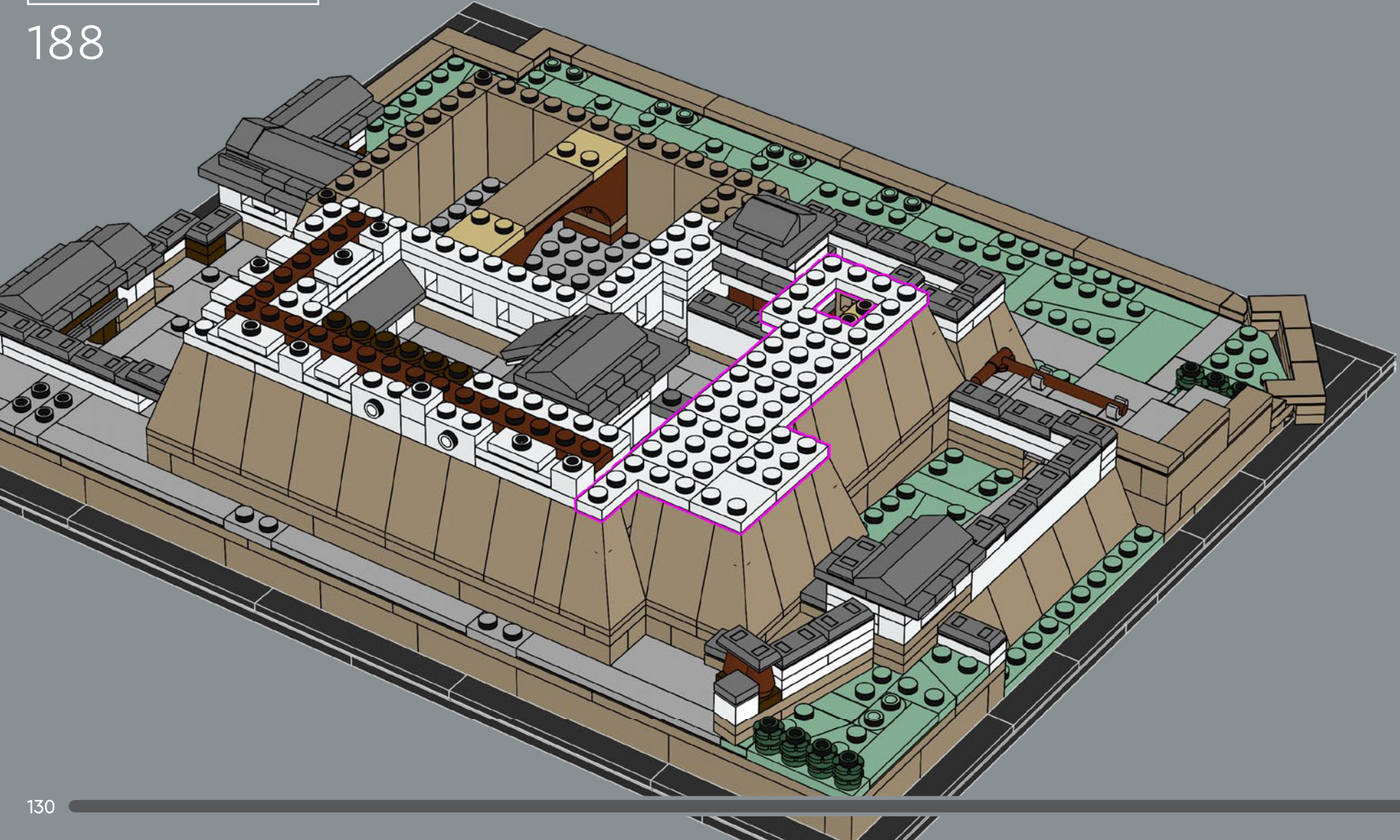

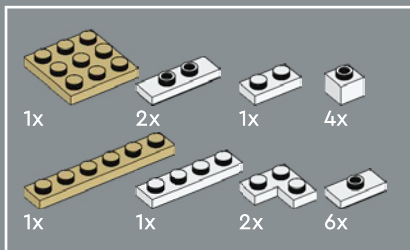

189

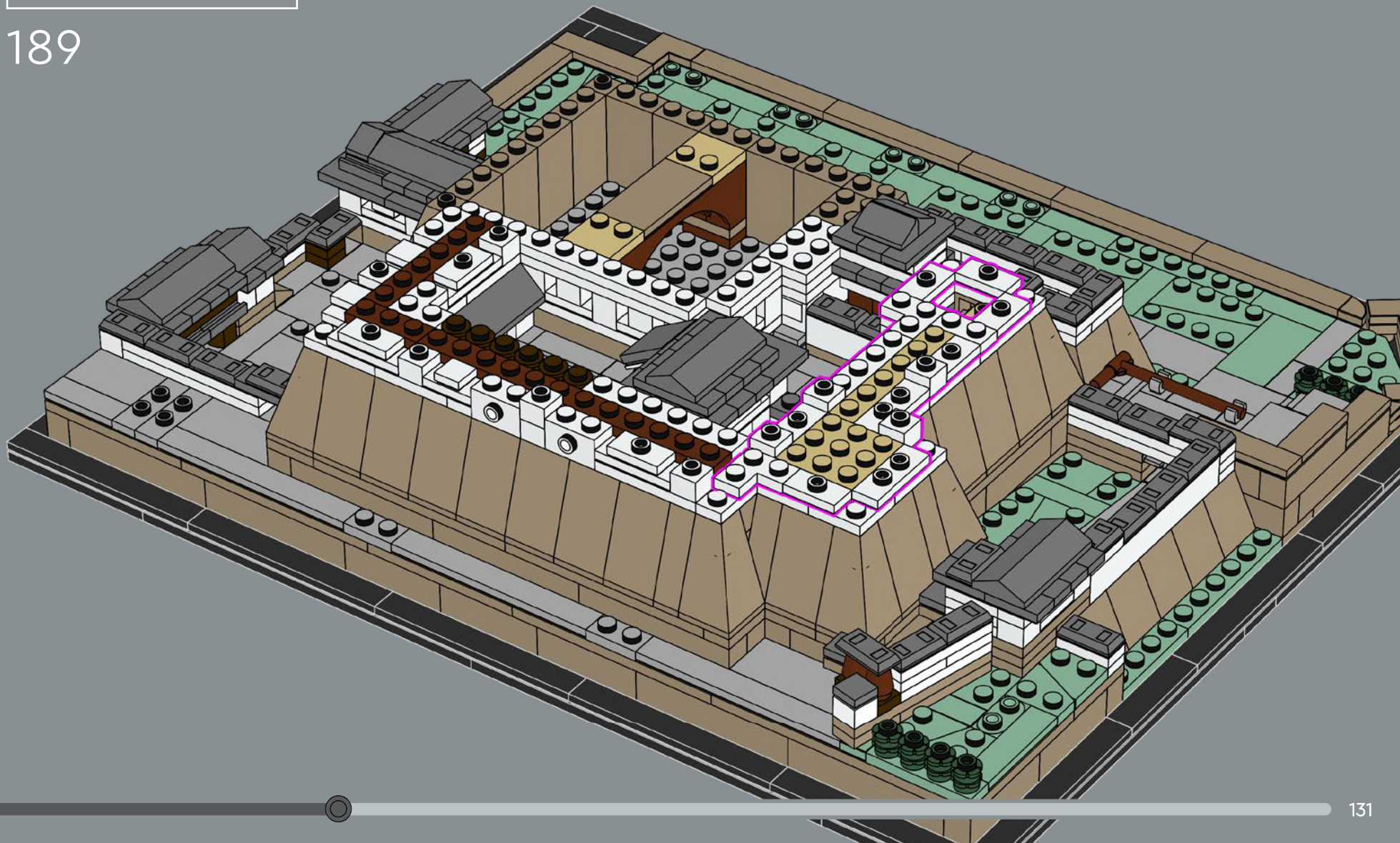

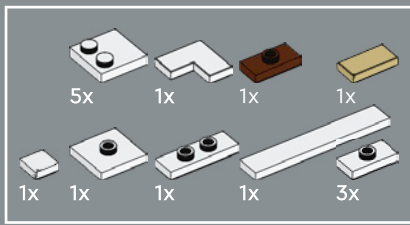

191

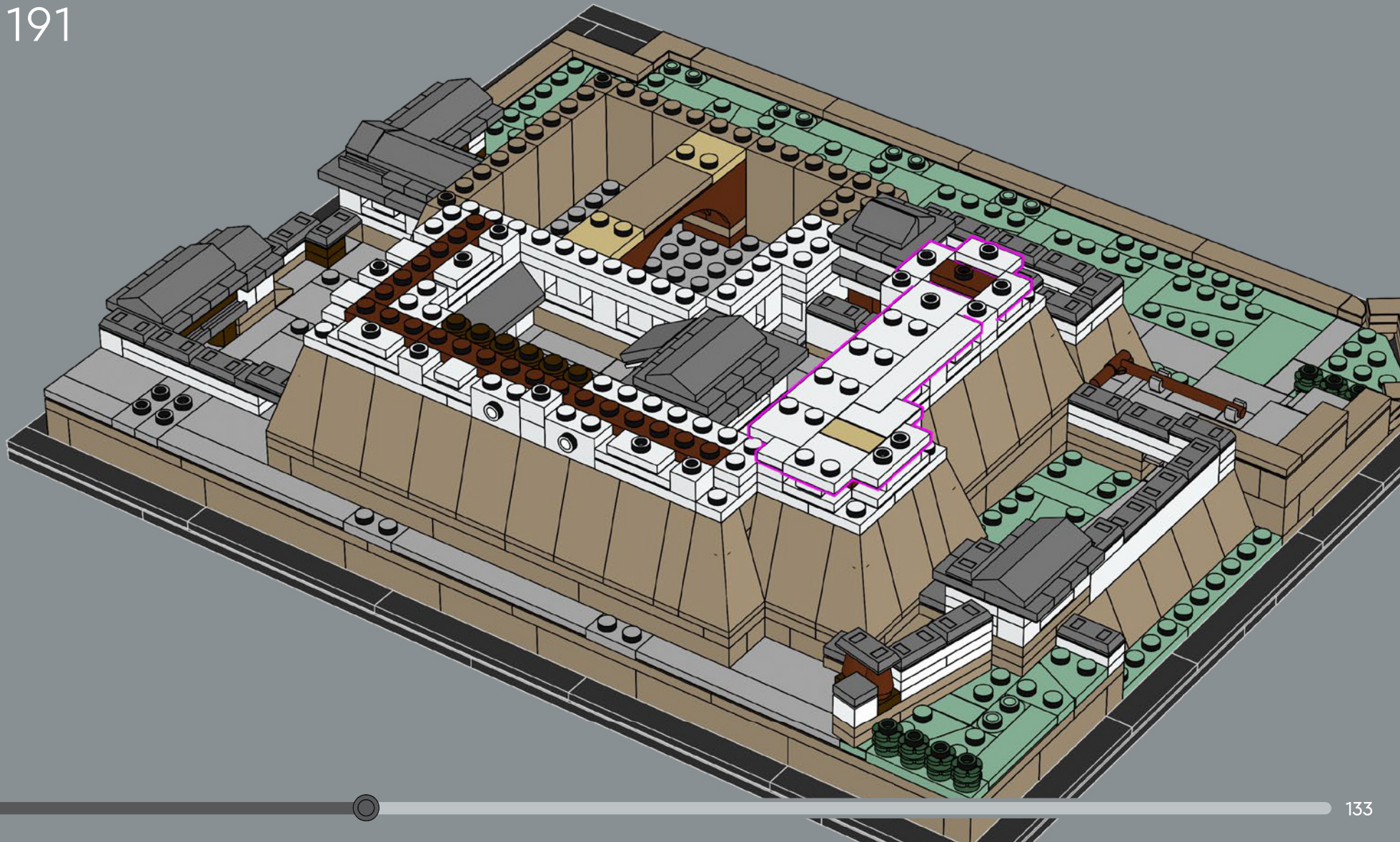

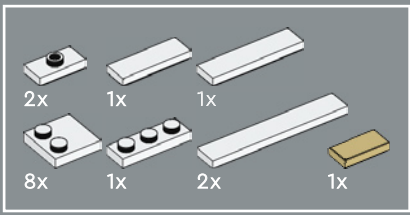

192

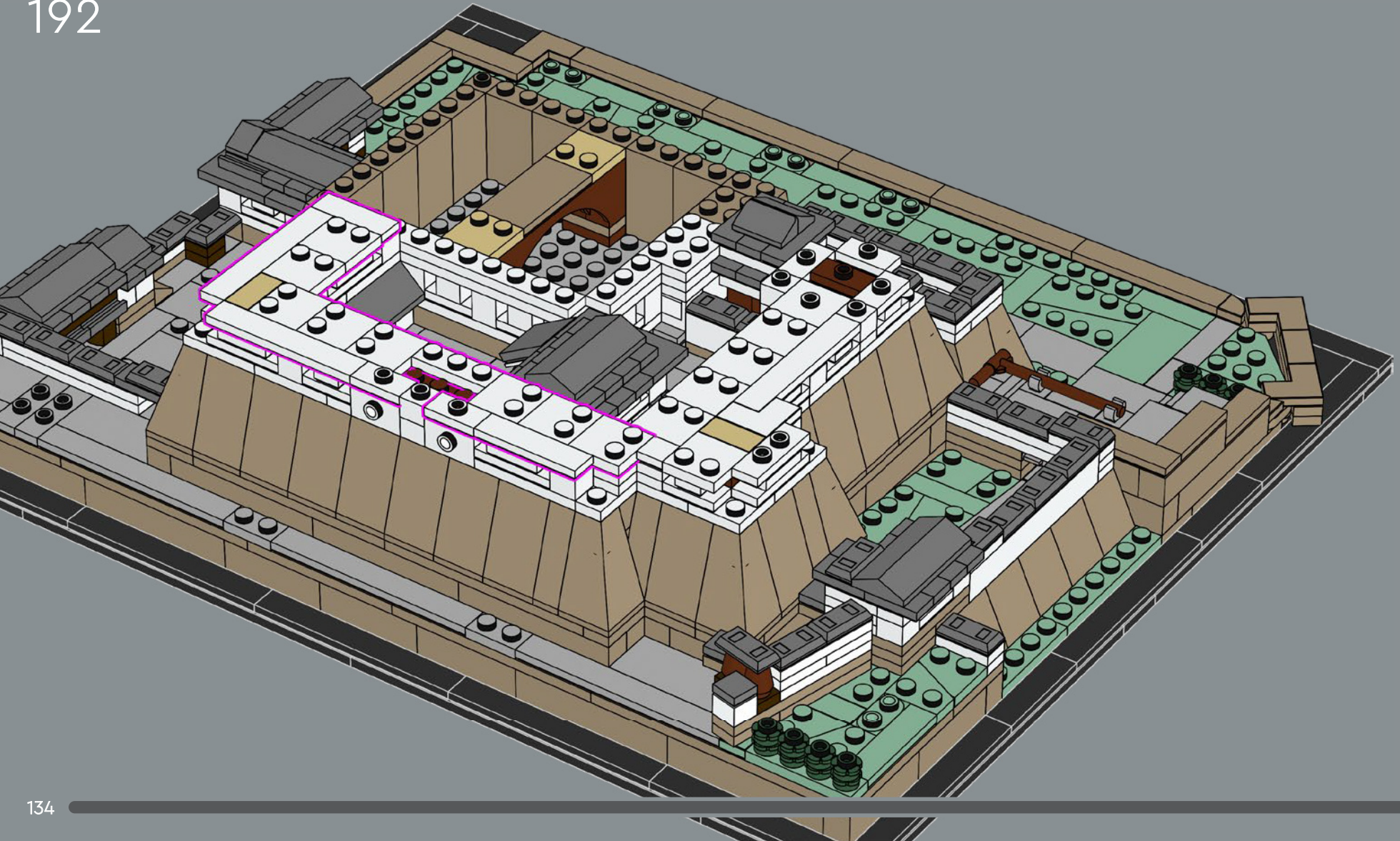

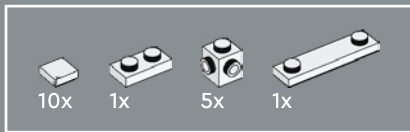

193

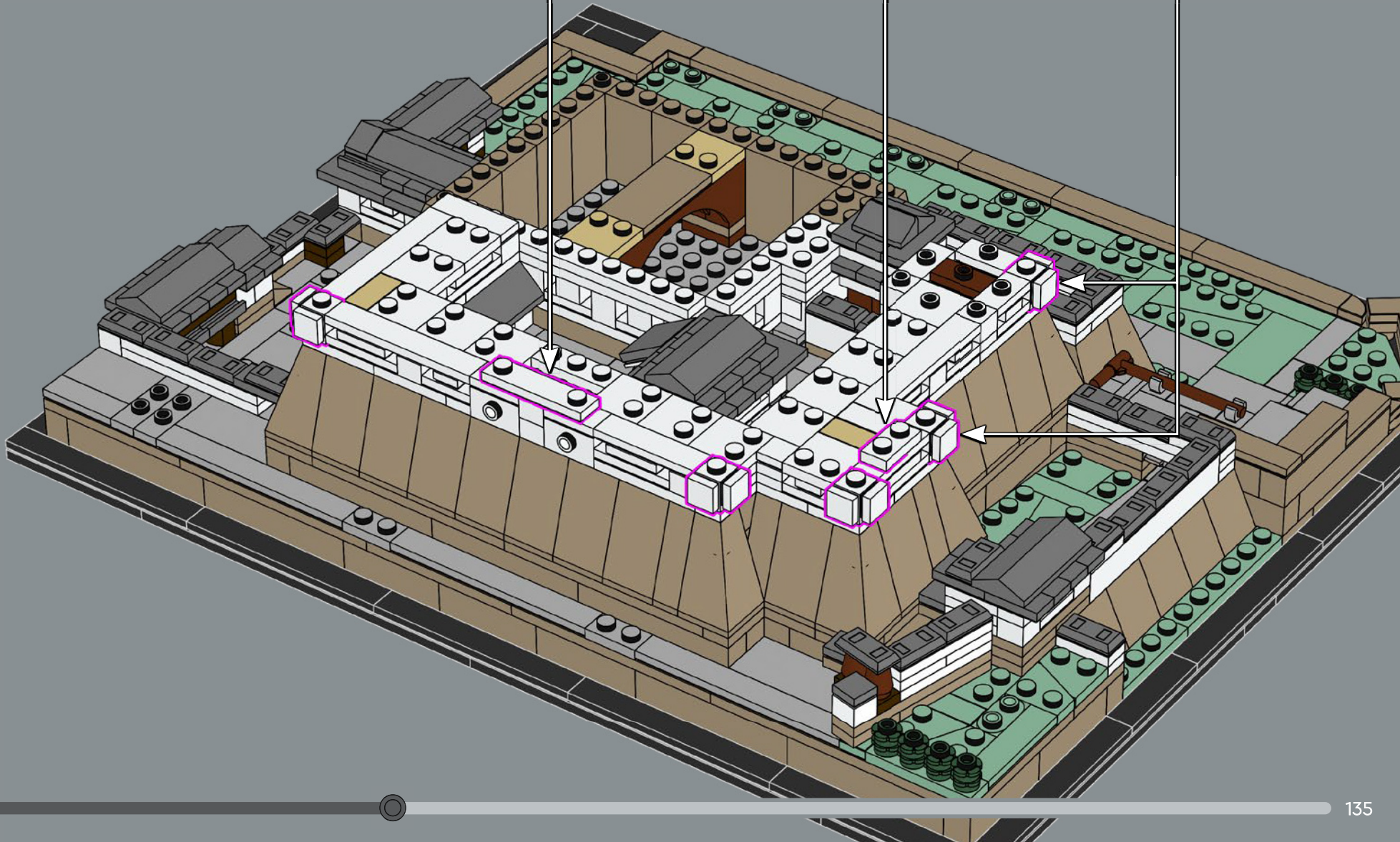
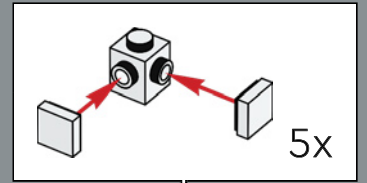
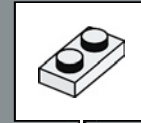
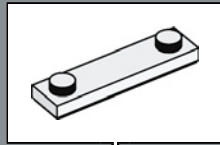

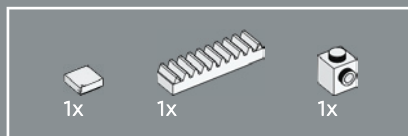

194

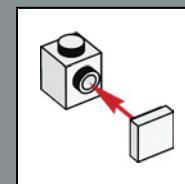
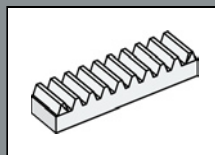

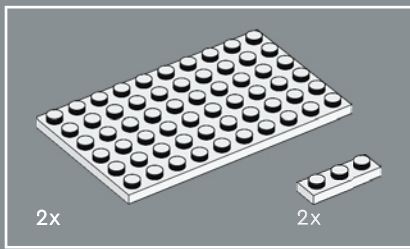

195

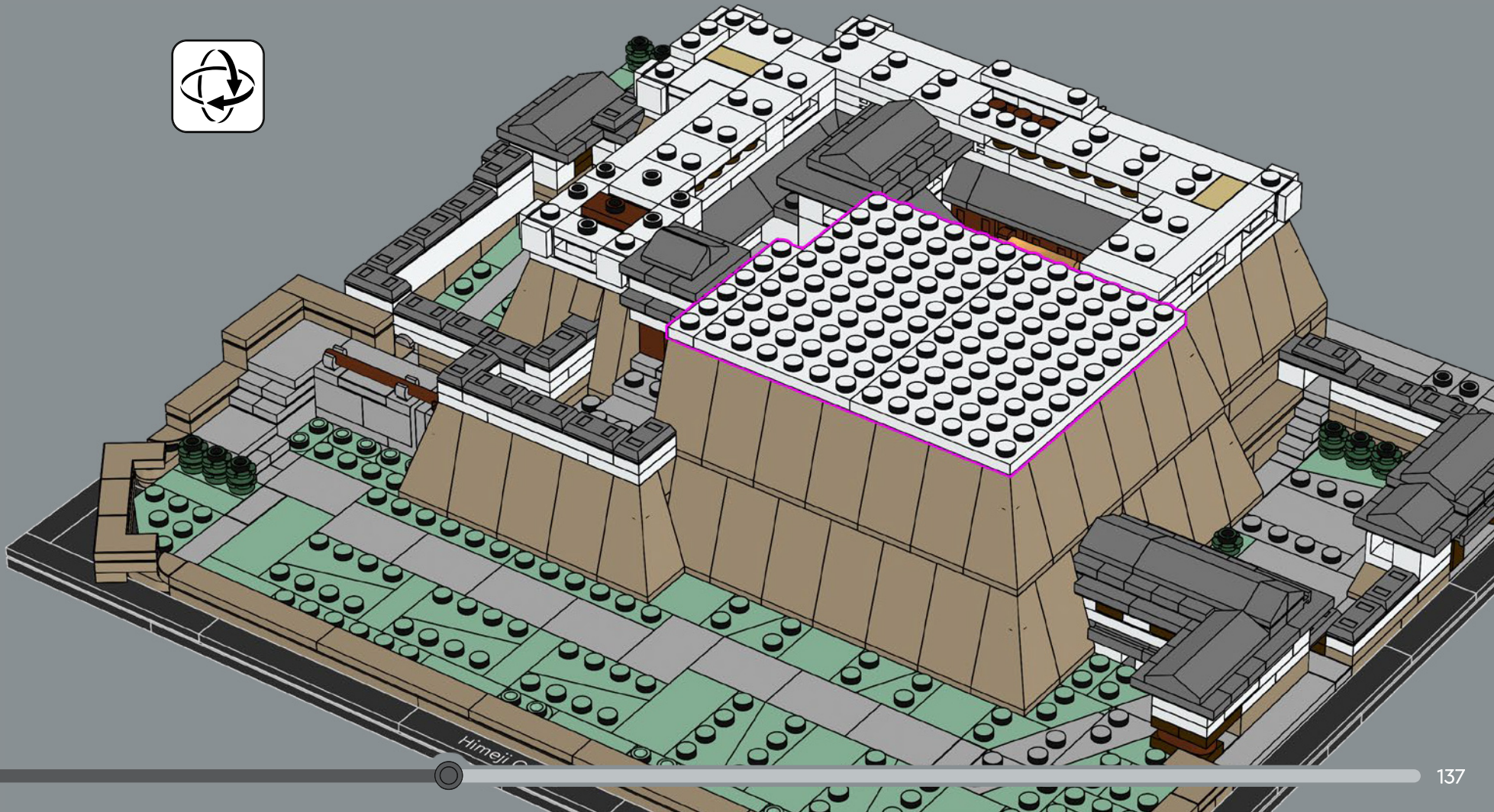

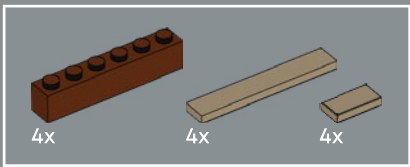

196

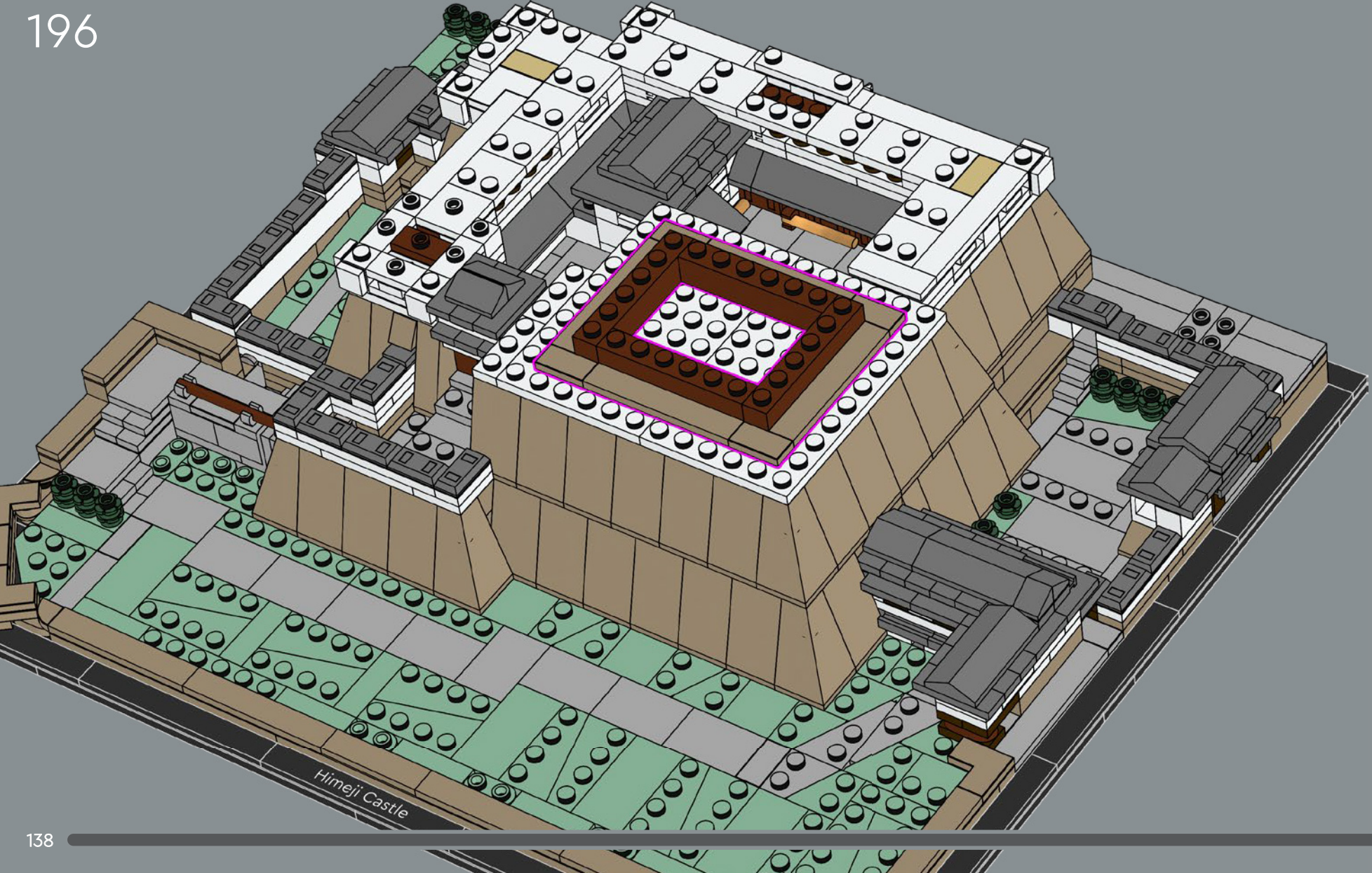

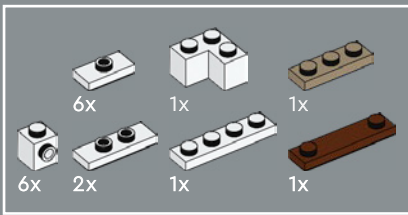

197

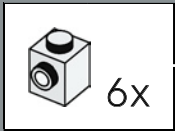
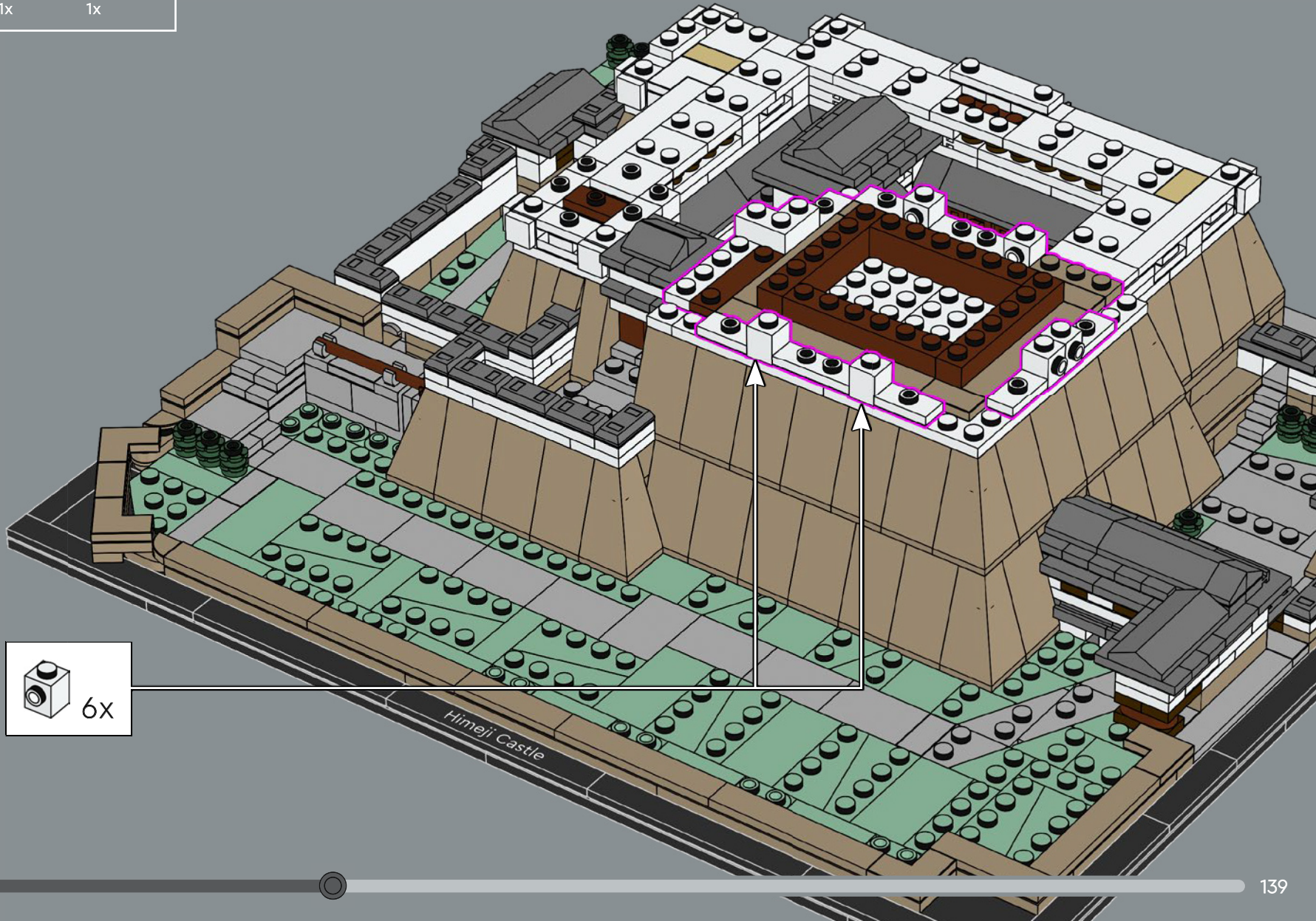

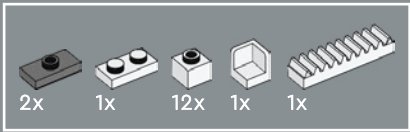

198

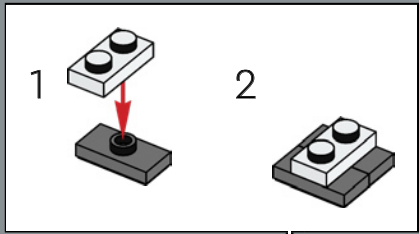

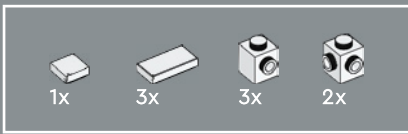

199

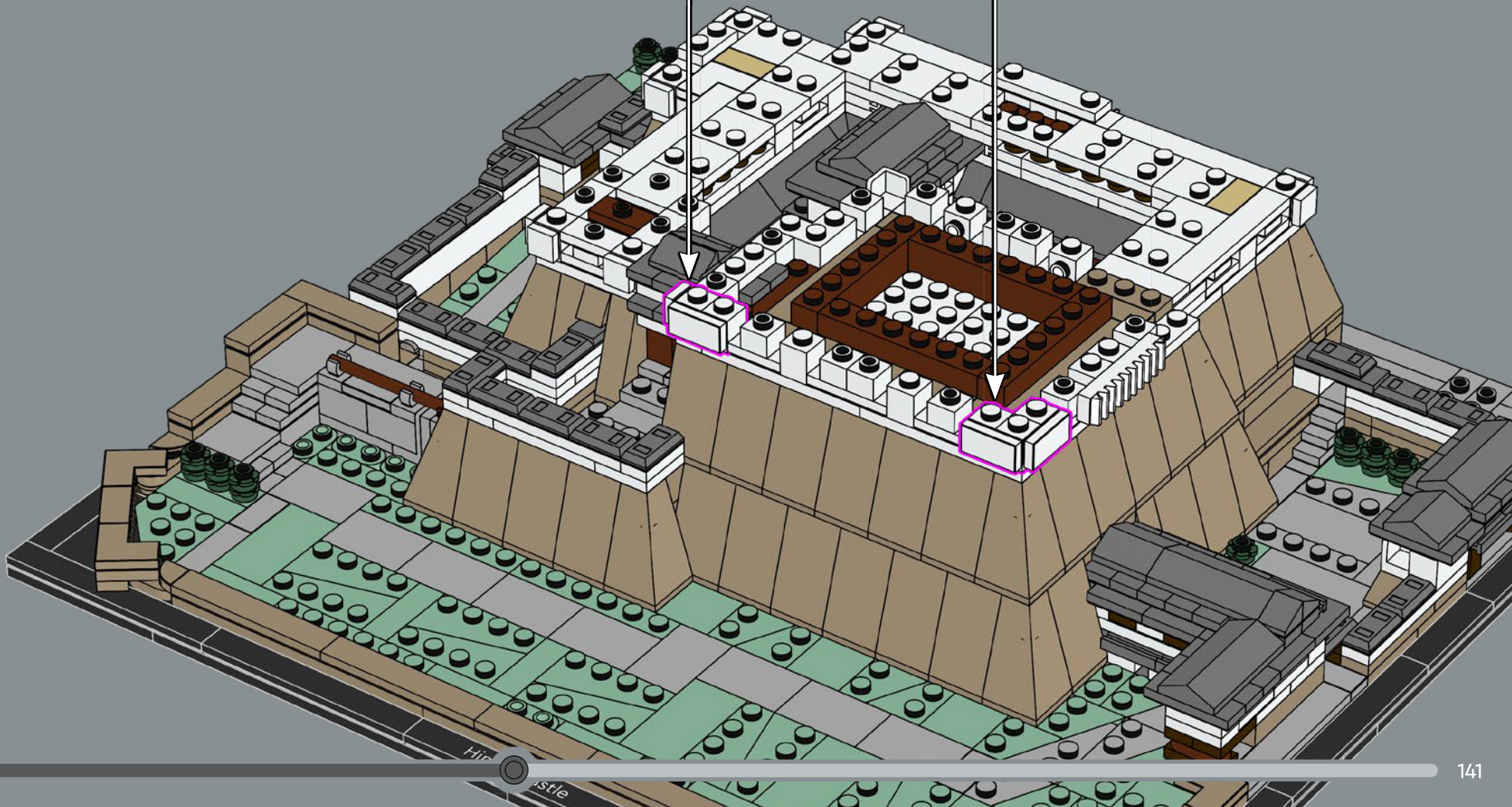
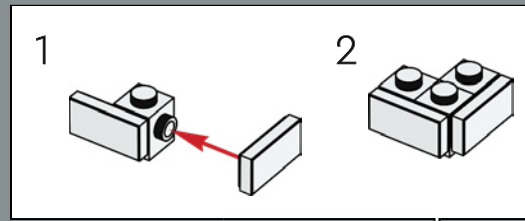
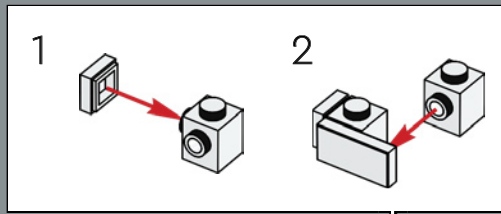

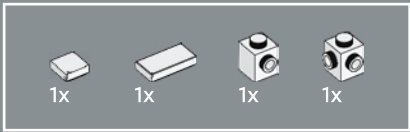

200

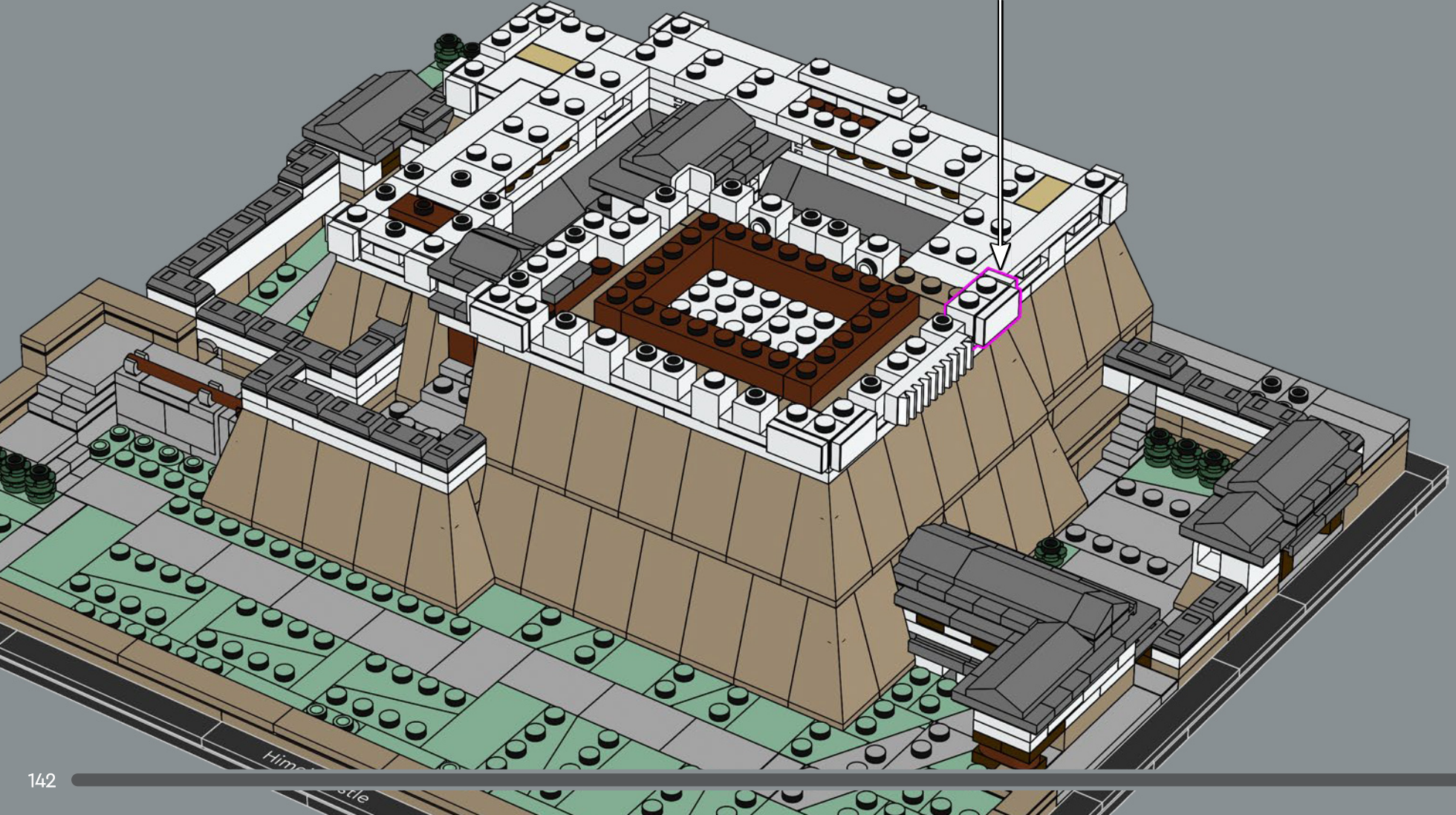
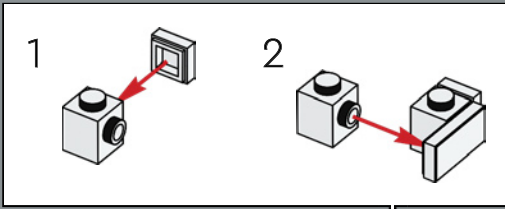

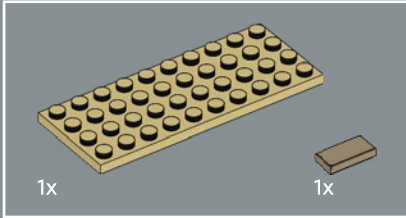
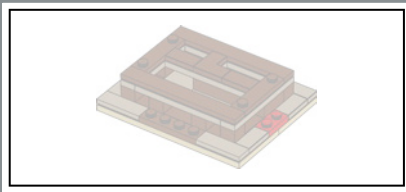

201

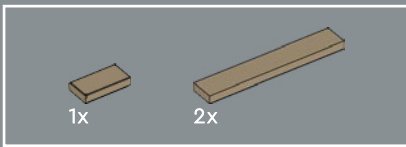
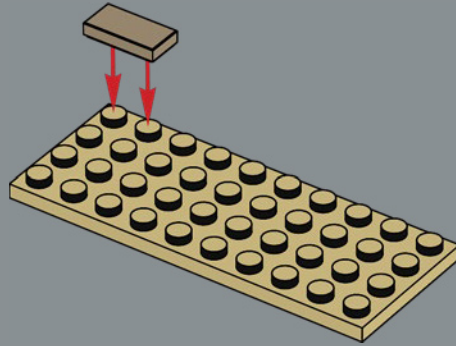

202

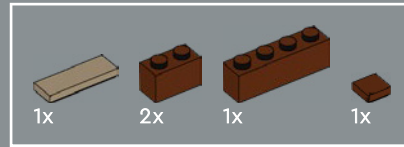
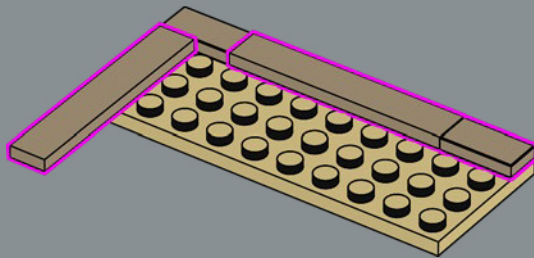

203

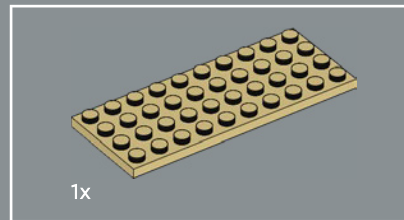
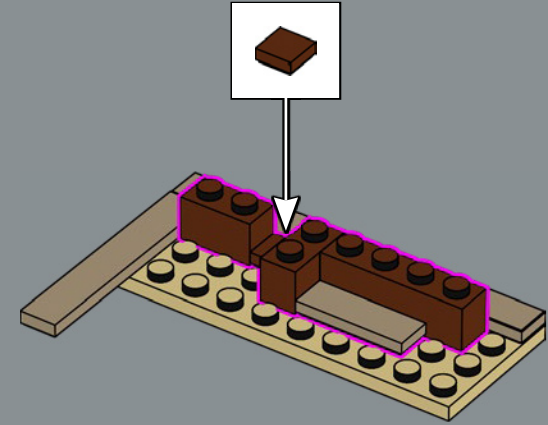

204

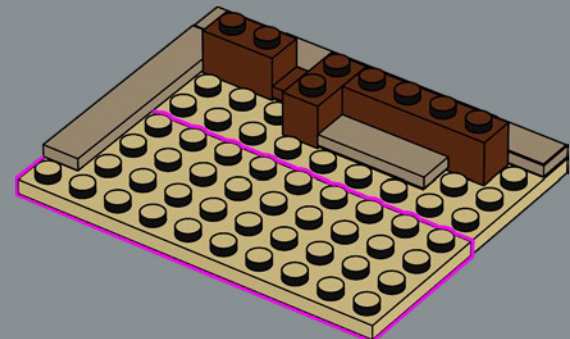

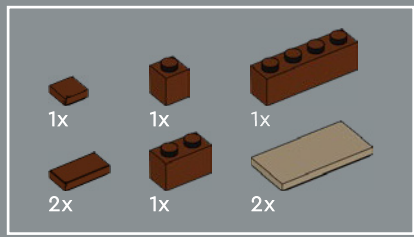

205

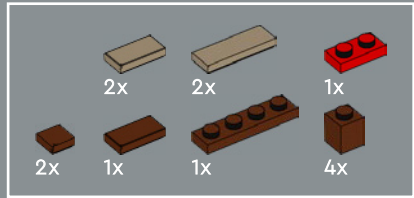
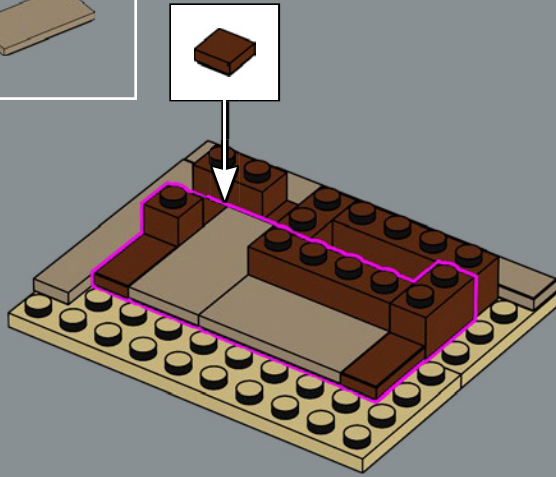

206

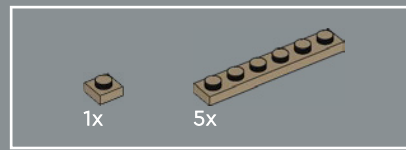
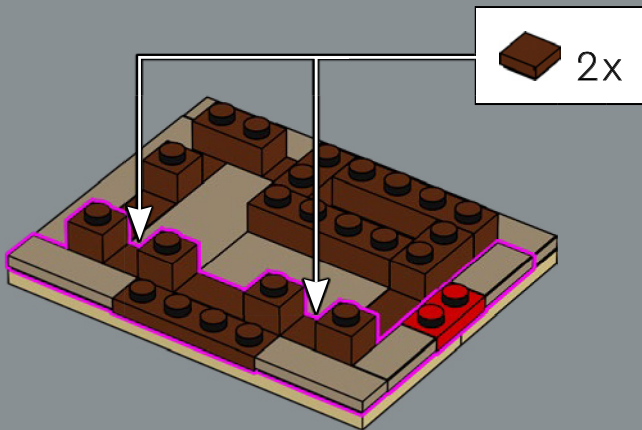

207

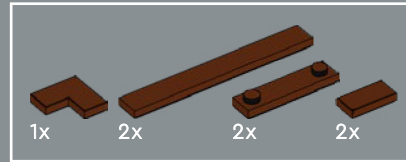
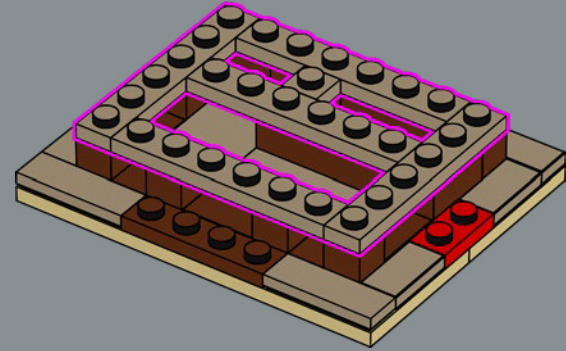

208

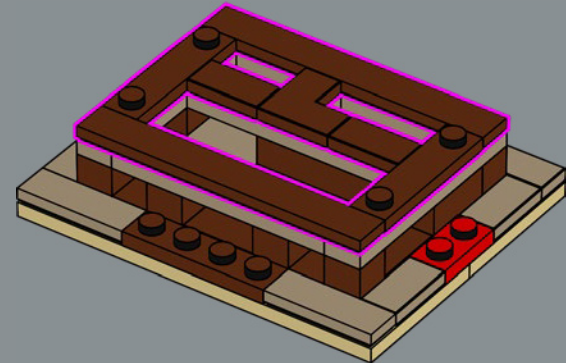

209

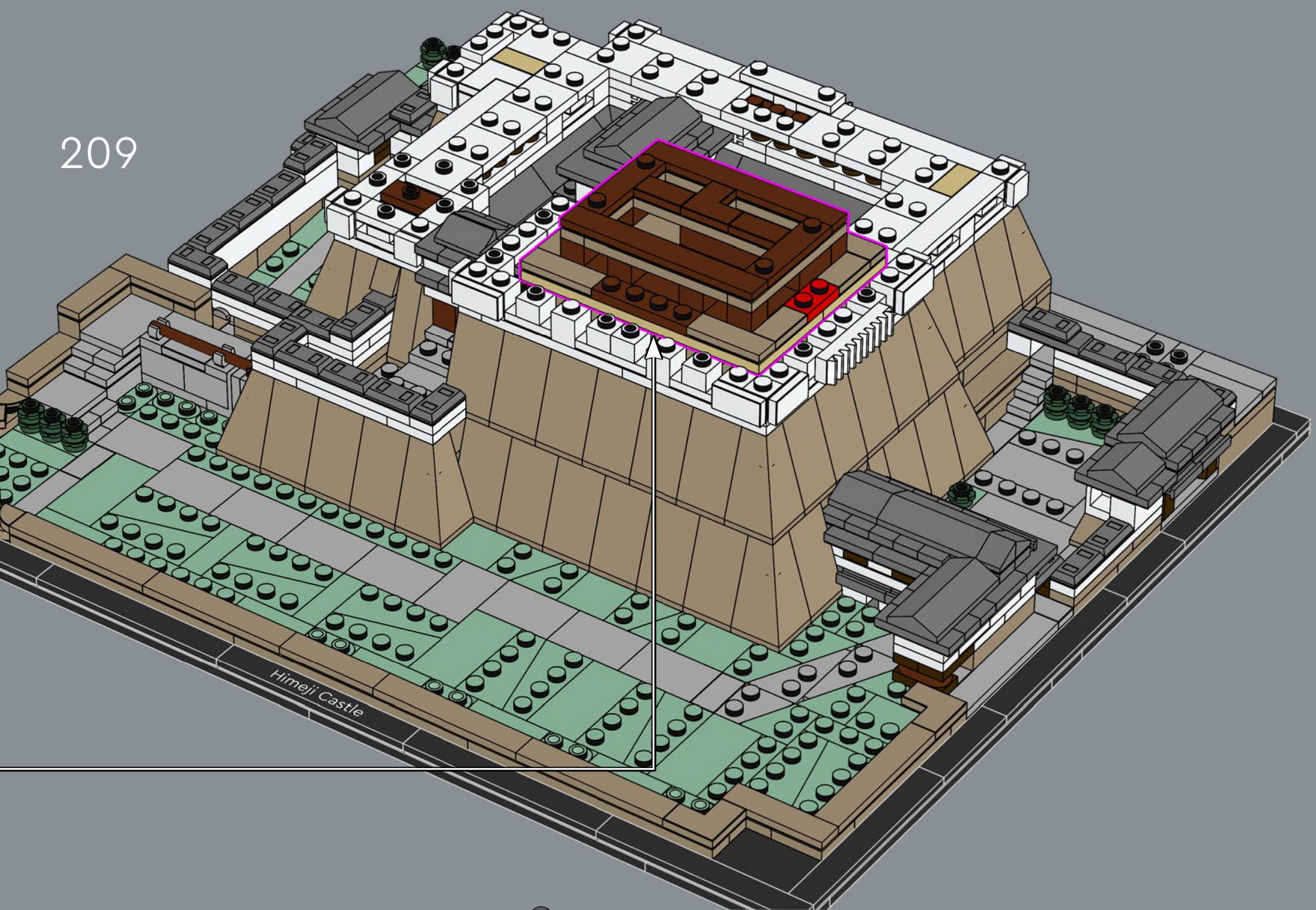

Himeji Castle

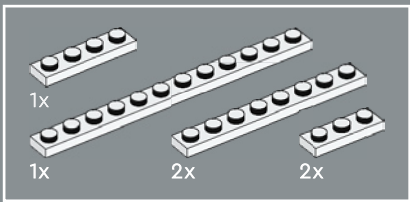

210

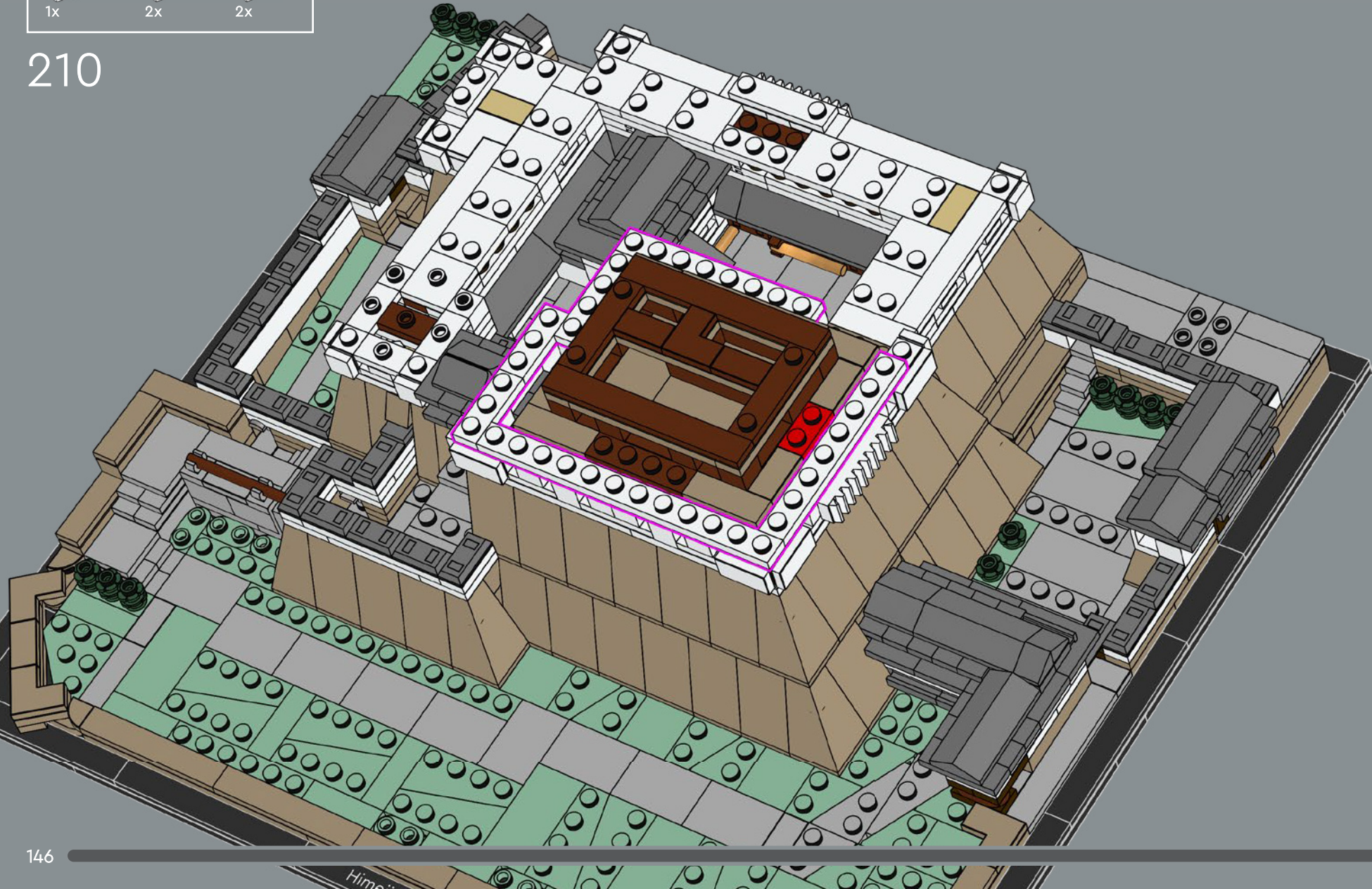

Though we had to adhere to 90-degree or other manageable angles for this set, we have kept some of the asymmetrical lines to honour the original castle.

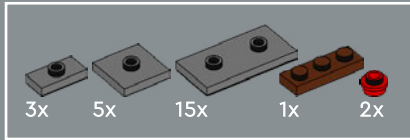

211

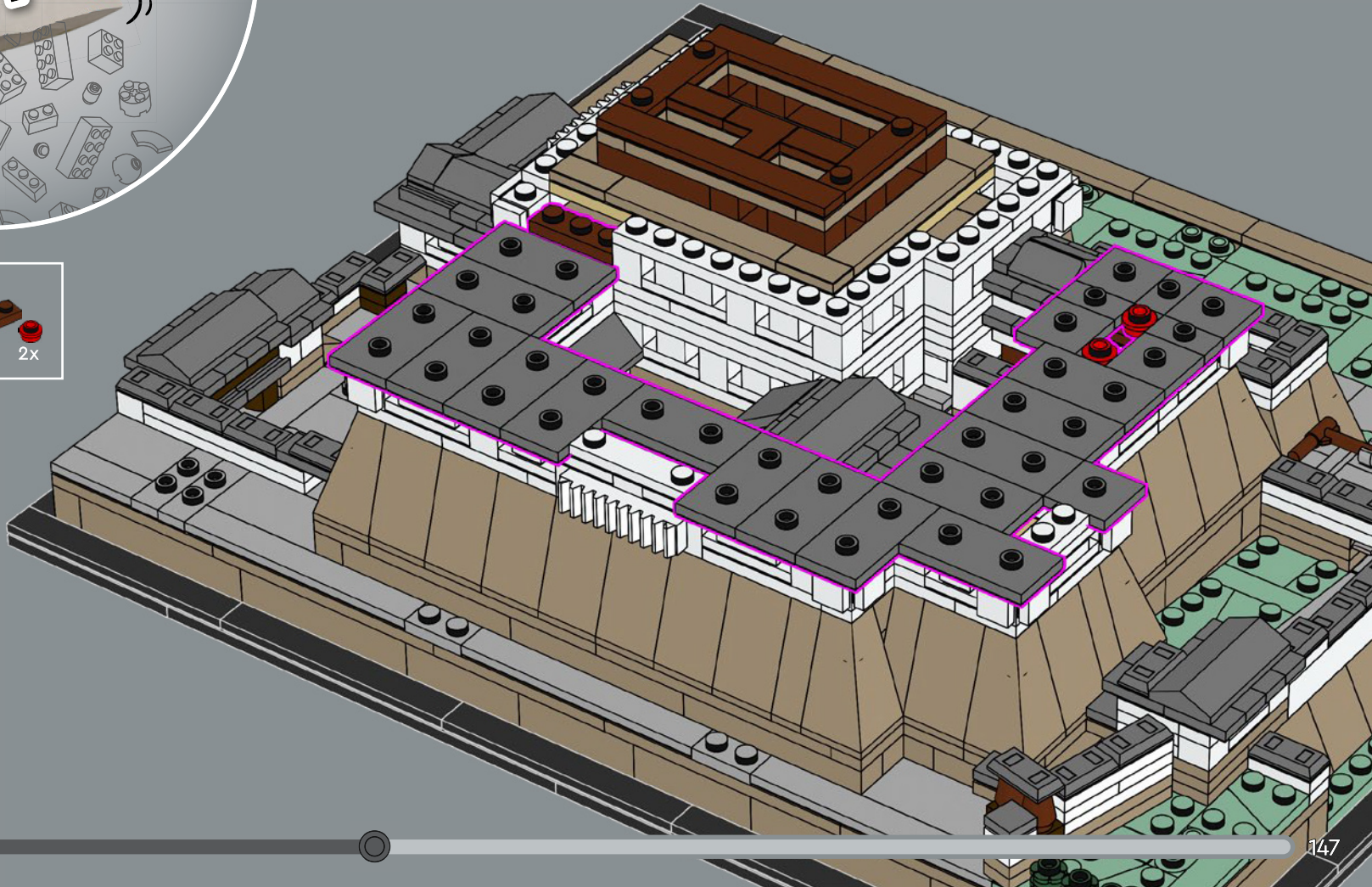

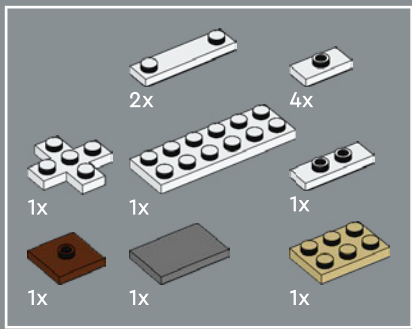

212

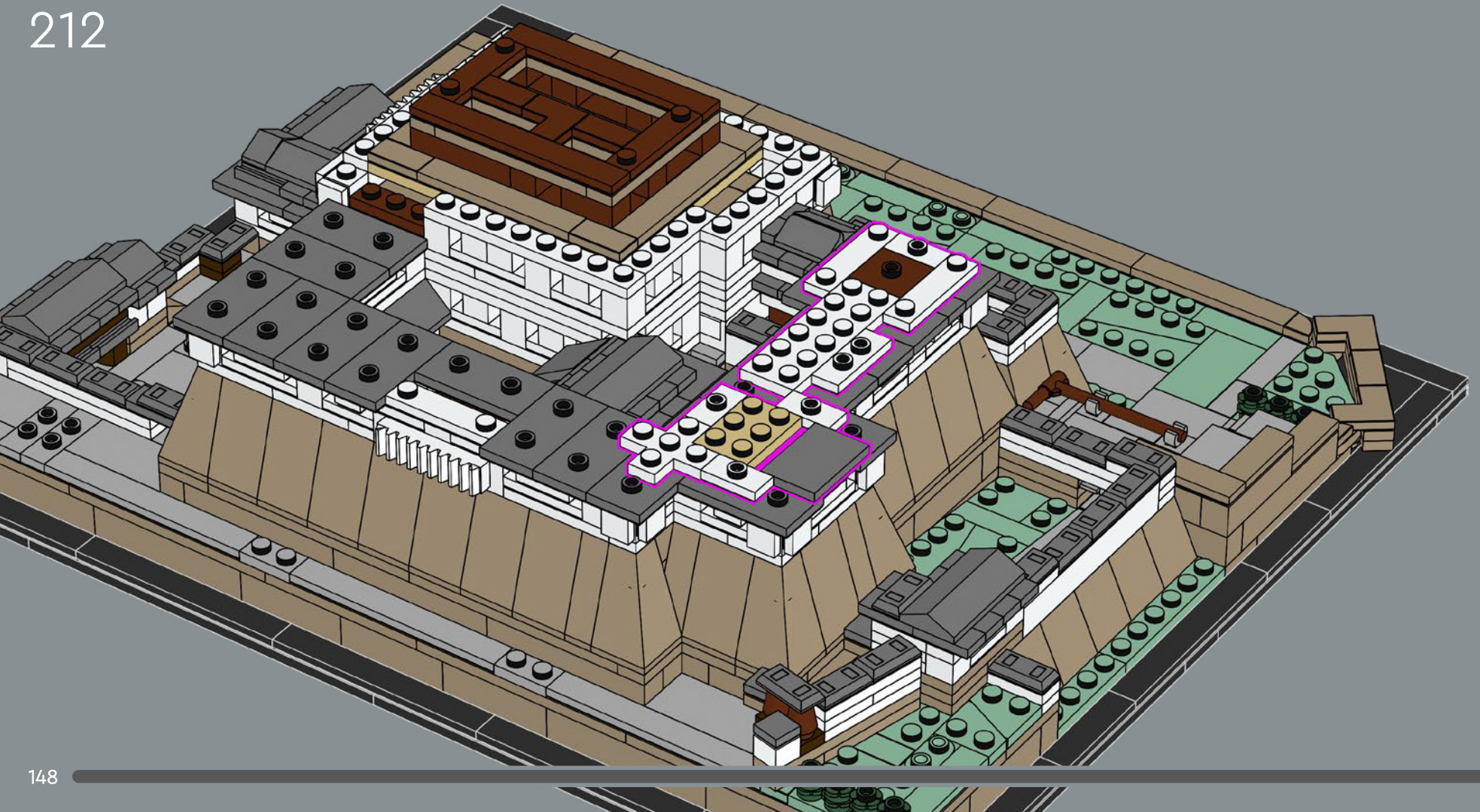

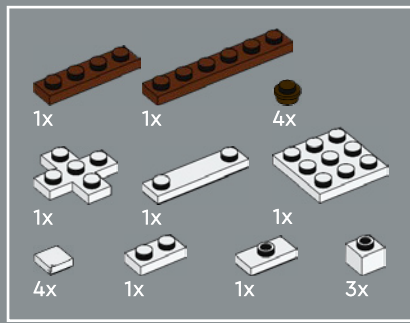

213

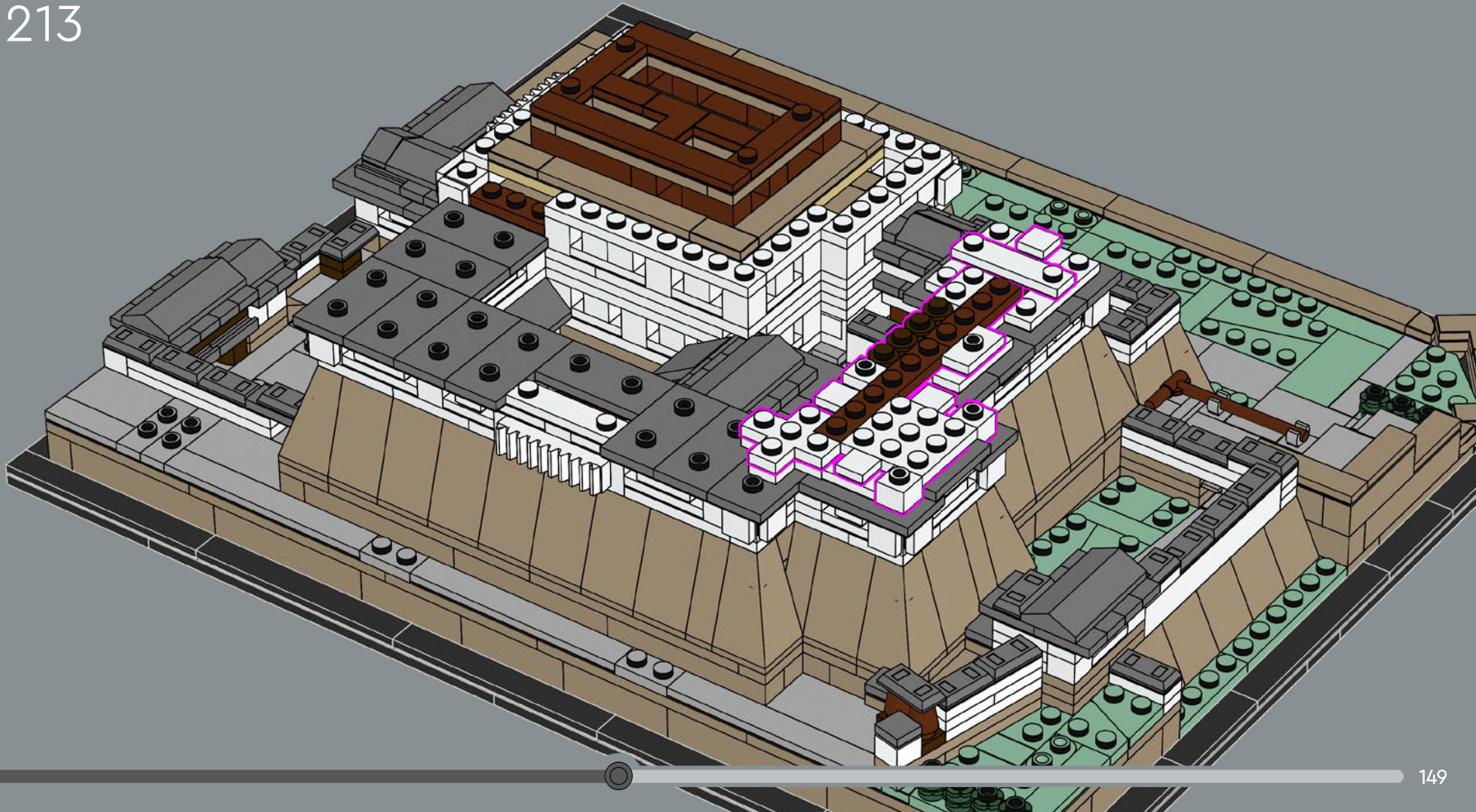

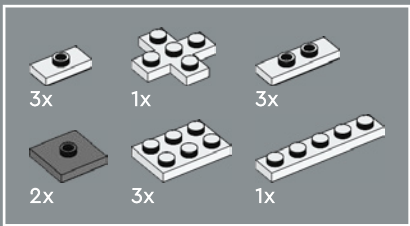

214

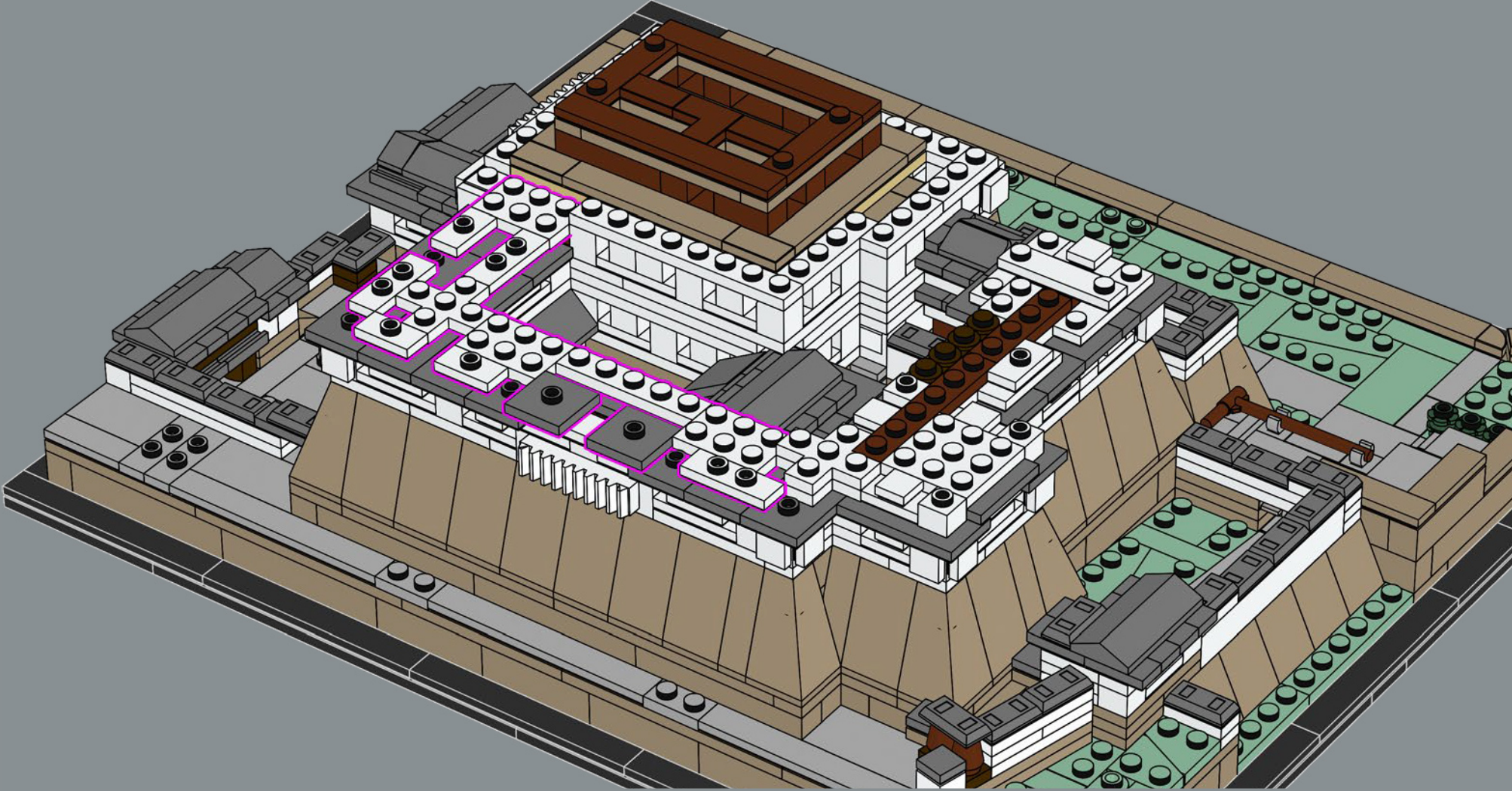

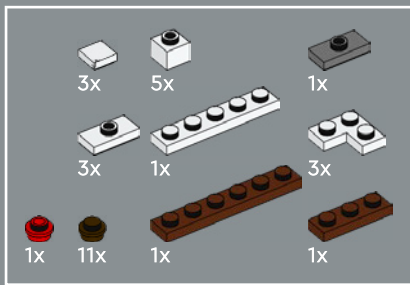

215

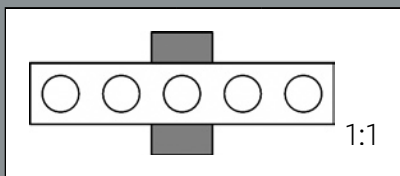
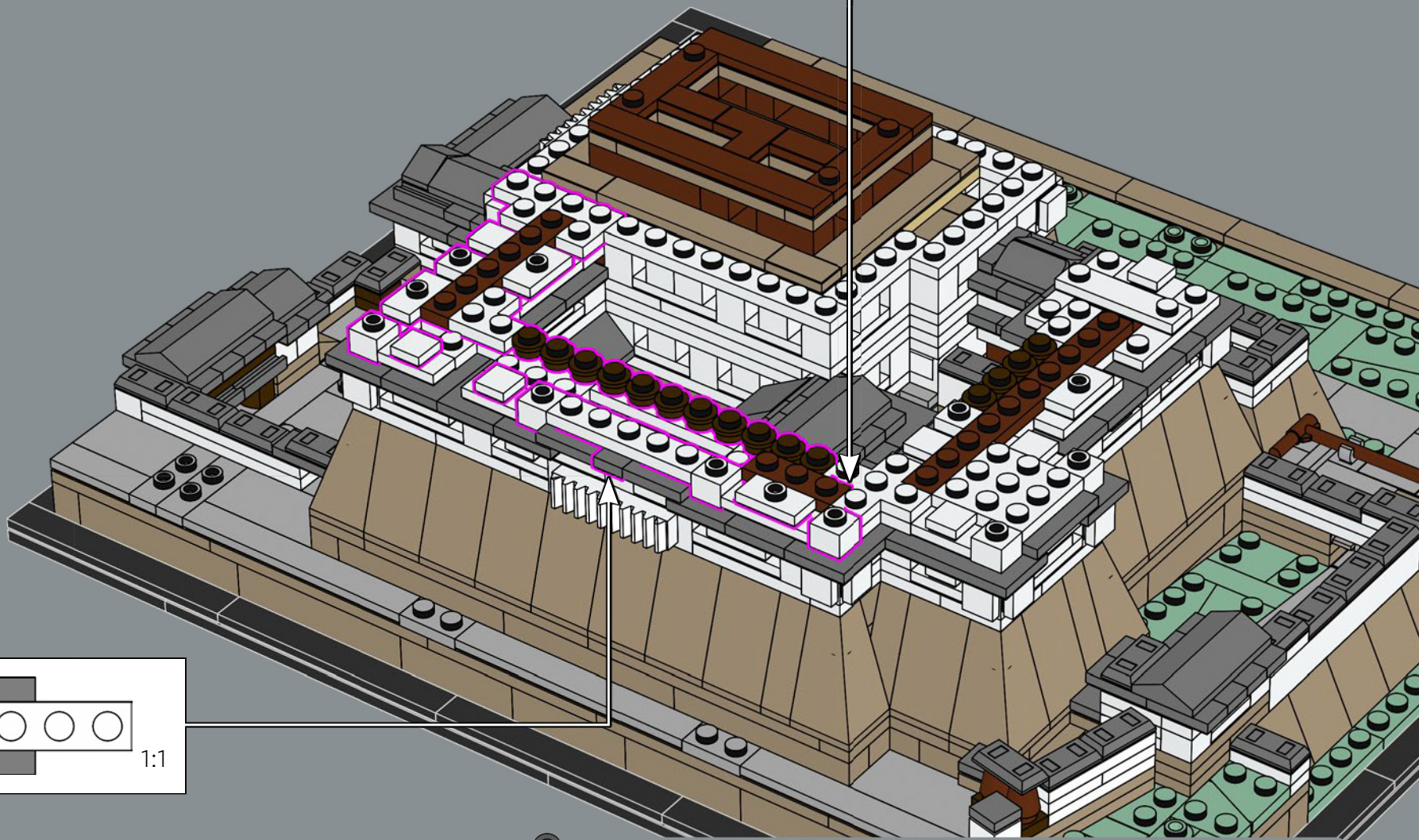
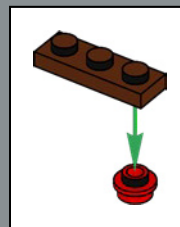

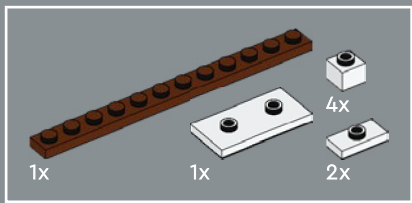

216

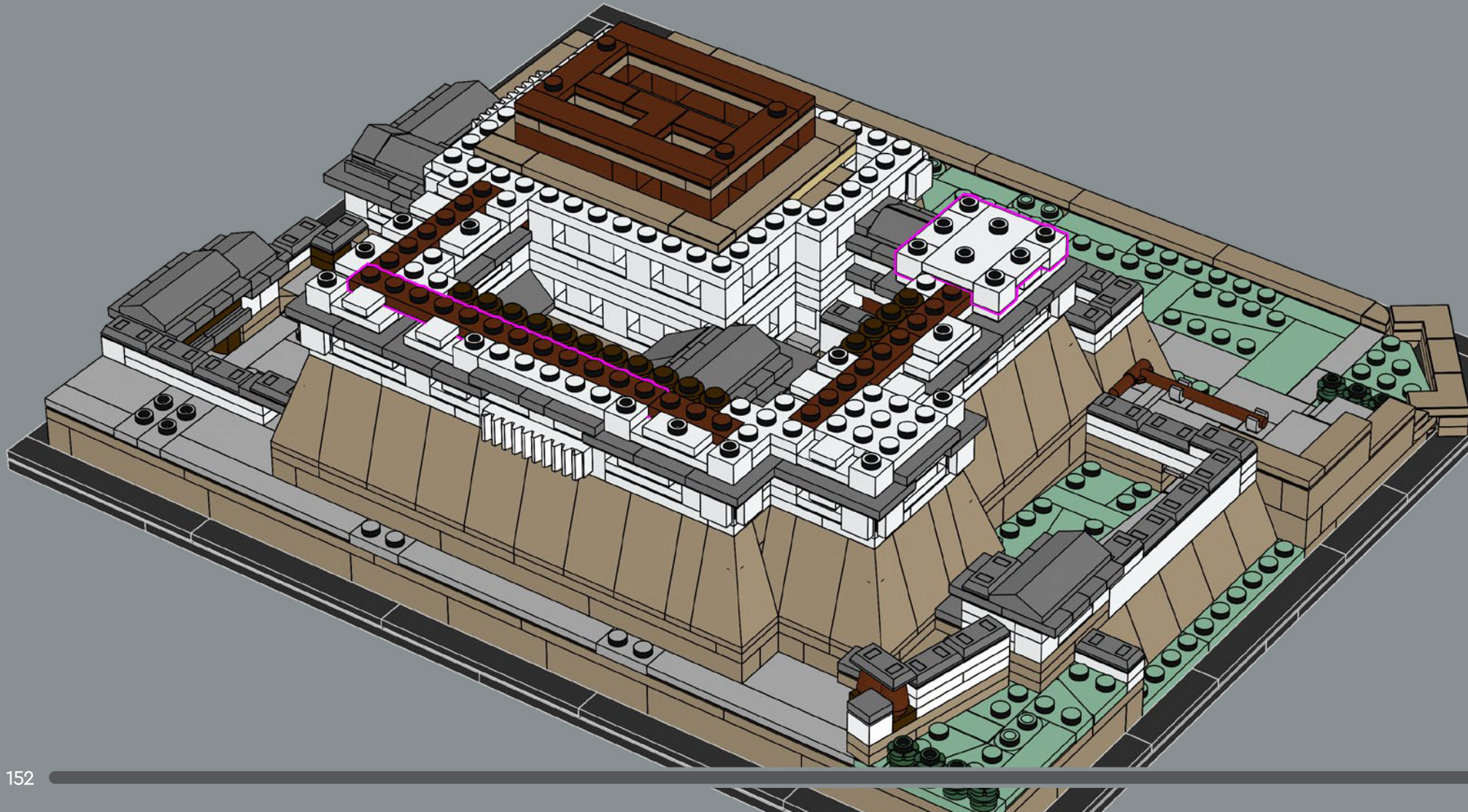

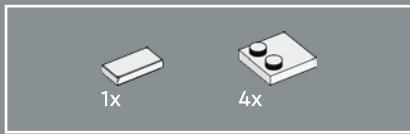

217

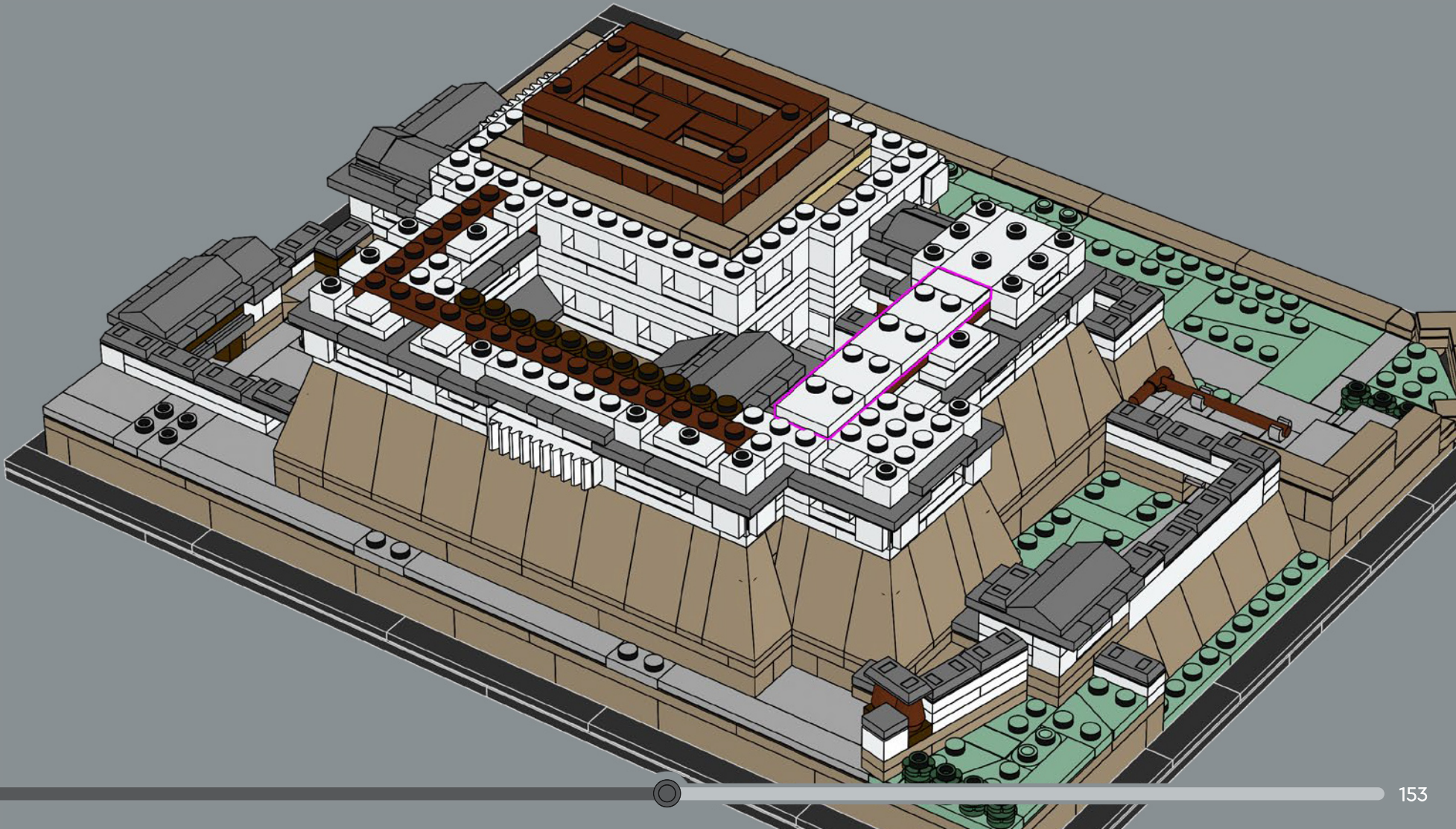

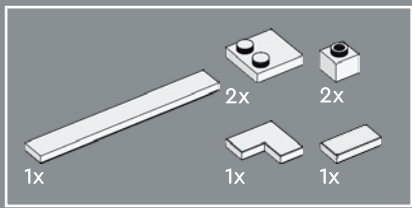

218

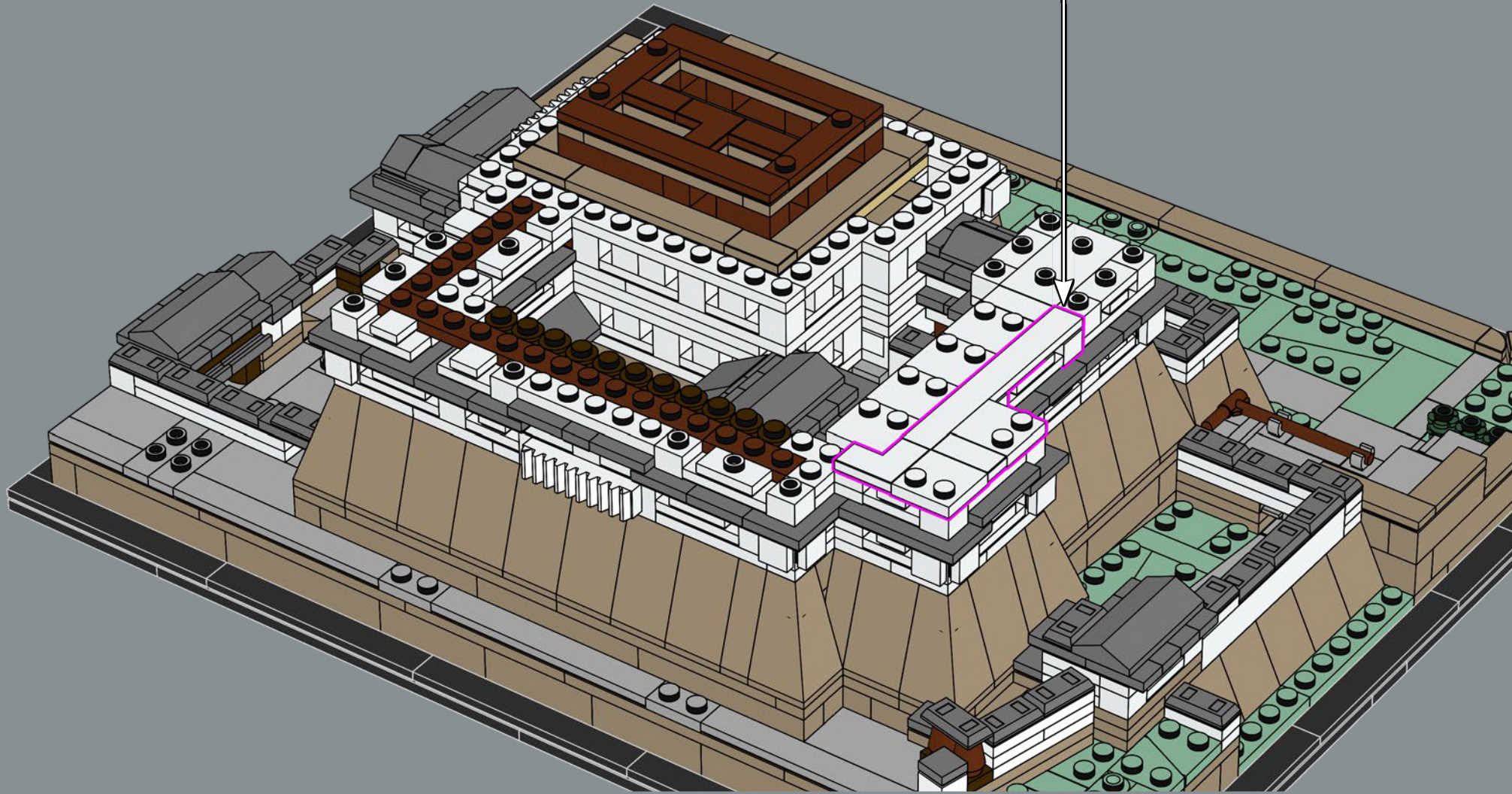
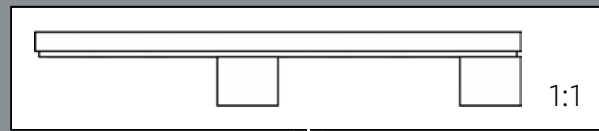

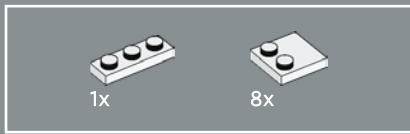

219

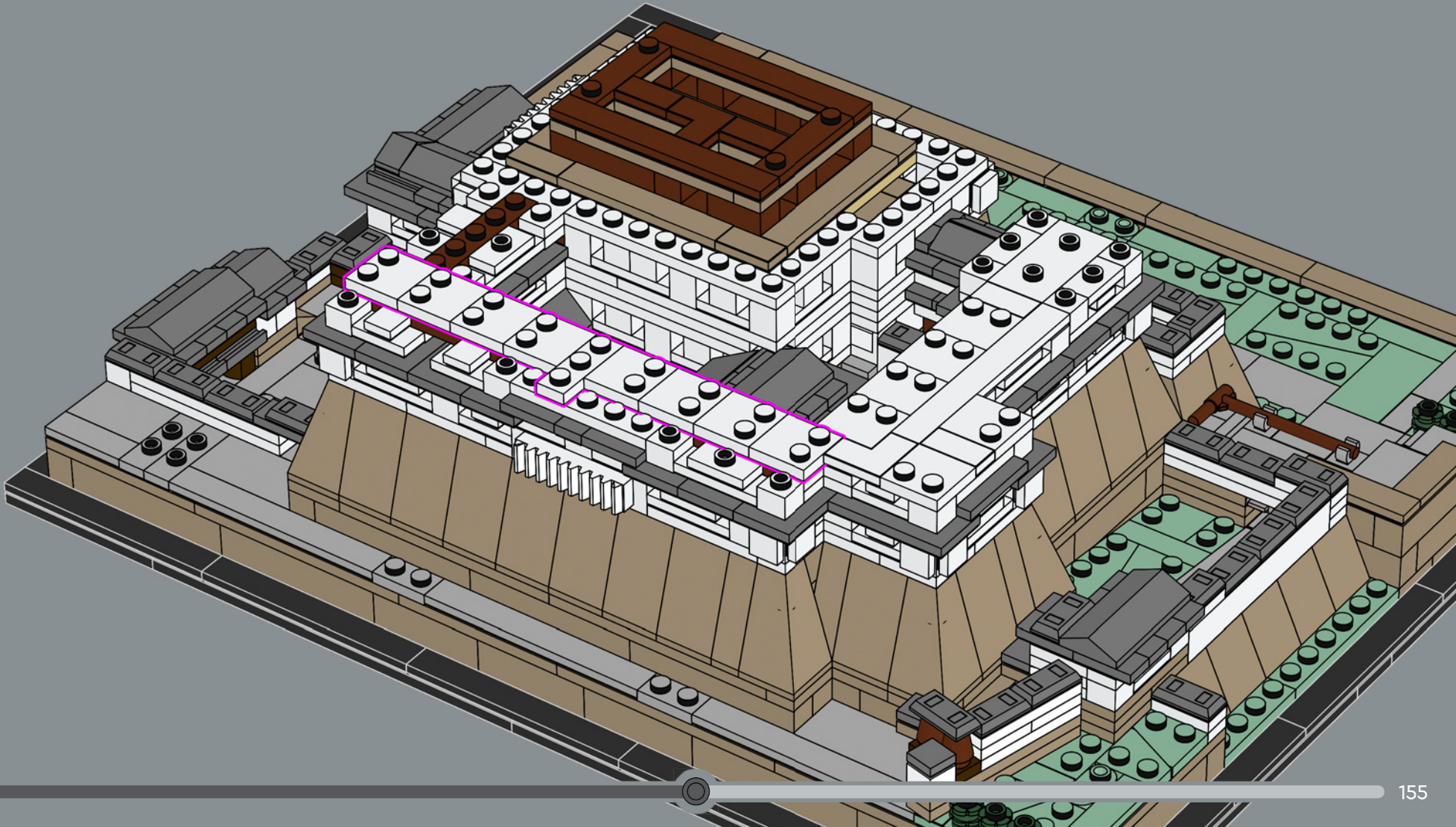

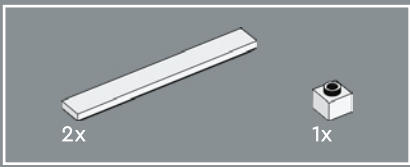

220

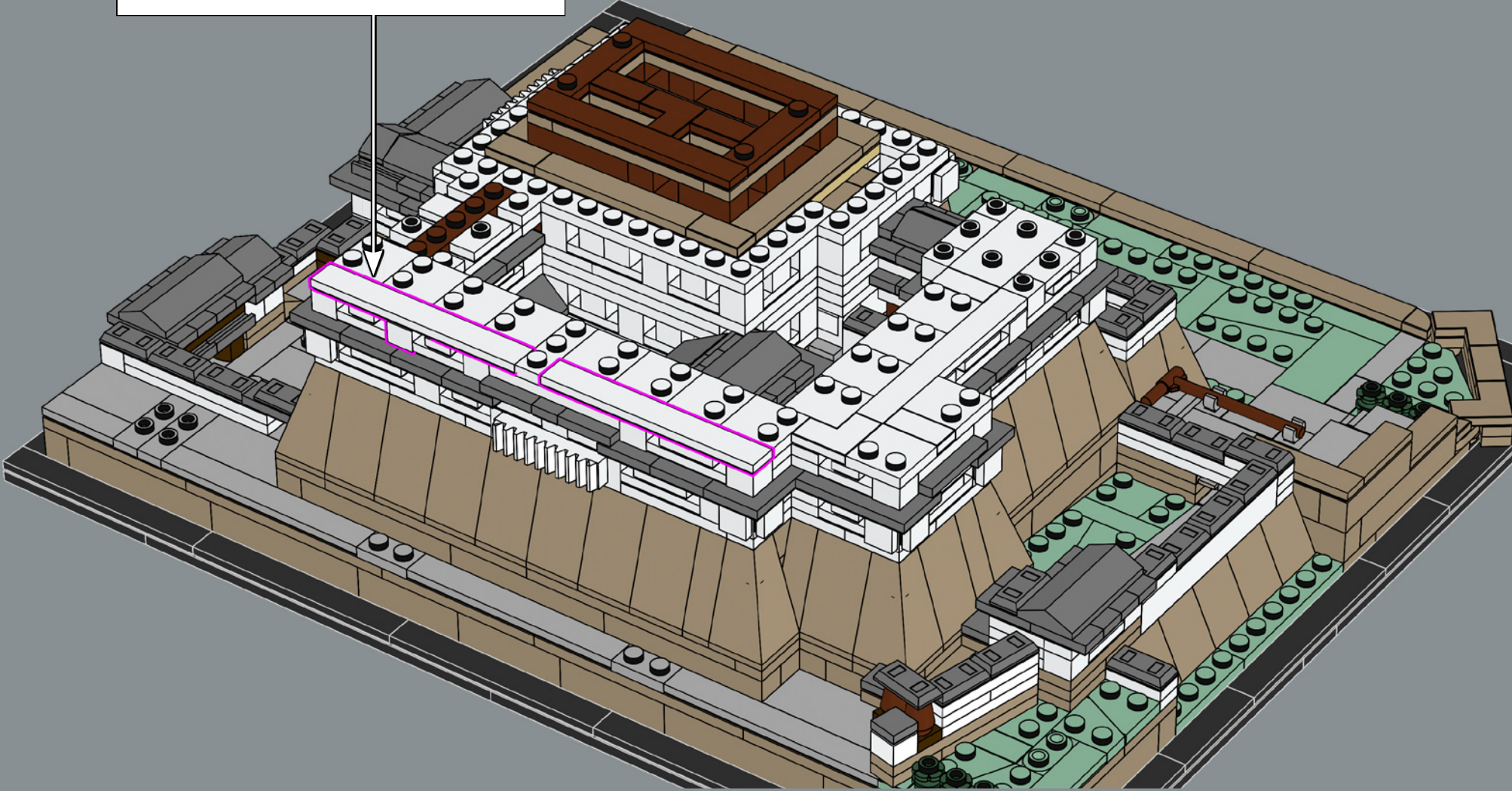

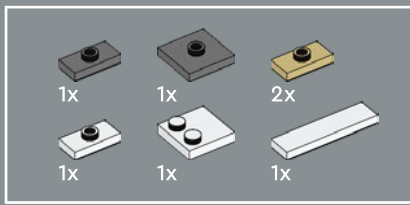

221

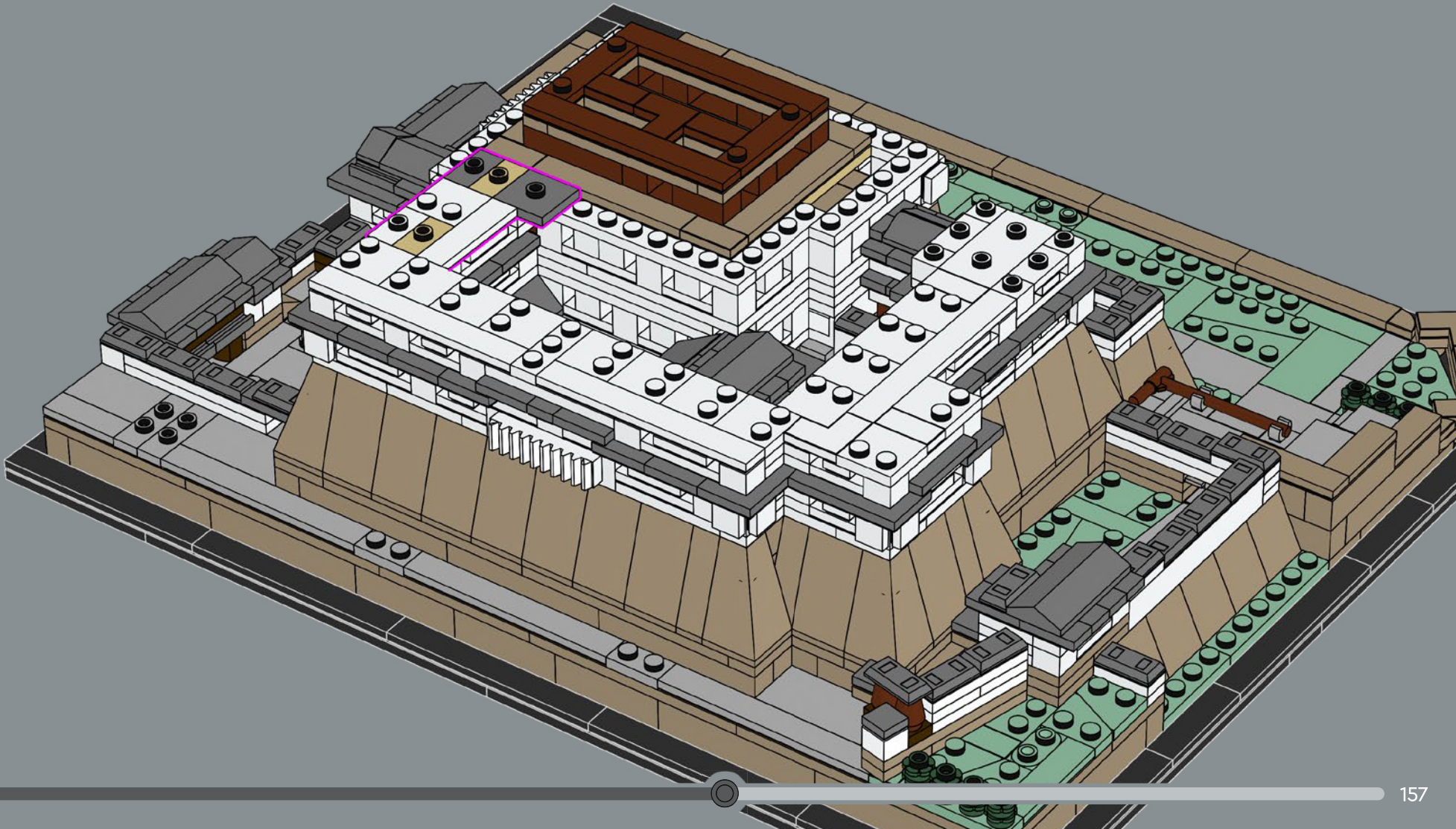

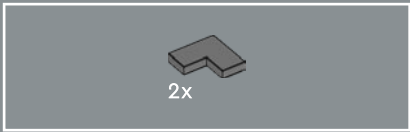

222

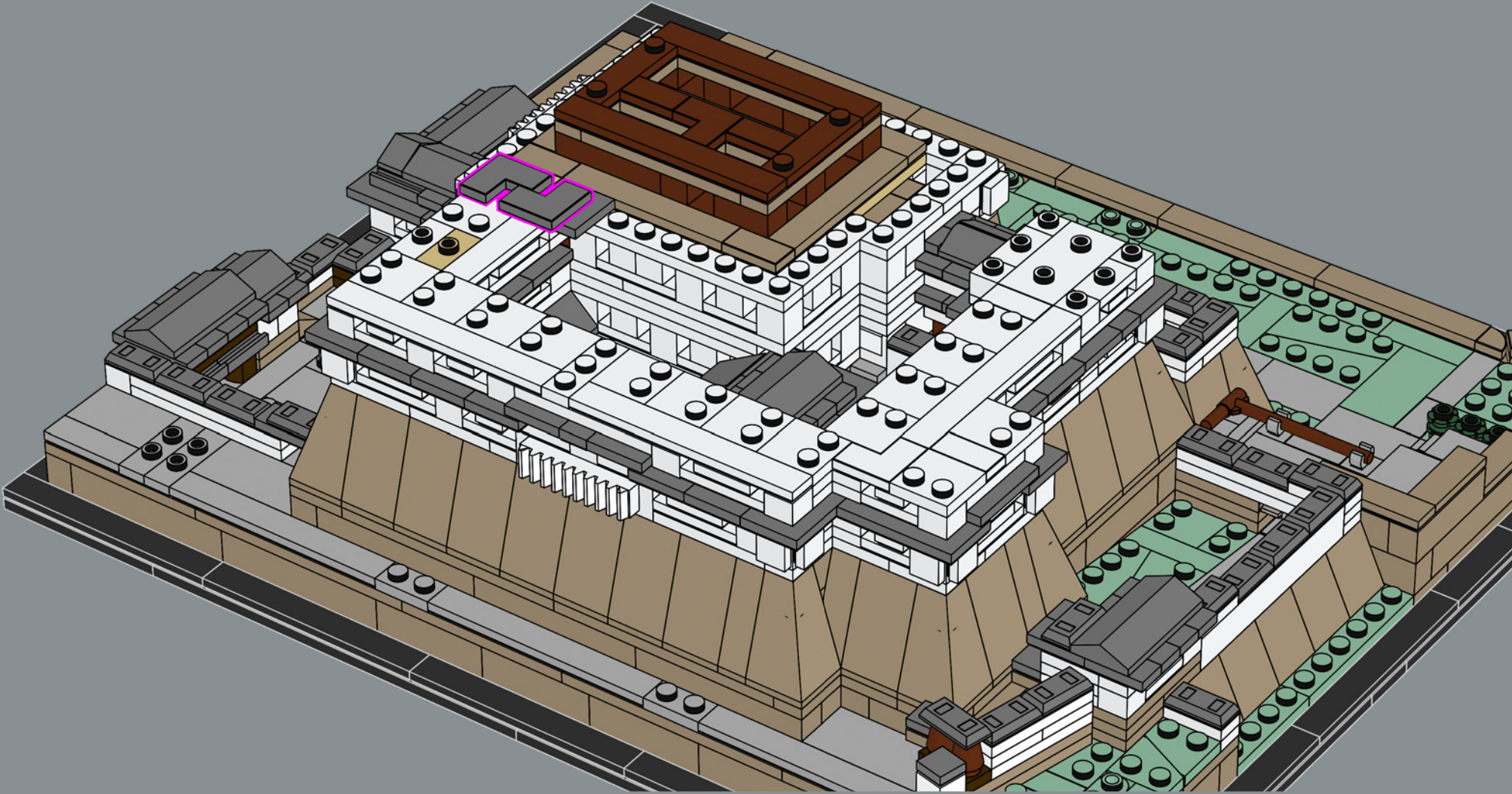

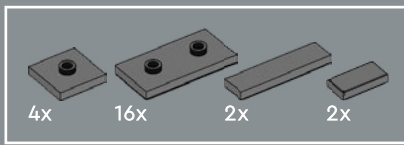

223

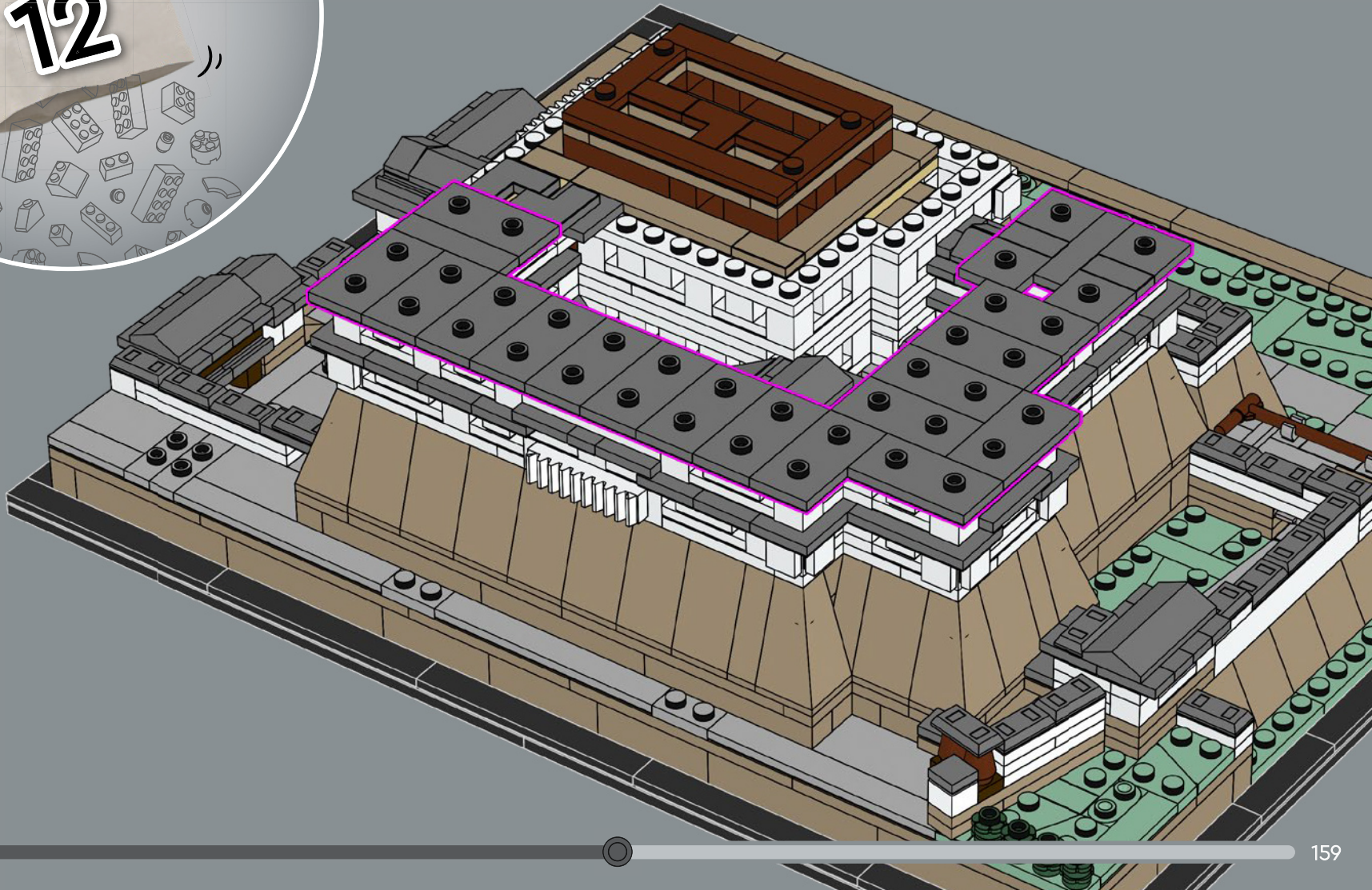

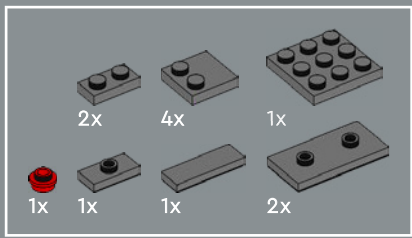

224

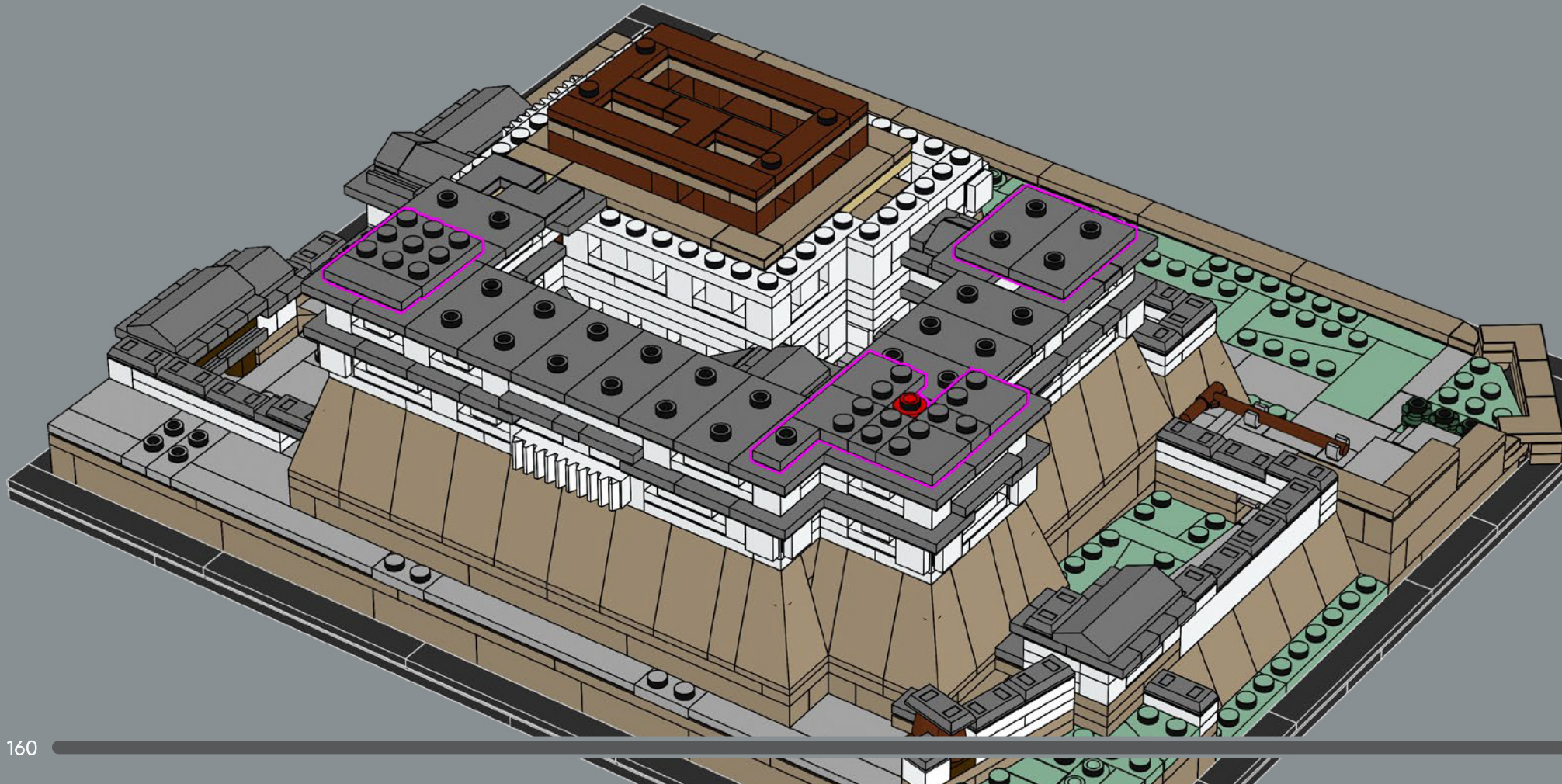

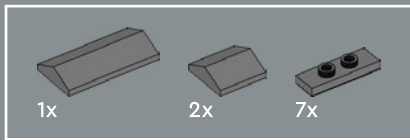

225

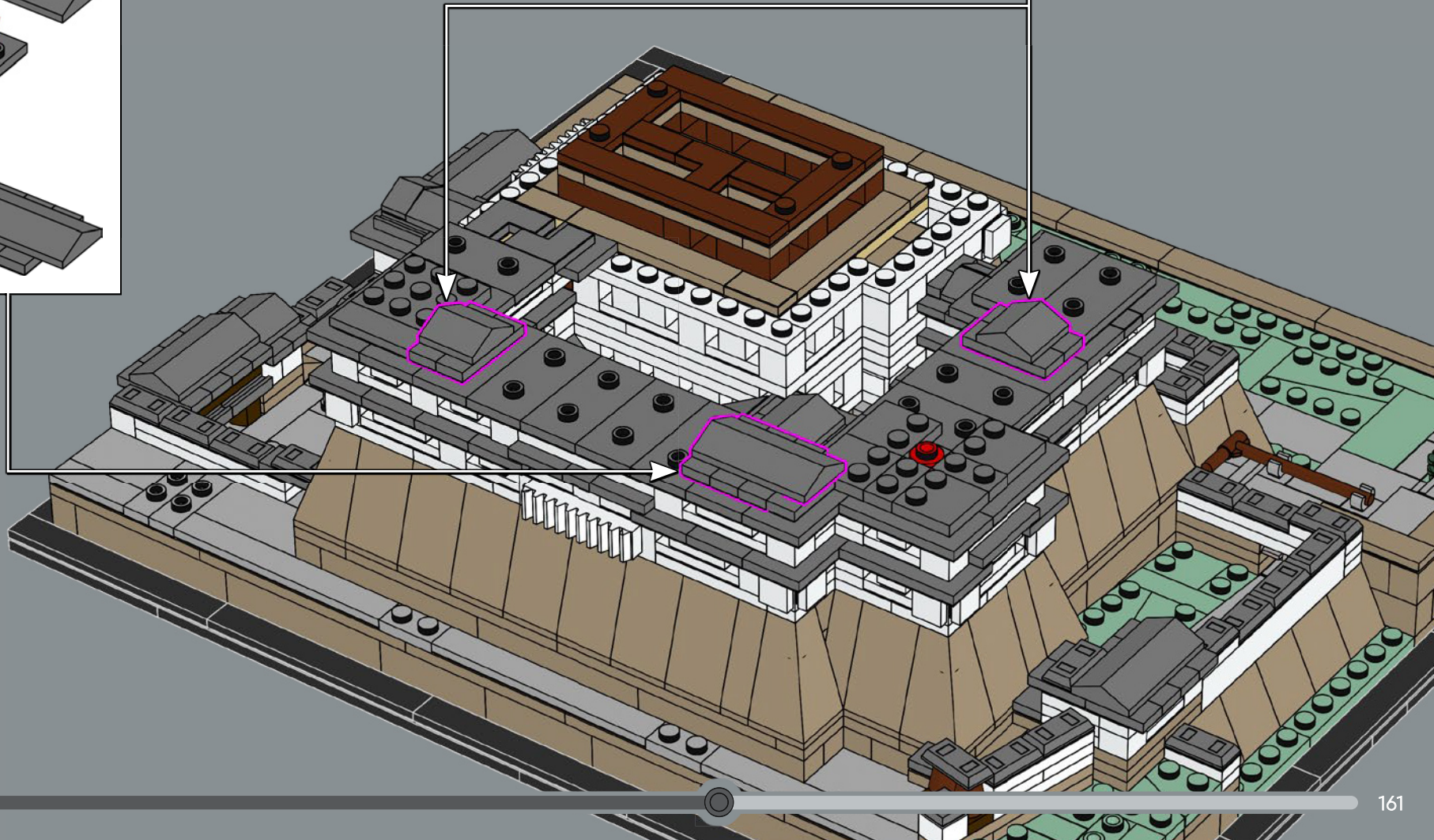
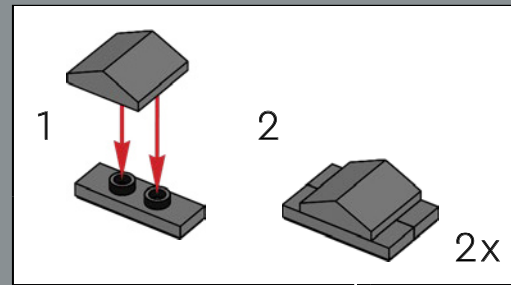
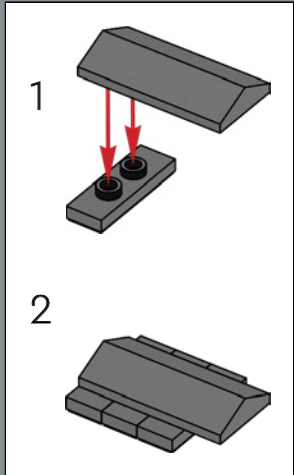

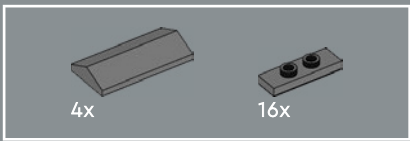

226

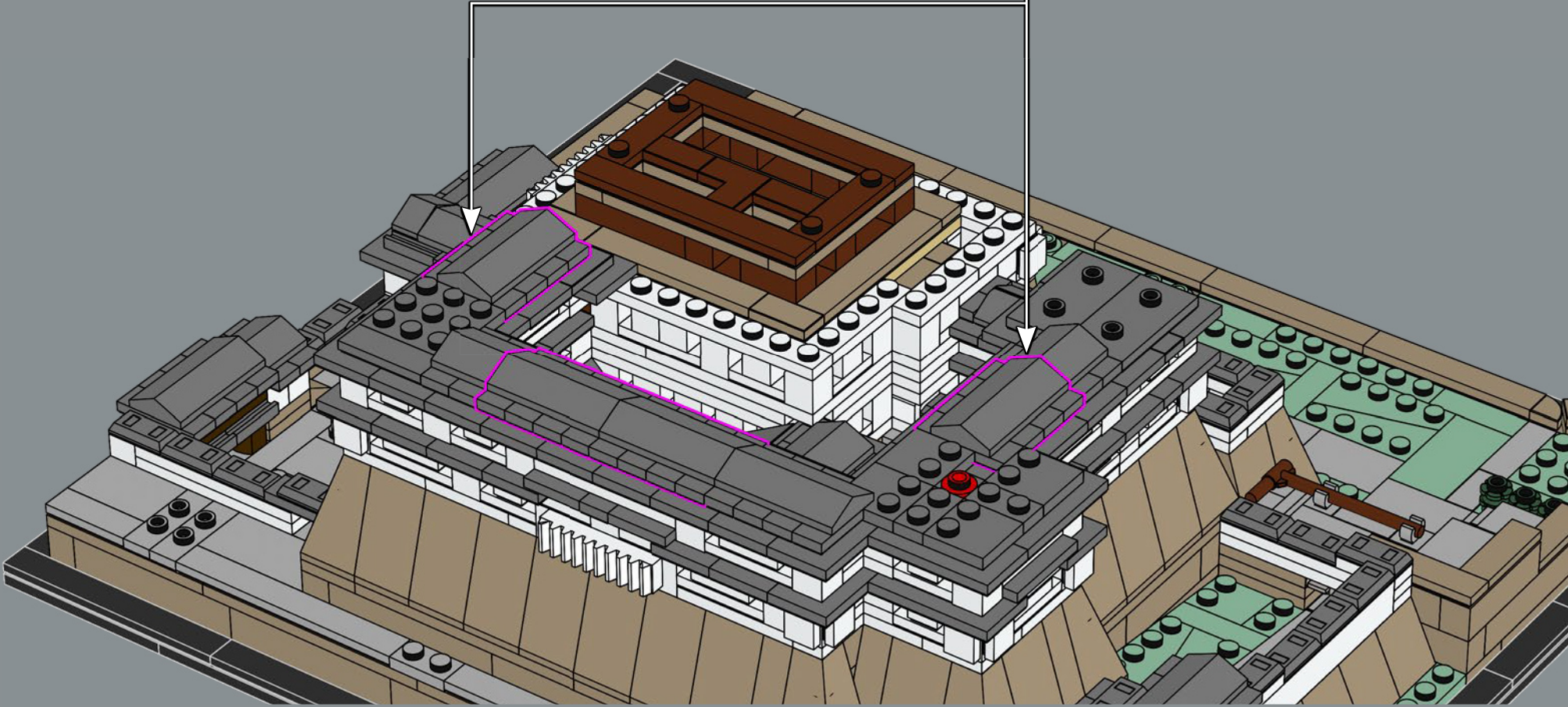
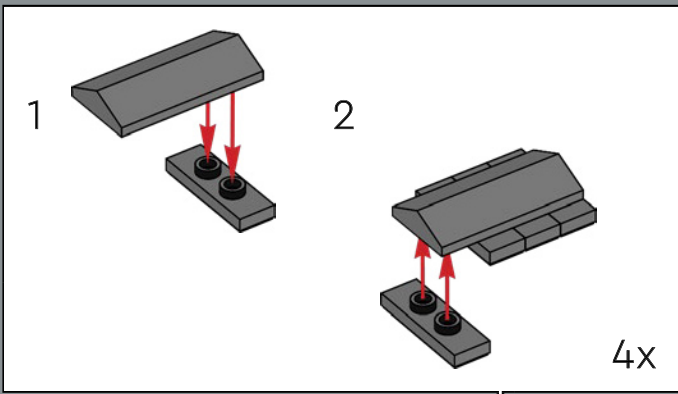

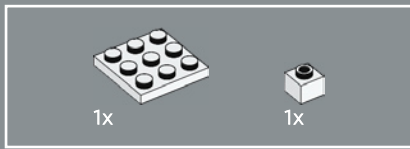

227

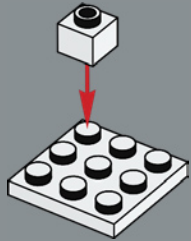

228

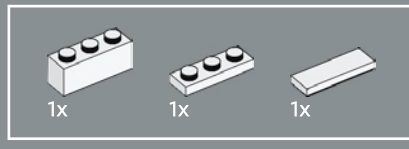
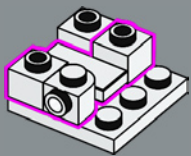

229

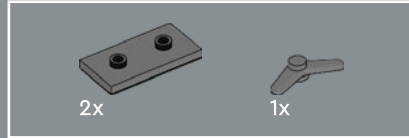
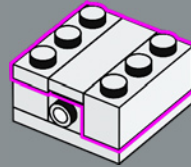

230

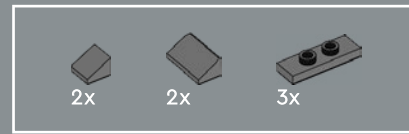
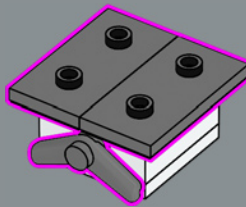

231

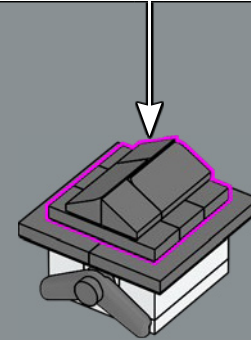
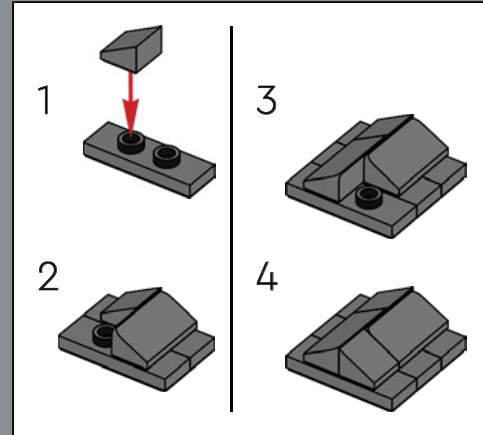

After years of exposure, the white clay on the roof starts to get dirty, slowly changing the appearance and colour of the roof.

232

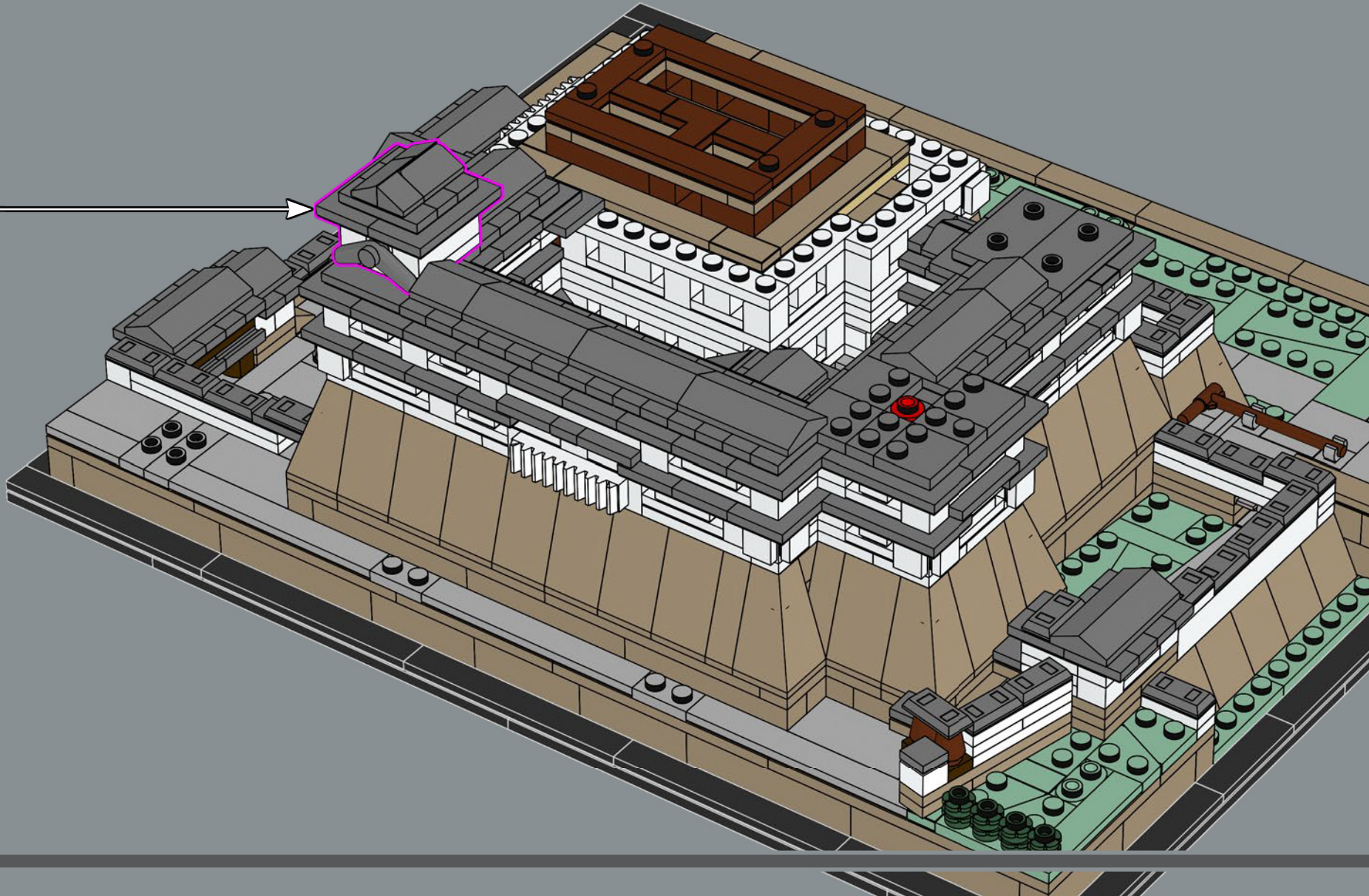

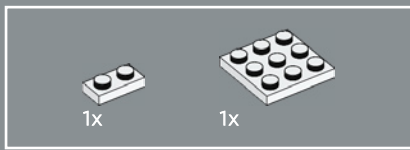

233

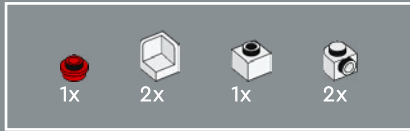
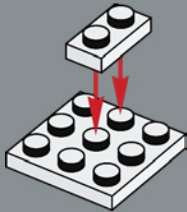

234

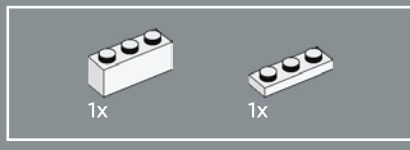
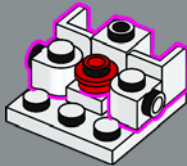

235

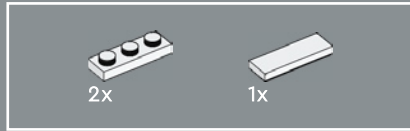
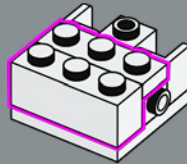

236

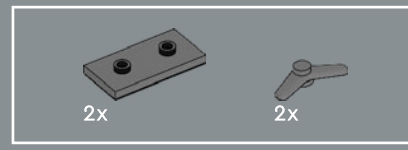
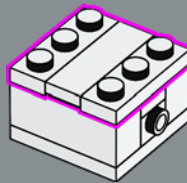

237

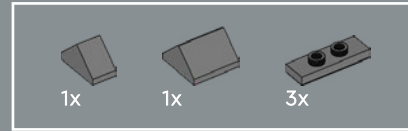
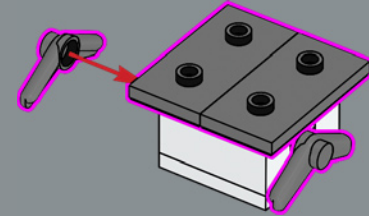

238

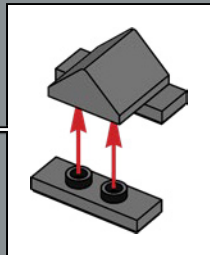
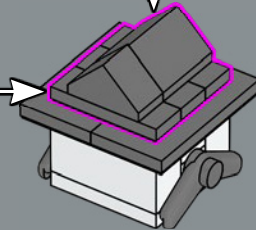
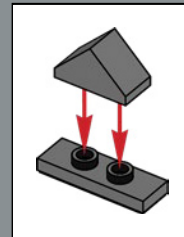

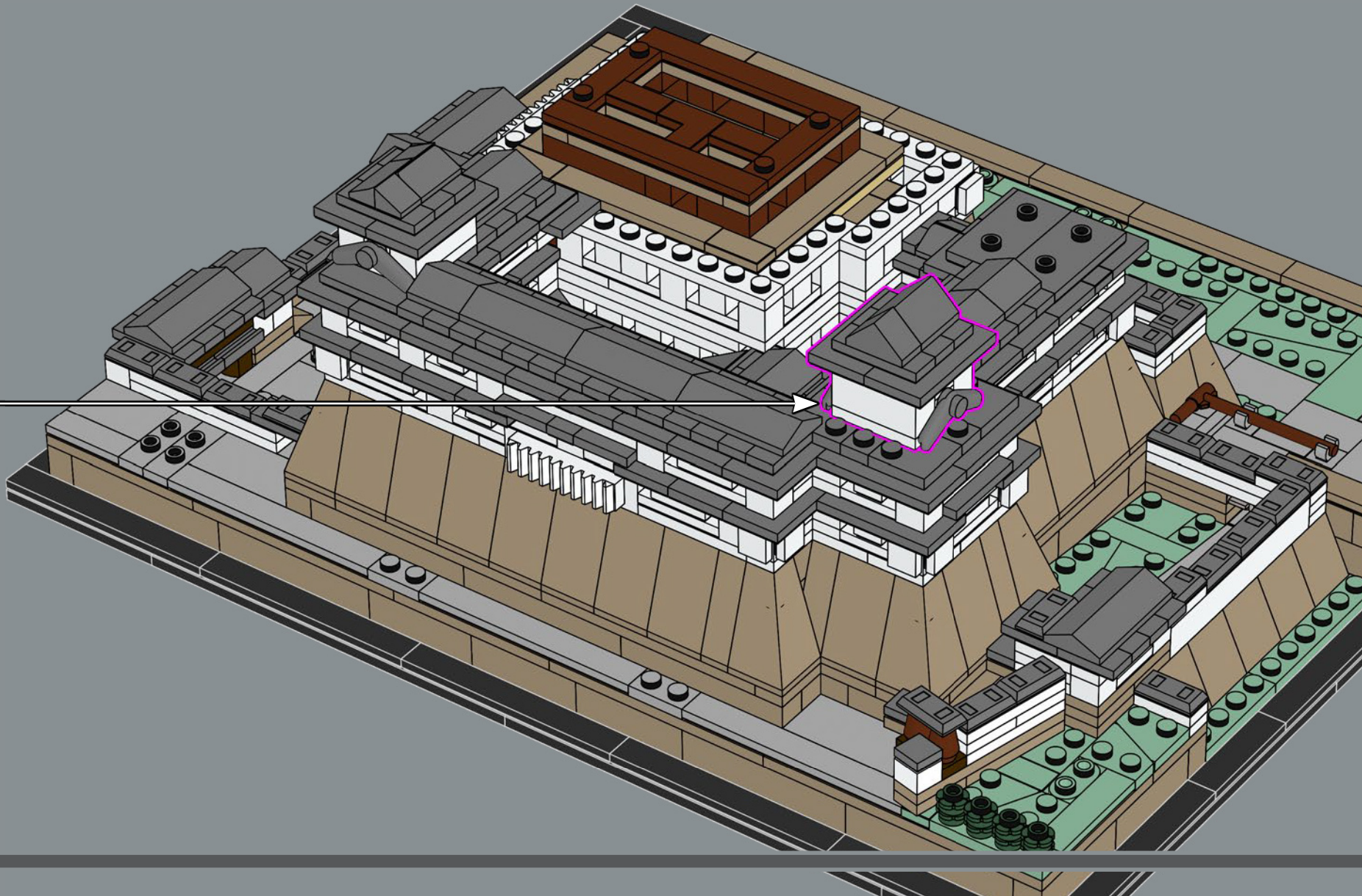



240

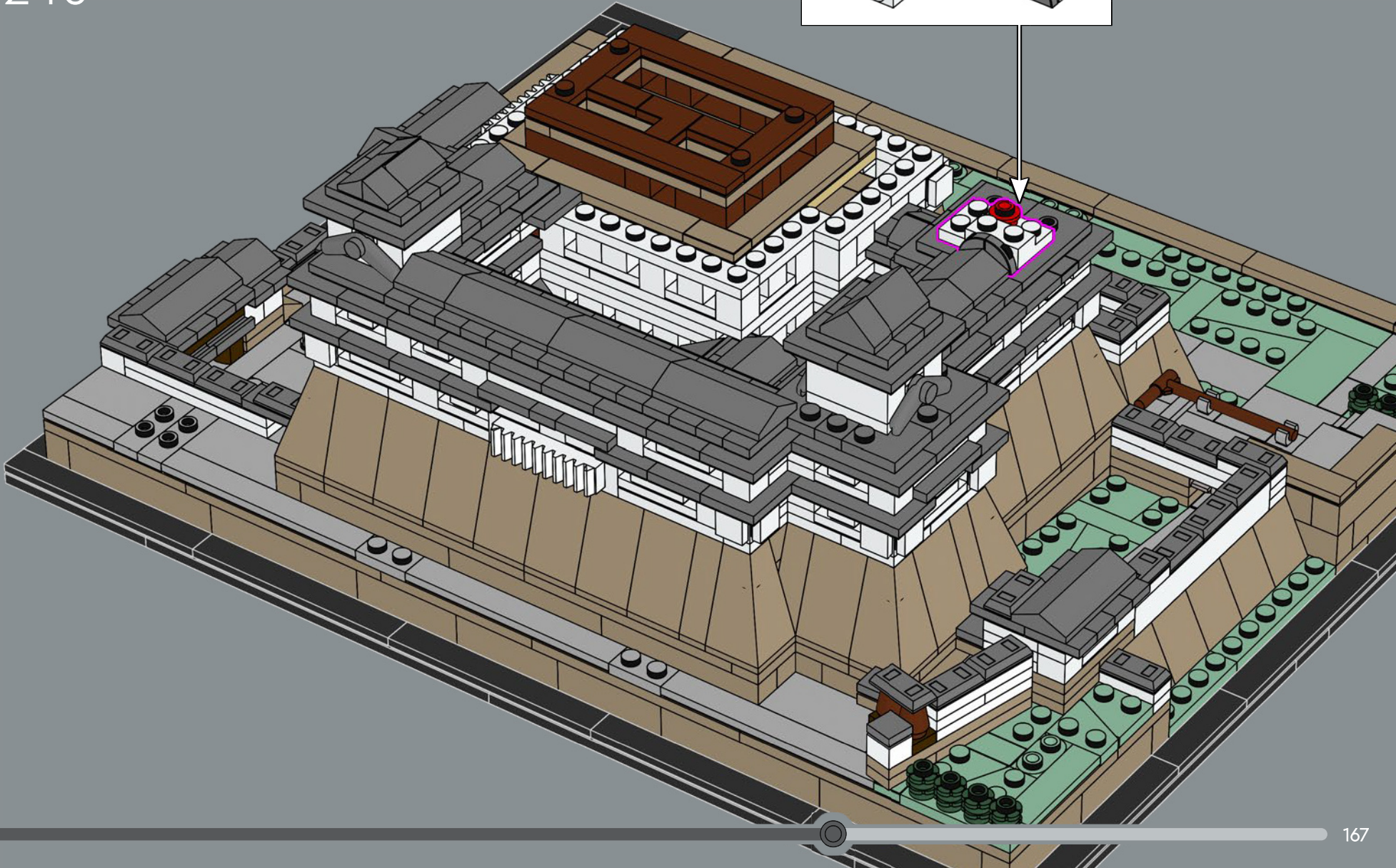
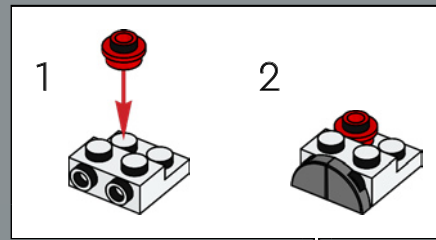

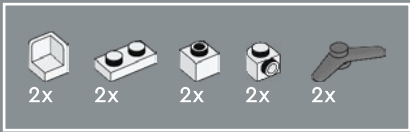

241

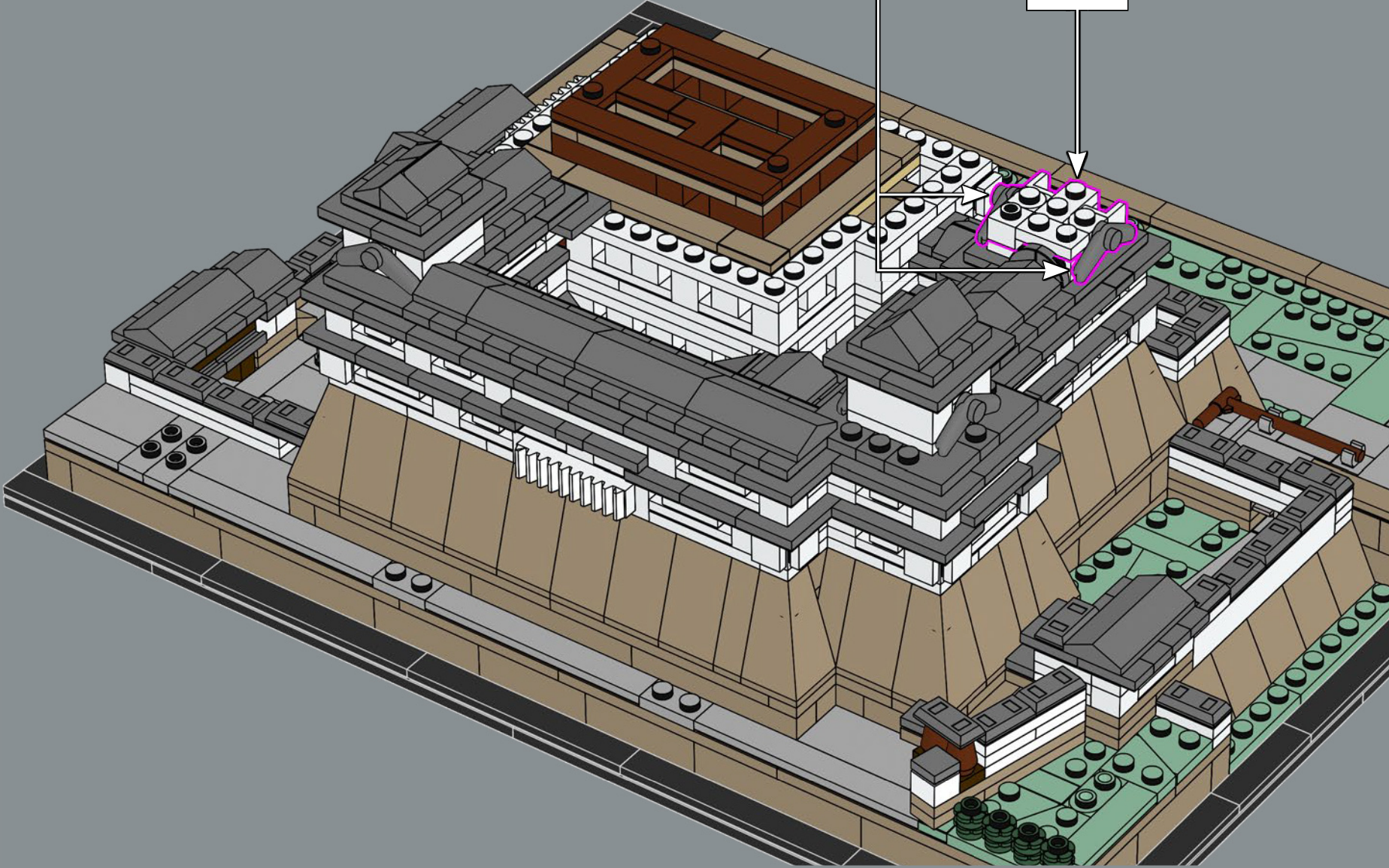
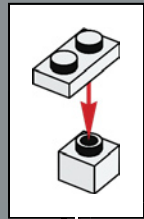
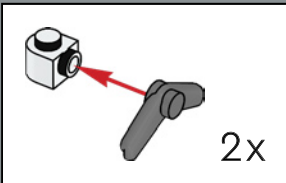

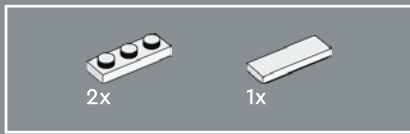

242

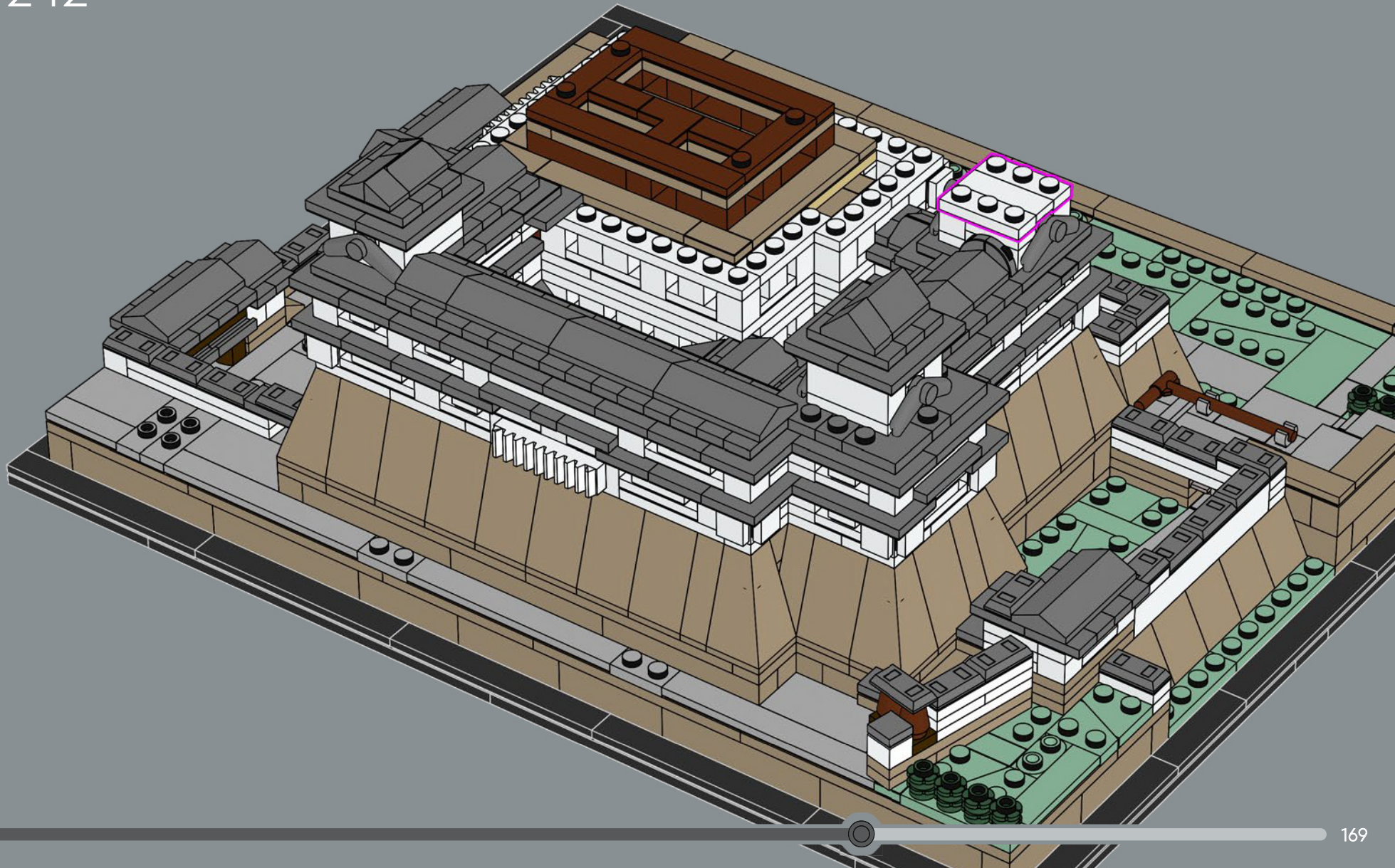

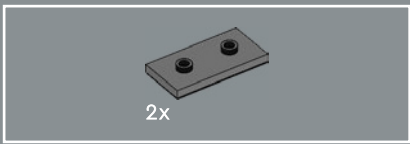

243

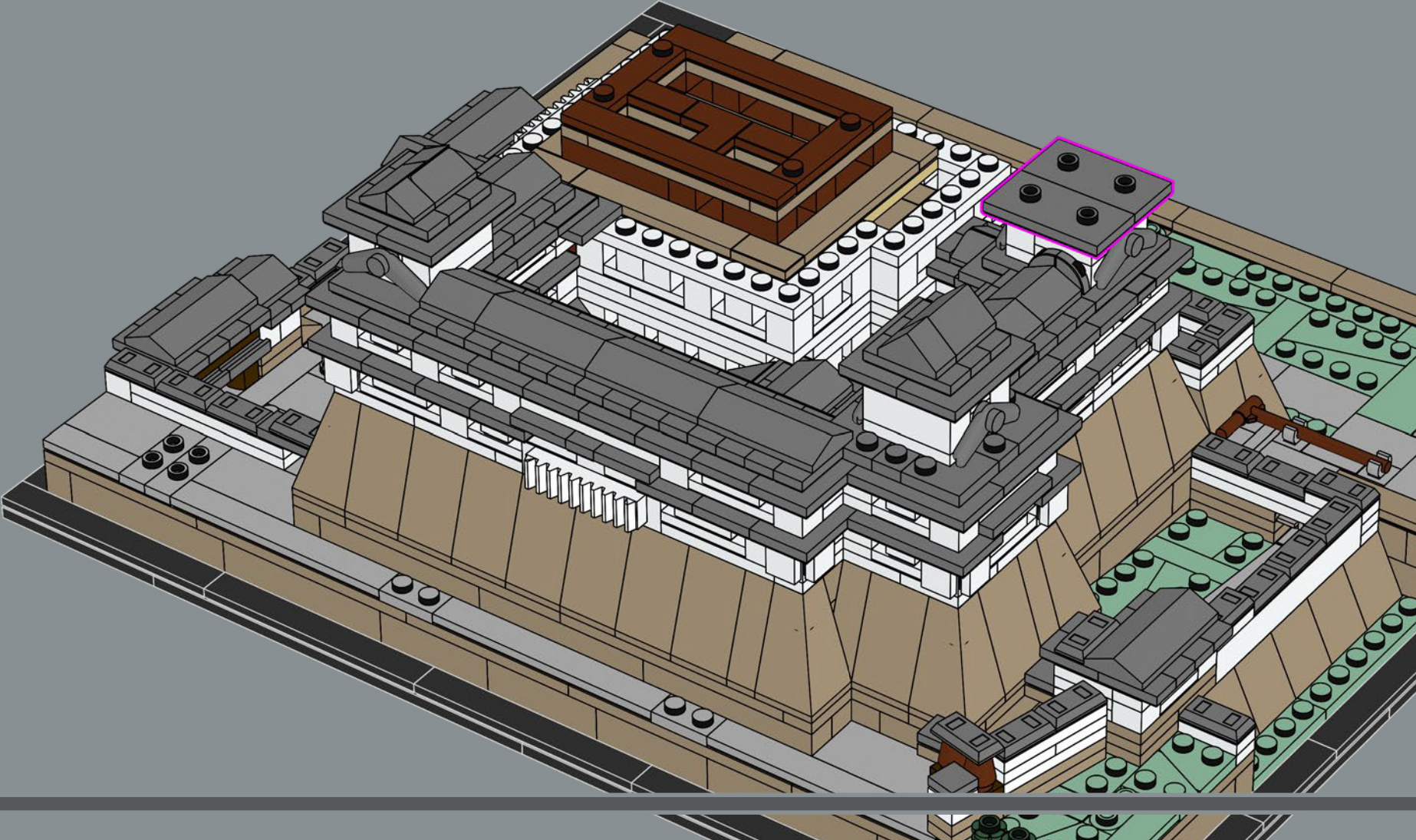

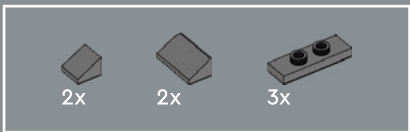

244

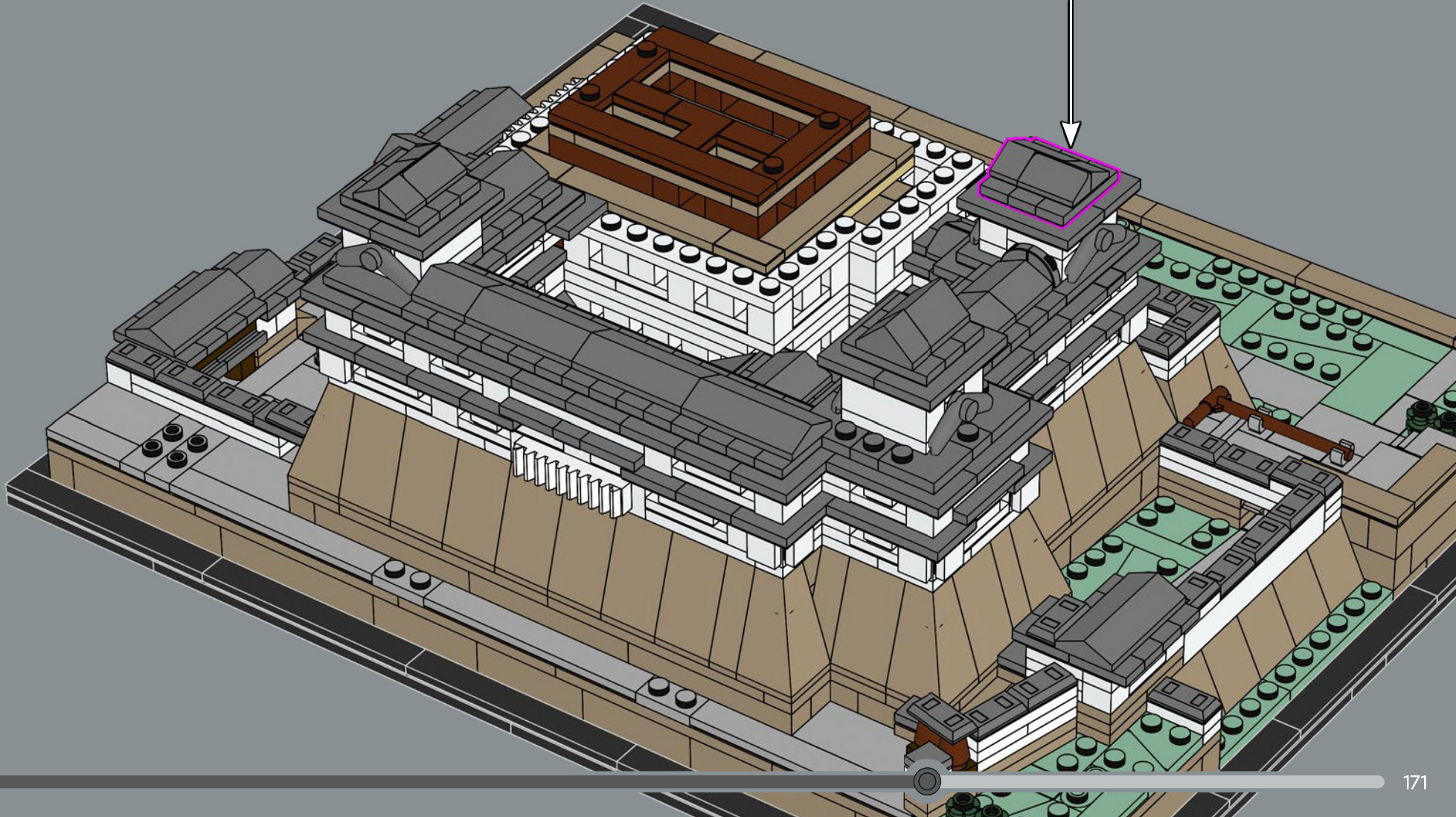
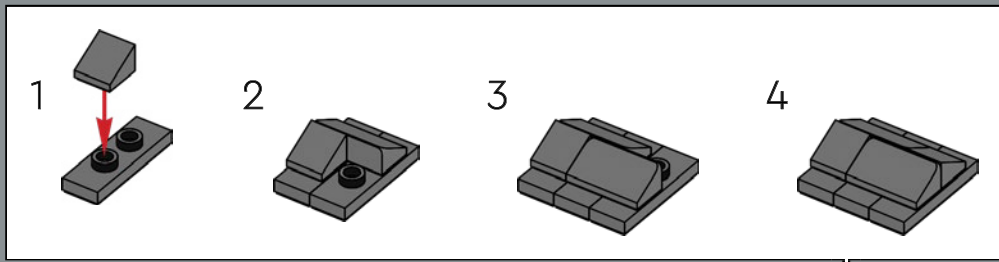

The new bowed 2x2 corner element is only the second NEW element to be approved for a LEGO® Architecture set. The first was a similar element in 3x3 size in Robie House 21010, (2011).

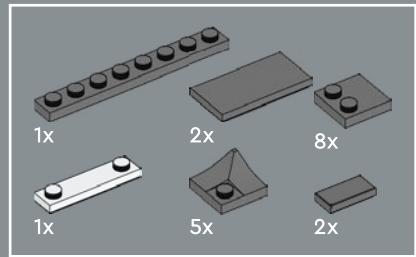

245

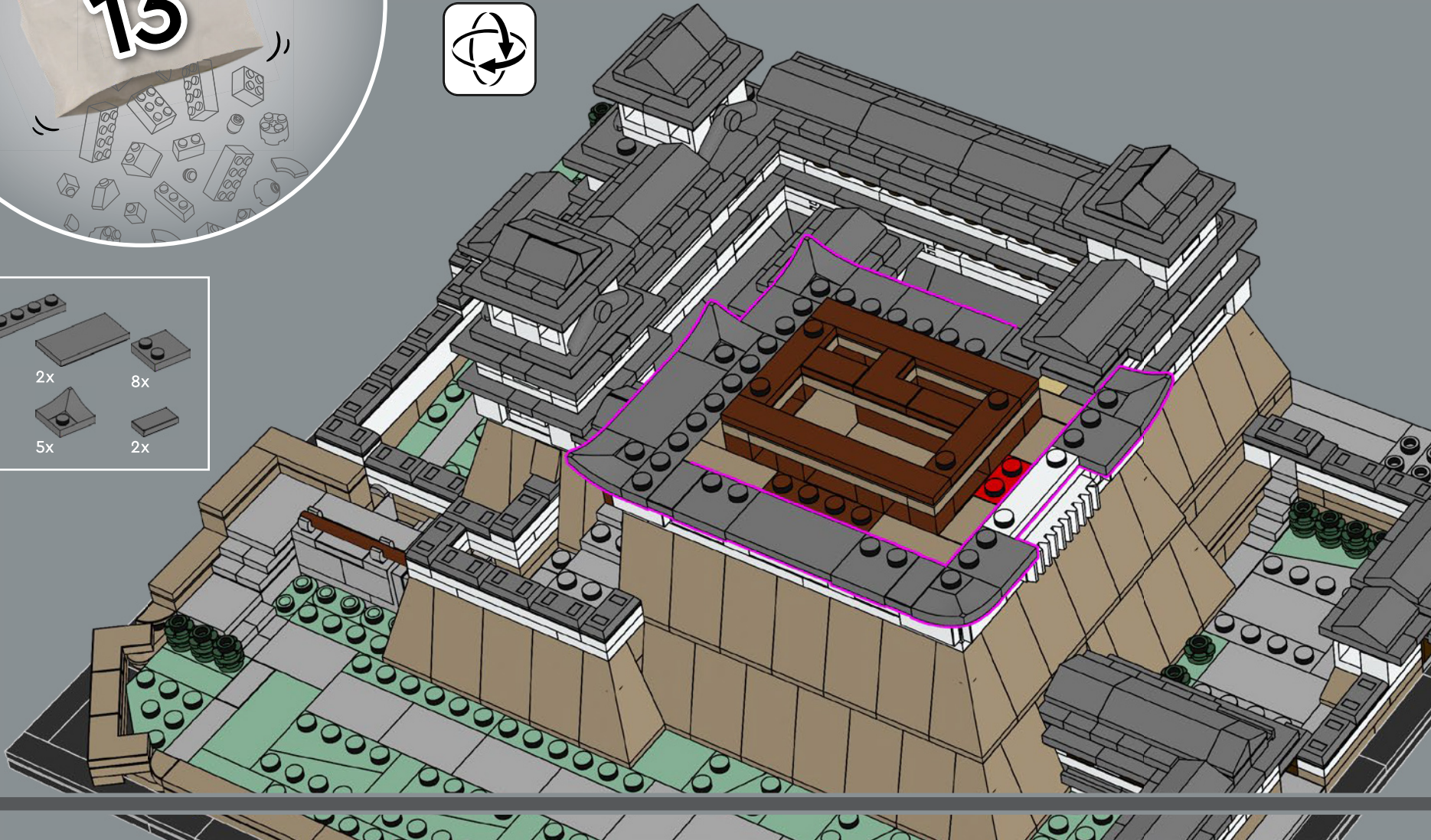

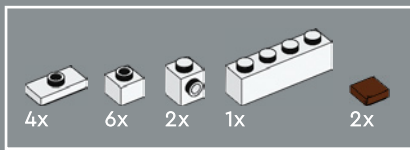

246

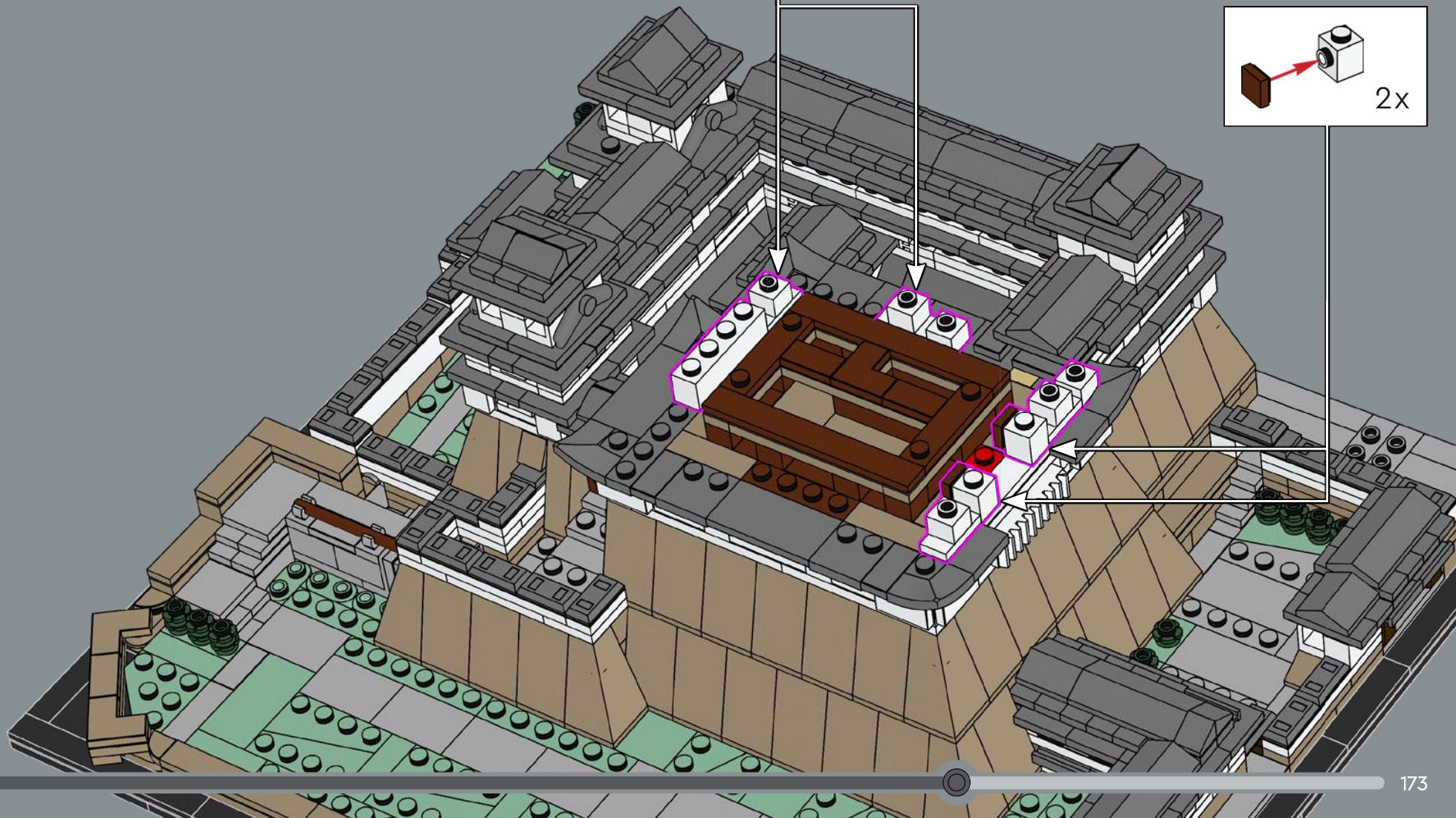
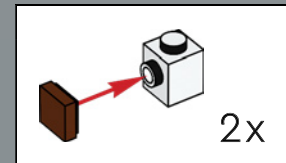
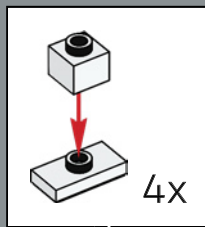

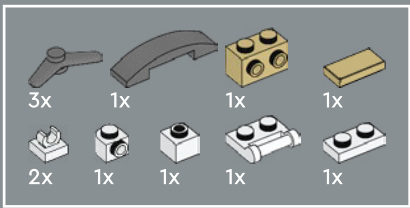

247

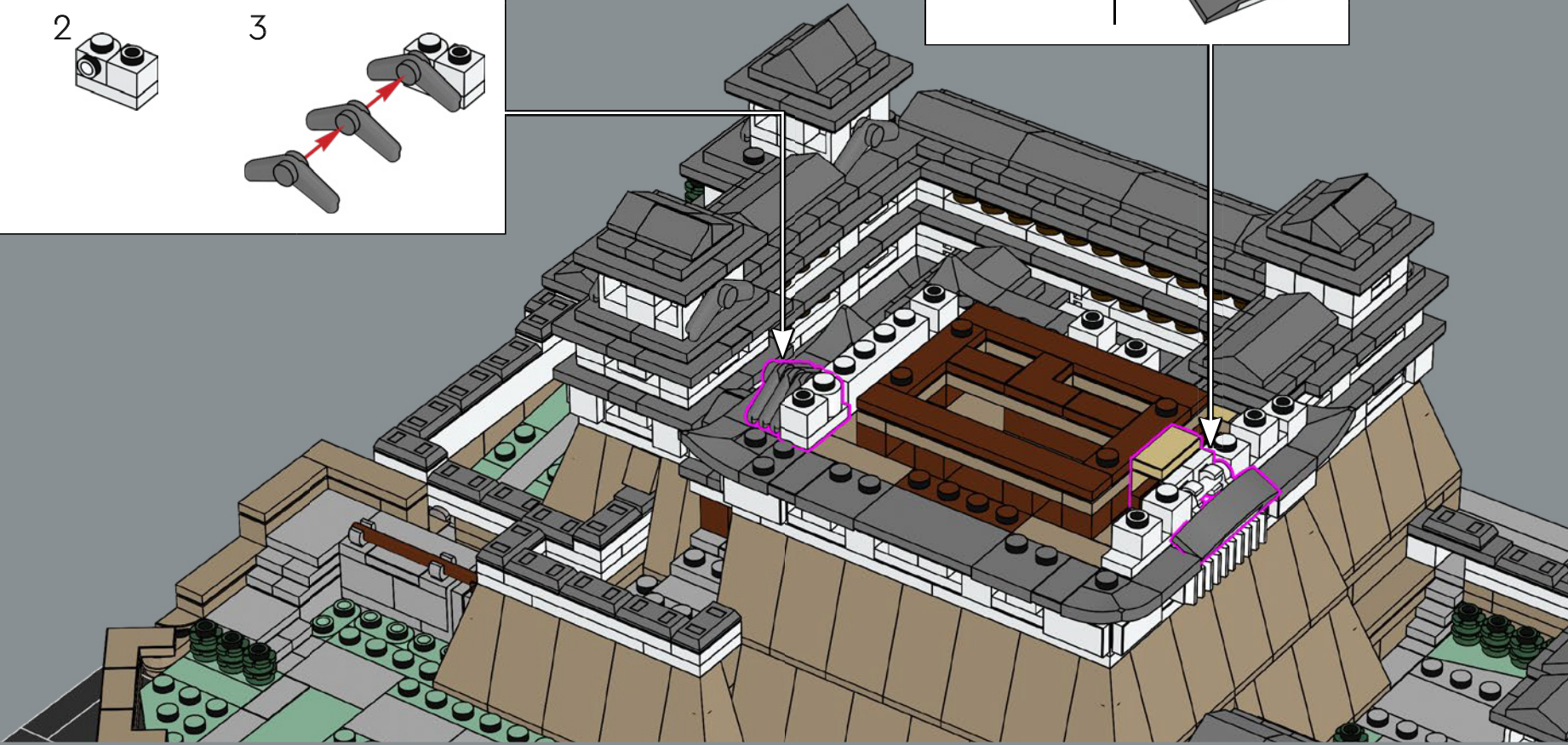
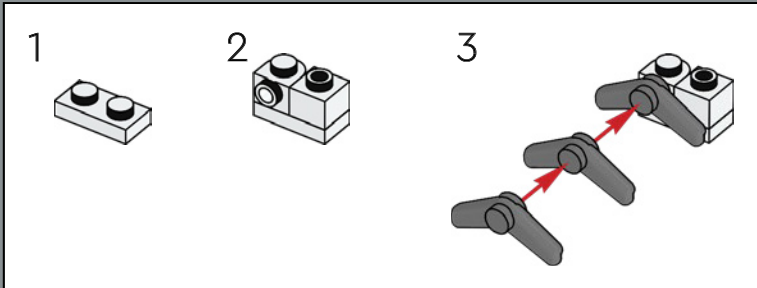
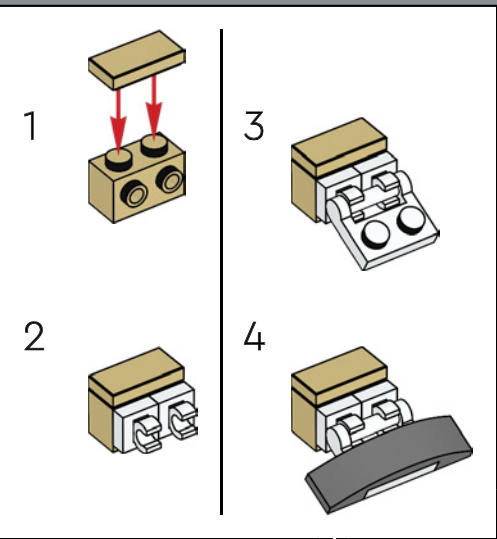

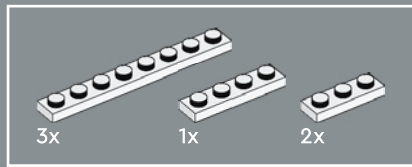

248

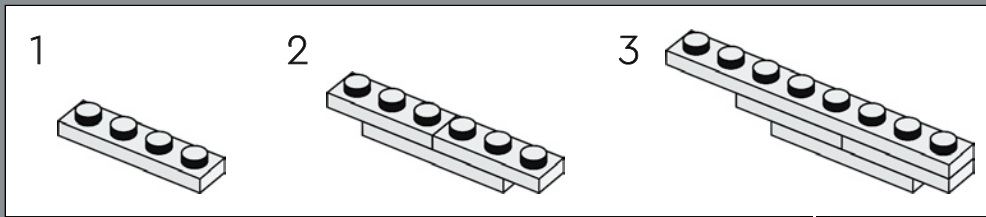

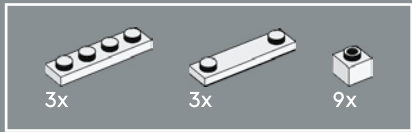
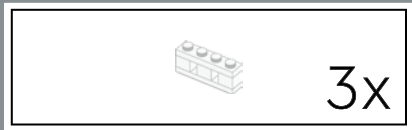

249

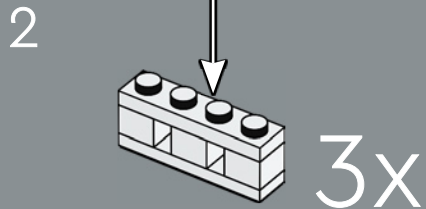
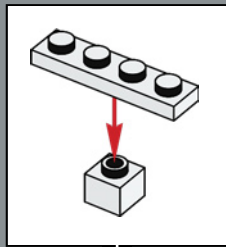
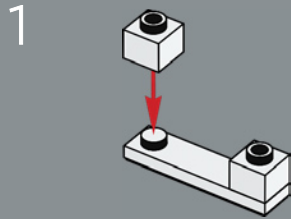

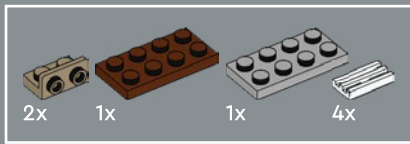

250

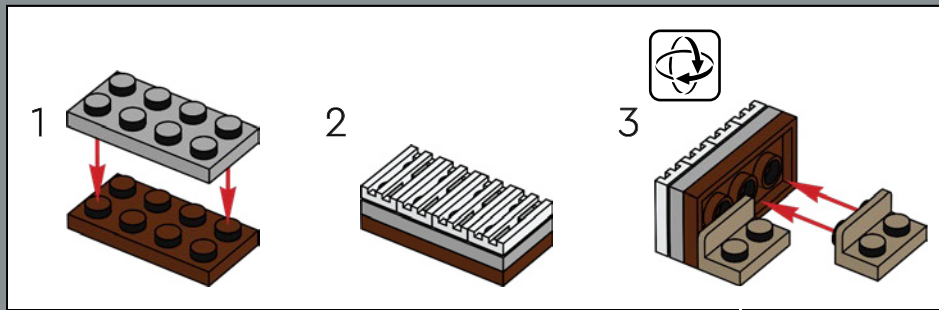

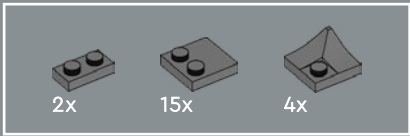

251



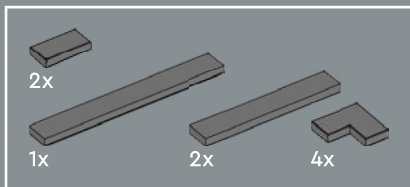

252

The top part of the structure can be removed to reveal some of the interiors, including the mostly empty council area to show what it looked like during the 2009-2015 renovation.

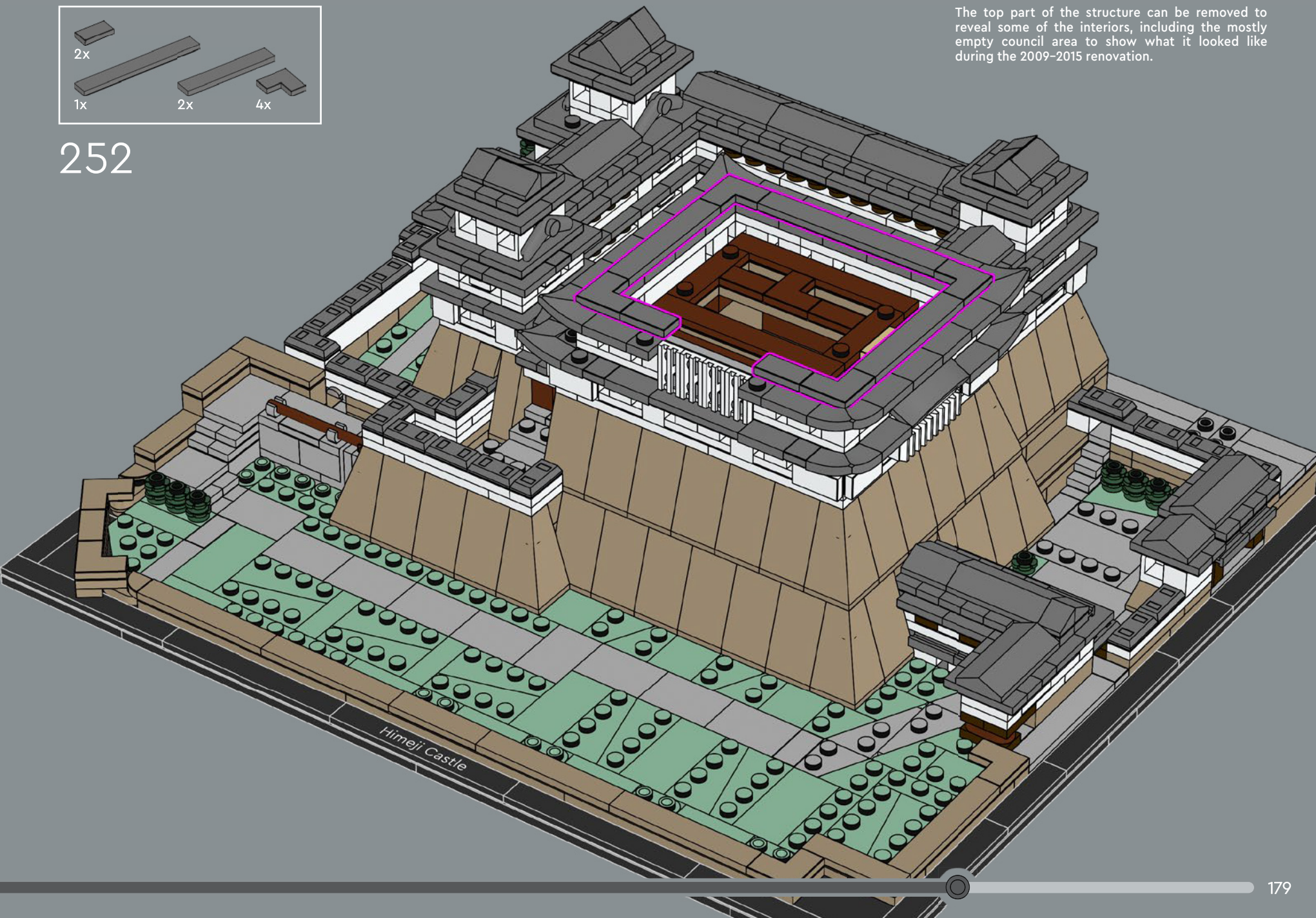

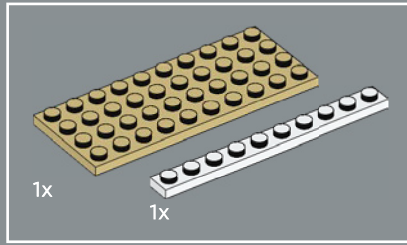
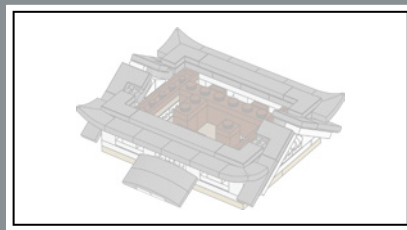

253

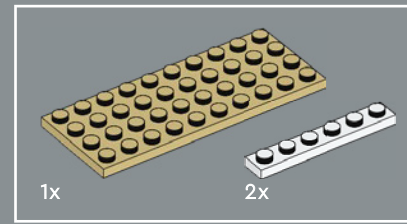
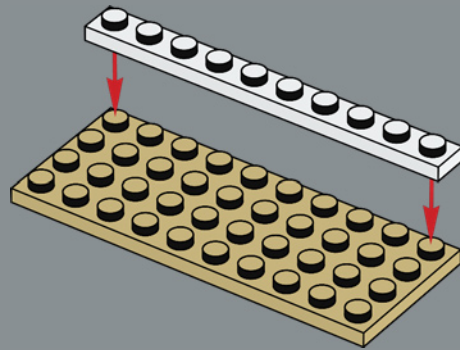

254

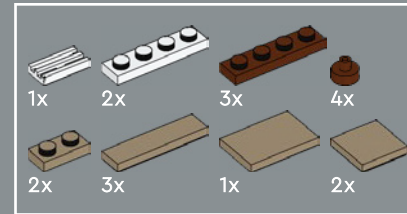
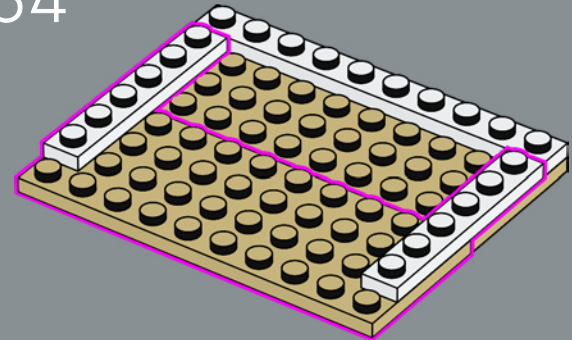

255

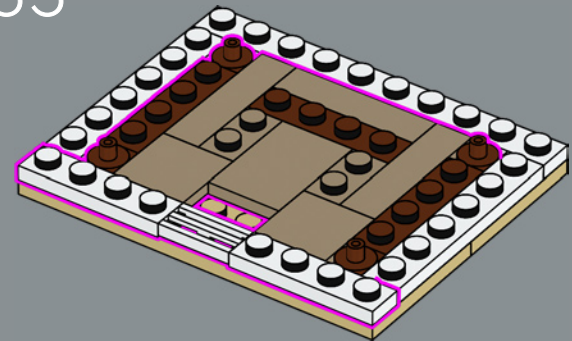

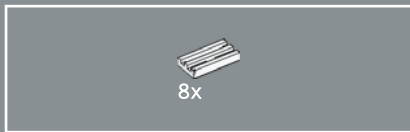

256

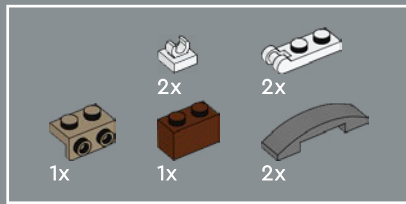
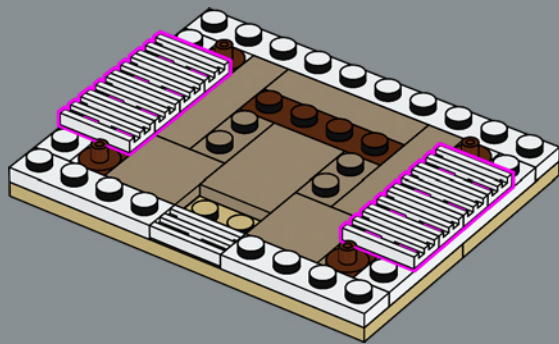

257

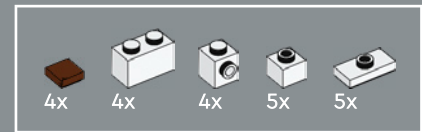
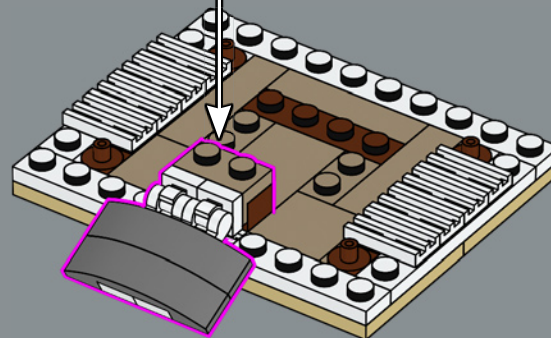
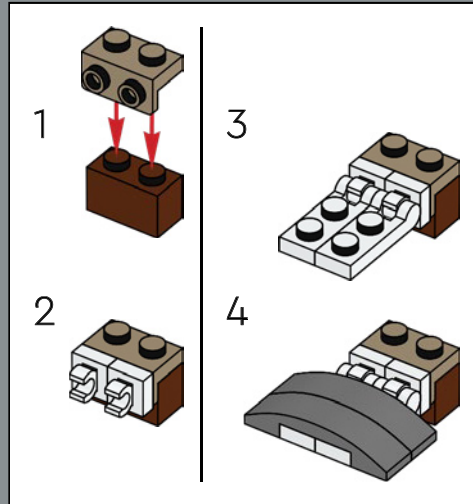

258

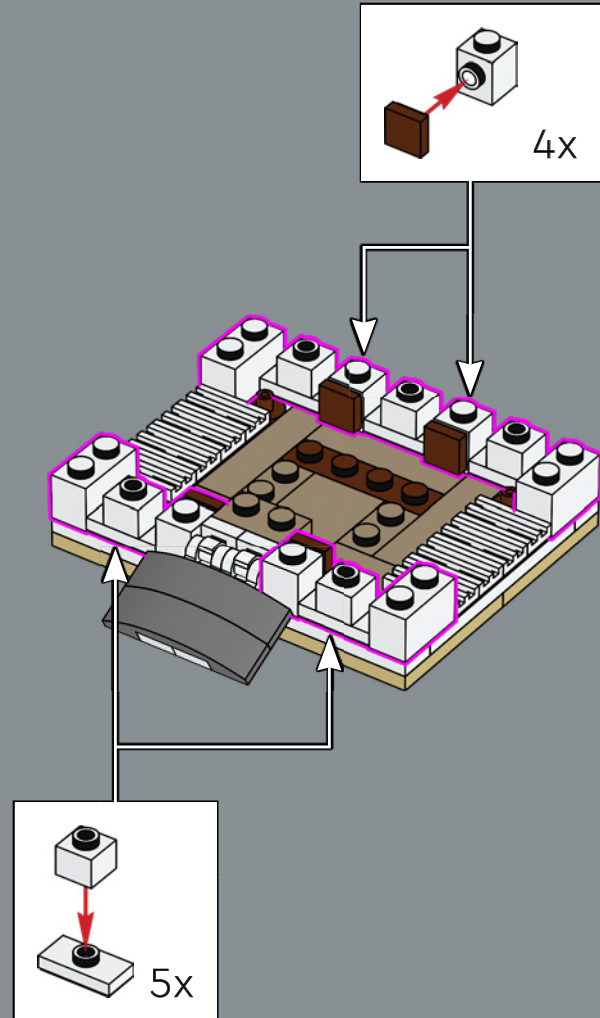

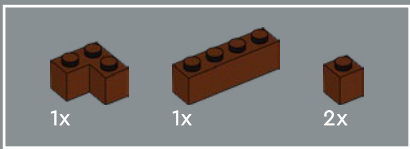

259

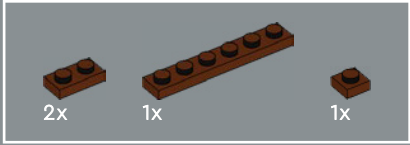
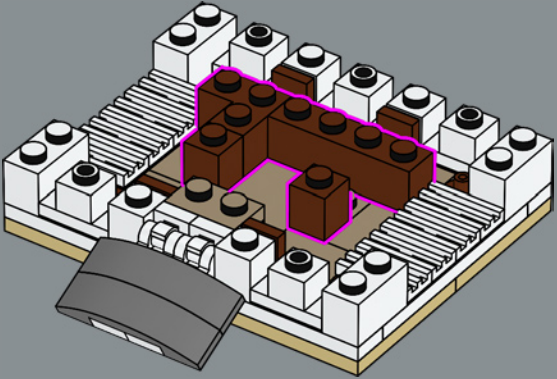

260

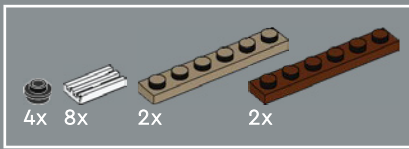
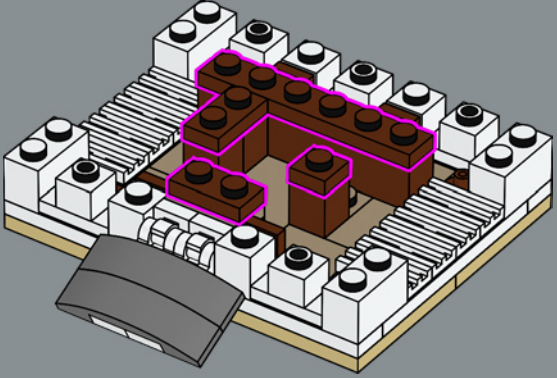

261

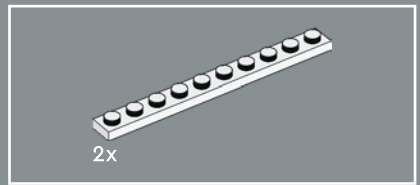
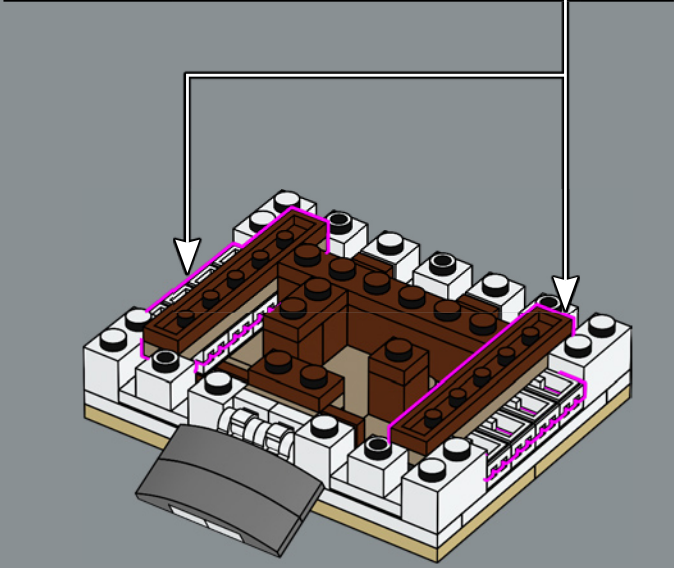
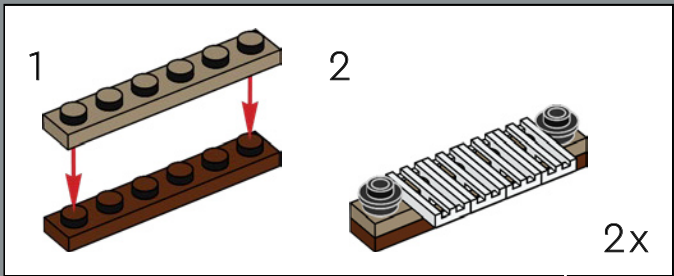

262

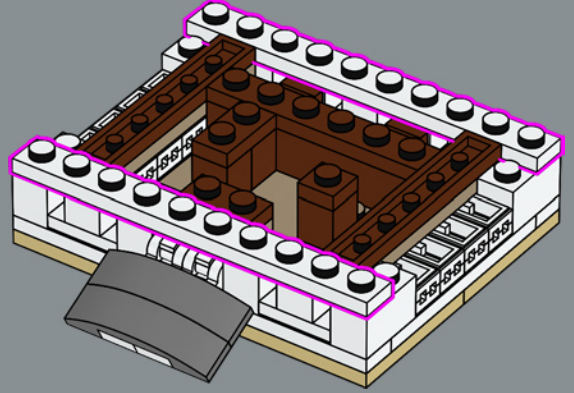

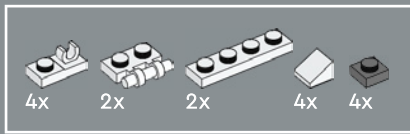

263

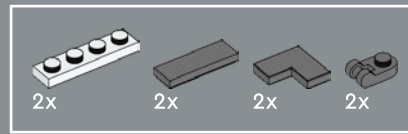
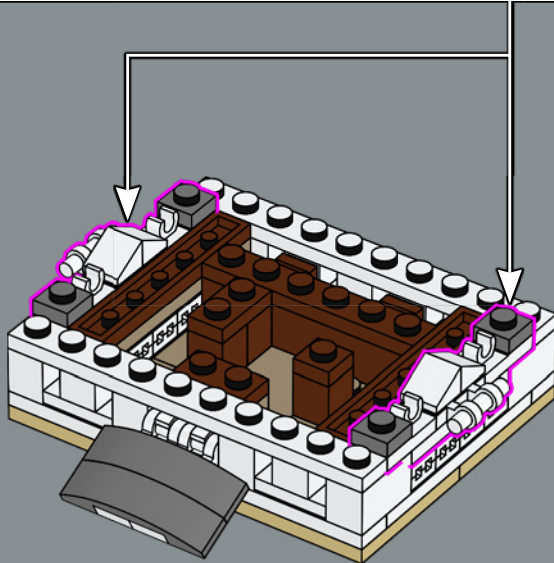
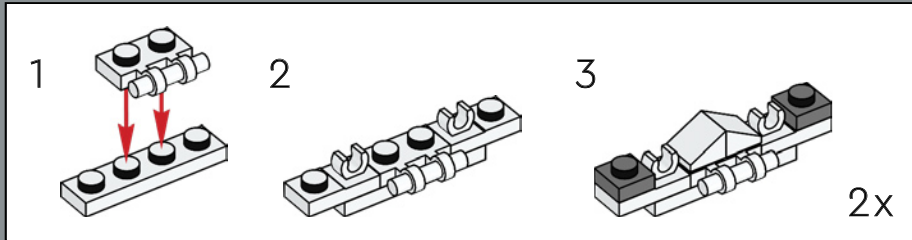

264

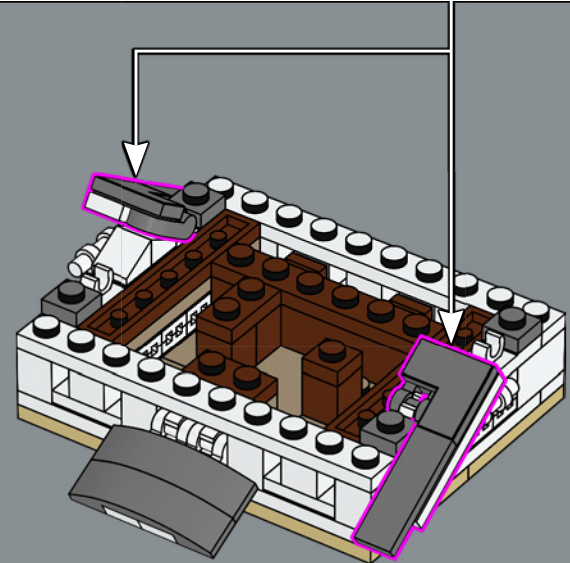
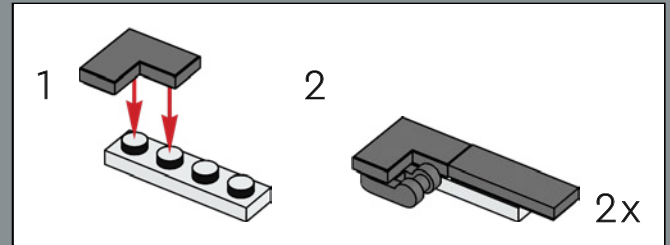

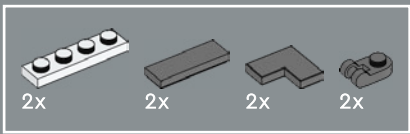

Each floor of the castle's Main Keep has a unique layout that draws from the floor plans of the original castle.

265

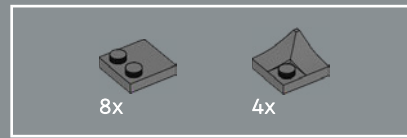
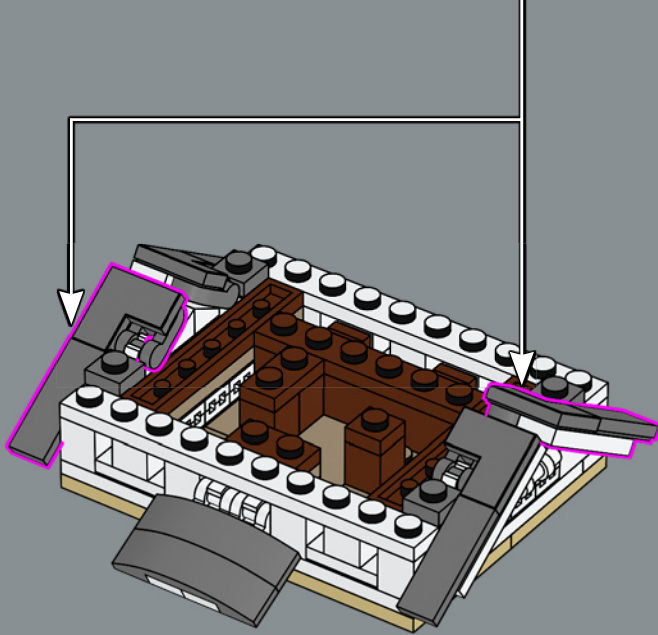
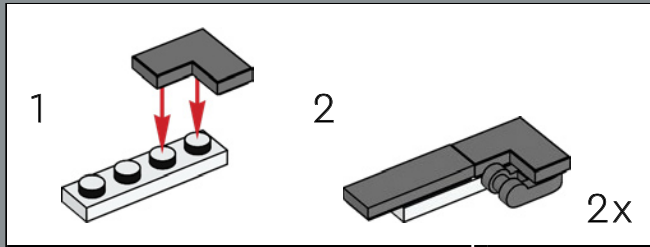

266

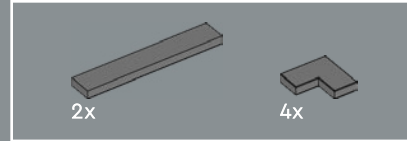
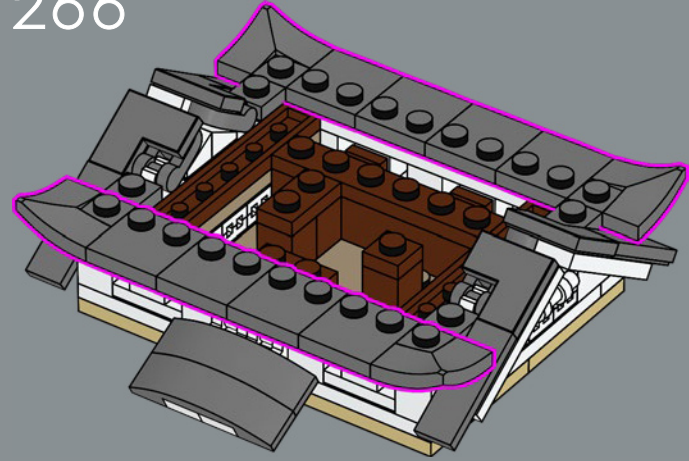

267

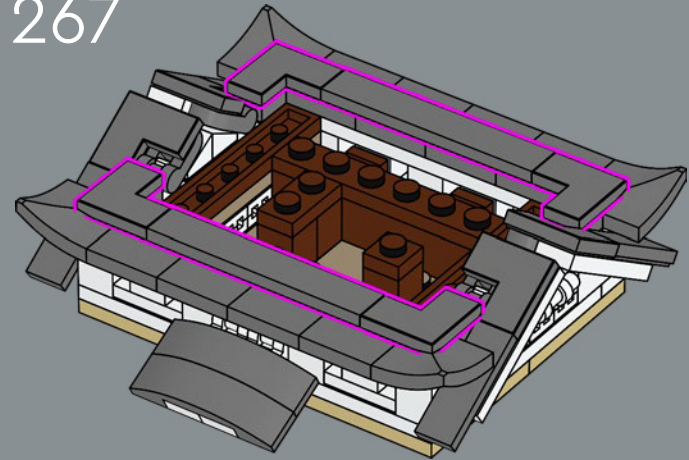

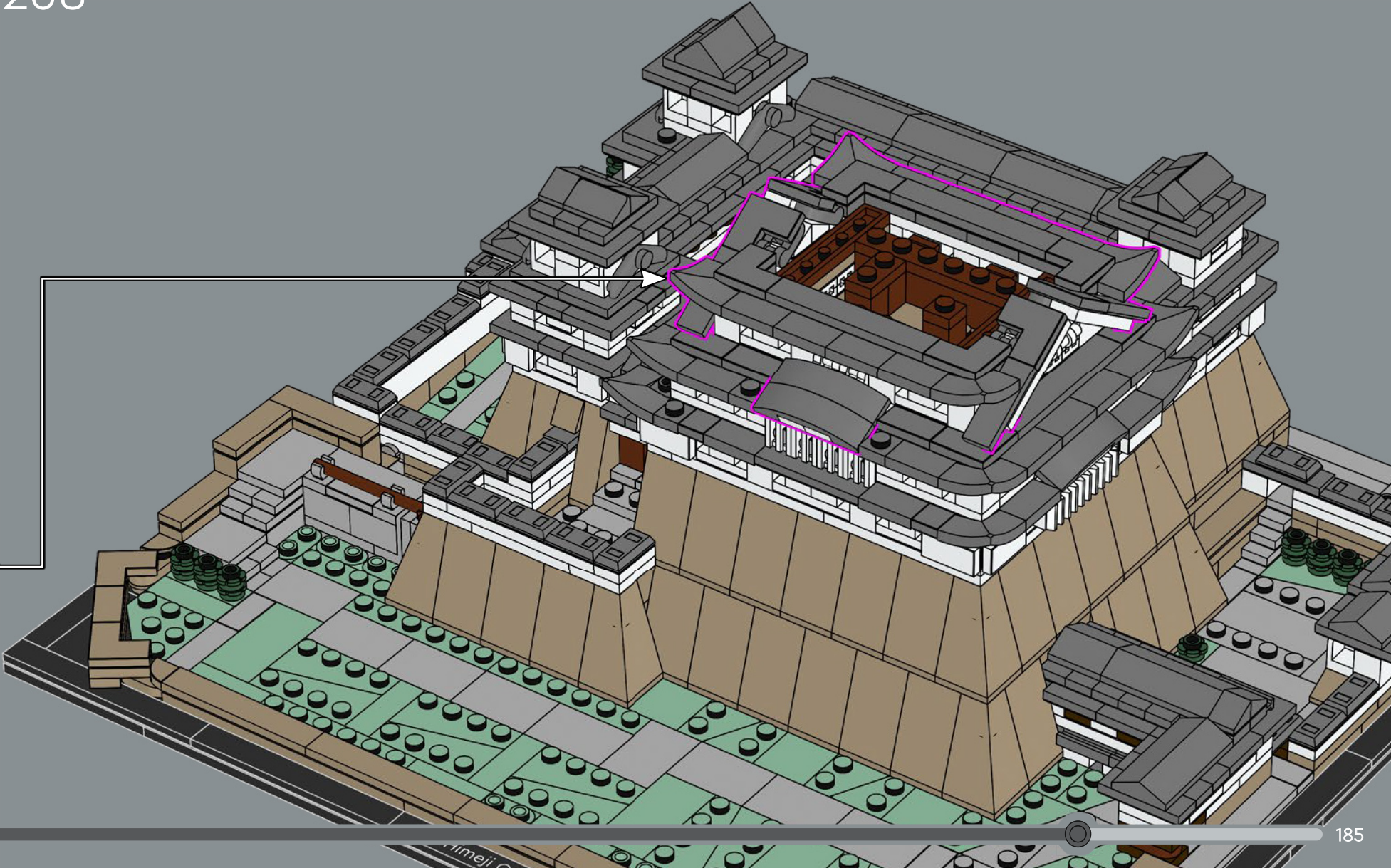

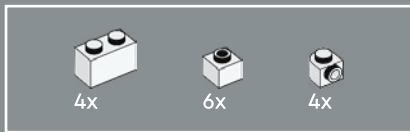

272

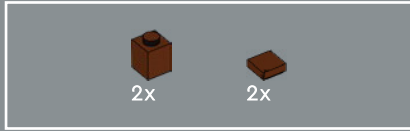
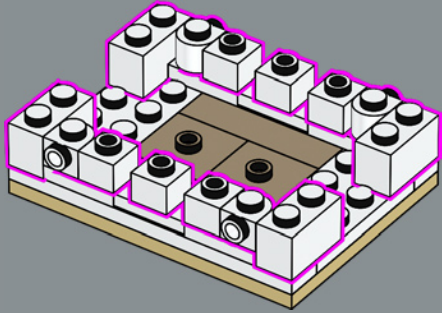

273

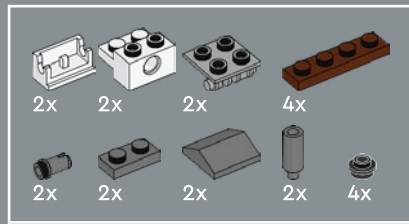
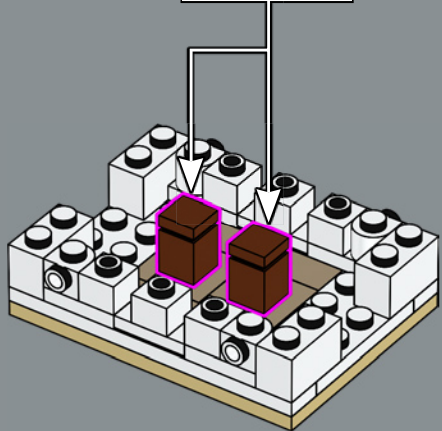
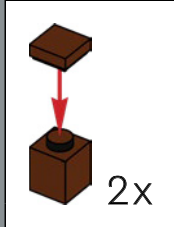

274

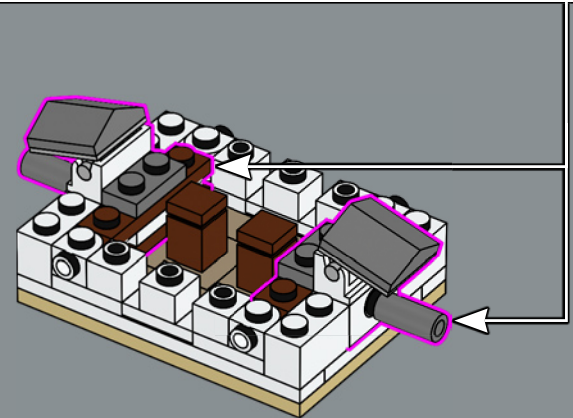
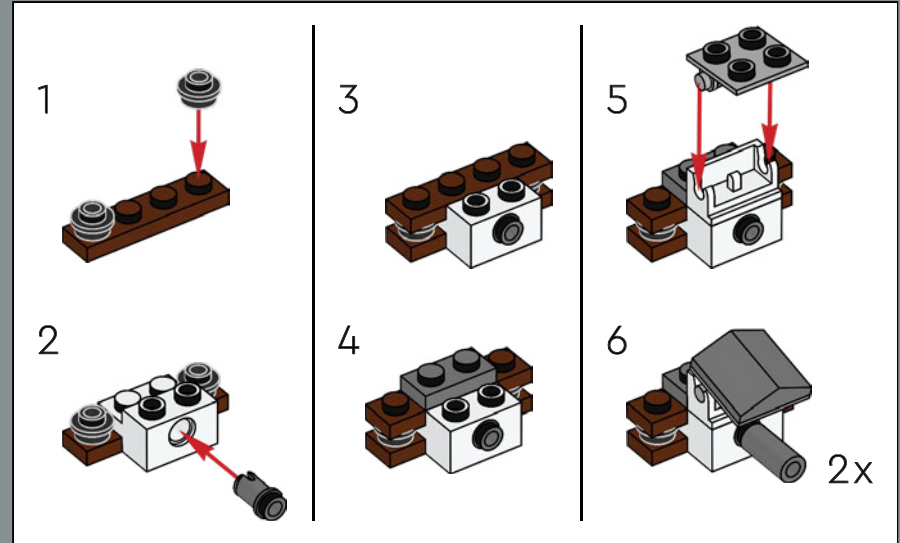

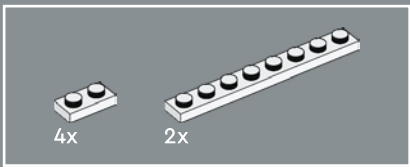

275

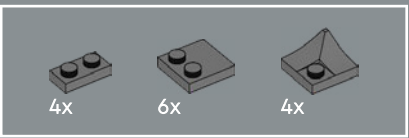
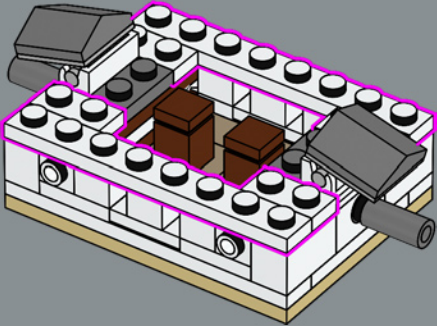

277

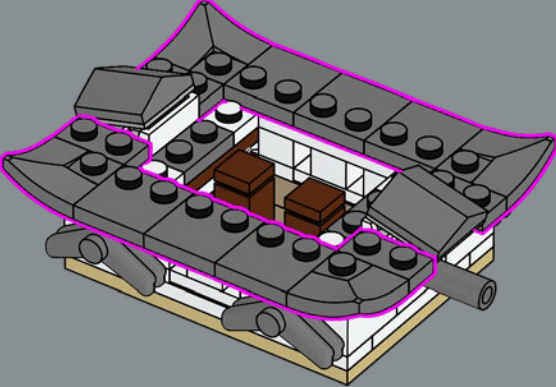

276

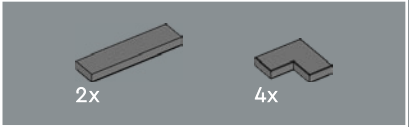
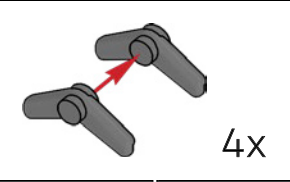
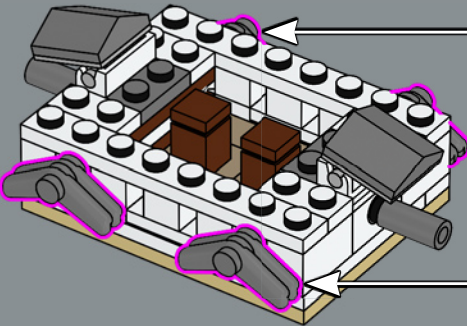

278

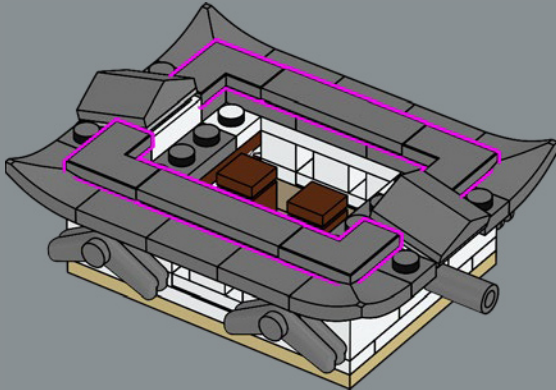

279

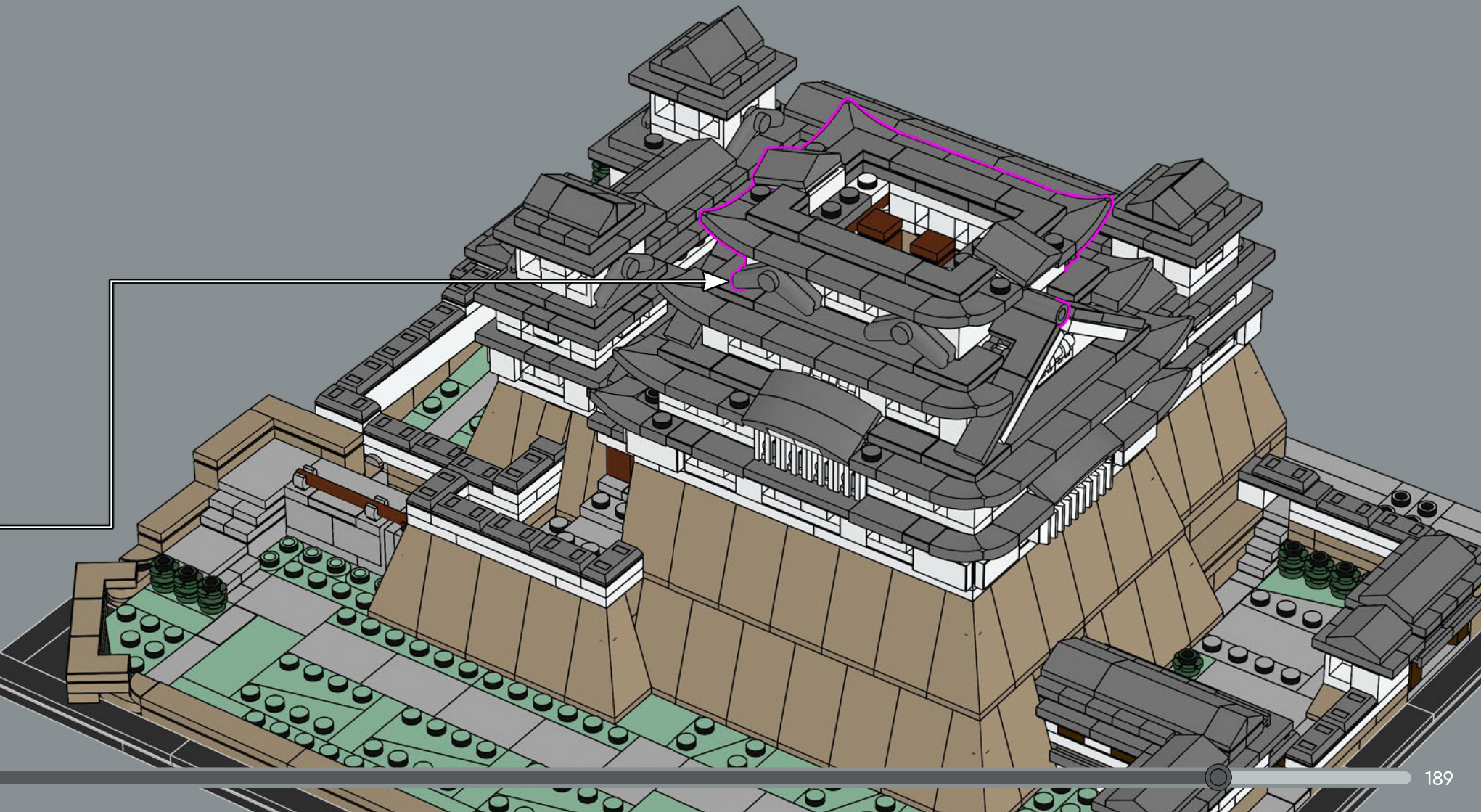

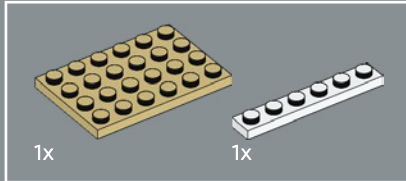
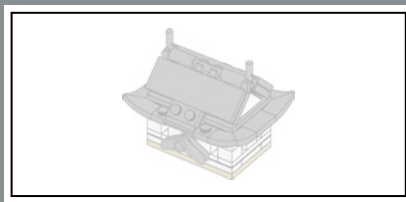

280

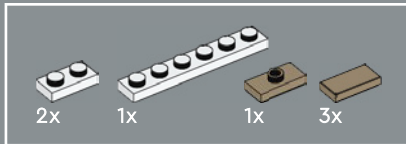
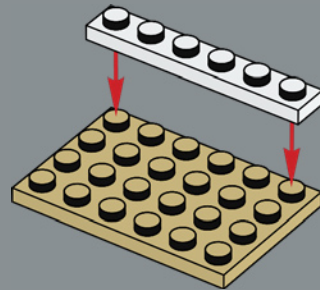

281

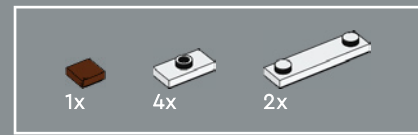
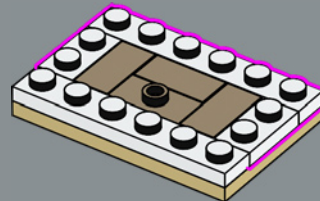

282

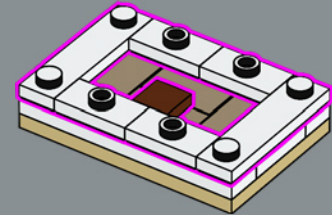

283

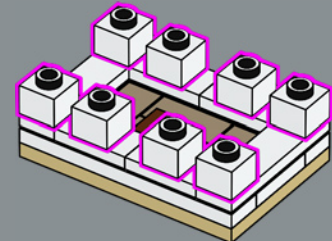

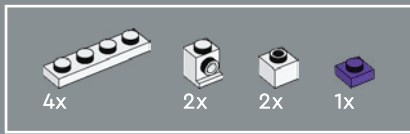

The purple 1x1 tile in the top floor chamber of the Main Keep is a nod to the small sacred wooden shrine covered in a purple drape inside this castle chamber.

284

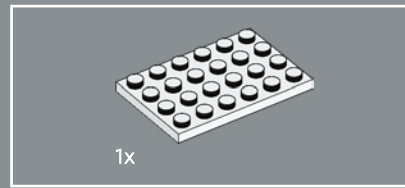
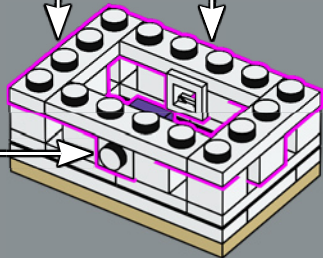
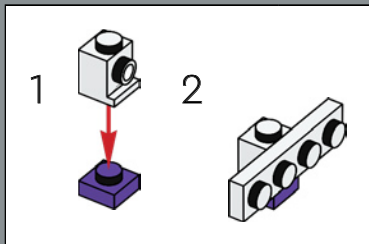
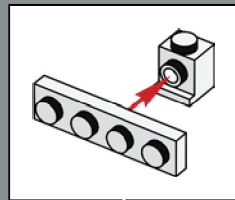
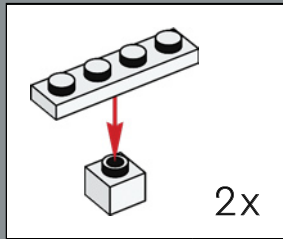

285

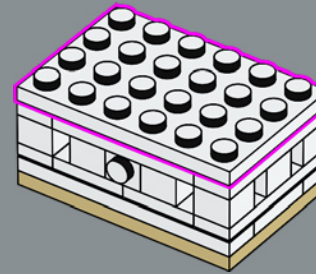

286

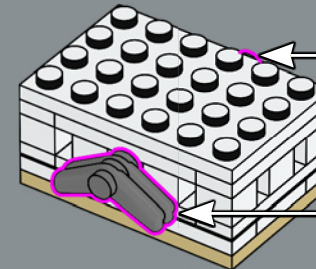
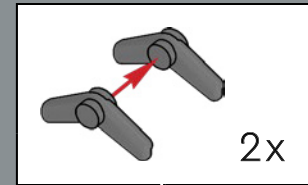

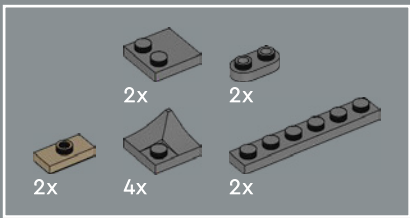

287

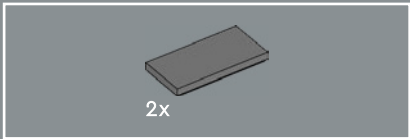
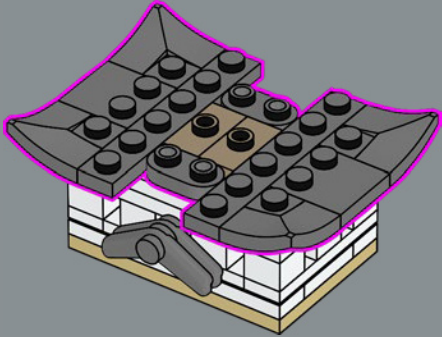

288

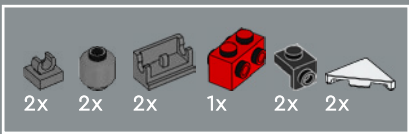
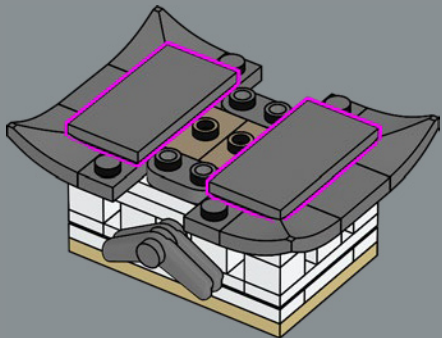

289

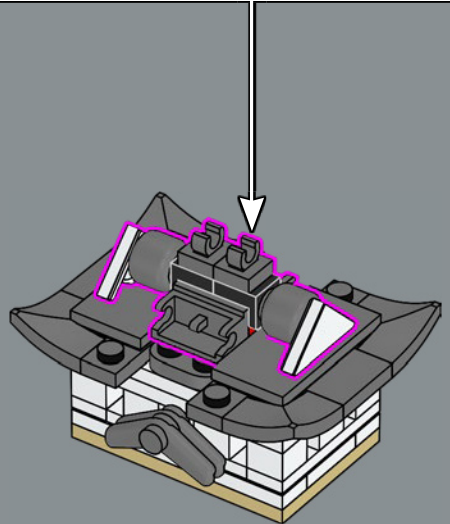
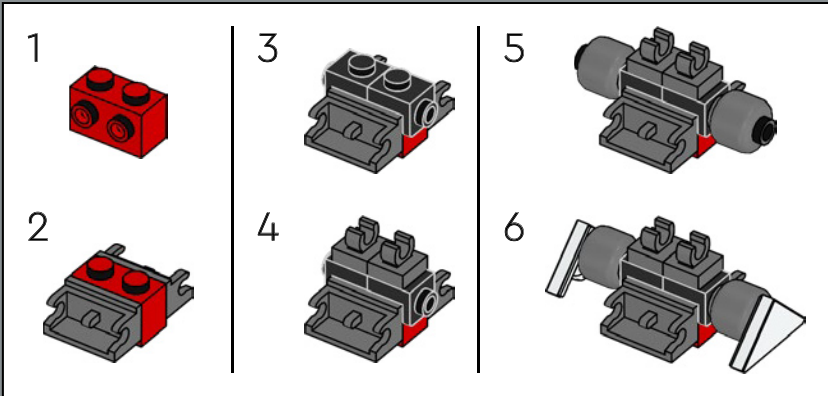

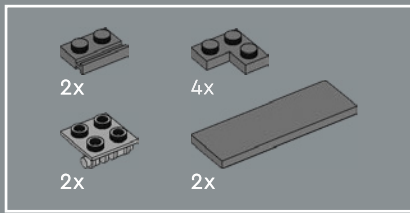

290

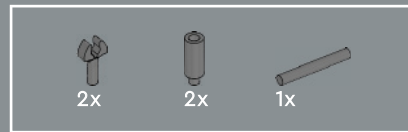
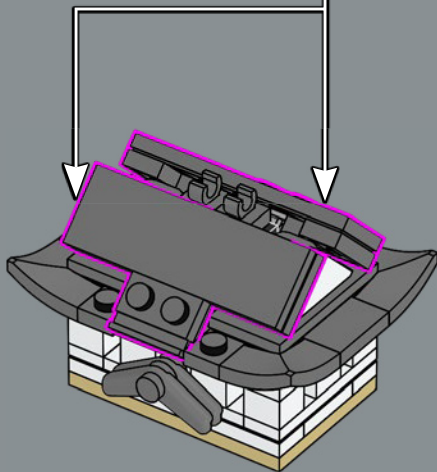
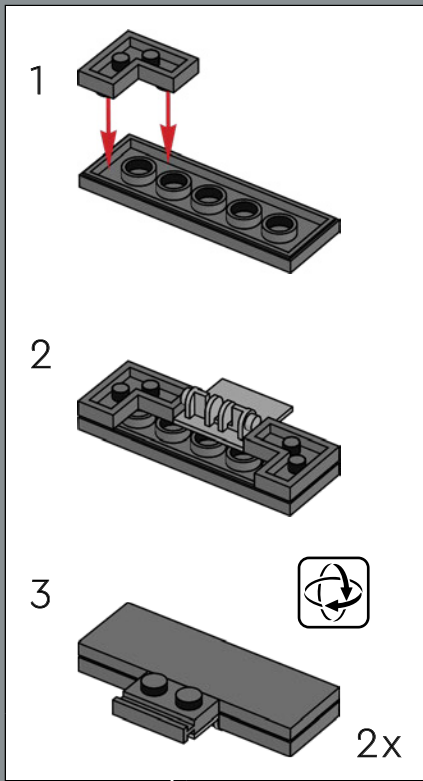

291

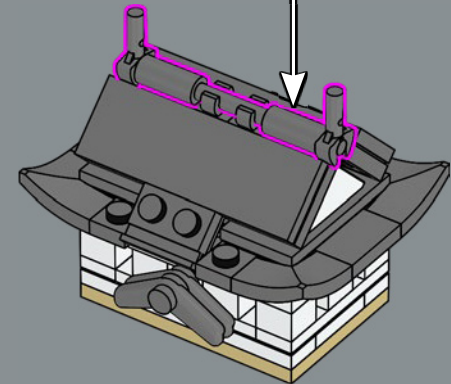
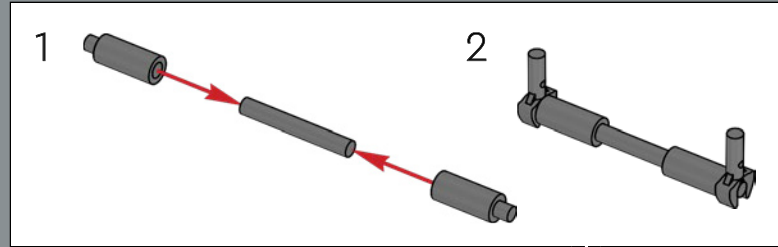

The Main Keep roof tiles were replaced during the 2009–2015 renovation. The new, thinner tiles weigh 0.75 kg (1.6 lbs.) less per tile, making the entire roof 45+ tonnes (50+ tons) lighter than before!

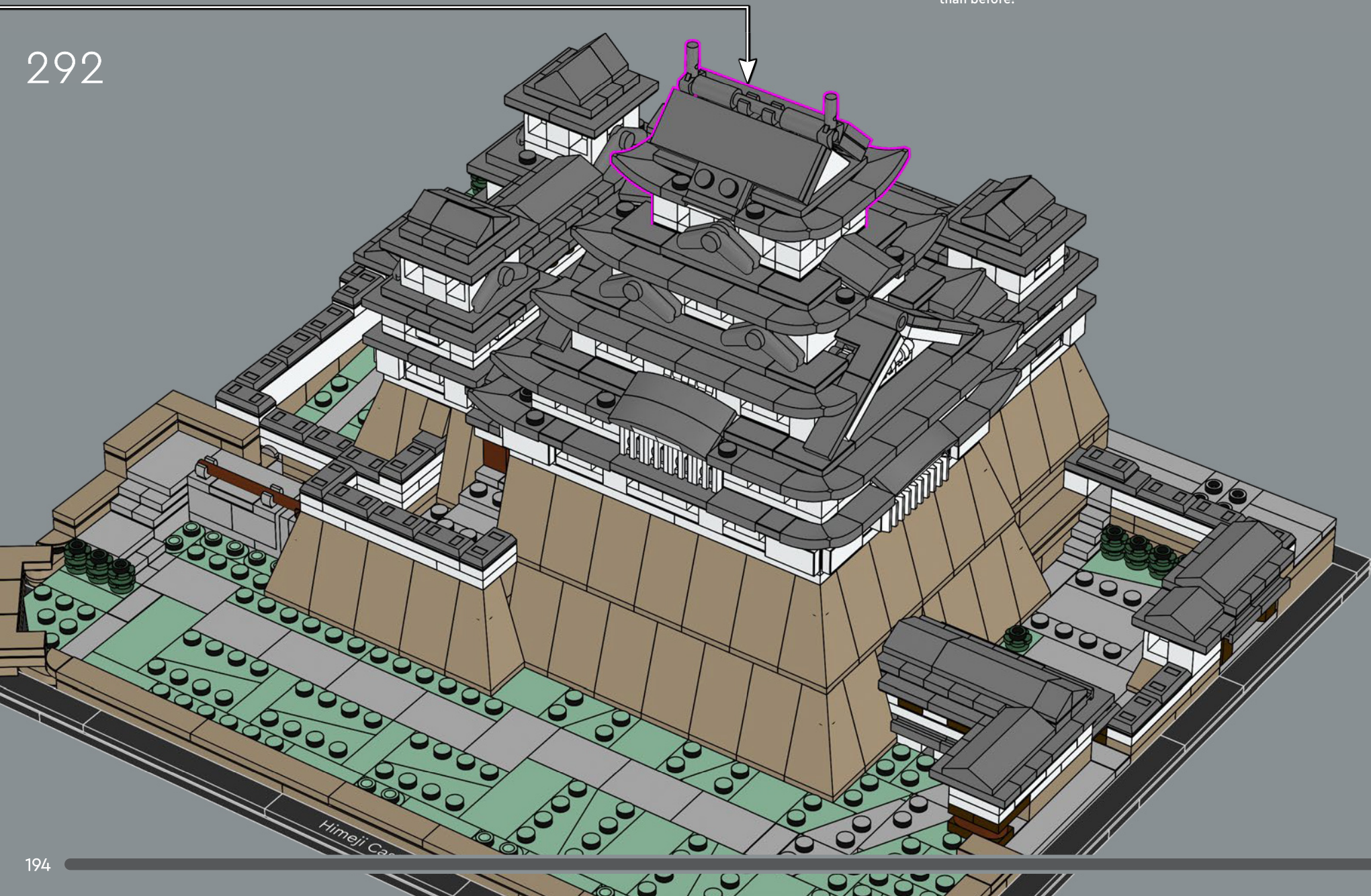

3x

3x

293

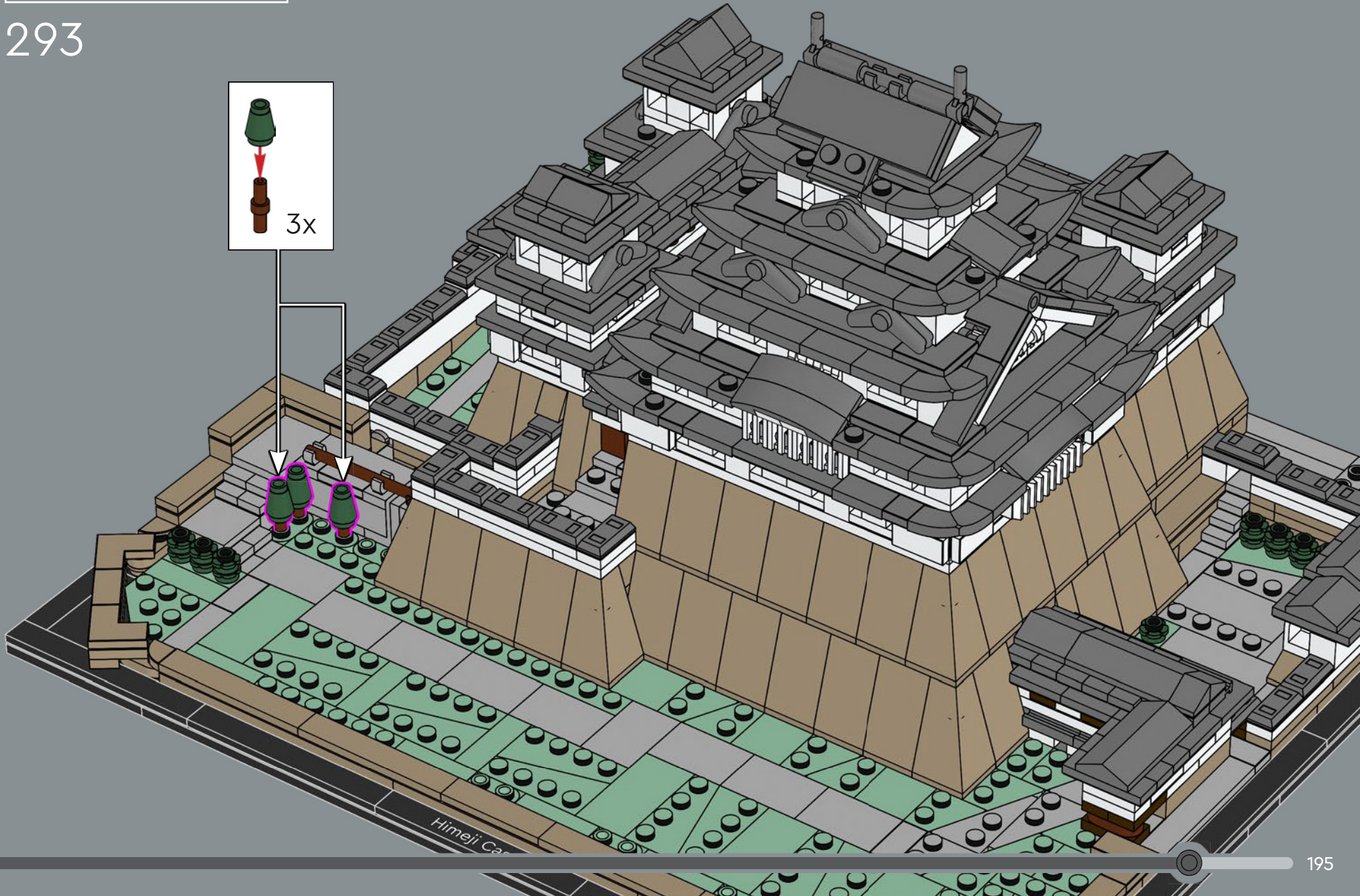
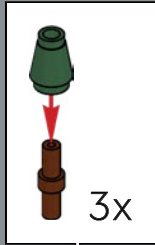



294

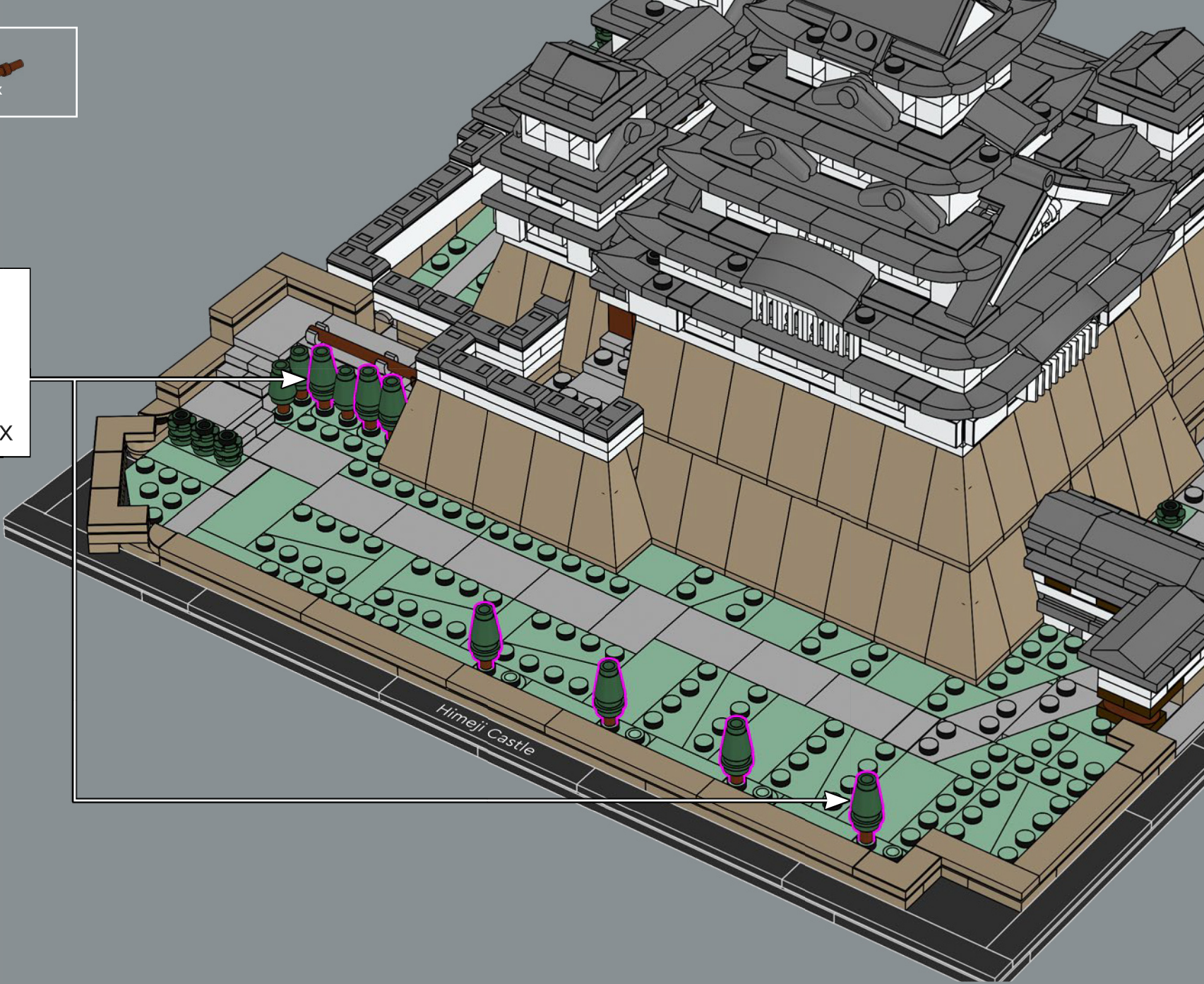
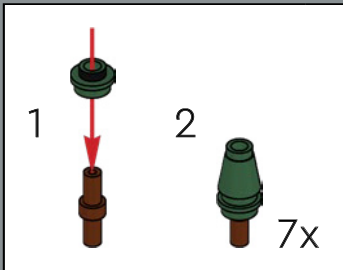

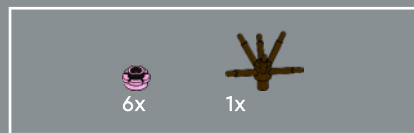

295

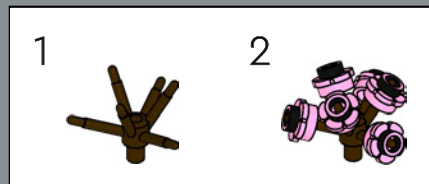

3x

296

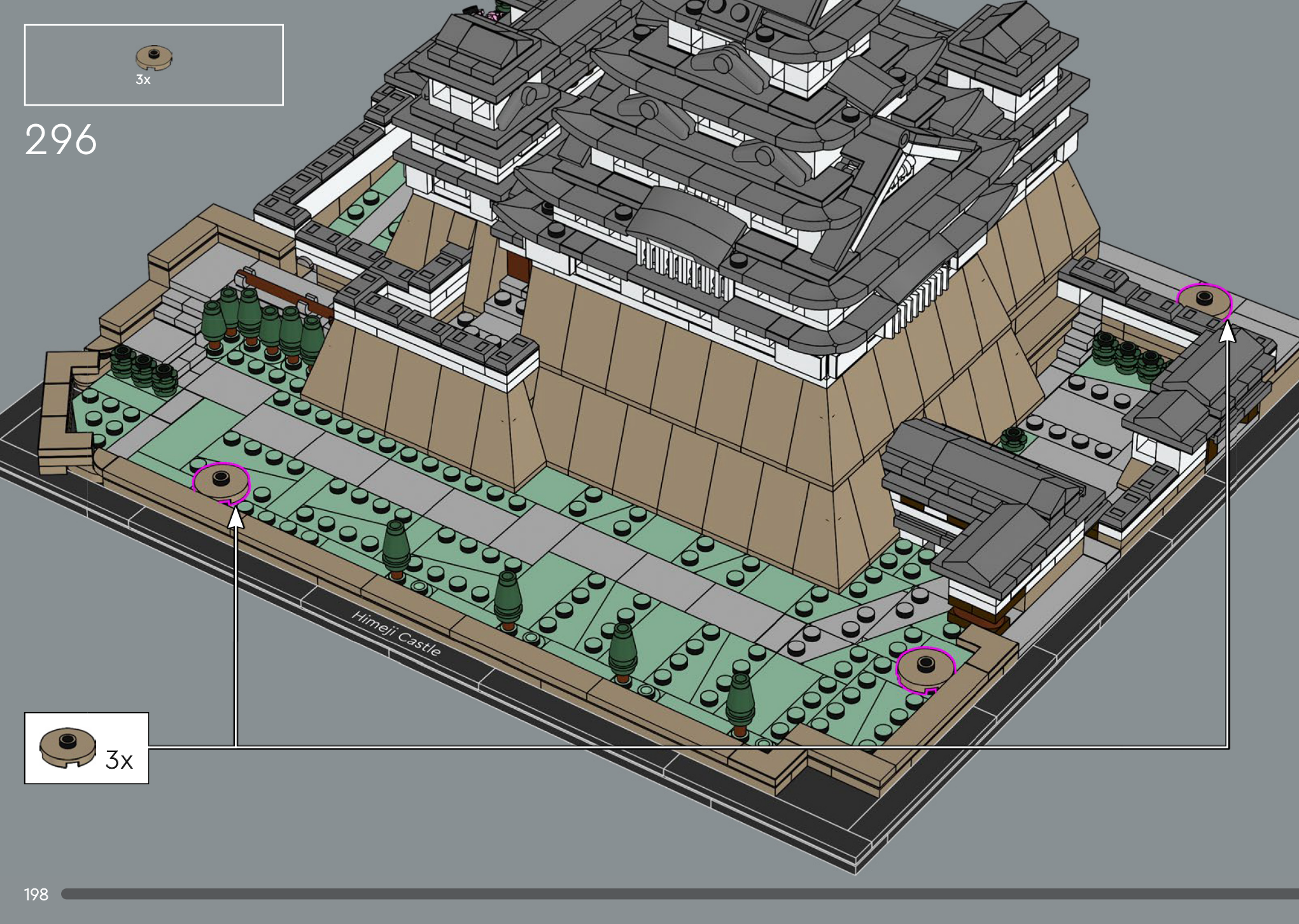

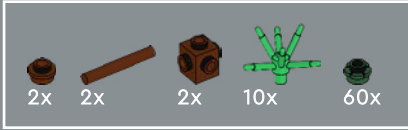
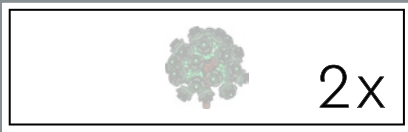

297

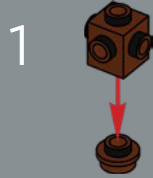
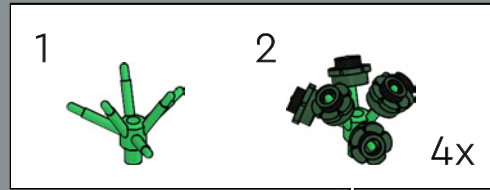
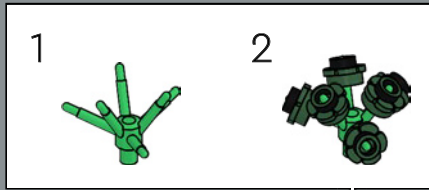



298

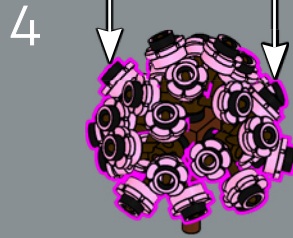
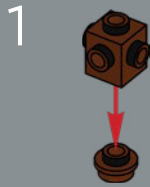
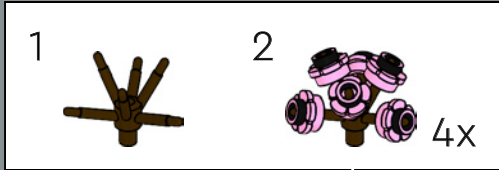
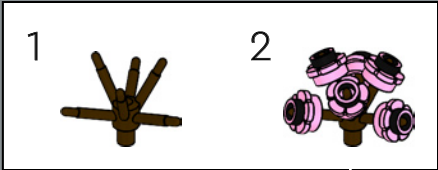



Himeji Castle

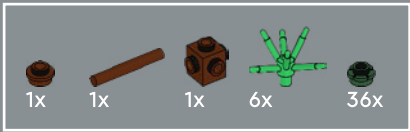

299

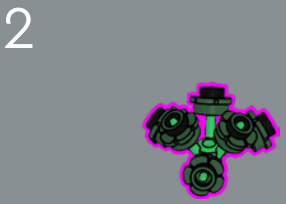
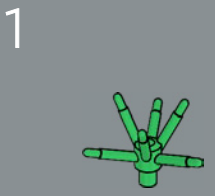
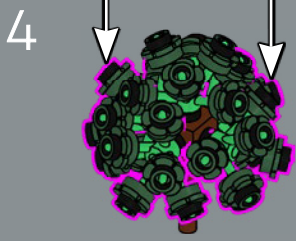
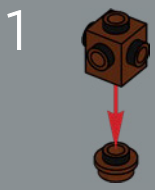
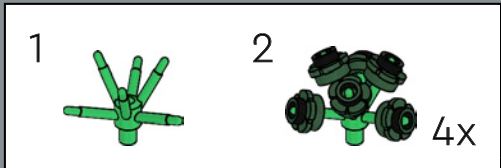
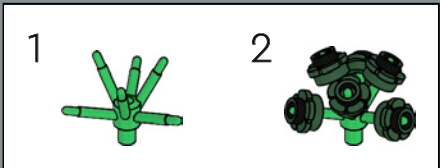

Himeji Castle is also known as The Castle of the White Heron, as it resembles the majestic bird about to take flight.

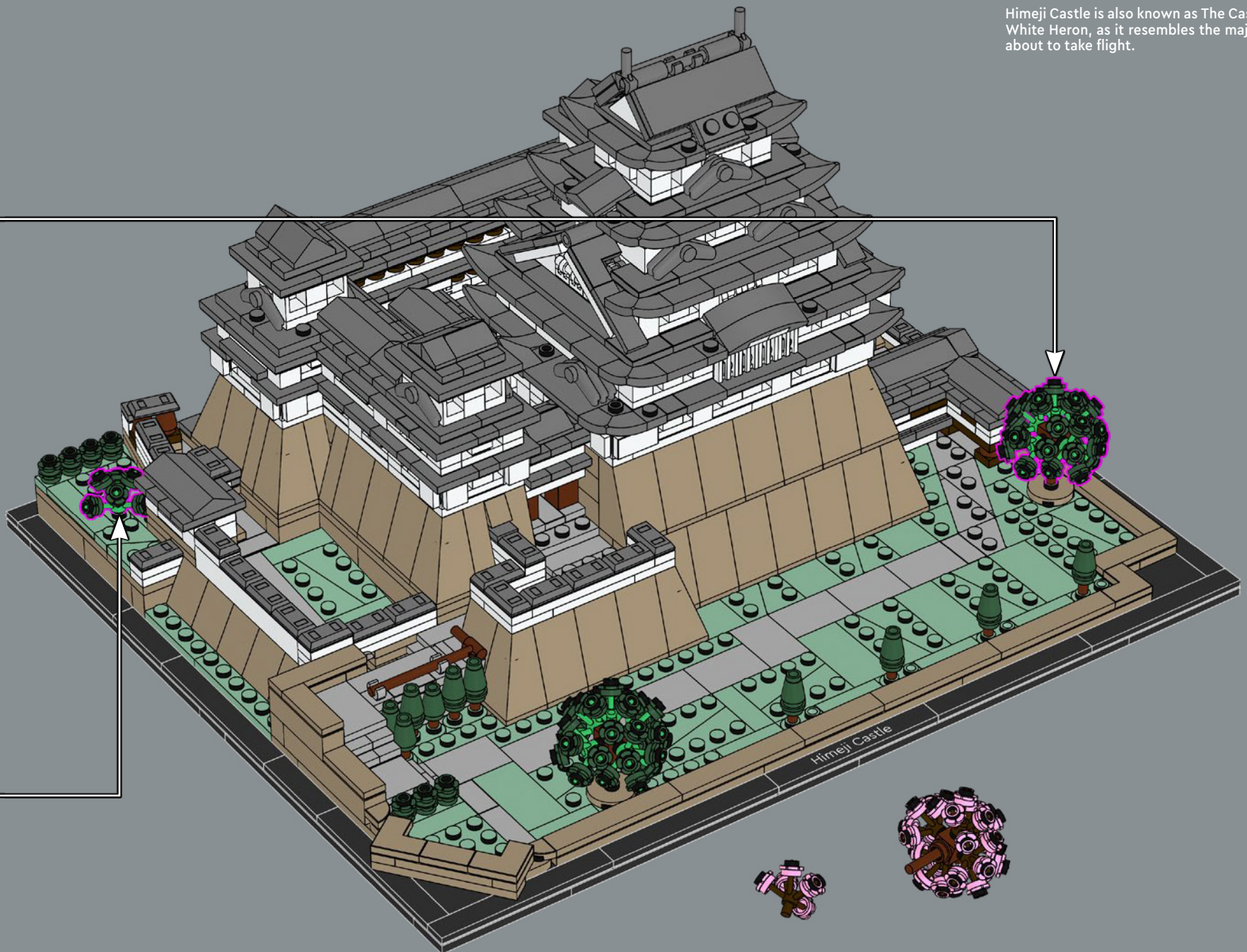

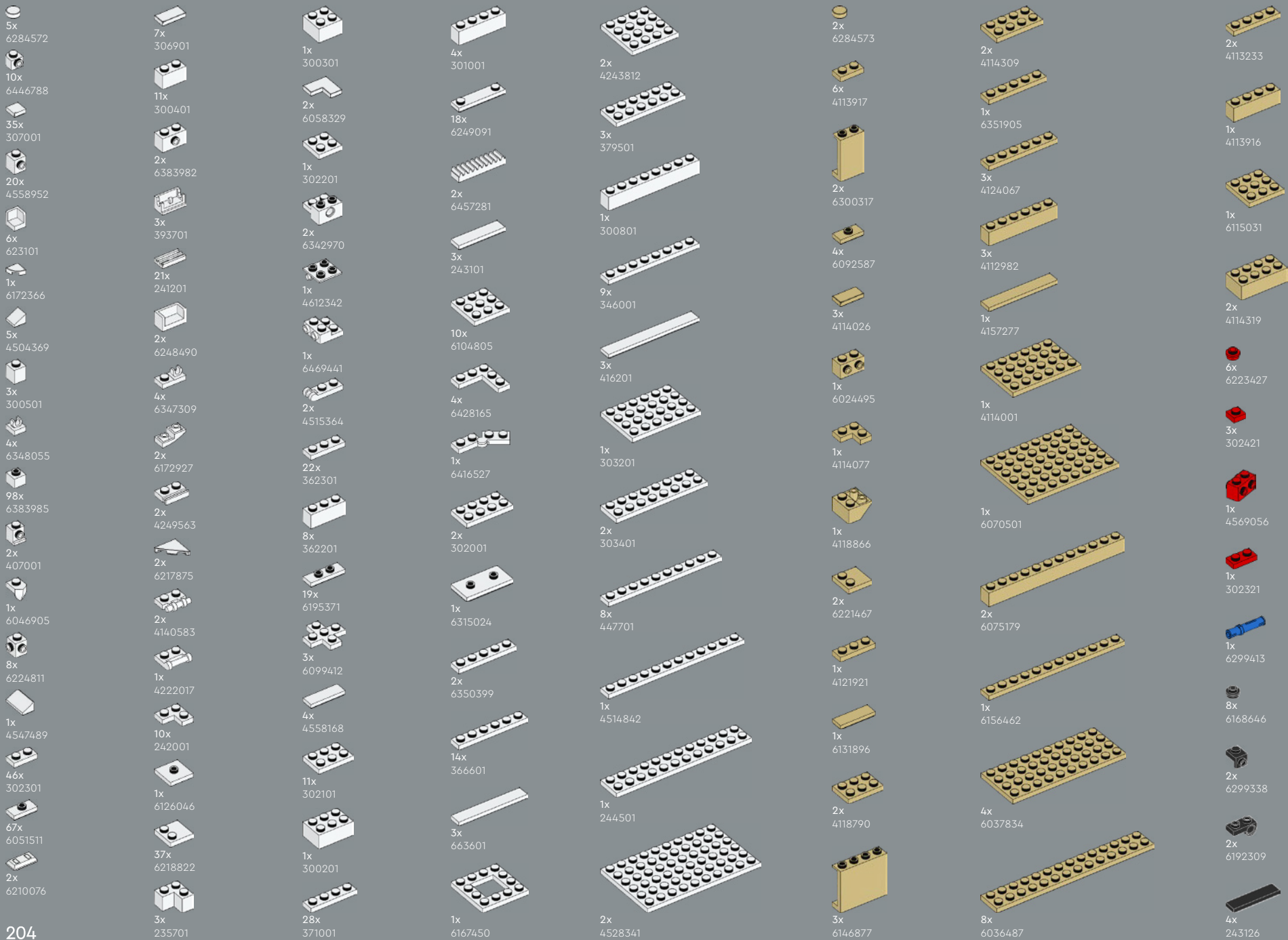



- 1x 6126082
- 1x 4211397
- 2x 4211349
- 1x 4211413
- 4x 4211881
- 1x 6438836
- 12x 4558169
- 12x 6211969
- 3x 4211429
- 16x 6171894
- 2x 4211356
- 5x 6257593
- 2x 4211445
- 5x 4560183
- 2x 4211395
- 1x 4211385
- 2x 4211549
- 4x 4211795
- 5x 4211481

- 1x 4211407
- 4x 4211408
- 6x 4211405
- 6x 4662161
- 4x 6058221
- 6x 6452882
- 1x 6252667
- 2x 6226792
- 1x 6223039
- 36x 6212501
- 4x 6388120
- 4x 4529240
- 2x 6439040
- 1x 4211407
- 4x 4211408
- 6x 4211405
- 4x 6058221
- 6x 6452882
- 1x 6252667
- 2x 6226792
- 1x 6223039
- 36x 6212501
- 4x 6388120
- 4x 4529240
- 2x 6439040

- 2x 6192569
- 2x 6395635
- 4x 4210848
- 9x 4210719
- 2x 6344022
- 6x 4504378
- 2x 6199549
- 2x 6221607
- 4x 6388119
- 1x 4226221
- 6x 4567887
- 29x 6331866
- 20x 6092572
- 12x 4211063
- 6x 4211052
- 2x 4211066
- 2x 4211135

- 3x 6000606
- 9x 4543086
- 20x 6446785
- 1x 6310596
- 12x 6126083
- 6x 6446786
- 1x 4211094
- 43x 6309059
- 2x 4210702
- 18x 6247784
- 1x 6232193
- 21x 6447212
- 4x 4210635
- 1x 4211055
- 60x 6343852
- 8x 4568734

- 1x 4211043
- 3x 6187008
- 4x 4211053
- 3x 4648256
- 2x 6039176
- 41x 6307616
- 6x 4560184
- 3x 4211127
- 10x 6189120
- 4x 4210651
- 2x 4211056
- 2x 6321746
- 1x 6230281

- 2x 4210998
- 1x 4211008
- 1x 4210997
- 1x 4211061
- 2x 6133611
- 1x 6000970
- 1x 6231376
- 2x 6215447
- 3x 6093529
- 25x 6315780
- 3x 6259071
- 4x 6194729
- 3x 4519970



 [LEGO.com/service](https://www.LEGO.com/service)



YOU COULD WIN



YOU COULD WIN

Your feedback will help shape the future development of this product series.

Visit:

DU KÖNNTEST GEWINNEN

Dein Feedback trägt zur Weiterentwicklung dieser Produktreihe bei.

Geh auf:

VOUS POURRIEZ GAGNER

Vos commentaires nous aideront à concevoir les futurs produits de cette gamme.

Visitez :

POTRESTI VINCERE TU

La tua opinione ci aiuterà a migliorare la creazione futura di questa linea di prodotti.

Visita:

PUEDES GANAR

Tu opinión contribuirá al futuro de esta serie de productos.

Visita:

轻松获奖

您的反馈将有助于我们在今后改进本产品系列。

请访问:

[LEGO.com/productfeedback](https://www.lego.com/productfeedback)

You also have the chance to win a LEGO® set.

Terms and conditions apply.*

Außerdem hast du die Chance, ein LEGO® Set zu gewinnen.

Es gelten die Teilnahmebedingungen.*

Vous pourriez également gagner un ensemble LEGO®.

Des conditions s'appliquent.*

Hai anche la possibilità di vincere un set LEGO®.

Termini e condizioni sono applicabili.*

También tienes la oportunidad de ganar un set LEGO®.

Aplican términos y condiciones.*

您还有机会赢取乐高®套装。

条款和条件适用。*

*[LEGO.com/productfeedback-terms](https://www.lego.com/productfeedback-terms)

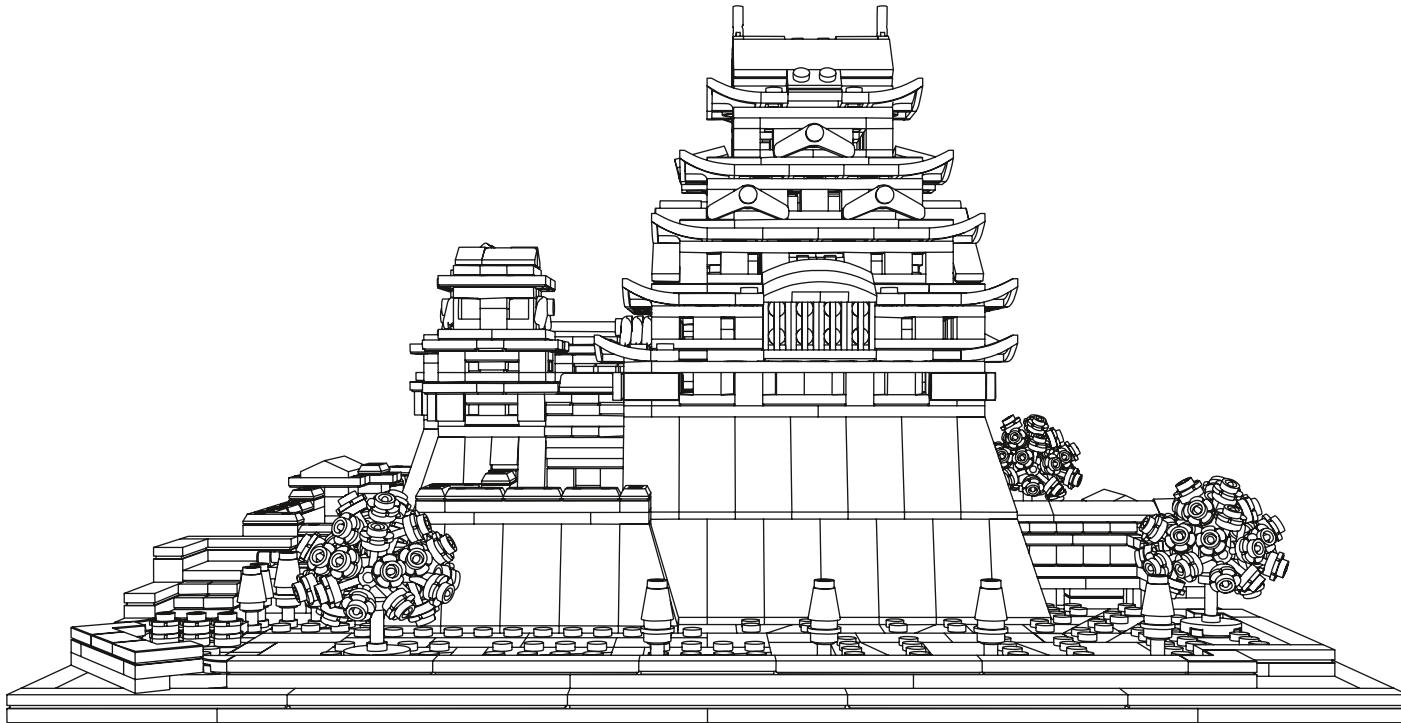

LEGO and the LEGO logo are trademarks of the LEGO Group. ©2023 The LEGO Group.

Adam Reed Tucker is the co-developer of the LEGO® Architecture product line.

6493762