





ARID PLANTS

LES PLANTES DES ZONES ARIDES

PLANTAS DE ZONAS ÁRIDAS

☞ Arid or desert plants are some of the toughest species you will find. They have evolved to survive in climate zones with harsh winds, intense heat and only very sporadic precipitation. They typically store what little moisture they can attract in plump pods and save it for... well, not a rainy day, but long dry spells instead. Radiant flowers help them attract pollinators, giving them an edge over any competition in their surroundings.

☞ Les plantes des zones arides ou désertiques comptent parmi les espèces les plus résistantes qui soient. Elles ont évolué pour survivre dans des zones climatiques caractérisées par des vents violents, une chaleur intense et des précipitations très sporadiques. Elles stockent généralement le peu d'humidité qu'elles peuvent absorber dans des gousses dodues et la conservent pour de longues périodes de sécheresse. Des fleurs éclatantes leur permettent d'attirer les pollinisateurs, ce qui leur donne une longueur d'avance sur la concurrence dans leur environnement.

☞ Las plantas de zonas áridas o desérticas son algunas de las especies más resistentes que encontrarás. Han evolucionado para sobrevivir en zonas climáticas con vientos inclementes, calor intenso y precipitaciones muy esporádicas. Normalmente almacenan en gruesas vainas la poca humedad que pueden captar y la guardan para... Bueno, no para los días de lluvia, sino para largos períodos de sequía. Sus radiantes flores les ayudan a atraer a los polinizadores con ventaja sobre cualquier competencia presente su entorno.



(Dudleya brittonii)

BRITTON'S LIVEFOREVER

A succulent native only to Baja California, Mexico.

LE DUDLEYA DE CRAIE

Une succulente originaire de Basse-Californie, au Mexique.

SIEMPREVIVA DE TIZA

Una suculenta nativa solo de Baja California (México).



(Opuntia humifusa)

EASTERN PRICKLY PEAR

A cactus native to large parts of the eastern United States and northeastern Mexico.

LE FIGUIER DE BARBARIE ORIENTAL

Un cactus indigène à une grande partie de l'est des États-Unis et du nord-est du Mexique.

NOPAL DEL ESTE

Cactus originario de gran parte del este de Estados Unidos y el noreste de México.



*(Mammillaria crinita
f. zeilmanniana)*

PINCUSHION CACTUS

Native to Mexico, and areas in the southwestern United States, the Caribbean and South America.

LE CACTUS PELOTE

Un cactus indigène au Mexique et dans les régions du sud-ouest des États-Unis, des Caraïbes et de l'Amérique du Sud.

BIZNAGA DE ESPINAS ÁUREAS

Originaria de México y zonas del suroeste de Estados Unidos, el Caribe y Sudamérica.



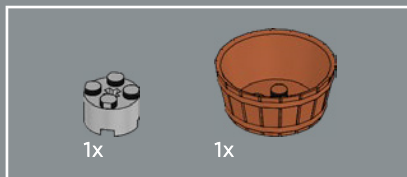

1

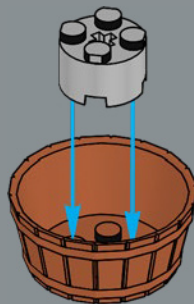



2

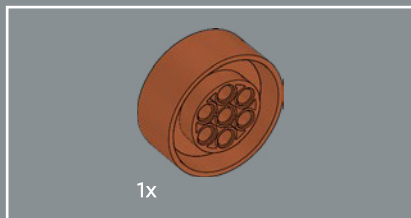
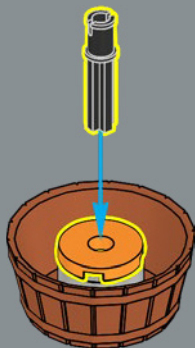

3

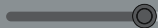
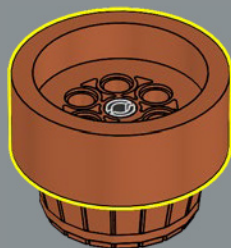



4

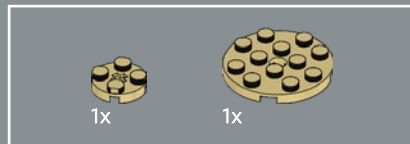
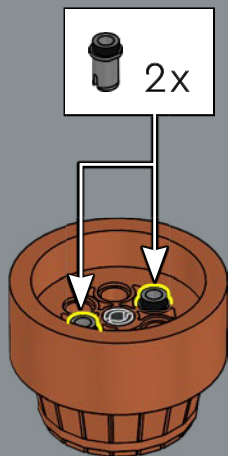

5

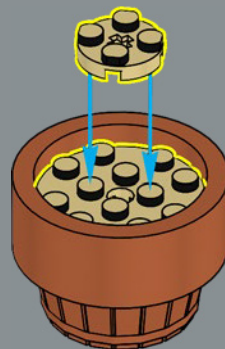



4x

6

This colorful succulent was named after Nathaniel Lord Britton, an American botanist who first categorized the *Dudleya* genus.

Cette succulente colorée a été nommée d'après Nathaniel Lord Britton, un botaniste américain qui a été le premier à catégoriser le genre *Dudleya*.

Esta colorida suculenta debe una parte de su nombre científico (*Dudleya brittonii*) a Nathaniel Lord Britton, botánico estadounidense que clasificó por primera vez el género *Dudleya*.

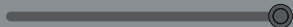
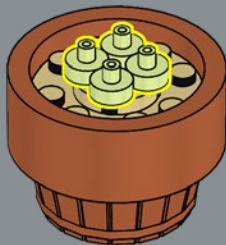

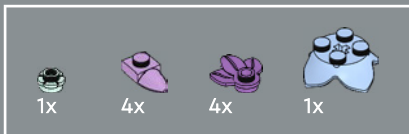

7

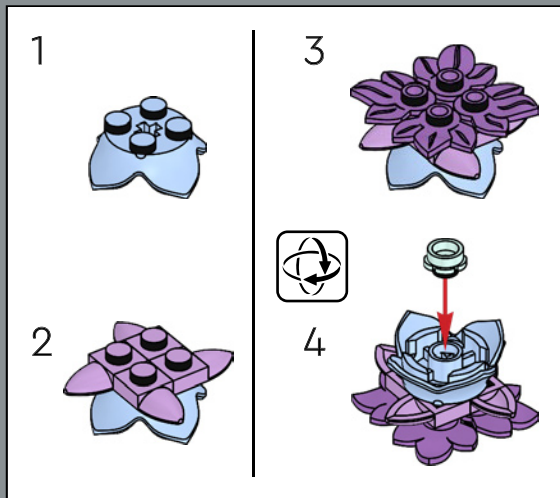

To capture a nice gradient of spiky leaves, we added a new color for the 1x1 plate with a tooth. So, if you have any LEGO® animals in your house, you could always give them lovely light lavender teeth.

Pour obtenir un joli dégradé de feuilles épineuses, nous avons ajouté une nouvelle couleur à la plaque 1x1 avec une dent. Ainsi, si vous avez des animaux LEGO® dans votre maison, vous pouvez toujours leur donner de jolies dents couleur lavande pâle.

Para reproducir un bonito gradiente de hojas puntiagudas, añadimos un nuevo color a la placa 1x1 con un diente. Así que, si tienes algún animal LEGO® en casa, tendrás la opción de ponerle unos preciosos dientes de color lavanda claro.

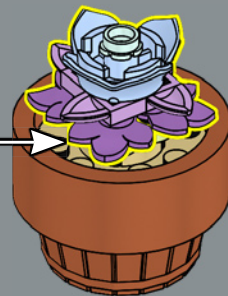

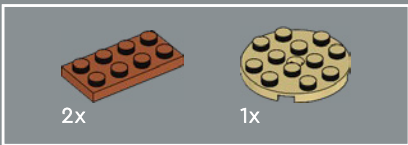
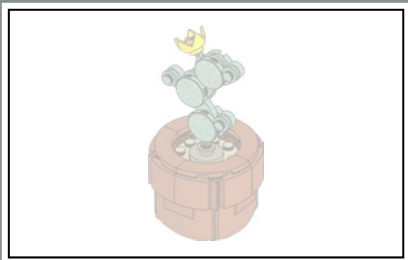

1

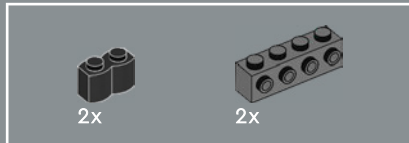
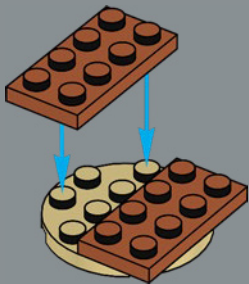

2

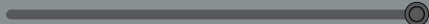
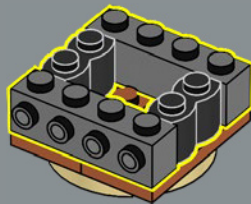

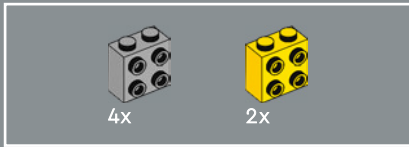

3

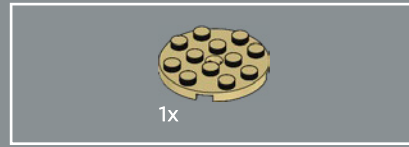
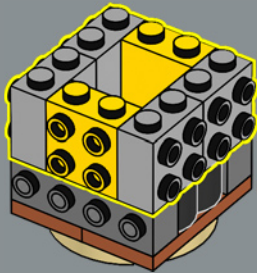

4

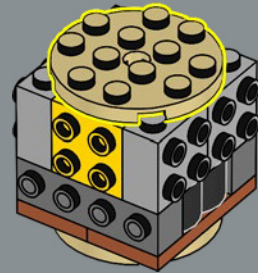

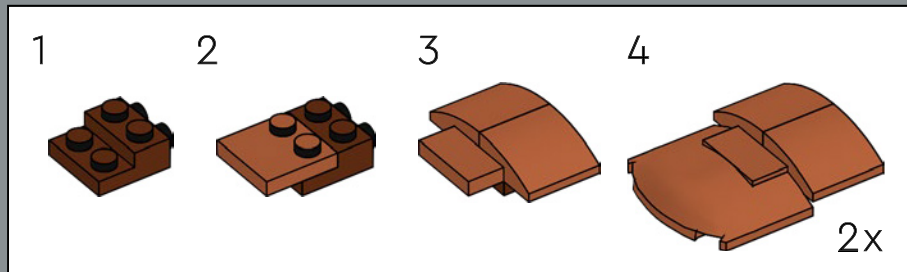
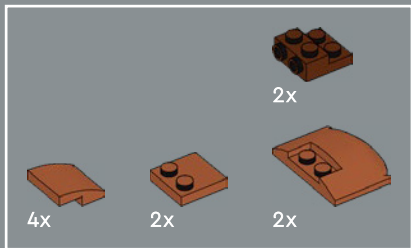

5

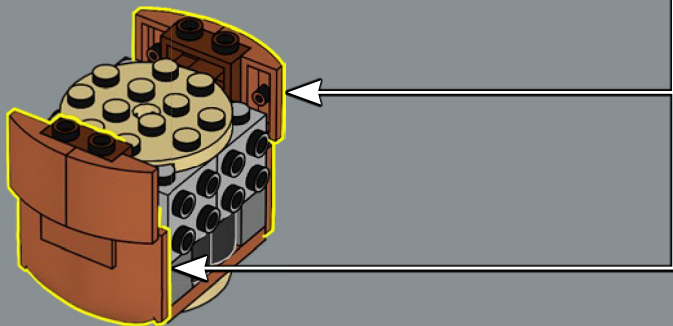

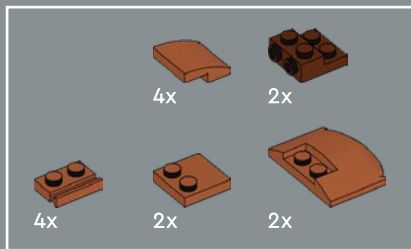

6

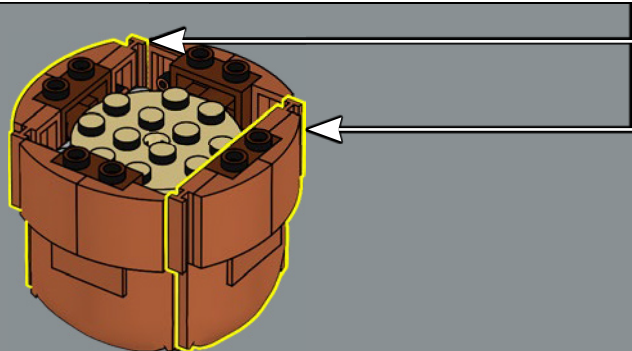
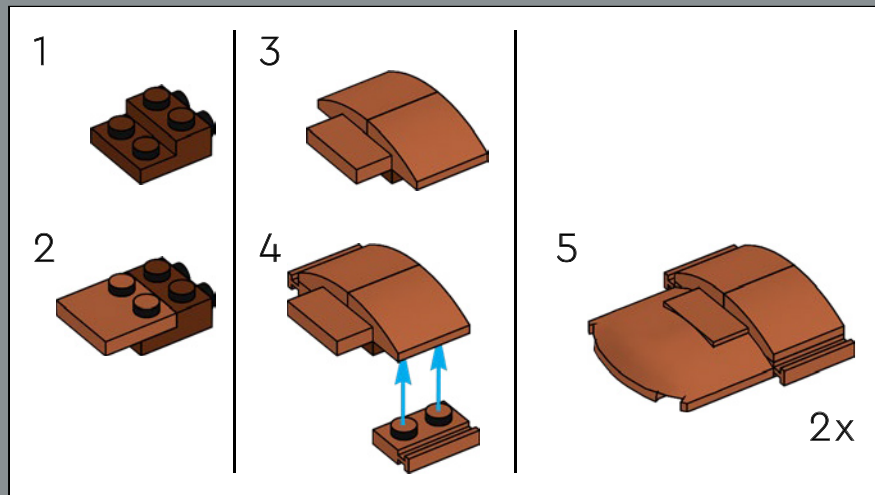

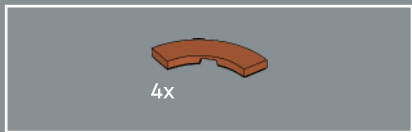

7

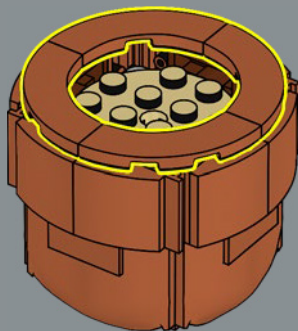

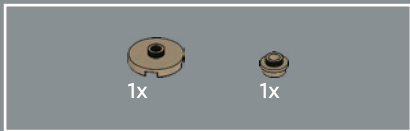

8

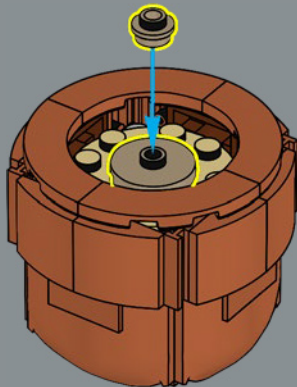

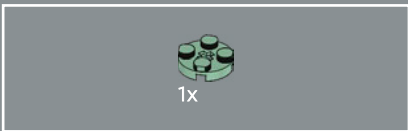
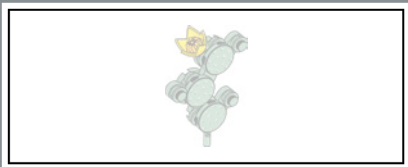

9



10

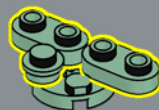

11

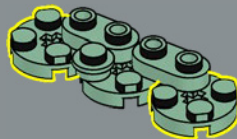

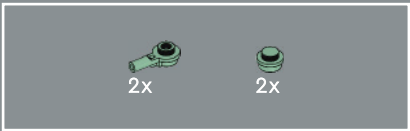

12

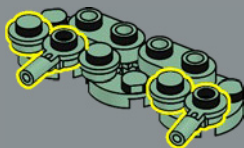

13

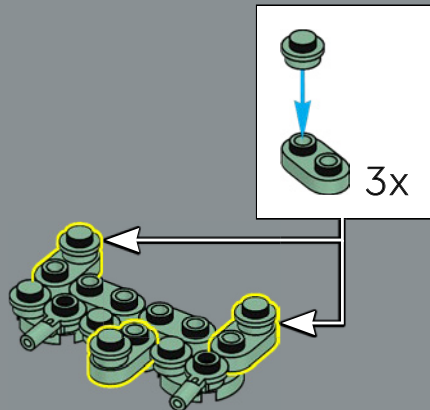



14

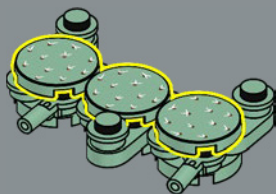

The round printed 2×2 LEGO® tiles are in a new sandy green color and feature a fun new spiky deco to capture the look of an Eastern prickly pear.

Les tuiles LEGO® rondes imprimées 2×2 sont d'une nouvelle couleur vert sable et présentent un nouveau motif épineux pour reproduire l'aspect du figuier de Barbarie oriental.

Las cubiertas LEGO® redondas 2×2 con estampado vienen en un nuevo color verde arena y presentan una nueva y divertida decoración con picos para capturar el aspecto de un nopal del este.

15

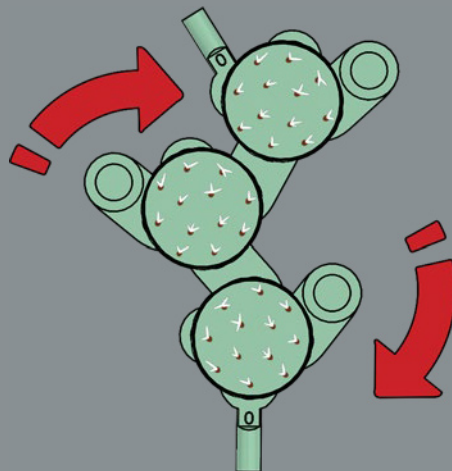

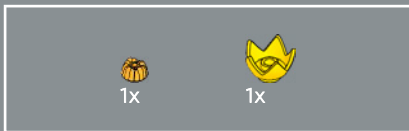

16

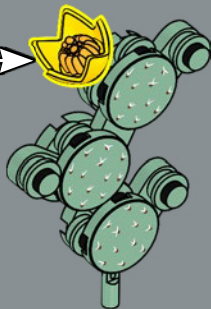
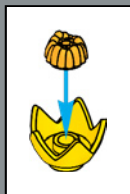

17

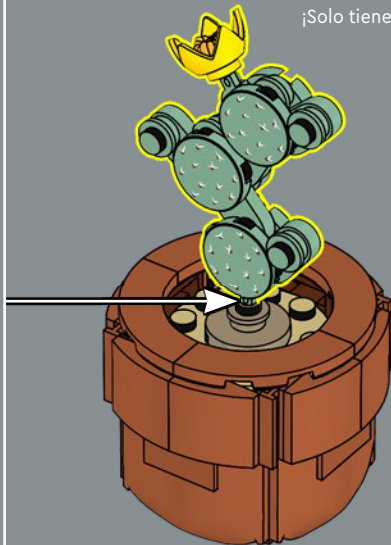

Did you know that prickly pear fruit is edible?
And so are the big green 'pads.' Just be sure
to remove the spines before eating!

Saviez-vous que les fruits du figuier de Barbarie
sont comestibles ? Il en va de même pour les gros
« coussinets » verts. Veuillez simplement à retirer les
épines avant de les manger !

¿Sabías que el fruto del nopal es comestible?
Y también lo son sus grandes "hojas" verdes.
¡Solo tienes que quitarles las espinas antes de comerlas!

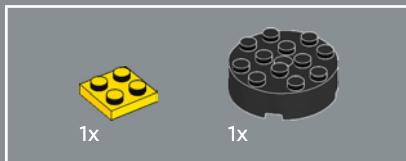
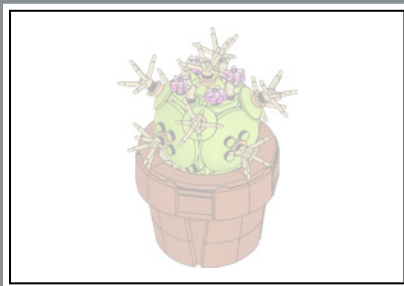

1

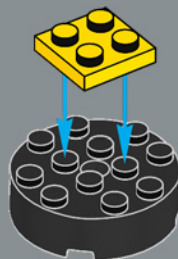



2

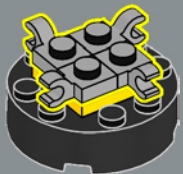

3

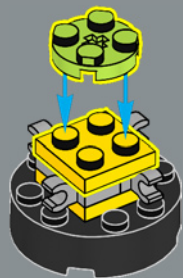



4



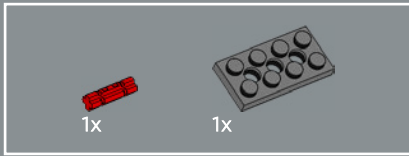

5

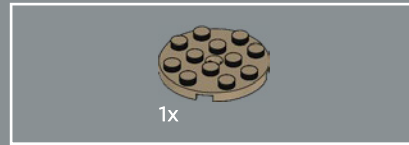
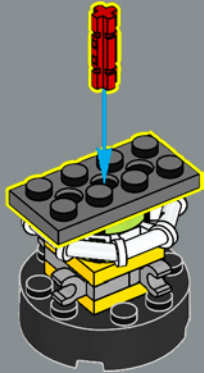

6

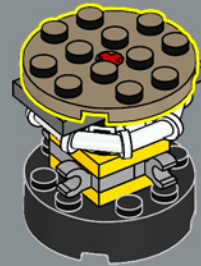



7

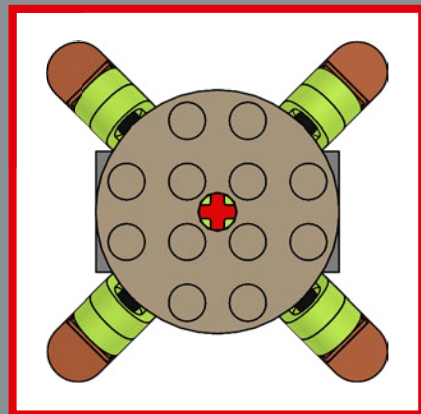
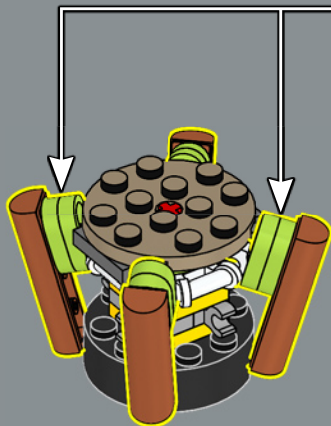
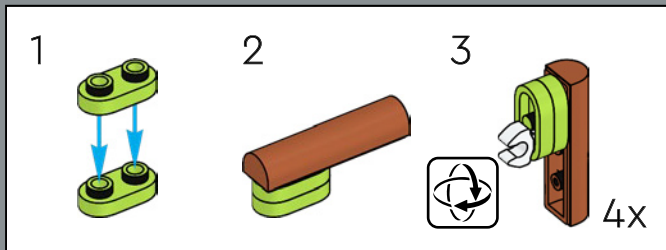

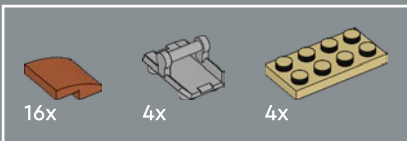

8

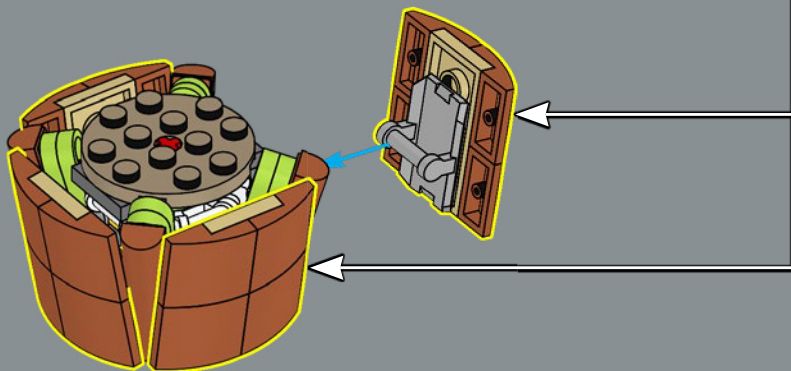
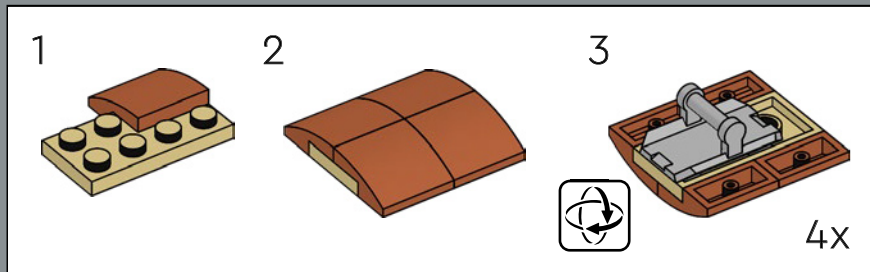

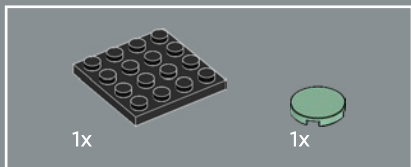
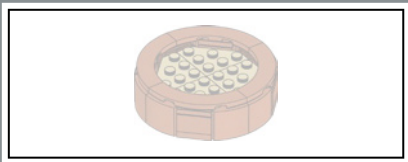

9

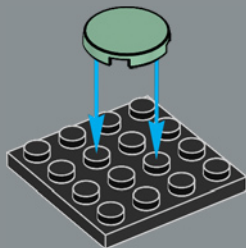

10

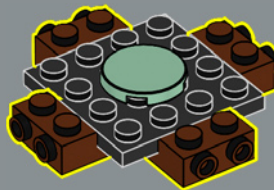



11

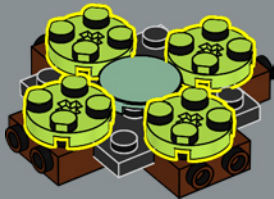

12

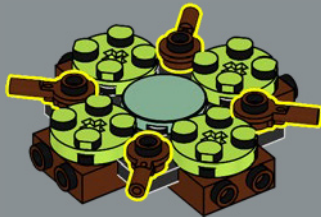

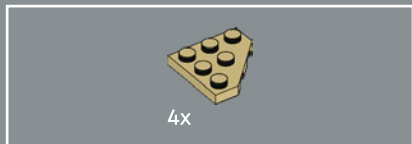

13

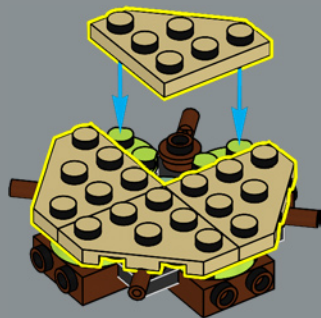

14

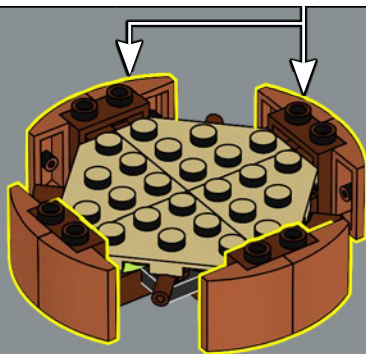
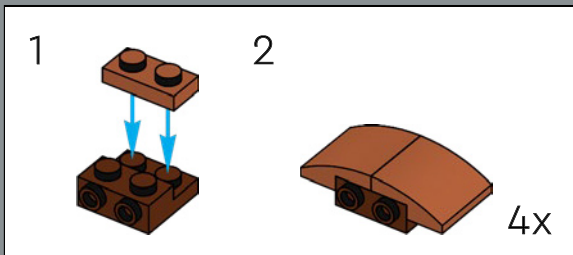

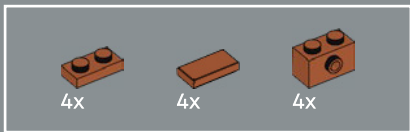

15

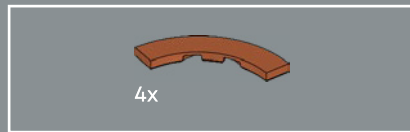
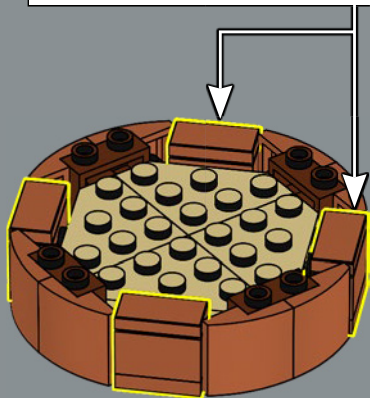
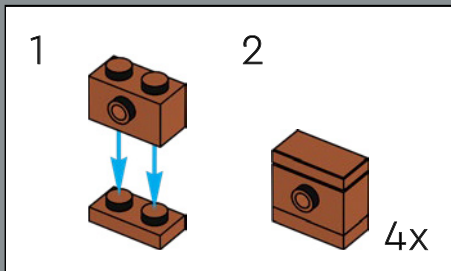

16

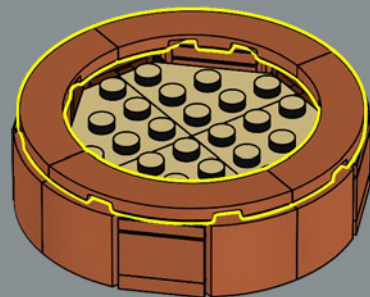

17

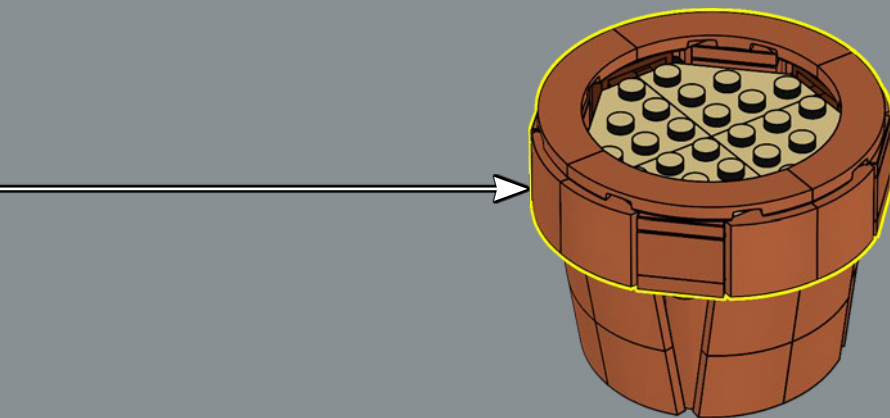

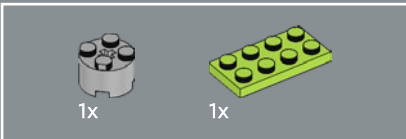
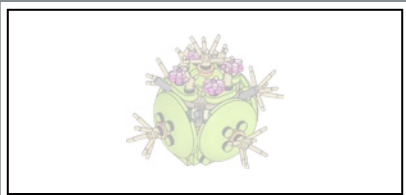

18

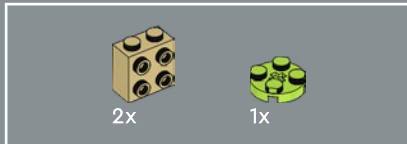
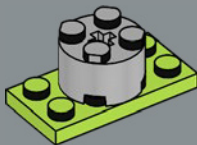

19

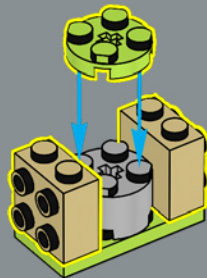



20

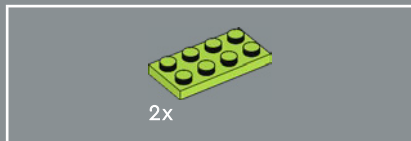
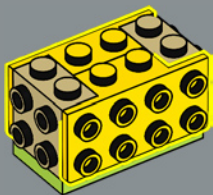

21

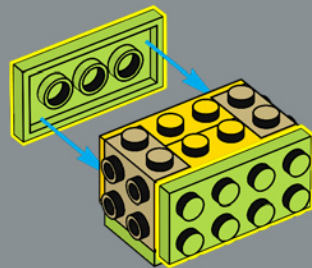



22

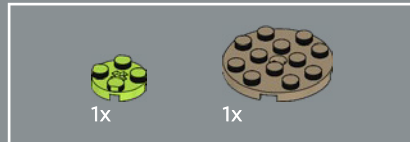
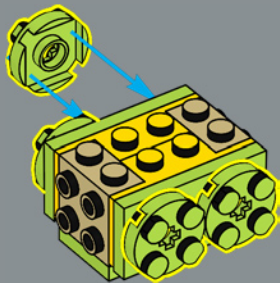

23

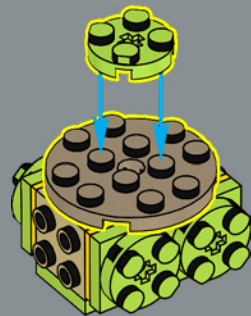



8x

24

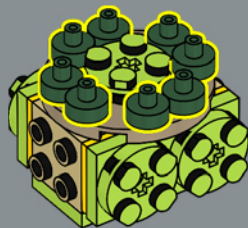



25

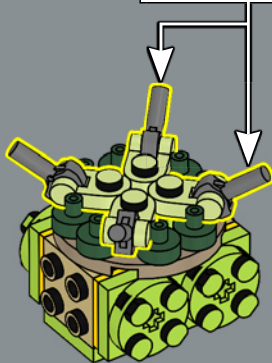
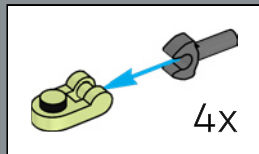

26

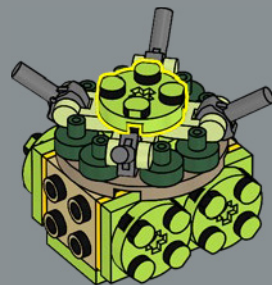

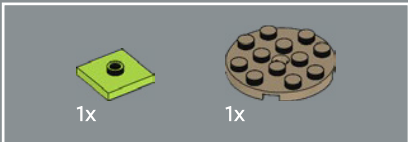

27

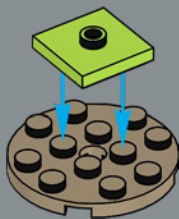

28

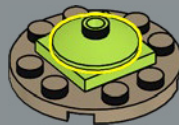



1x



4x

29

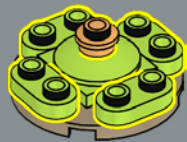

4x

30





31



32





33



34

Several species of pincushion cactus grow a lovely crown of flowers in vivid colors.
Plusieurs espèces de cactus pelote produisent une belle couronne de fleurs aux couleurs vives.

De varias especies de cactus crecen hermosas coronas de coloridas flores.

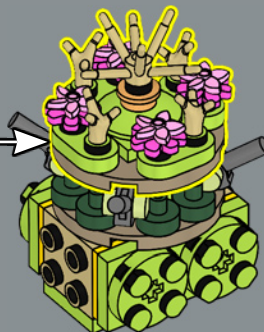

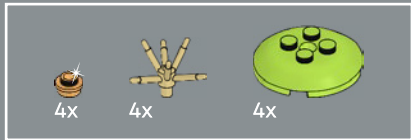

35

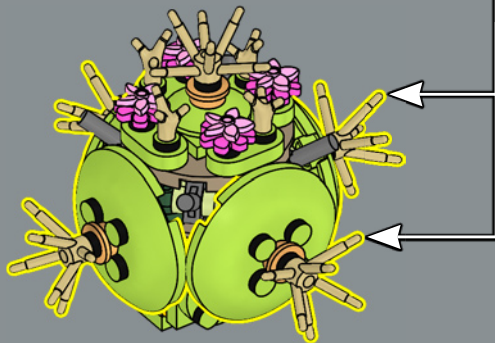
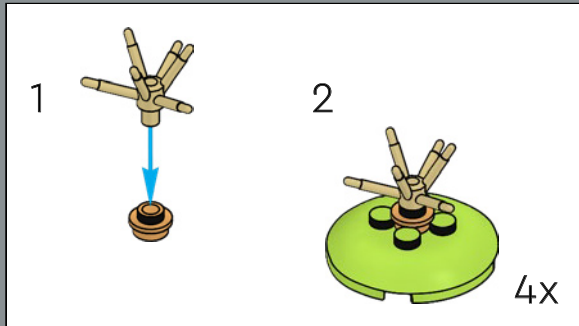

36

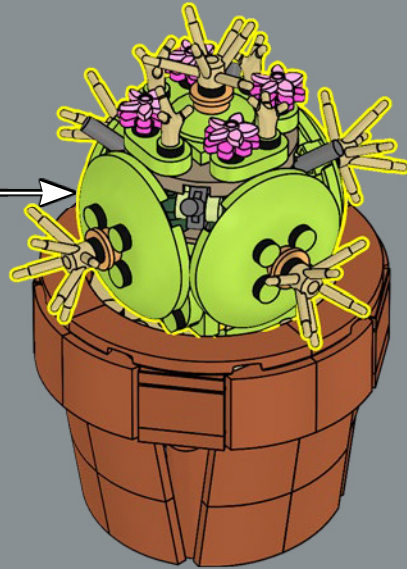

After being catalogued for the first time in the late 1920s, *Mammillaria crinata f. zeilmanniana* was largely unknown, until it was rediscovered in 1988 within a specific canyon area in Mexico.

Après avoir été cataloguée pour la première fois à la fin des années 1920, la *Mammillaria crinata f. zeilmanniana* est restée largement inconnue, jusqu'à ce qu'elle soit redécouverte en 1988, uniquement dans une zone spécifique d'un canyon au Mexique.

Poco se supo de la *Mammillaria crinita f. Zeilmanniana* luego de que fuera catalogada por primera vez a finales de la década de 1920. Mucho tiempo después, en 1988, fue redescubierta solo en una zona específica de un cañón en México.

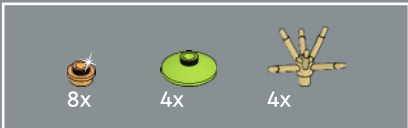
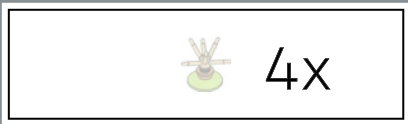

37

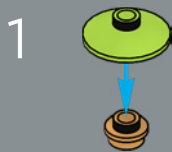

2



3

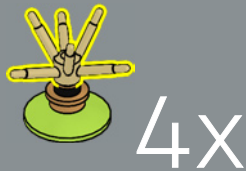

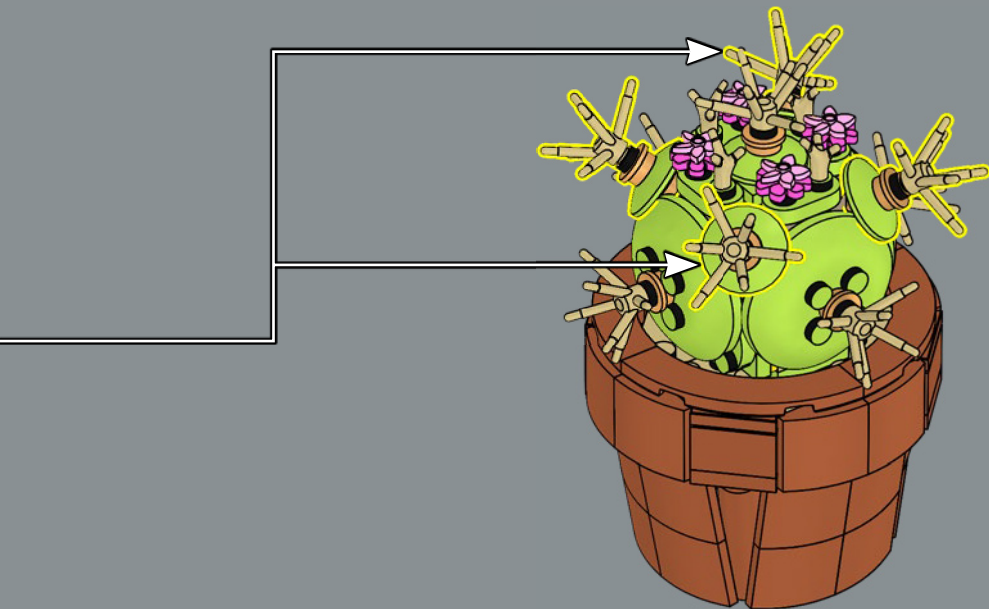



12x
6439046



3x
6302268



8x
6210269



2x
6468074



6x
4644456



1x
6074954



3x
6009016



12x
4114309



3x
4142865



1x
6170487



3x
6089119



2x
6399780



4x
6324176



1x
6449709



1x
6132541



1x
6168644



3x
4558957



2x
302228



13x
4140562



2x
6439048



1x
6102138



1x
6365630



3x
4243819



4x
6451597



2x
6214334



4x
6368619



2x
6135130



2x
6313592



5x
6382575



4x
6328327



10x
6463564



4x
6348058



4x
6370686



2x
302224



10x
6210271



4x
6468078



4x
4208072



2x
6400110



2x
302221



2x
6118828



2x
6253140



8x
6400649



2x
6138624



2x
4119479



3x
6161772



24x
4570877



12x
6468067



12x
4614158



12x
6228839



96x
6104344



12x
6394948



12x
6439724



12x
6468066



12x
6468071



3x
6462459



6x
4535928

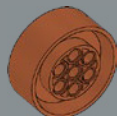

3x
6462460



12x
6468069



4x
6240030



1x
6147052

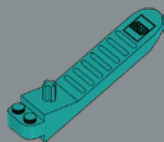

1x
6254100



6x
6211875



13x
6264062



2x
6190251



4x
6468391



13x
6314224



2x
6438450



5x
6121816



2x
6468075



1x
6056291



4x
6468077



3x
4537936



2x
6143445



13x
6300322



5x
6132767

2x
6092591

4x
6038637

6x
6232138

13x
6190252



8x
6454462

5x
6397157

8x
6392975

6x
6403175

5x
6303004

2x
6357616

3x
6468072

3x
6467694

3x
6223237

8x
6468343

4x
6360079

1x
6448317

1x
6456642

1x
4211183

3x
6133765

20x
6306775

6x
6102360

1x
6349130

36x
6470170

1x
6313506

4x
6075207

1x
6170468

12x
6335378

4x
4211526

12x
6123809

12x
6195471

1x
6420921

4x
6439040

7x
6395635

6x
4210725

3x
4227398

1x
6230582

4x
6206151

4x
6096990

3x
6468345

8x
6426463

6x
6468346

5x
6005030

1x
6251854

4x
6210460

4x
6468342

1x
6275487

4x
6223506

12x
6468504

4x
6468079

 [LEGO.com/service](https://www.lego.com/service)



YOU COULD WIN



YOU COULD WIN

Your feedback will help shape the future development of this product series.

Visit:

DU KÖNNTEST GEWINNEN

Dein Feedback trägt zur Weiterentwicklung dieser Produktreihe bei.

Geh auf:

VOUS POURRIEZ GAGNER

Vos commentaires nous aideront à concevoir les futurs produits de cette gamme.

Visitez :

POTRESTI VINCERE TU

La tua opinione ci aiuterà a migliorare la creazione futura di questa linea di prodotti.

Visita:

PUEDES GANAR

Tu opinión contribuirá al futuro de esta serie de productos.

Visita:

轻松获奖

您的反馈将有助于我们在今后改进本产品系列。

请访问:

LEGO.com/productfeedback

You also have the chance to win a LEGO® set.

Terms and conditions apply.*

Außerdem hast du die Chance, ein LEGO® Set zu gewinnen.

Es gelten die Teilnahmebedingungen.*

Vous pourriez également gagner un ensemble LEGO®.

Des conditions s'appliquent.*

Hai anche la possibilità di vincere un set LEGO®.

Termini e condizioni sono applicabili.*

También tienes la oportunidad de ganar un set LEGO®.

Aplican términos y condiciones.*

您还有机会赢取乐高®套装。

条款和条件适用。*

*LEGO.com/productfeedback-terms



LEGO and the LEGO logo are trademarks of the/sont des marques de commerce du/son marcas registradas de LEGO Group.
©2024 The LEGO Group. 6494686