

1989

# BATWING

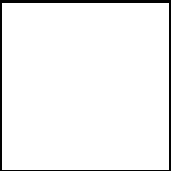

Booklet available in English on  
Livret disponible en français sur  
Folleto disponible en español en  
[LEGO.com/service/buildinginstructions](https://www.lego.com/service/buildinginstructions)





[LEGO.com/brickseparator](https://www.lego.com/brickseparator)

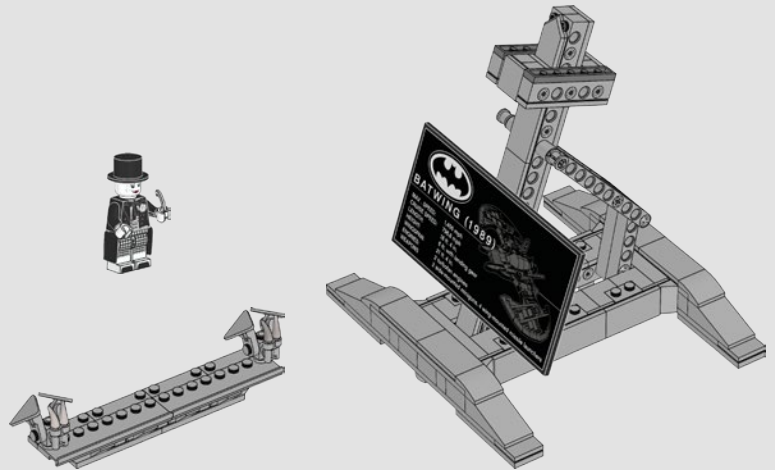
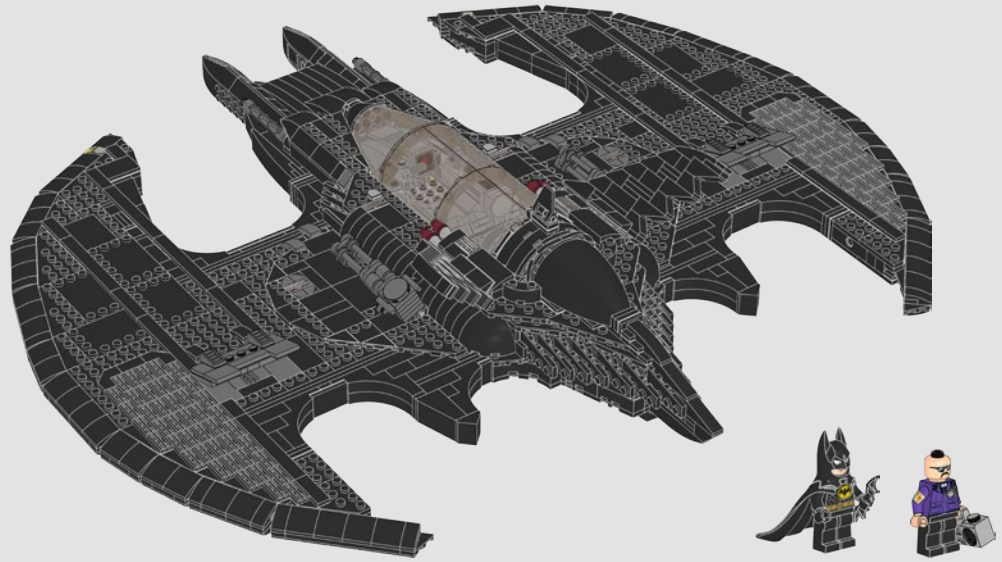
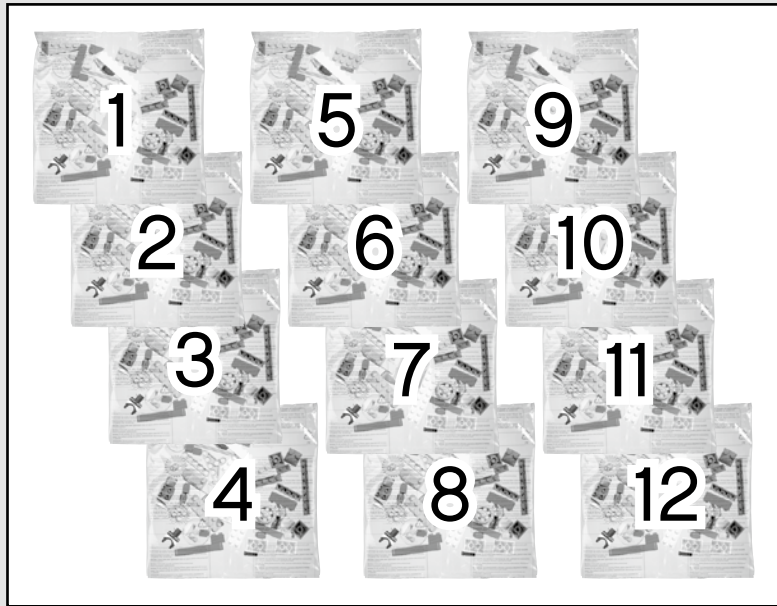



**IF THE FORCES OF EVIL SHOULD RISE AGAIN TO CAST A SHADOW ON THE  
HEART OF THE CITY, CALL ME"**

- Letter from Batman™ to the citizens of GOTHAM CITY™, Batman™ (1989).

**« SI LES FORCES DU MAL DEVAIENT SE RELEVER ET JETER UNE OMBRE SUR  
LE CŒUR DE LA VILLE, APPELEZ-MOI. »**

- Lettre de Batman™ aux citoyens de GOTHAM CITY™, Batman™ (1989).

**"SI LAS FUERZAS DEL MAL LLEGAN DE NUEVO SALIENDO DE LAS SOMBRAS  
DEL CORAZÓN DE LA CIUDAD, LLÁMENME".**

- Carta de Batman™ a los ciudadanos de GOTHAM CITY™, Batman™ (1989)

La  
**BATWING**  
de 1989

**BATIPLANO**  
de 1989





### THE INSPIRATION

The Batwing™ is the epitome of the Caped Crusader™. For one thing, a bat has to fly, of course. But more than that, its silhouette against the full moon in *Batman™* (1989) emulates the Bat-Signal™ – the iconic beacon of hope that summons Batman in the darkest hours of GOTHAM CITY™.

### L'INSPIRATION

Le Batwing™ est la quintessence du justicier masqué. D'une part, une chauve-souris doit voler, bien entendu. Mais plus encore, sa silhouette devant la pleine lune dans *Batman™* (1989) imite le Bat-Signal™ – l'emblématique phare de l'espoir qui appelle Batman dans les heures les plus sombres de GOTHAM CITY™.

### LA INSPIRACIÓN

El Batiplano representa a la perfección la esencia del Cruzado de la Capa. Para empezar, un murciélago tiene que poder volar, por supuesto. Pero, más allá de eso, su silueta contrastada ante la luna llena en la película *Batman™* (1989) emula la batiseñal: el inconfundible rayo de esperanza que avisa a Batman cuando GOTHAM CITY™ se sumerge en sus horas más oscuras.

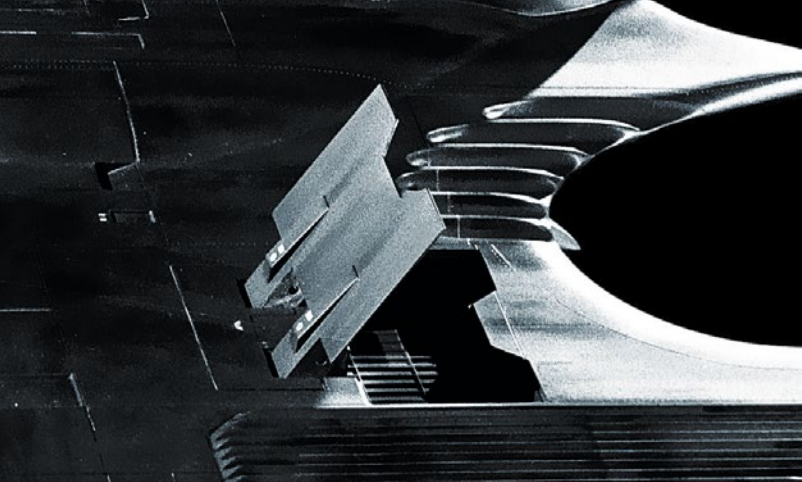

## THE DESIGN PROCESS

Eager to capture the mood, brood and spirit of the movie, our designers went all out to recreate the distinctive features of the Batwing™.

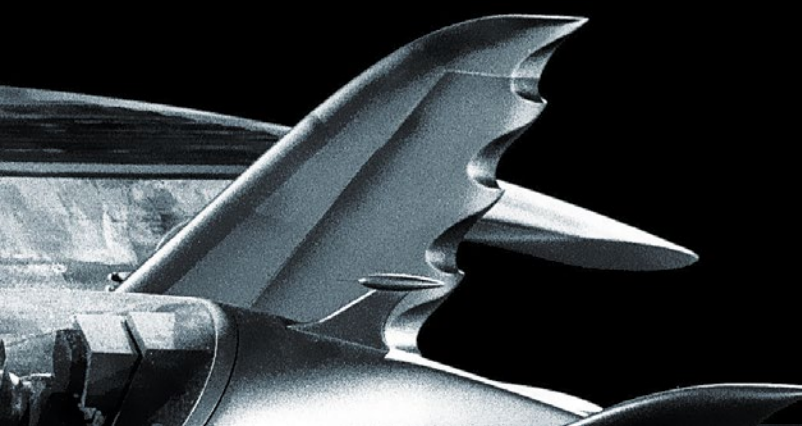

## LE PROCESSUS DE CONCEPTION

Désireux de saisir l'ambiance, la noirceur et l'esprit du film, nos concepteurs se sont donnés corps et âme pour recréer les caractéristiques distinctives du Batwing™.



## EL PROCESO DE DISEÑO

Nuestros diseñadores, ansiosos por captar la atmósfera, la melancolía y el espíritu de la película, se esforzaron al máximo para recrear los rasgos distintivos del Batiplano.

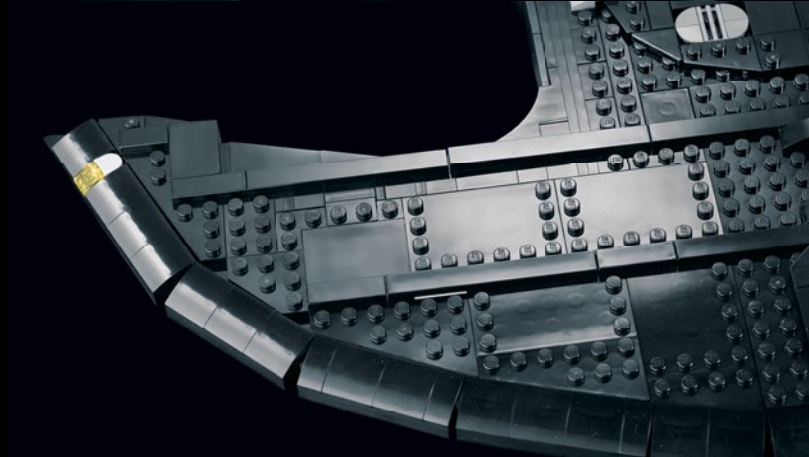
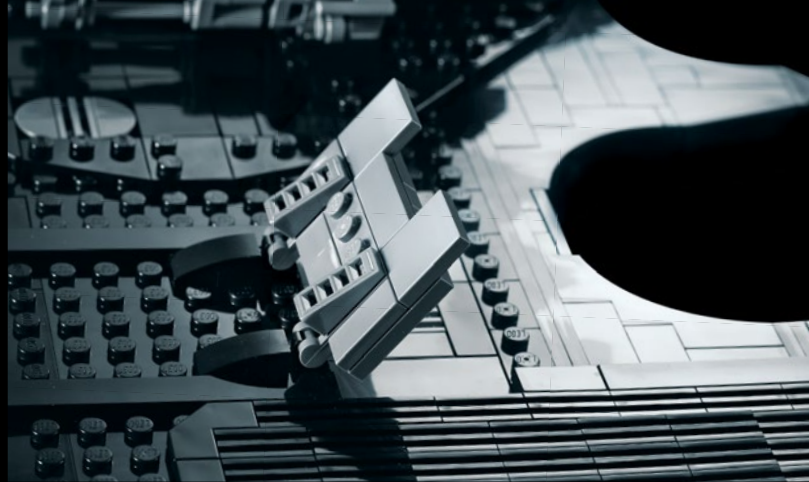



### **ADAM GRABOWSKI, SENIOR MODEL DESIGNER**

"The Batwing™ movie model actually isn't very detailed, but its shape is what gives it life, so it was important to get that right. I tackled it as one unit instead of one feature at a time. It's only shown very briefly in the movie, and most details can be seen inside the cockpit. But we had blueprints that, knowing the dimensions, we blew up to scale with the 1989 Batmobile™ 76139. Then we mapped out the cockpit window and went from there. We opted for a built solution rather than a one-piece window because in our opinion it worked almost at once."

---

### **ADAM GRABOWSKI, CONCEPTEUR PRINCIPAL DE MODÈLES**

« Le modèle du Batwing™ du film n'est pas vraiment détaillé, mais c'est sa forme qui lui donne vie. Il était donc important de bien la rendre. Je l'ai approché comme un tout au lieu de me concentrer sur une caractéristique à la fois. On ne l'aperçoit que très brièvement dans le film, et on peut voir la plupart des détails à l'intérieur du poste de pilotage. Mais nous avons des plans que nous avons convertis à l'échelle de la Batmobile™ 1989 (76139). Puis nous avons schématisé la fenêtre du poste de pilotage comme point de départ. Nous avons opté pour une solution construite plutôt qu'une fenêtre d'une seule pièce, puisque cela nous semblait fonctionner presque immédiatement. »

---

### **ADAM GRABOWSKI, DISEÑADOR SÉNIOR DE MODELOS**

"El modelo del Batiplano que aparece en la película no es especialmente detallado; lo que en realidad le da vida es su forma, así que era fundamental reproducirla con precisión. En lugar de ir elemento por elemento, resolví el diseño enfocándolo como una unidad. Sale muy brevemente en contadas escenas, y la mayoría de los detalles que se aprecian están adentro de la cabina. Pero contábamos con planos, conocíamos las dimensiones y, por tanto, pudimos reducirlo a la escala del modelo 1989 Batmobile™ (76139). Luego nos centramos en la cubierta transparente de la cabina y seguimos a partir de ahí. Nos decidimos por una solución construible en lugar de optar por una cubierta de una pieza porque, en nuestra opinión, en cuanto nos pusimos a probar, funcionó casi a la primera".



## INTERPRETING THE CONSTRUCTION

"We took a few creative liberties inside the cockpit. It's not an angle you really get to see, and we had to create an artificial shadow so that the footwell looks deeper than it actually is. The edges of the wings (in bags 5 and 6) are quite unusual and a fun challenge to build! They wrap around the outer curve of the wing, which isn't a perfect half circle. I created the outline with techniques that allowed me to flip bricks in a way so I could always use the best brick for the shape I needed. It's a crazy puzzle but it works!"

## INTERPRÉTATION DE LA CONSTRUCTION

« Nous avons pris quelques libertés créatives pour l'intérieur du poste de pilotage. Ce n'est pas un angle qu'il vous est vraiment donné de voir, et nous avons dû créer une ombre artificielle de sorte que le plancher semble plus profond qu'il ne l'est réellement. Les bordures des ailes (dans les sacs 5 et 6) sont assez inhabituelles et représentent un défi amusant à construire ! Elles suivent la courbe extérieure de l'aile, qui n'est pas un demi-cercle parfait. J'ai créé le contour avec des techniques qui m'ont permis de retourner les briques d'une manière telle que je puisse toujours utiliser la meilleure brique pour la forme dont j'avais besoin. C'est tout un casse-tête, mais ça marche ! »

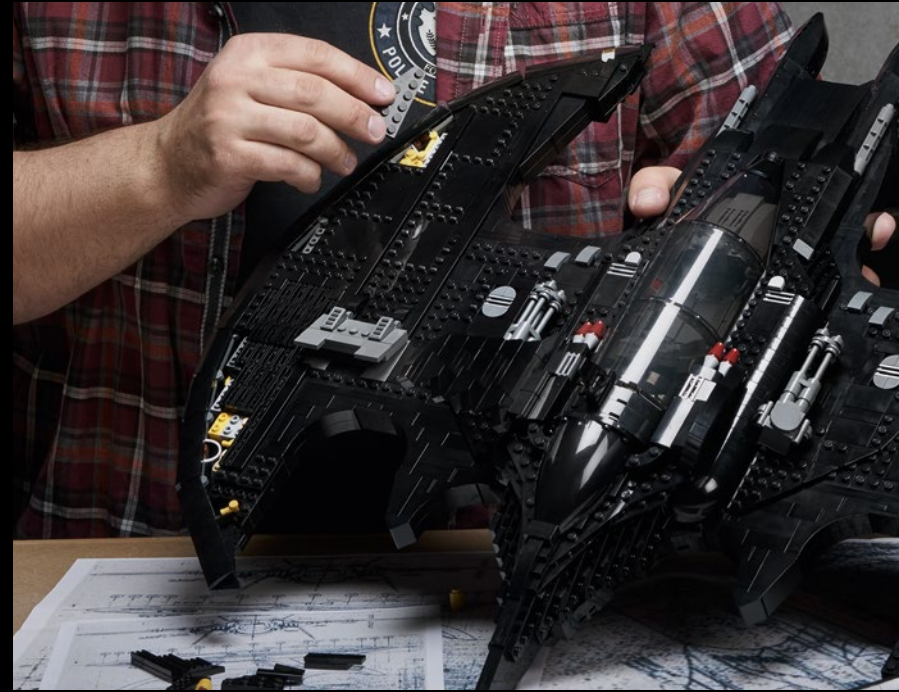

## INTERPRETACIÓN DE LA CONSTRUCCIÓN

"Nos tomamos algunas libertades creativas en el interior de la cabina. En realidad, ningún encuadre nos lo enseña por completo. Tuvimos que crear una sombra artificial para que el espacio para las piernas diera una sensación de profundidad que ciertamente no tiene. Los bordes de las alas (en las bolsas 5 y 6) son muy inusuales, ¡y representan un divertido desafío de construcción! Recubren la curva exterior del ala, que no es un semicírculo perfecto. Creé el contorno con técnicas que me permitieron voltear bricks de tal manera que pudiera usar siempre el mejor brick para la forma que necesitaba. Es un rompecabezas descabellado, ¡pero funciona!".



## IOANA POPESCU, GRAPHIC DESIGNER

"I loved creating the minifigures and stickers for this set. Especially the Boombox Goon™. He's such a fun character and nicely detailed. This was my fourth The Joker™ minifigure and the most unique so far. Graphic design brings the story into the model. Look for Easter eggs like the screen with the iconic Smylex gas balloon and the sticker that labels the engine as a 'Bat engine' (Adam's idea!). Working with Adam is always a smooth process, except for a mistake I made on a sticker which I had to correct quite late in the process (oops)!"

## IOANA POPESCU, GRAPHISTE

« J'ai adoré créer les figurines et les autocollants pour cet ensemble. Surtout l'homme de main tenant une radiocassette. C'est un personnage amusant et bien détaillé. C'était ma quatrième figurine Le Joker™ et la plus unique à ce jour. La conception graphique infuse l'histoire dans le modèle. Cherchez les œufs de Pâques, comme l'écran avec l'emblématique ballon de gaz Hilarex et l'autocollant sur le moteur qui le qualifie de "Bat-moteur" (une idée d'Adam !). Travailler avec Adam se passe toujours sans accrocs, sauf pour une erreur que j'ai commise sur un autocollant et que j'ai dû corriger assez tard durant le processus (oops) ! »



## IOANA POPESCU, DISEÑADORA GRÁFICA

"Me encantó crear las minifiguras y las calcomanías para este set. Especialmente el matón de la grabadora. Es un personaje divertidísimo y lleno de detalles. Respecto a The Joker™, es la cuarta minifigura que hago de este villano y la más especial hasta ahora. El diseño gráfico envuelve al modelo en la historia. Busca sorpresas como la pantalla que muestra el famoso globo con gas de Sonríex y la calcomanía con el rótulo 'Bat engine' pegada en el motor (¡fue idea de Adam!). El trabajo con Adam siempre es muy dinámico, sin contratiempos, ¡excepto por un error que cometí en una calcomanía y que tuve que corregir bastante avanzado el proceso (vaya...)!".



"I'M BATMAN."

« JE SUIS BATMAN. »

"SOY BATMAN".







### THE BATWING™ MOVIE MODEL

A life-size model of the Batwing™ was built for the close-up flying scenes when Batman™ takes on The Joker™ at the 200th anniversary celebration of GOTHAM CITY™. He grabs the toxic Smylex-filled parade balloons from The Joker's float and flies off, releasing them into the night sky. Guns blazing, he zooms back towards the grinning maniac on the ground in a theatrical showdown that ends in a dramatic crash.

### LE MODÈLE BATWING™ DU FILM

Un modèle grandeur nature du Batwing™ a été construit pour les scènes de vol en gros plan, lorsque Batman™ affronte le Joker™ à la cérémonie du 200<sup>e</sup> anniversaire de GOTHAM CITY™. Il arrache les ballons de défilé remplis d'Hilarex toxique du char allégorique du Joker et s'envole, les relâchant dans le ciel nocturne. Il plonge ensuite vers le désaxé souriant et déclenche une pluie de balles, ce qui donne lieu à un affrontement théâtral qui prend une tournure dramatique.

### EL MODELO DEL BATIPLANO EN LA PELÍCULA

Se construyó un modelo del Batiplano a tamaño real para las escenas de vuelo en las que Batman™ enfrenta a The Joker™ durante el desfile de la celebración del 200 aniversario de GOTHAM CITY™. El superhéroe engancha los globos llenos de gas tóxico de Sonríex sujetos al carro alegórico de The Joker, se aleja volando y los suelta en el cielo nocturno. De inmediato y con sus armas listas para disparar, regresa a toda velocidad hacia el sonriente lunático, que le espera desafiante sobre el asfalto, y protagonizan un teatral duelo que termina en una espectacular colisión.

## **READY FOR TAKEOFF**

The movie version of this Batwing™ may have crashed on the steps of the GOTHAM CITY™ Cathedral, but this one you can build, rebuild and display wherever you like. Follow the instructions, get ready to save GOTHAM CITY from the world's first fully functioning homicidal artist, and give the world a rest from crime.

---

## **PRÊT POUR LE DÉCOLLAGE**

La version cinématographique du Batwing™ s'est peut-être écrasée sur les marches de la cathédrale de GOTHAM CITY™, mais celle-ci peut être construite, reconstruite et exposée. Suivez les instructions, préparez-vous à sauver GOTHAM CITY du premier artiste meurtrier autonome au monde, et faites la guerre à la criminalité.

---

## **PREPARADOS PARA DESPEGAR**

La versión cinematográfica de este Batiplano puede haberse estrellado en las escaleras de la catedral de GOTHAM CITY™, pero tú puedes construirlo, reconstruirlo y exhibirlo donde quieras. Sigue las instrucciones, prepárate para salvar GOTHAM CITY de las fechorías del artista homicida más importante de la Tierra y ayuda a esta ciudad a descansar del crimen.

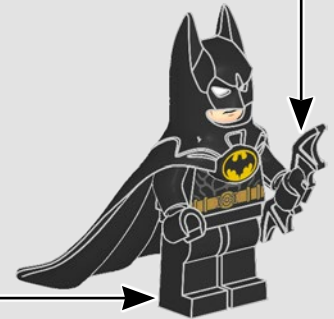
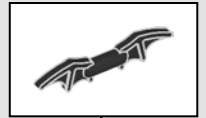
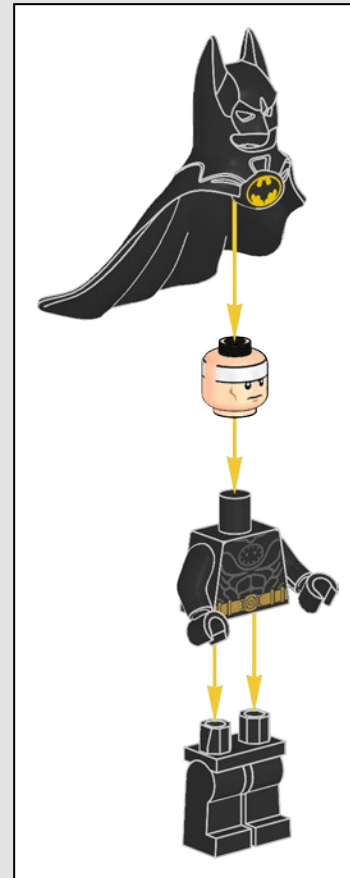
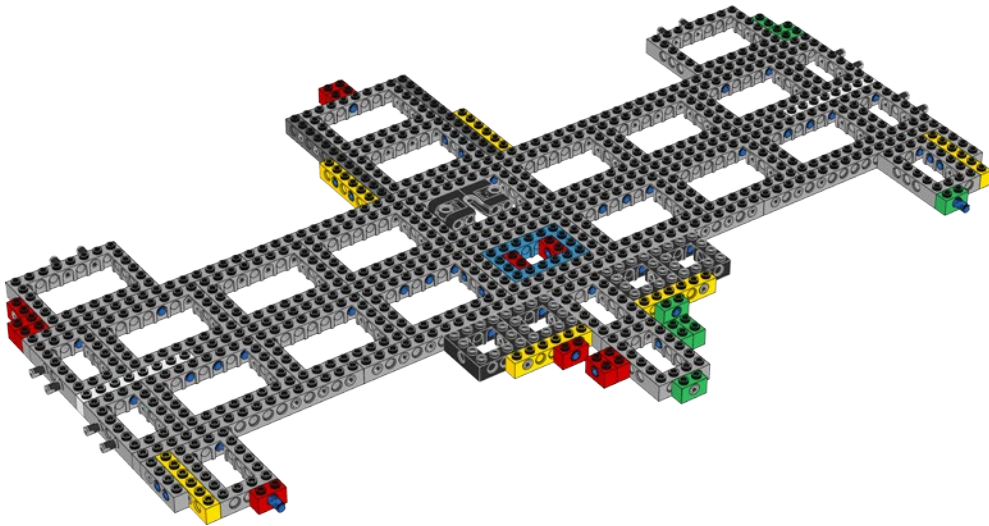
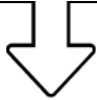
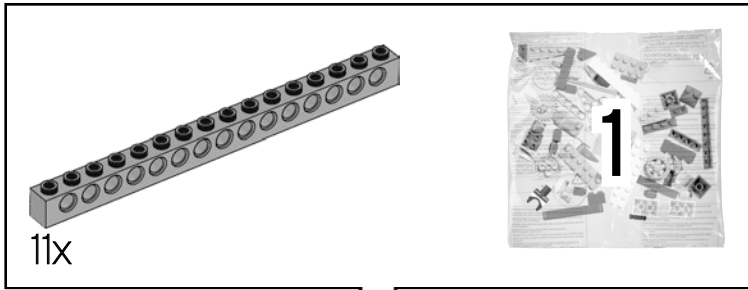



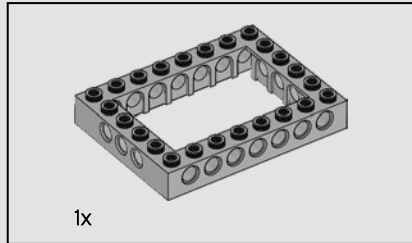
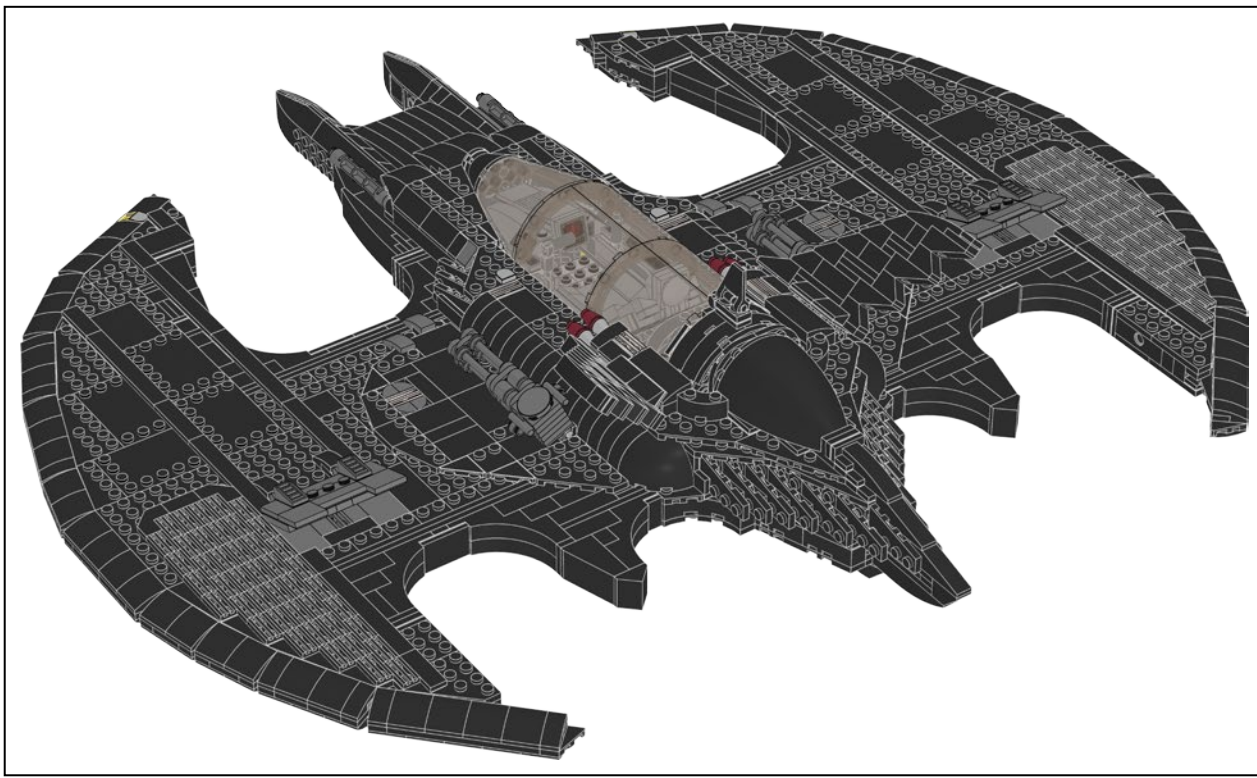

1

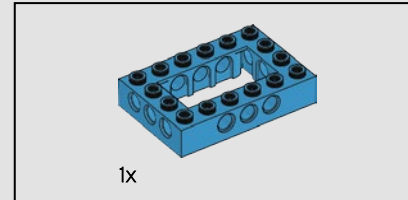
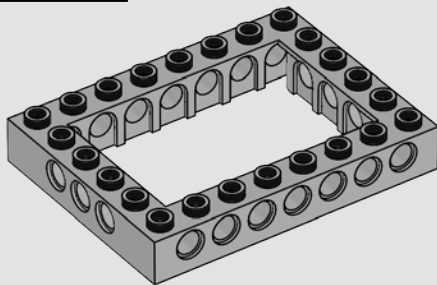

2

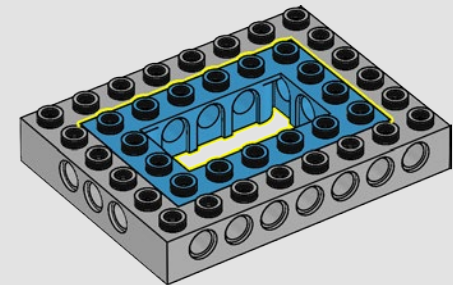

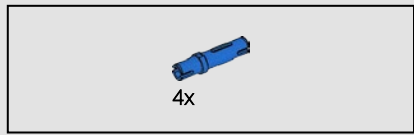

3

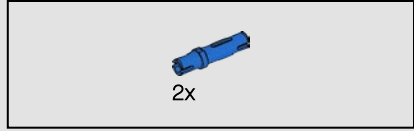
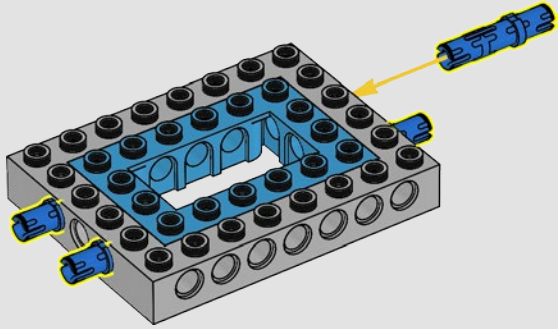

4

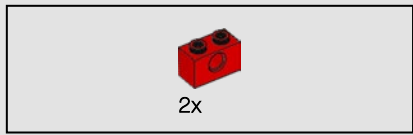
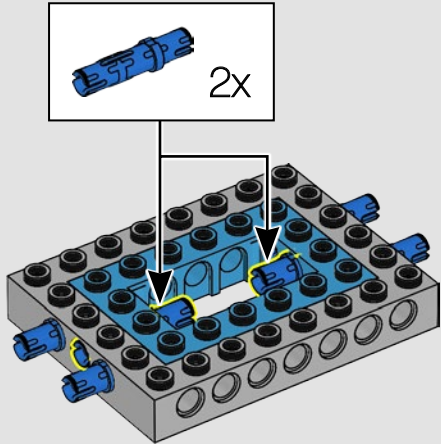

5

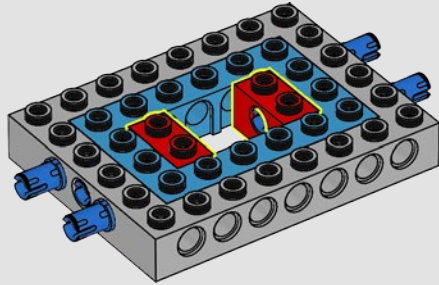

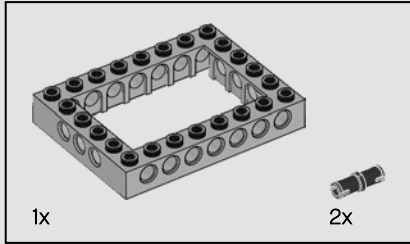
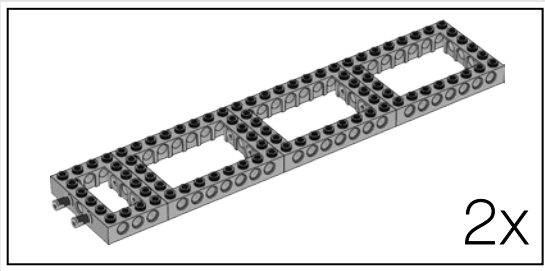

6

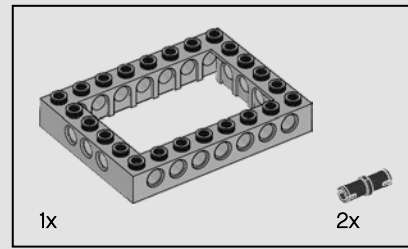
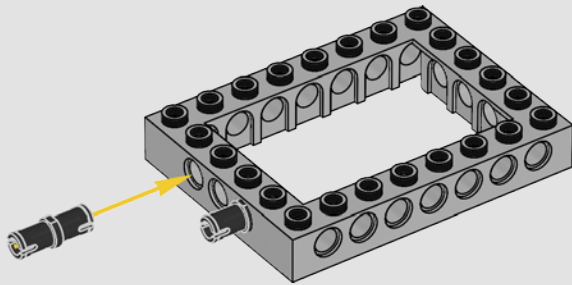

7

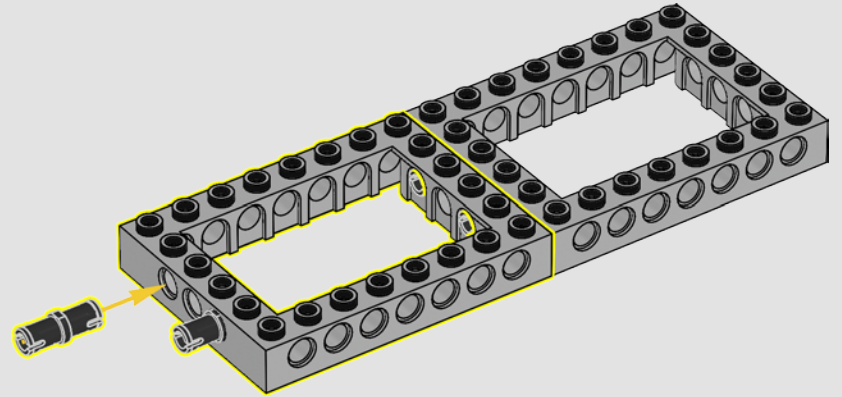

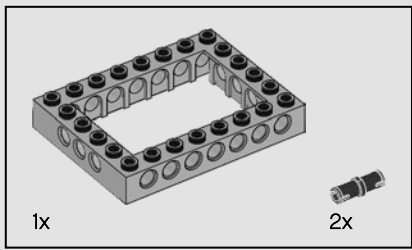

8

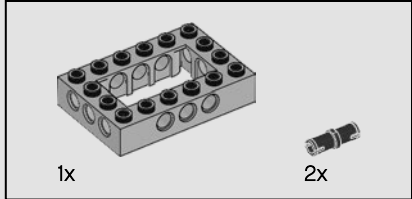
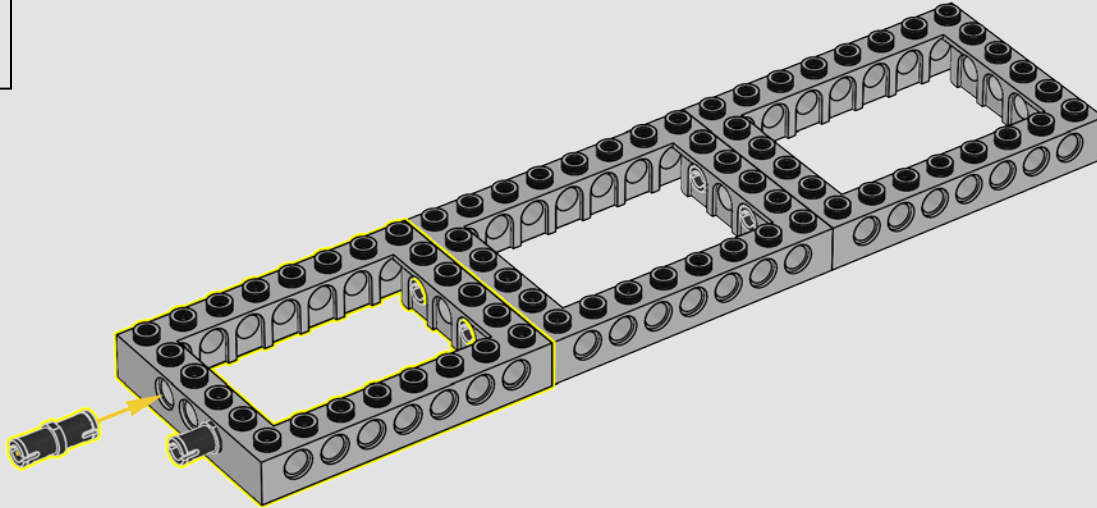

9

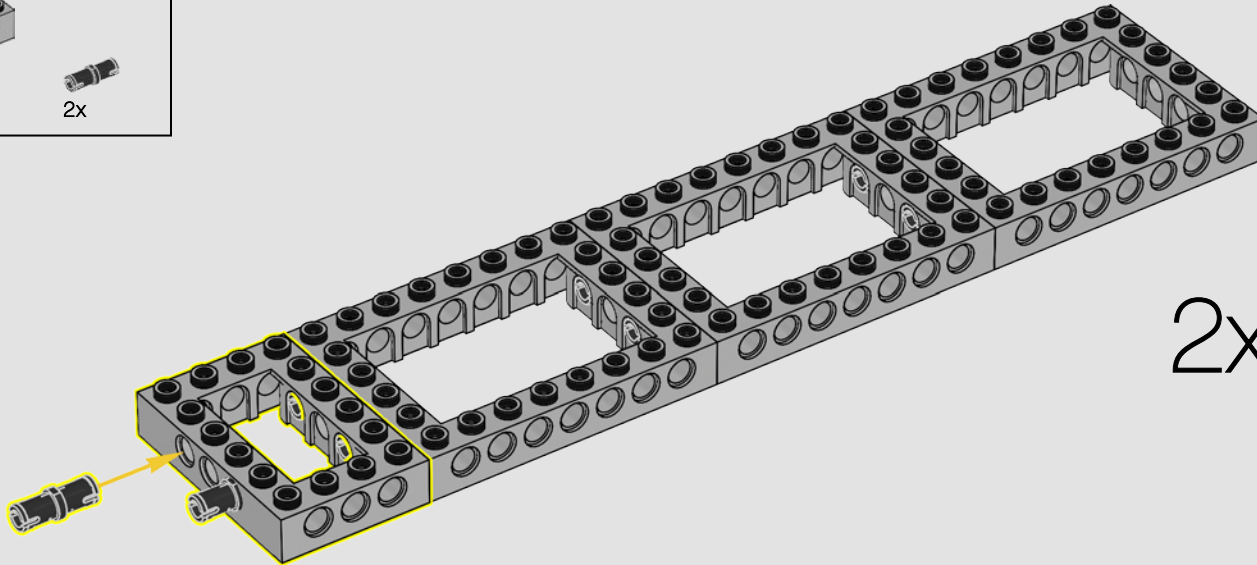

2x

10

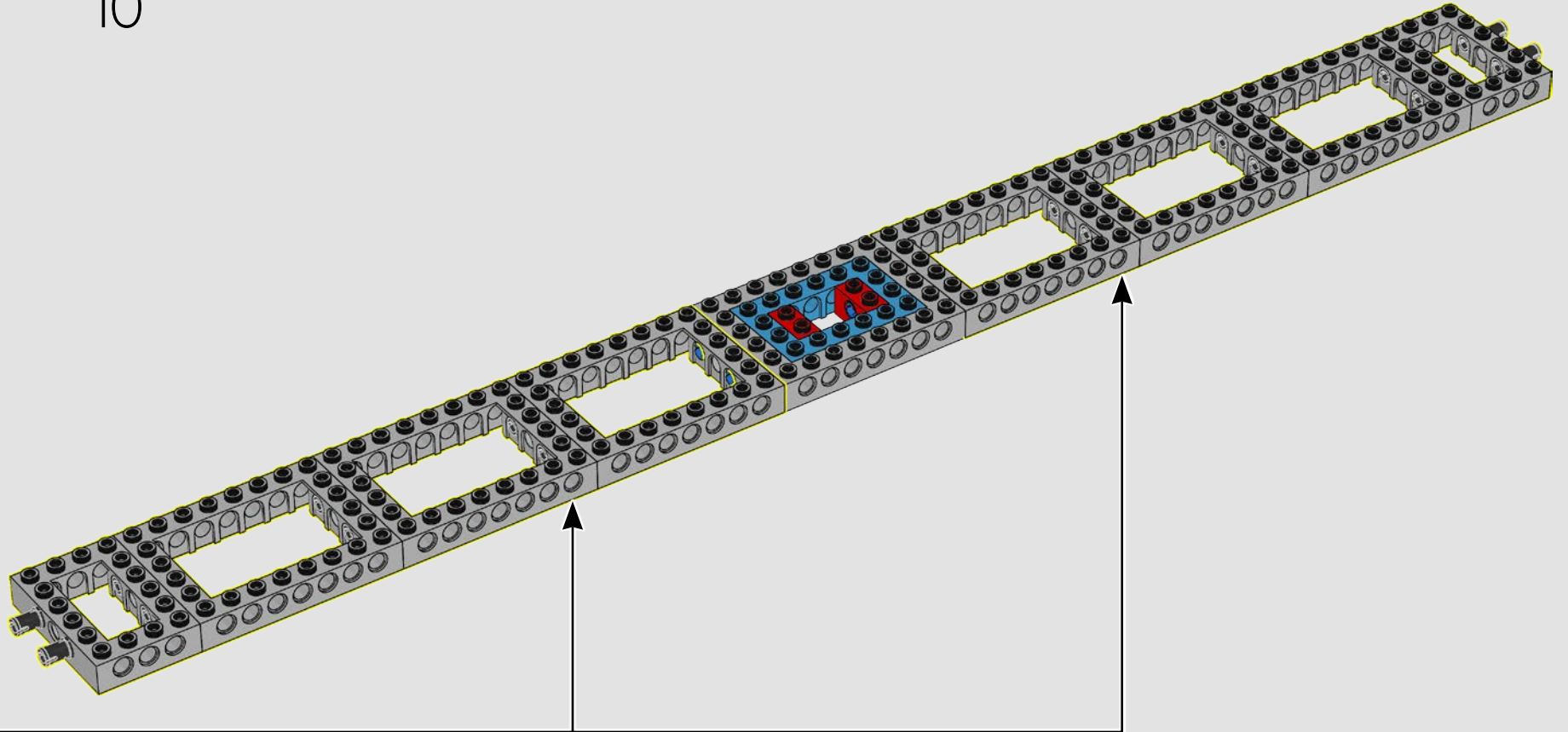



12x

11

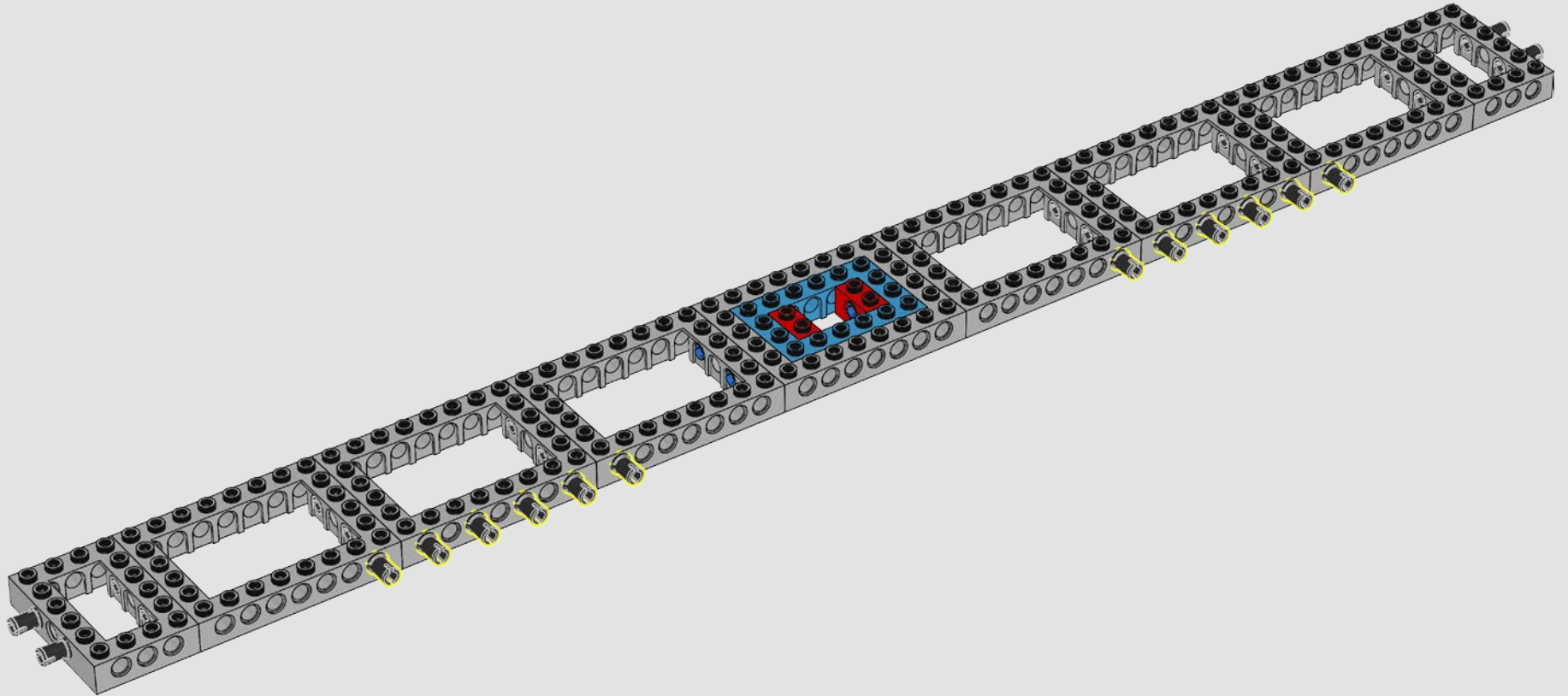

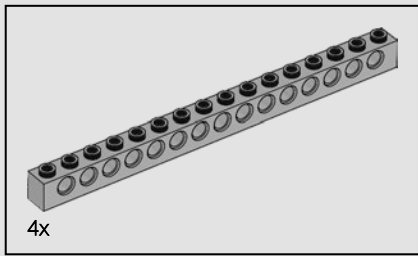

12

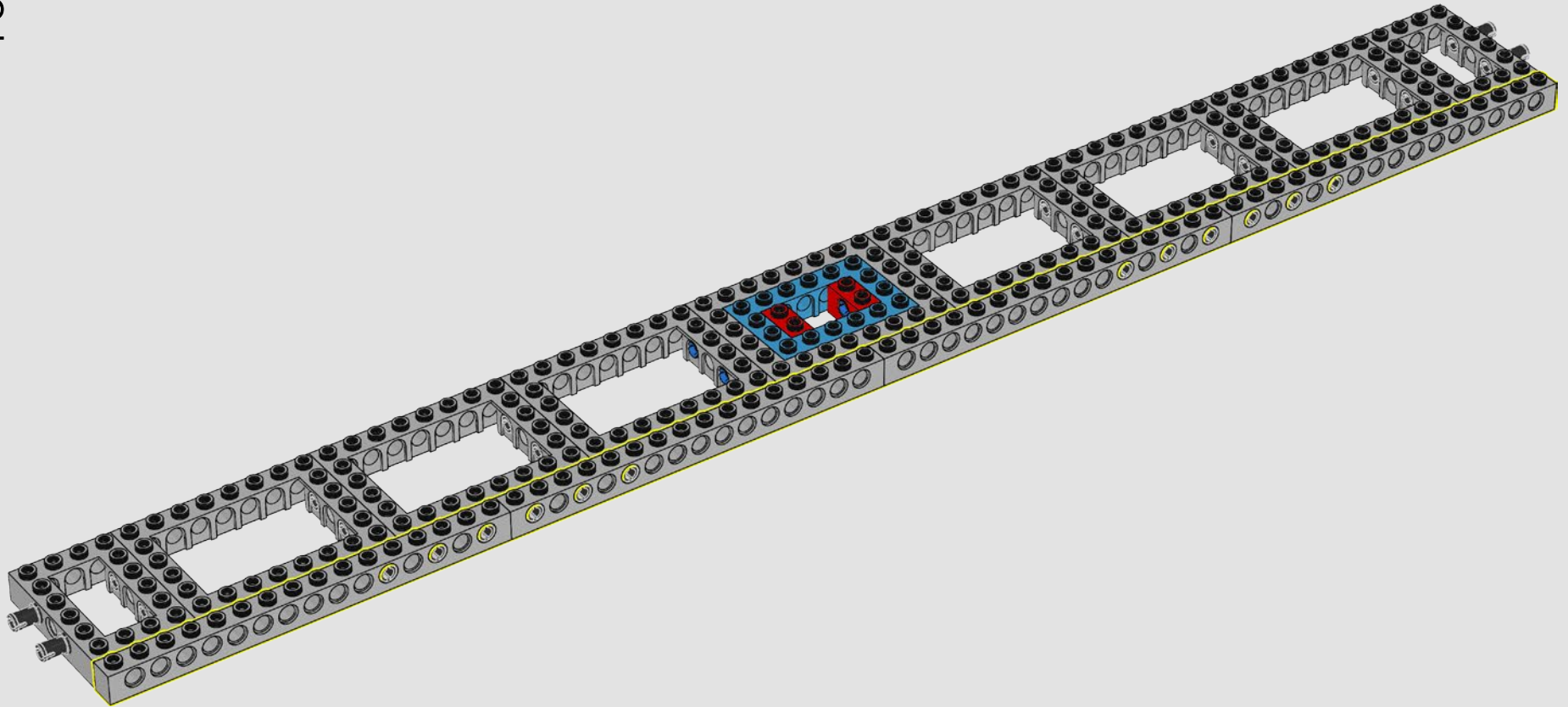



13

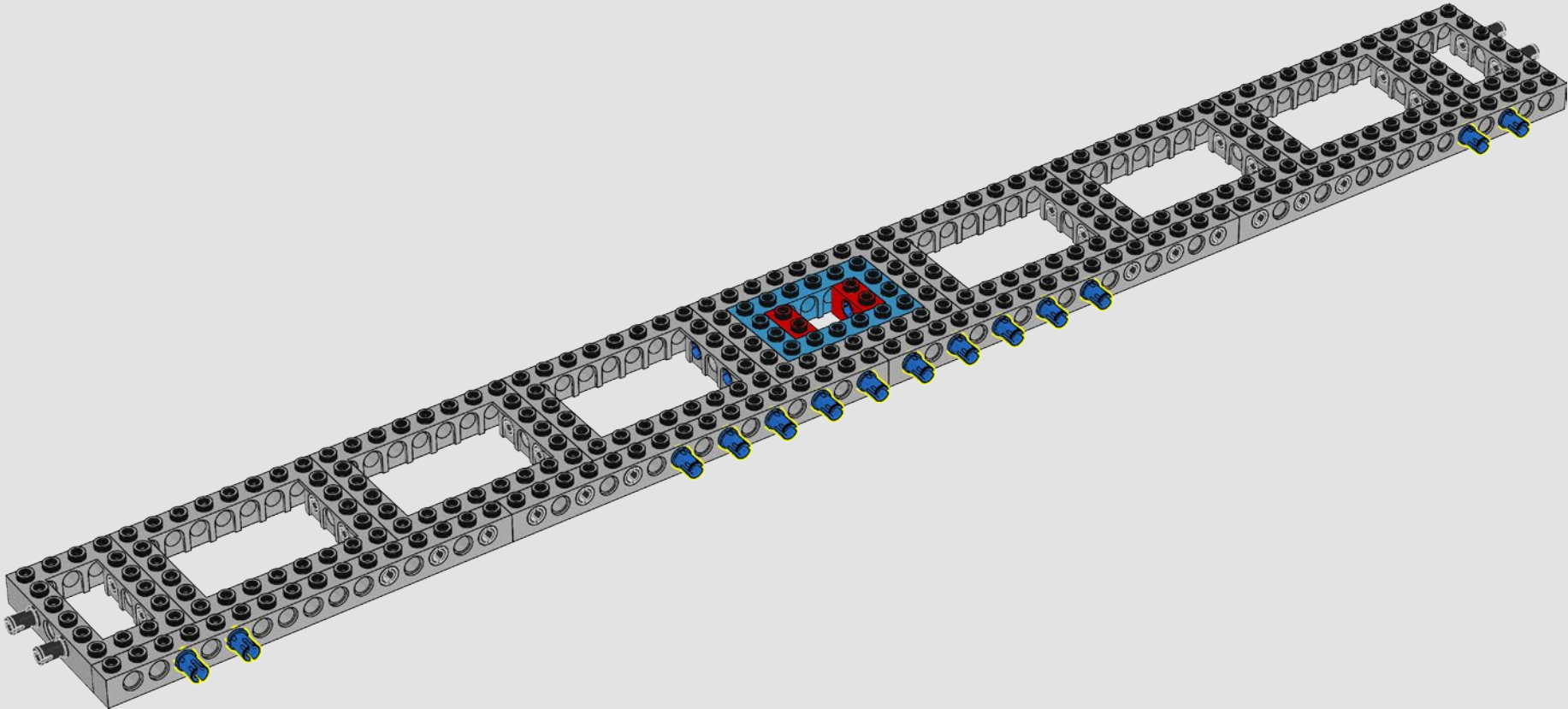



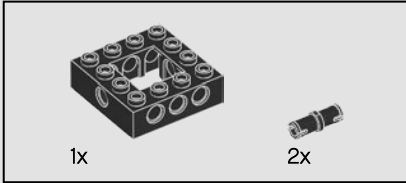
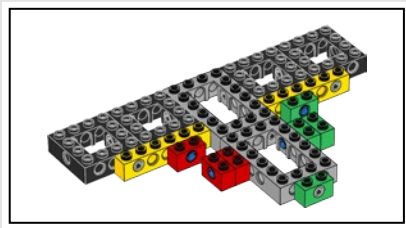

14

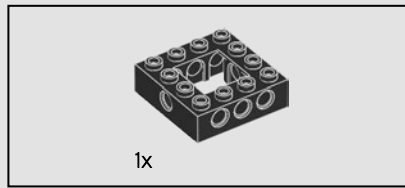
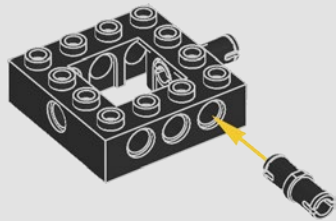

15

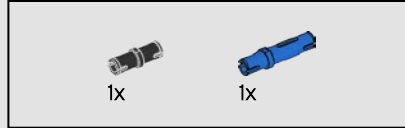
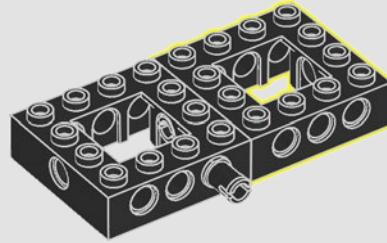

16

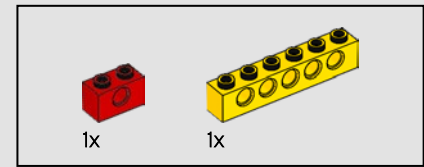
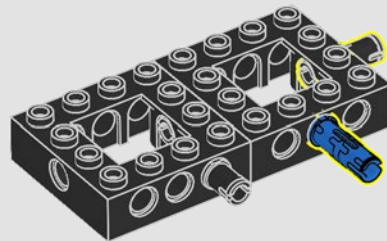

17

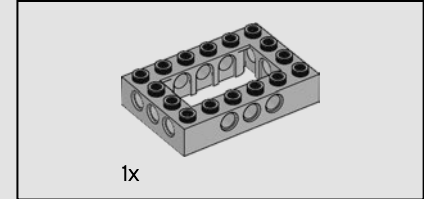
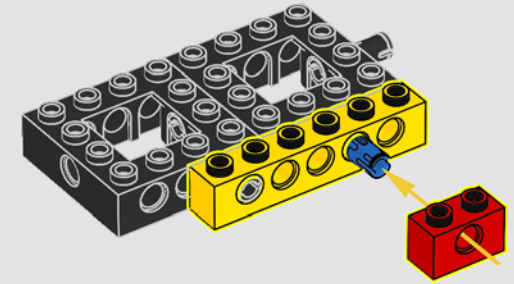

18

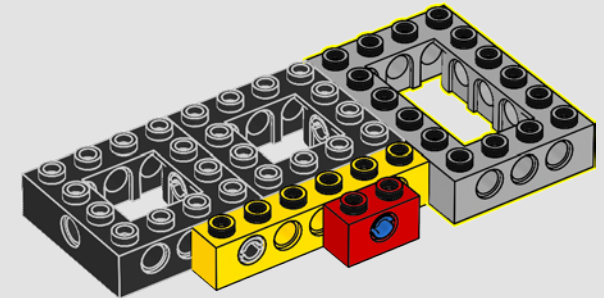

3x

19

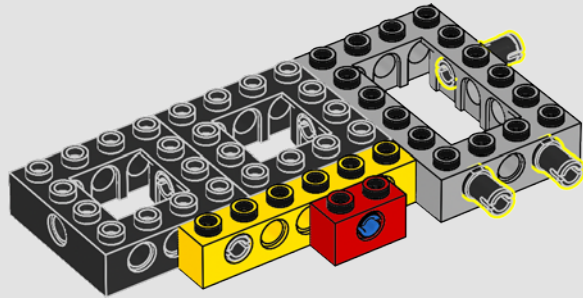

1x

1x

21

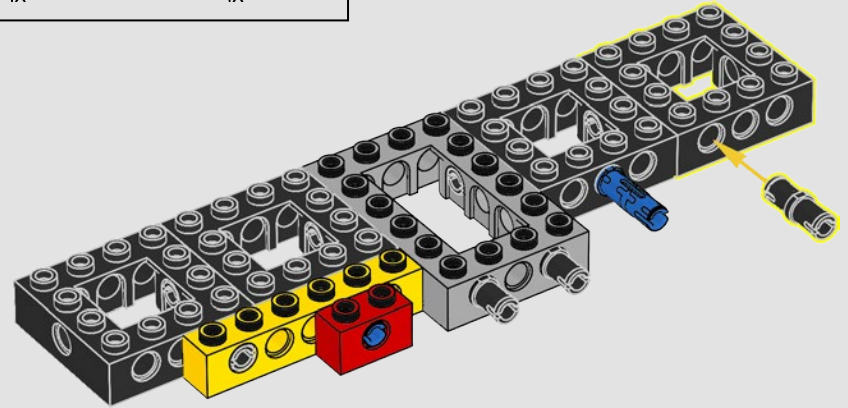

1x

1x

1x

20

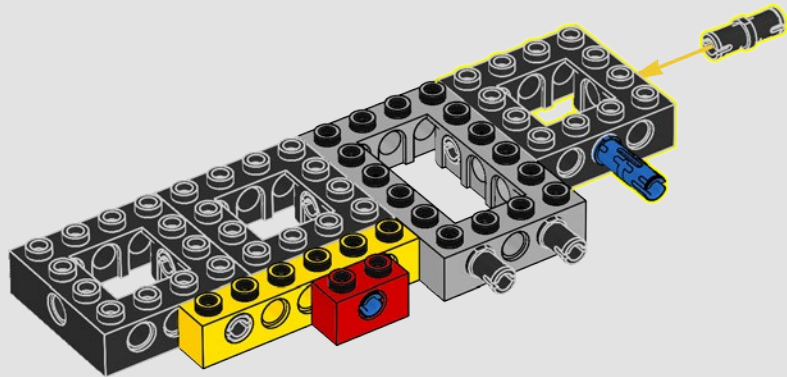

1x

1x

22

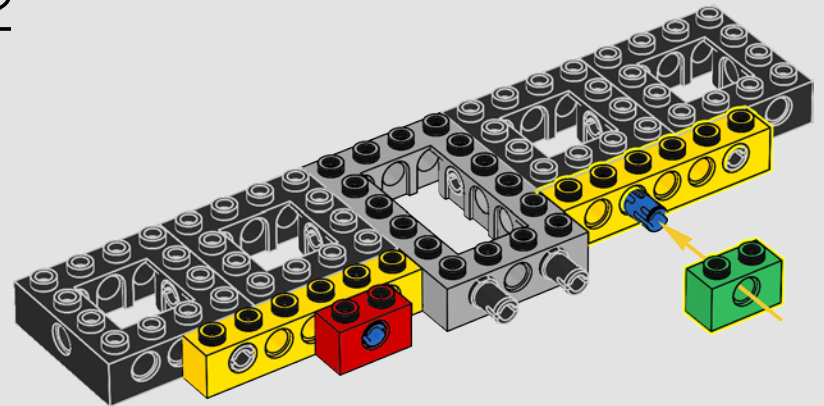

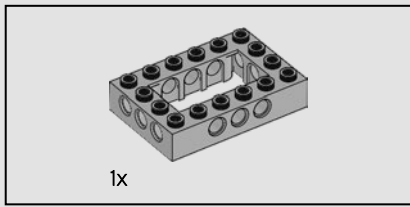

23

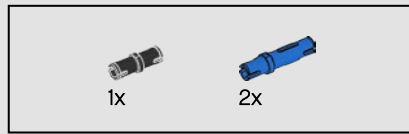
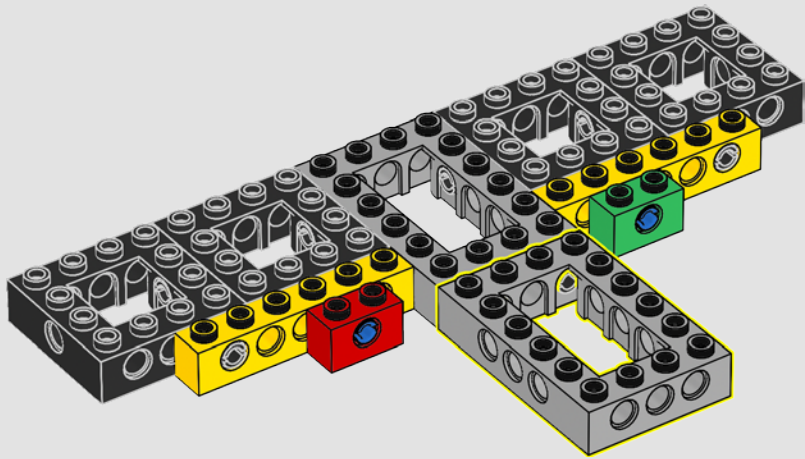

24

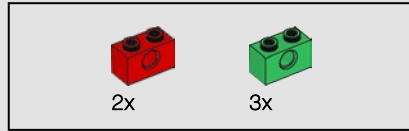
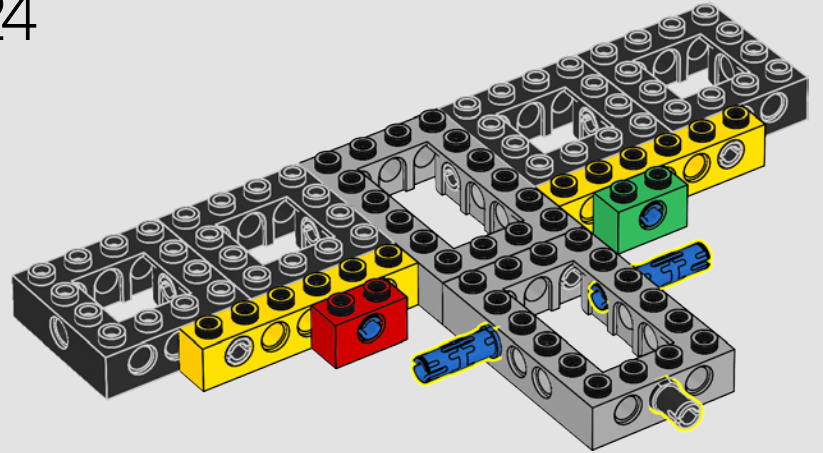

25

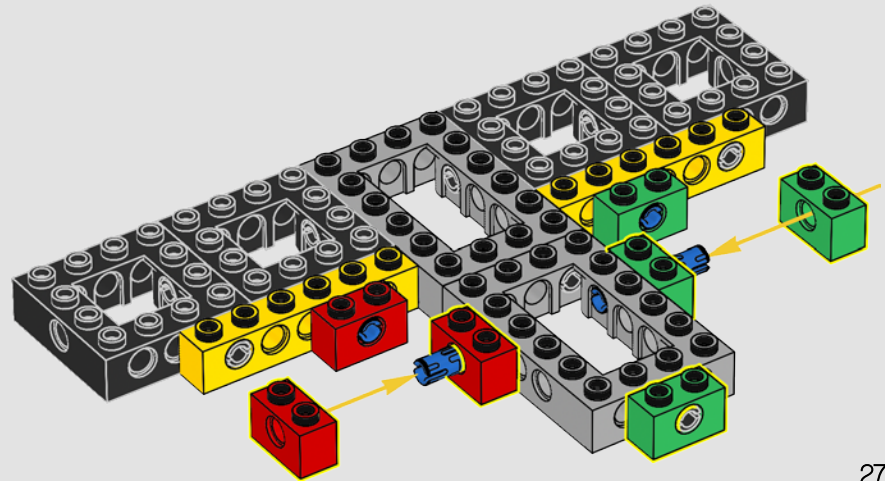

26

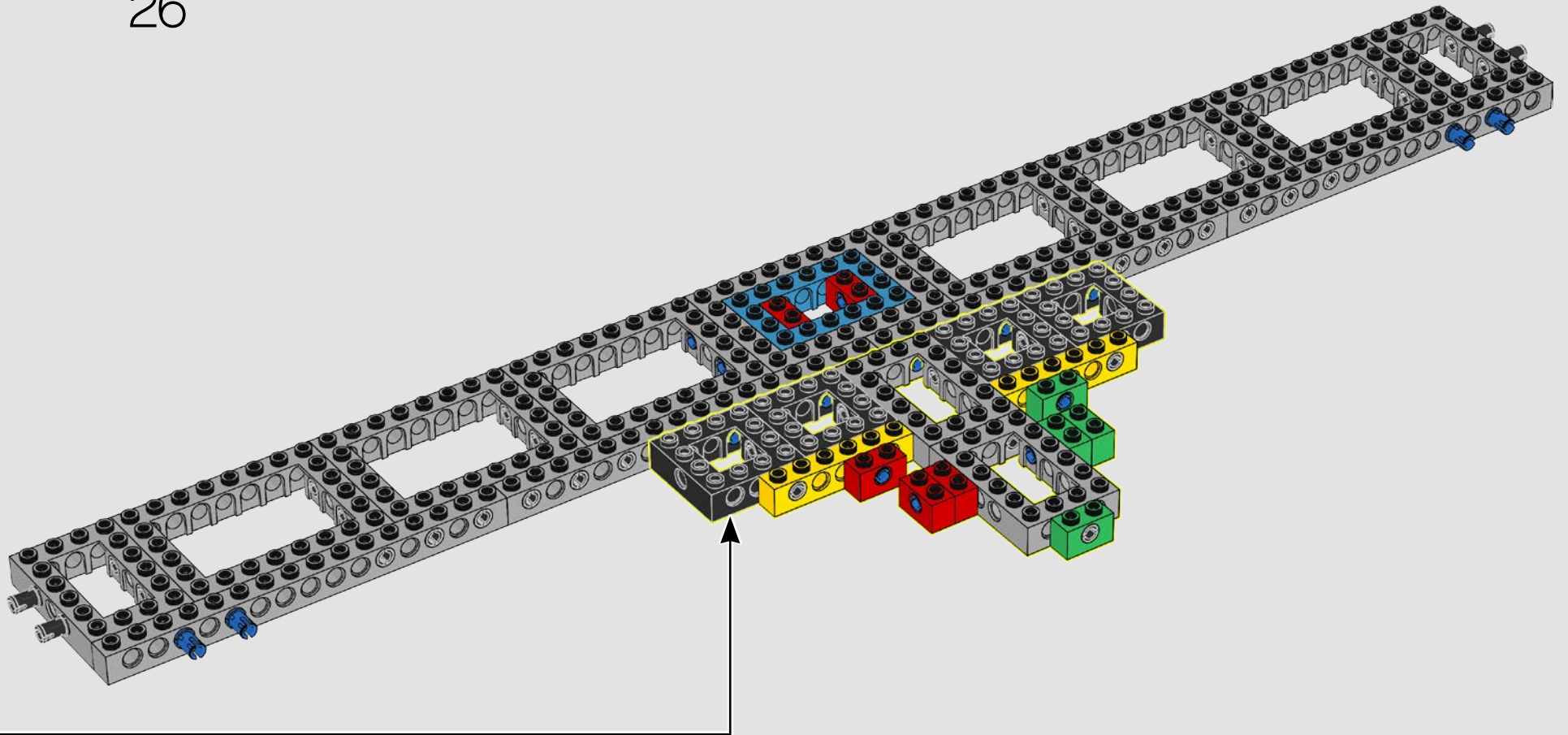

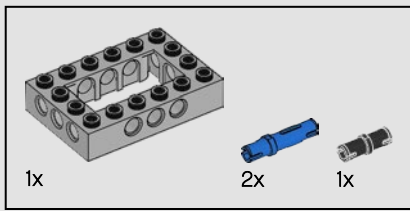

27

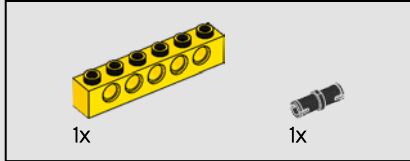
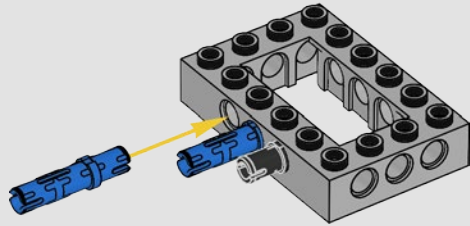

28

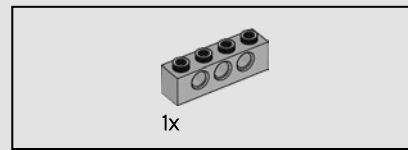
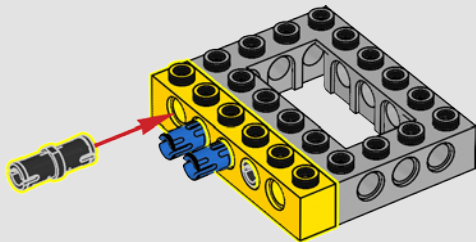

29

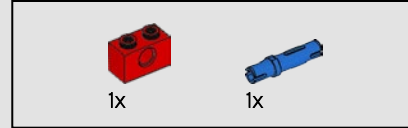
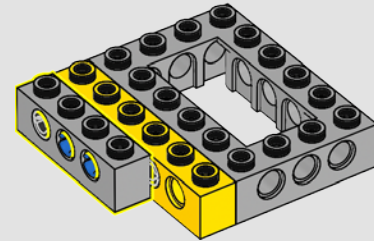

30

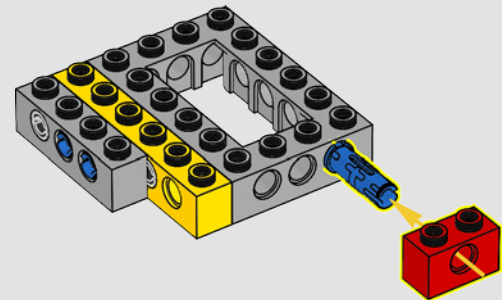

31

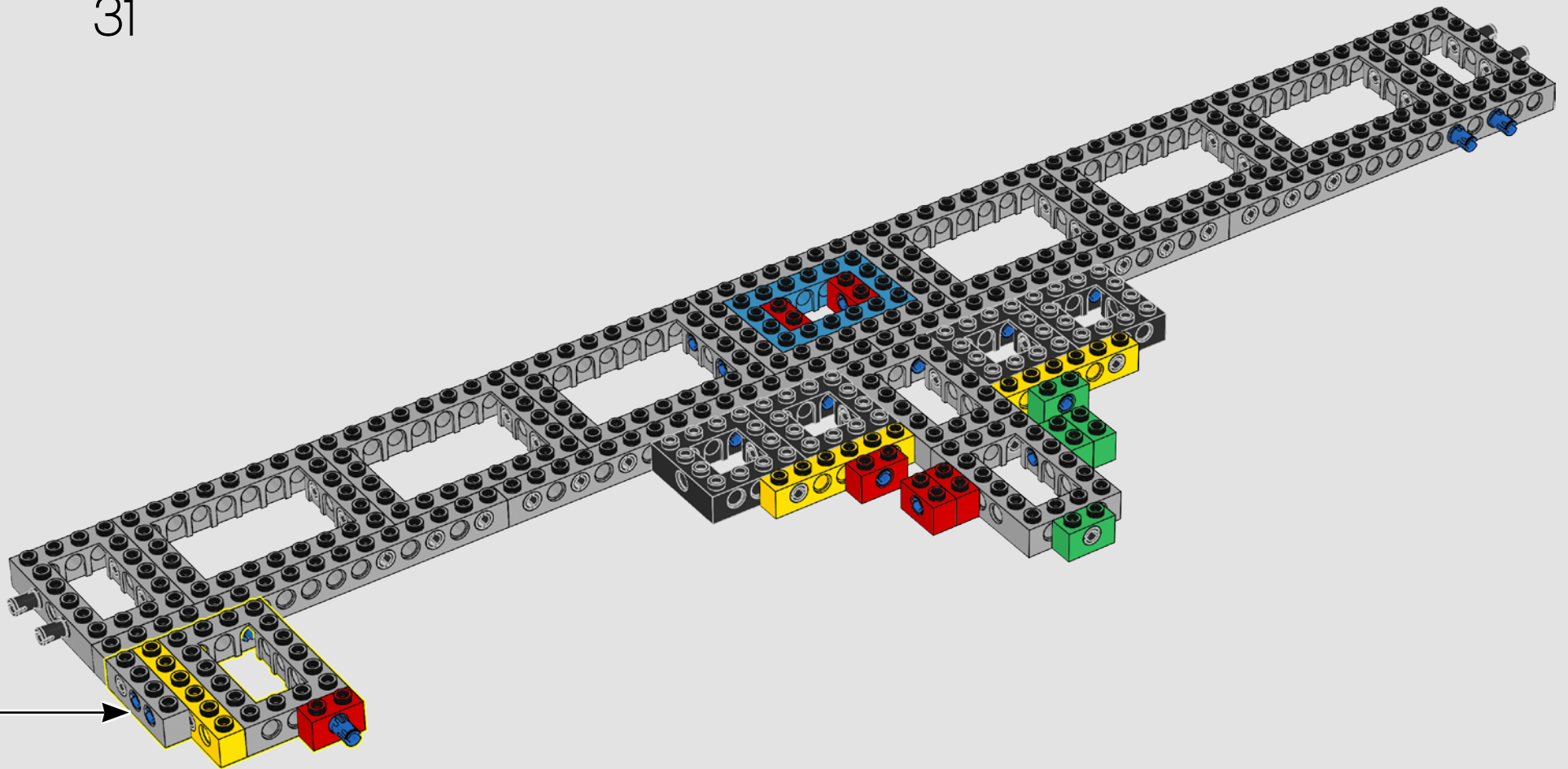

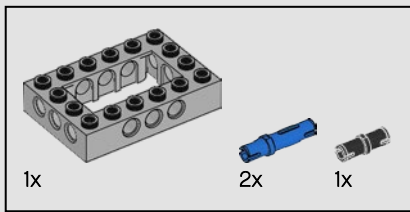

32

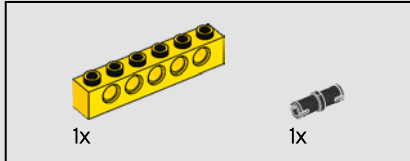
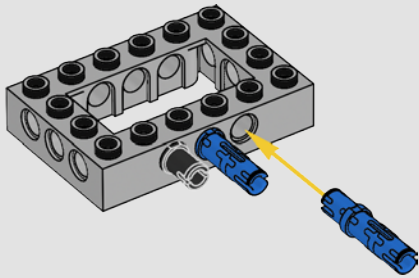

33

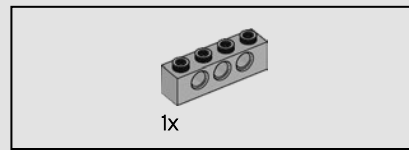
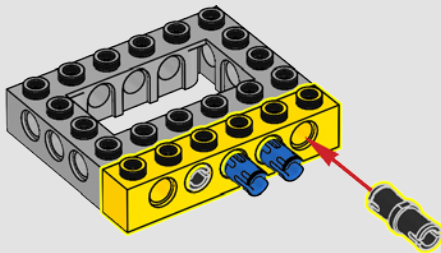

34

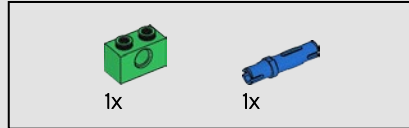
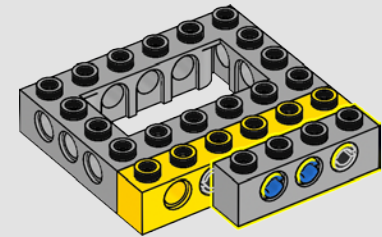

35

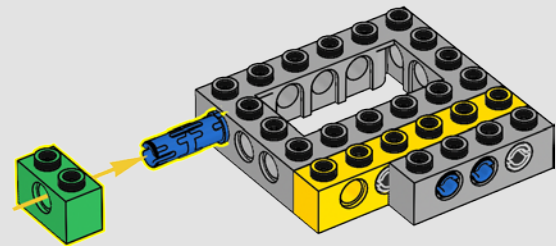

36

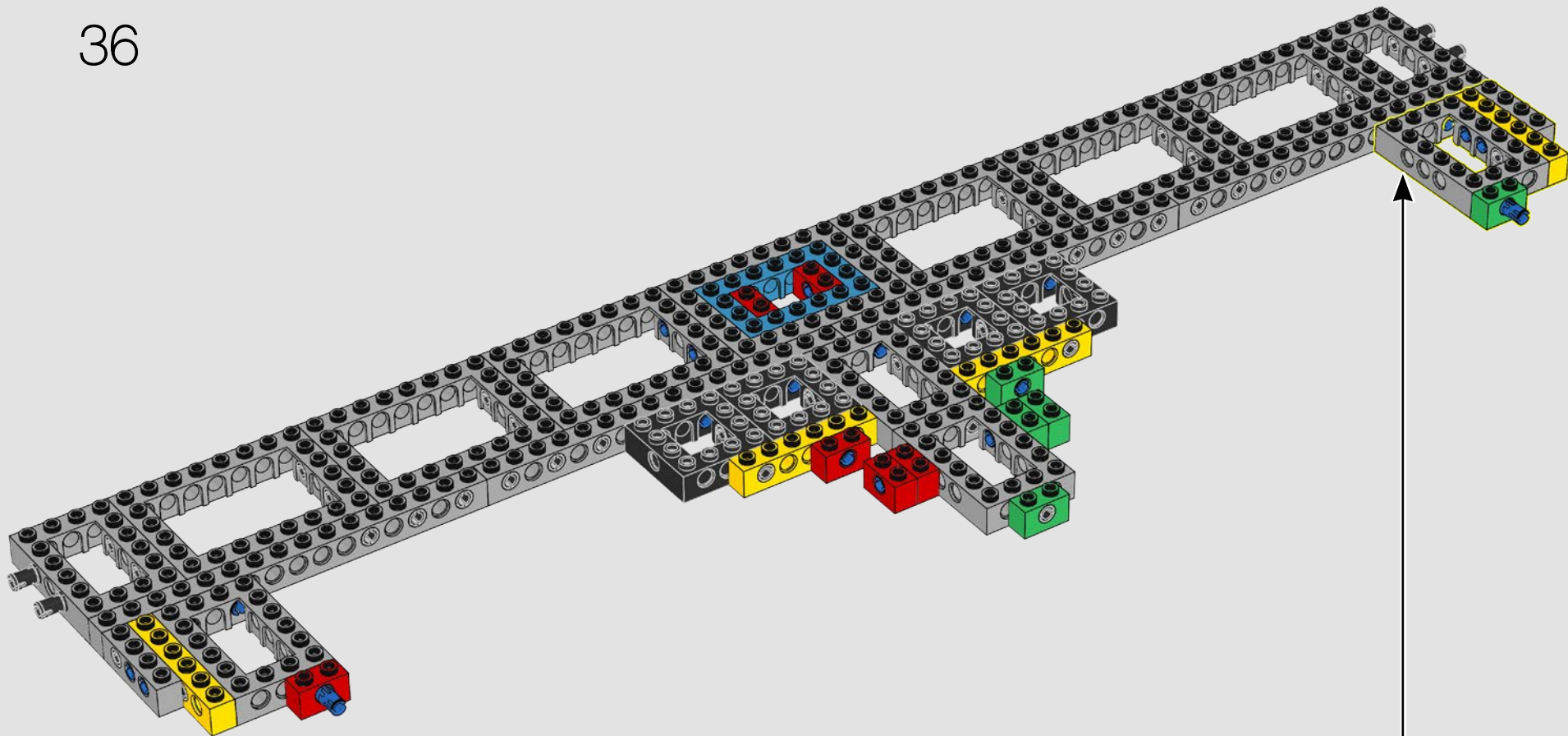



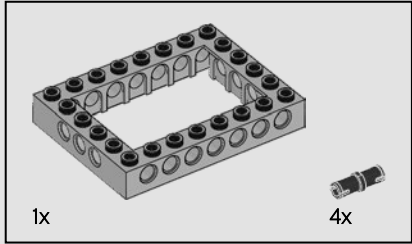
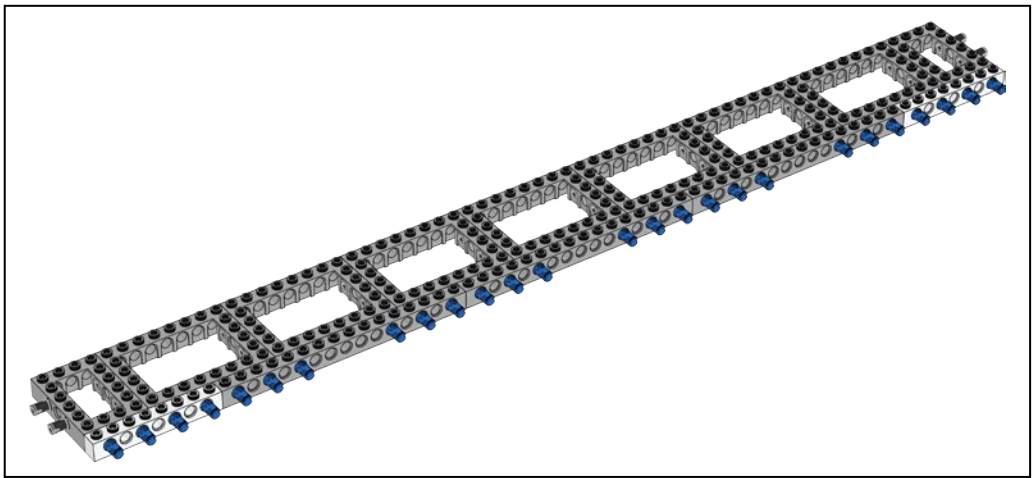

37

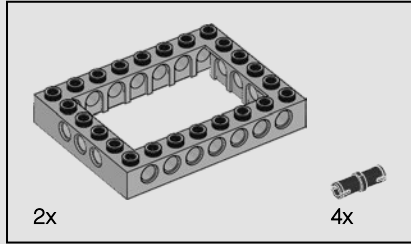
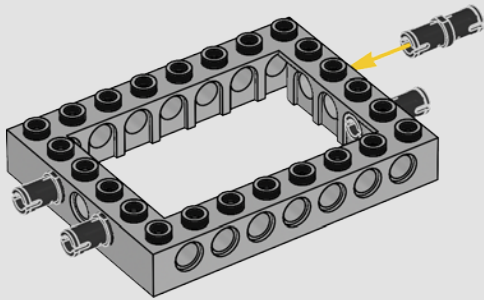

38

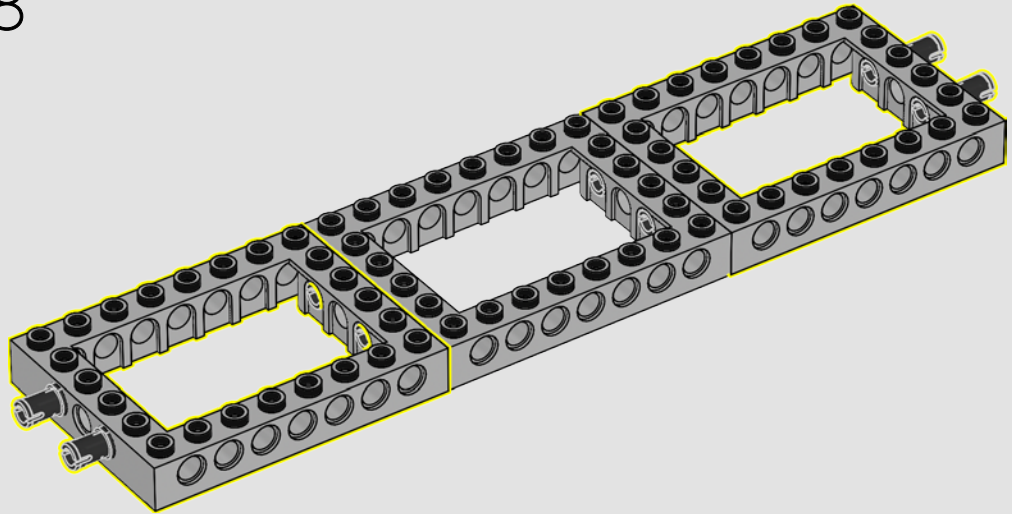

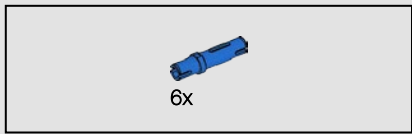

39

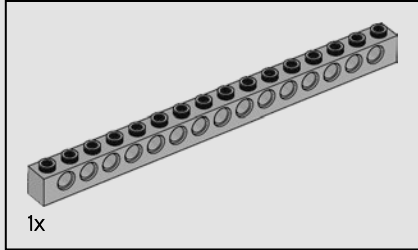
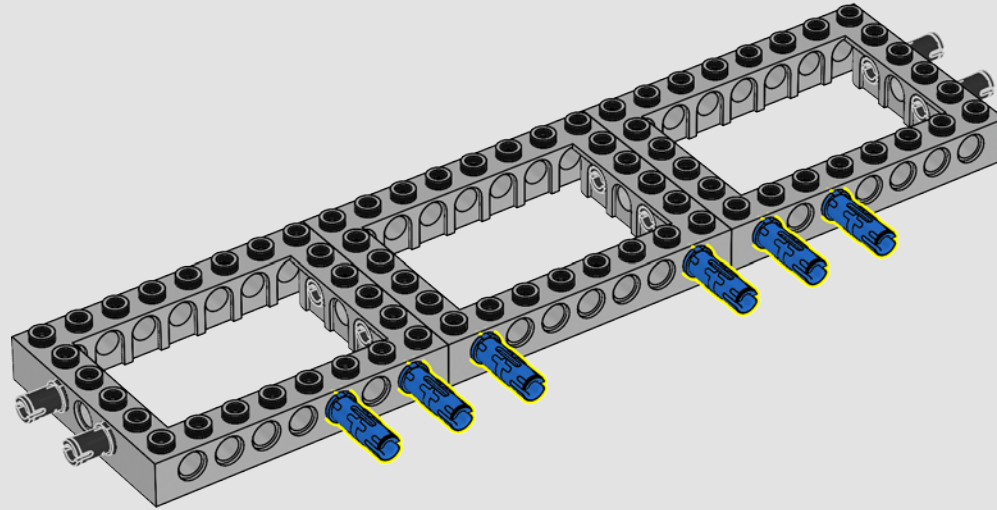

40

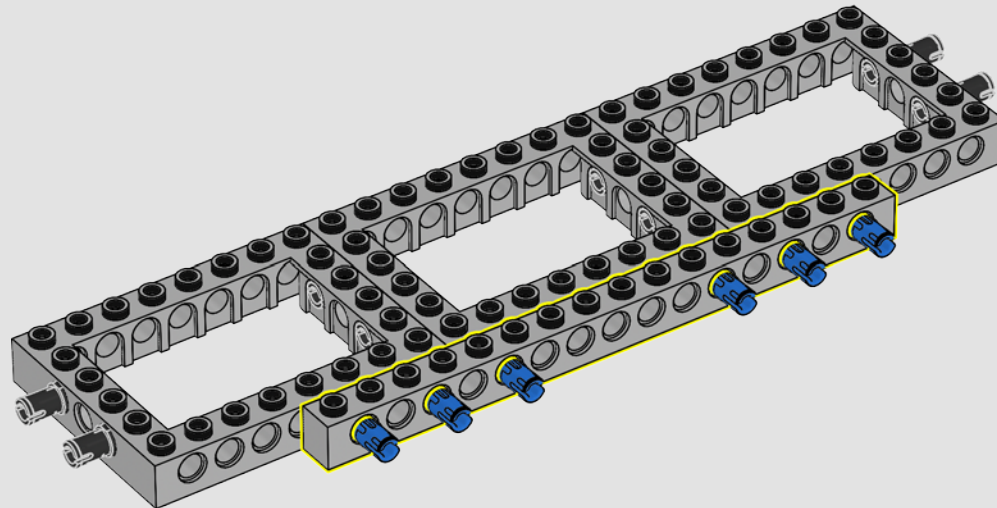

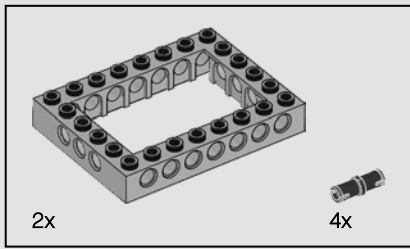

41

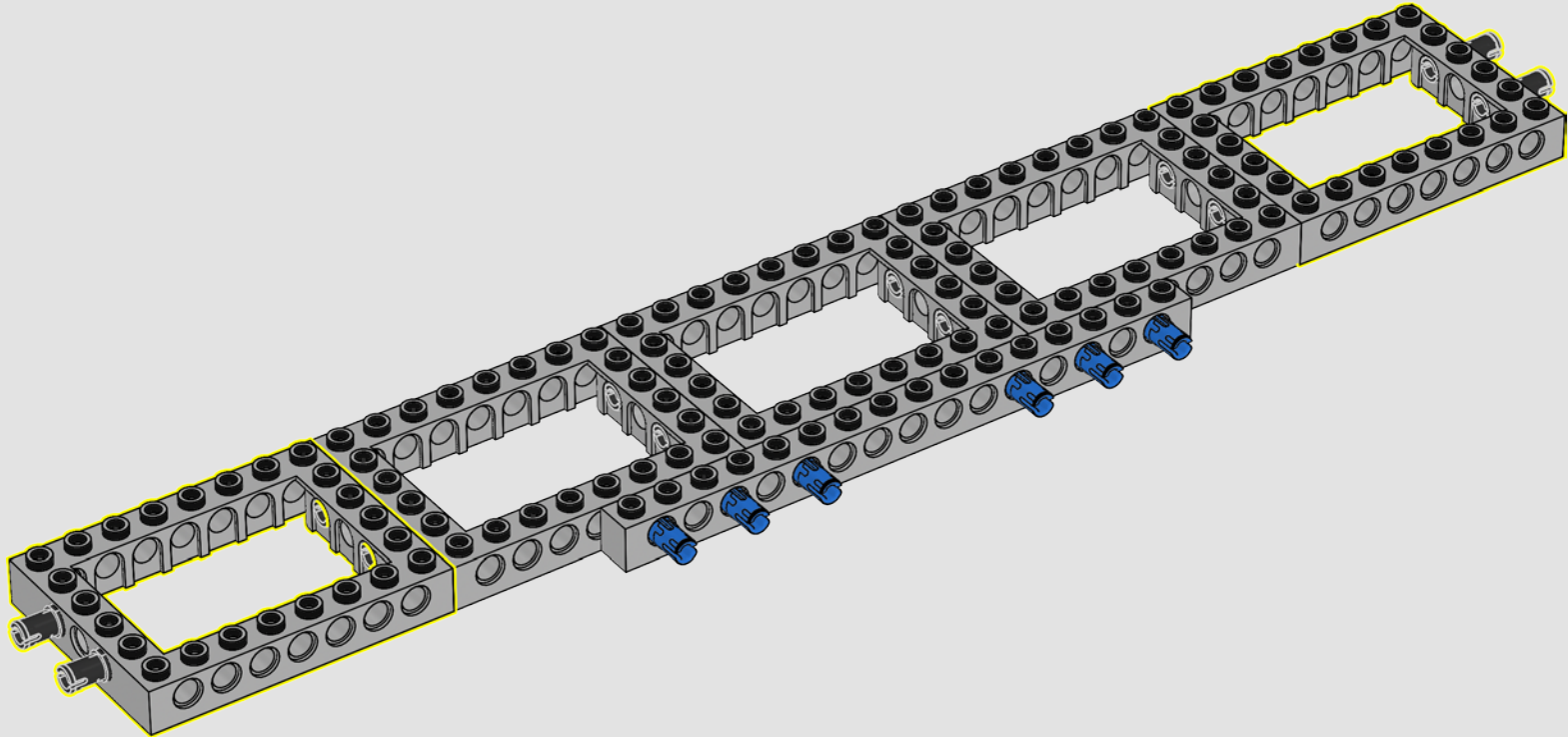

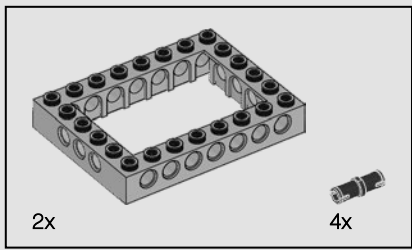

42

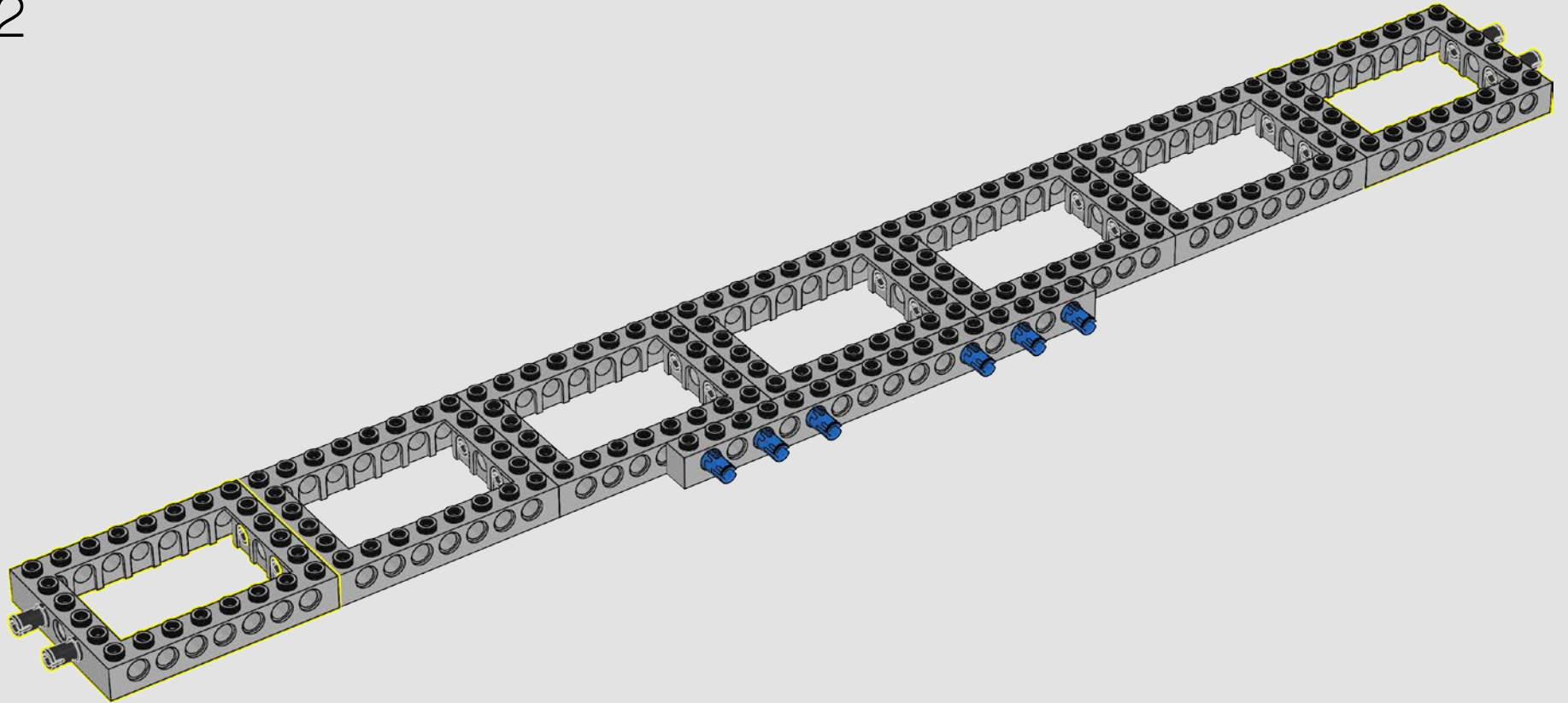

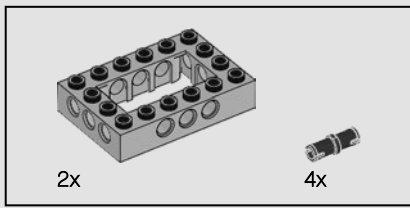

43

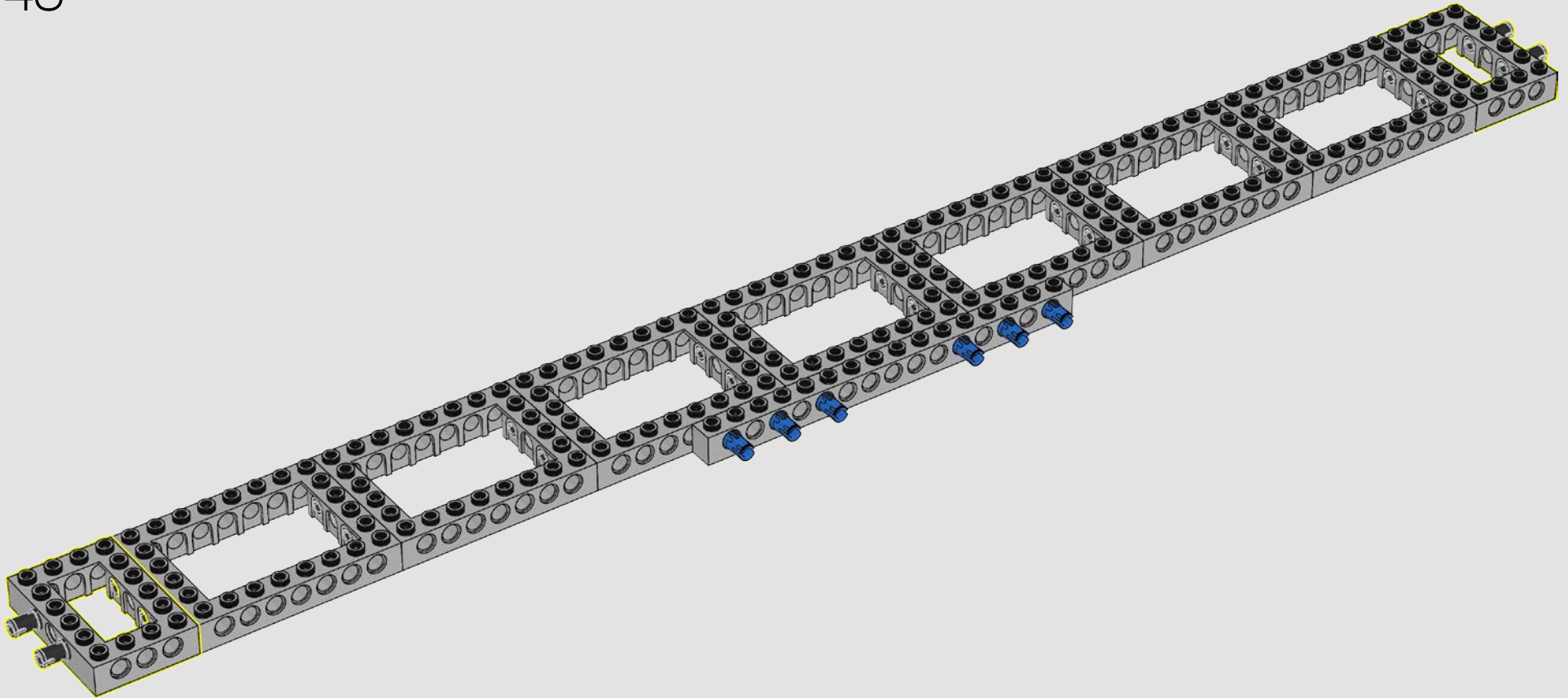



44

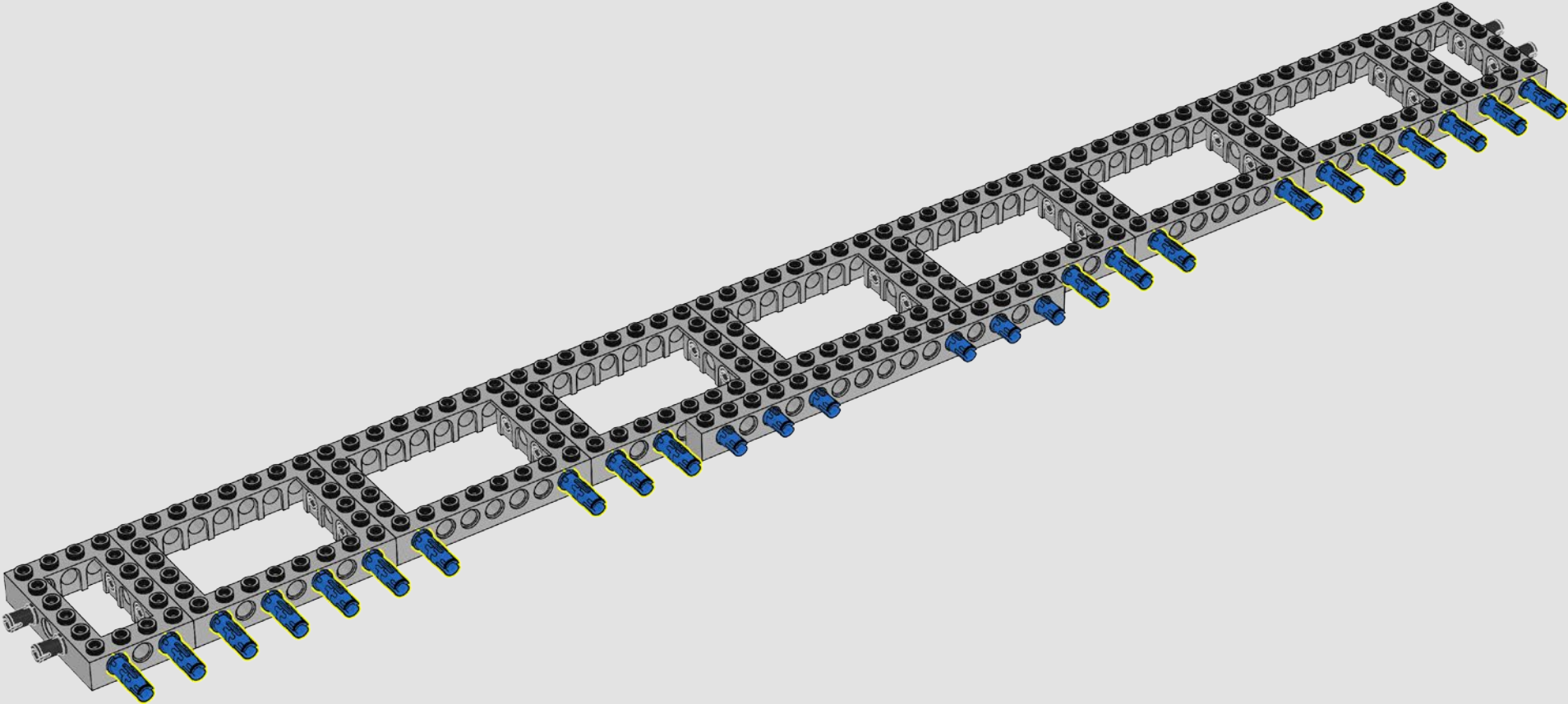

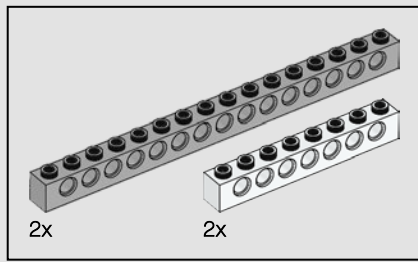

45

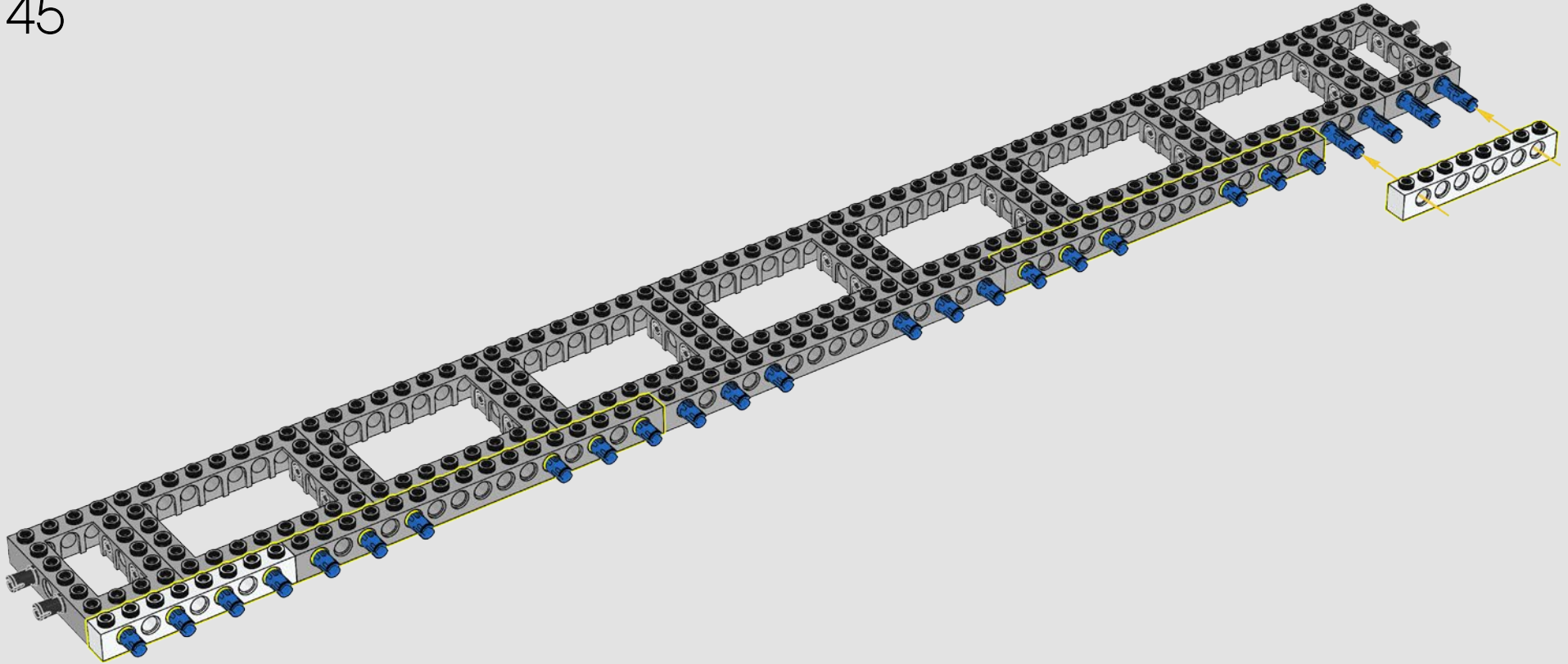

46

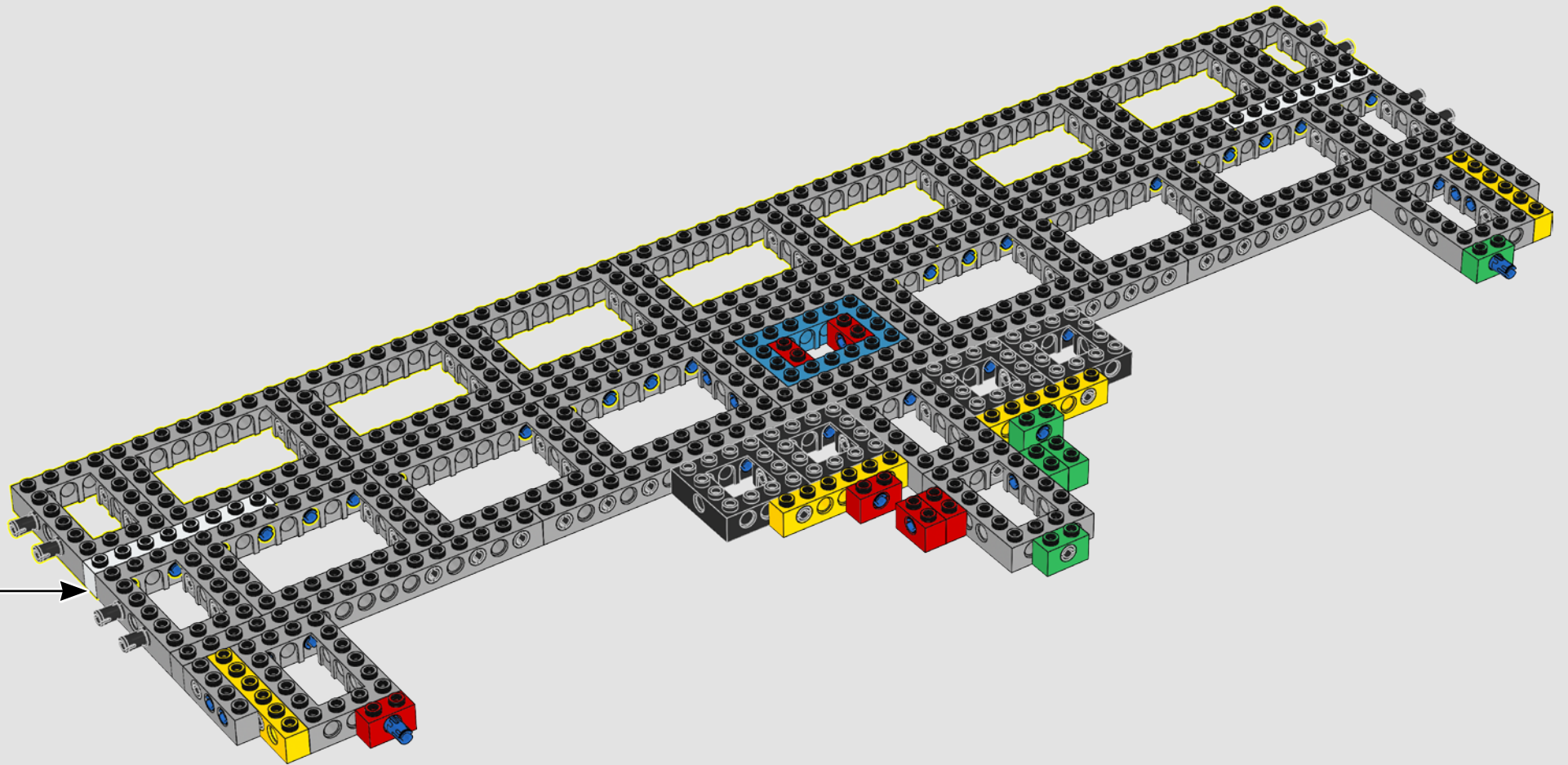



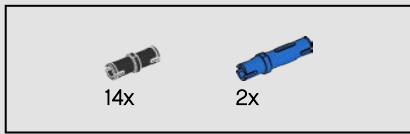

47

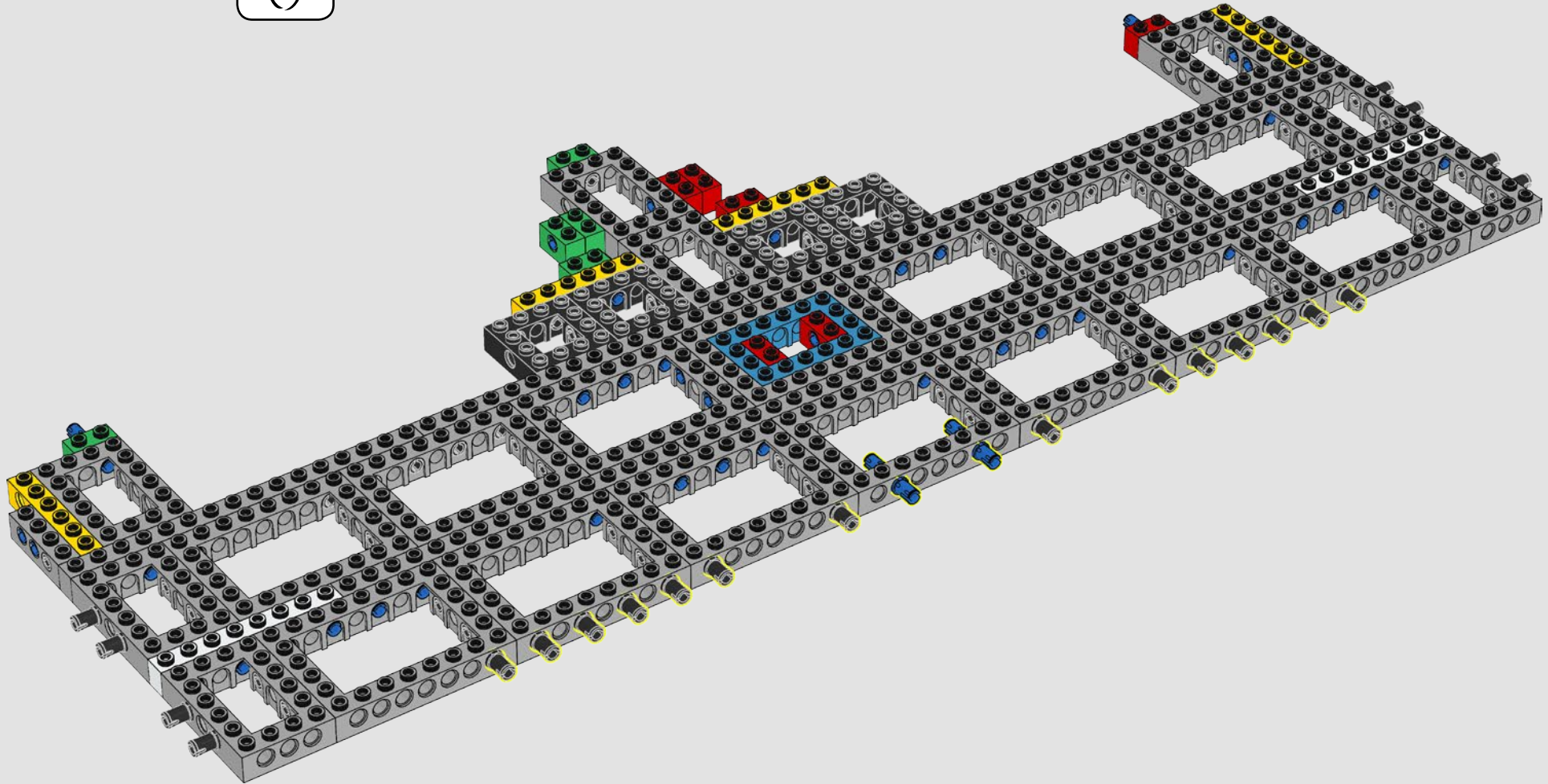

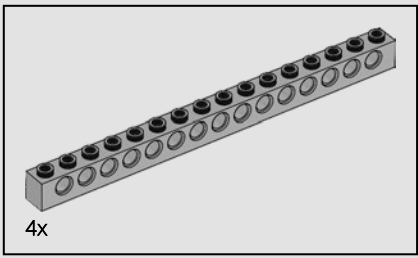

48

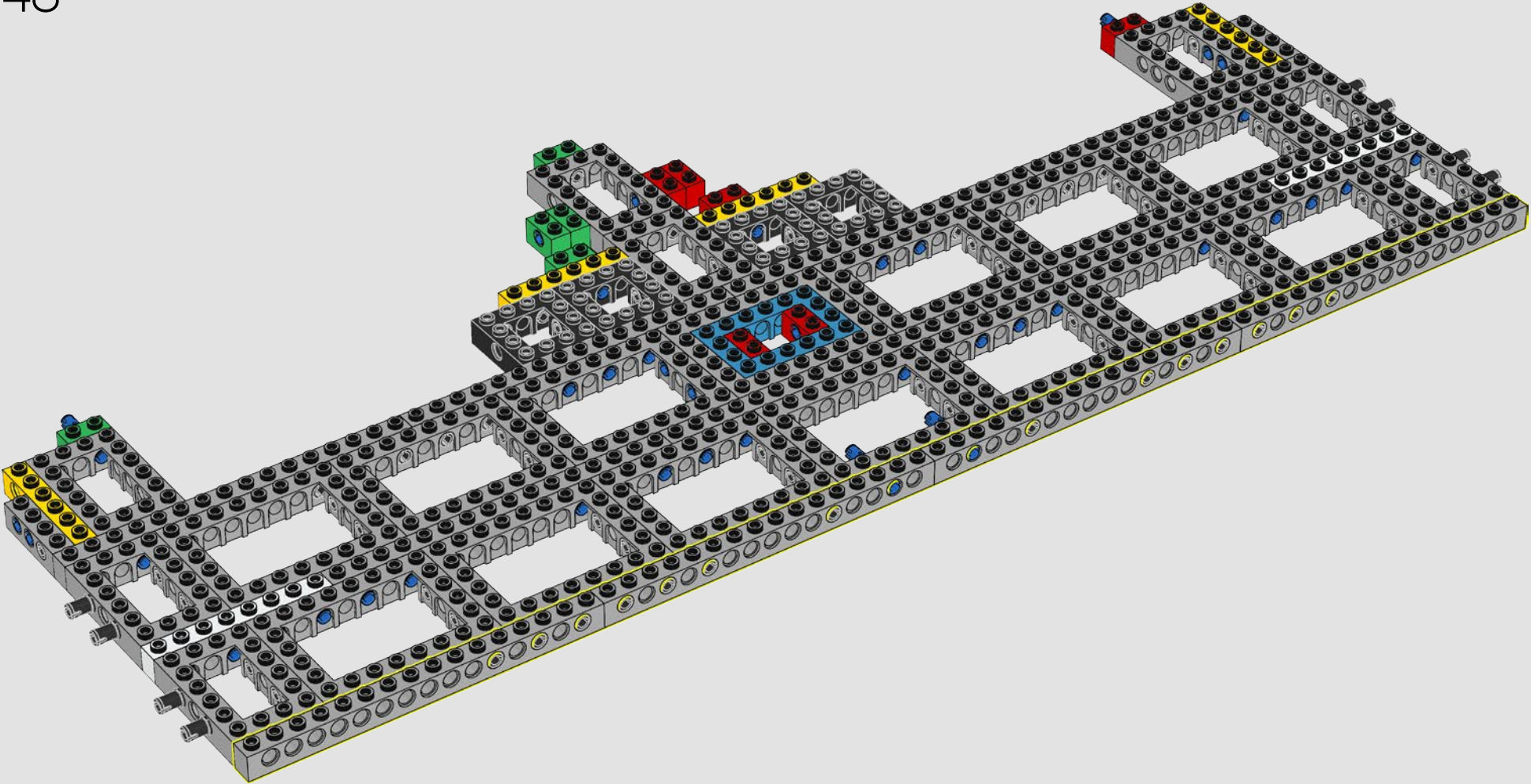

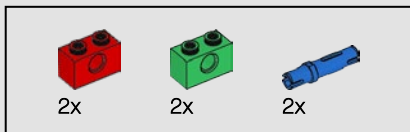

49

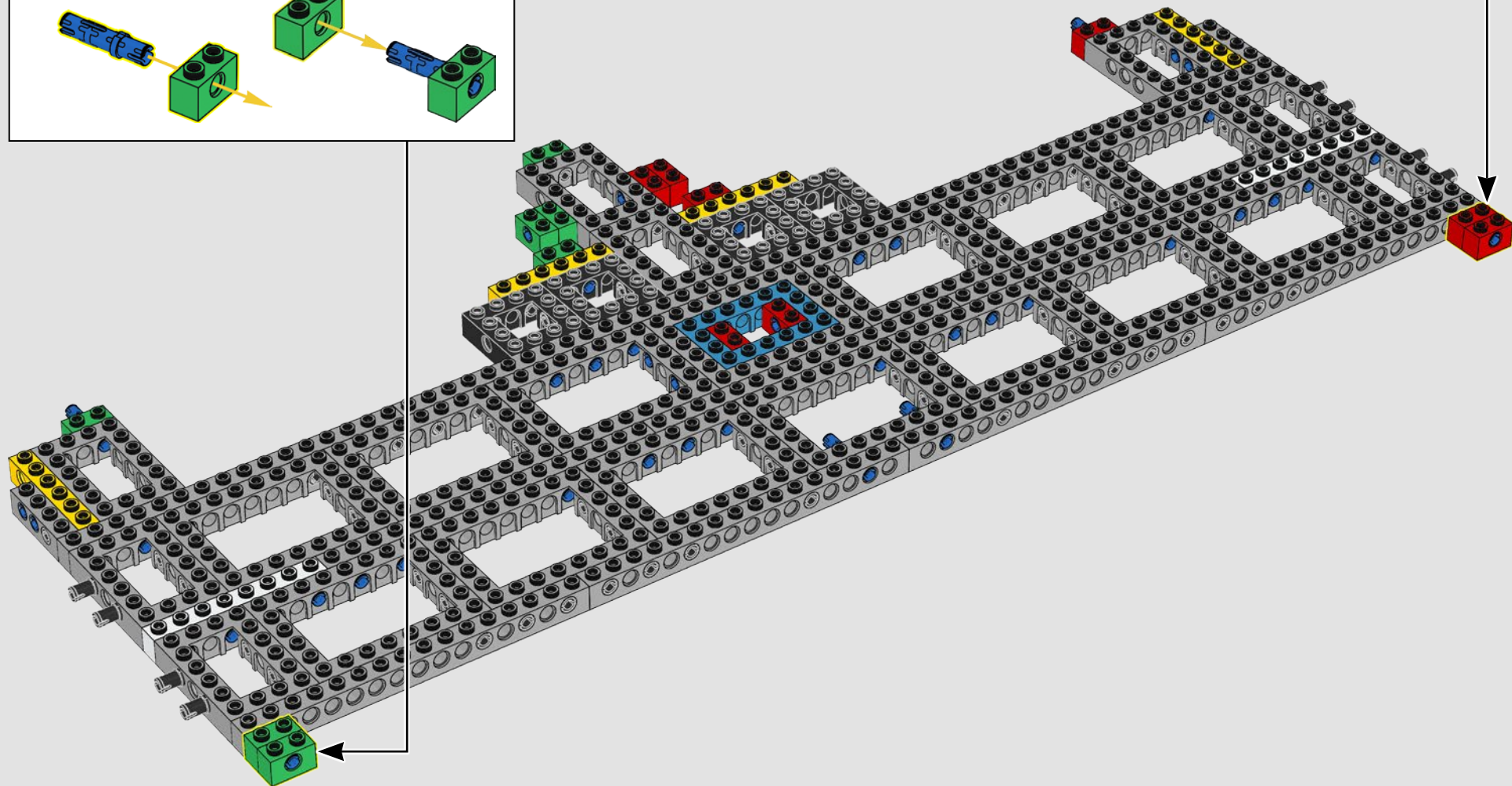
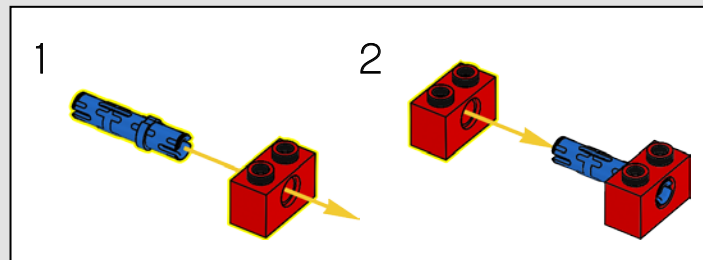
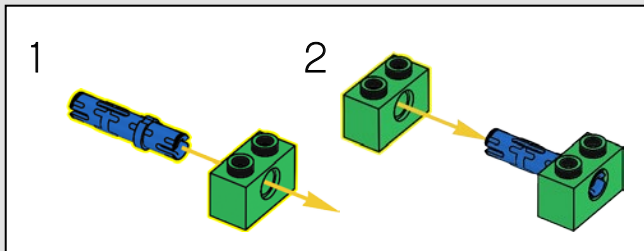

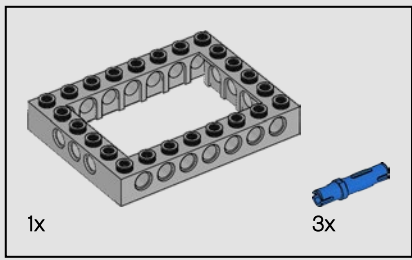

50

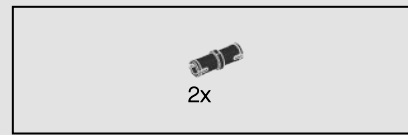
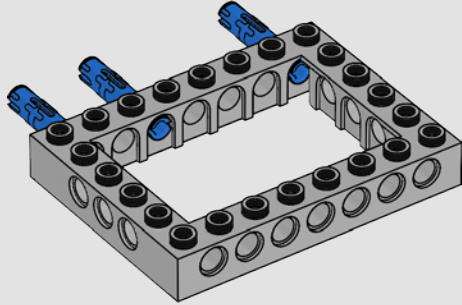

51

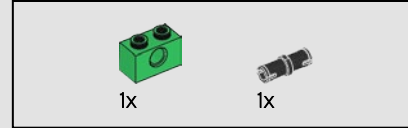
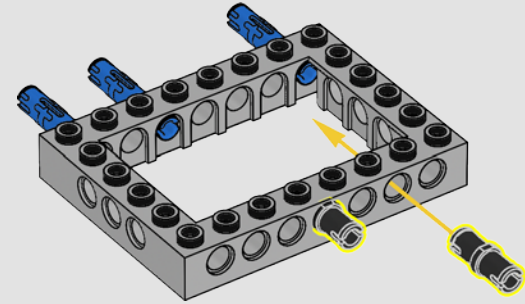

52

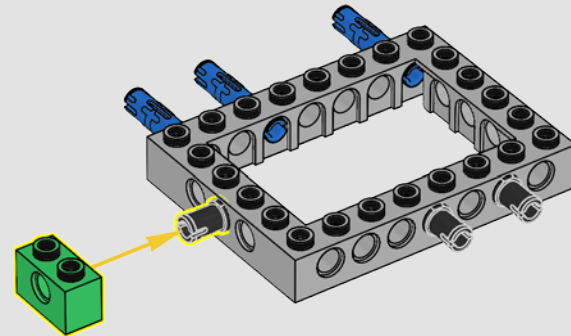

53

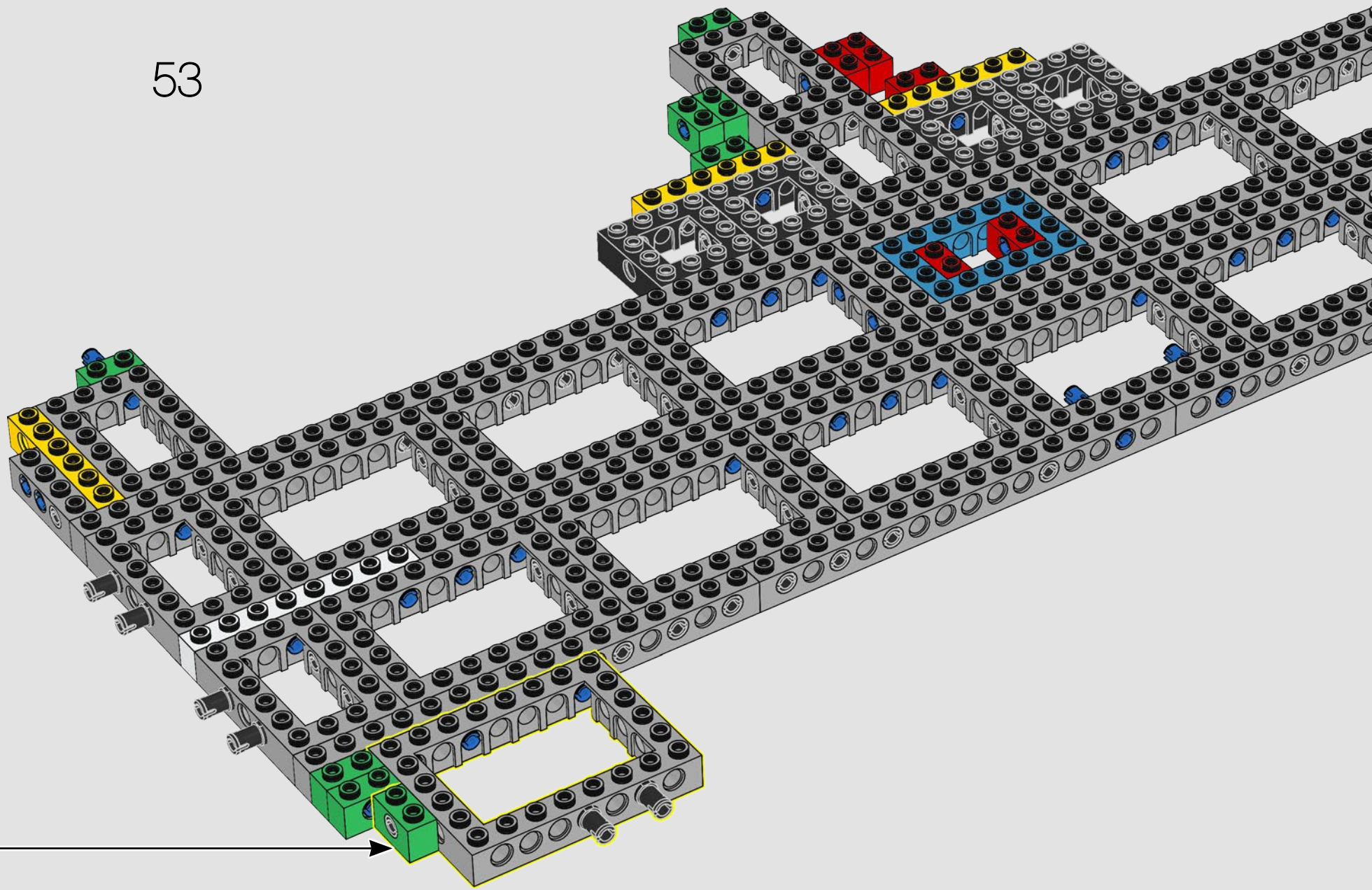

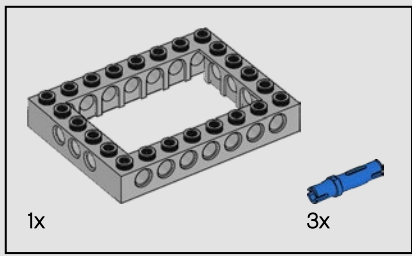

54

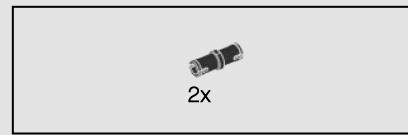
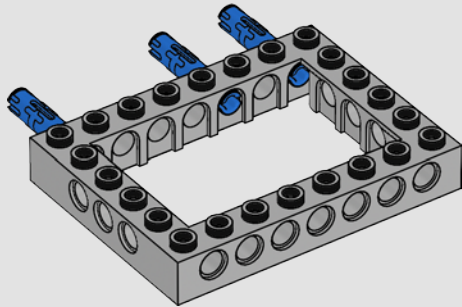

55

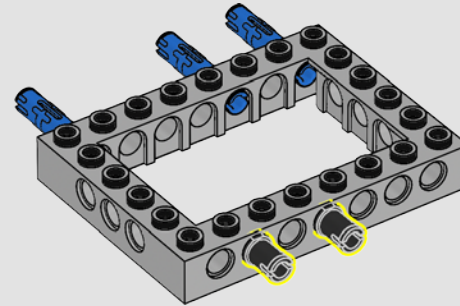

56

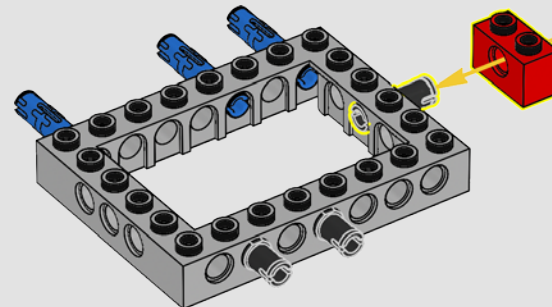

57

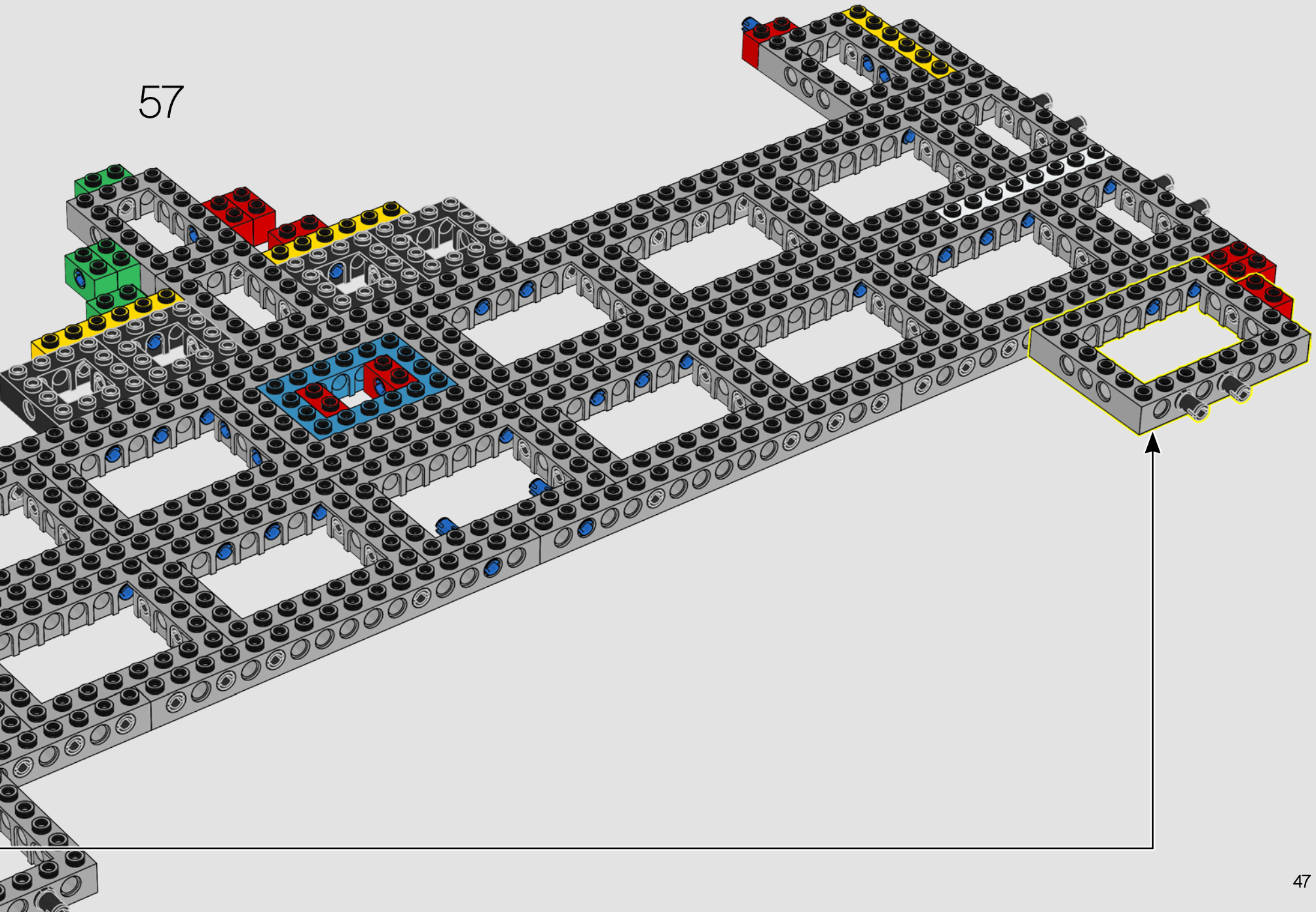

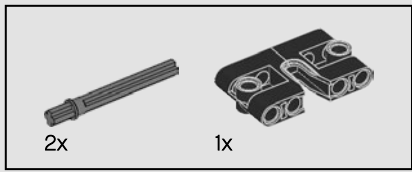

58

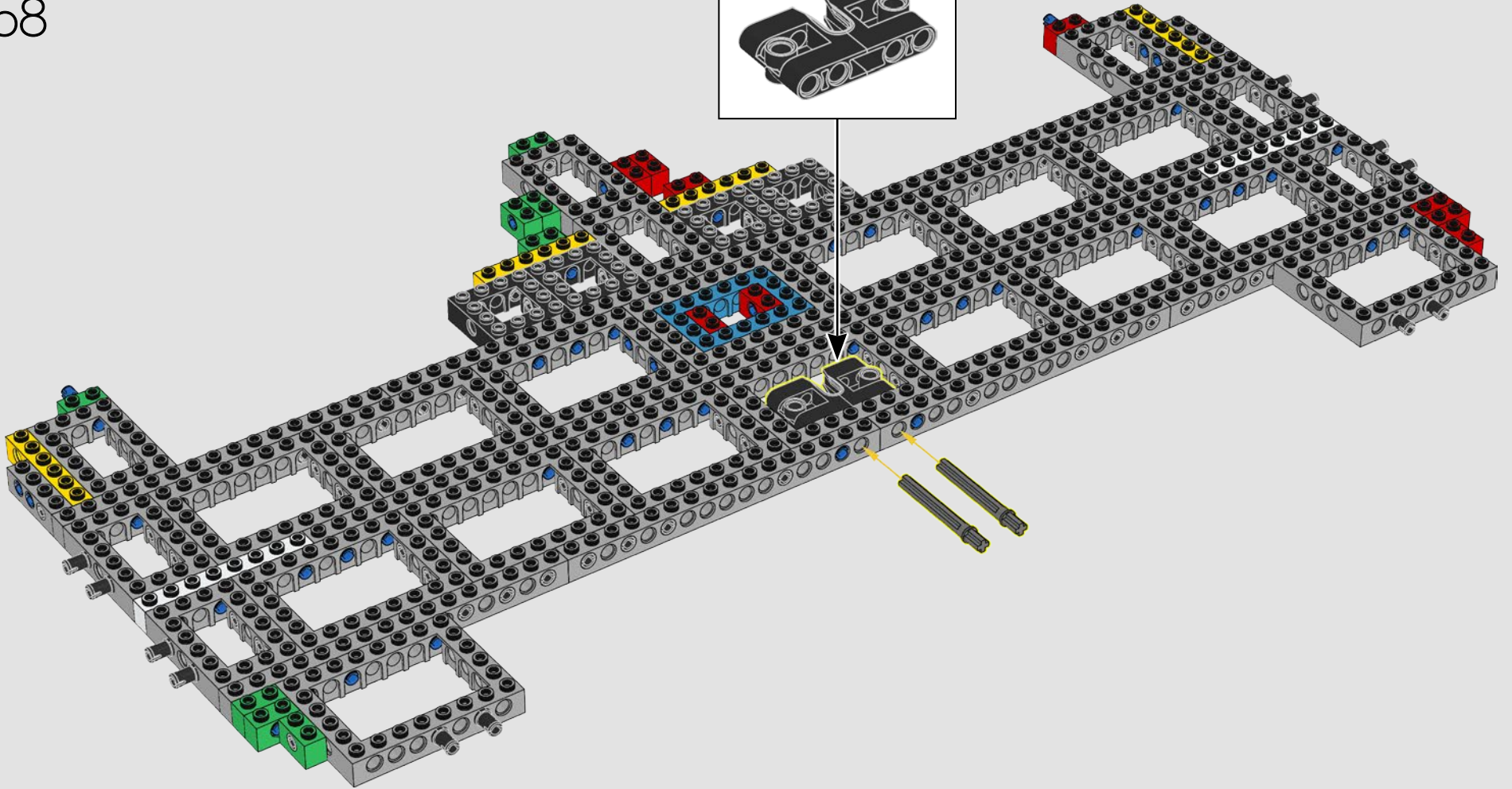
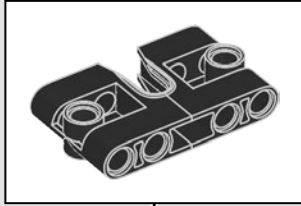



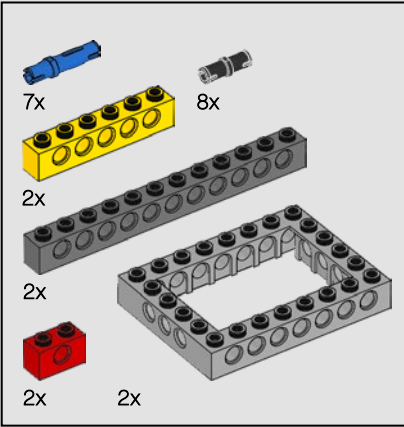
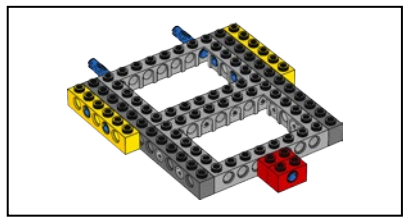

59

1

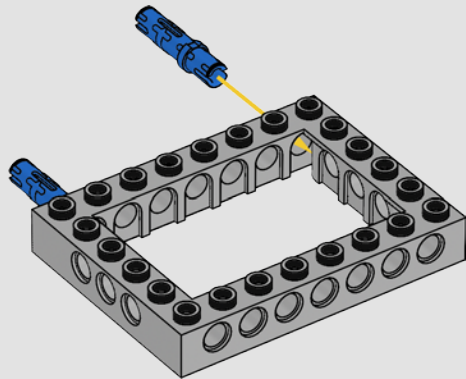

2

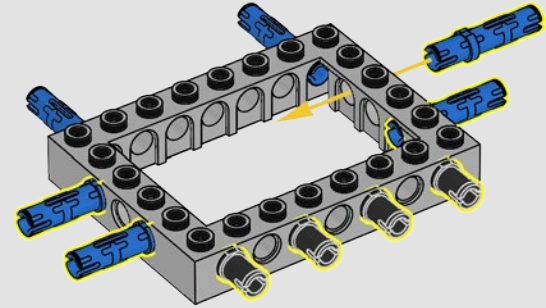

3

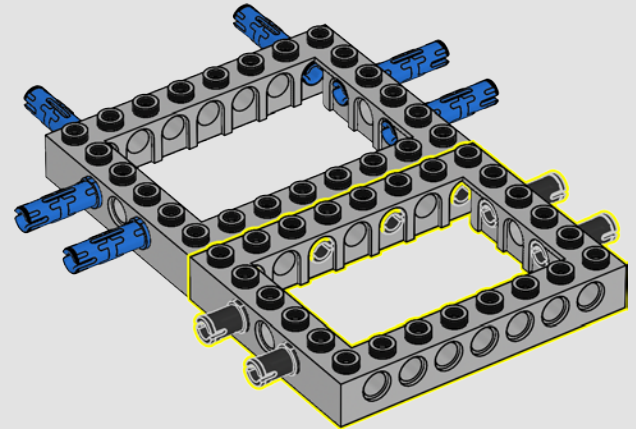

4

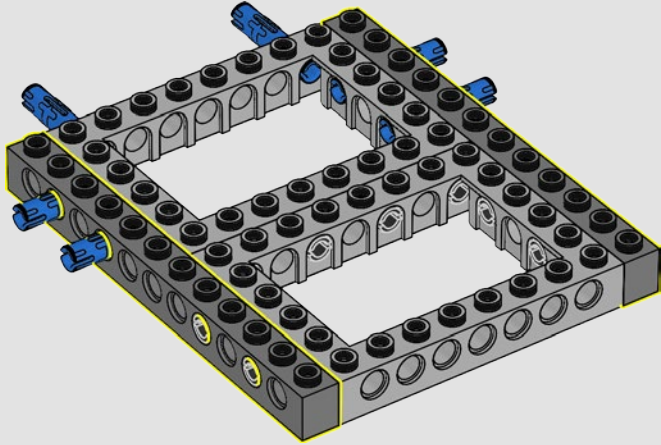

5

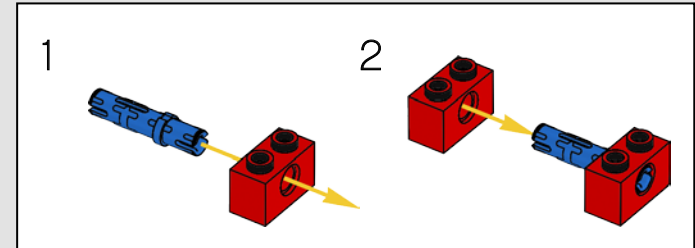
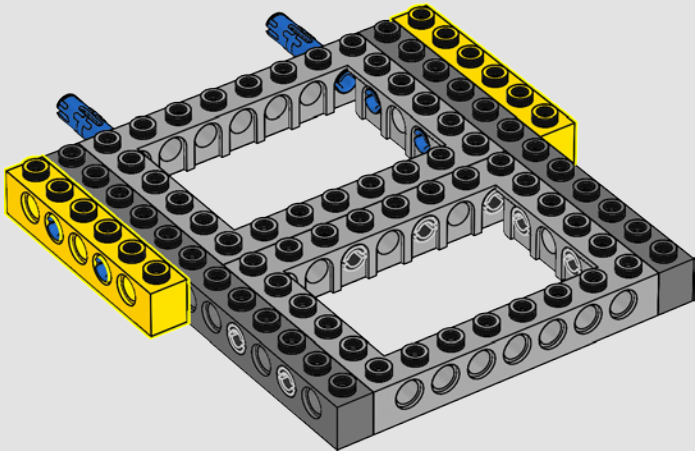

6

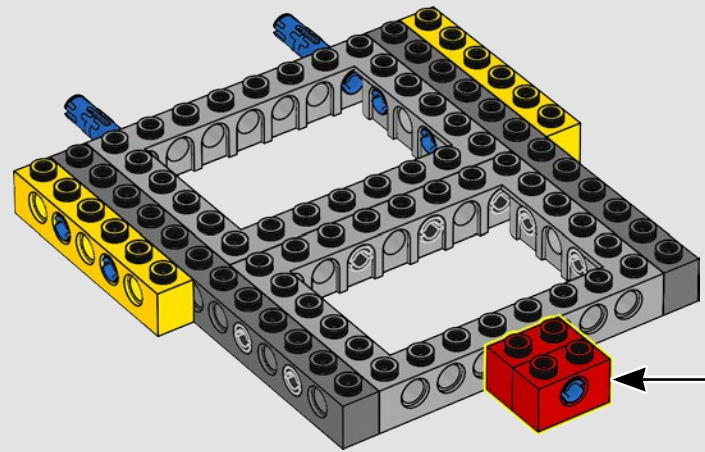

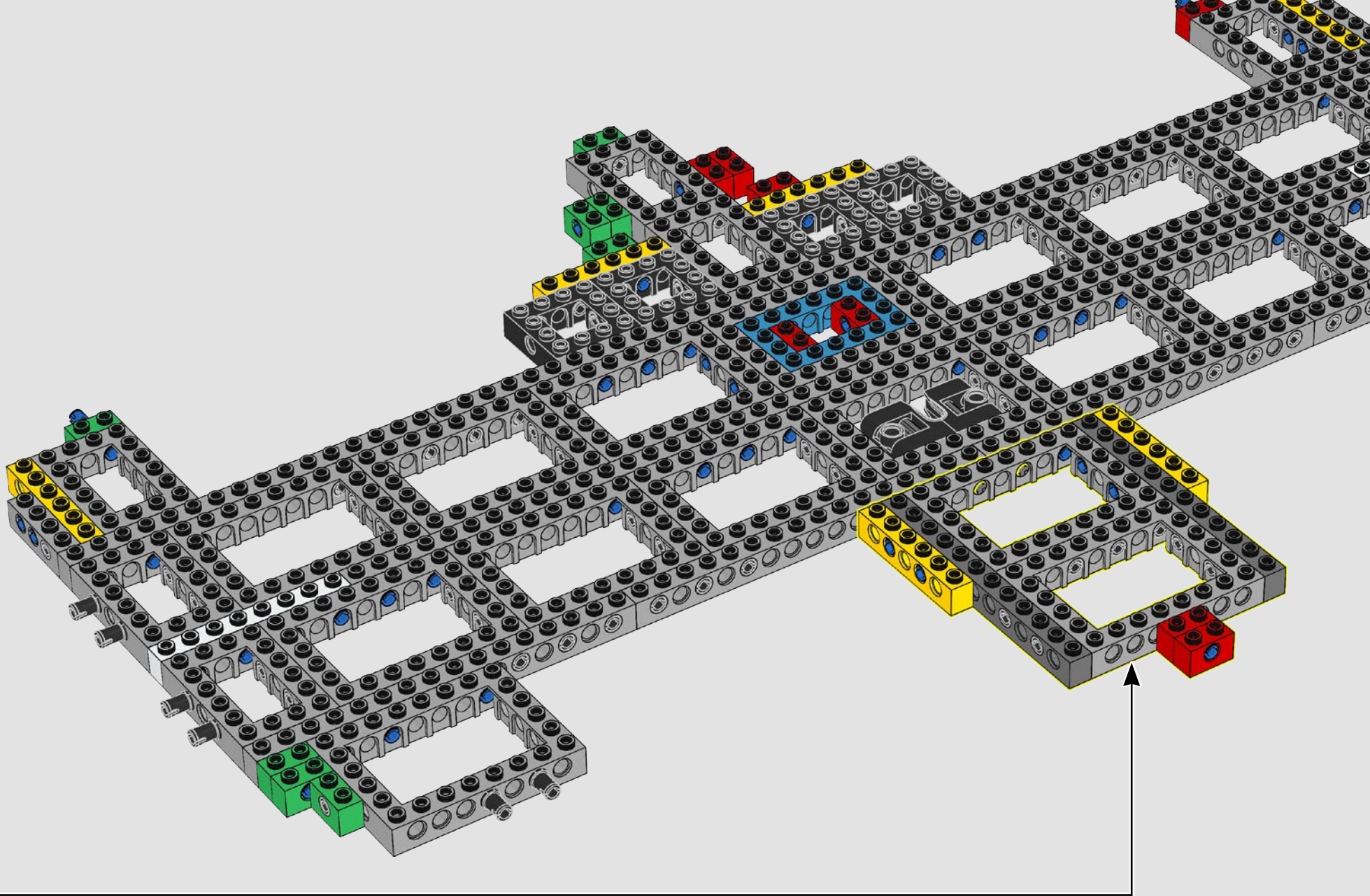

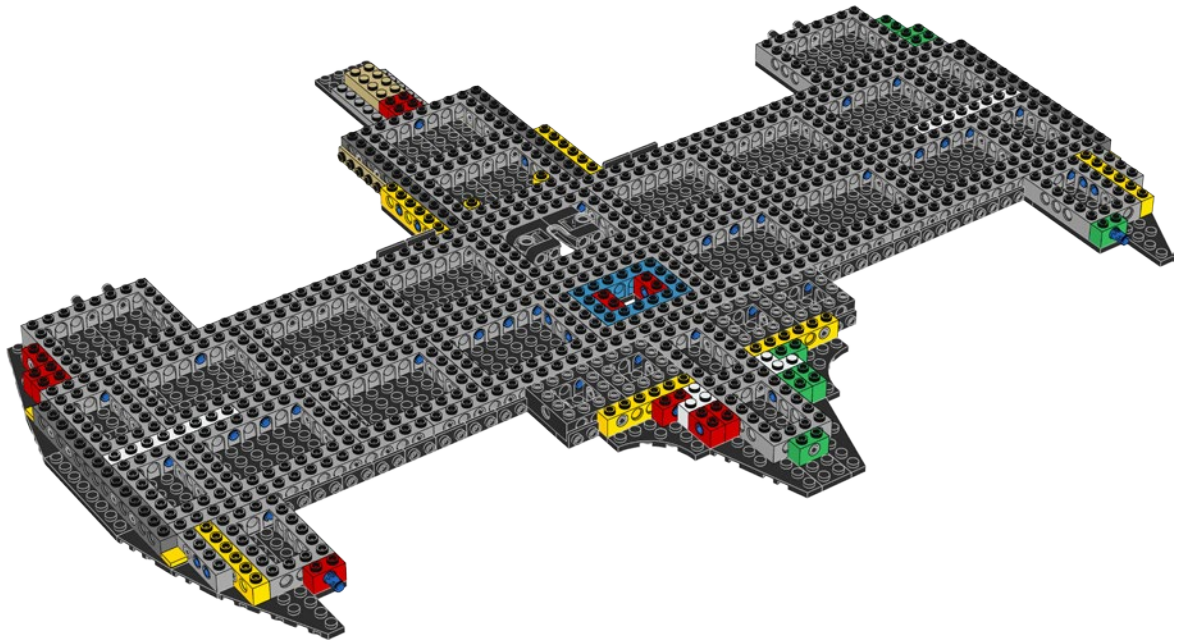
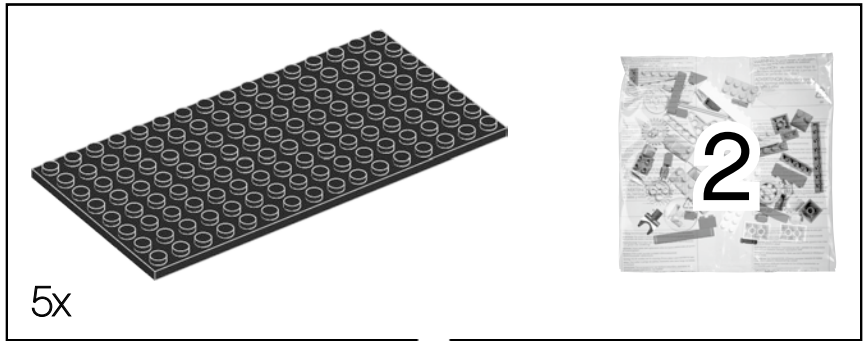

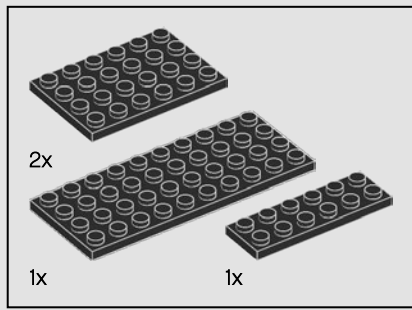

60

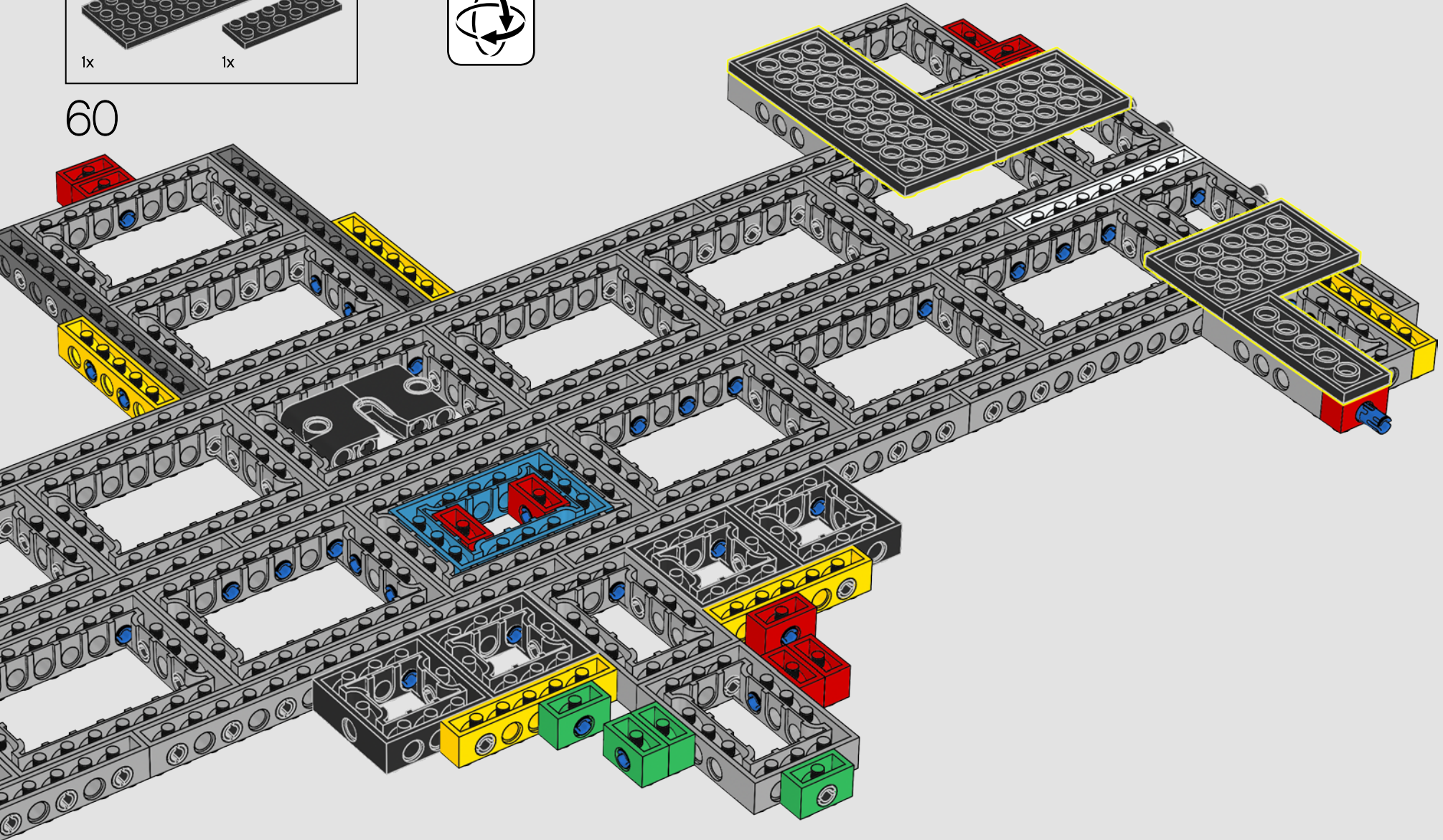

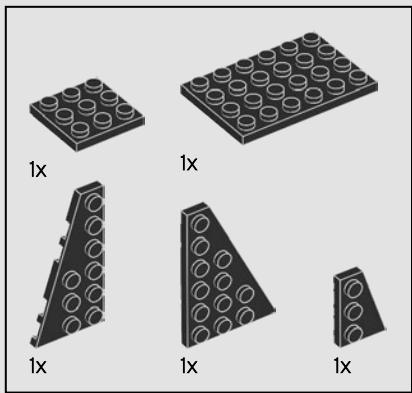

61

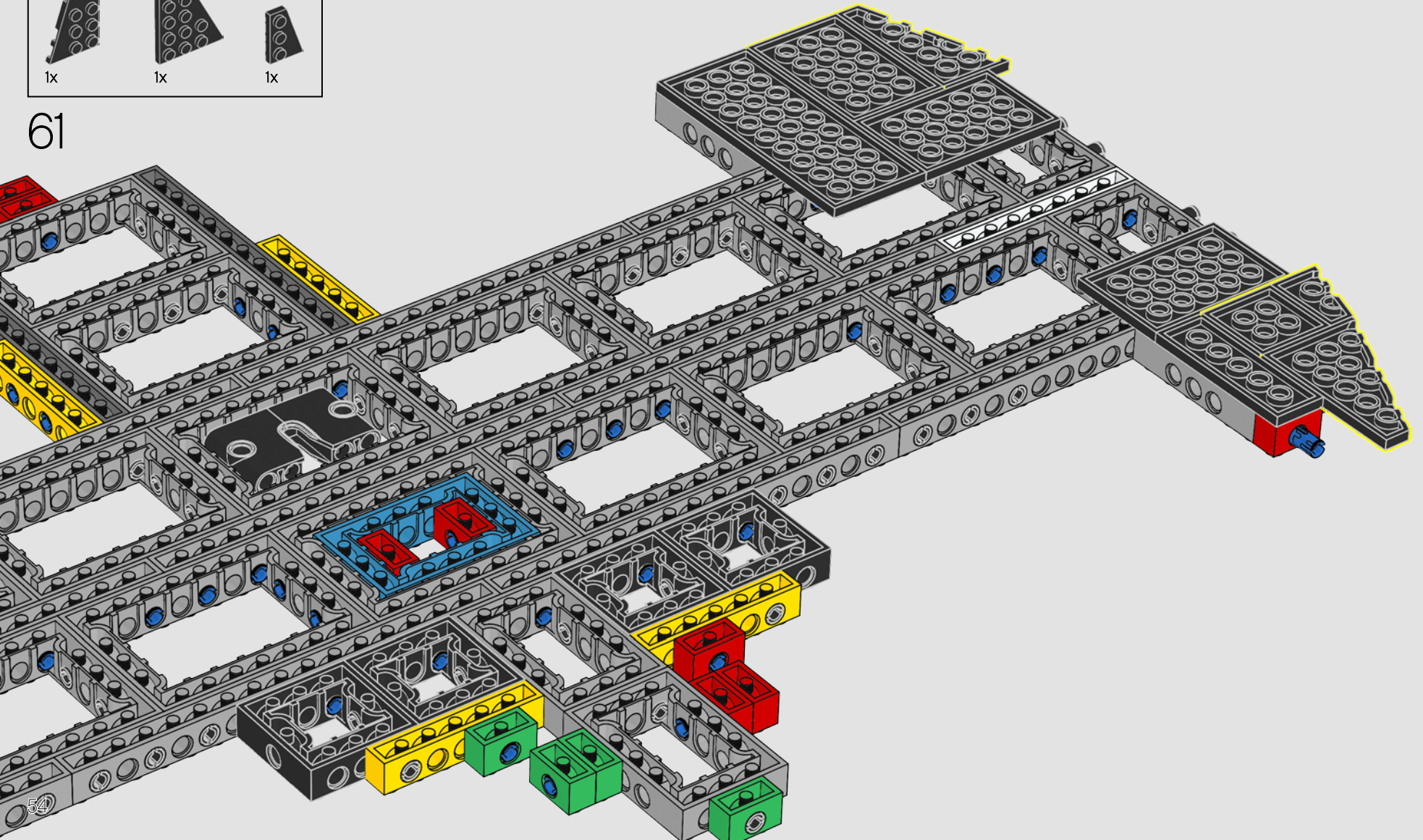

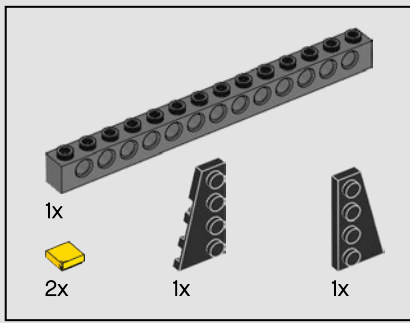

62

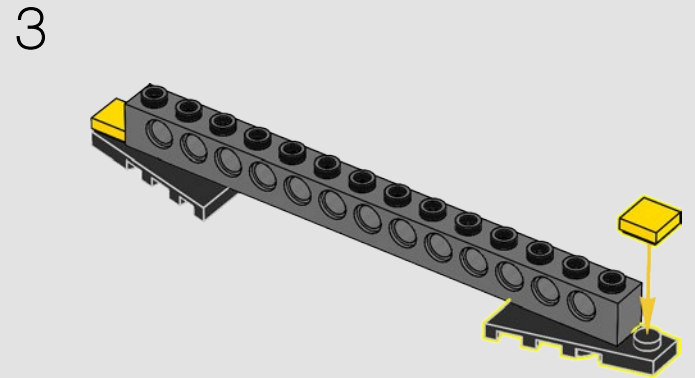
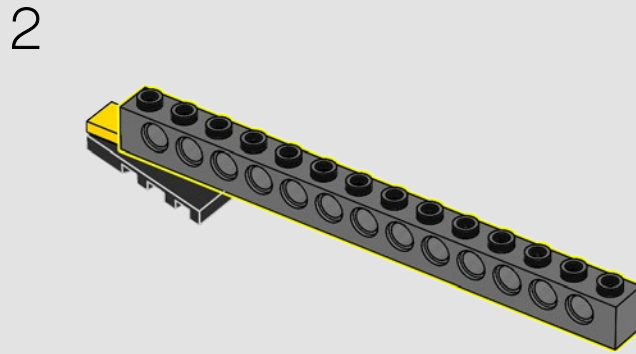
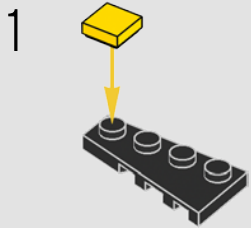

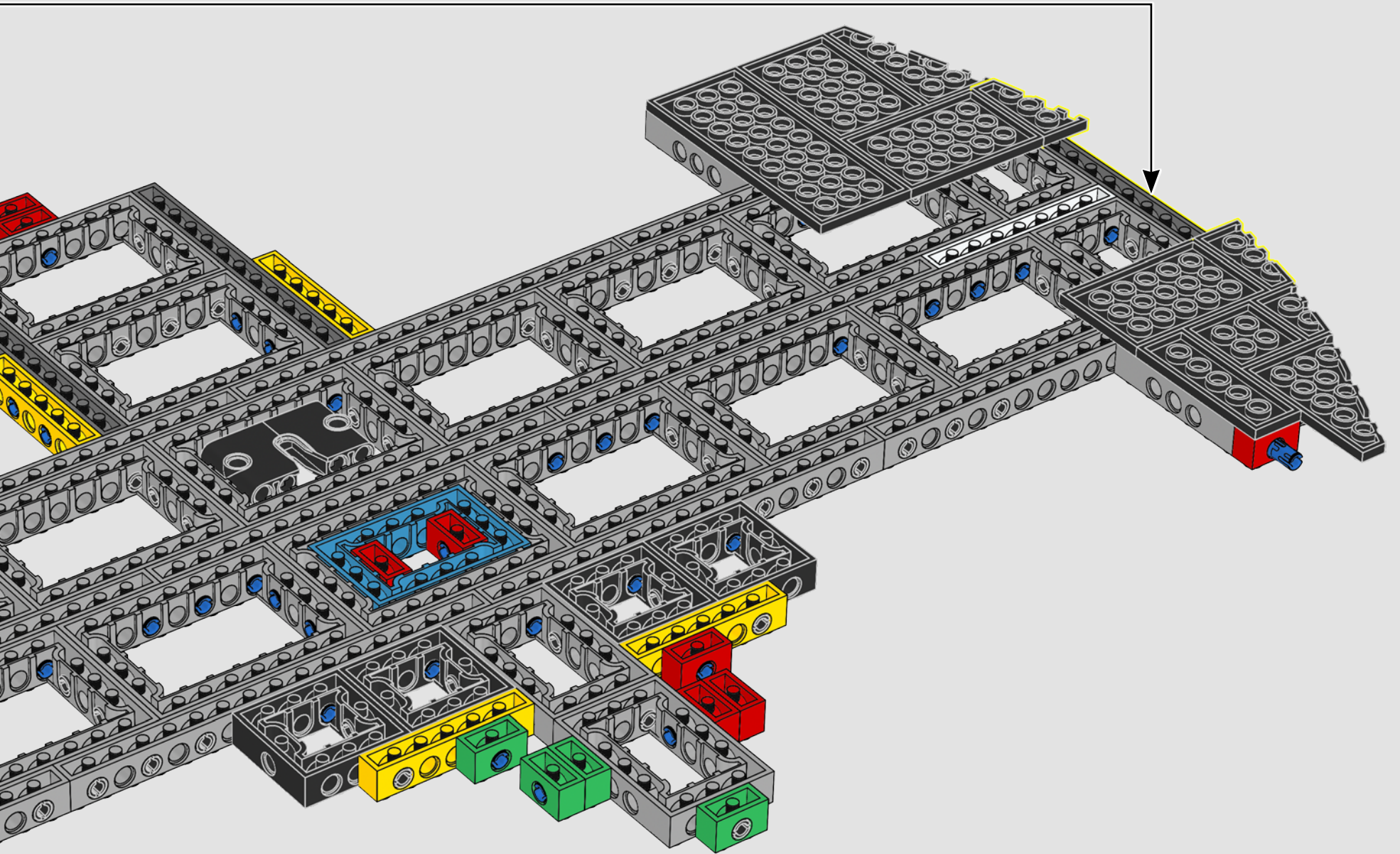



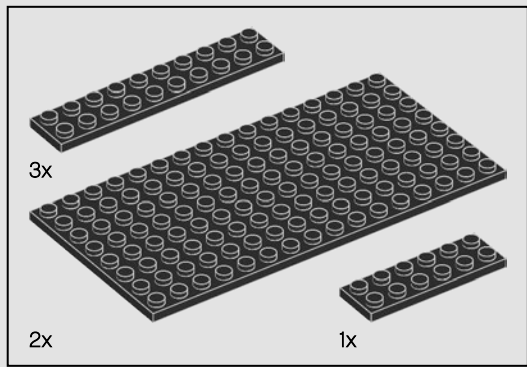

63

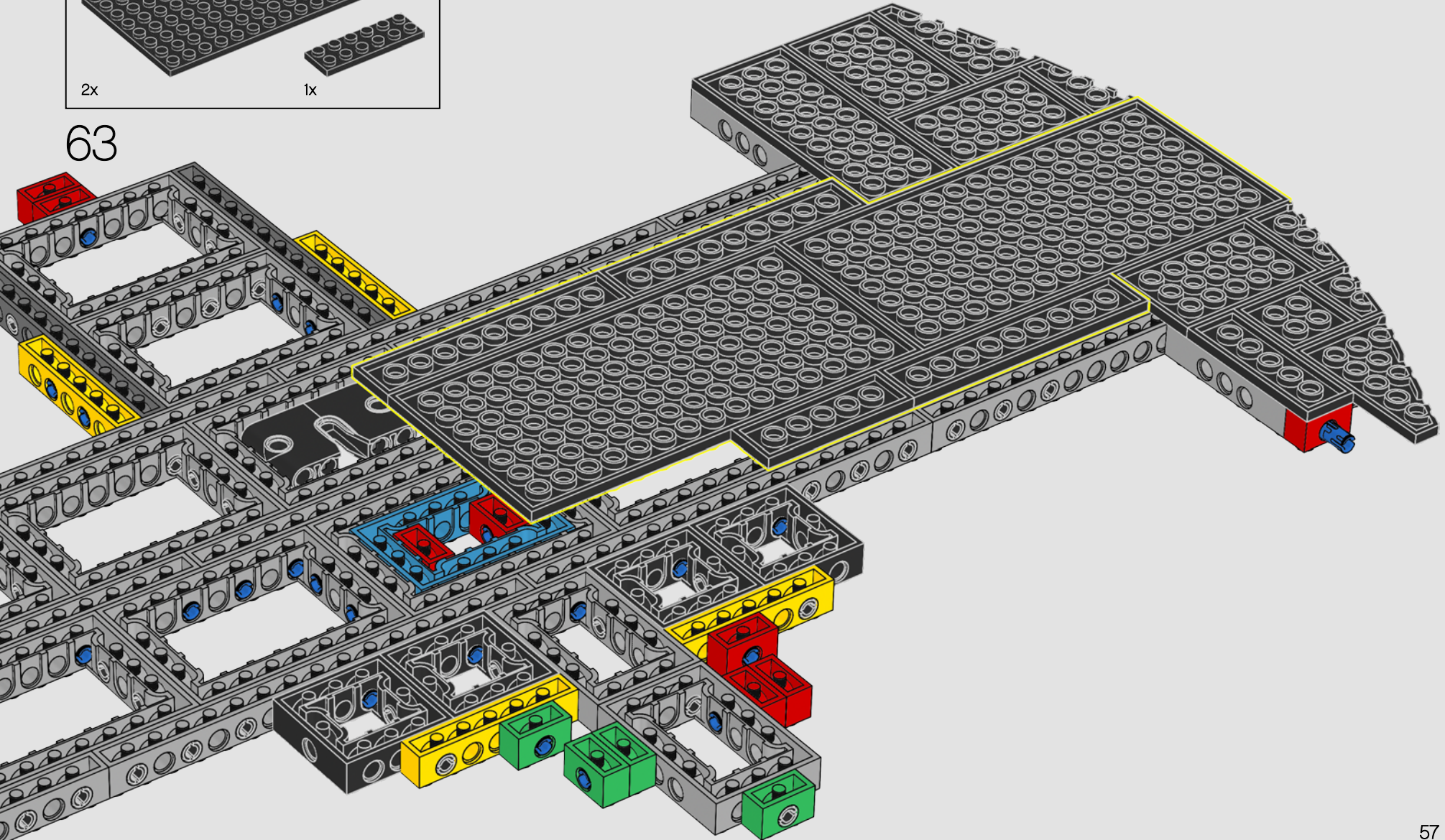

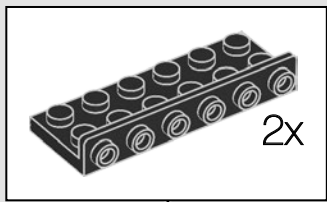
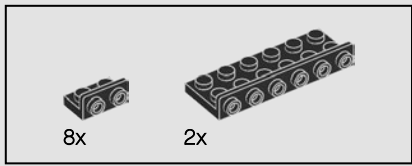

64

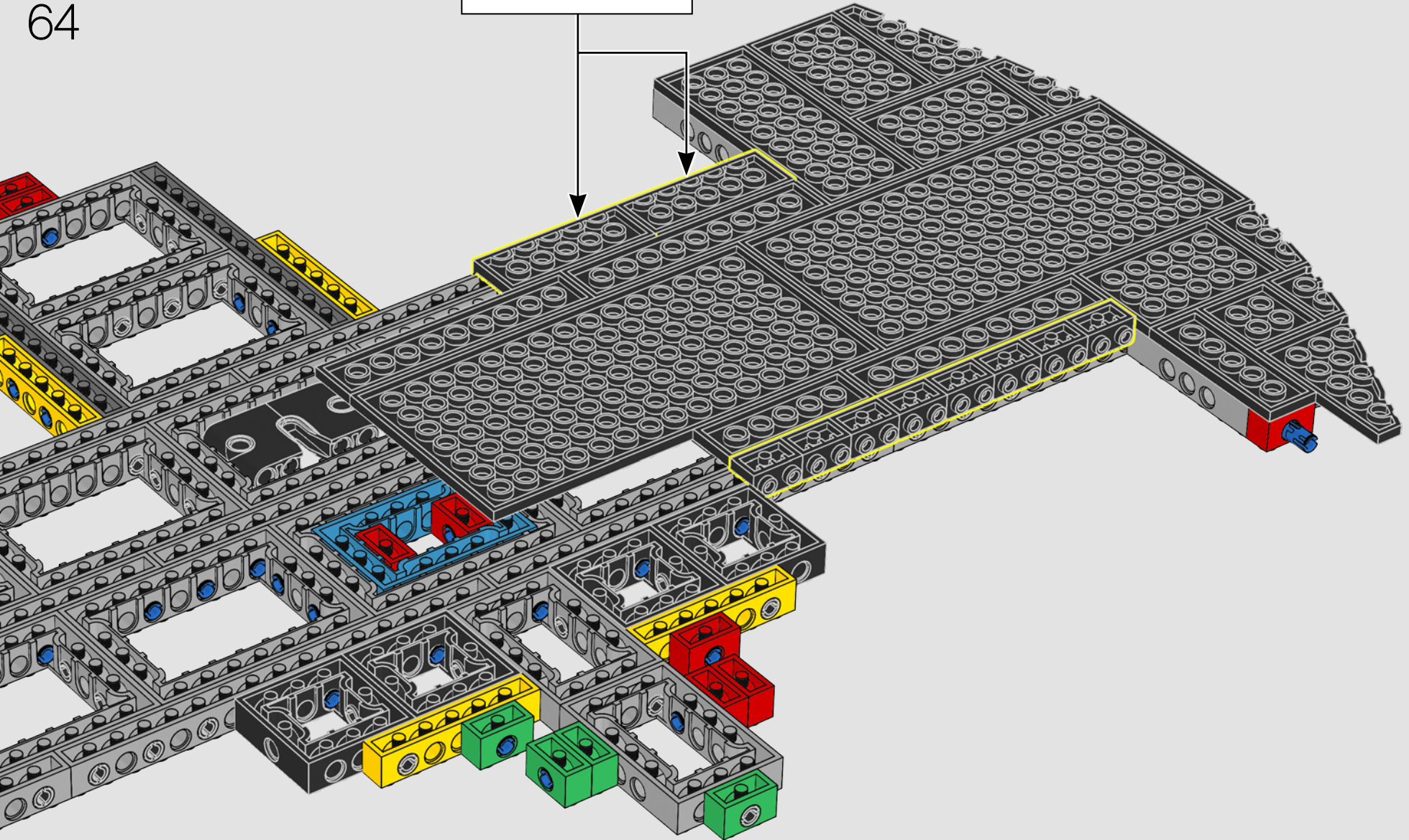

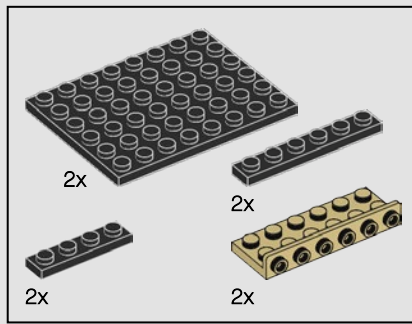

65

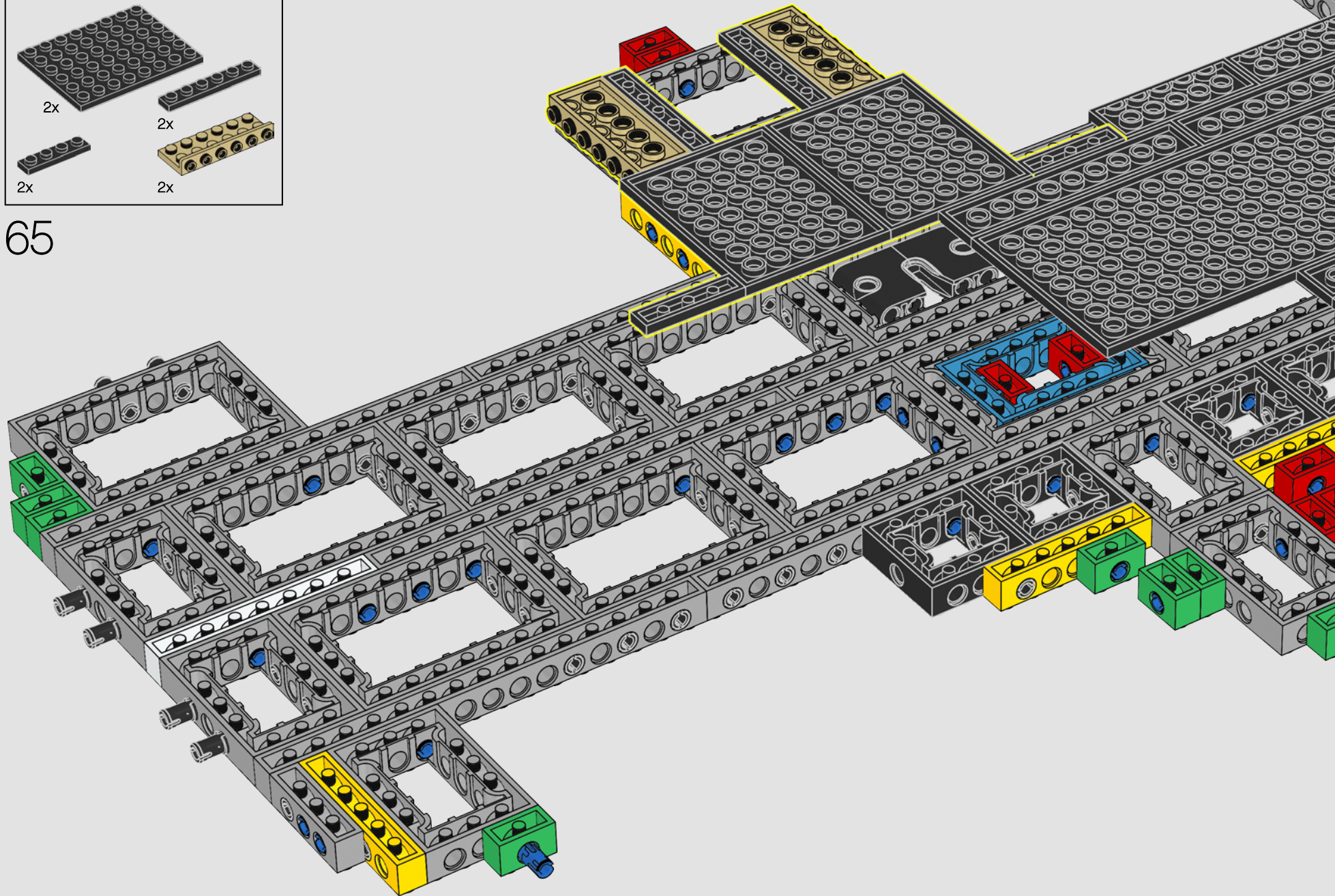

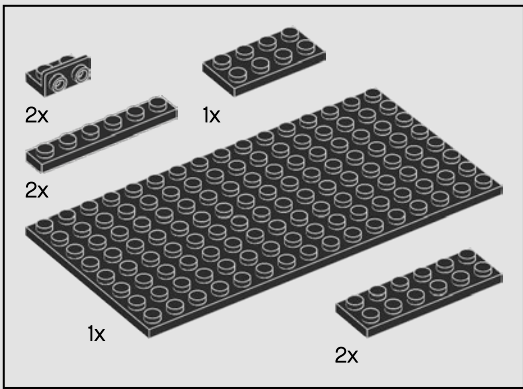

66

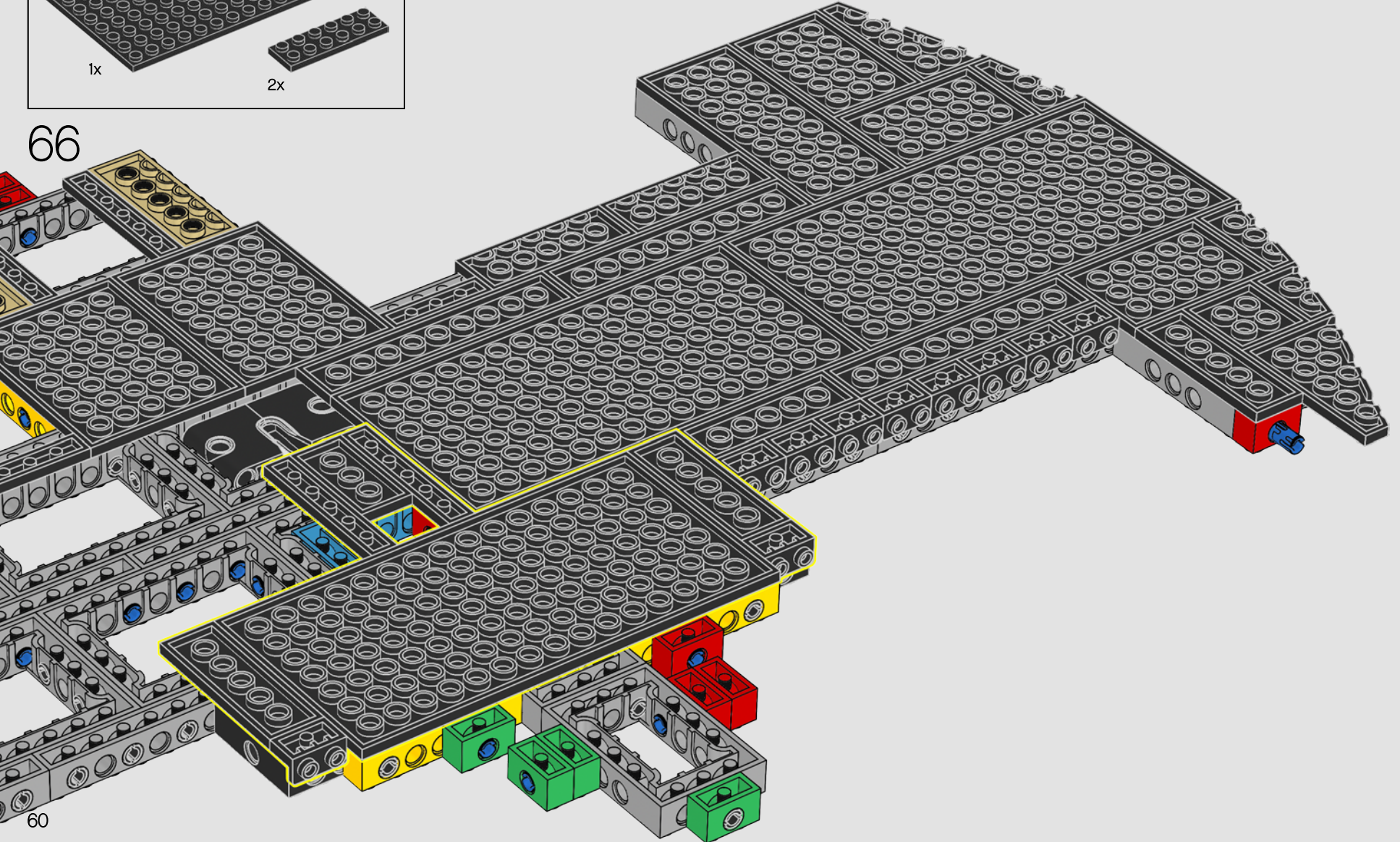



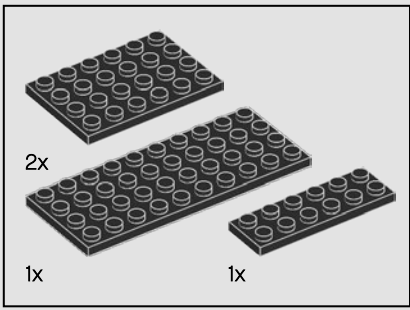

68

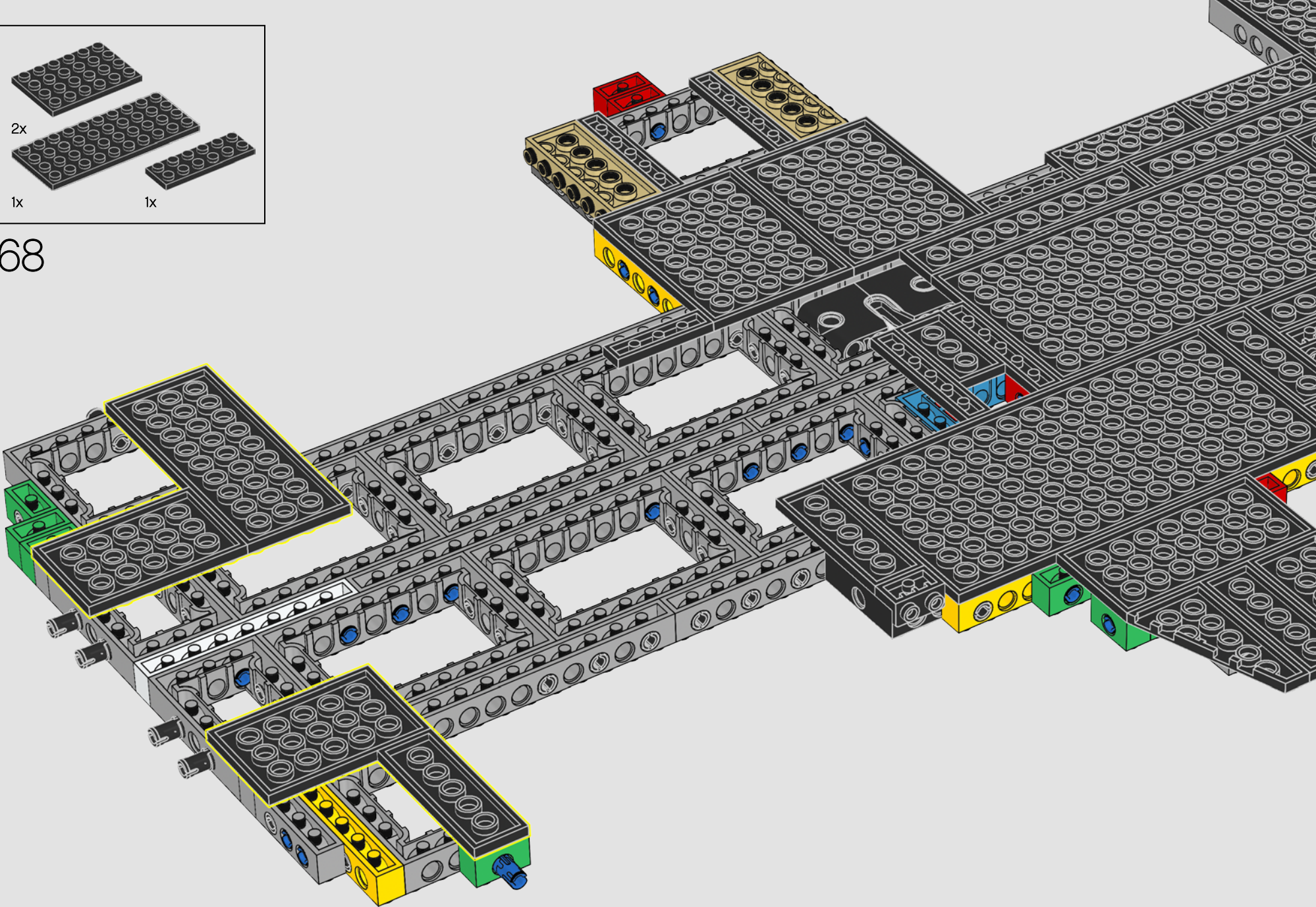

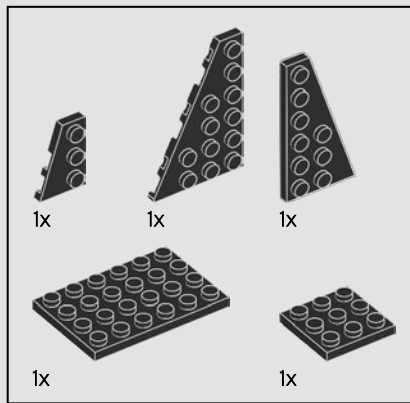

69

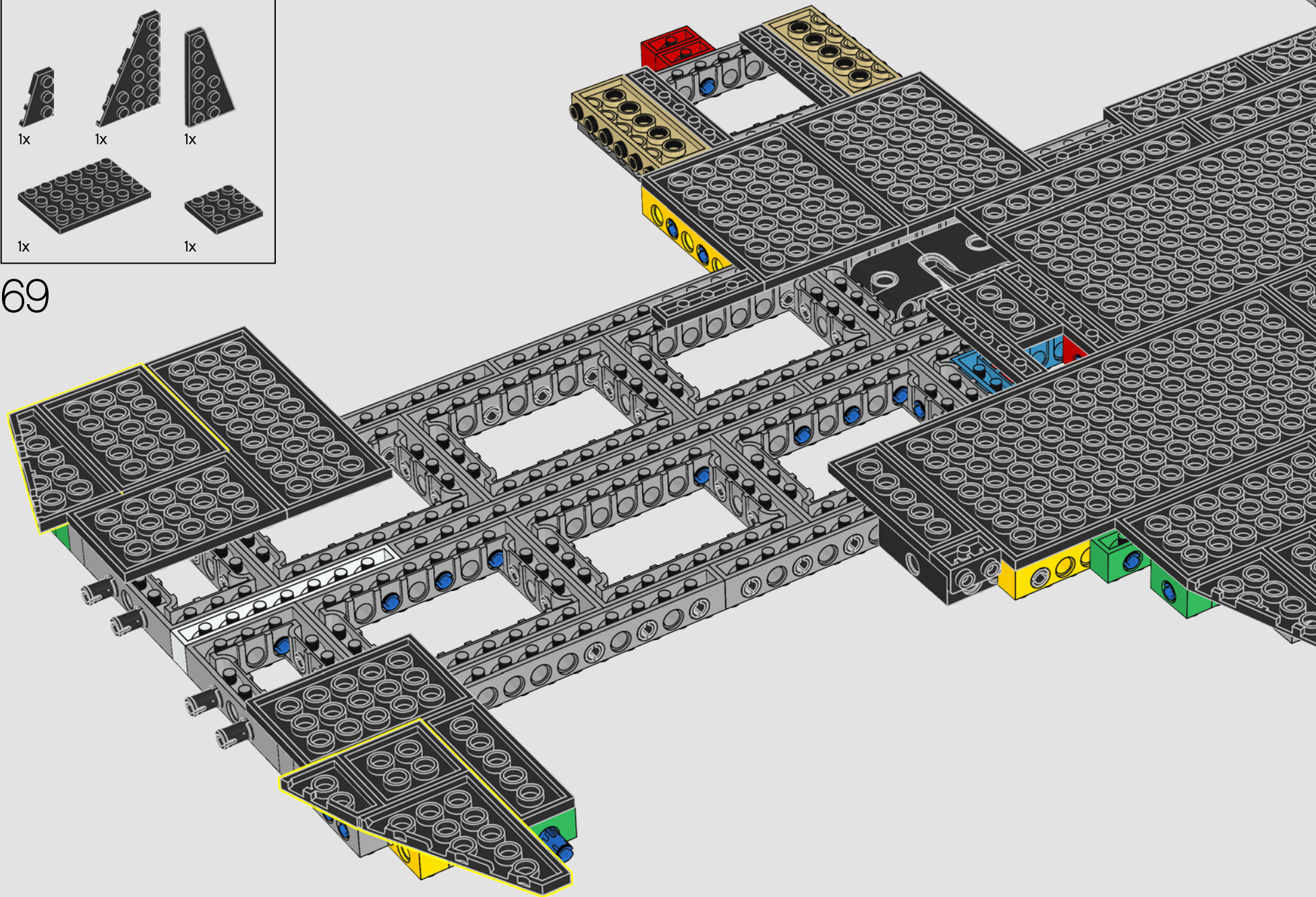

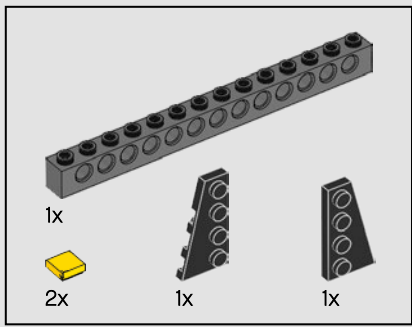

70

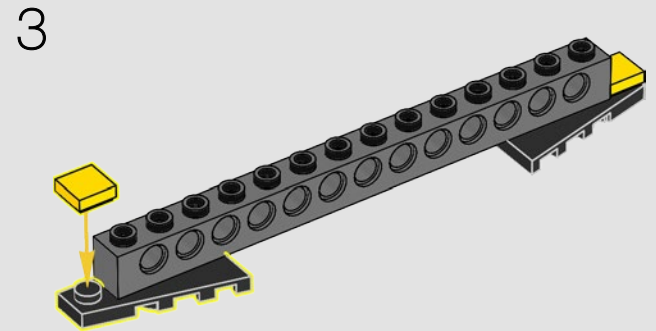
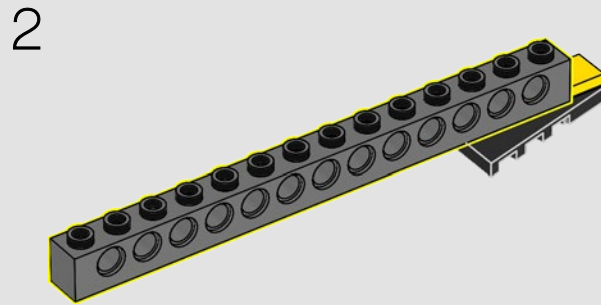
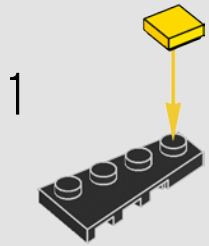



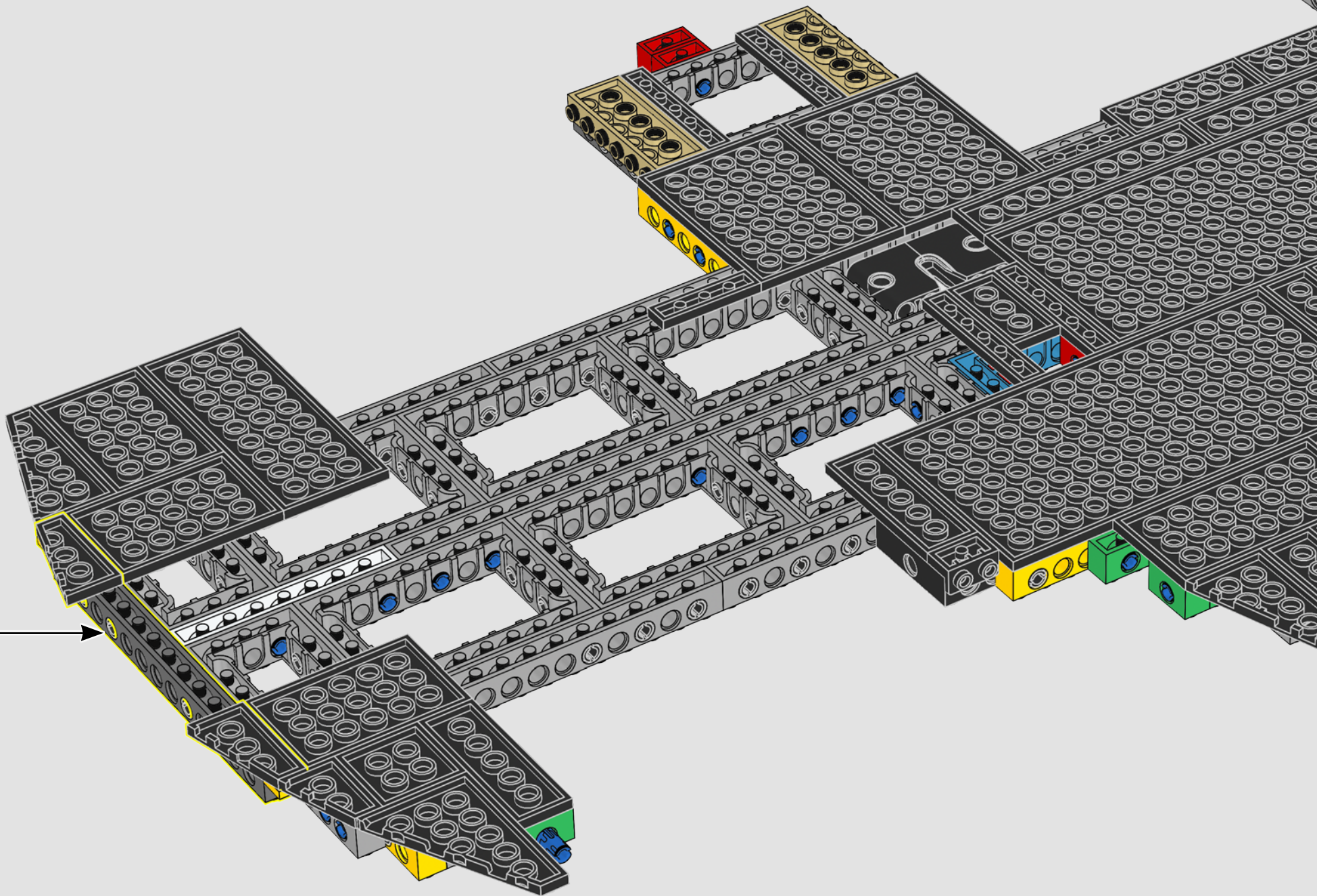

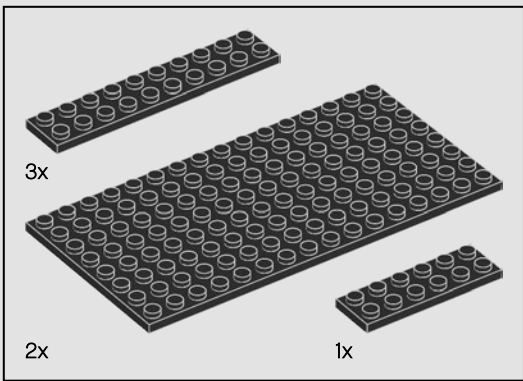

71

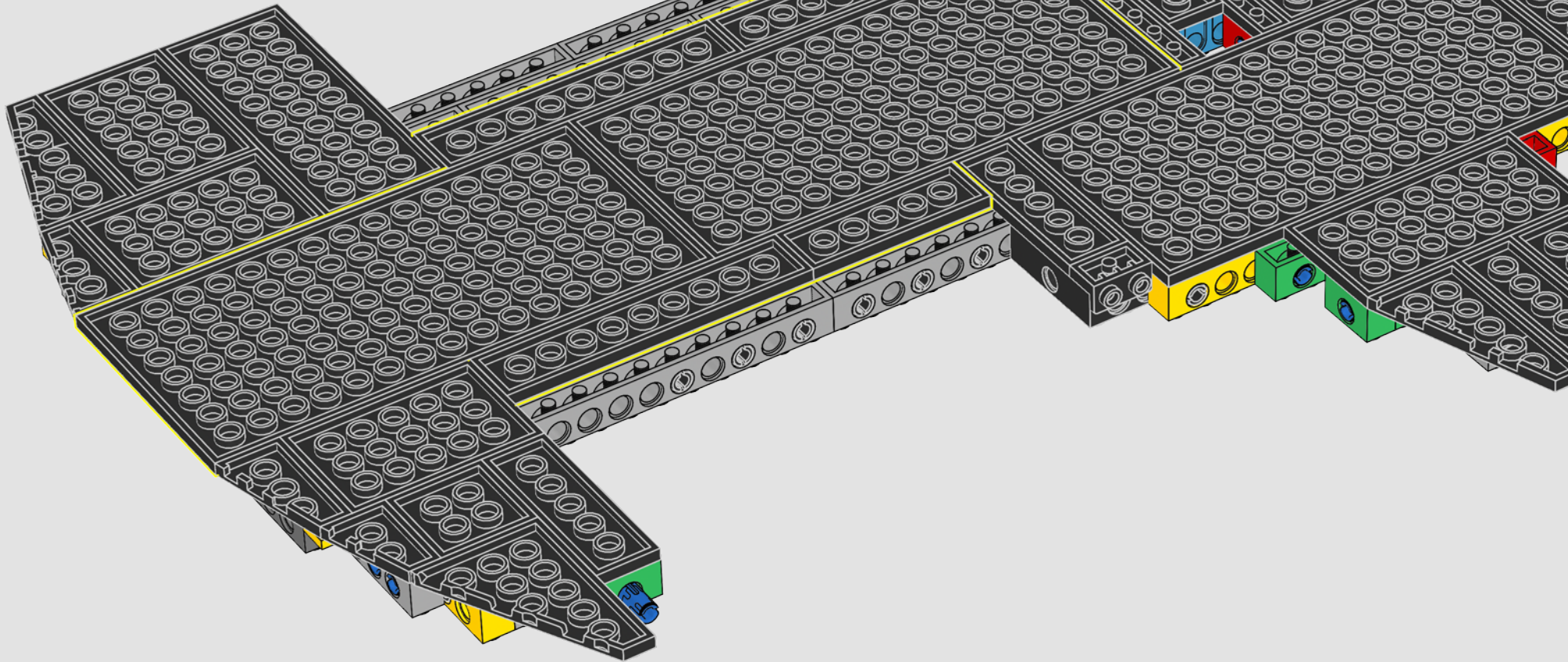

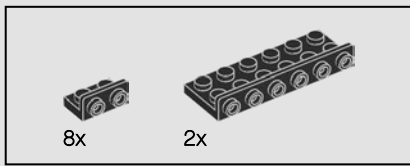

72

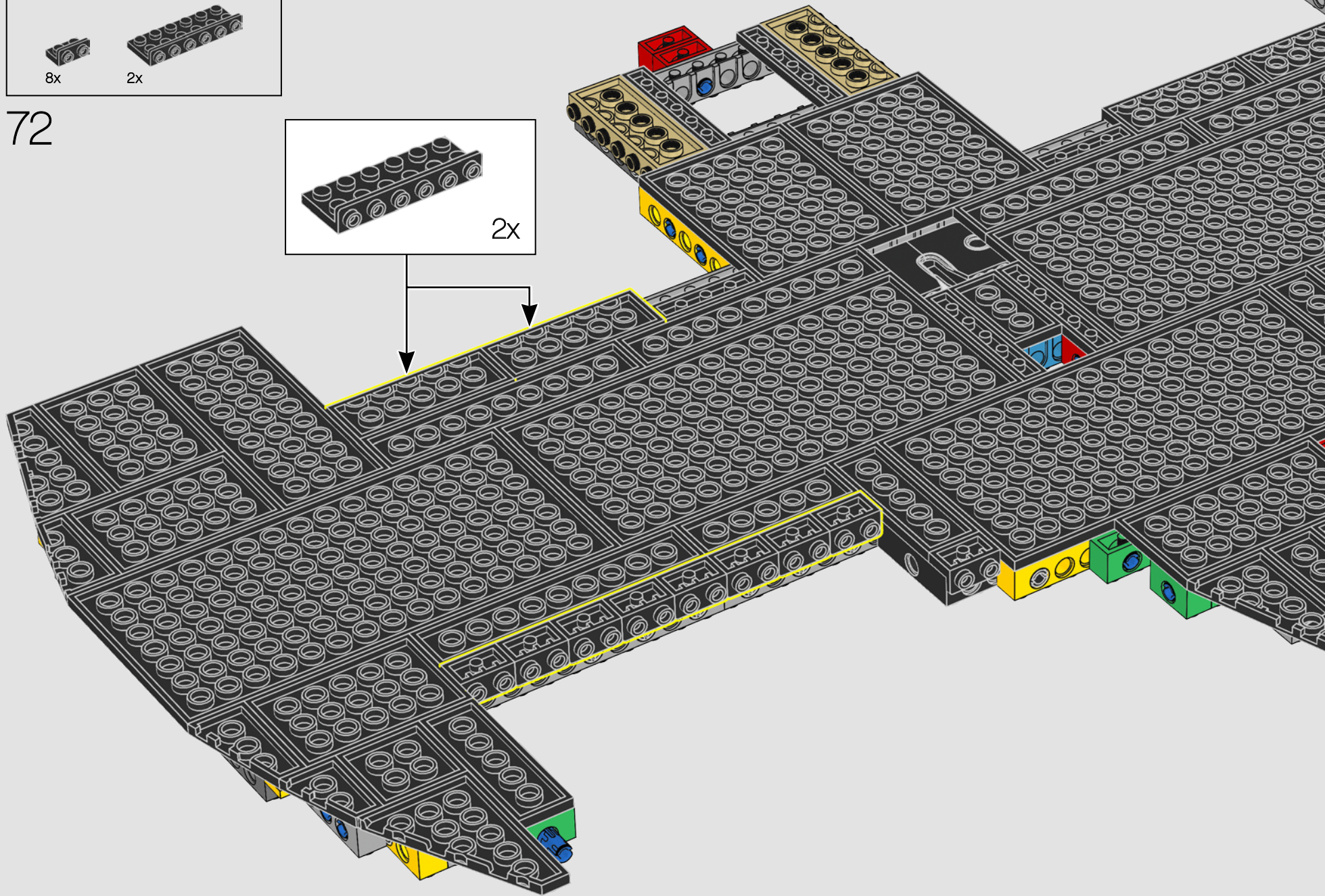
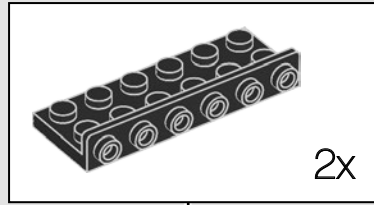

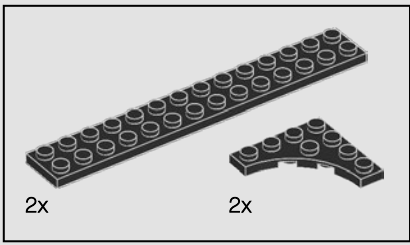

73

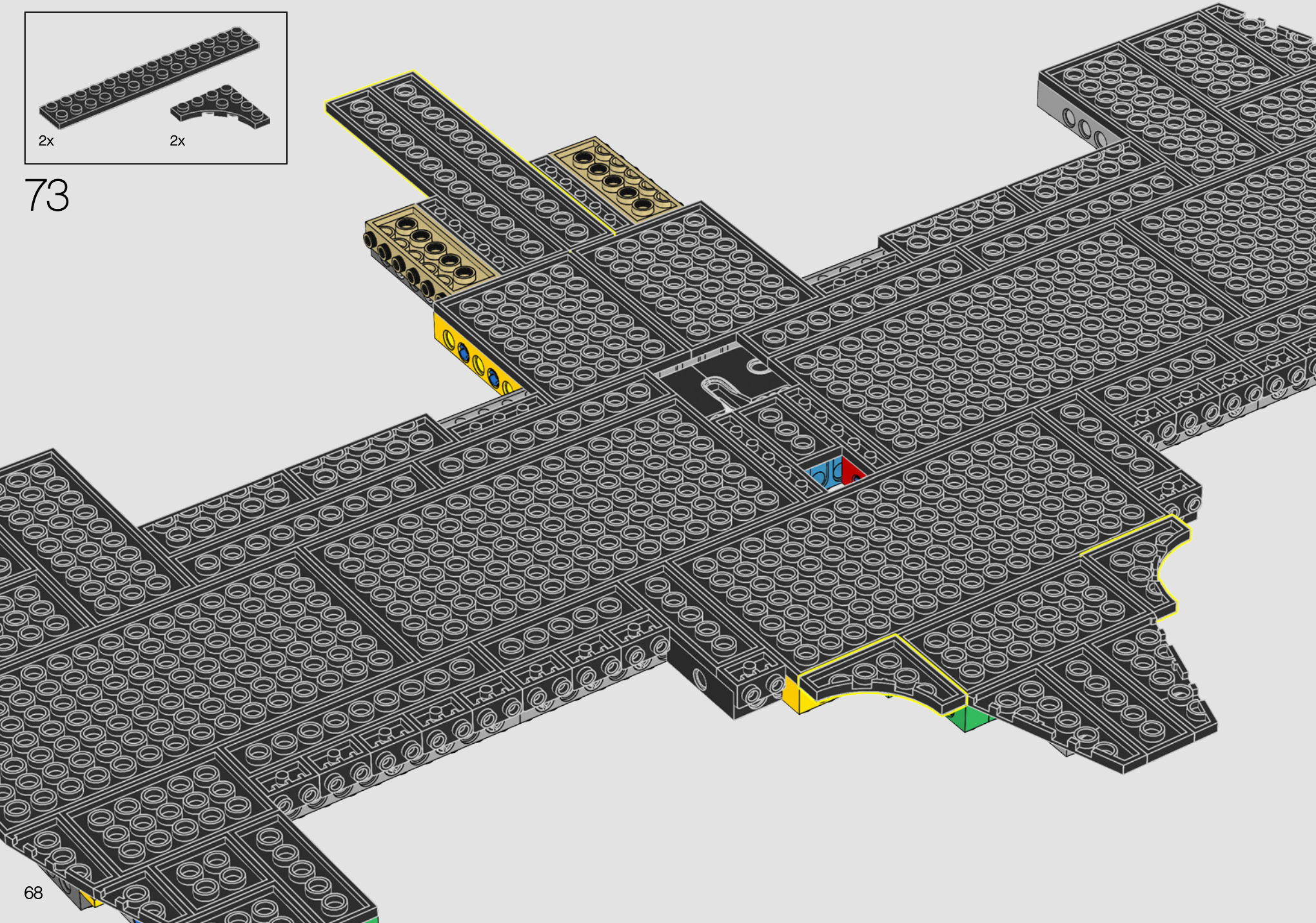

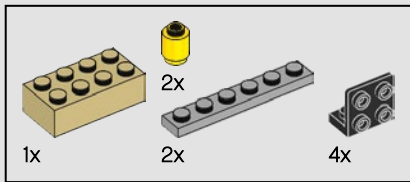

74

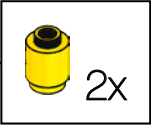
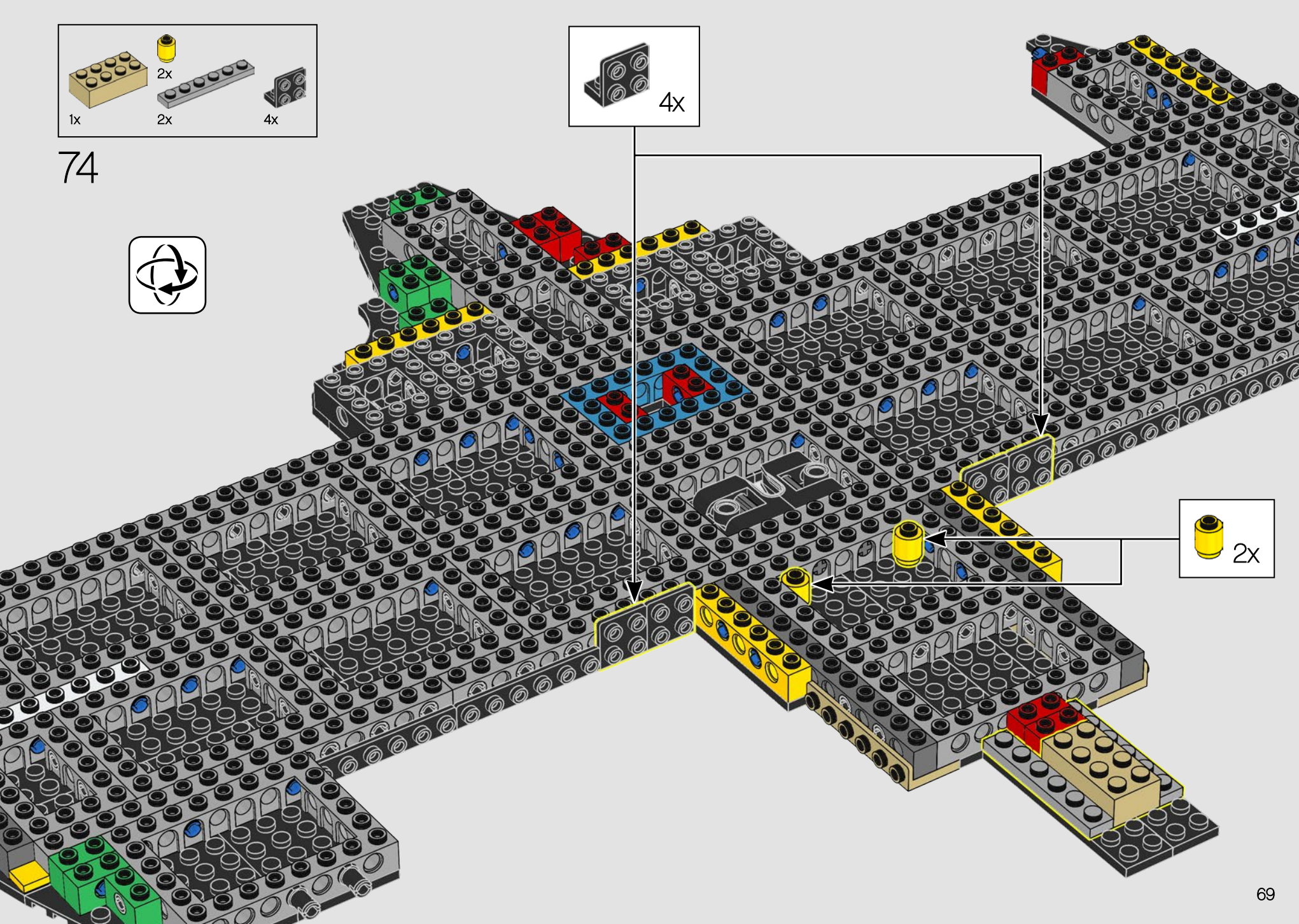
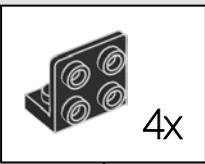

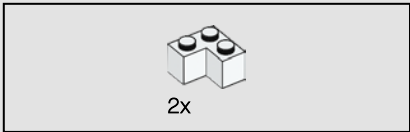

75

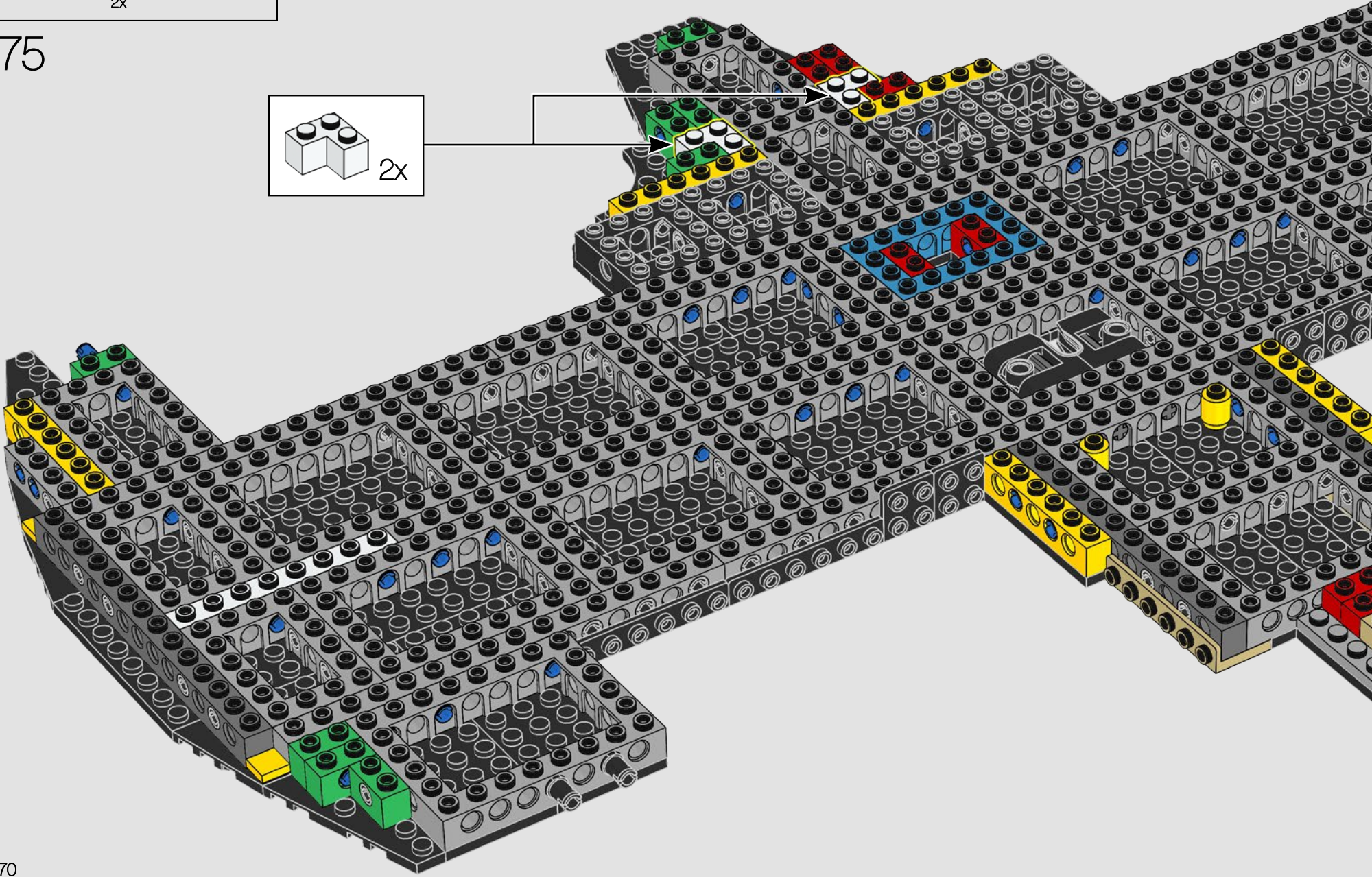
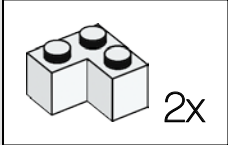

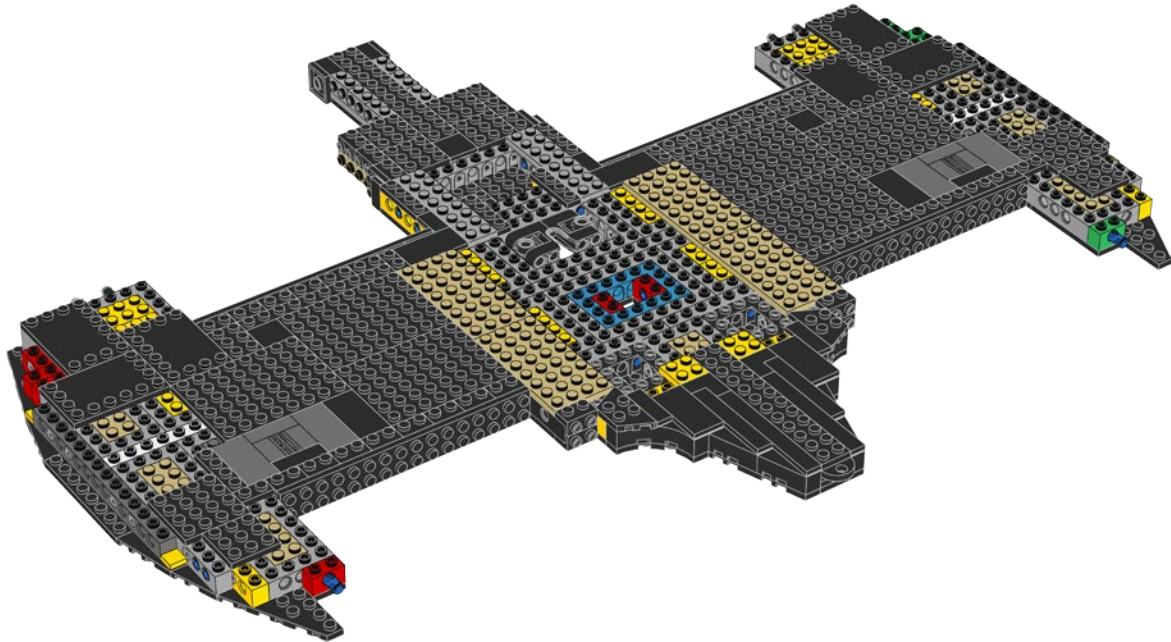
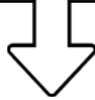
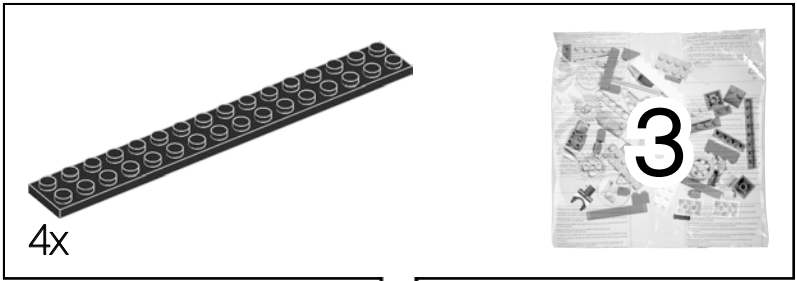

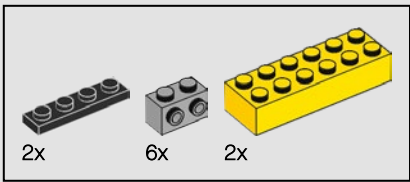

76

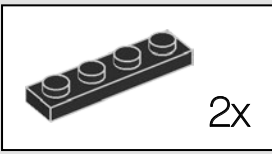
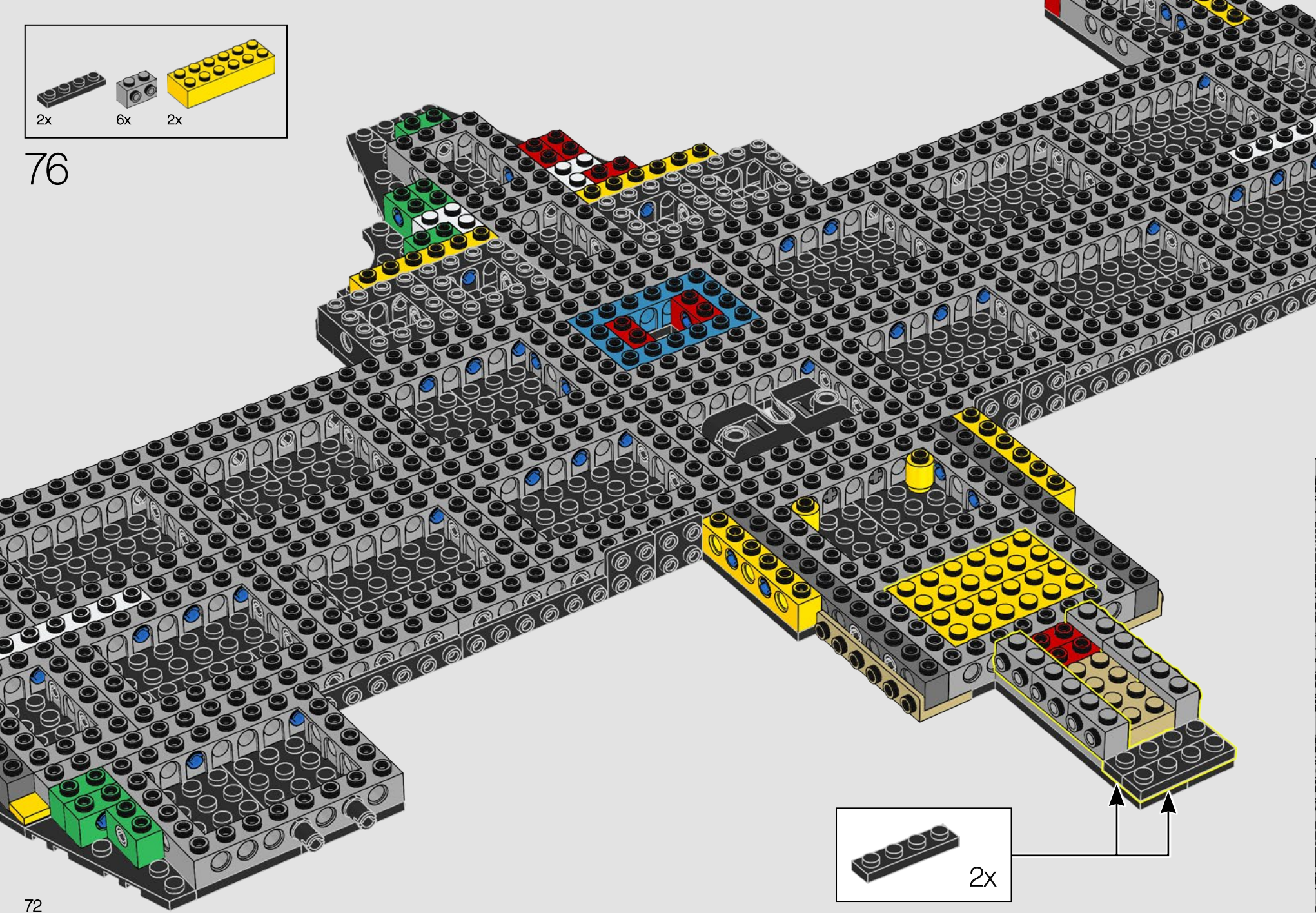

72



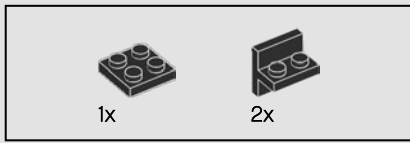

77

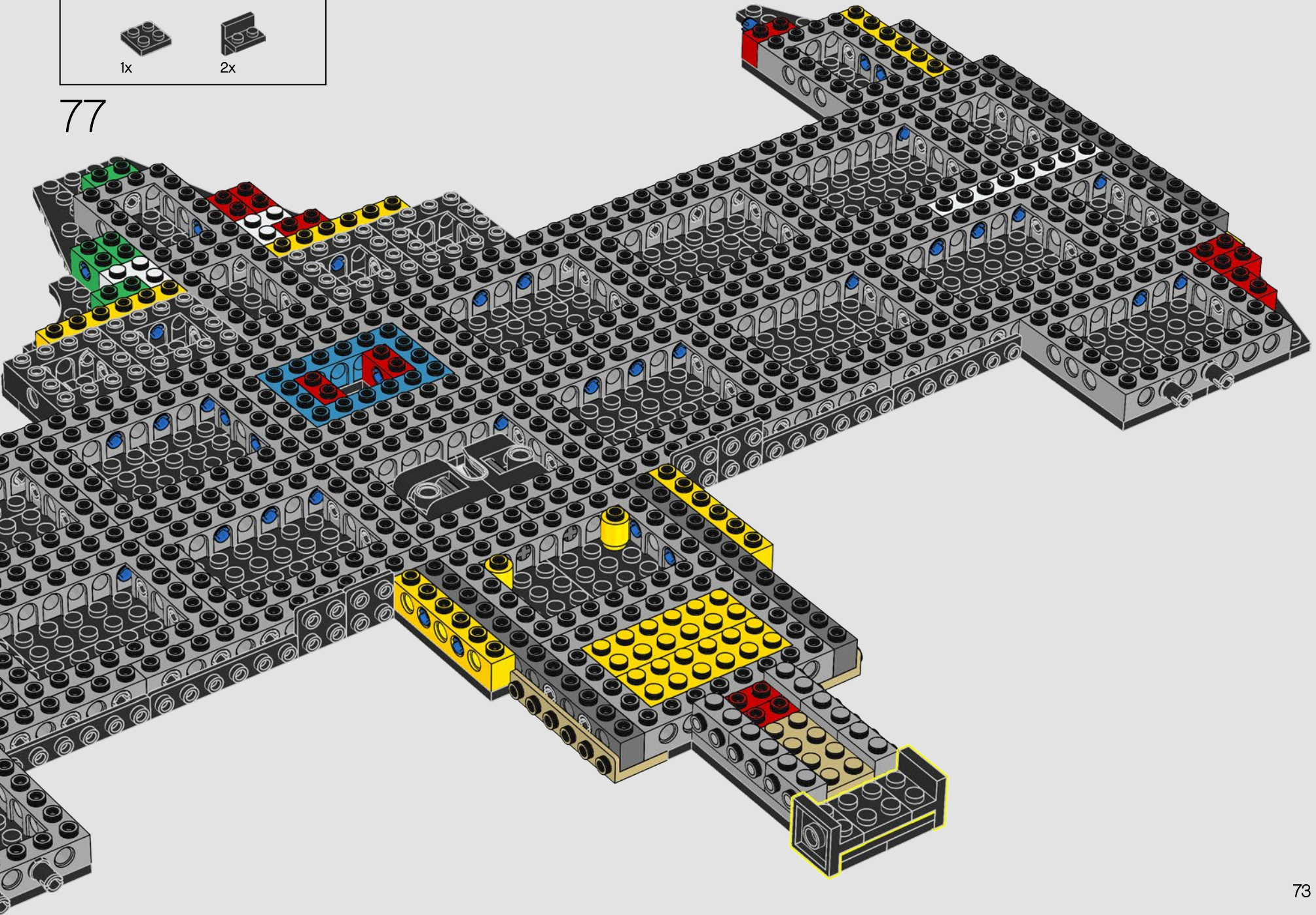

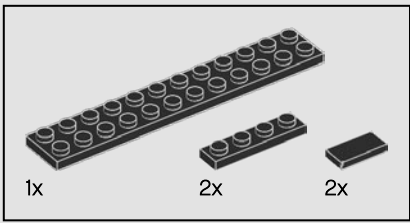

78

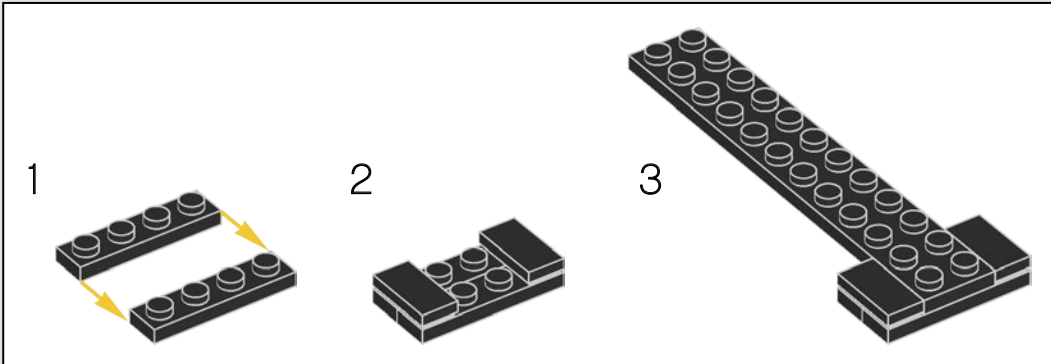
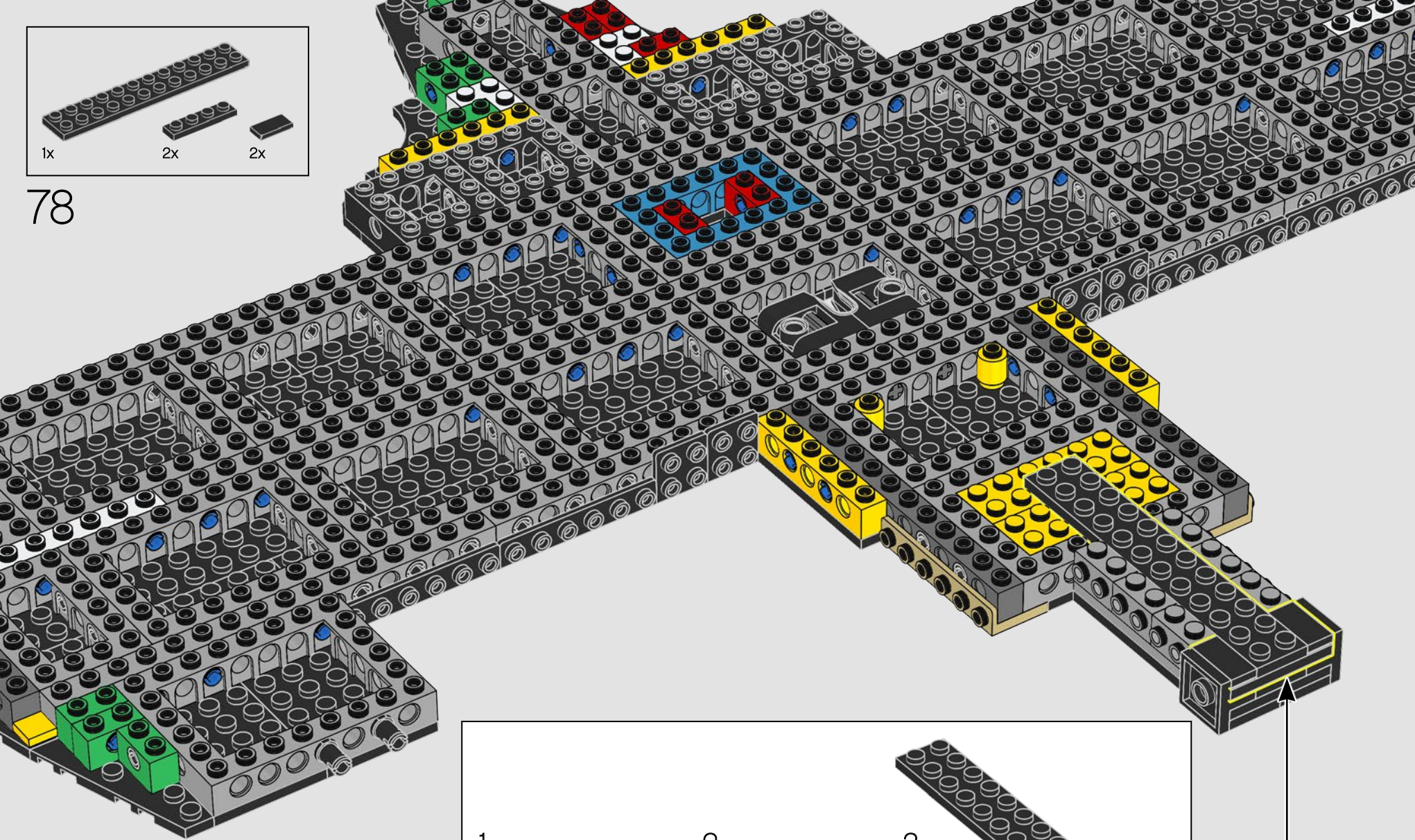

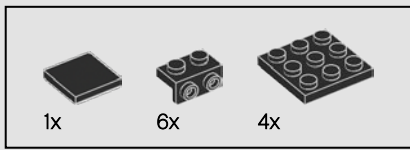

79

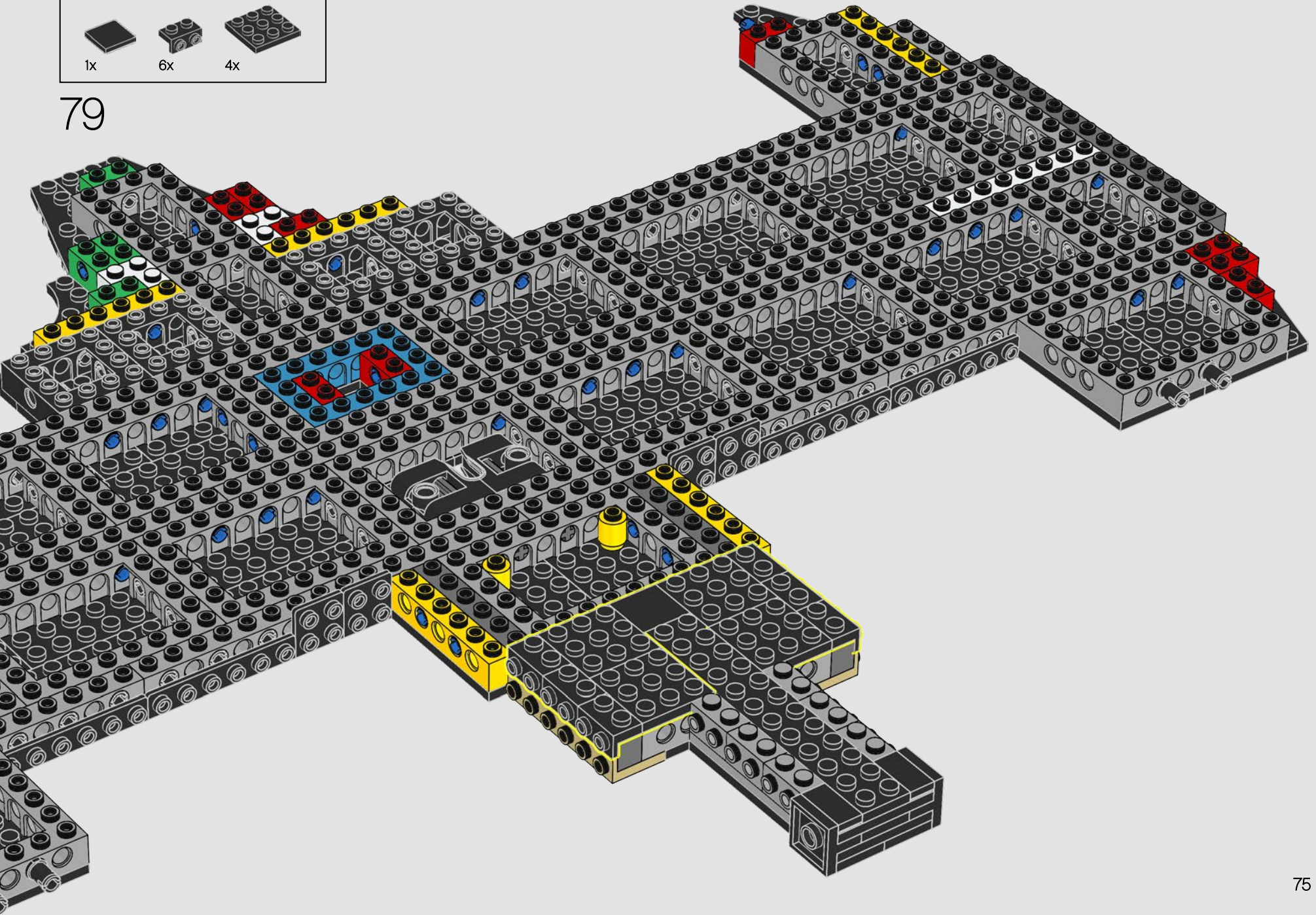

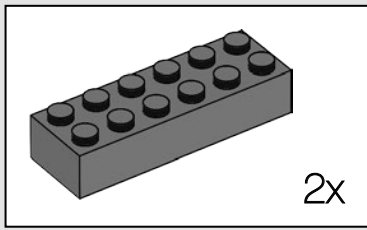
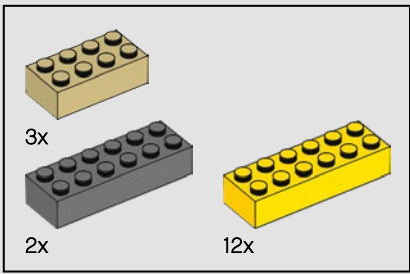

80

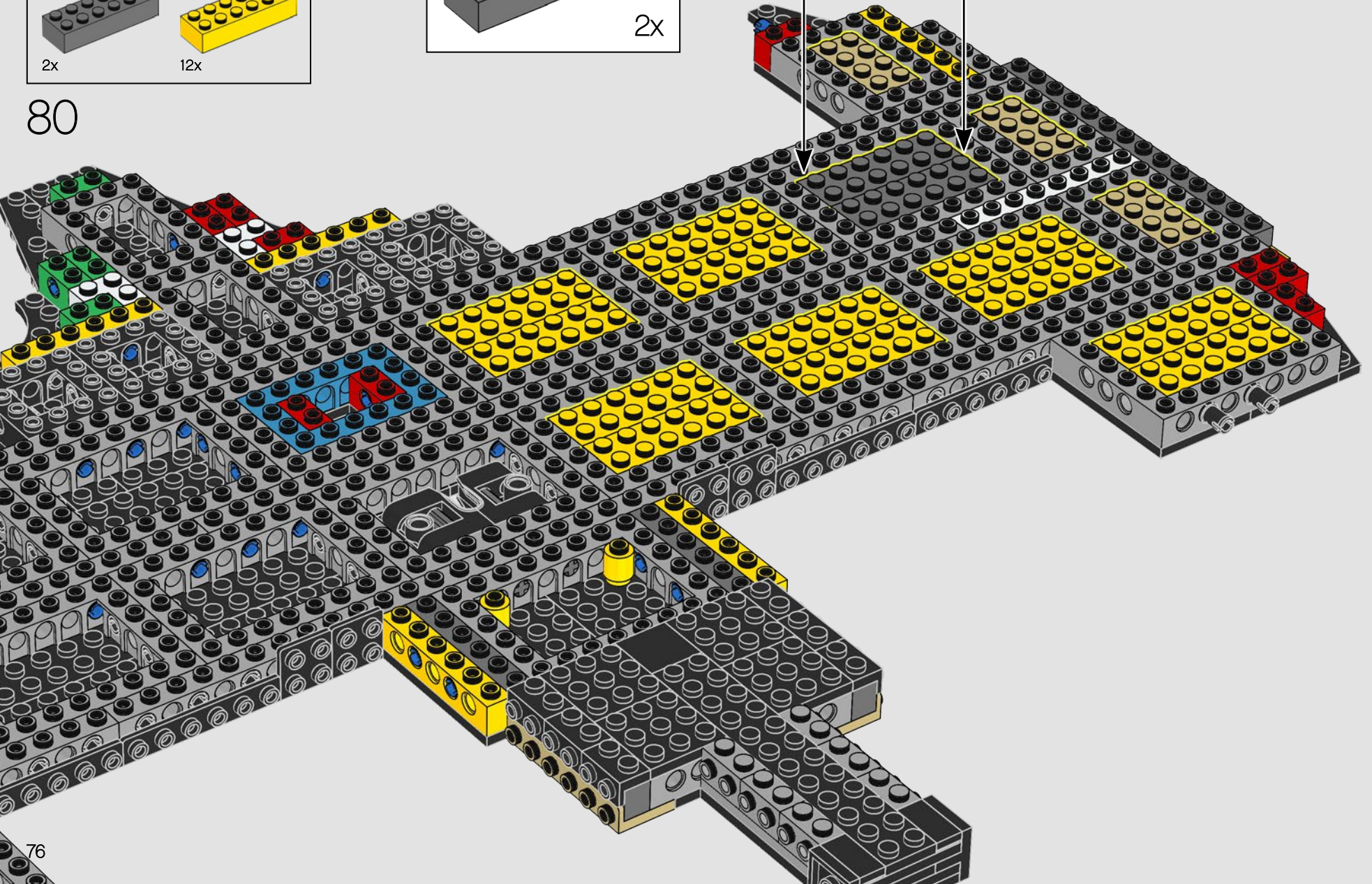

76

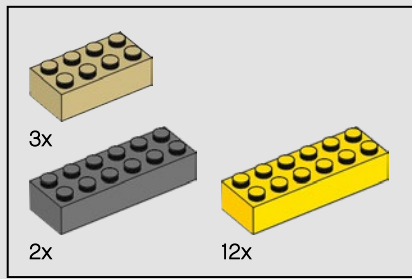

81

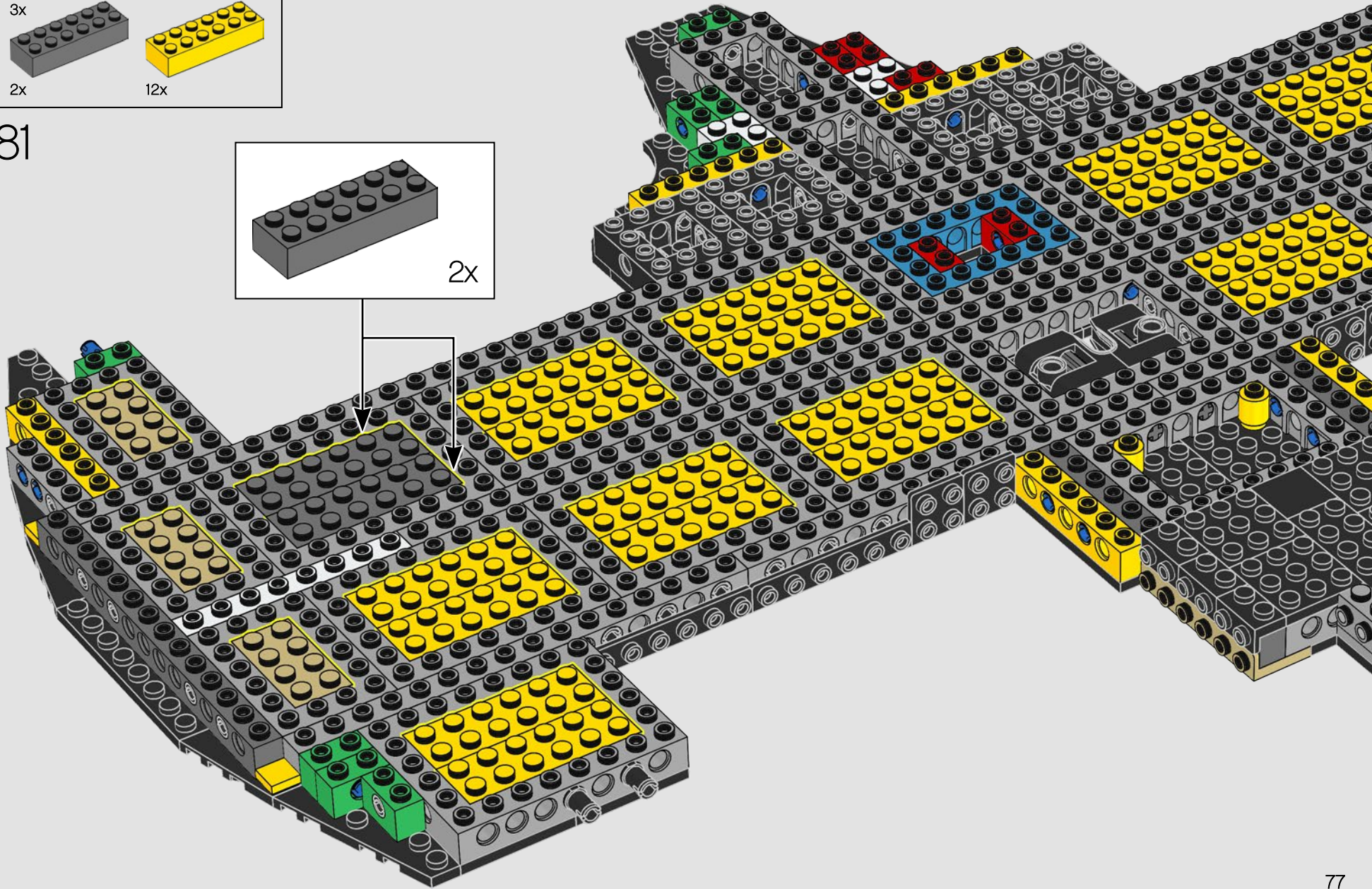
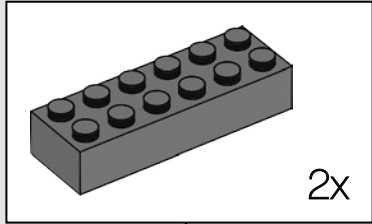

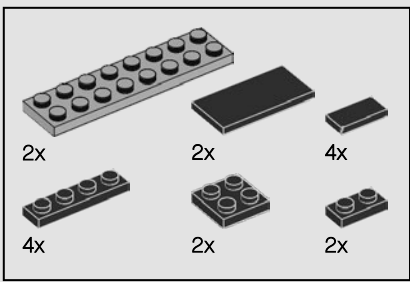

82

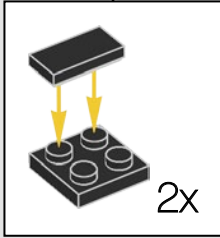
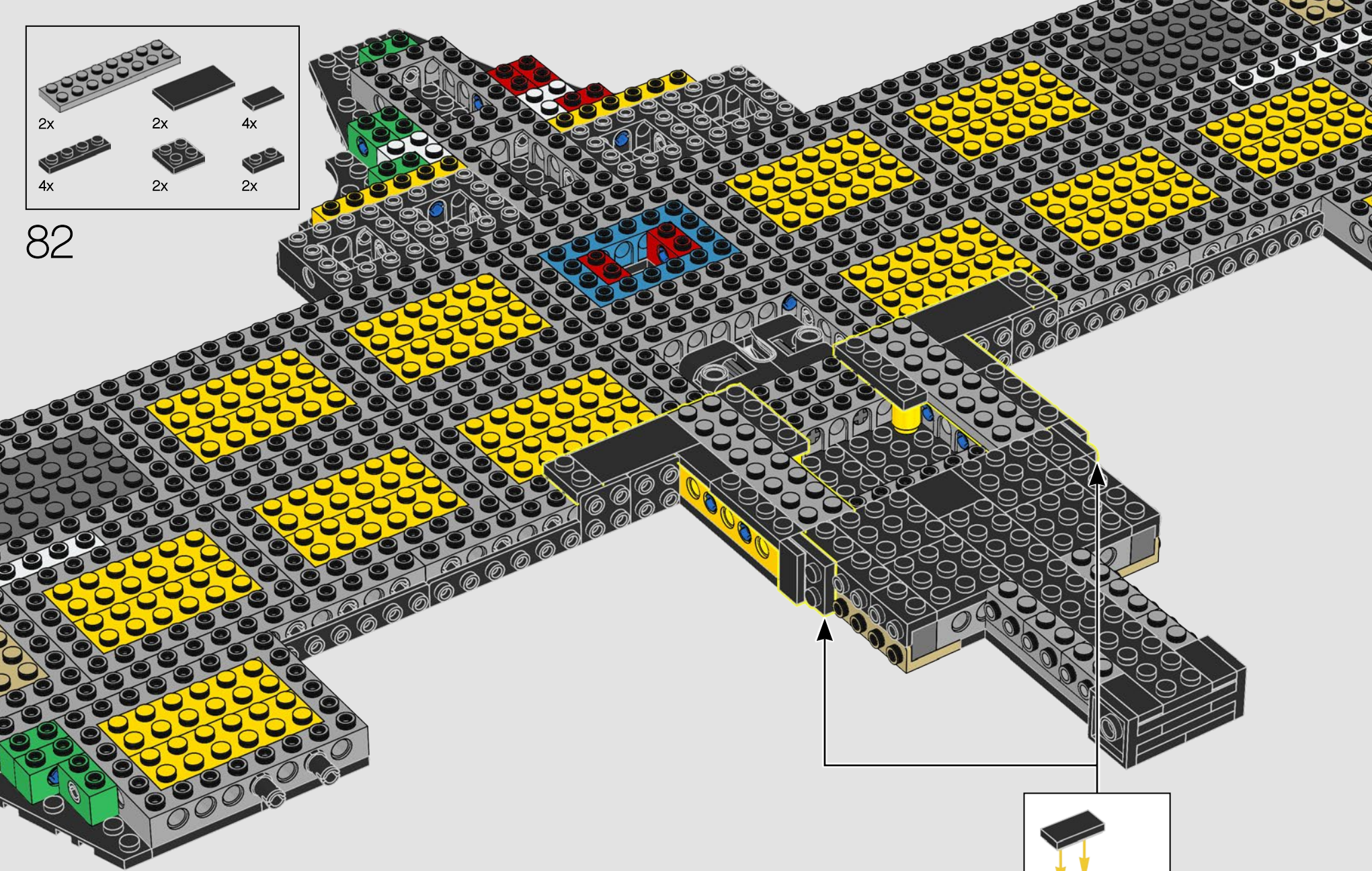

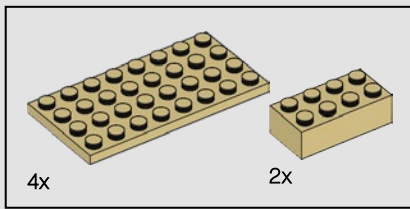

83

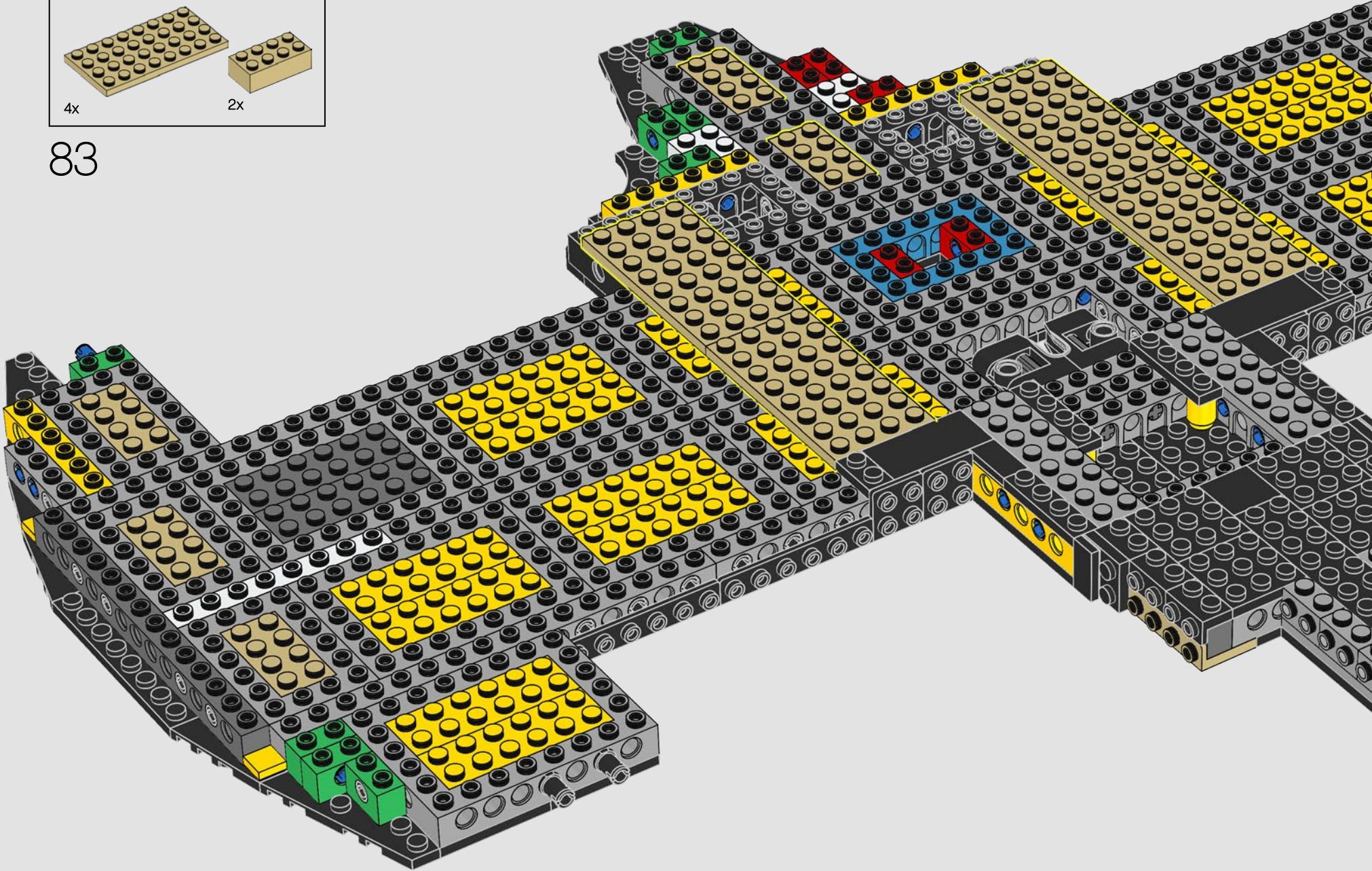



14x

84

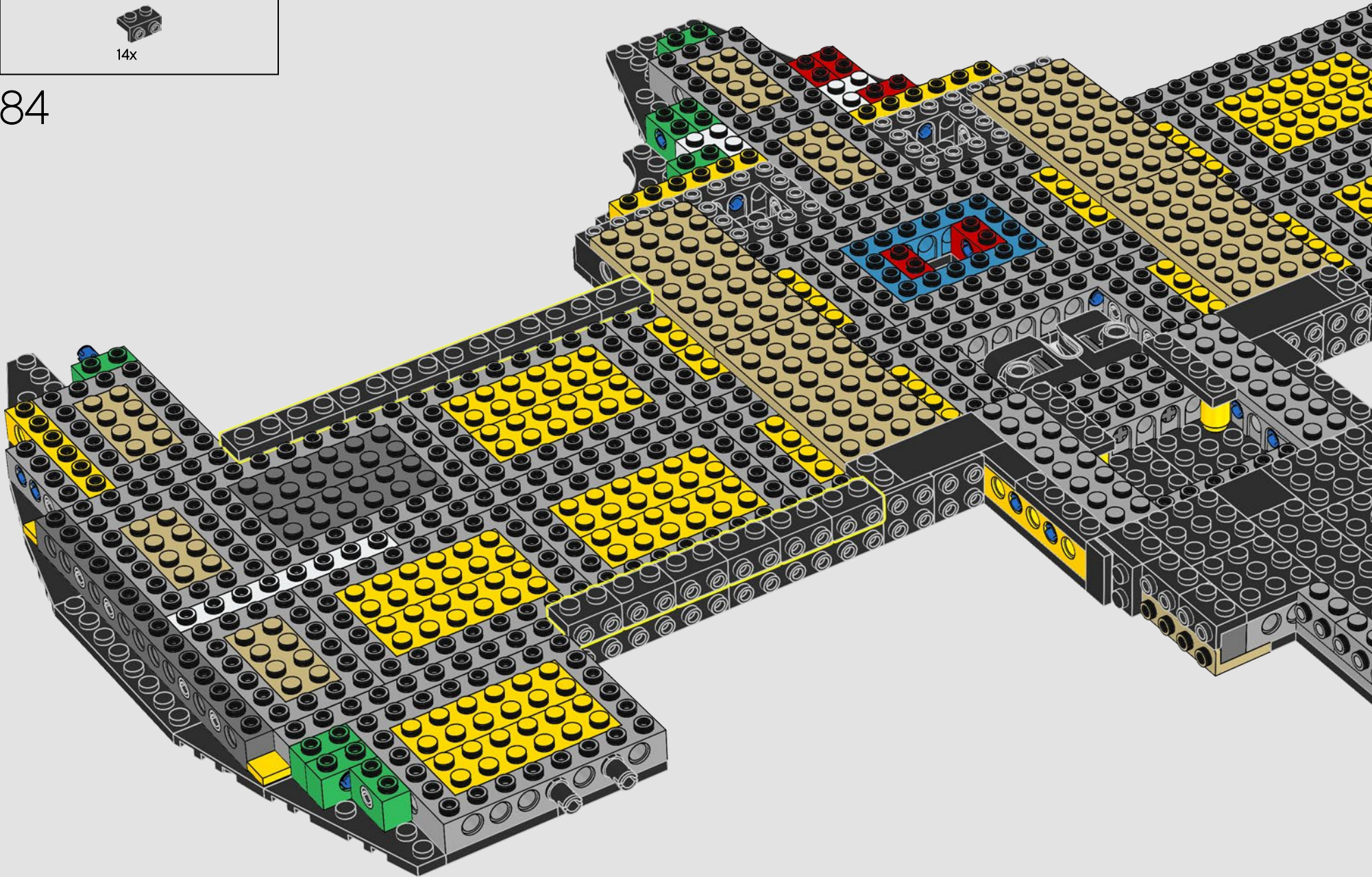



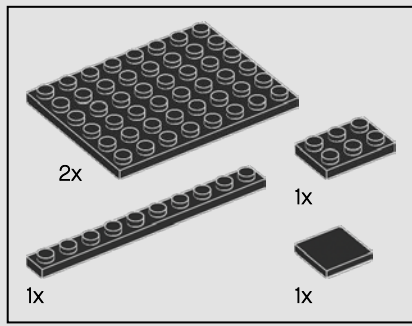

85

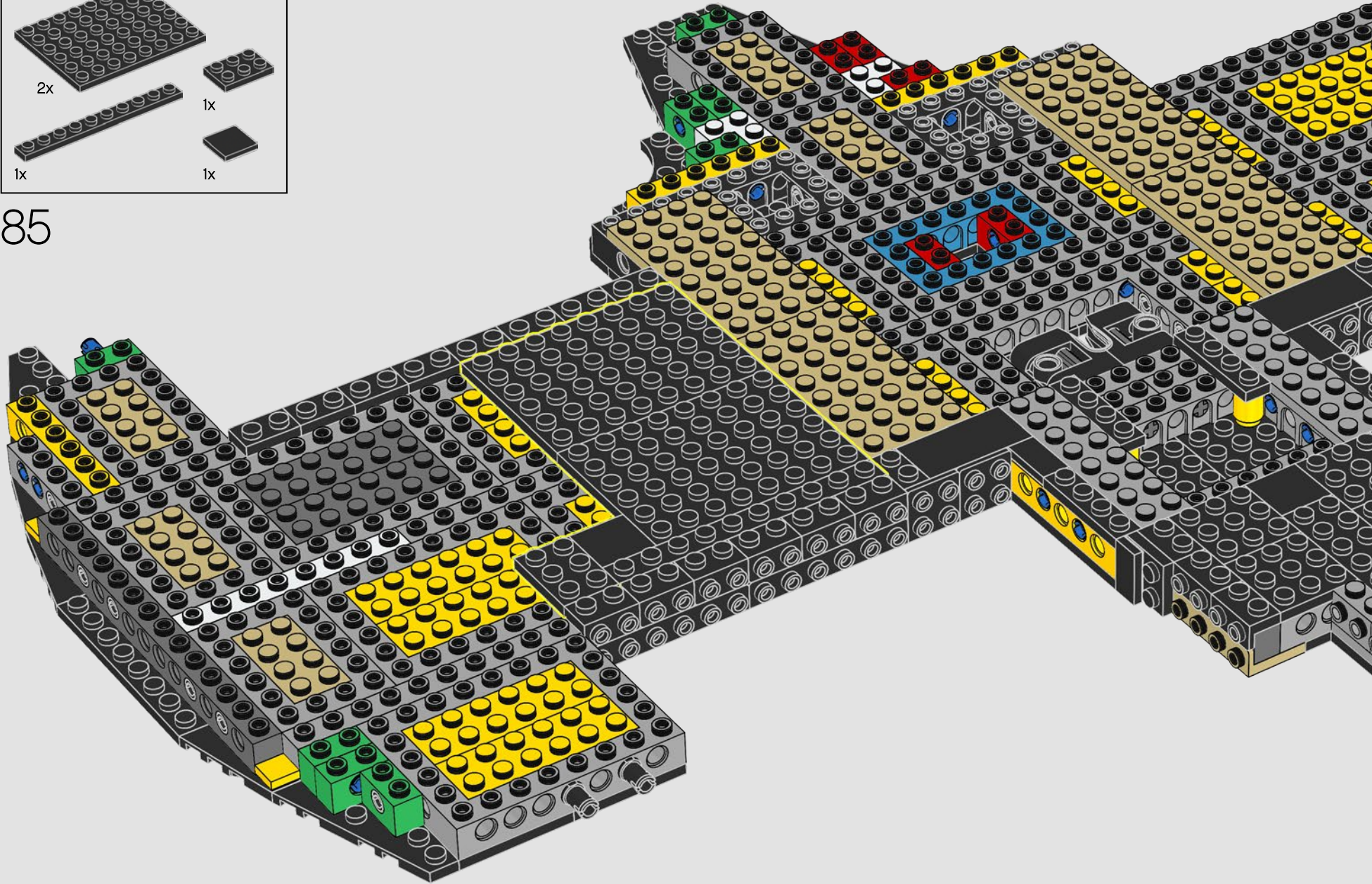



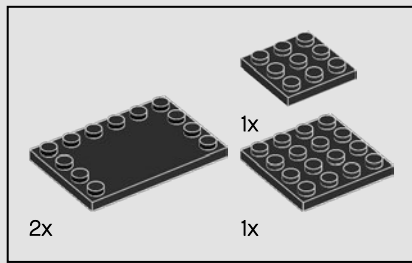

87

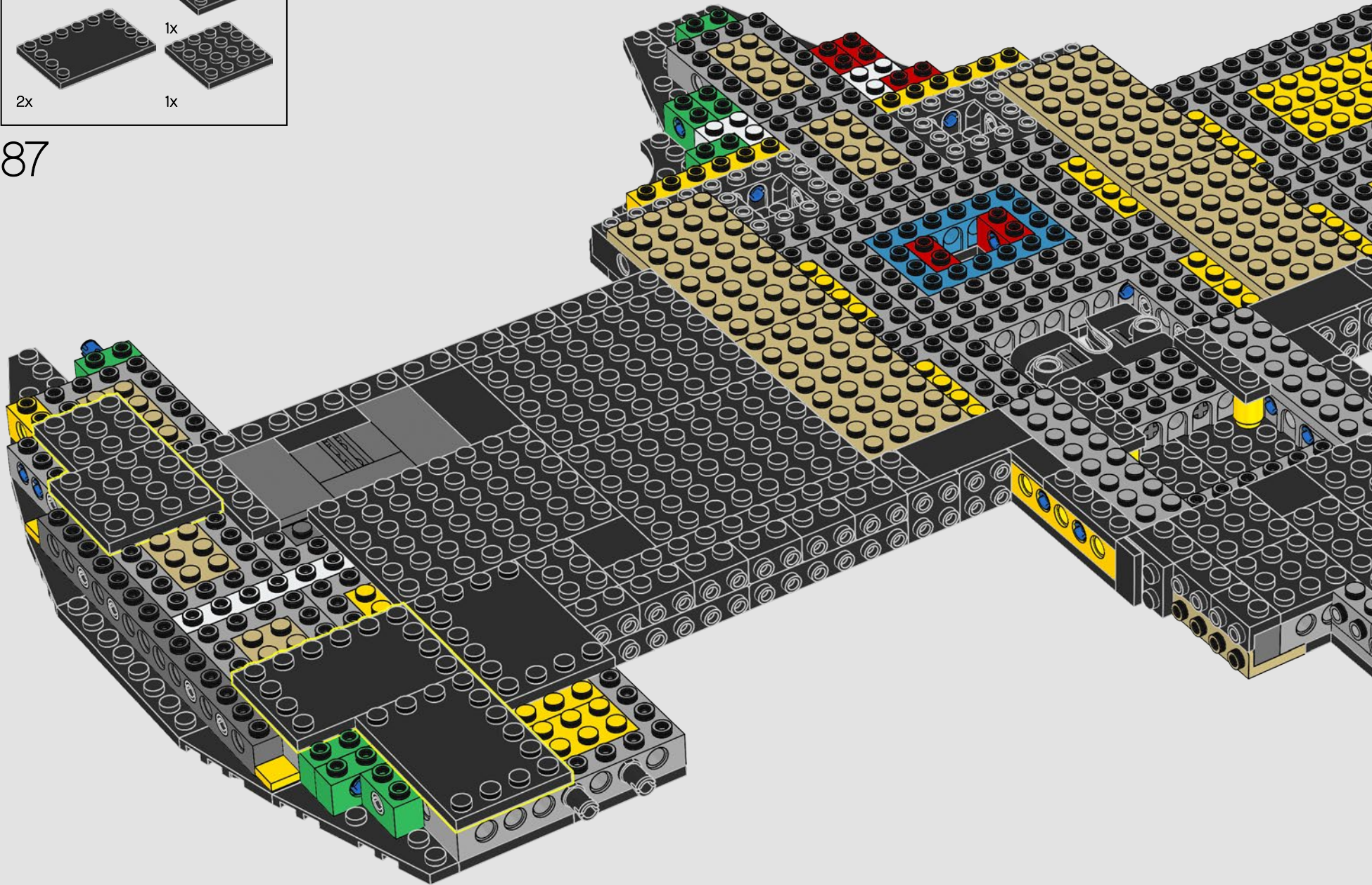



14x

88

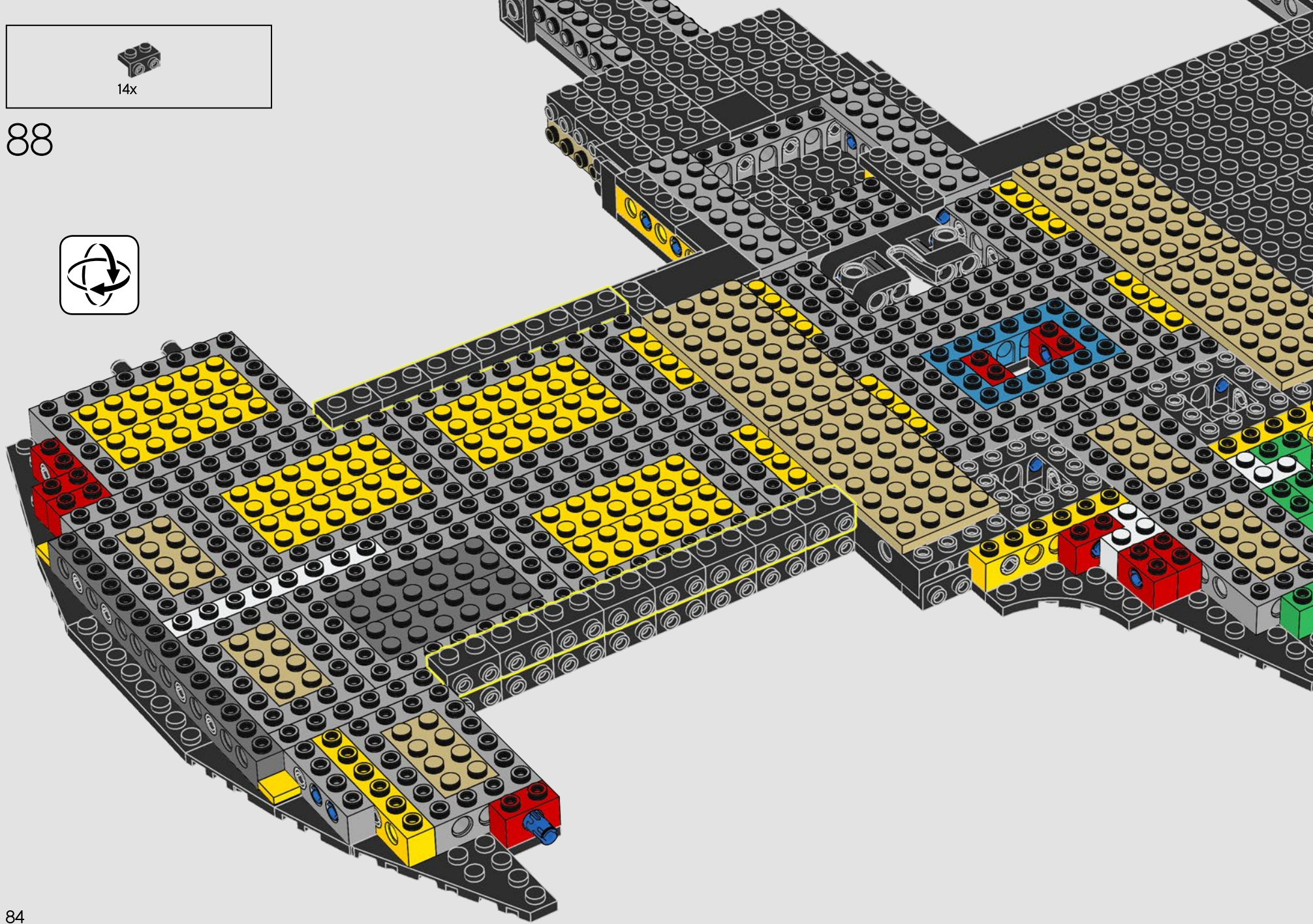

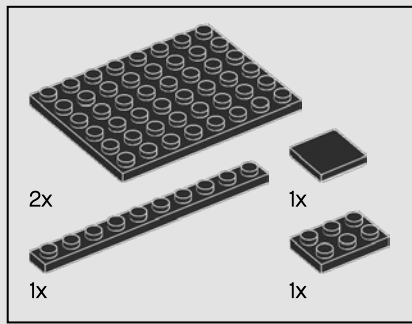

89

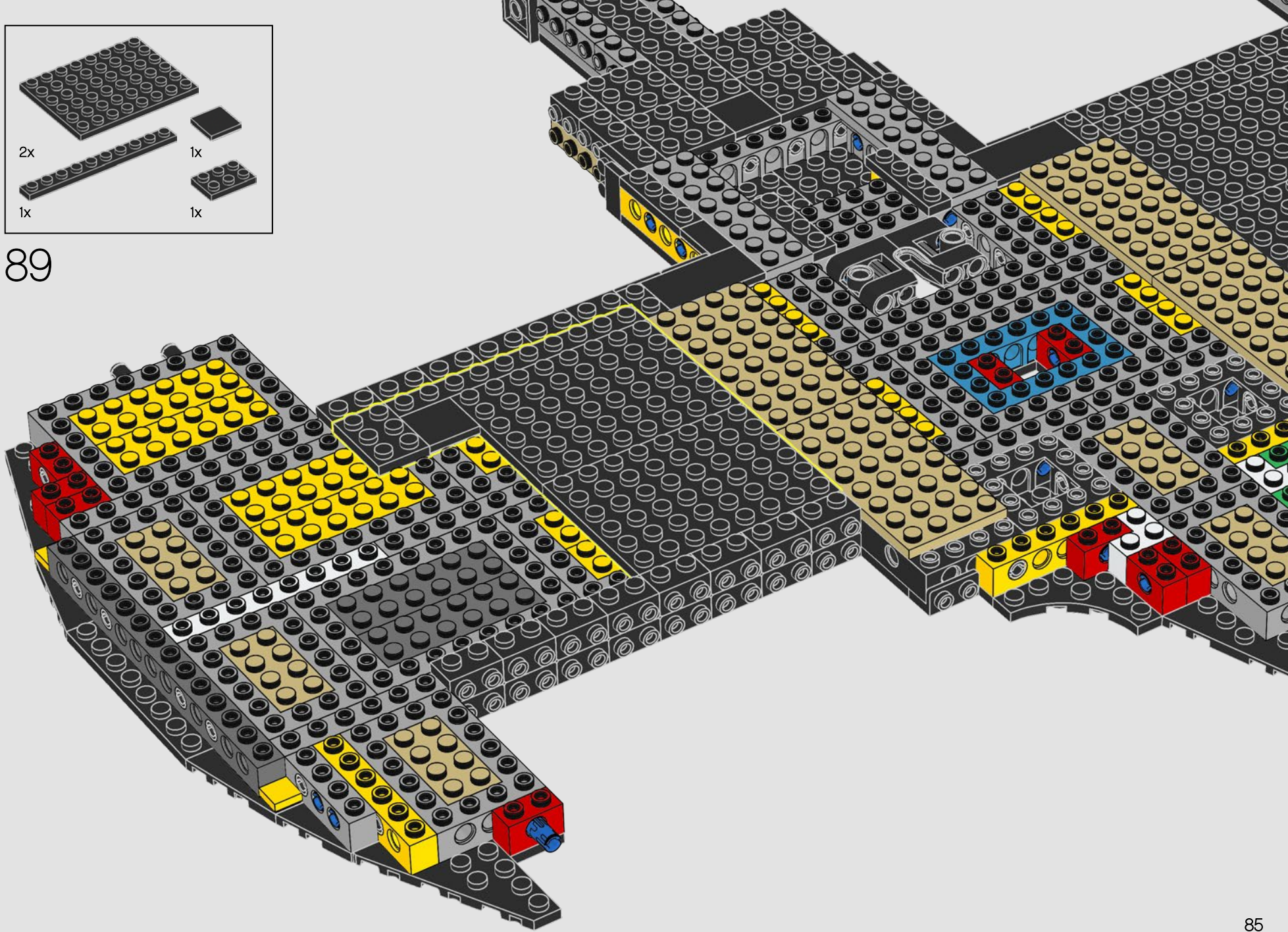



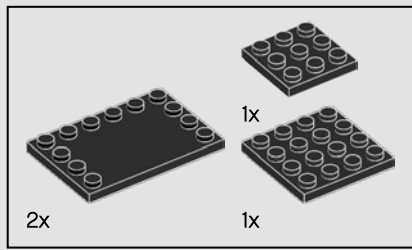

91

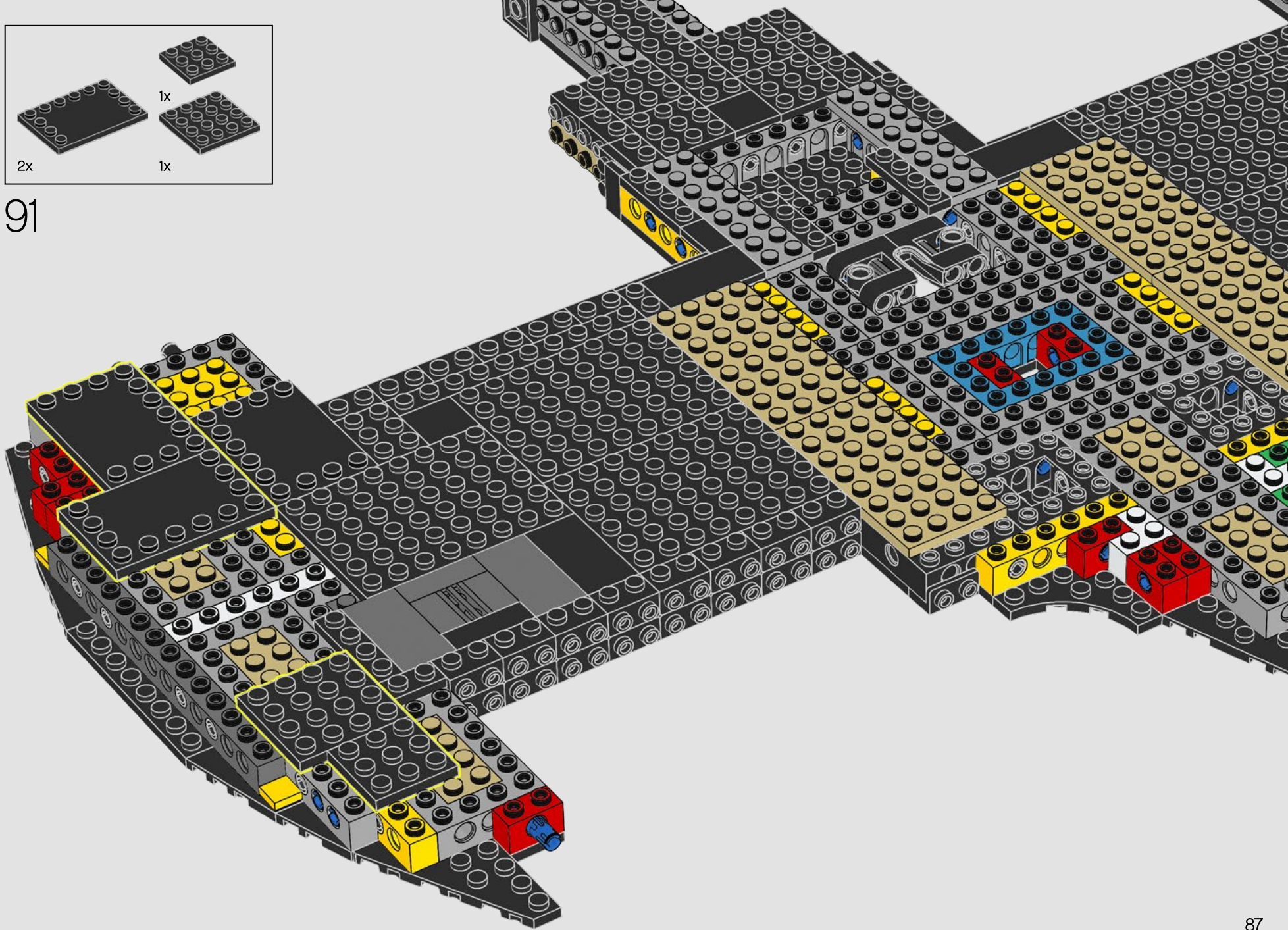

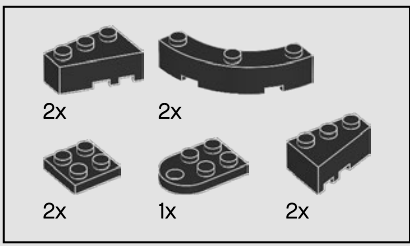

92

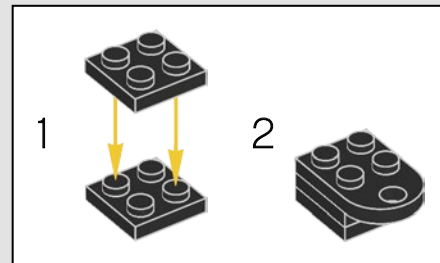
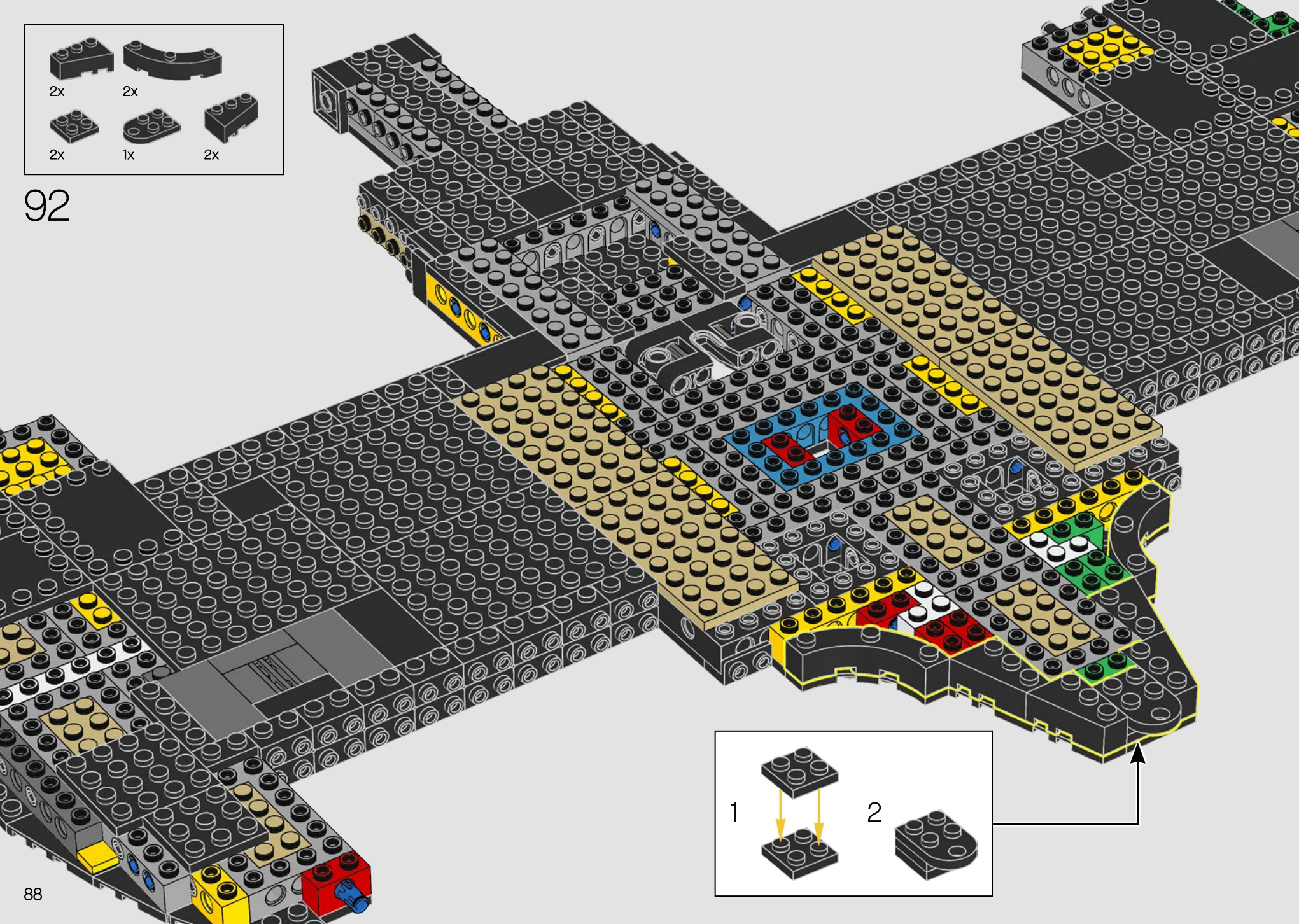



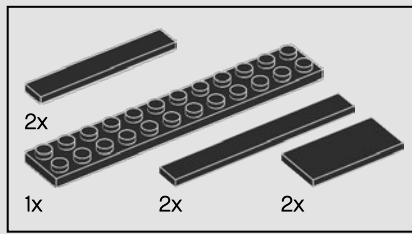

93

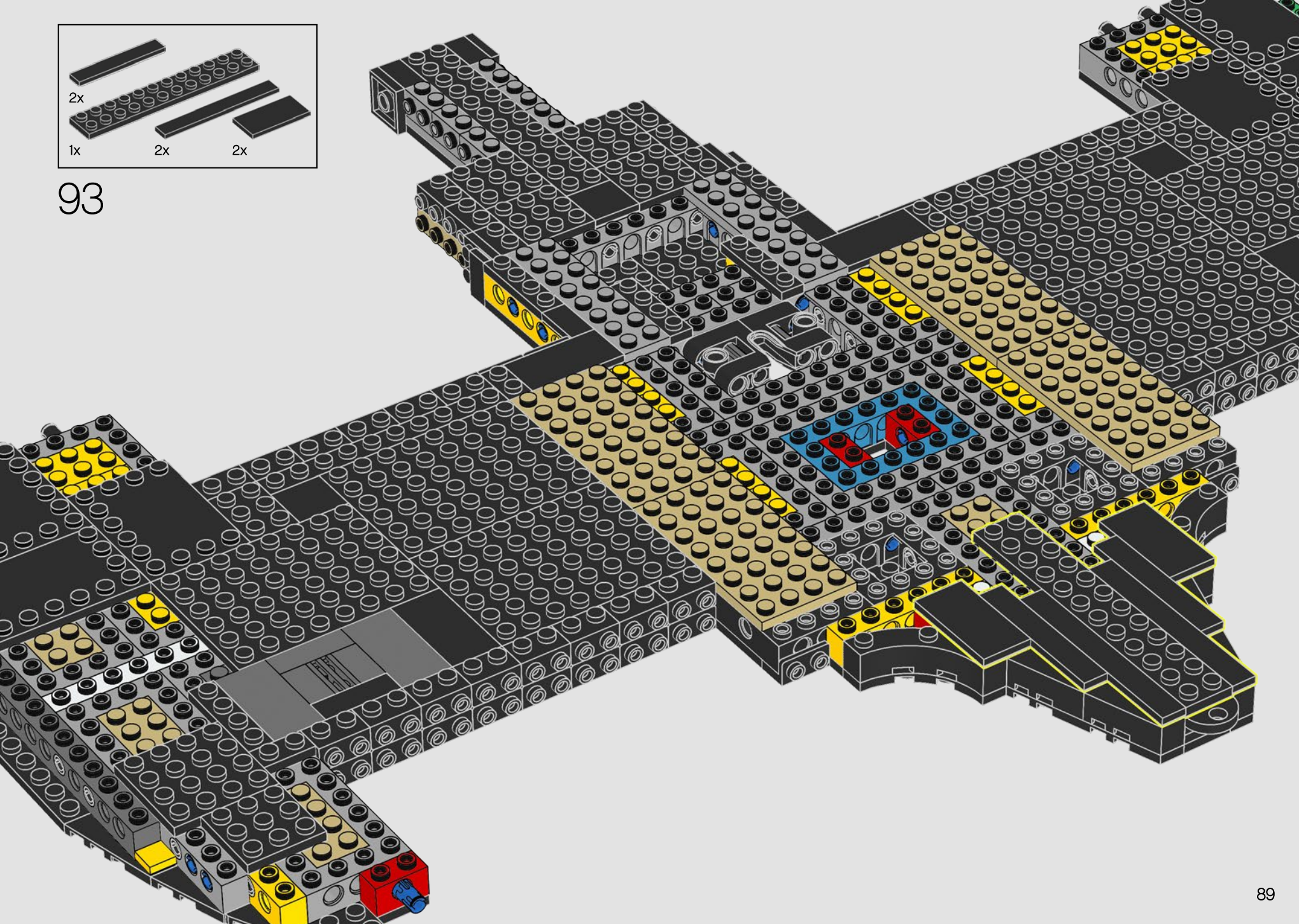

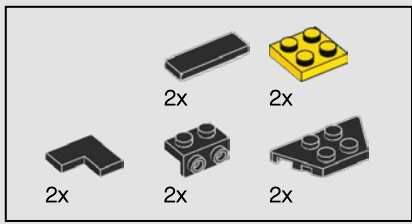

94

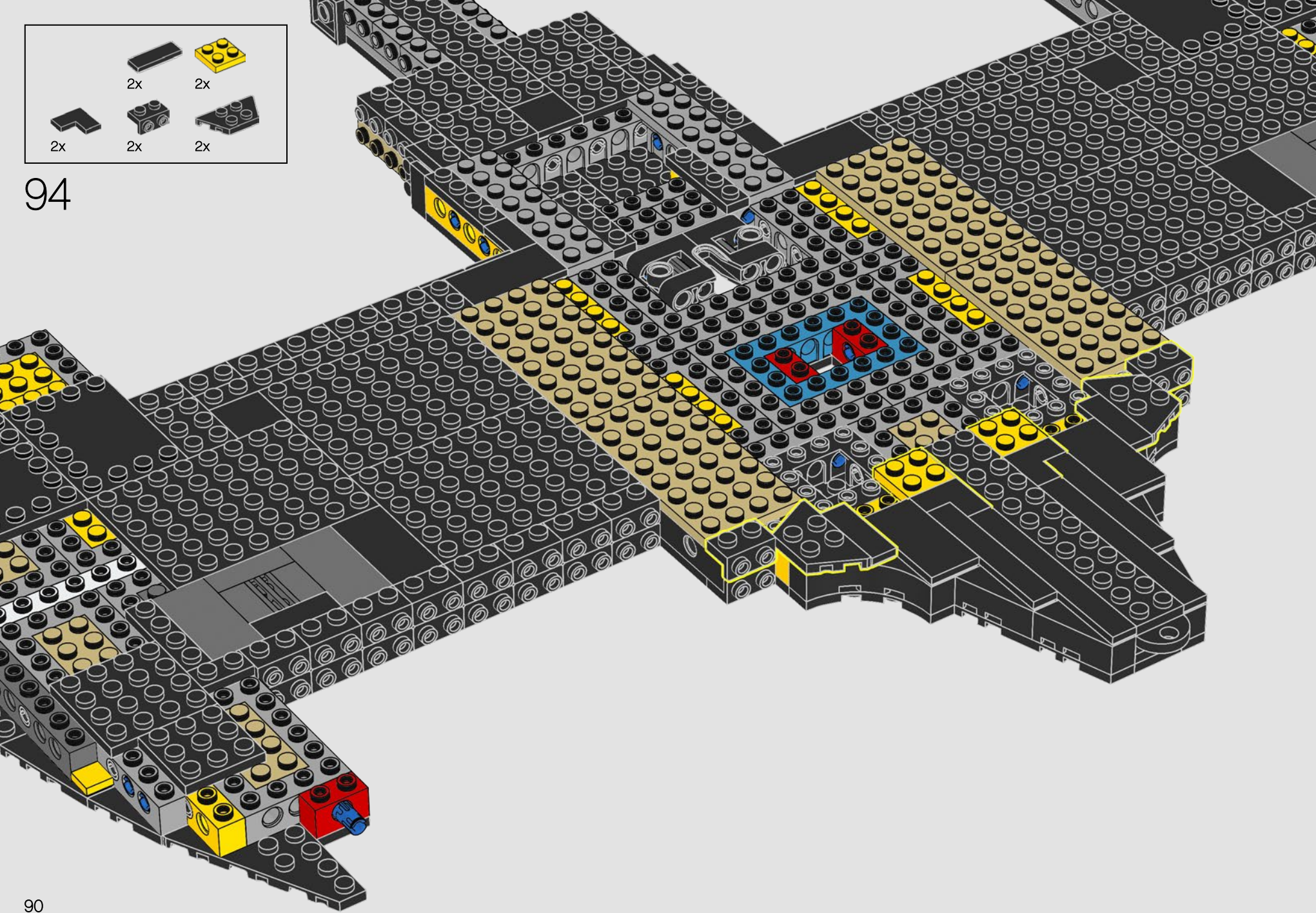

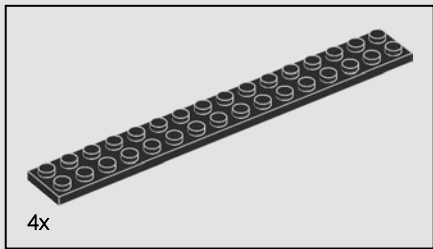

4x

95

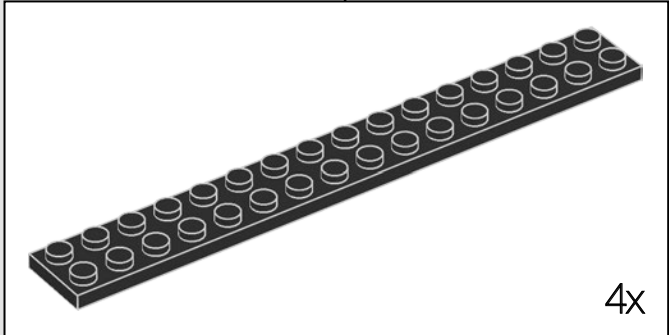
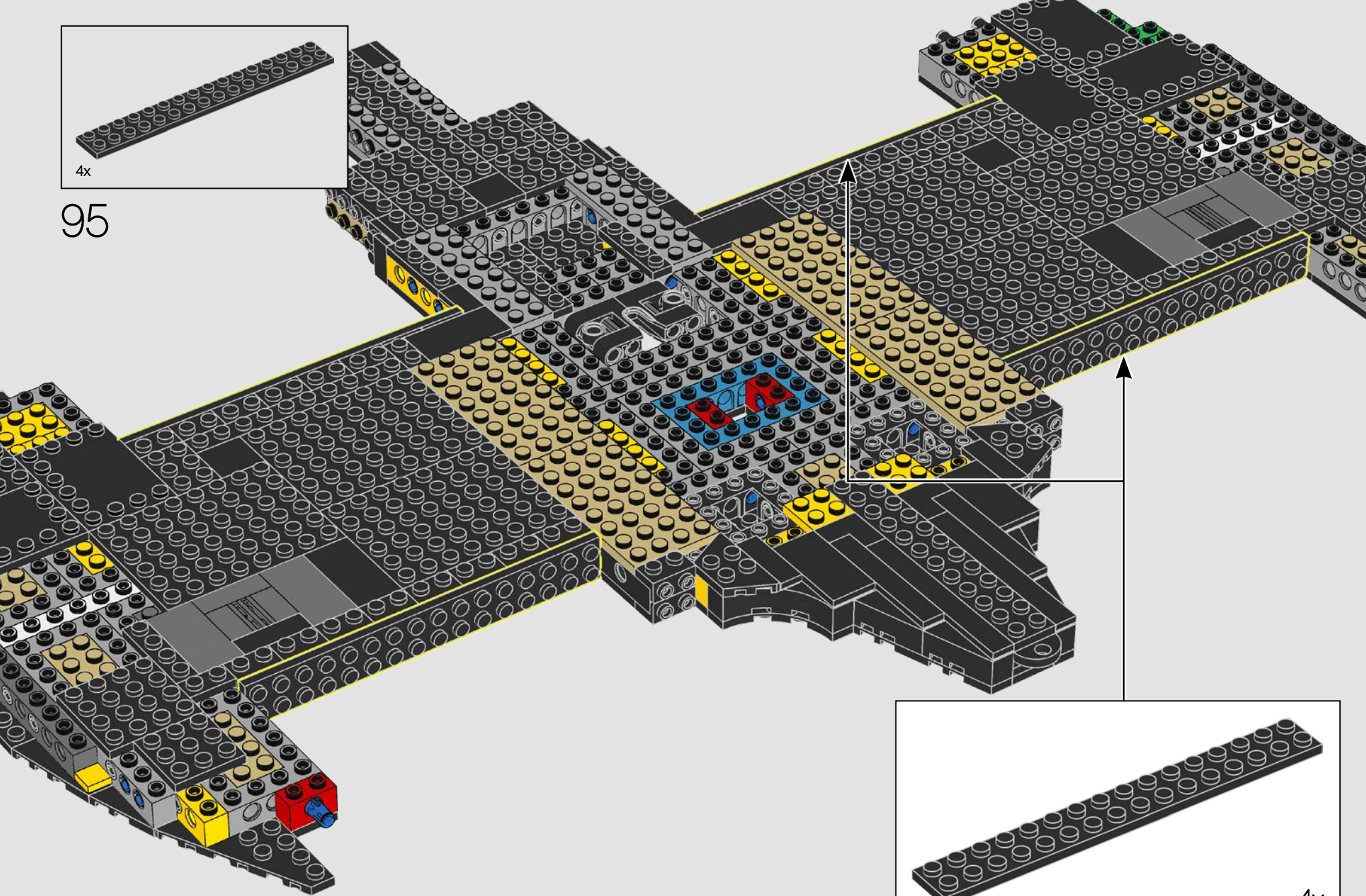

4x



4x

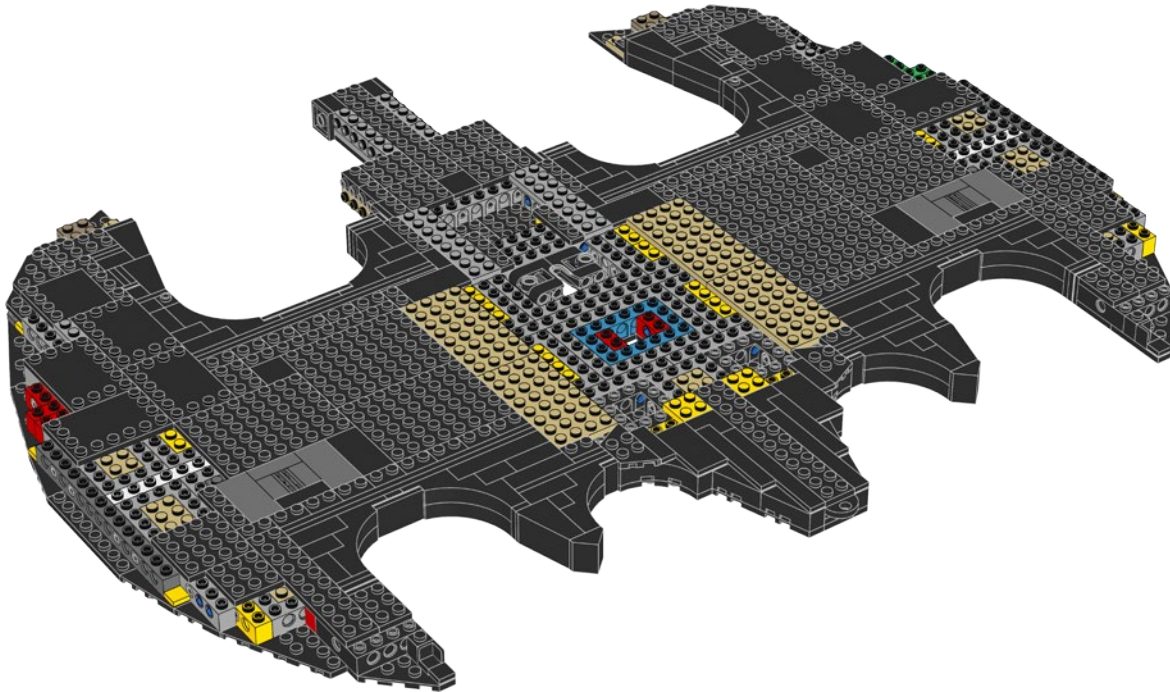
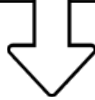

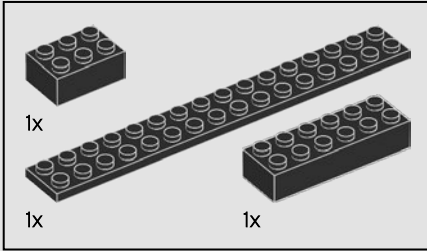
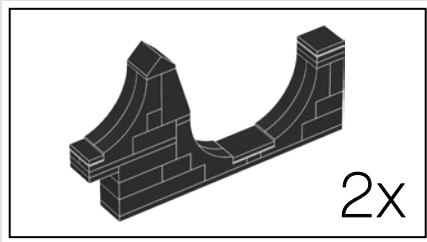

96

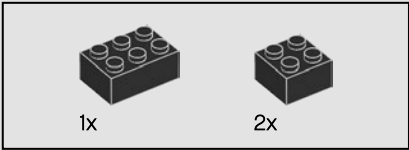
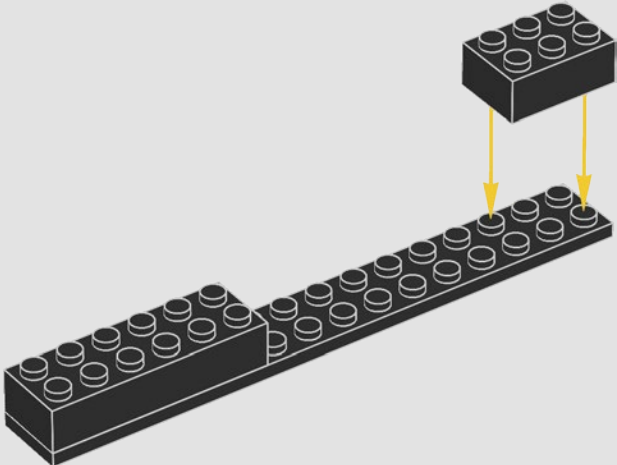

97

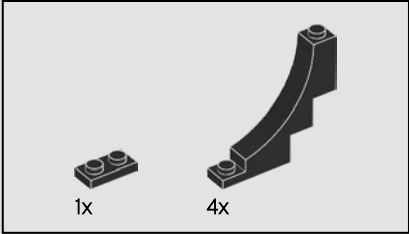
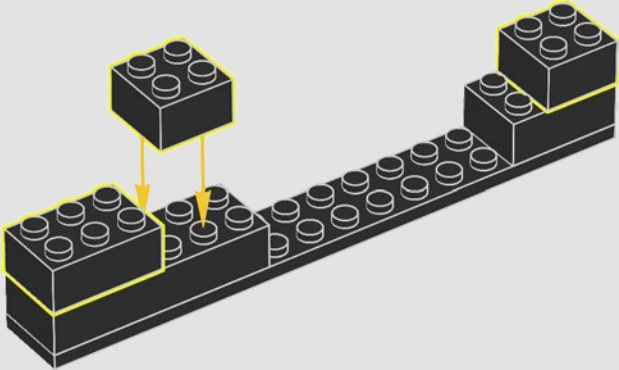

98

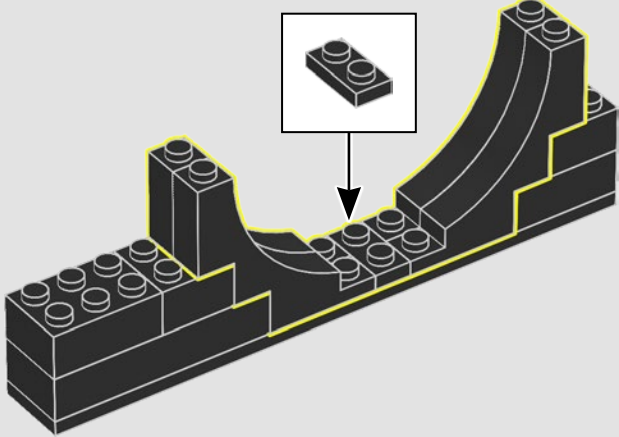

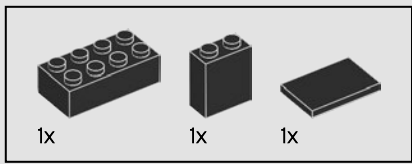

99

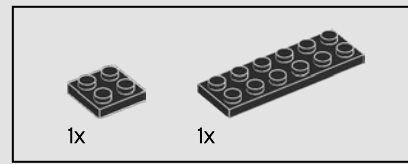
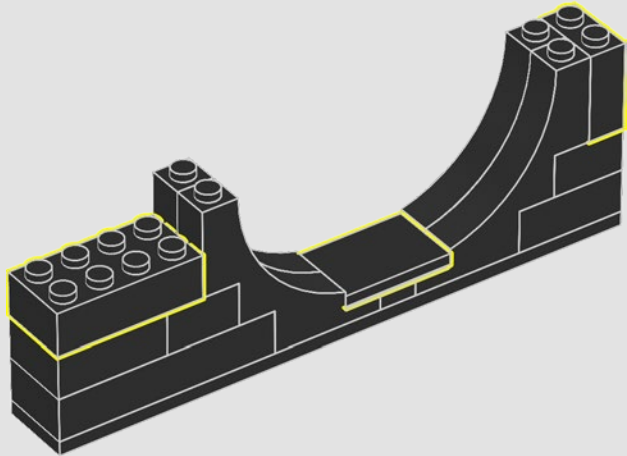

100

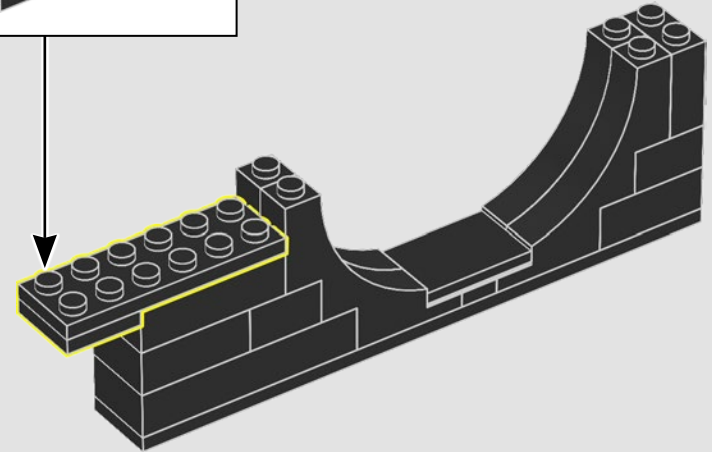
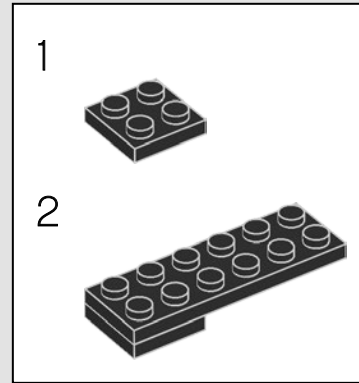

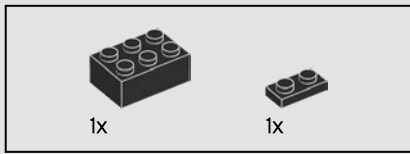

101

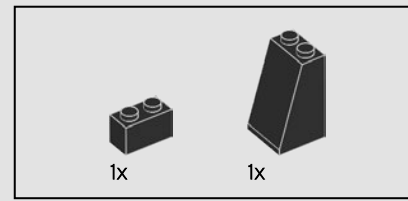
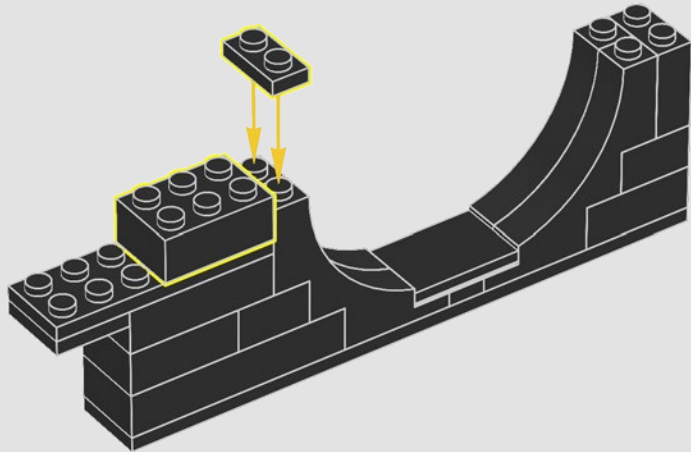

102

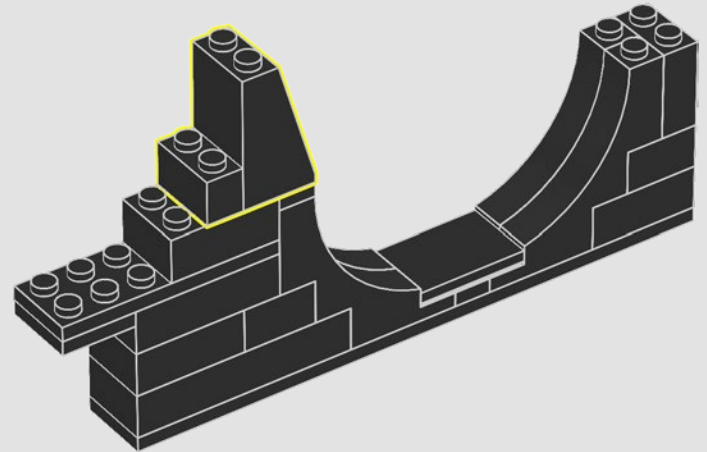

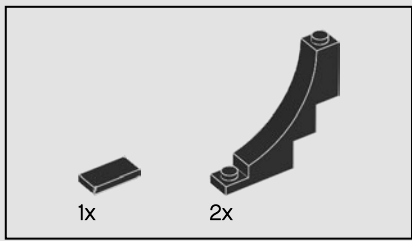

103

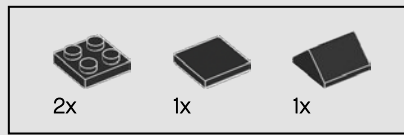
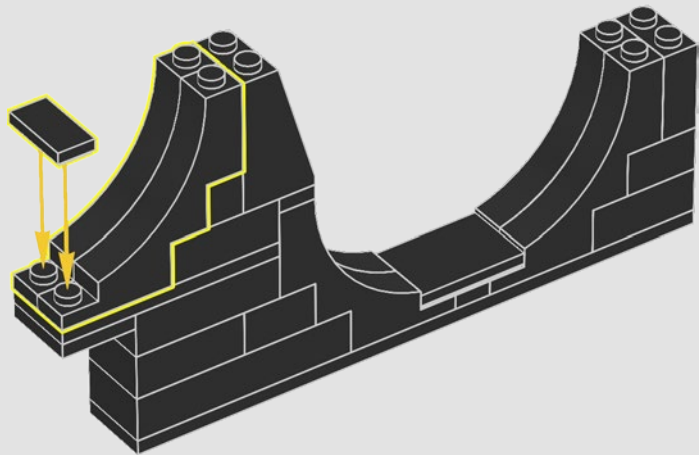

104

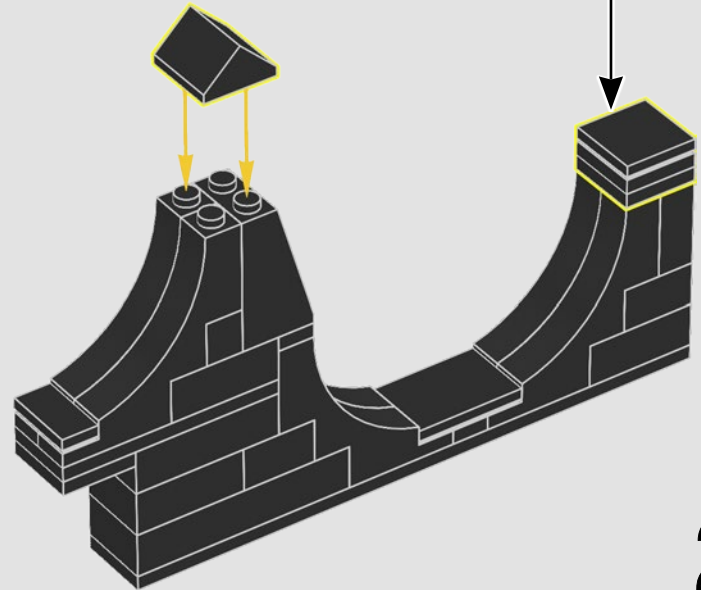
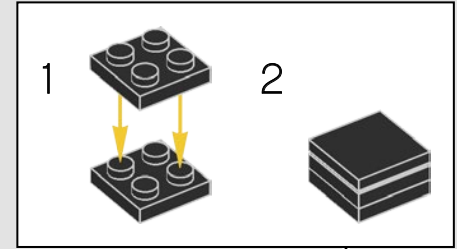

2x



105

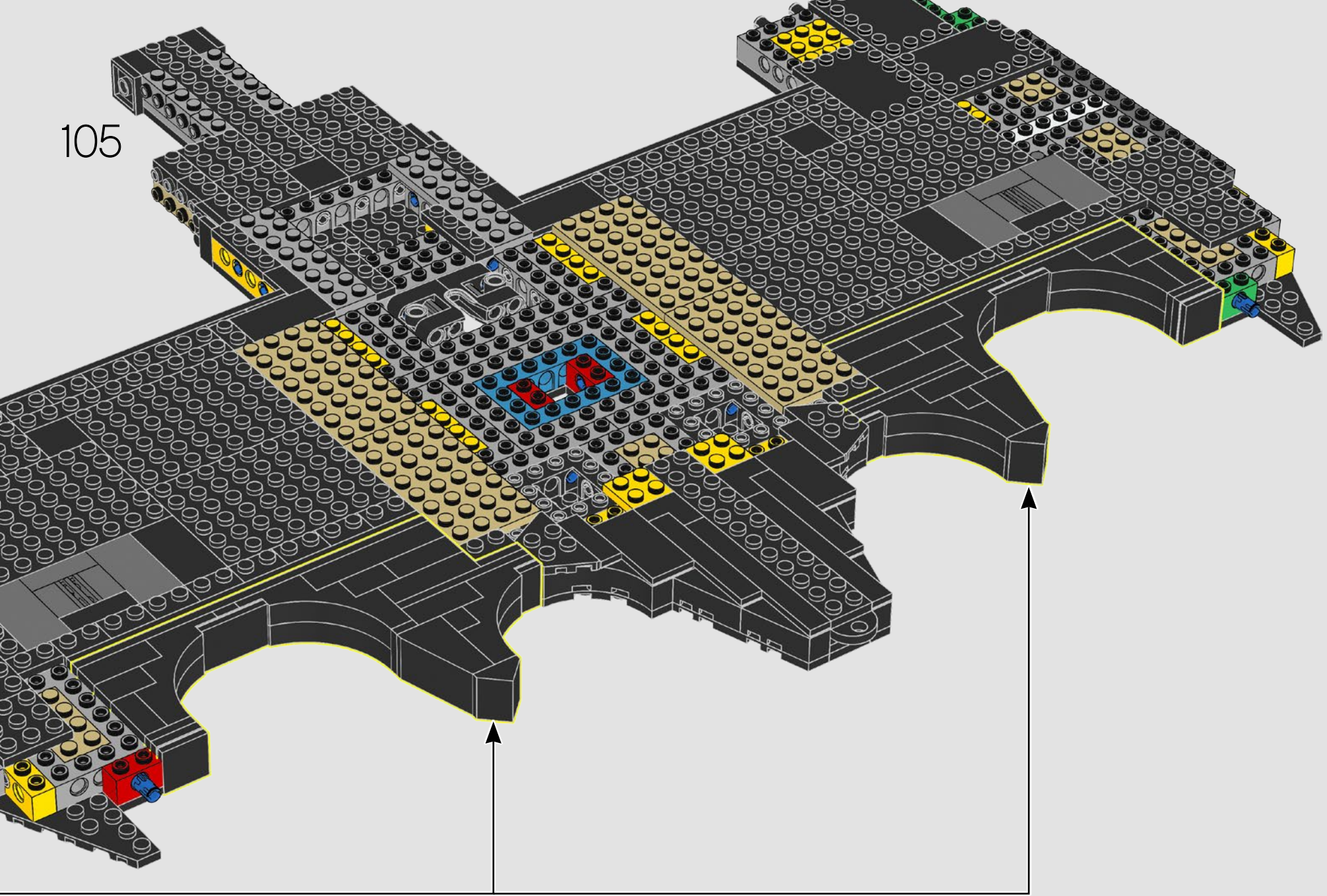

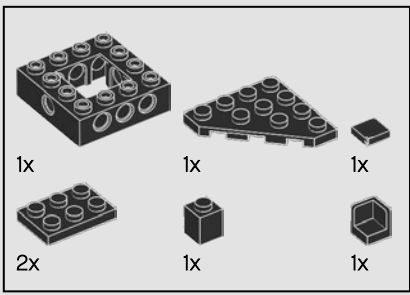

106

1

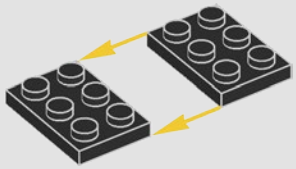

2

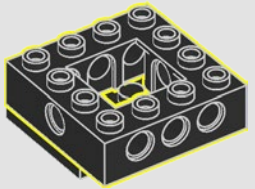

3

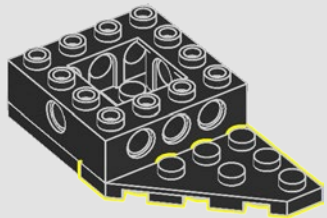

4

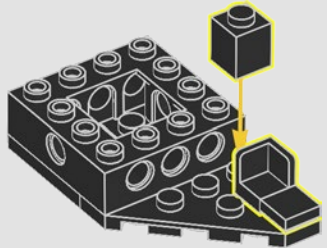

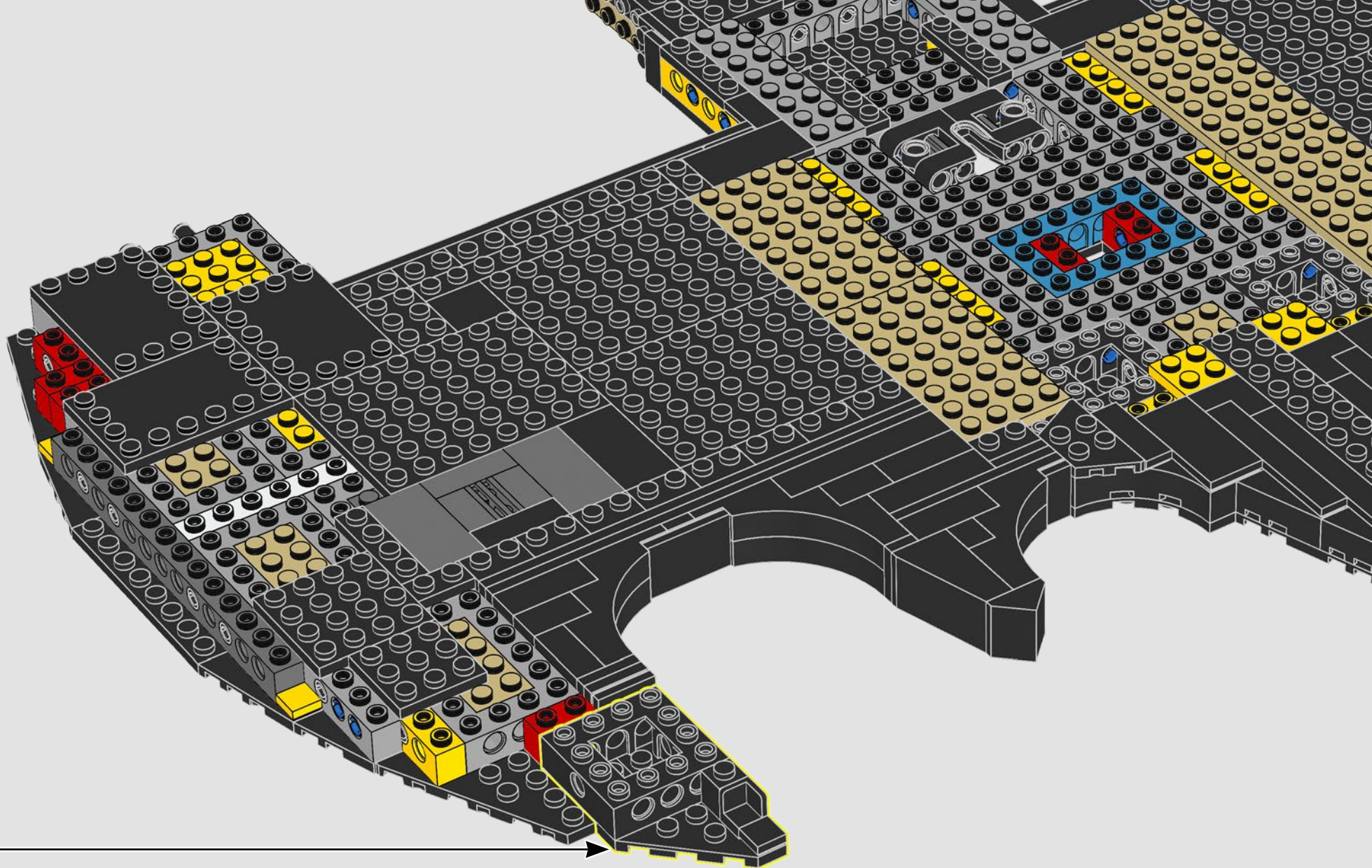

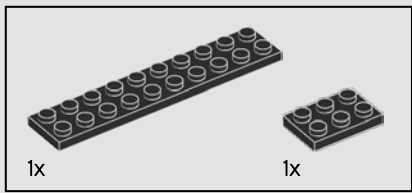

107

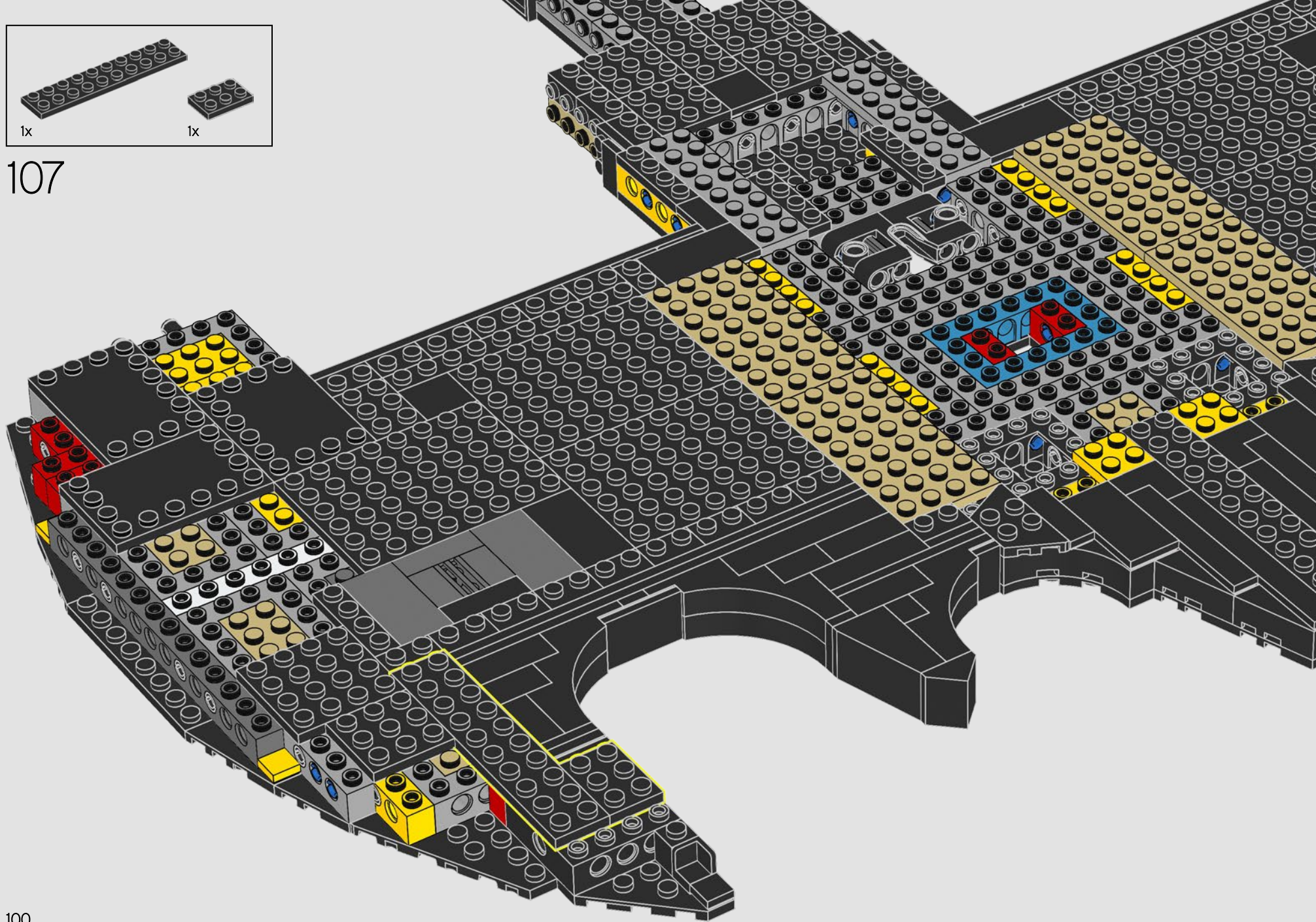

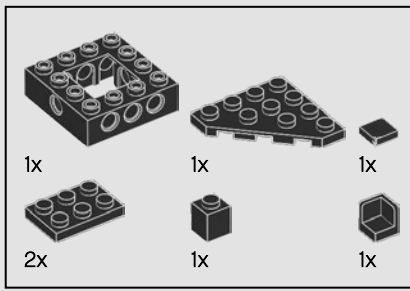

108

1

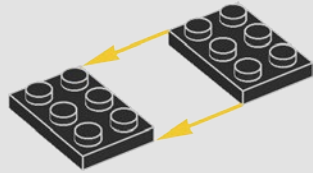

2

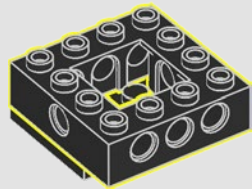

3

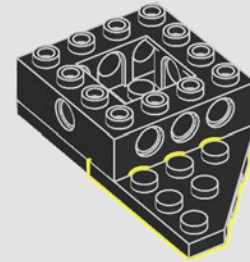

4

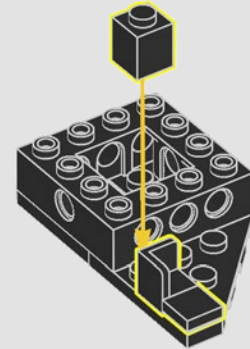

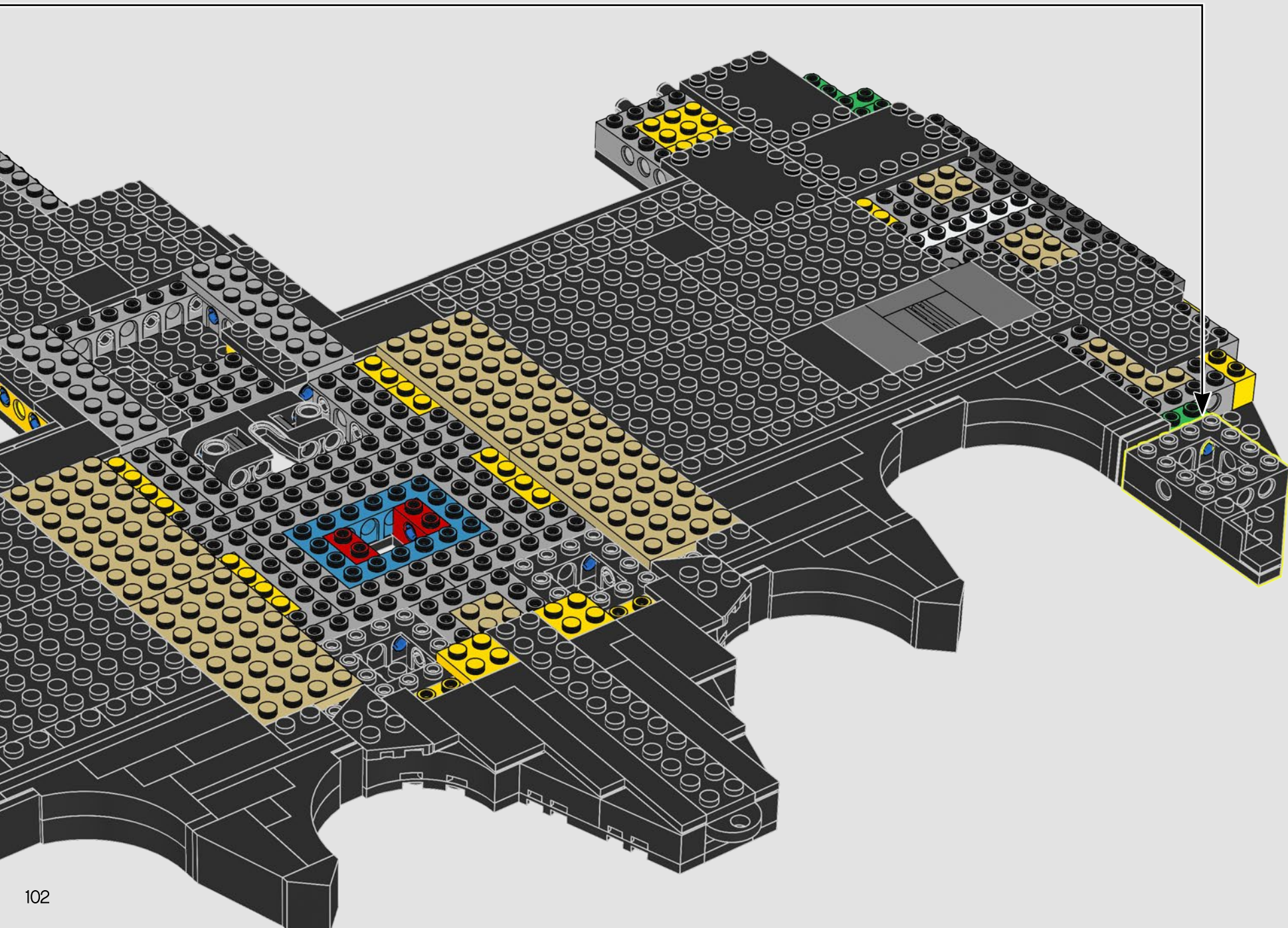

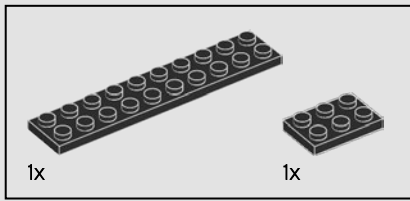

109

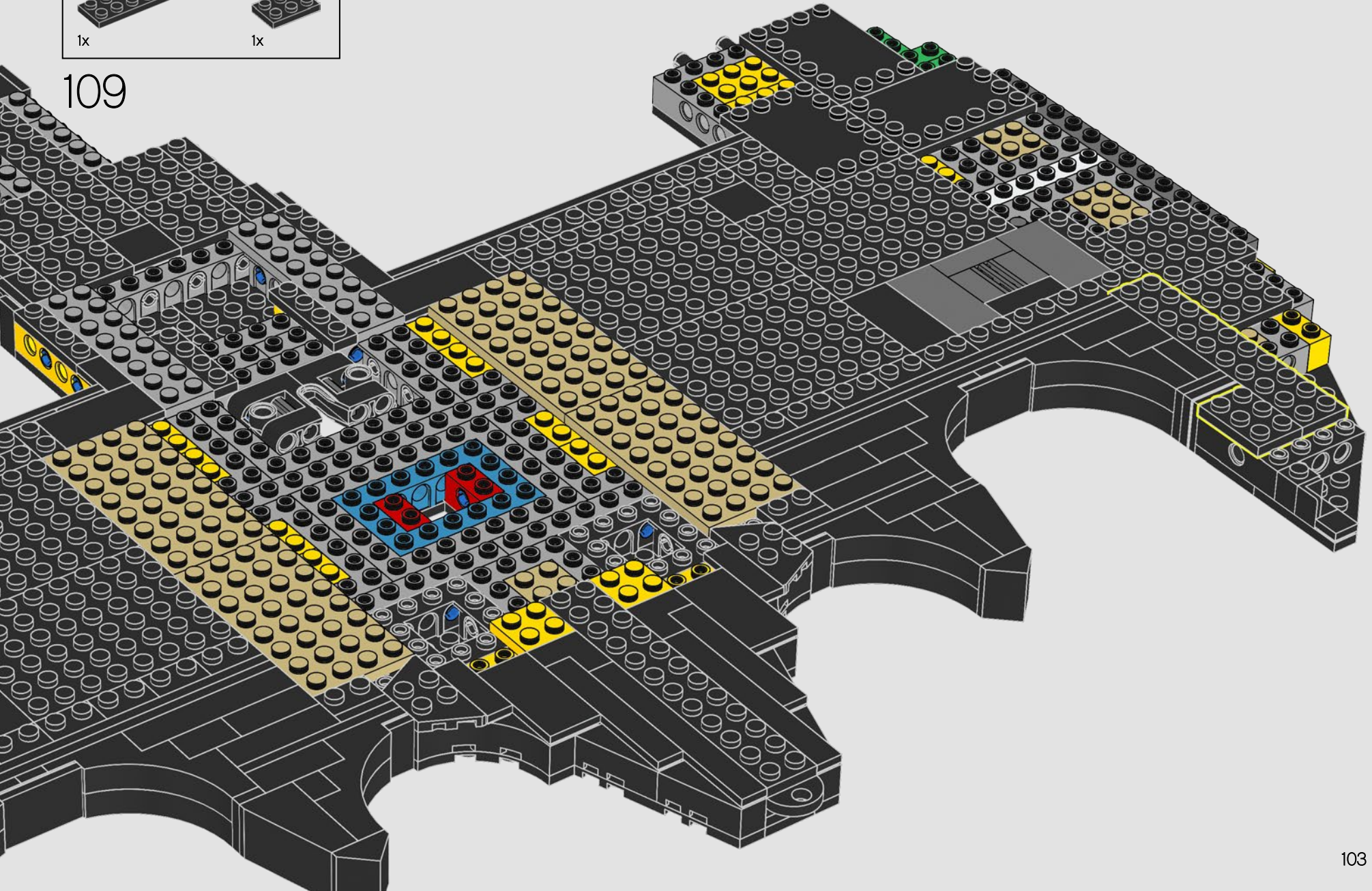

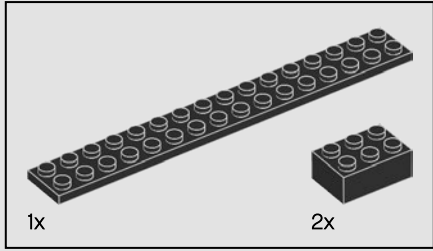
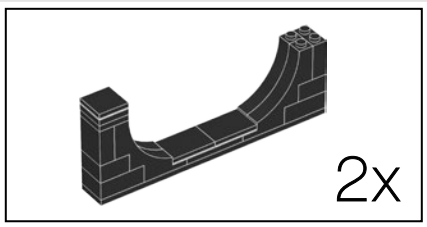

110

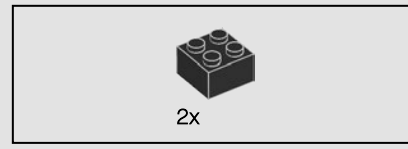
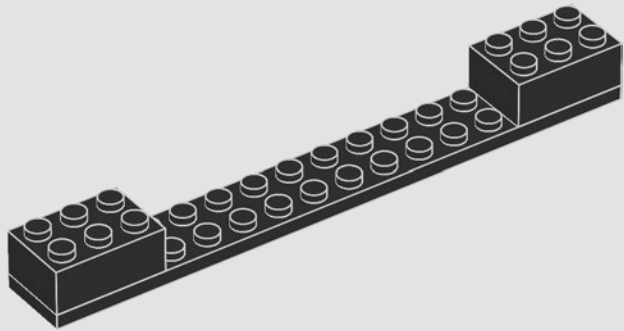

111

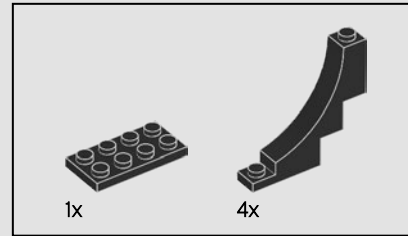
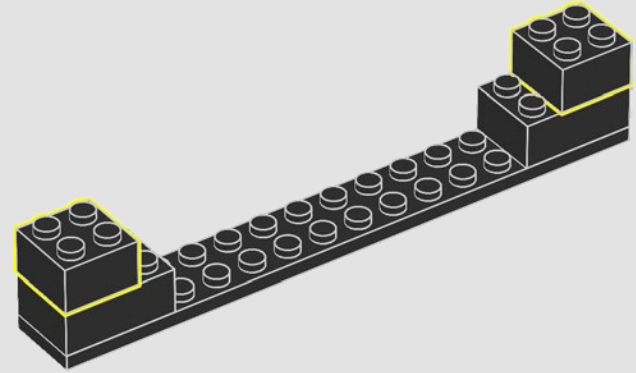

112

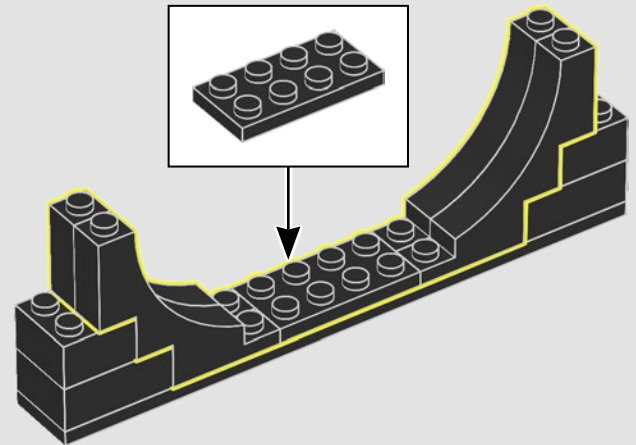



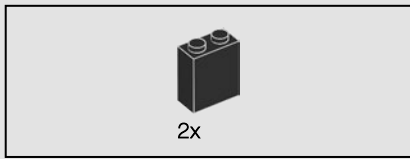

113

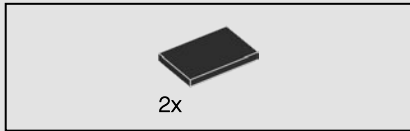
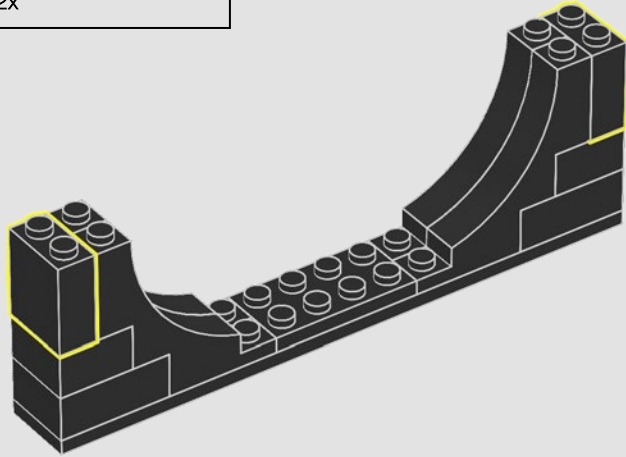

114

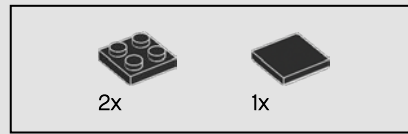
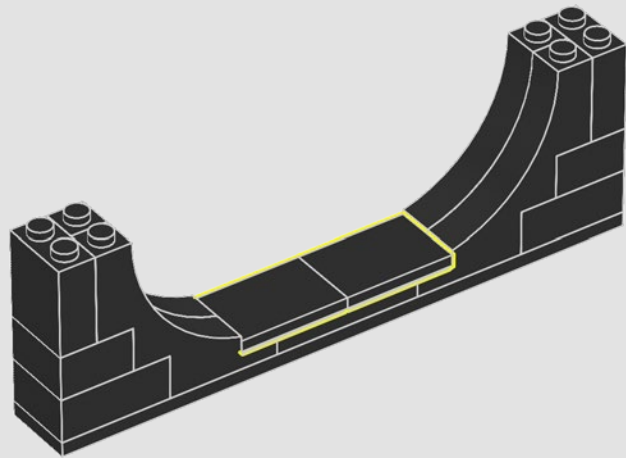

115

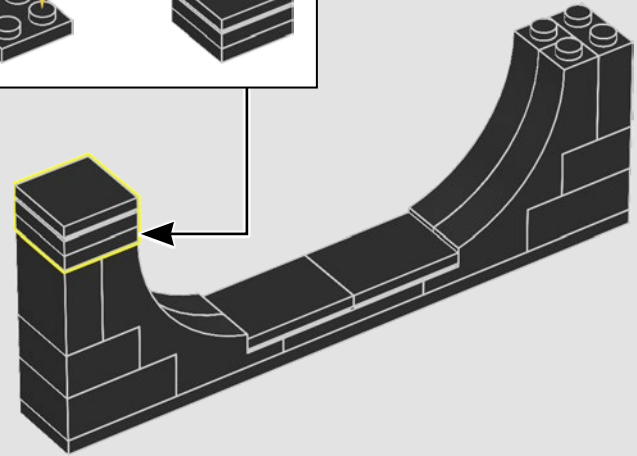
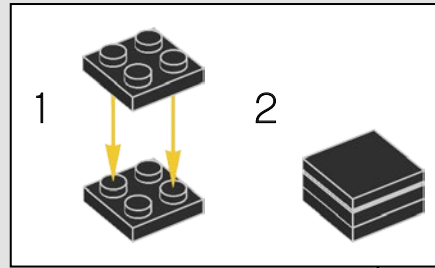

2x

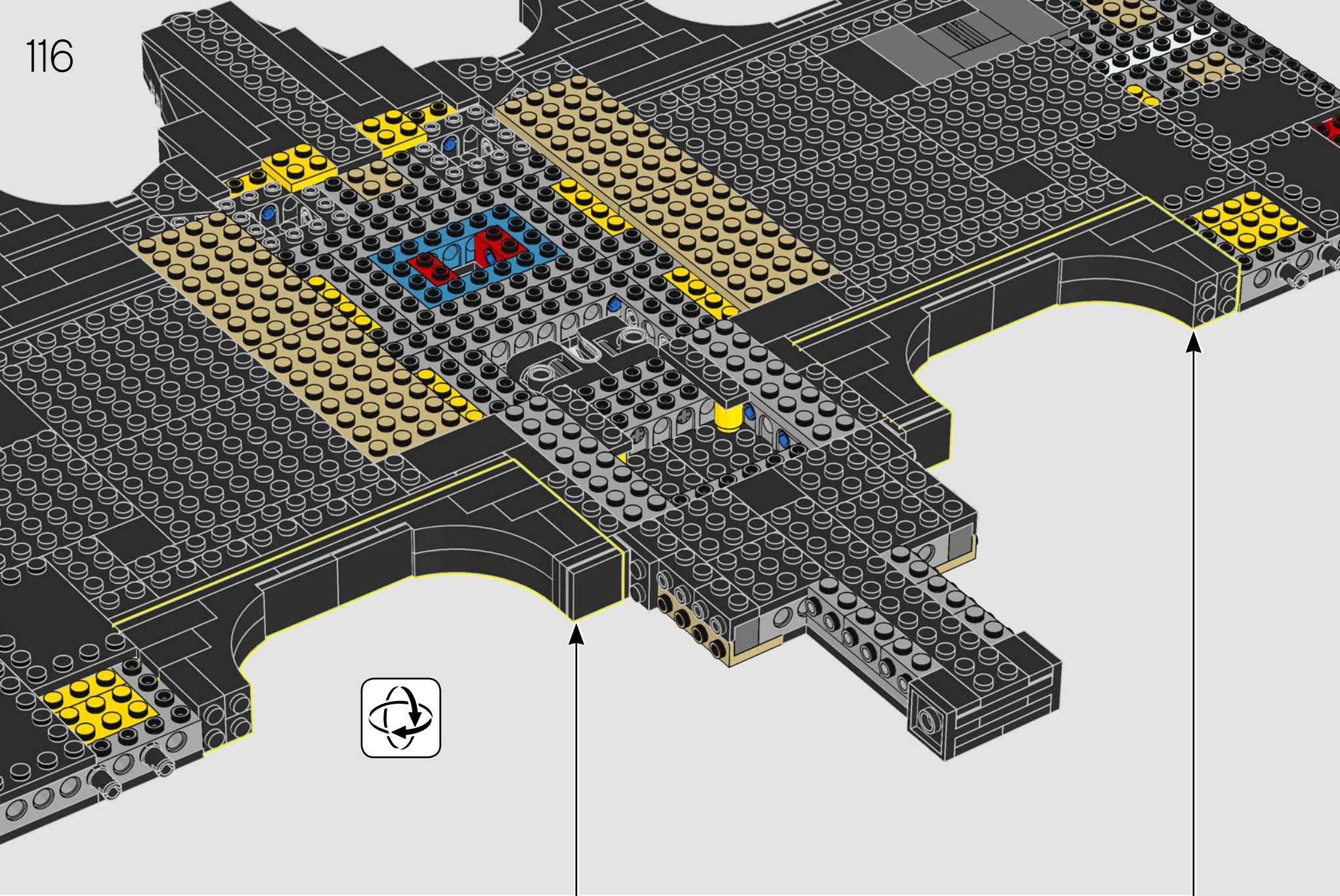

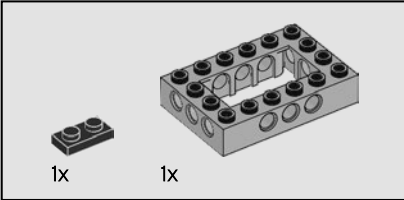
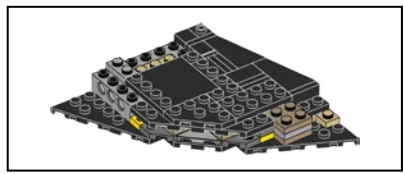

117

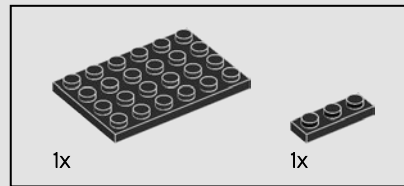
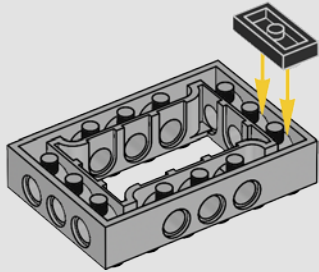

118

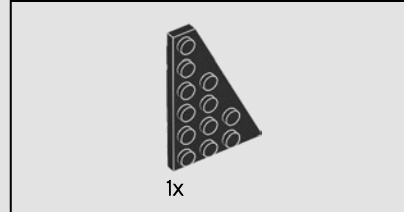
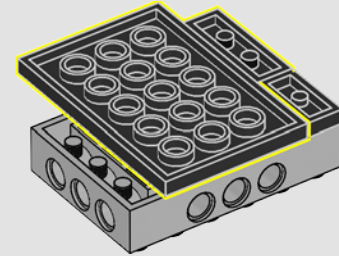

119

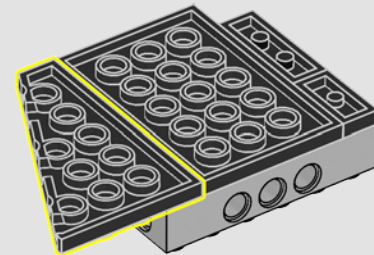

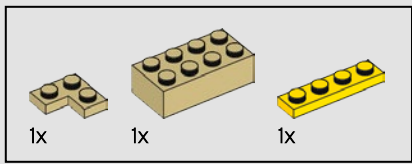

120

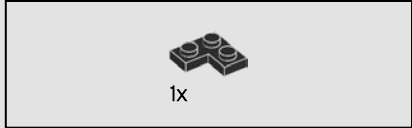
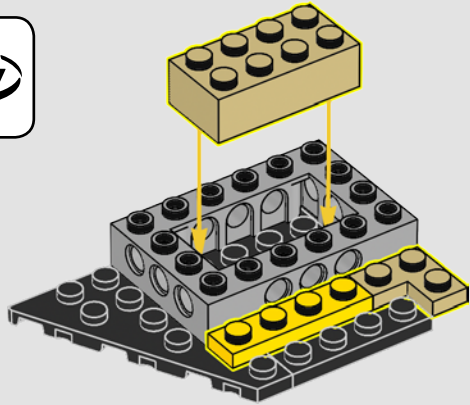

121

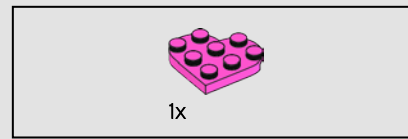
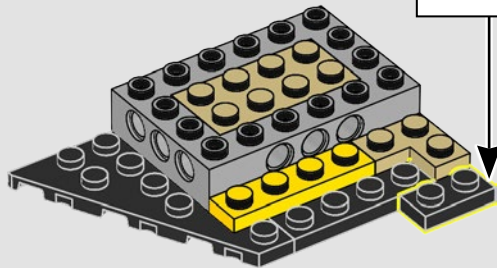
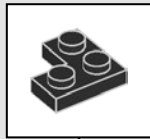

122

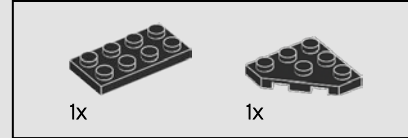
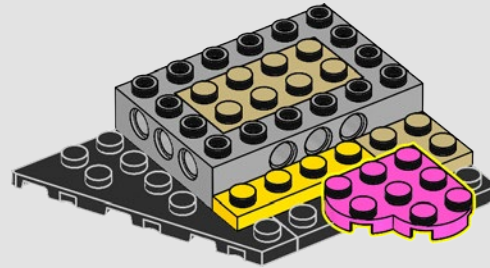

123

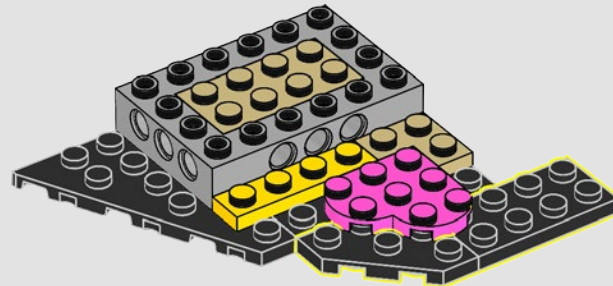

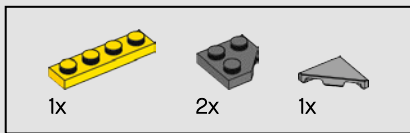

124

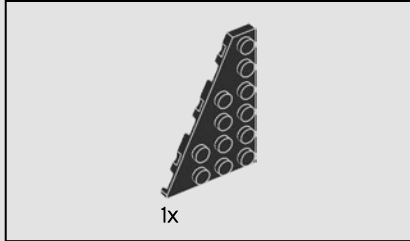
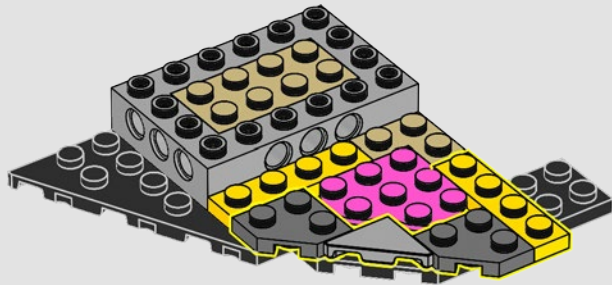

125

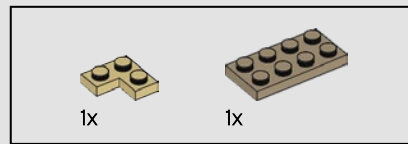
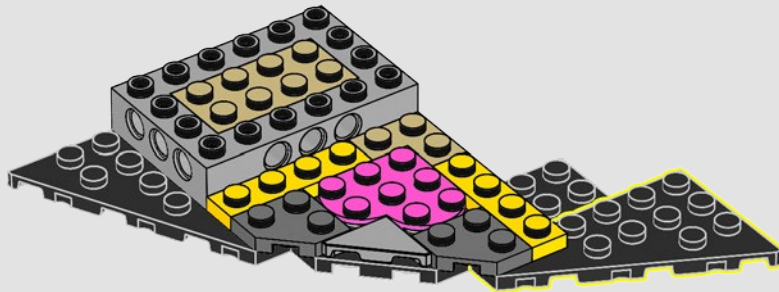

126

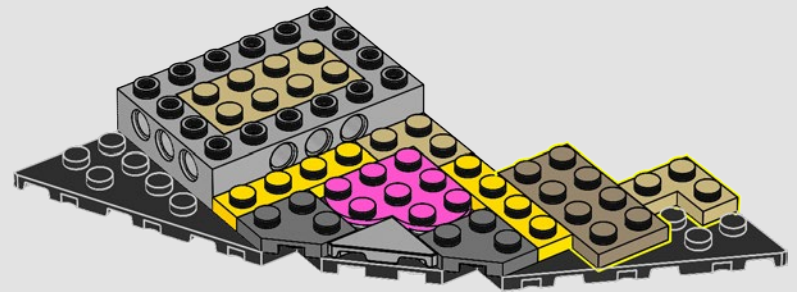

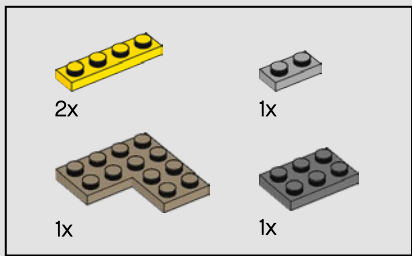

127

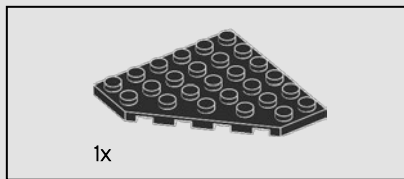
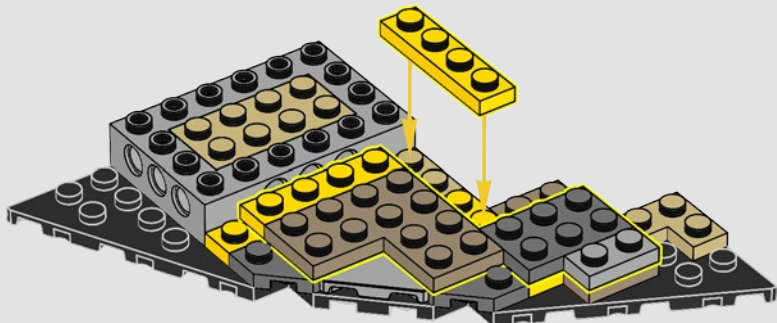

128

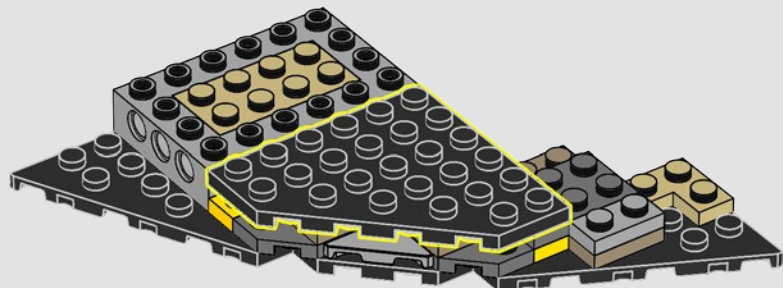

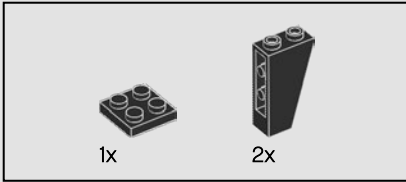
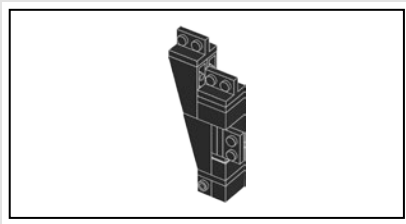

129

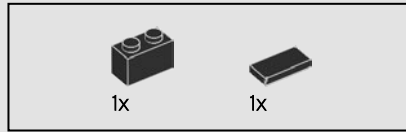
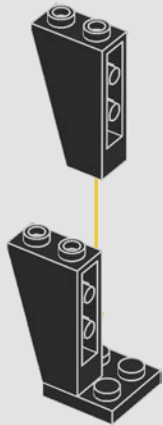

130

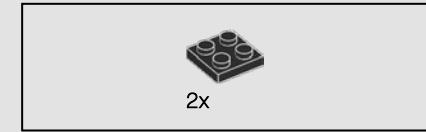
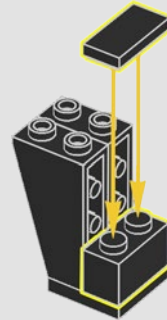

131

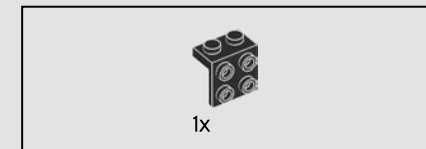
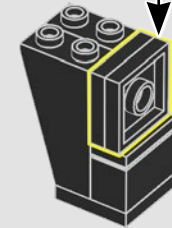
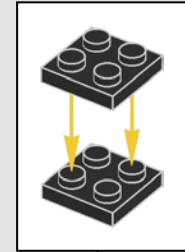

132

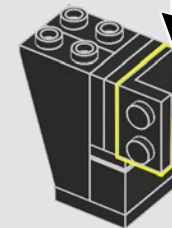
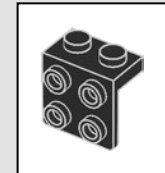

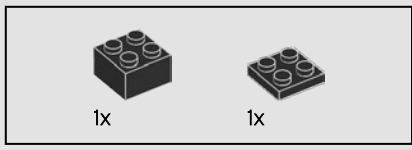

133

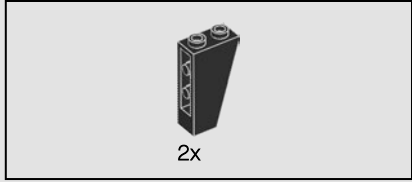
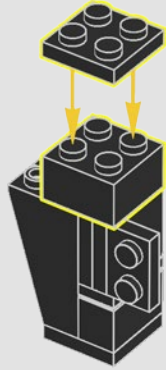

134

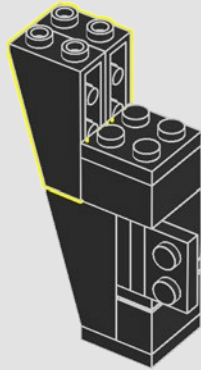

135

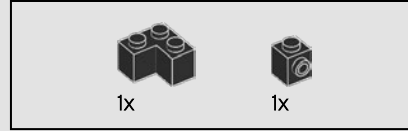
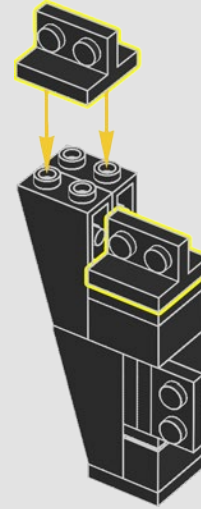

136

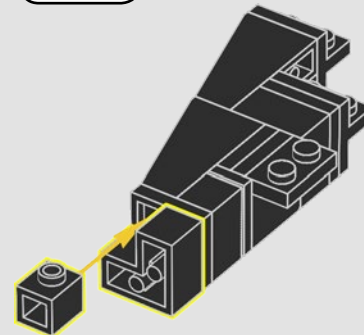
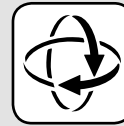



137

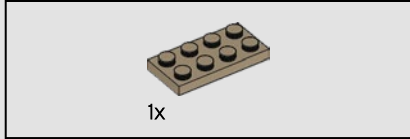
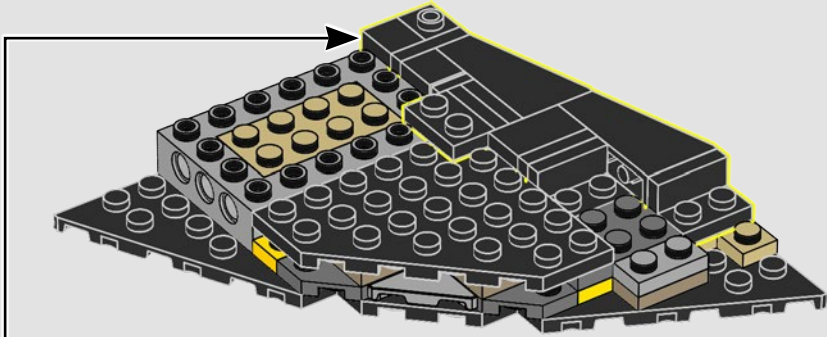

138

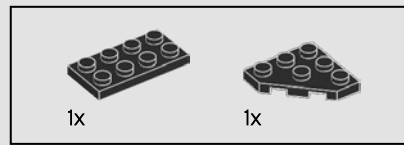
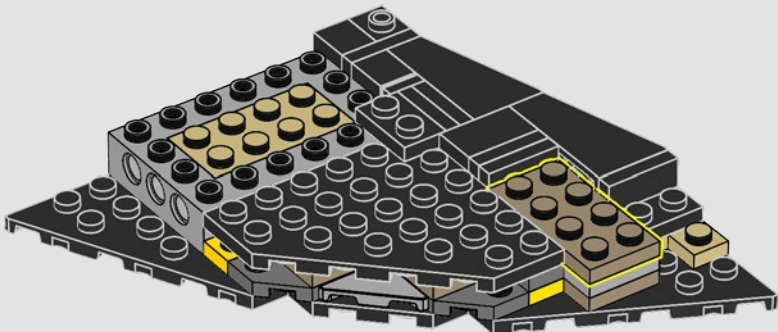

139

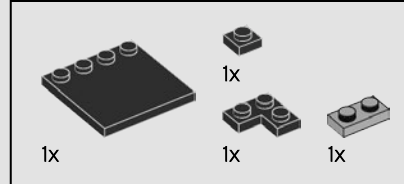
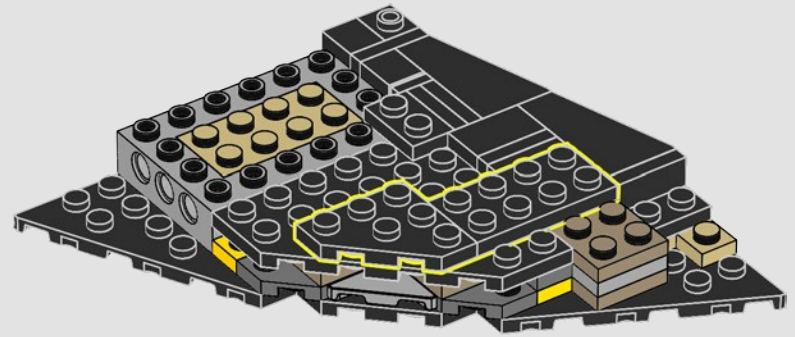

140

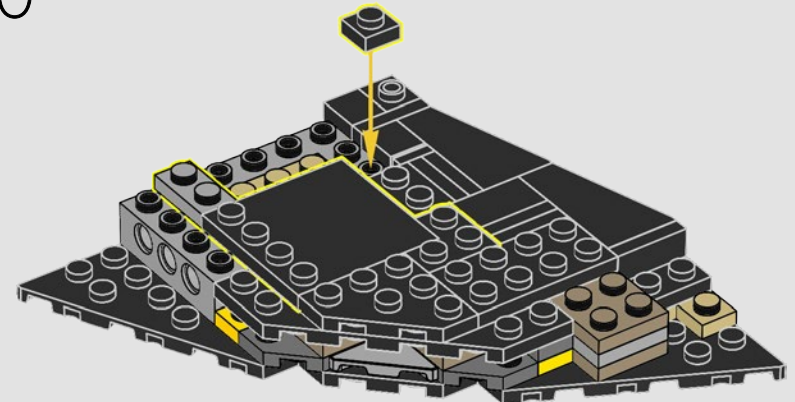

141

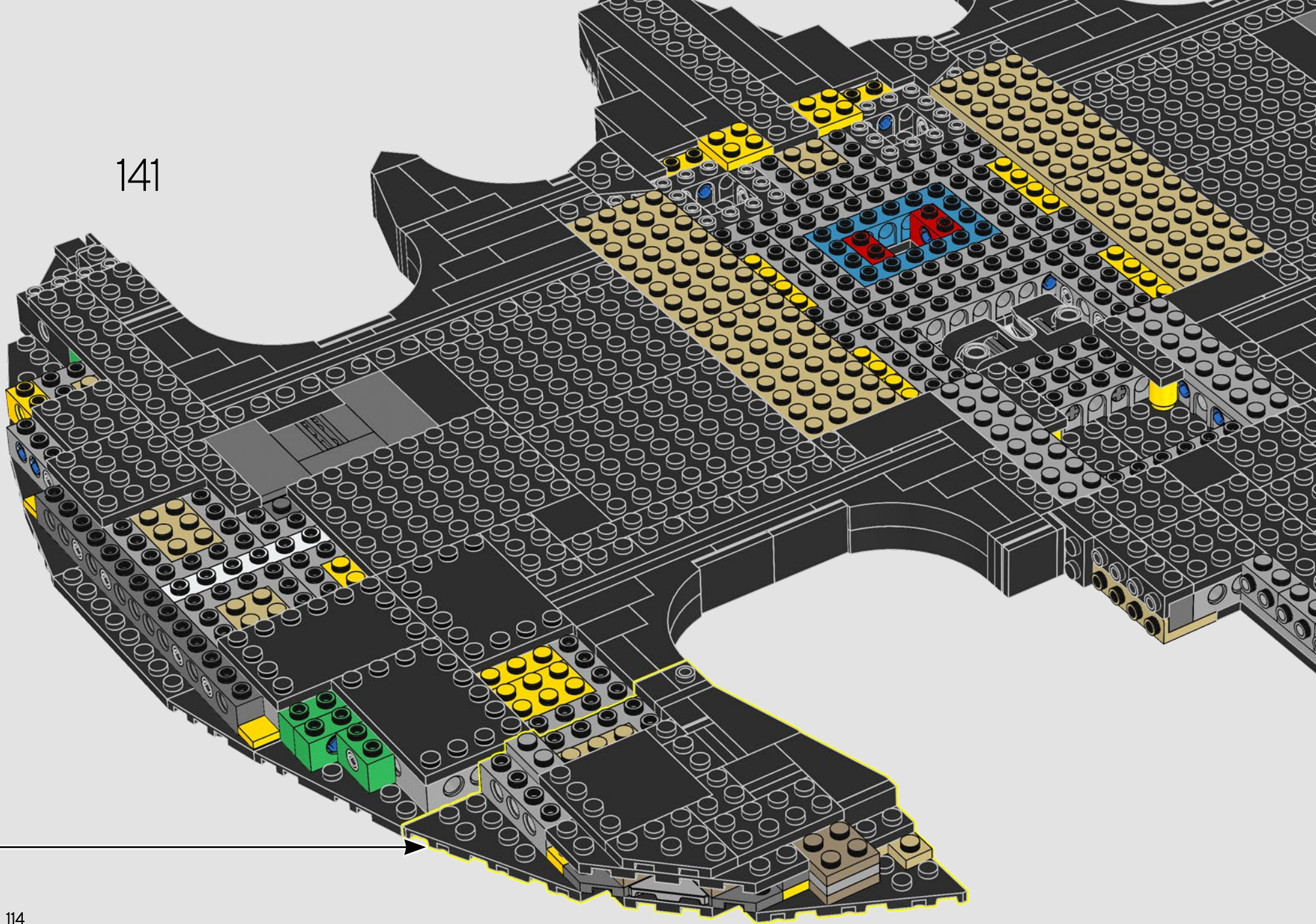

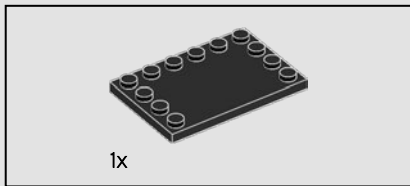

142

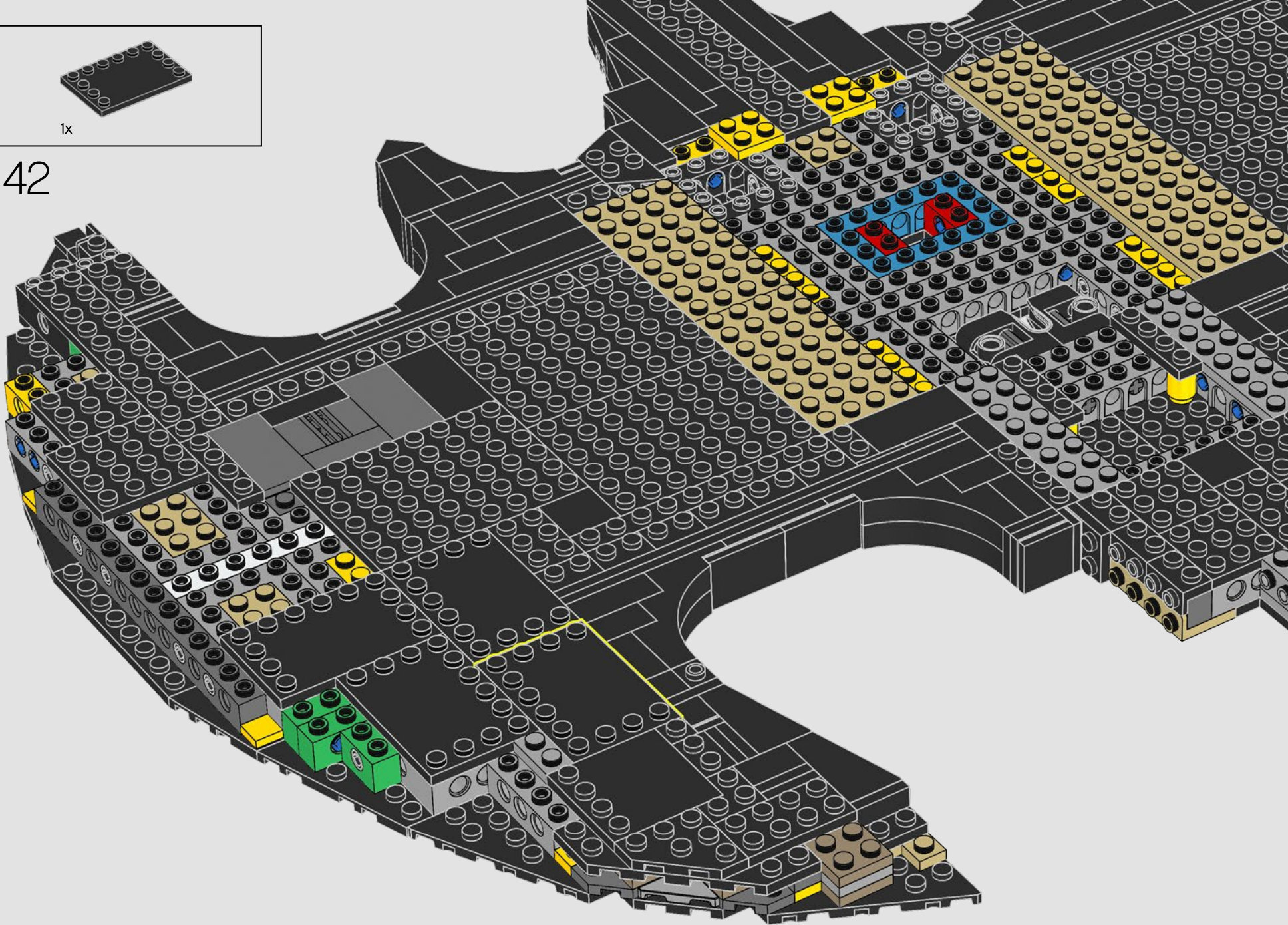

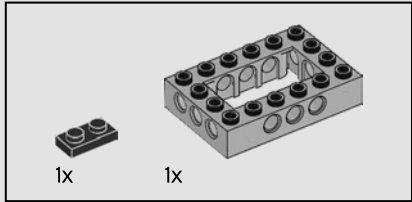
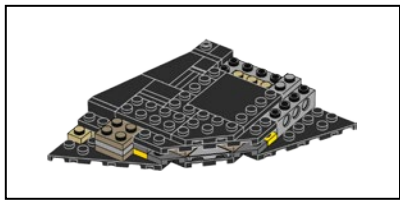

143

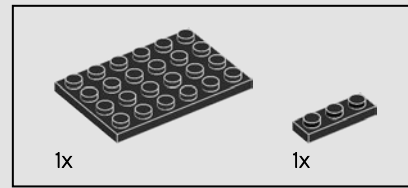
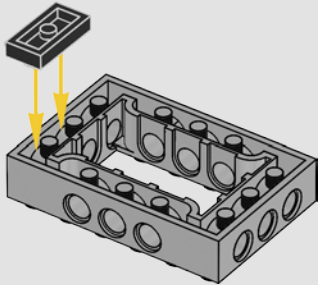

144

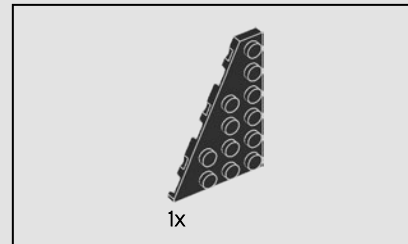
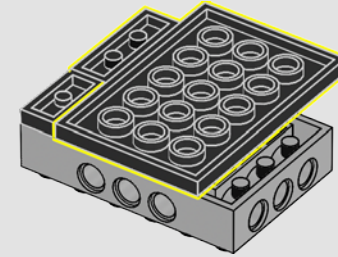

145

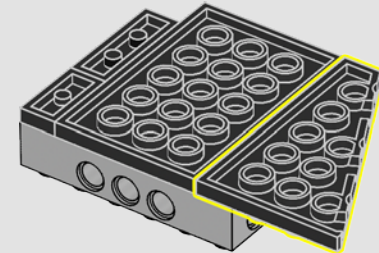

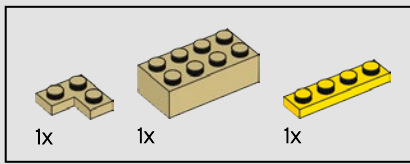

146

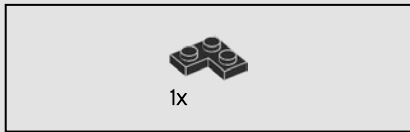
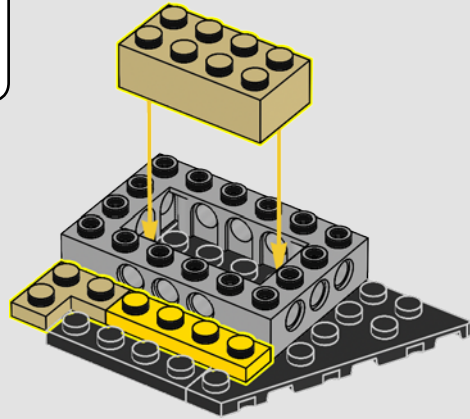

147

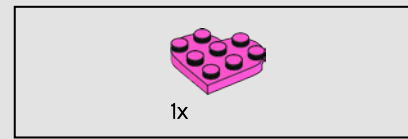
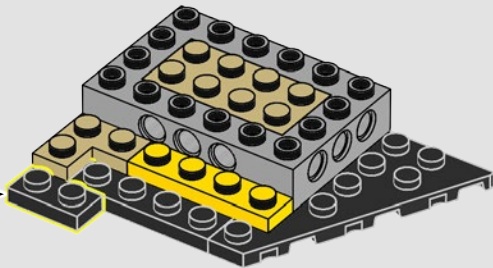
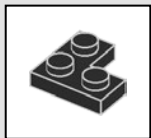

148

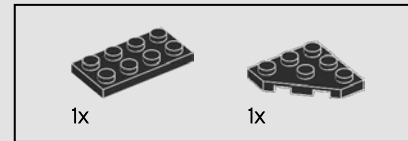
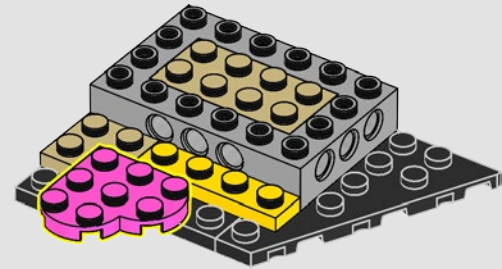

149

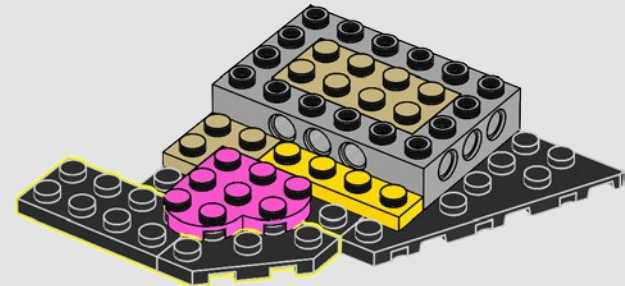

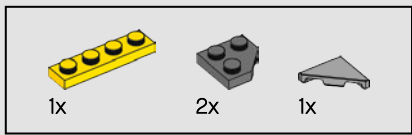

150

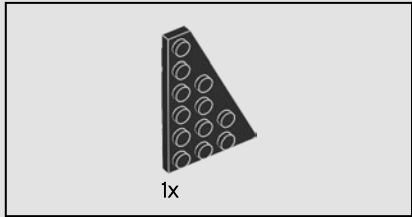
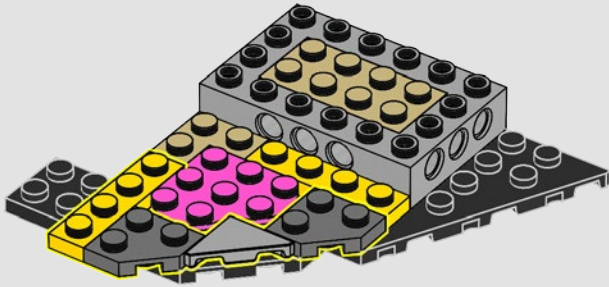

151

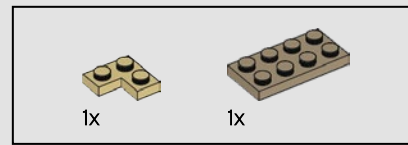
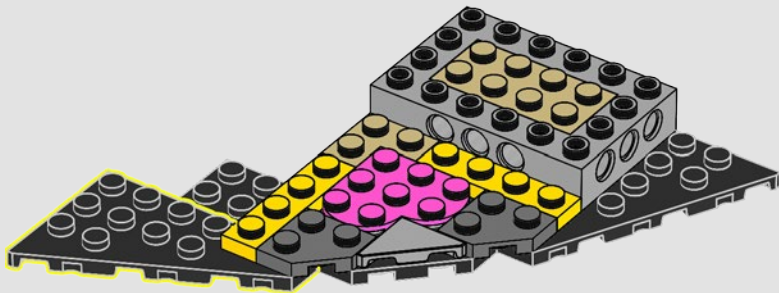

152

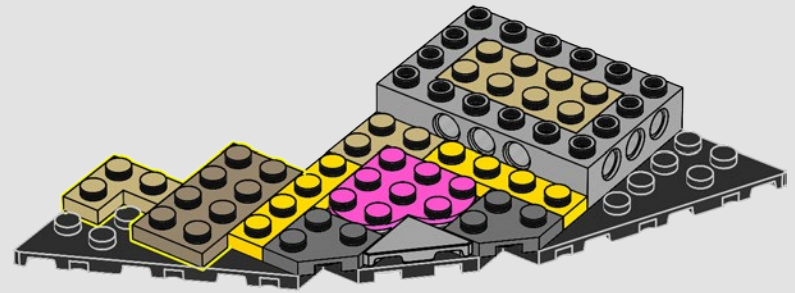

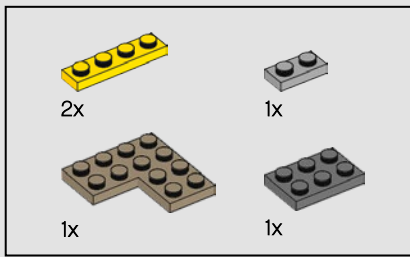

153

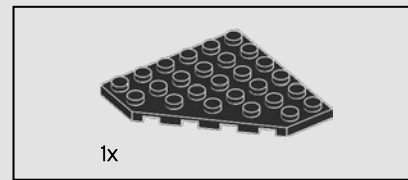
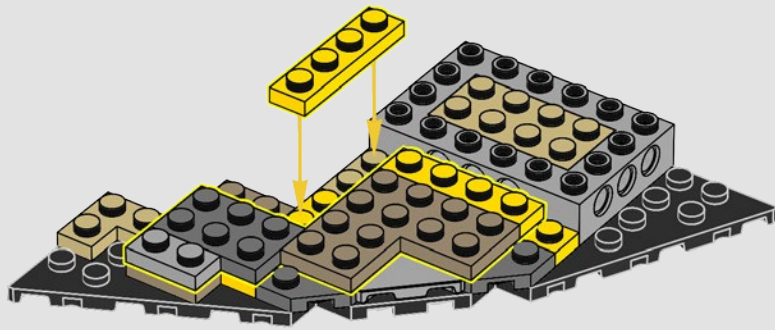

154

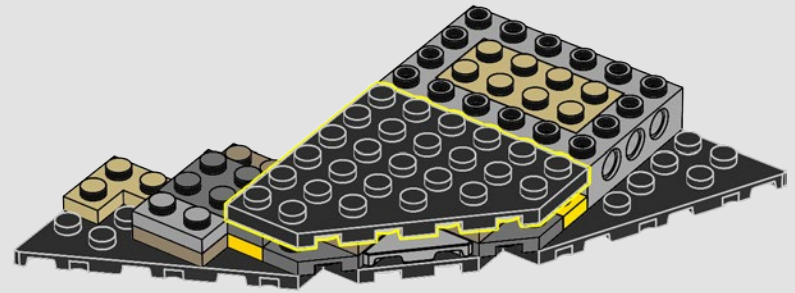

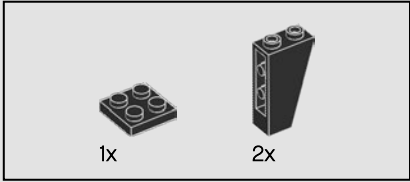
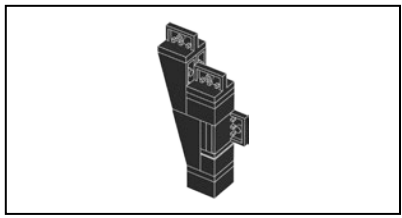

155

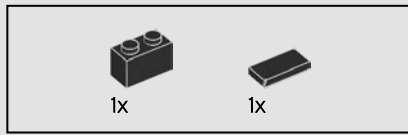
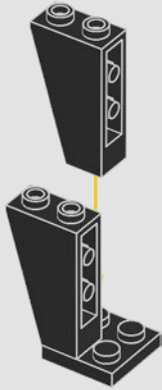

156

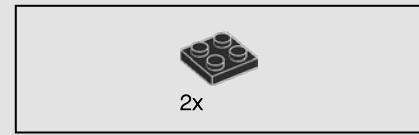
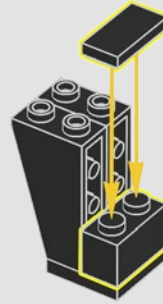

157

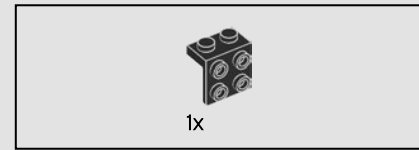
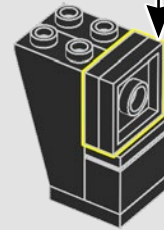
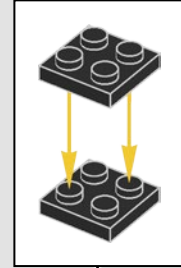

158

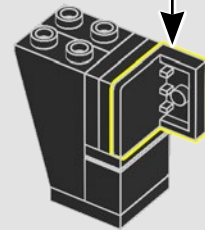
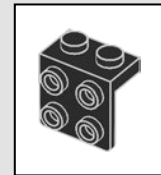



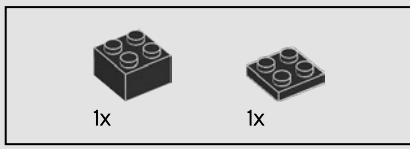

159

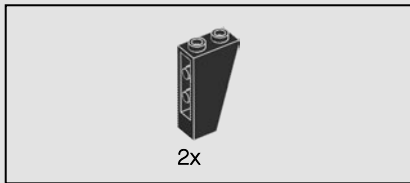
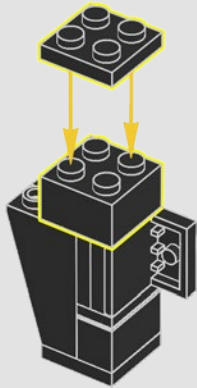

160

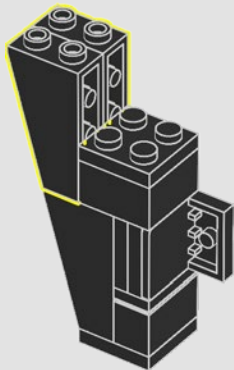

161

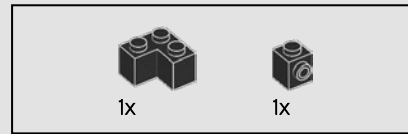
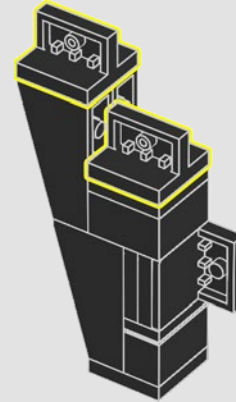

162

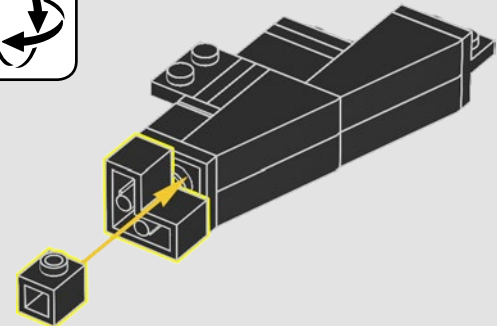
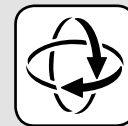

163

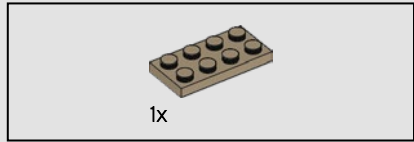
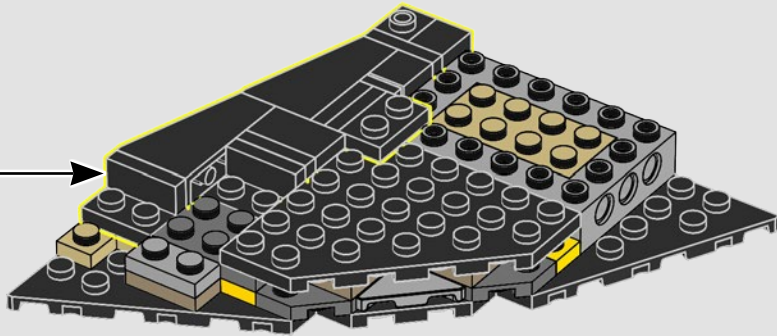

164

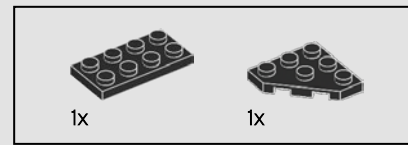
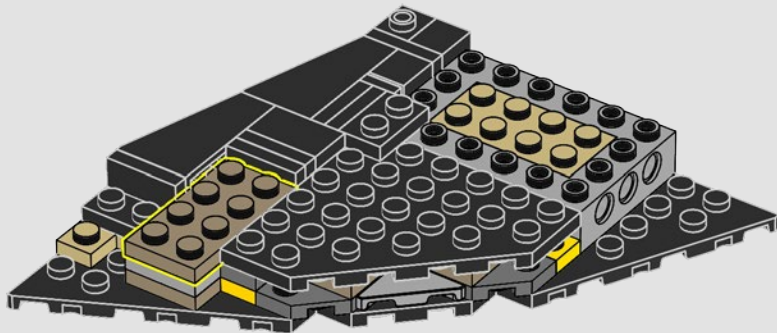

165

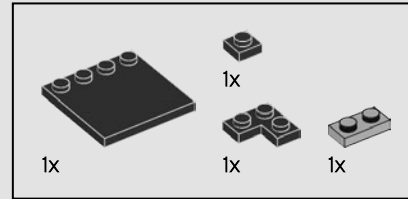
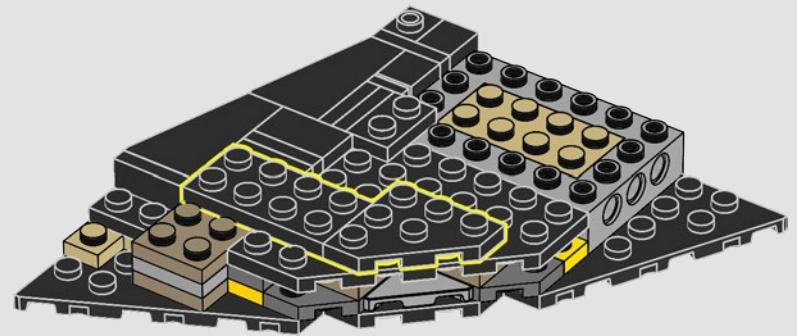

166

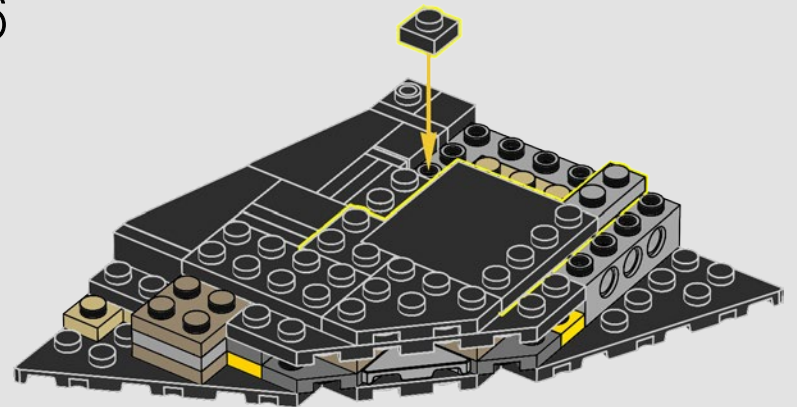

167

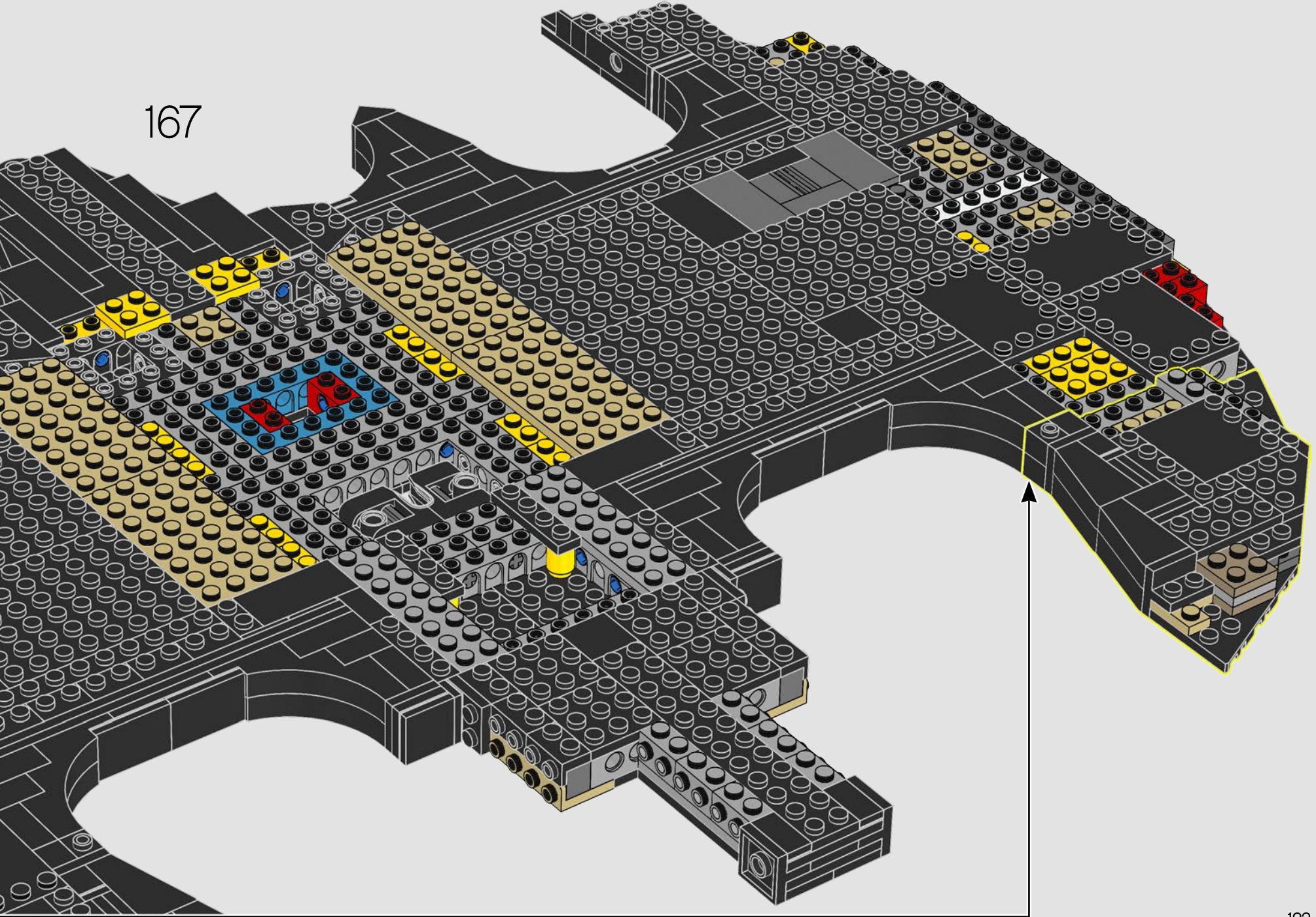

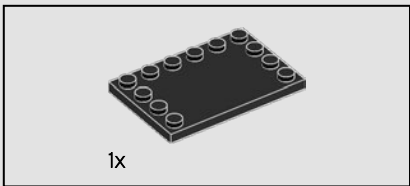

168

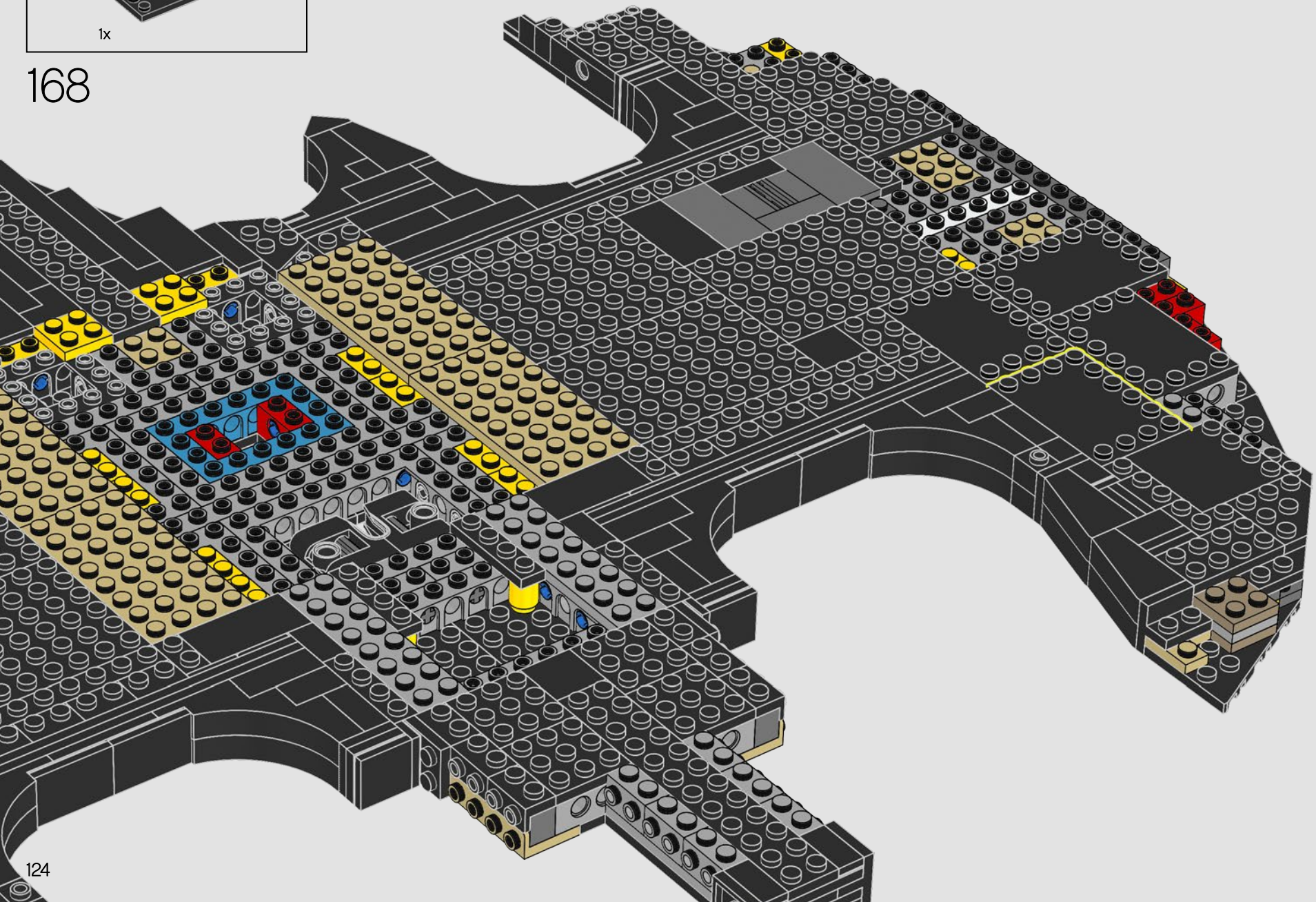

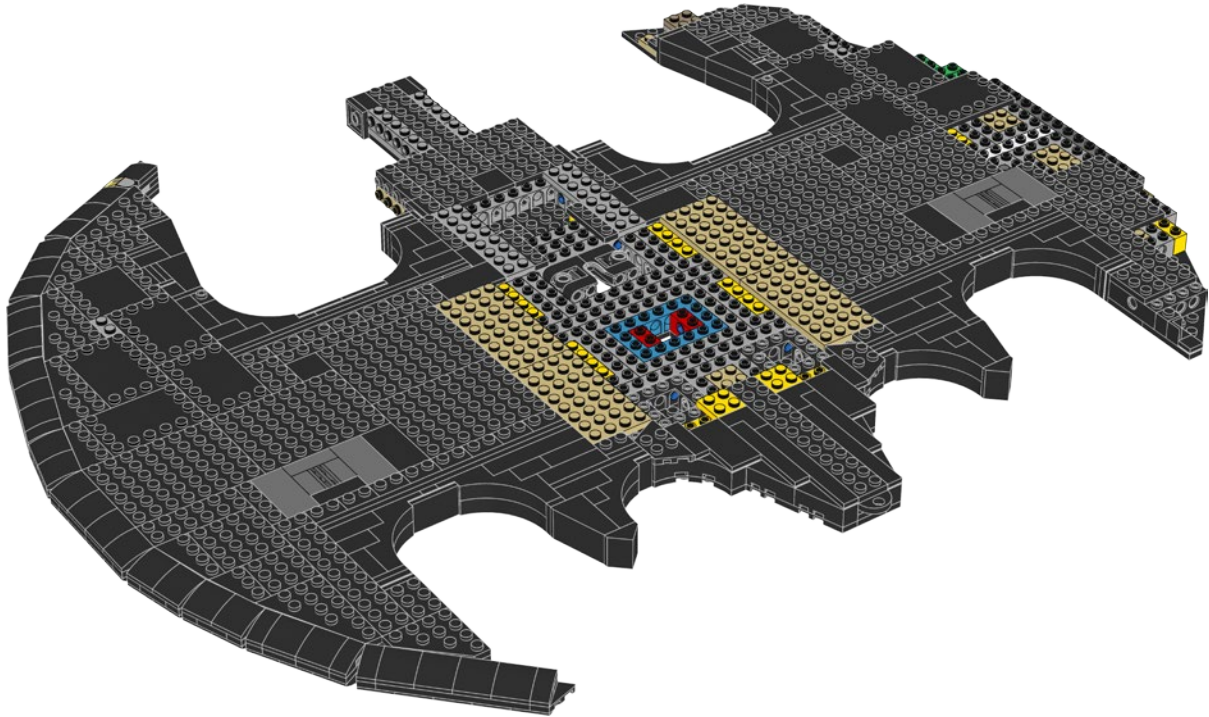
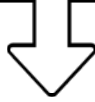

-   
1x
-   
2x
-   
3x
-   
1x

169

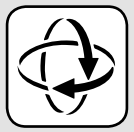
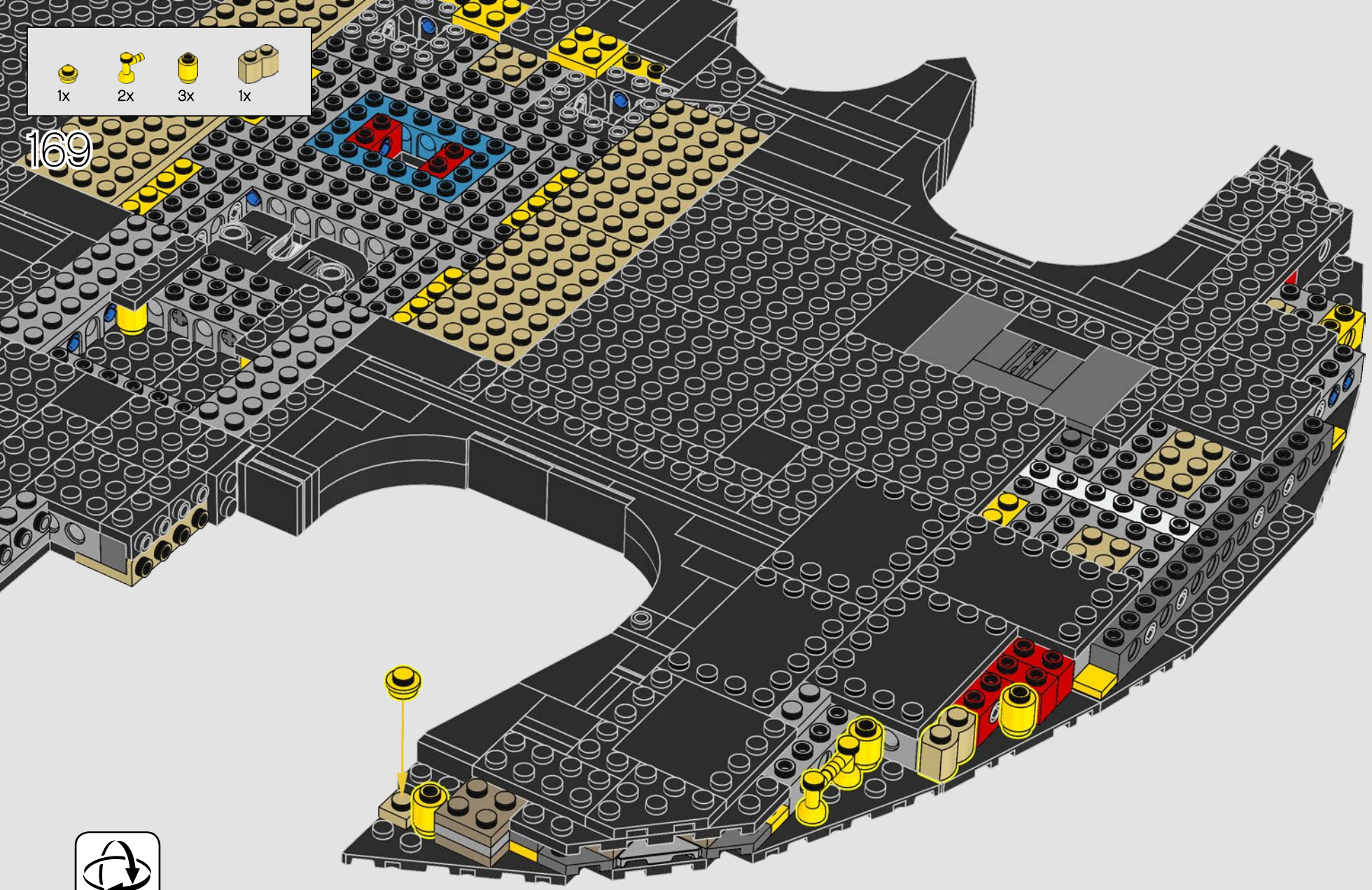

-  4x
-  1x
-  1x
-  1x

170

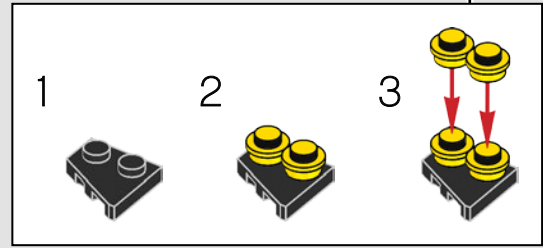
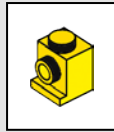
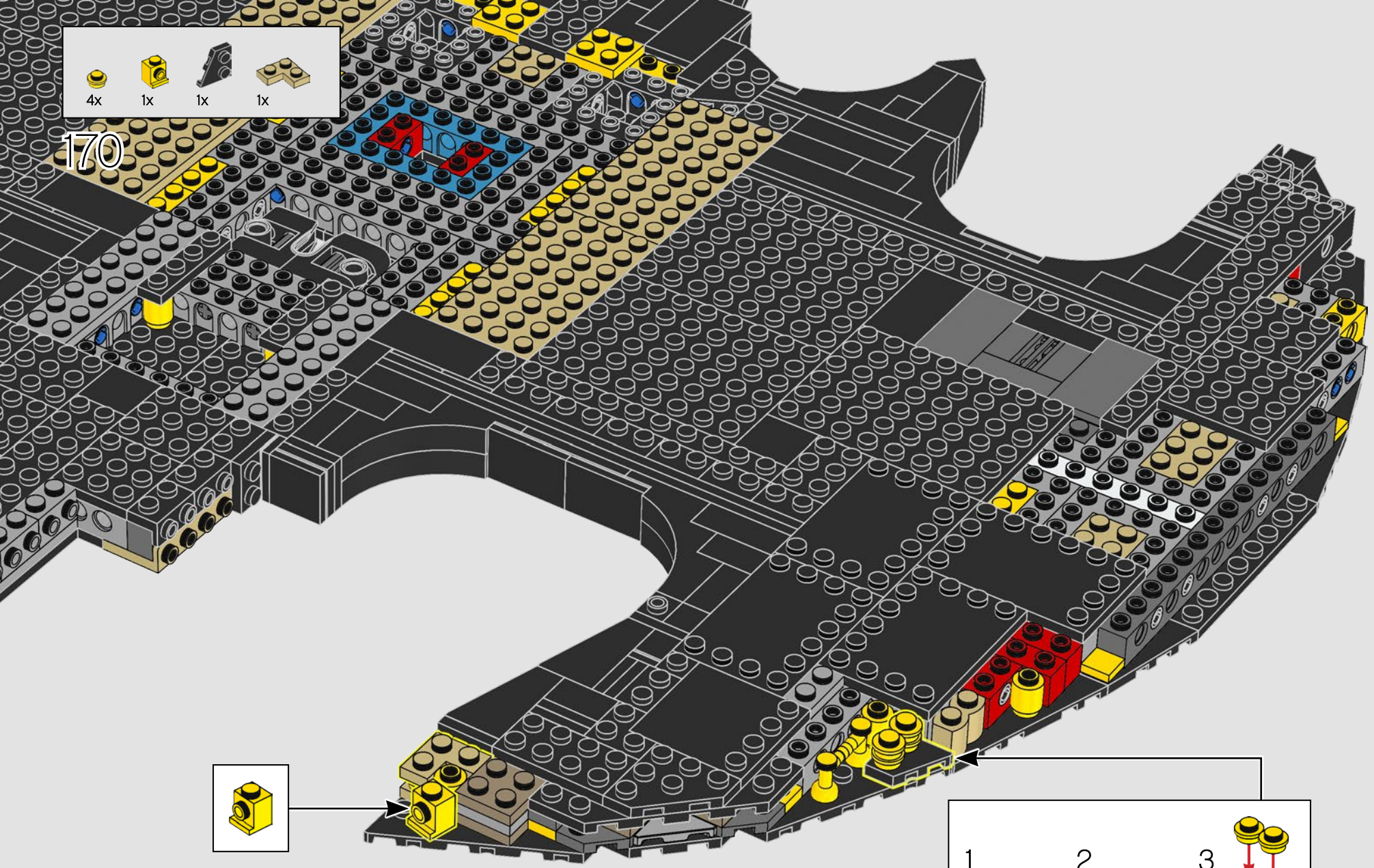

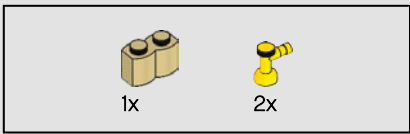

171

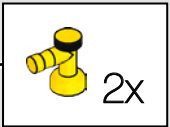
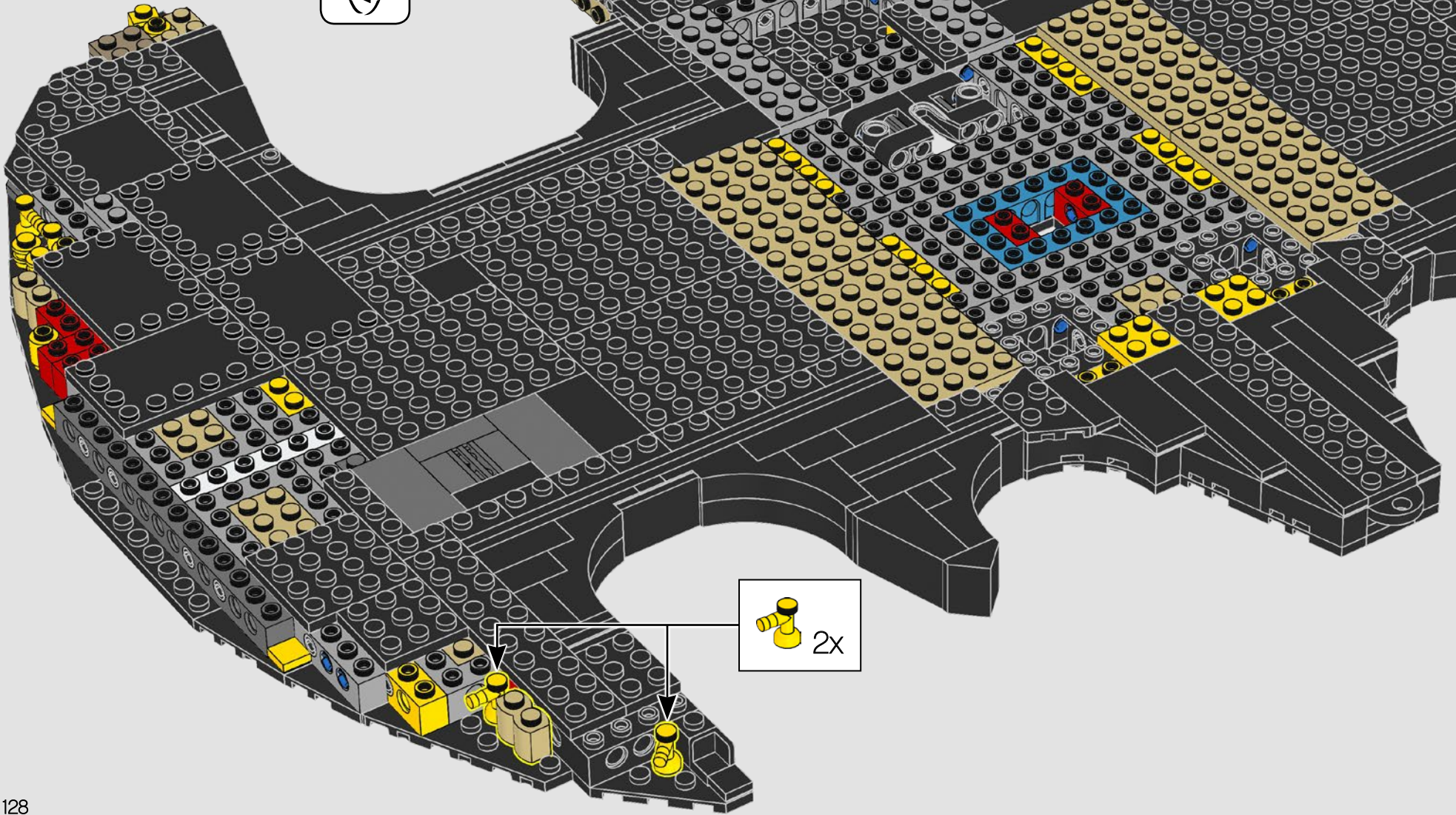



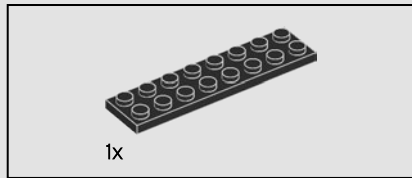
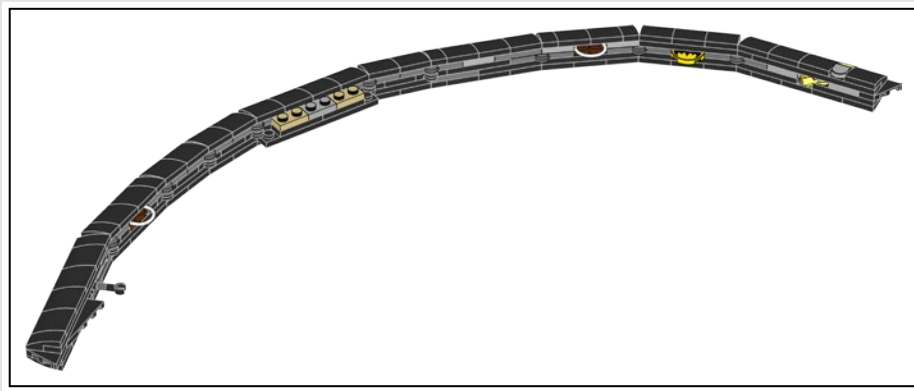

1x

172

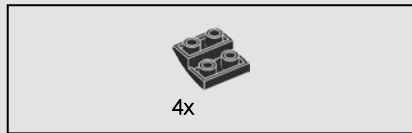
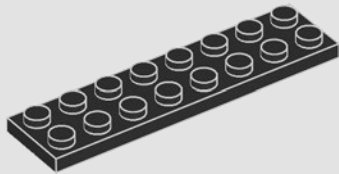

4x

173

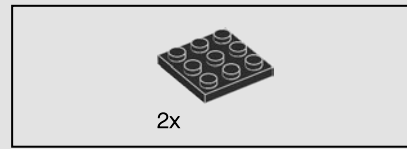
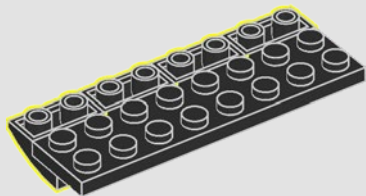

2x

174

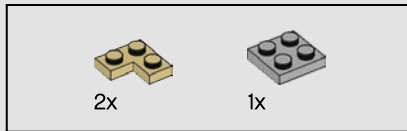
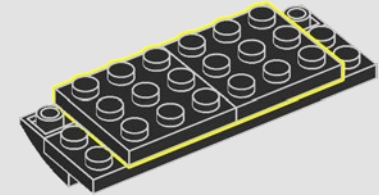

2x

1x

175

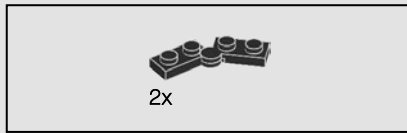
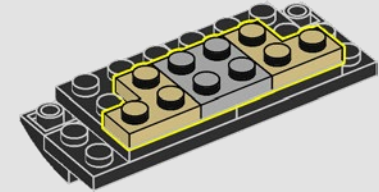

2x

176

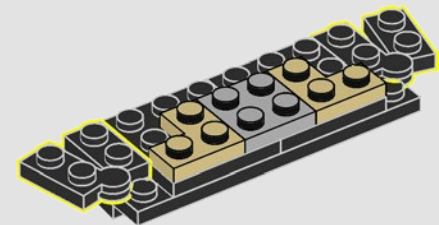

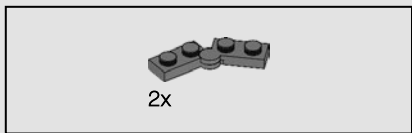

177

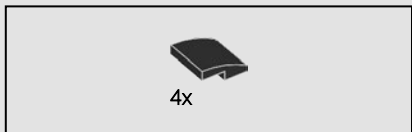
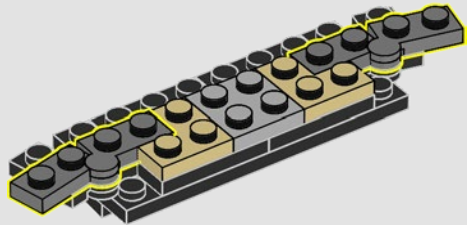

178

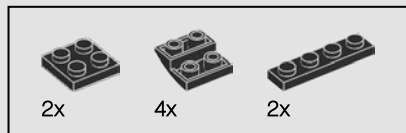
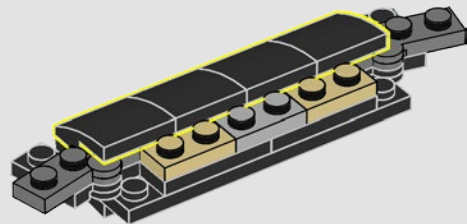

179

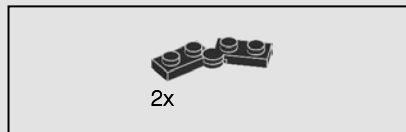
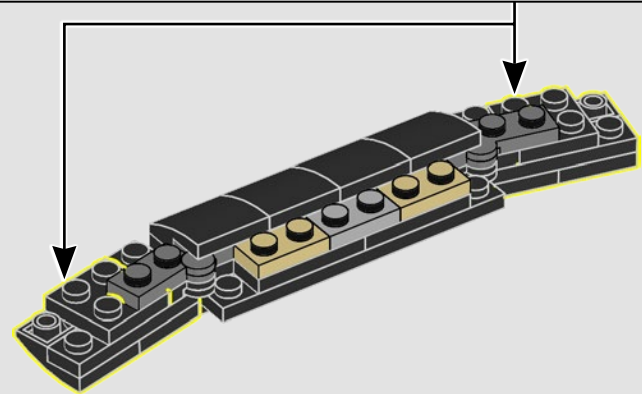
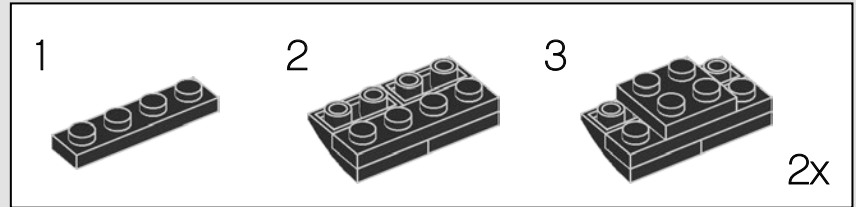

180

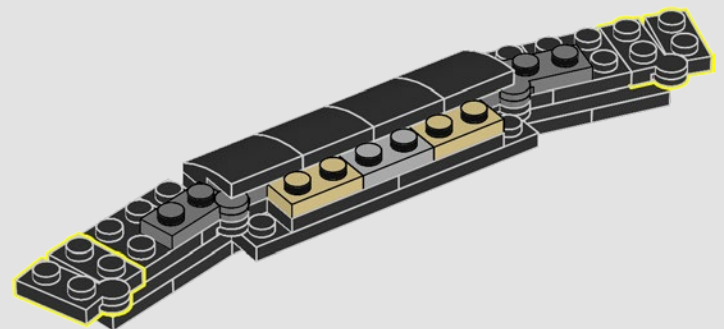

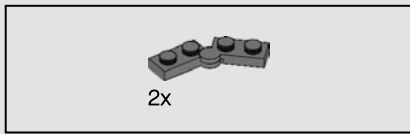

181

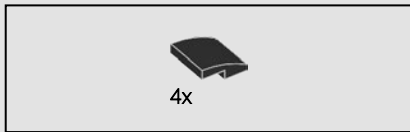
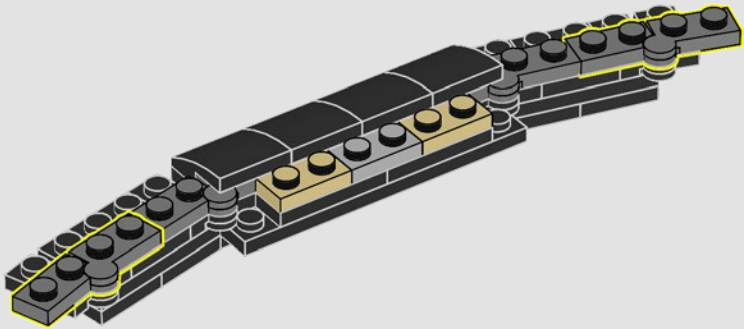

182

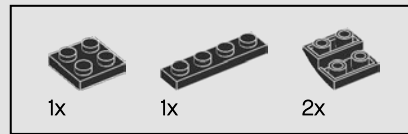
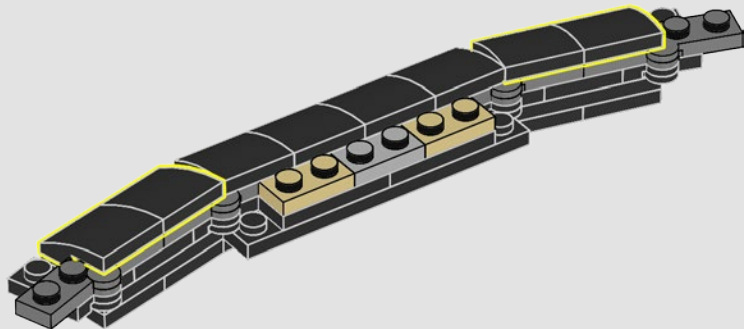

183

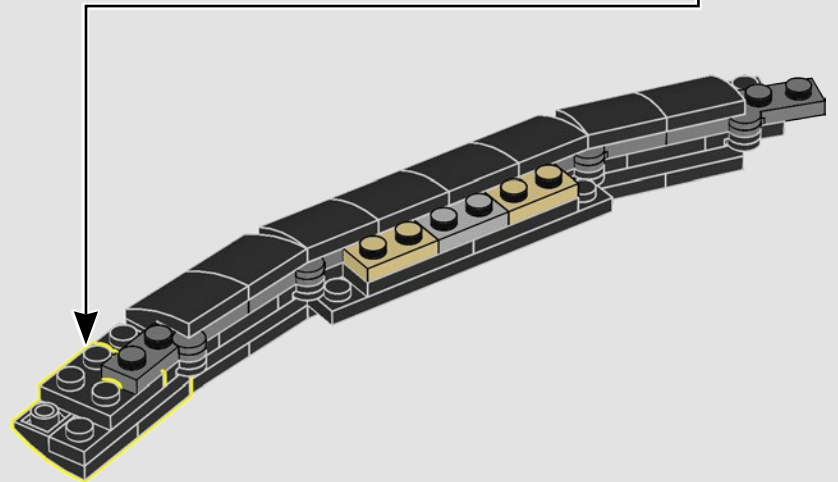

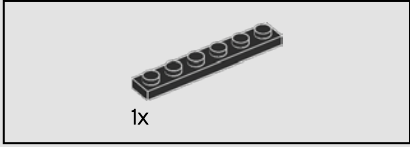
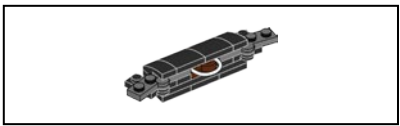

184

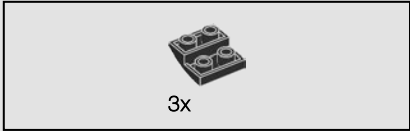
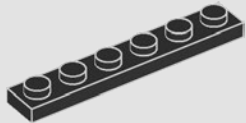

185

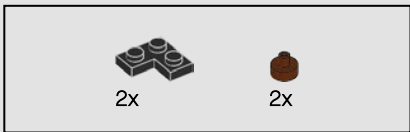
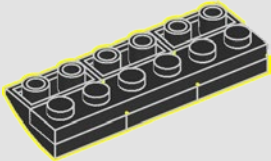

186

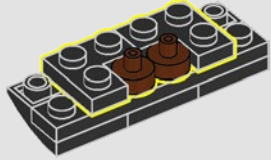

187

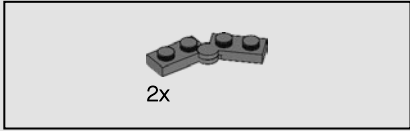
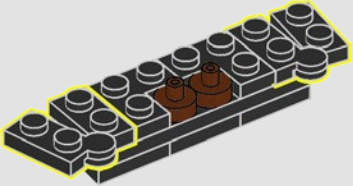

188

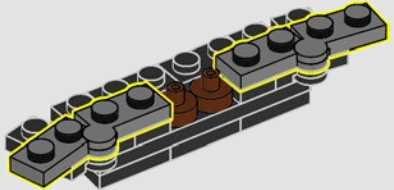

189

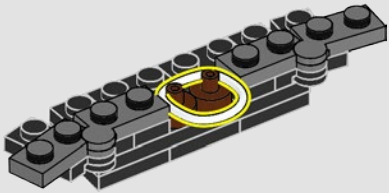

190

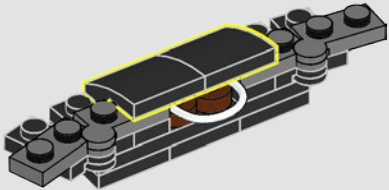



191

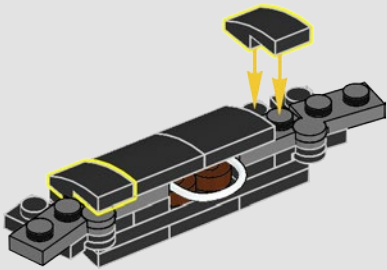

192

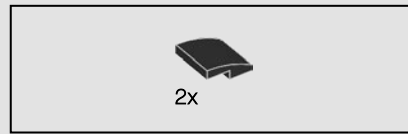
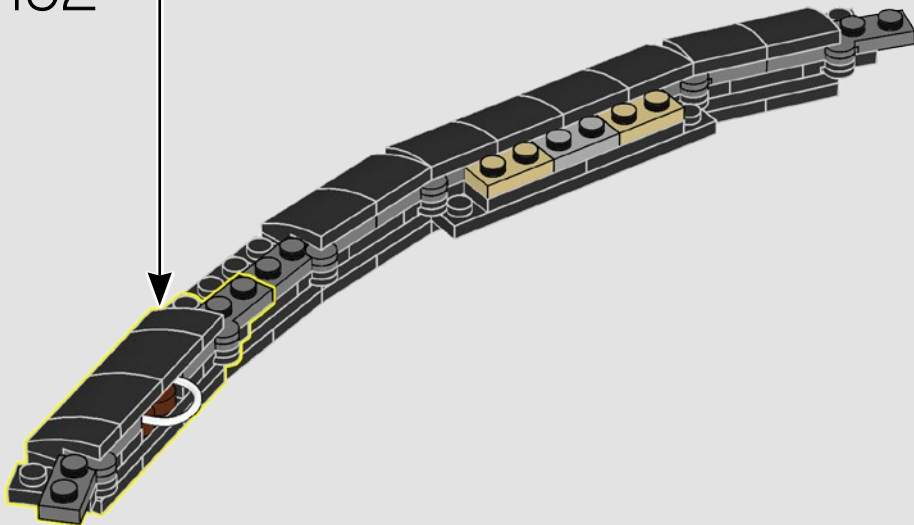

193

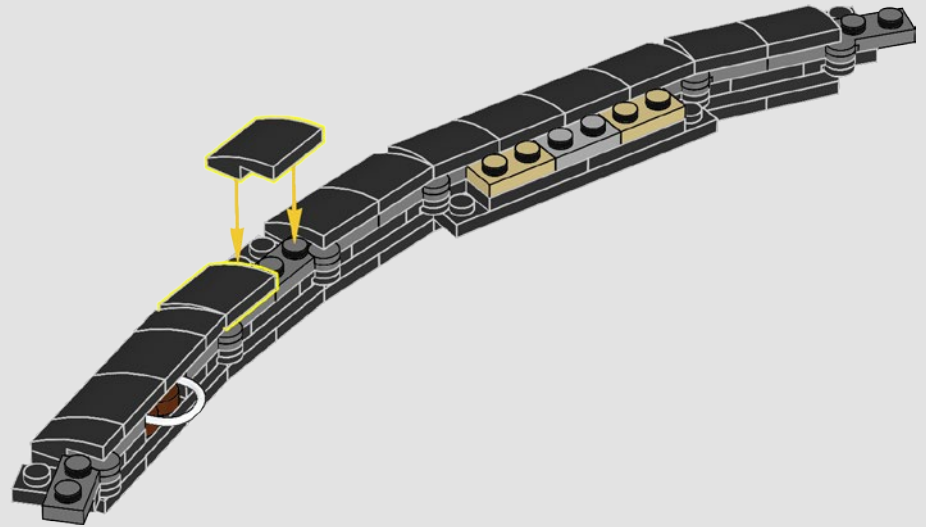

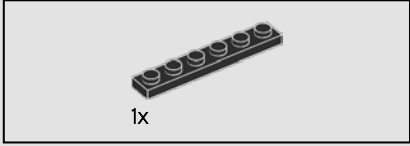
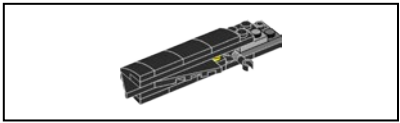

194

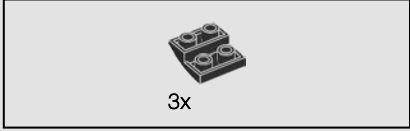
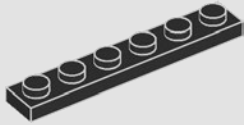

195

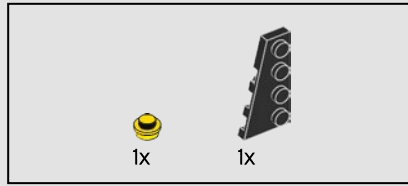
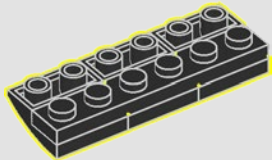

196

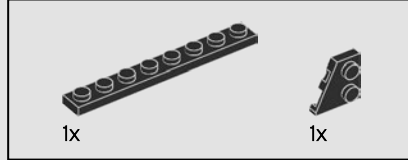
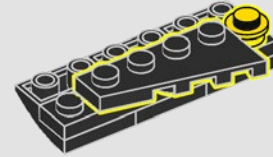

197

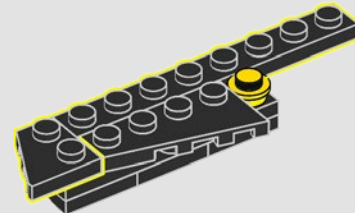

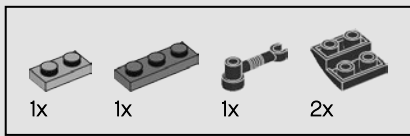

198

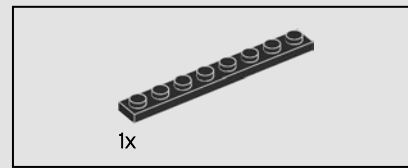
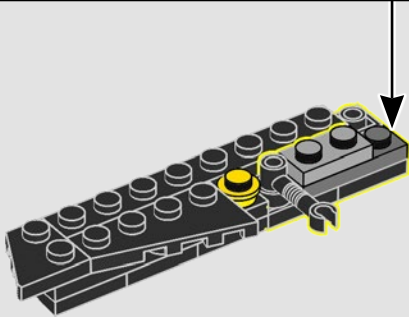
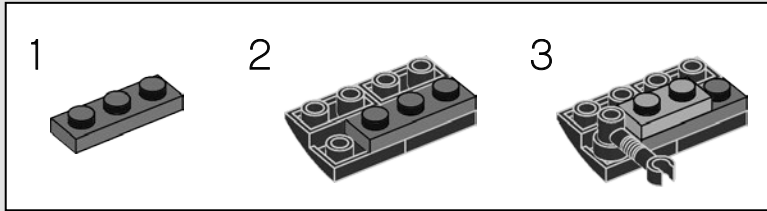

199

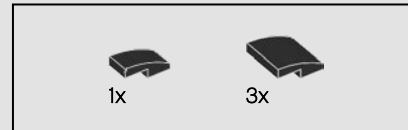
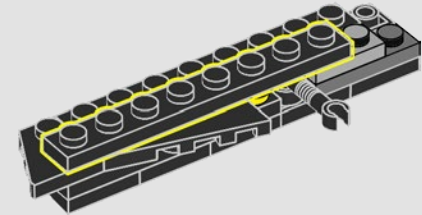

200

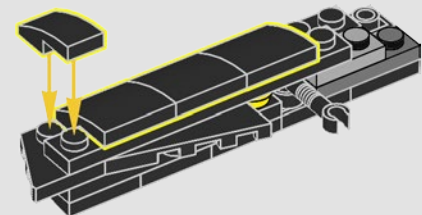

201

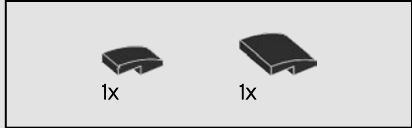
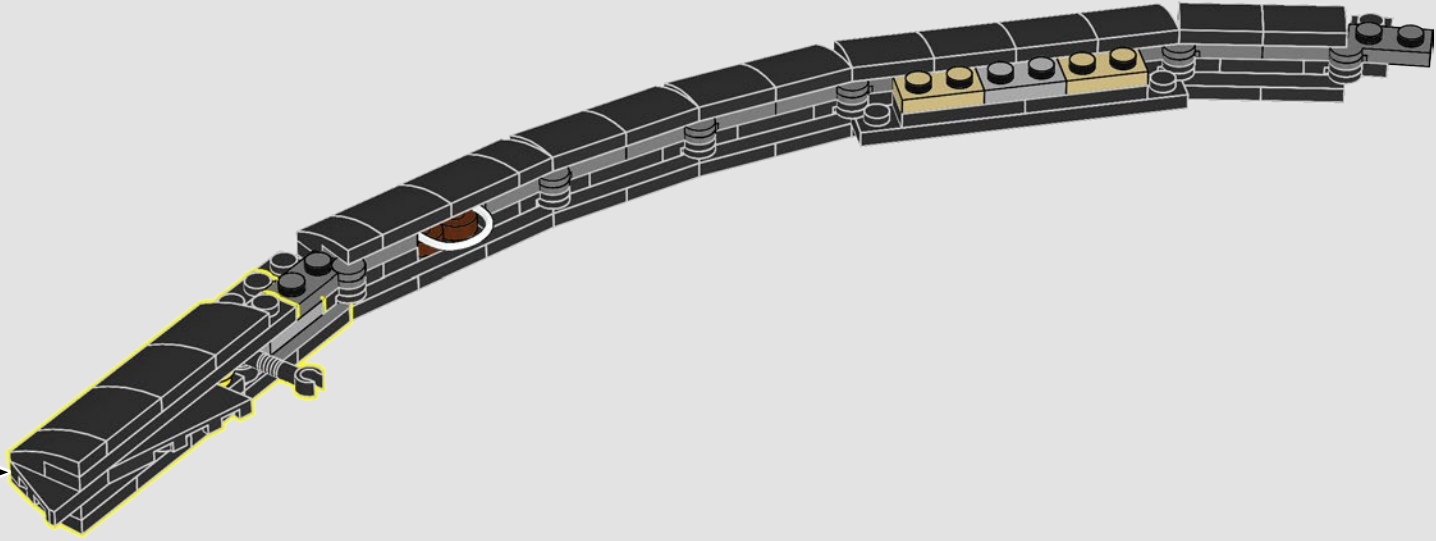

202

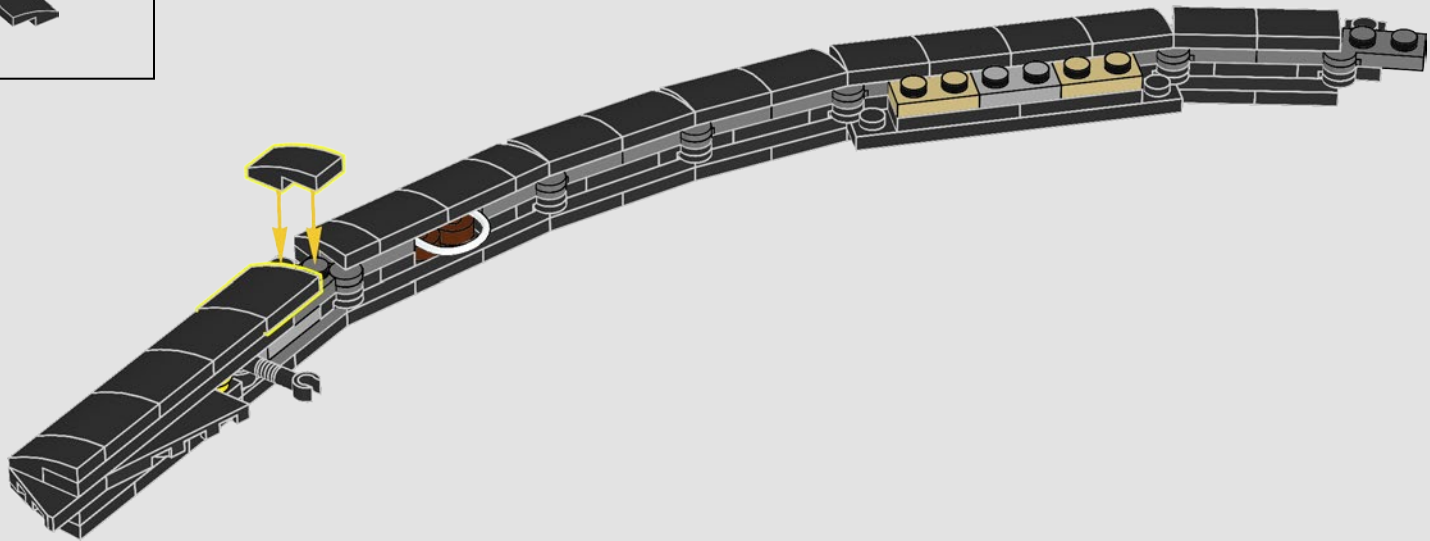



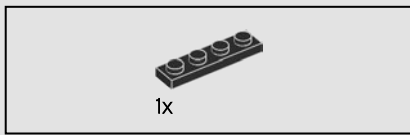

203

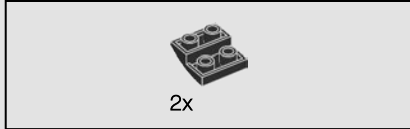
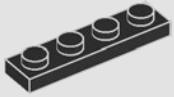

204

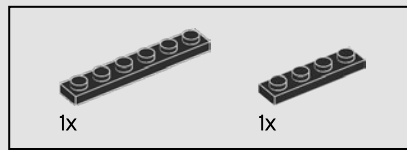
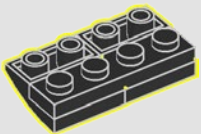

205

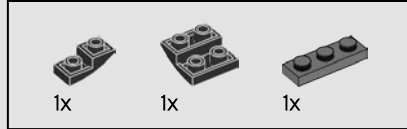
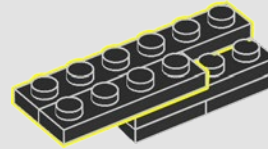

206

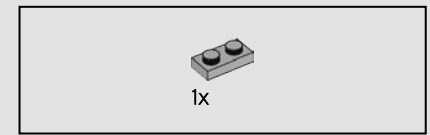
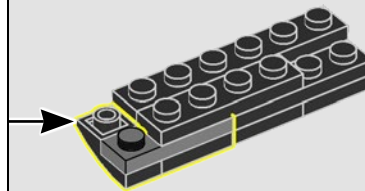
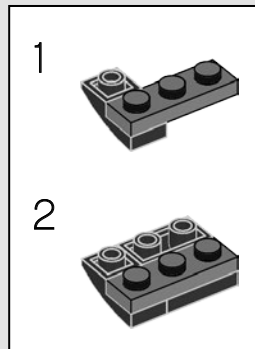

207

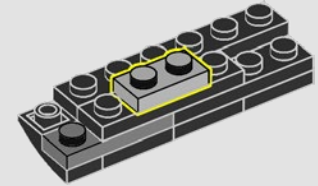

208

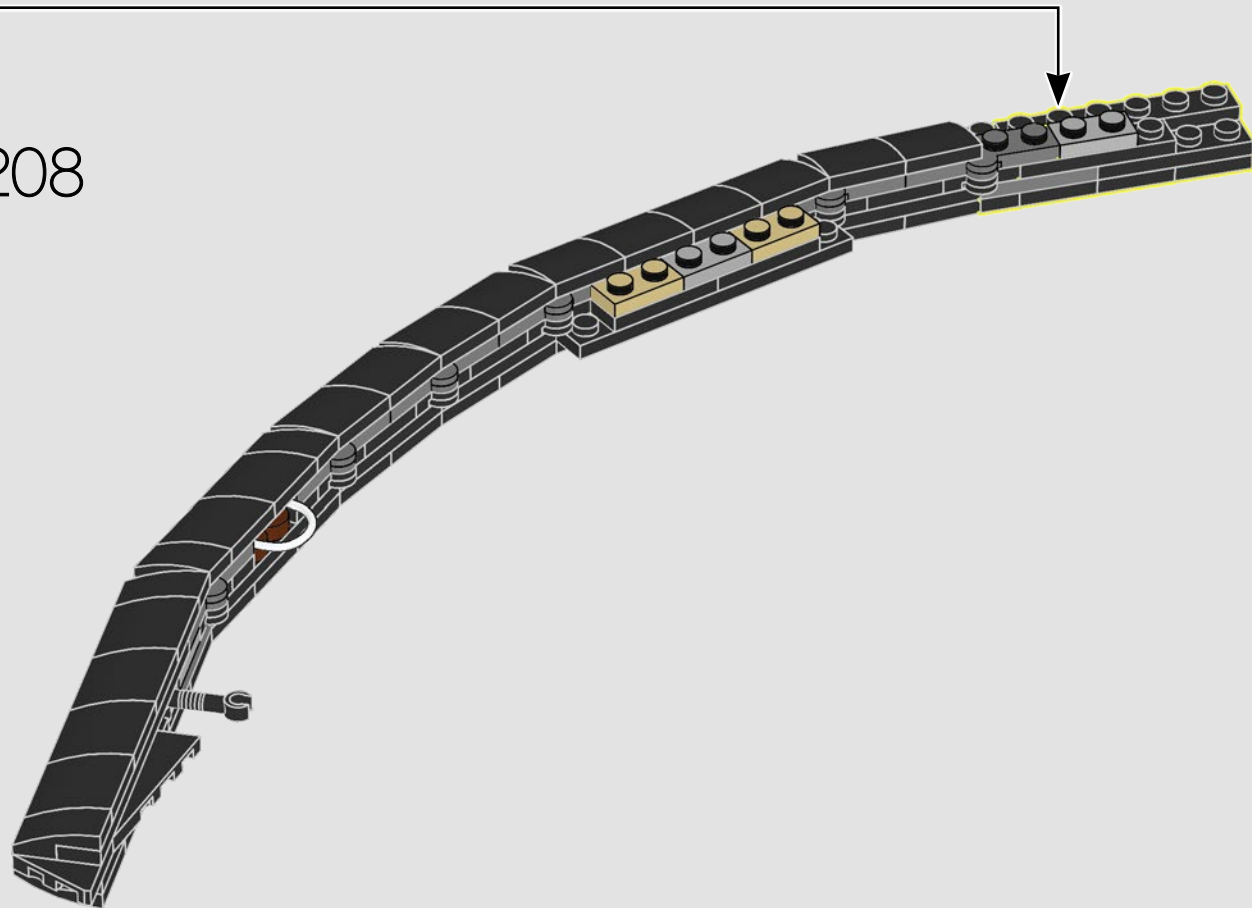

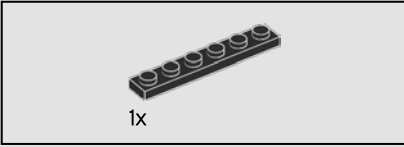
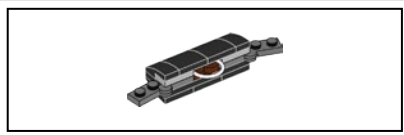

1x

209

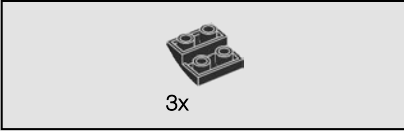
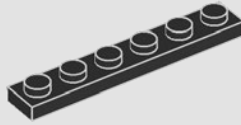

3x

210

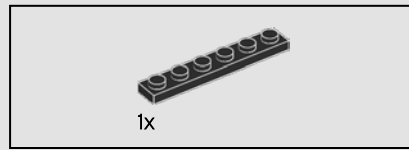
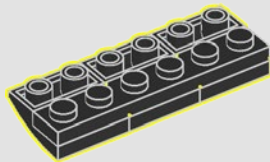

1x

211

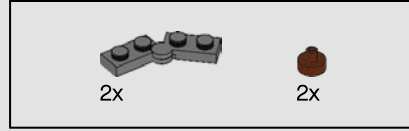
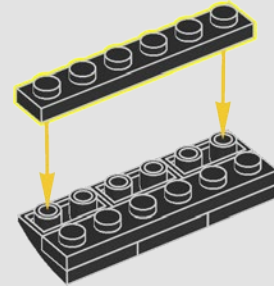

2x

2x

212

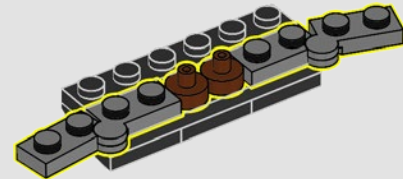



2x

213

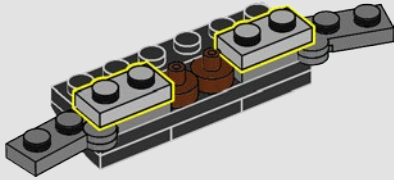

1x

214

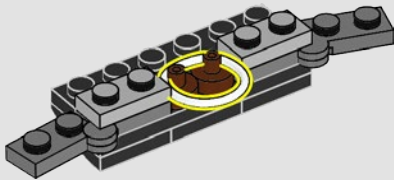

2x

215

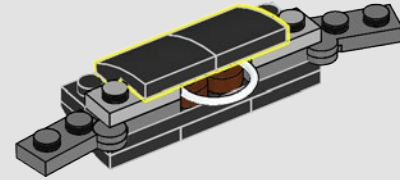

2x

216

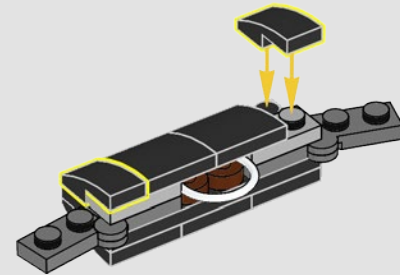

217

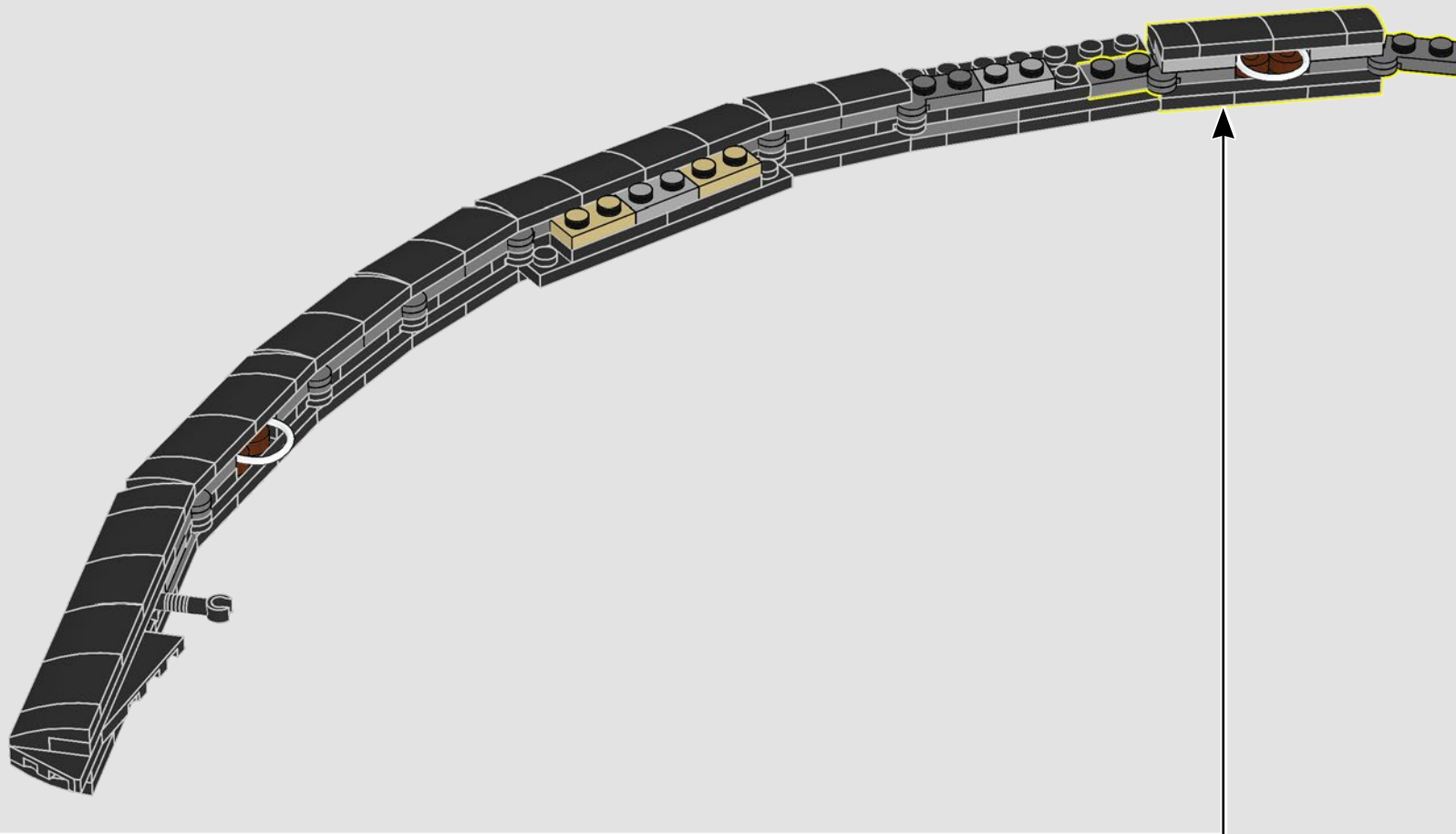

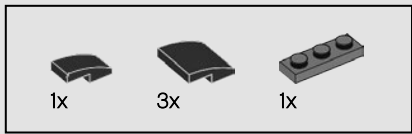

218

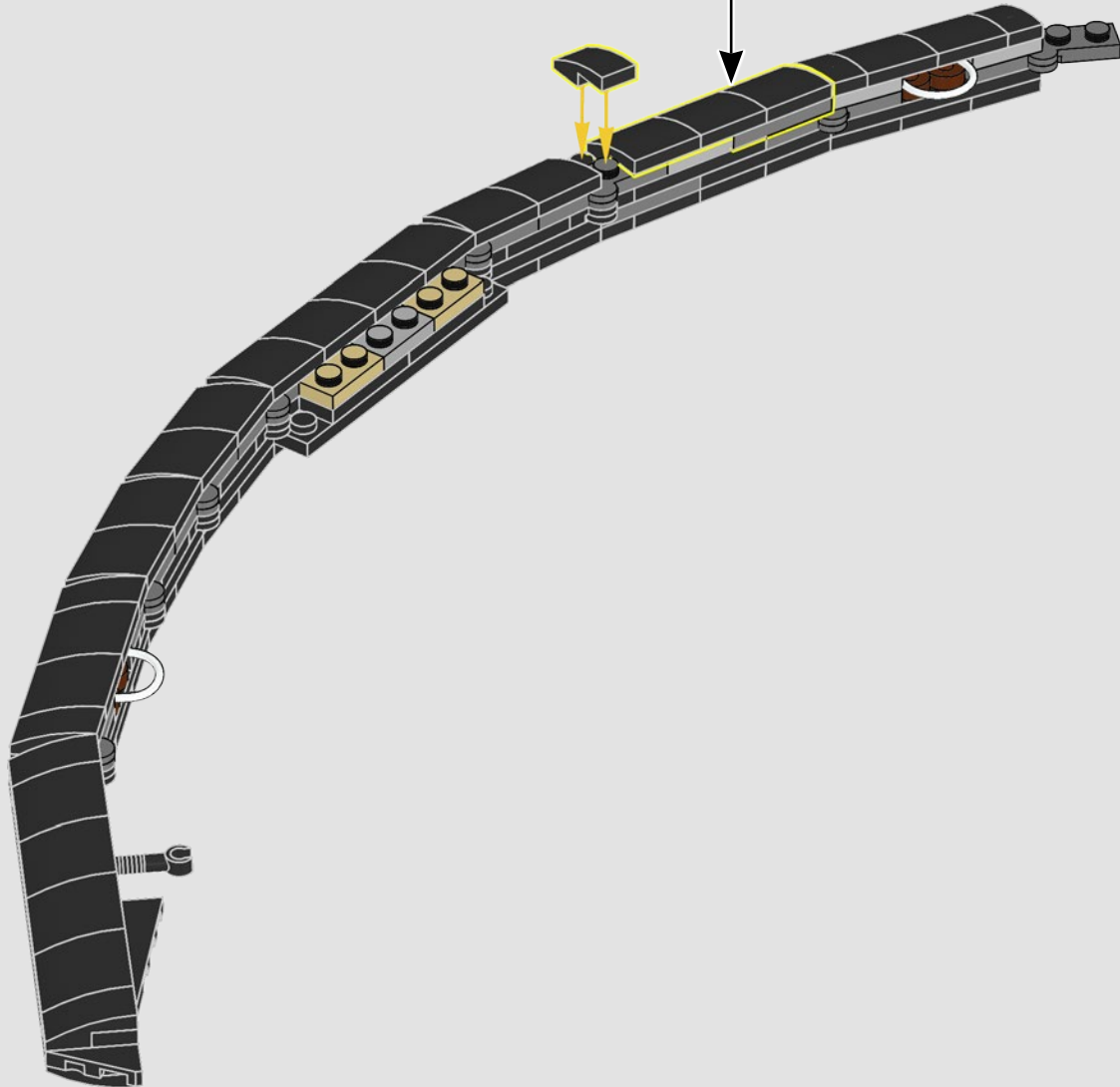
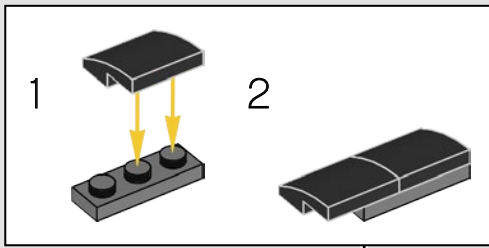

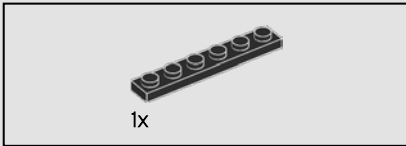
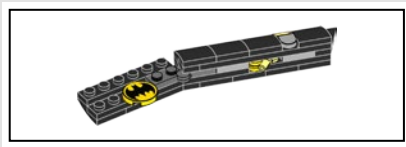

219

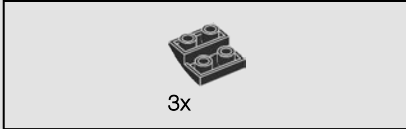
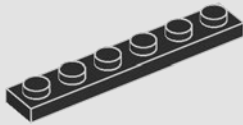

220

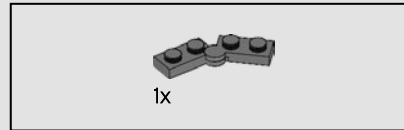
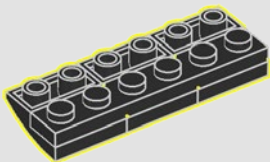

221

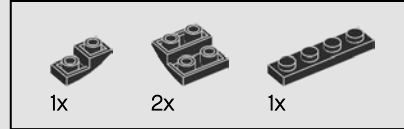
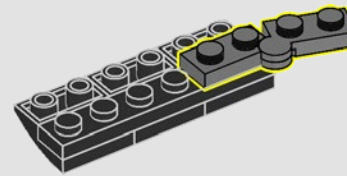

222

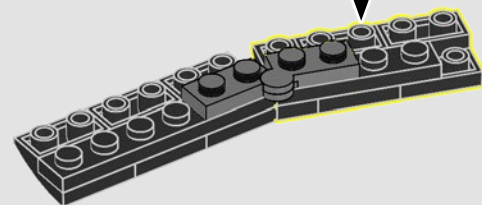
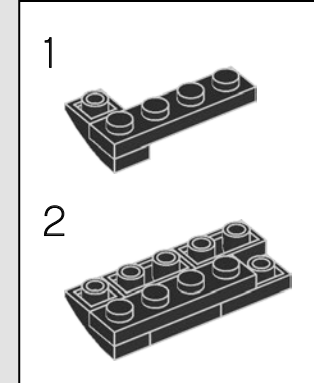

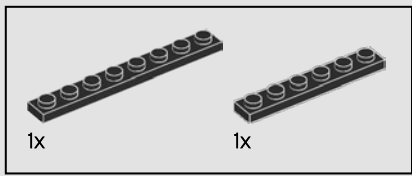

223

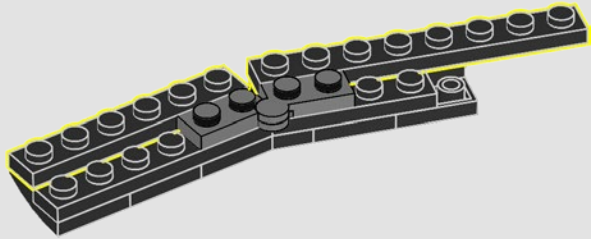

224

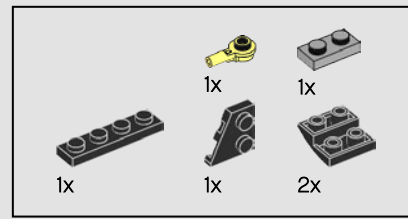
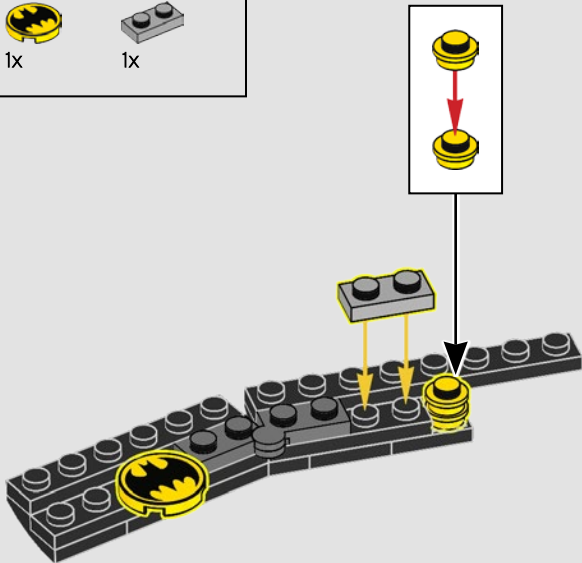

225

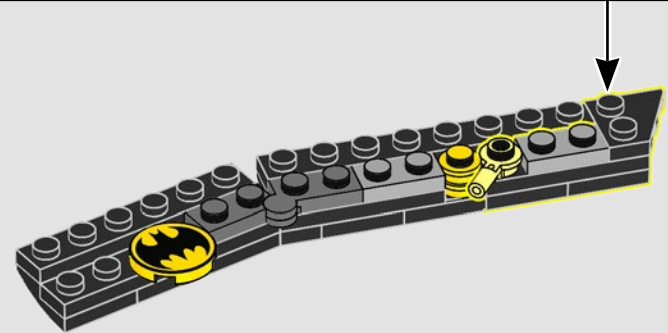
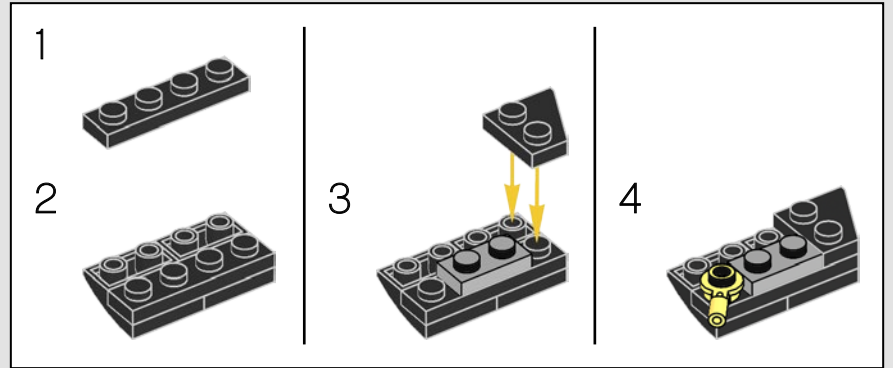



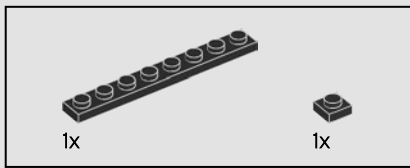

226

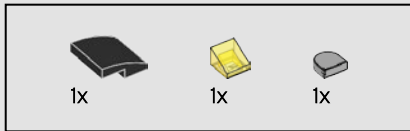
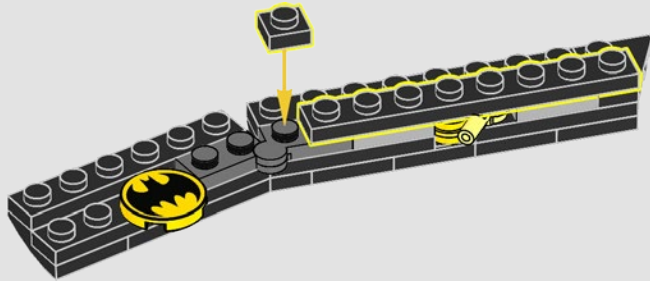

227

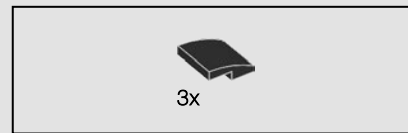
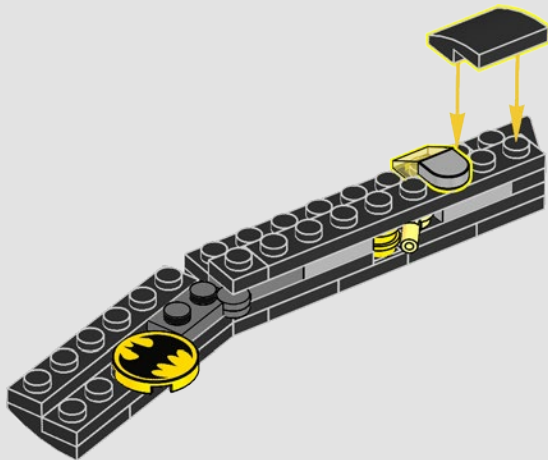

228

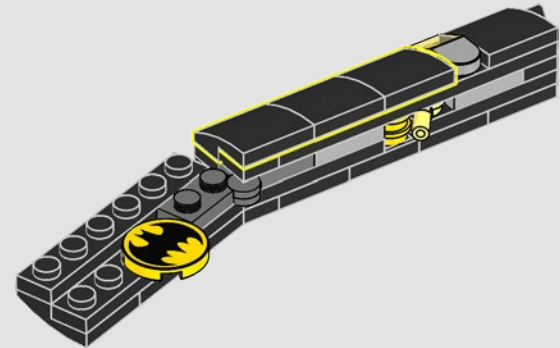

229

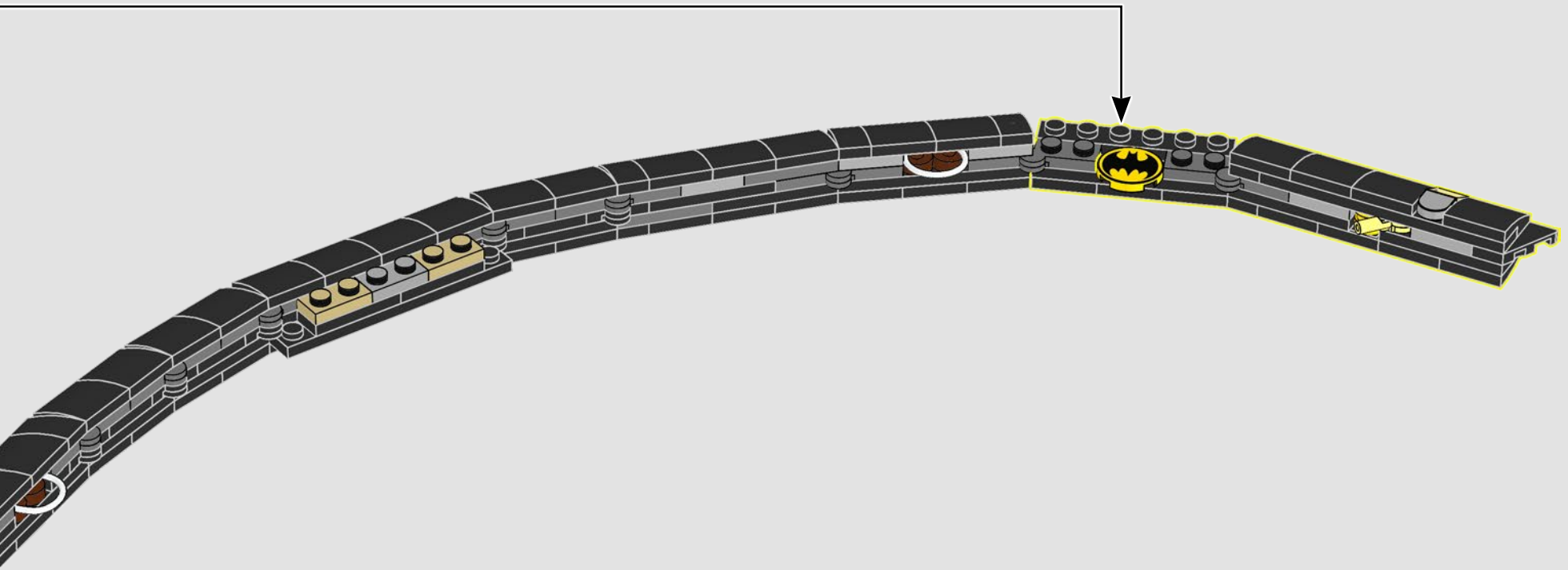

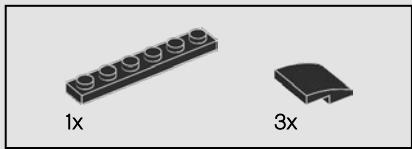

230

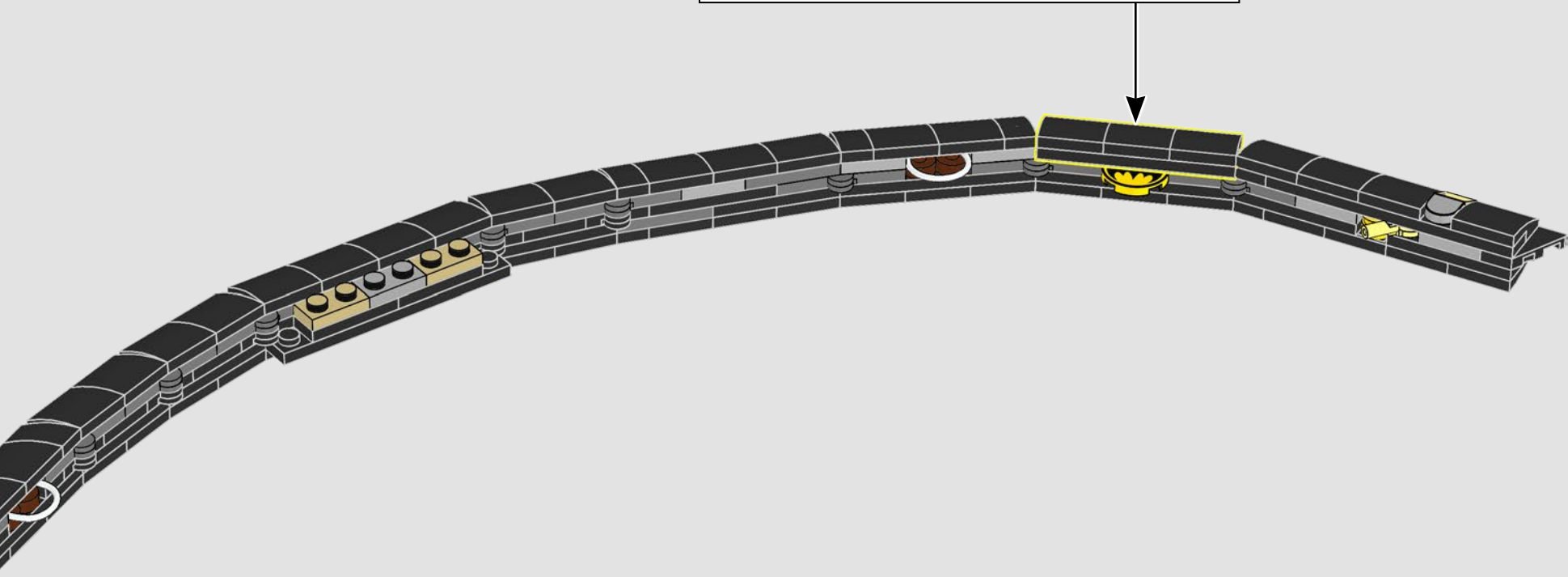
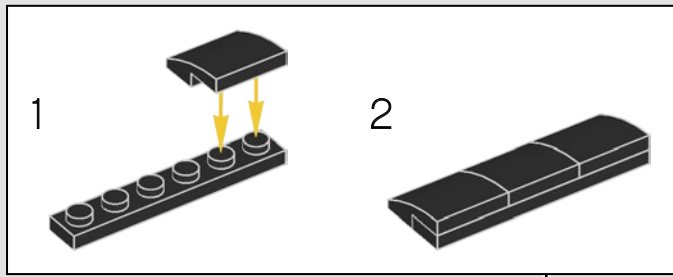

231

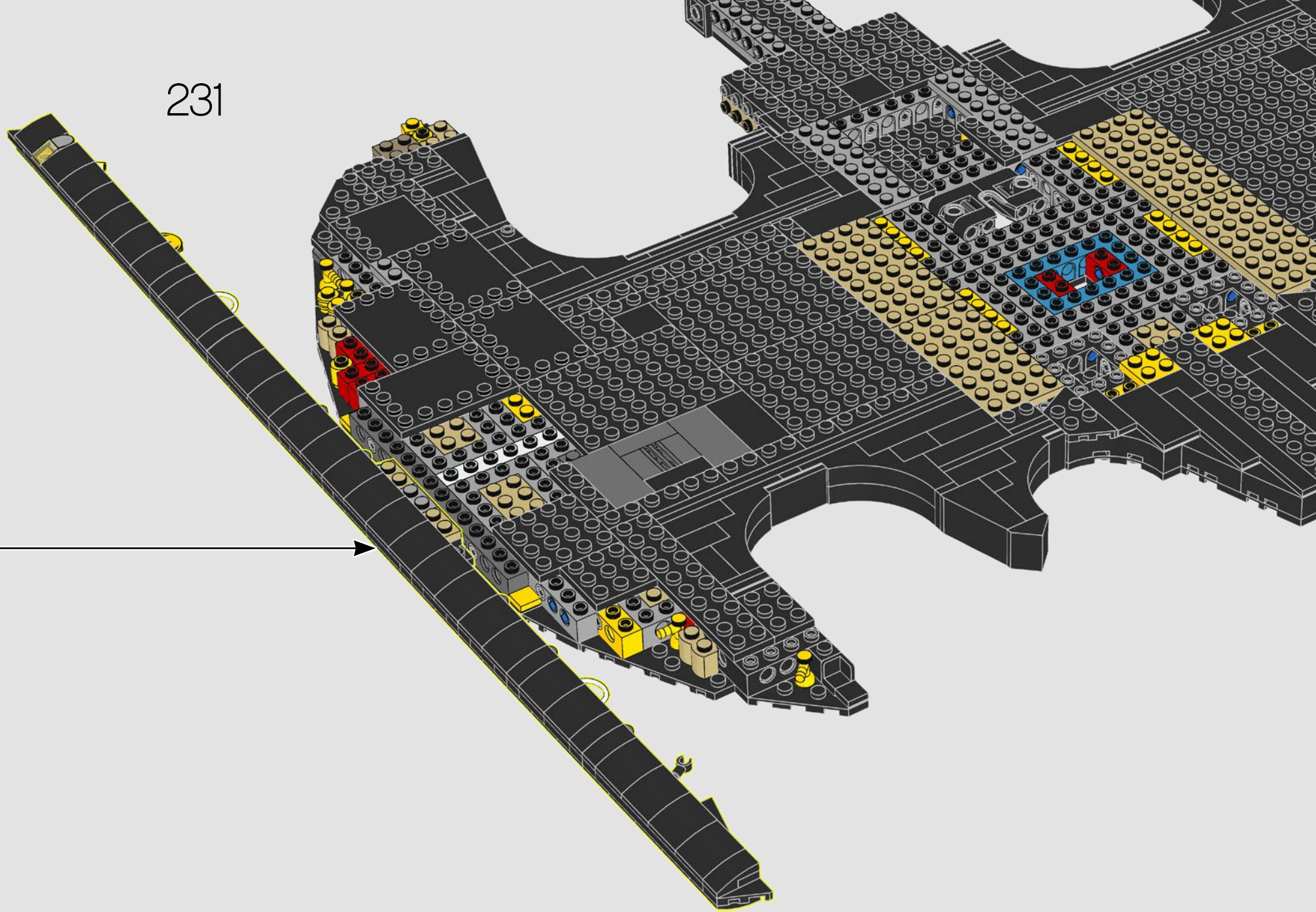

232

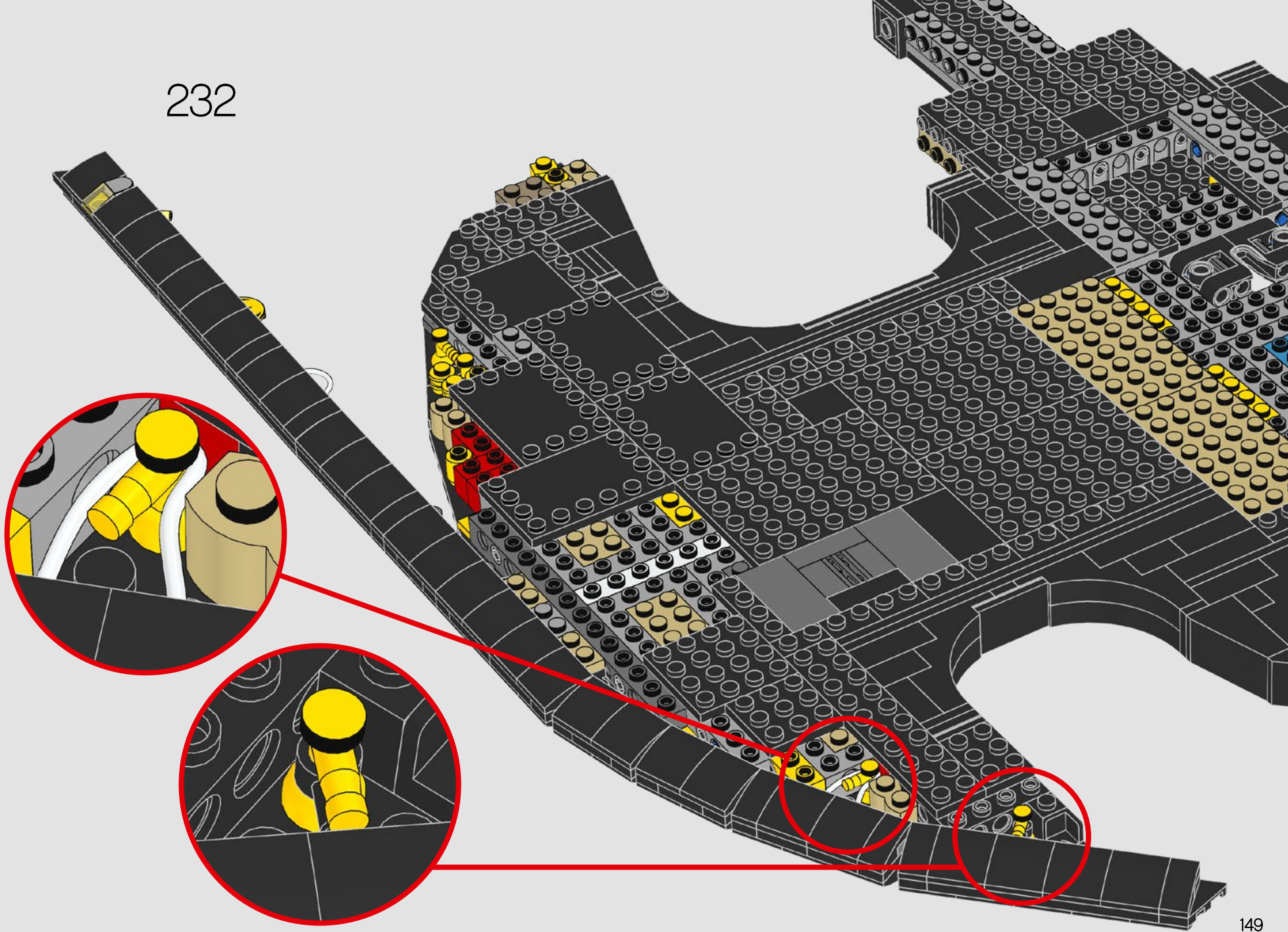



2x

233

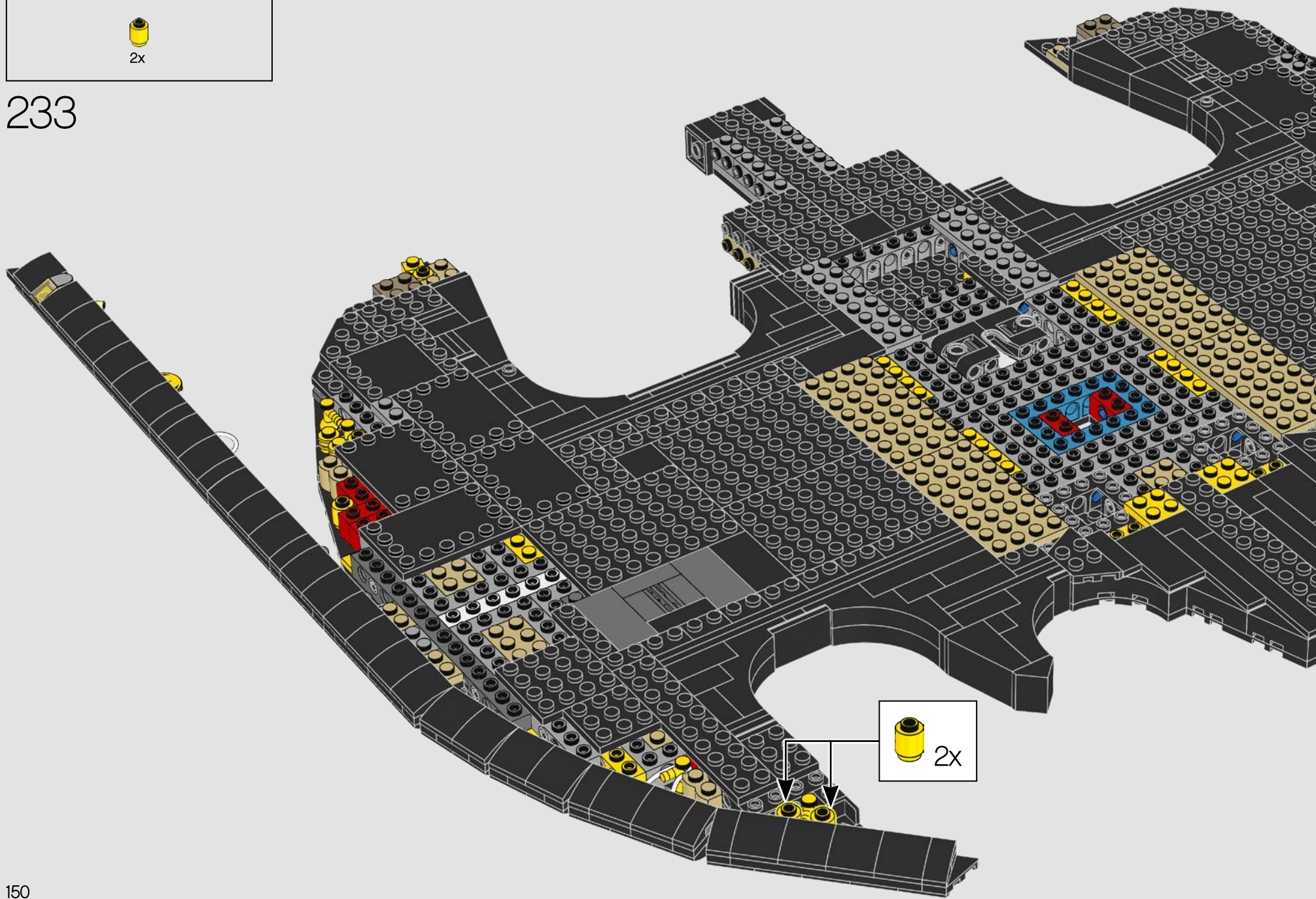

2x

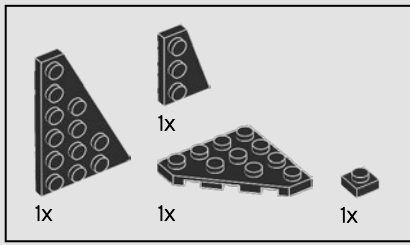

234

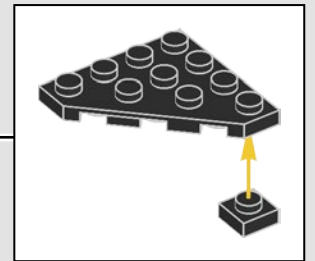
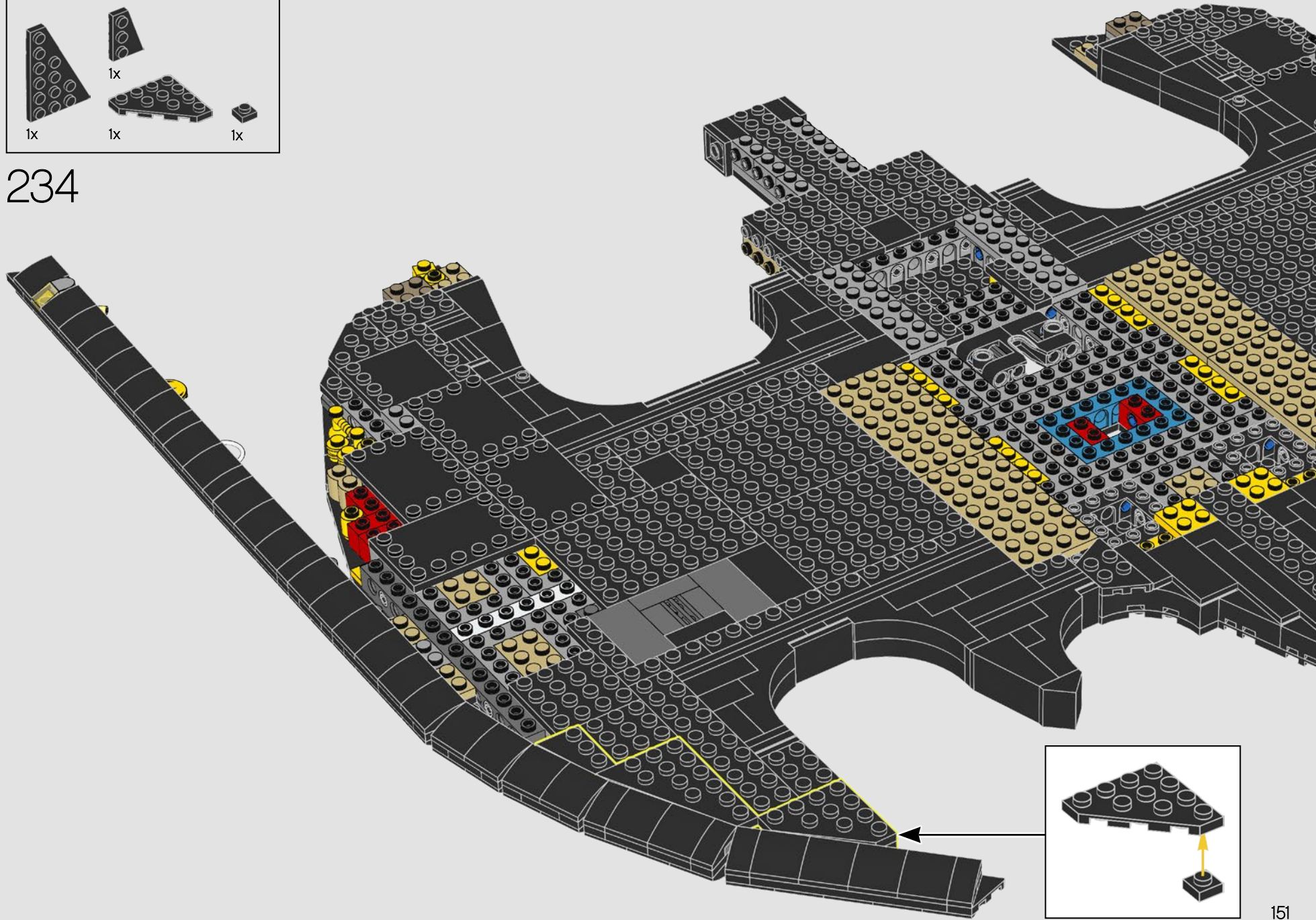

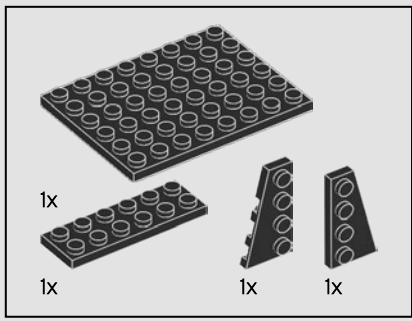

235

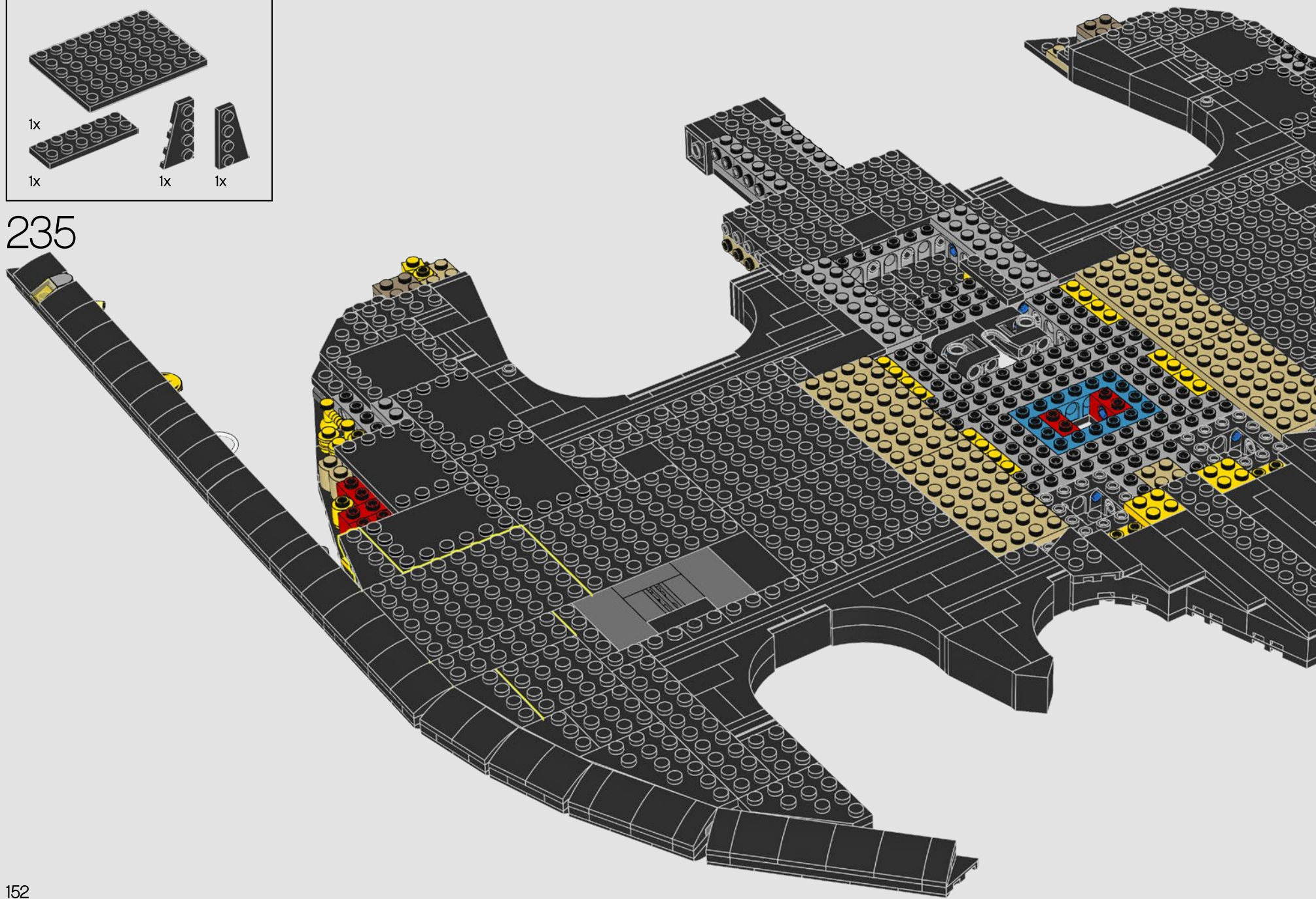



236

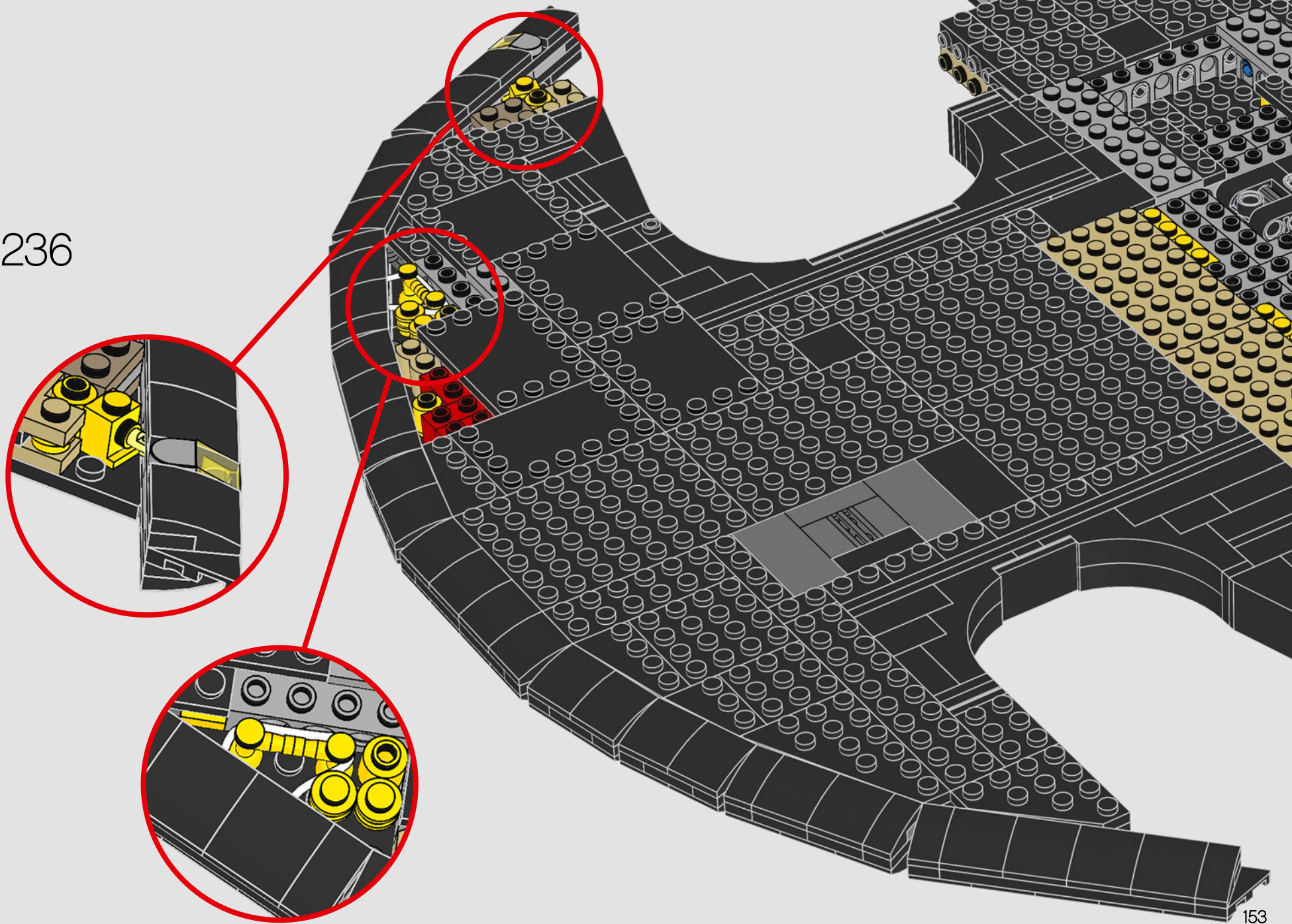

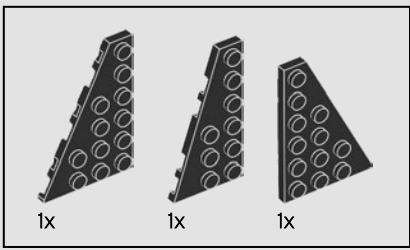



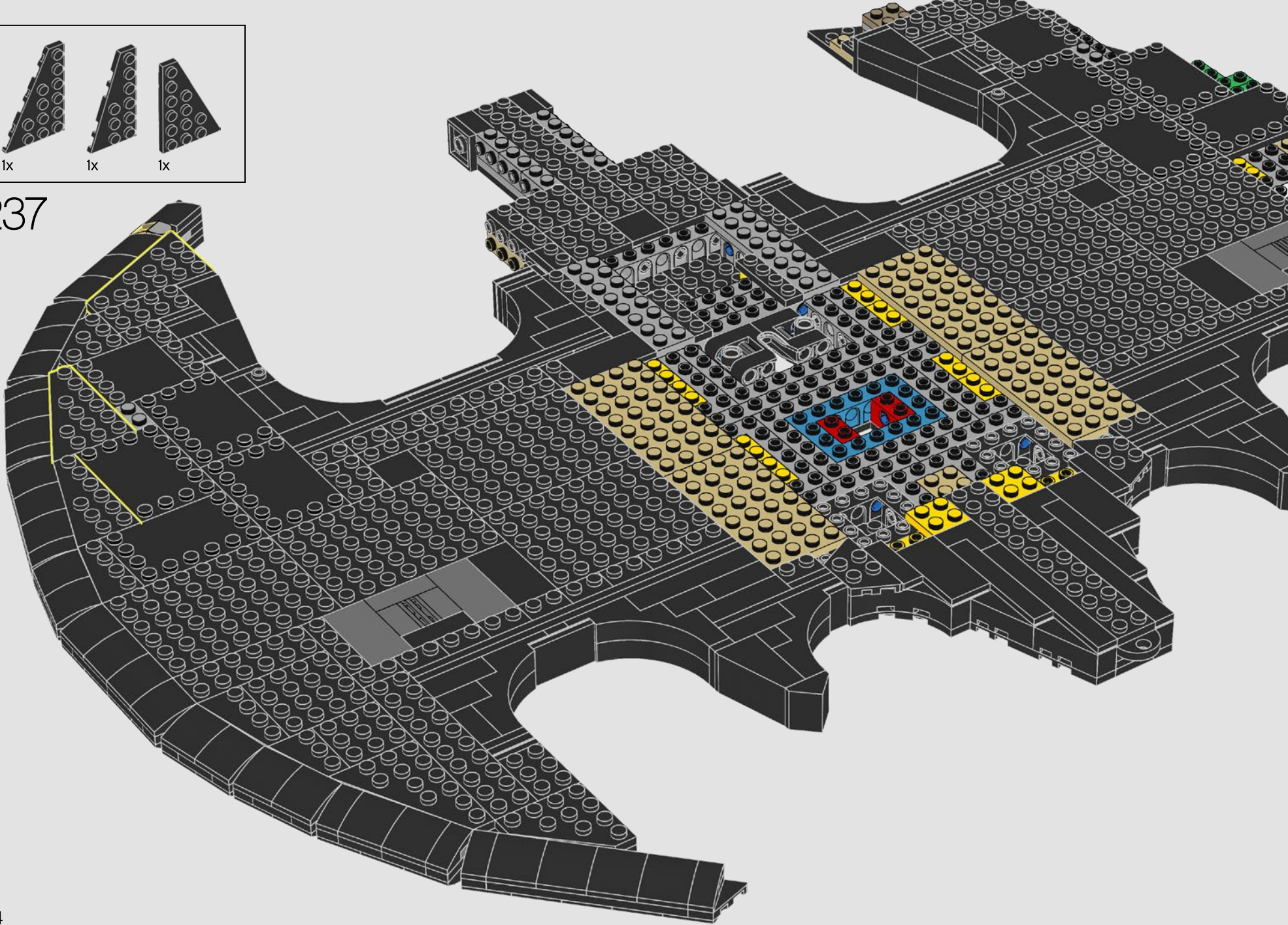

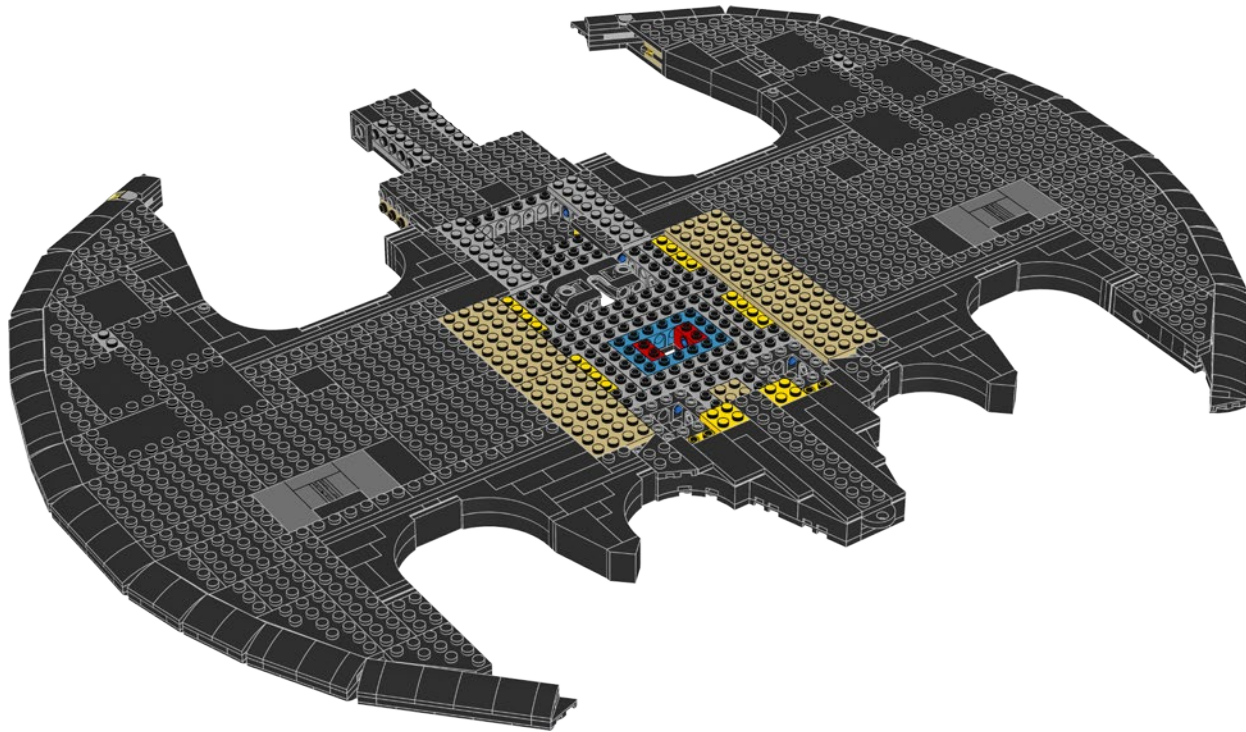
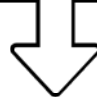
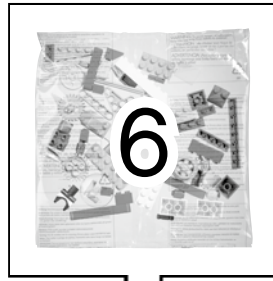
237





- 1x 
- 2x 
- 3x 
- 1x 

238

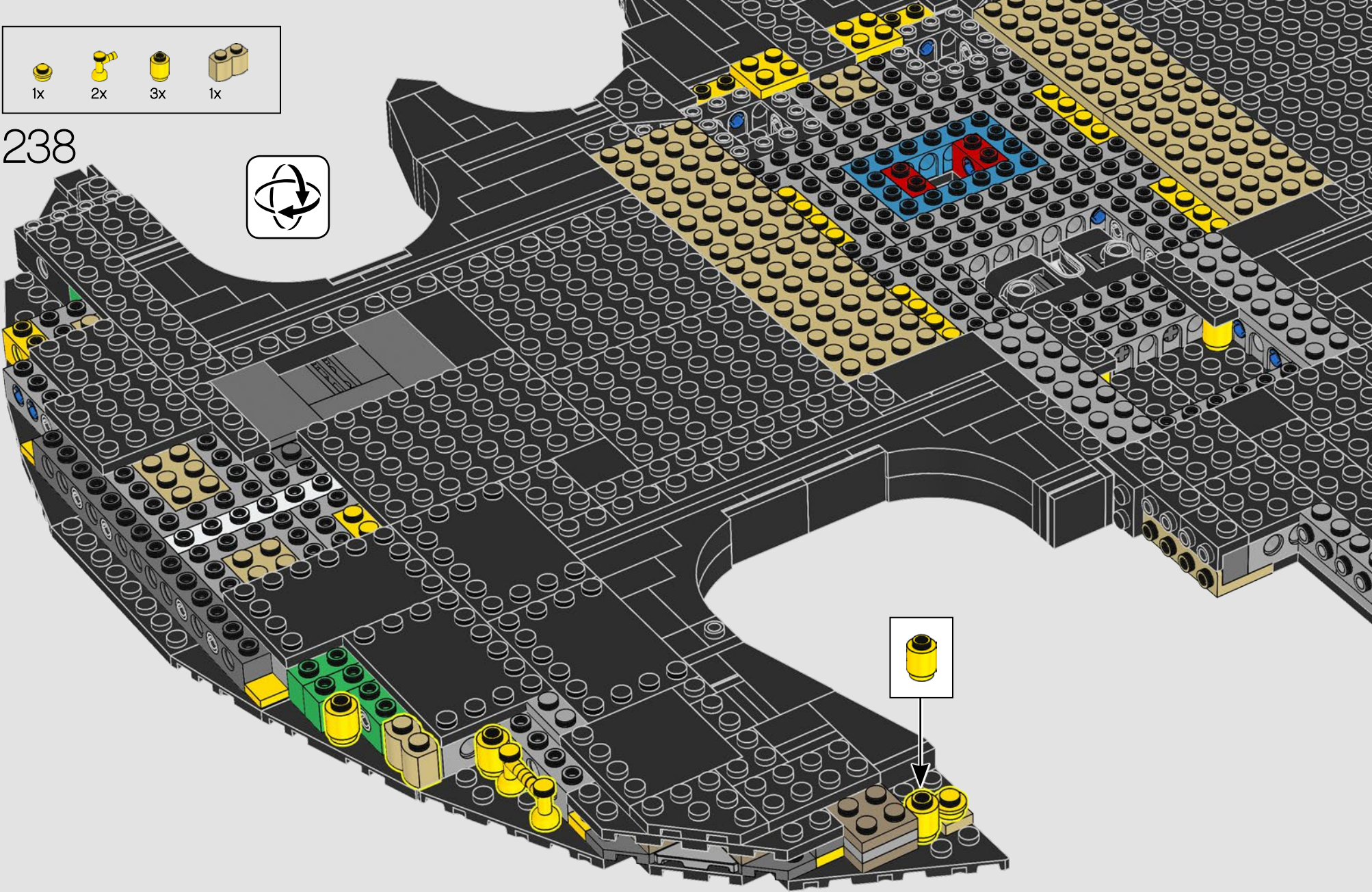



239

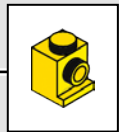
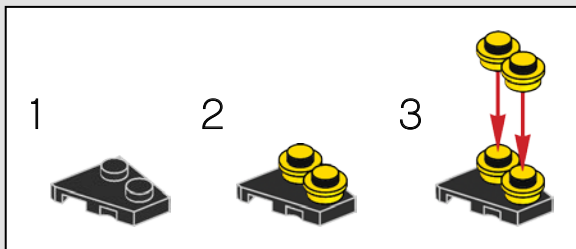
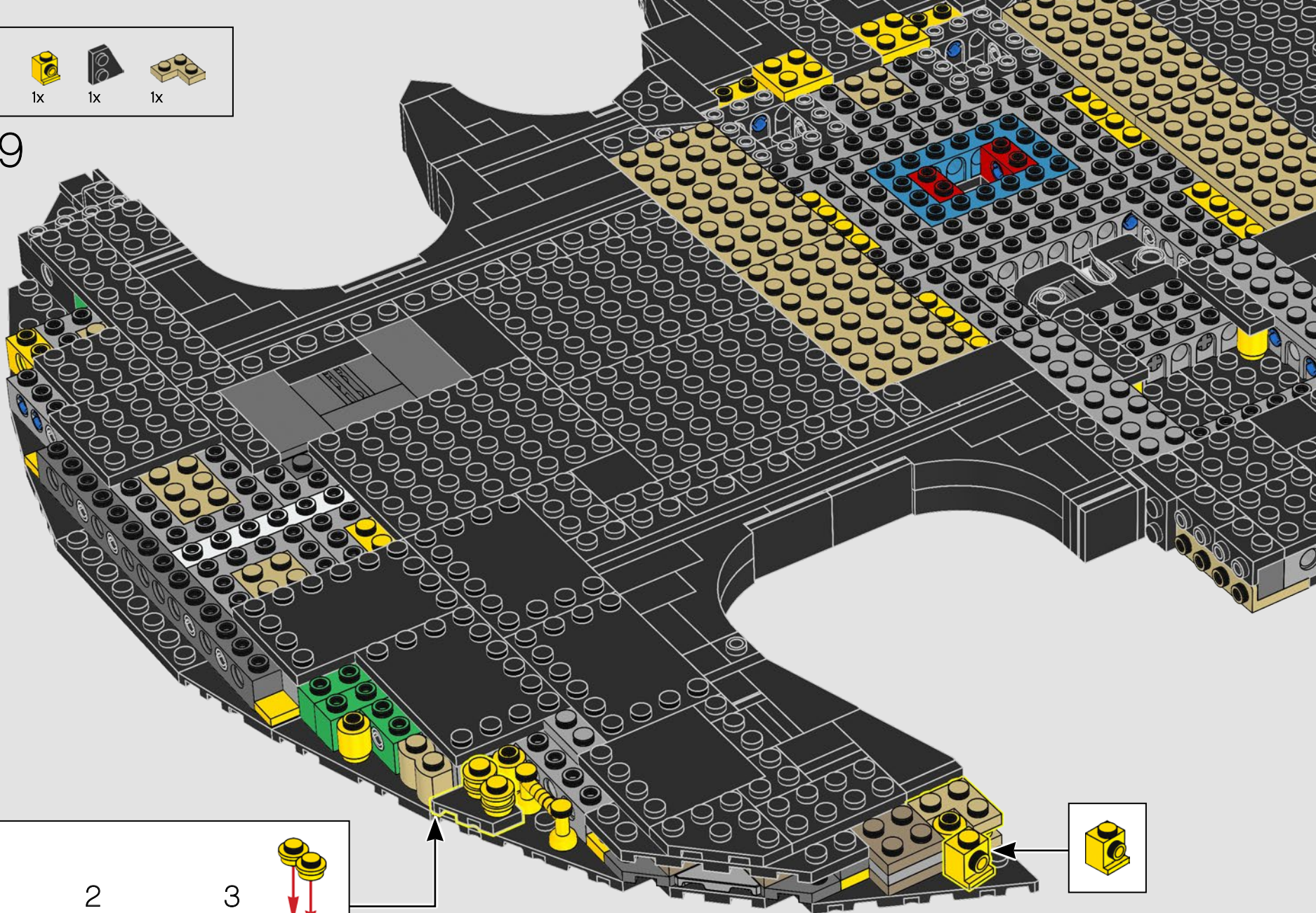

1x 2x

240

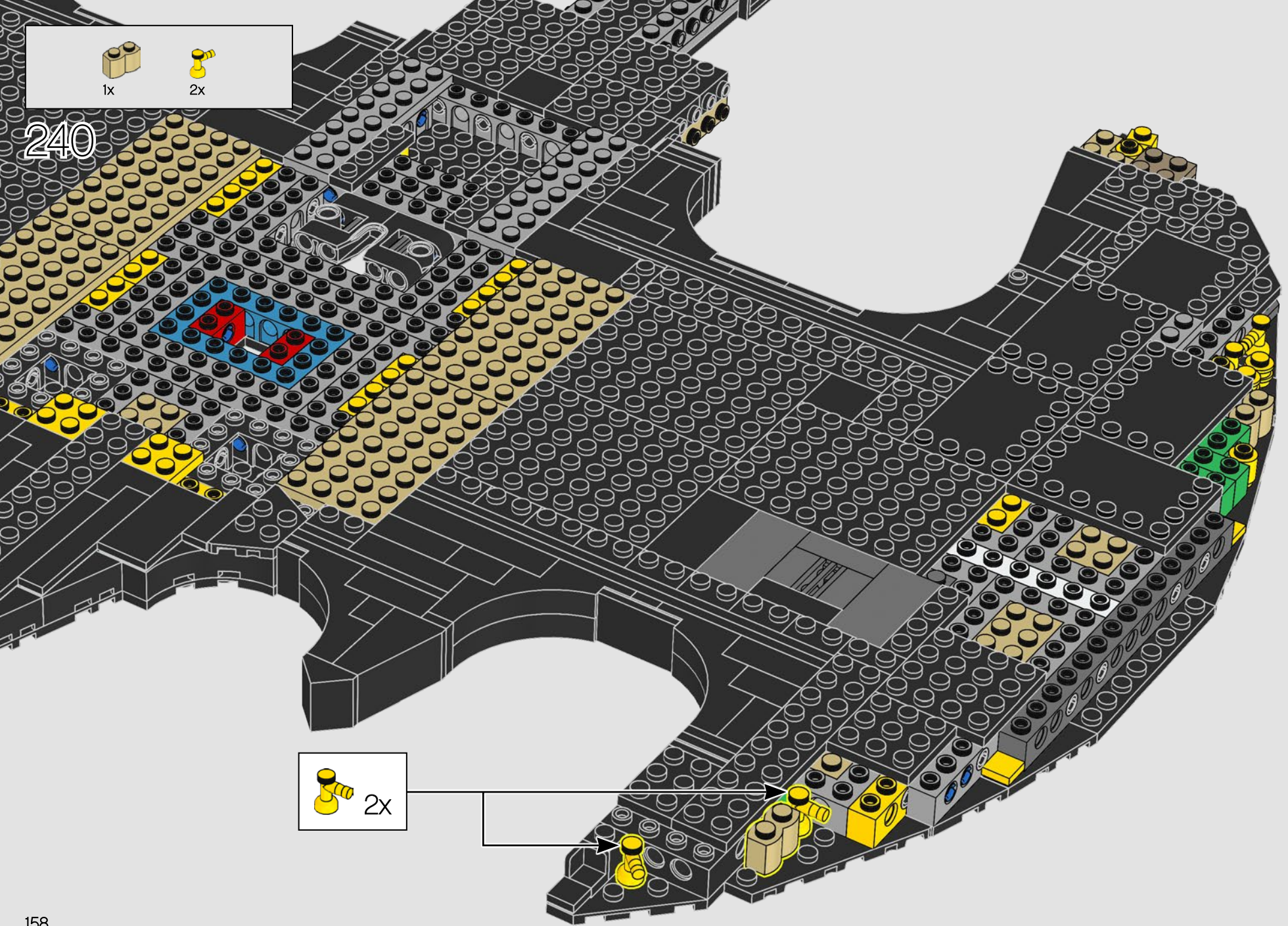

2x

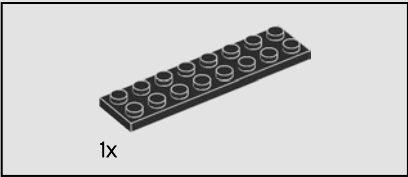
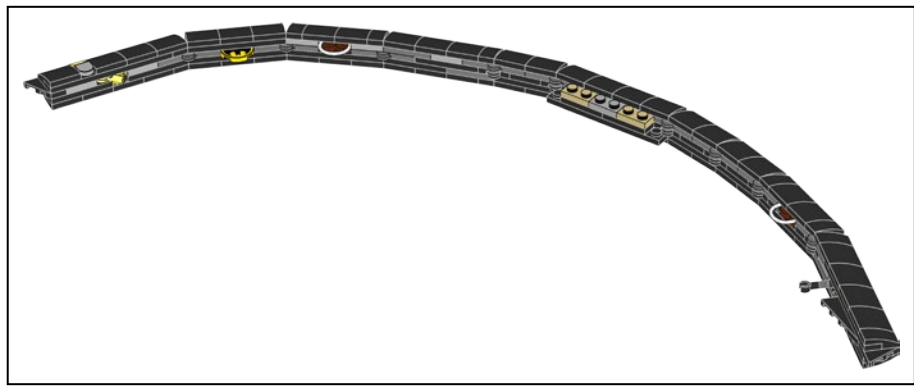

241

1x

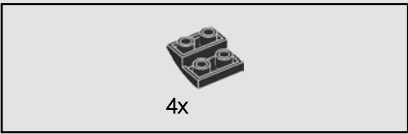
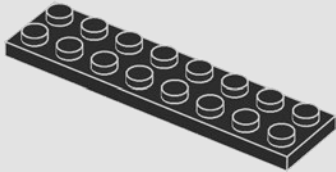

242

4x

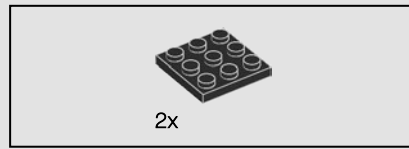
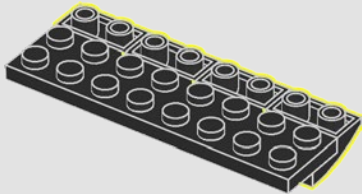

2x

243

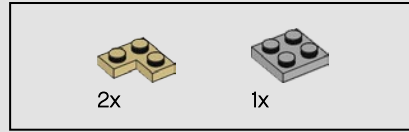
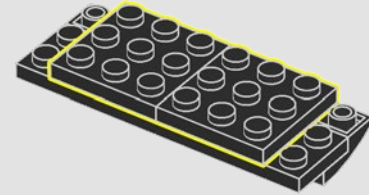

2x

1x

244

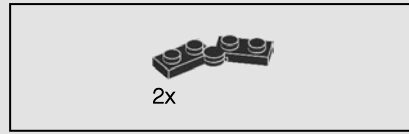
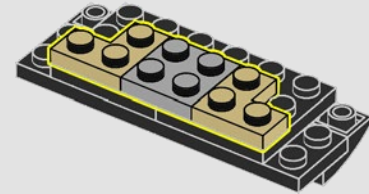

2x

245

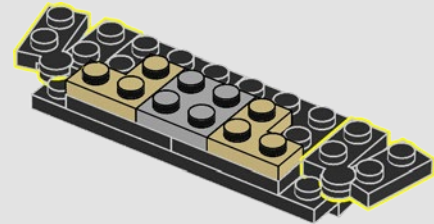

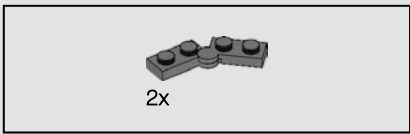

246

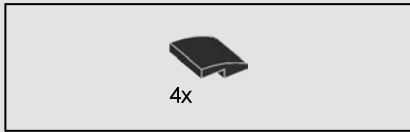
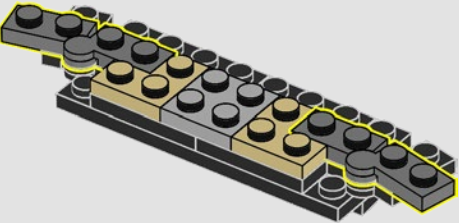

247

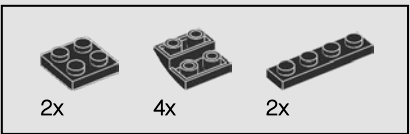
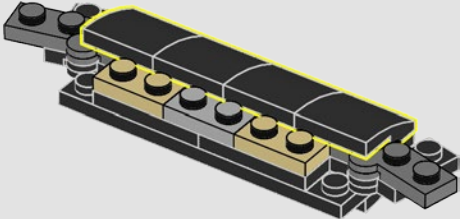

248

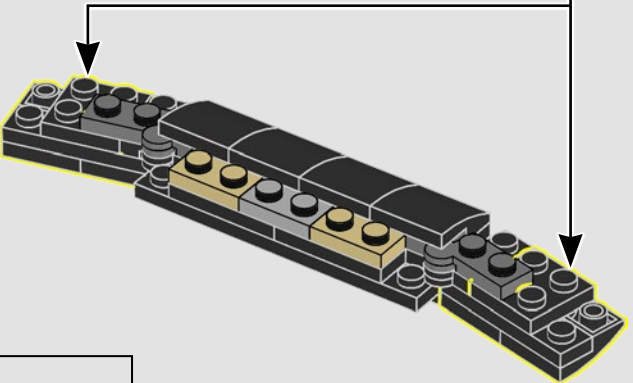
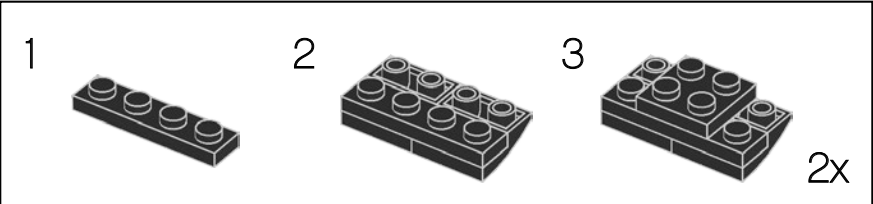

249

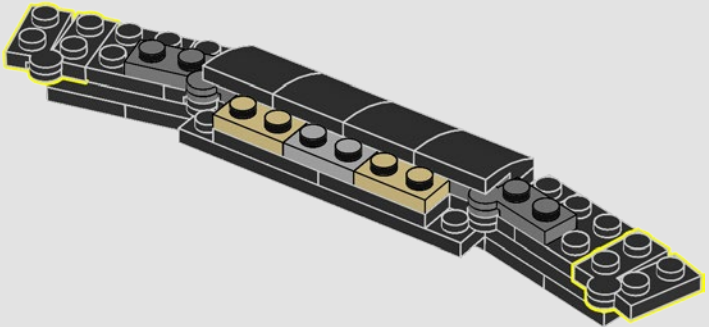



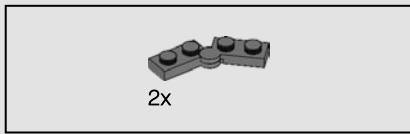

250

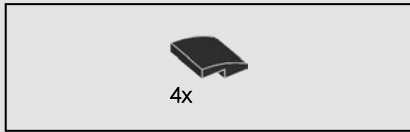
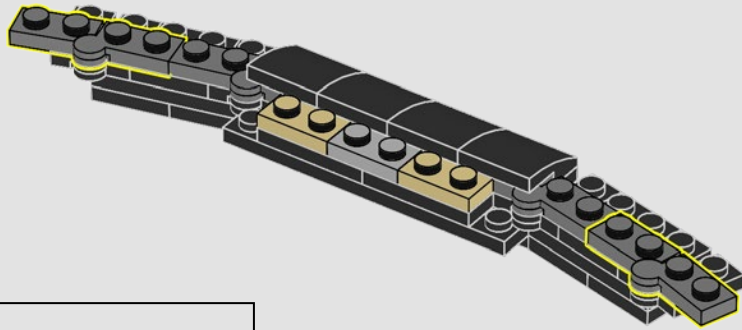

251

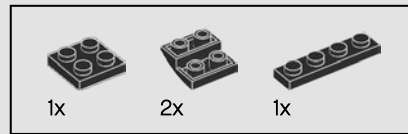
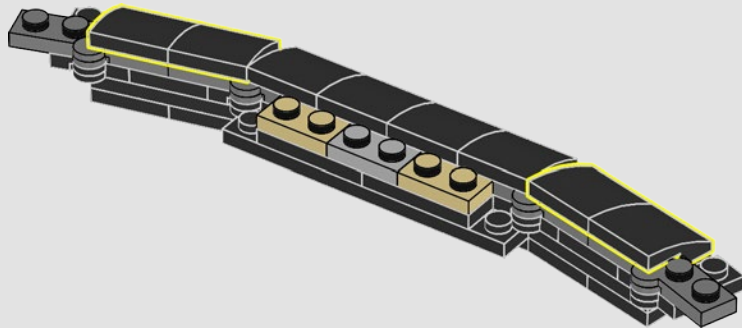

252

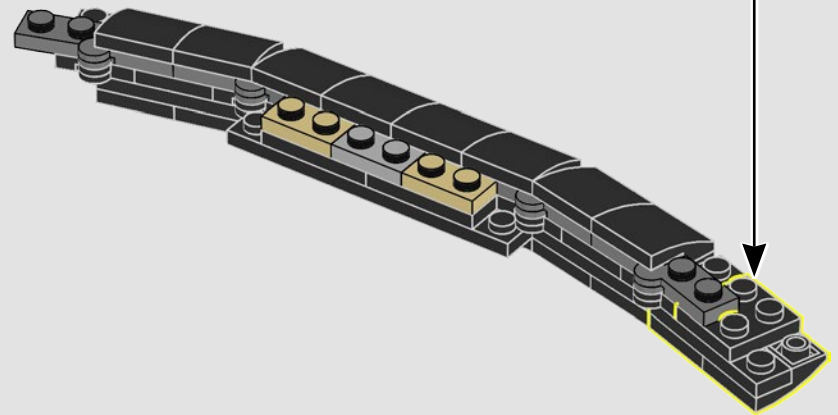
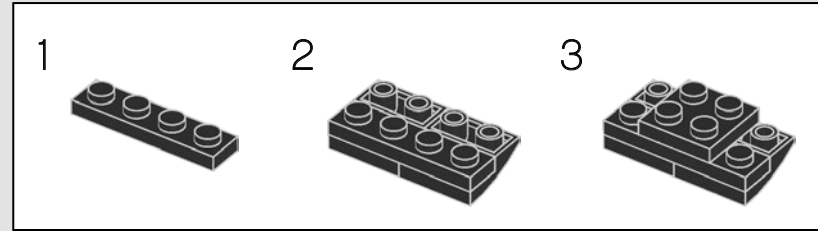

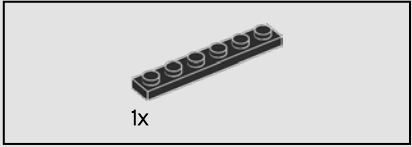
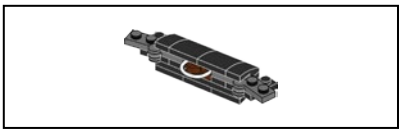

253

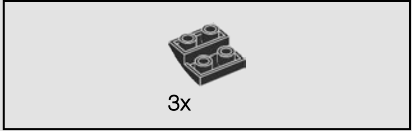
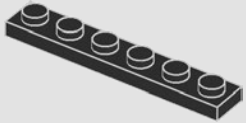

254

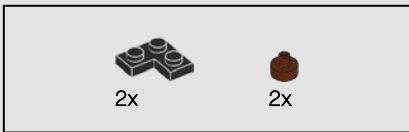
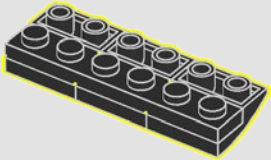

255

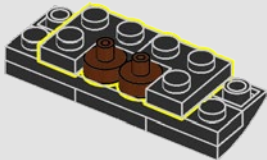

256

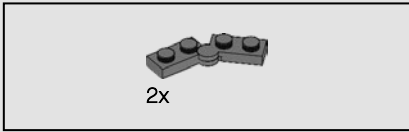
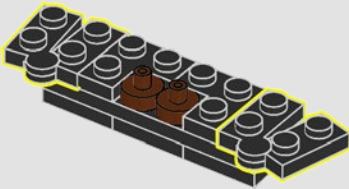

257

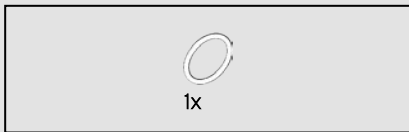
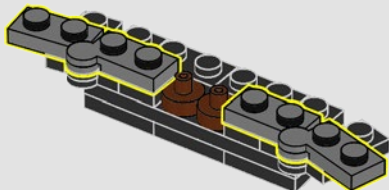

258

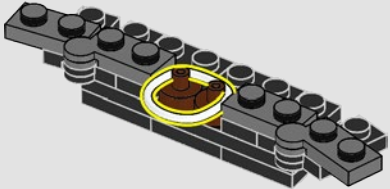

259

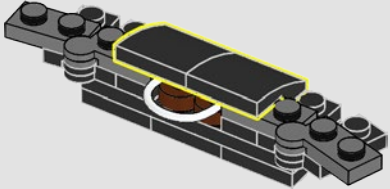

260

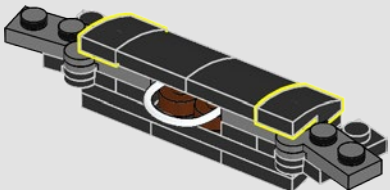

261

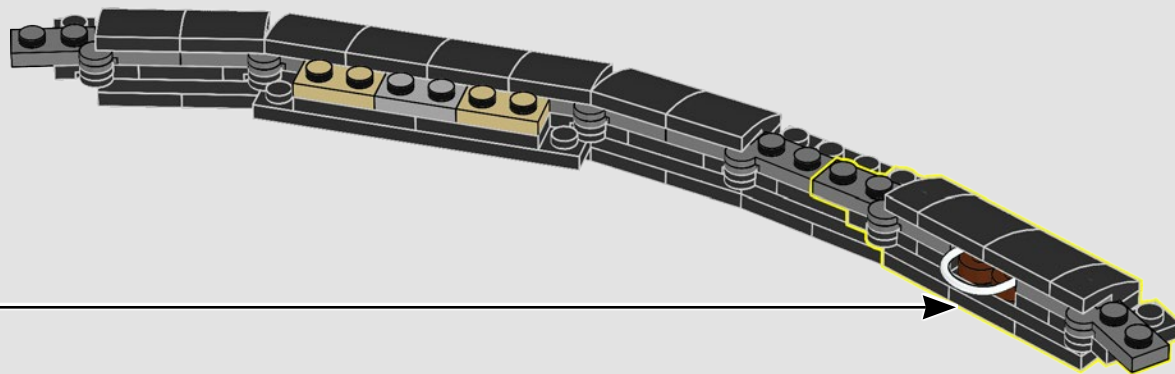

262

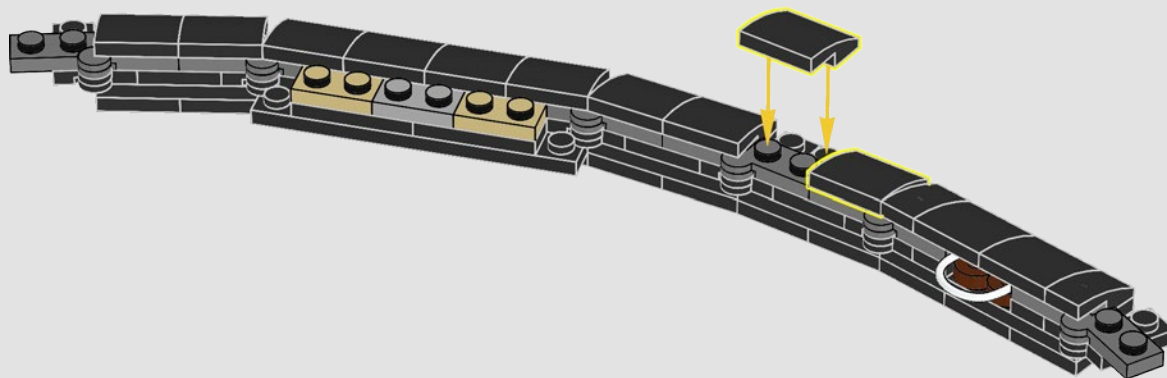

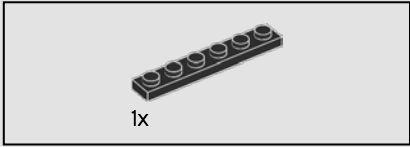
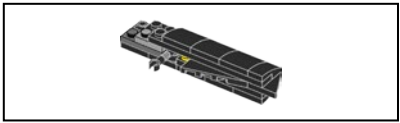

1x

263

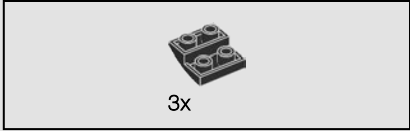
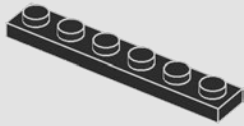

3x

264

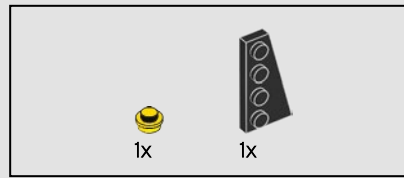
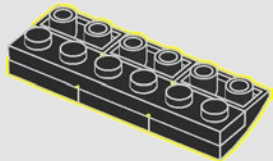

1x

1x

265

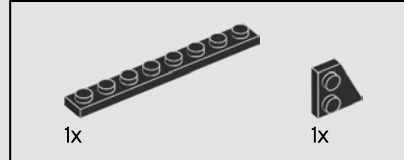
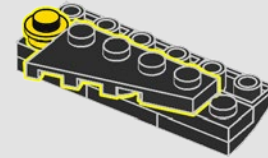

1x

1x

266

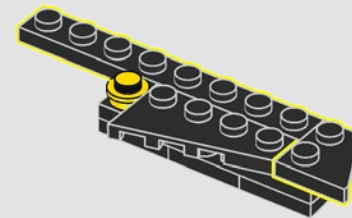

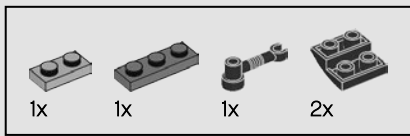

267

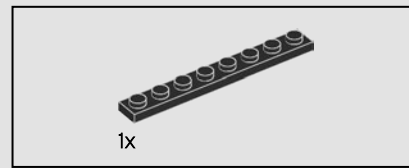
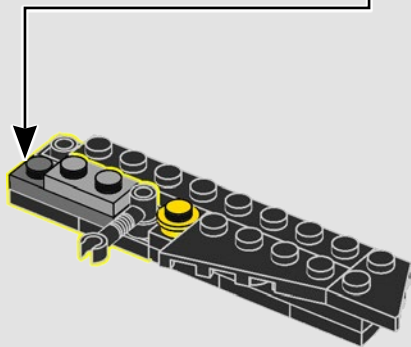
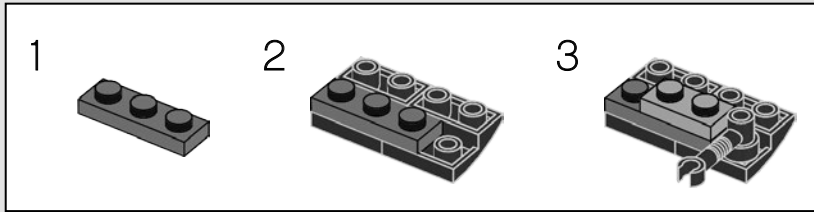

268

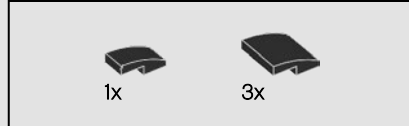
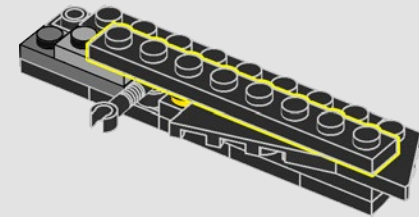

269

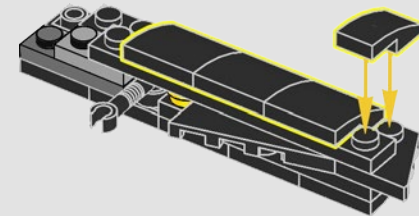

270

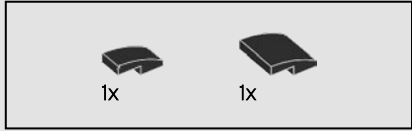
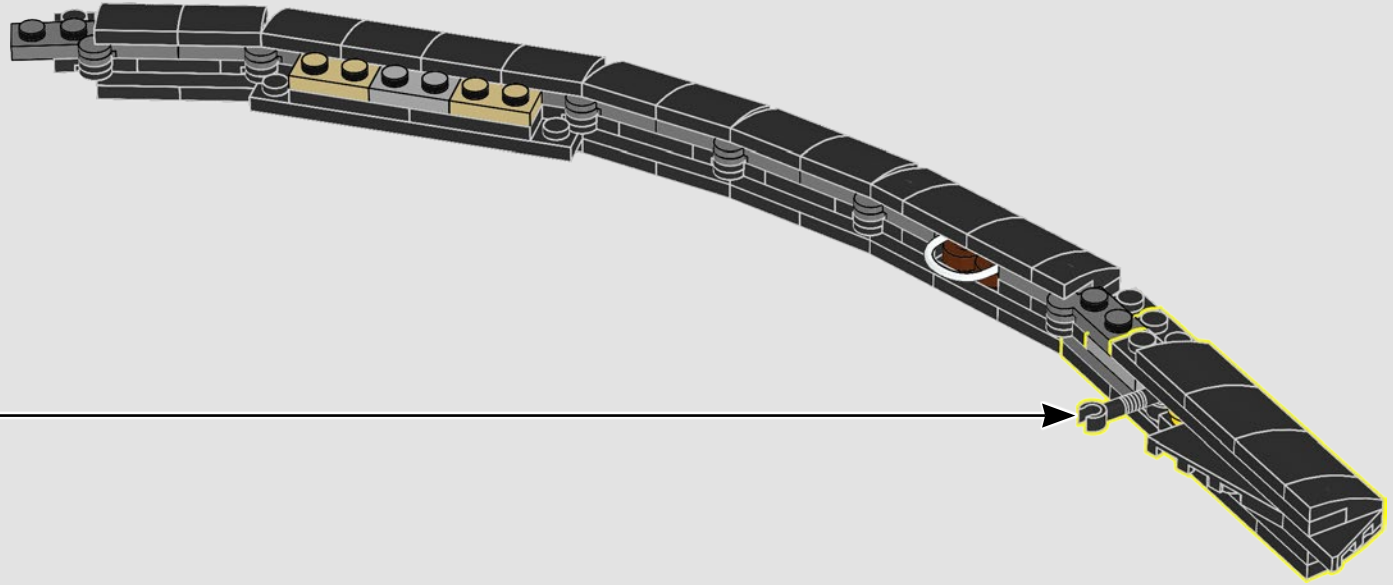

271

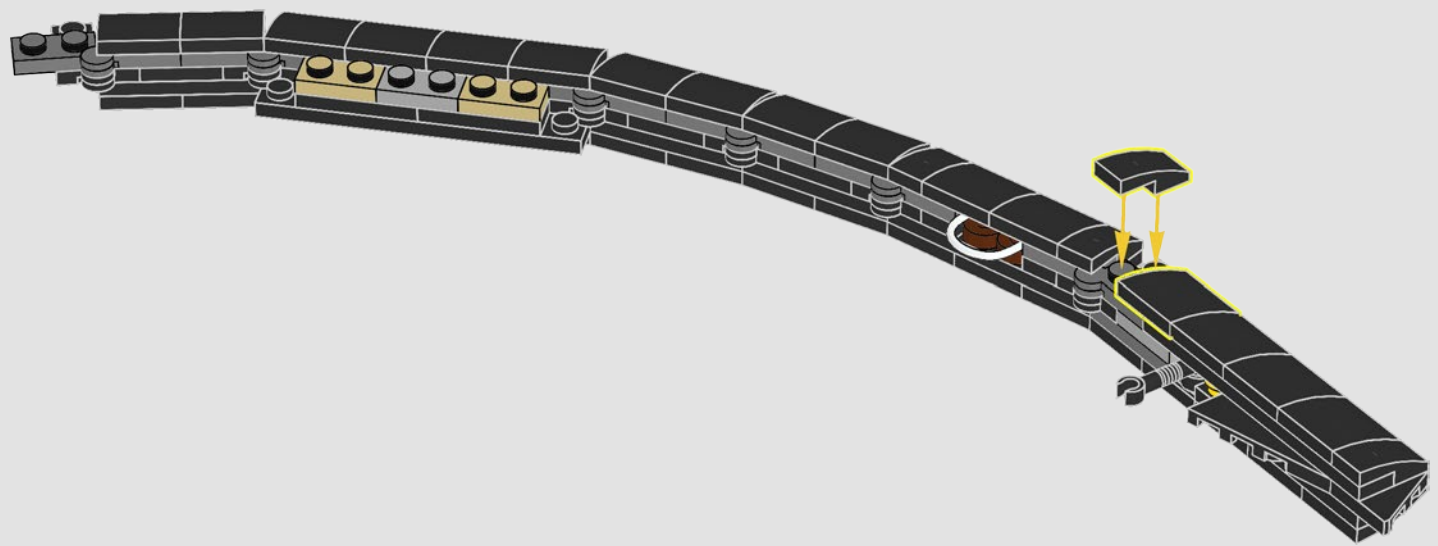

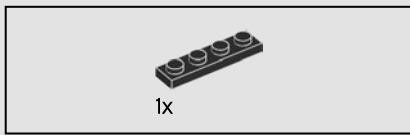

272

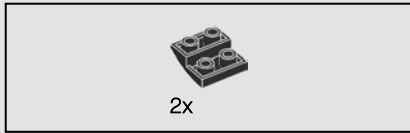
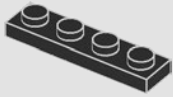

273

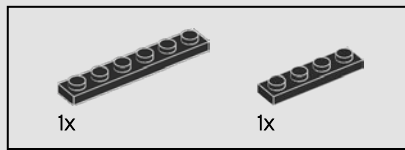
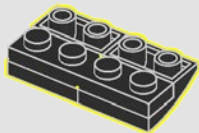

274

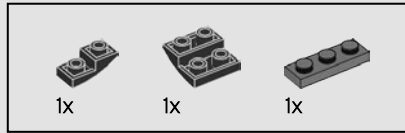
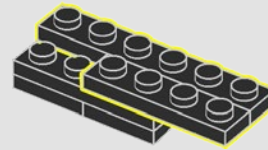

275

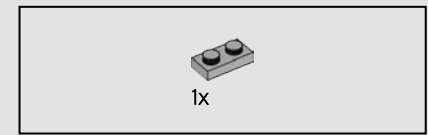
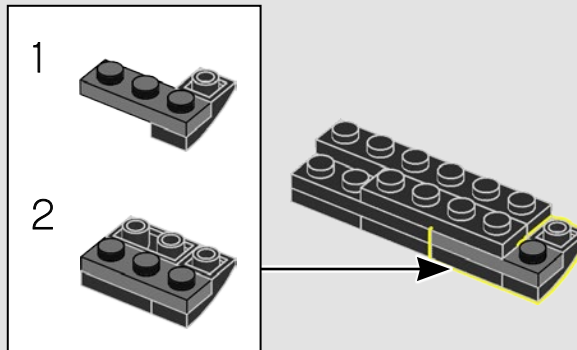

276

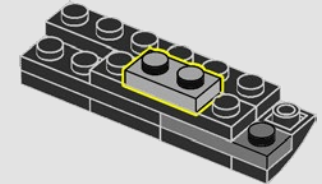

277

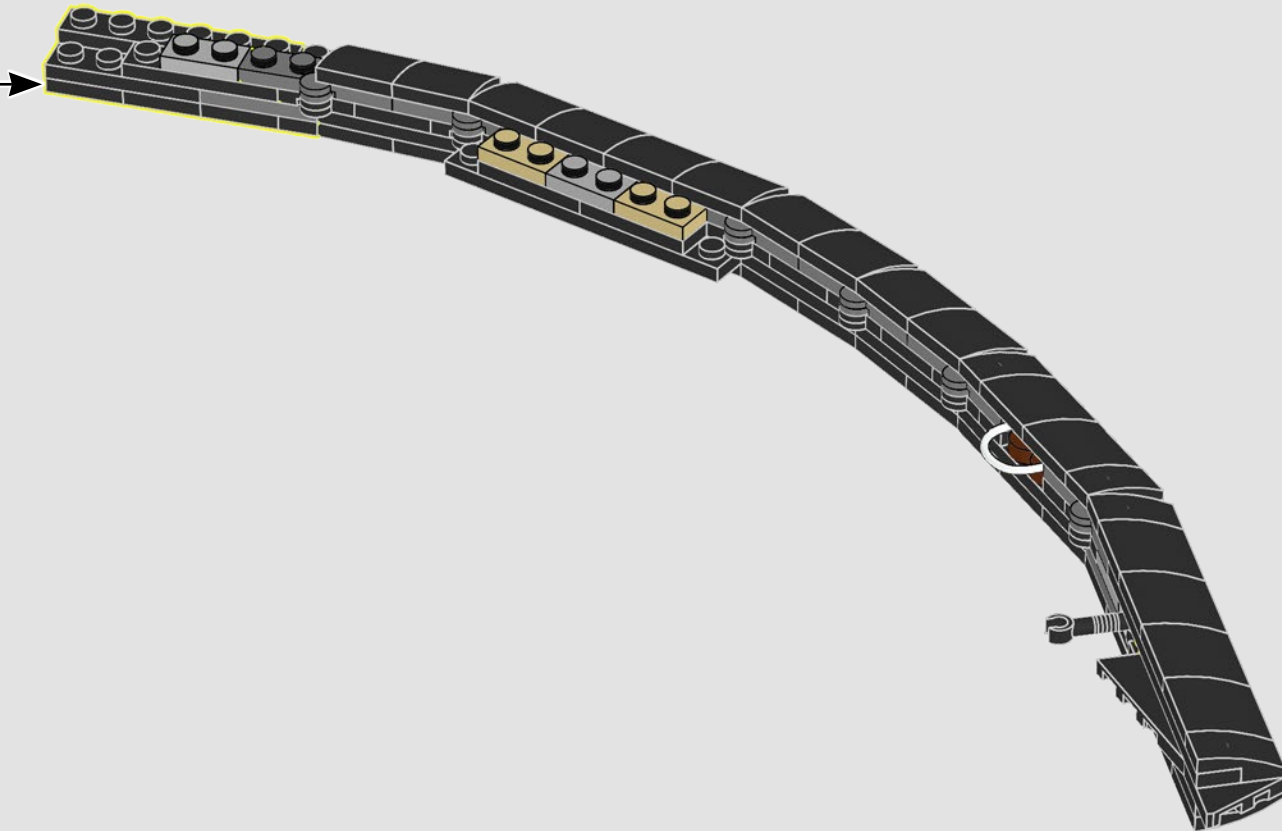



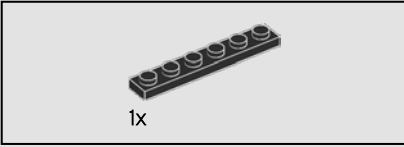
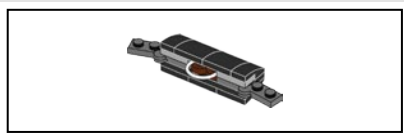

1x

278

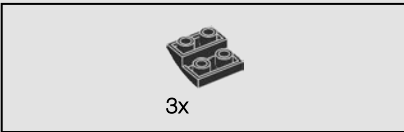
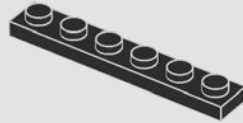

3x

279

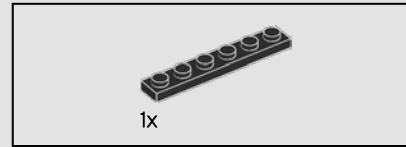
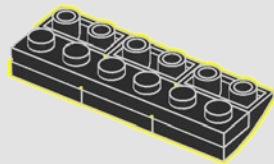

1x

280

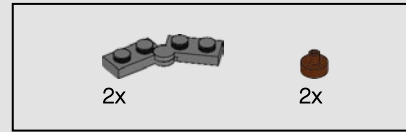
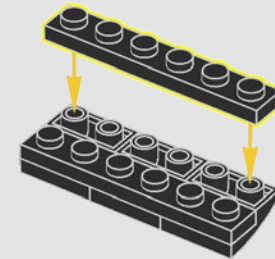

2x

2x

281

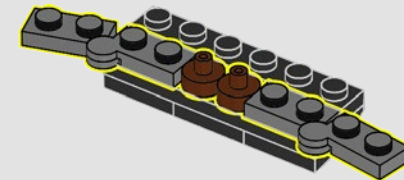



2x

282

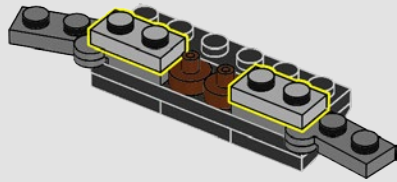

1x

283

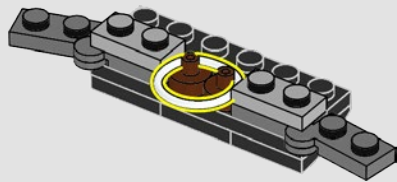

2x

284

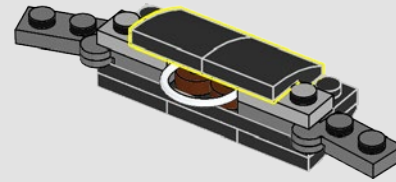

2x

285

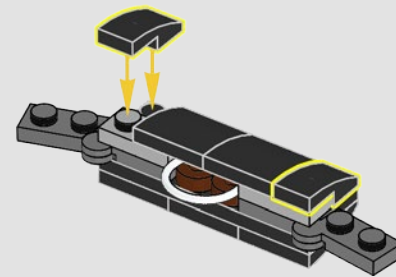

286

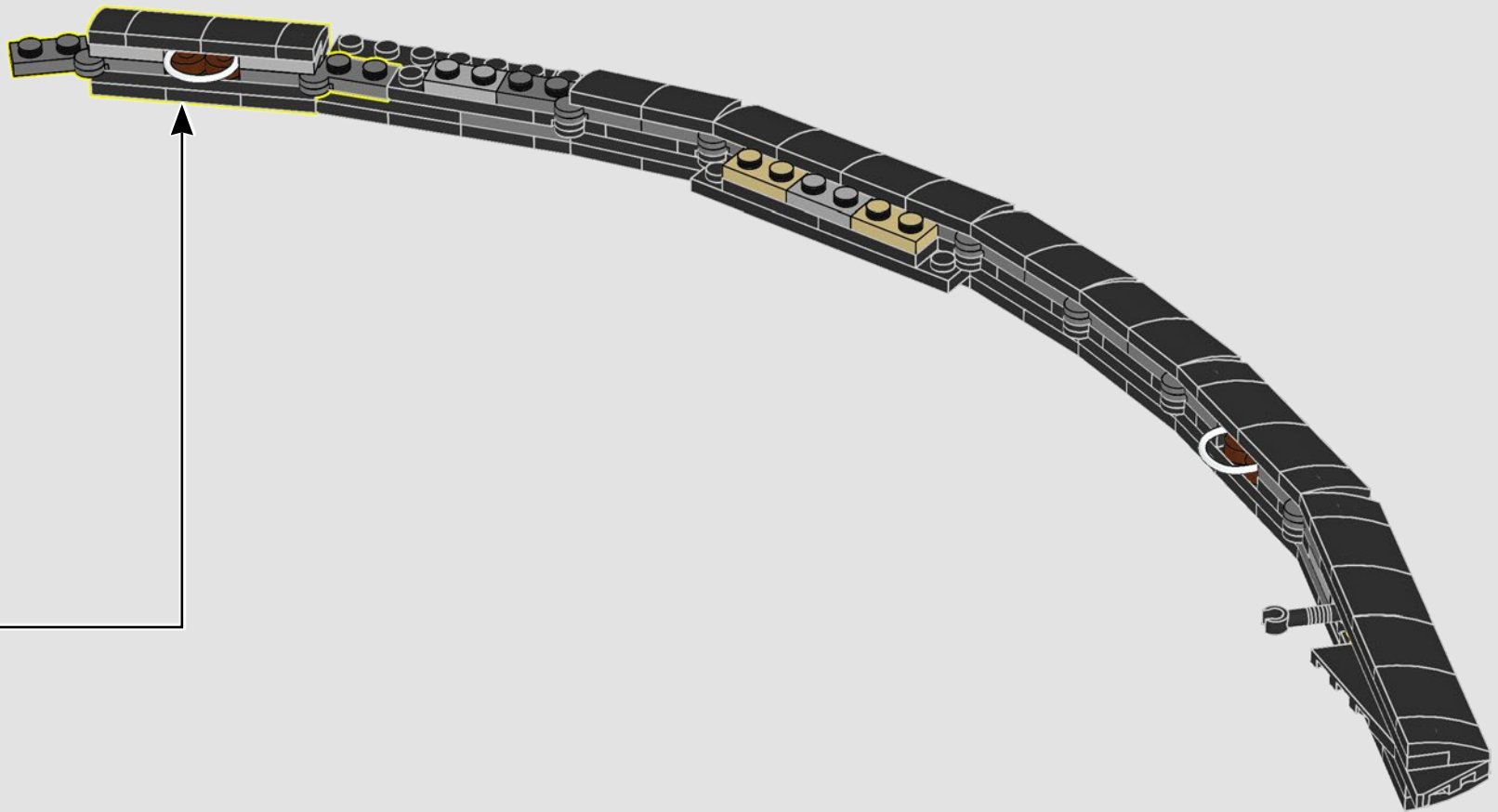

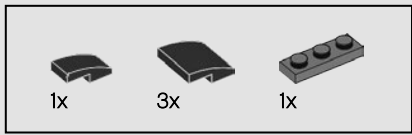

287

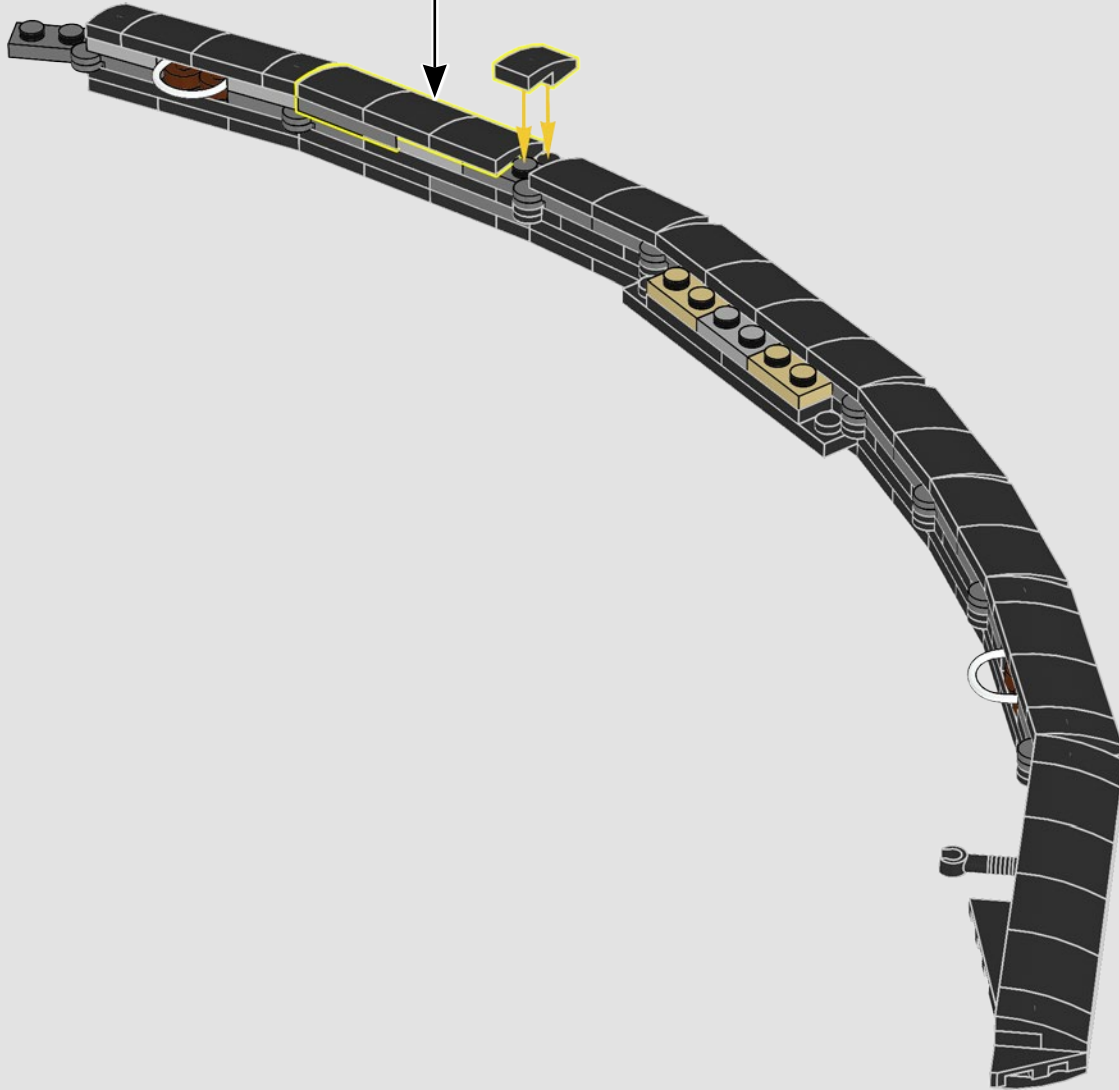
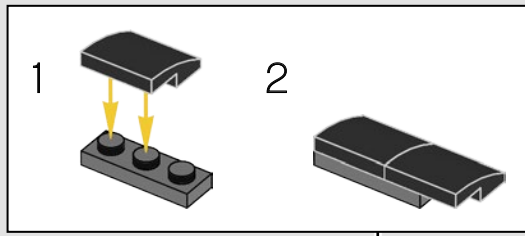

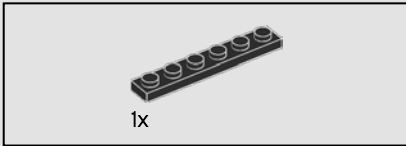
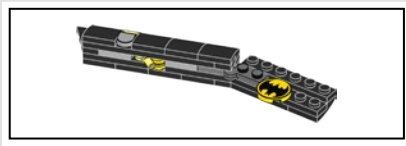

288

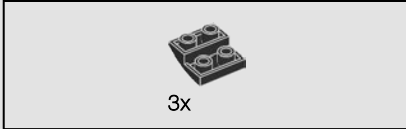
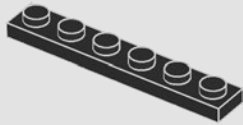

289

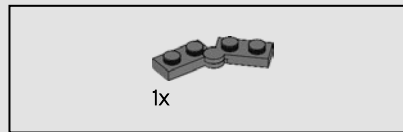
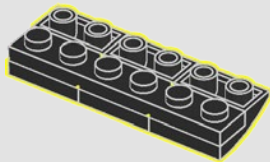

290

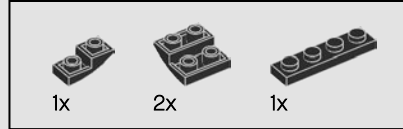
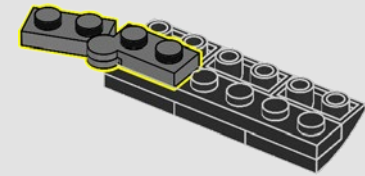

291

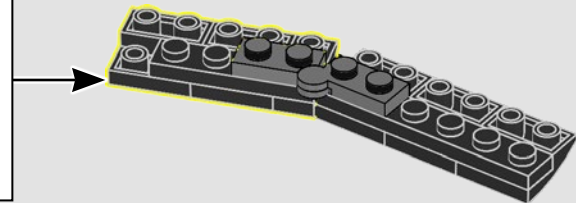
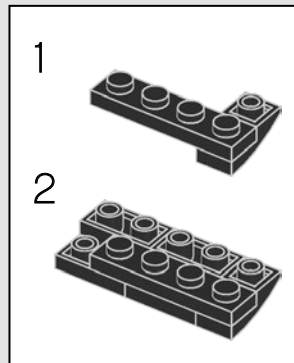

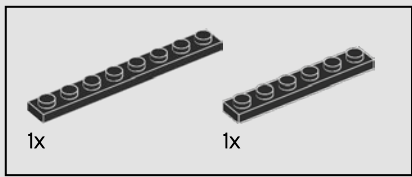

292

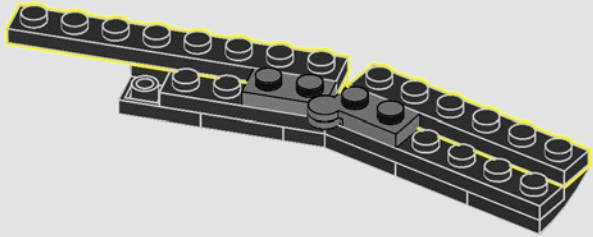

293

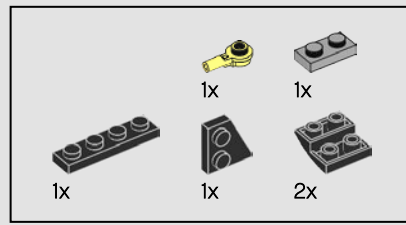
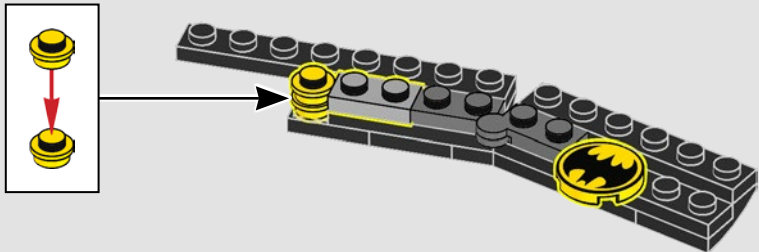

294

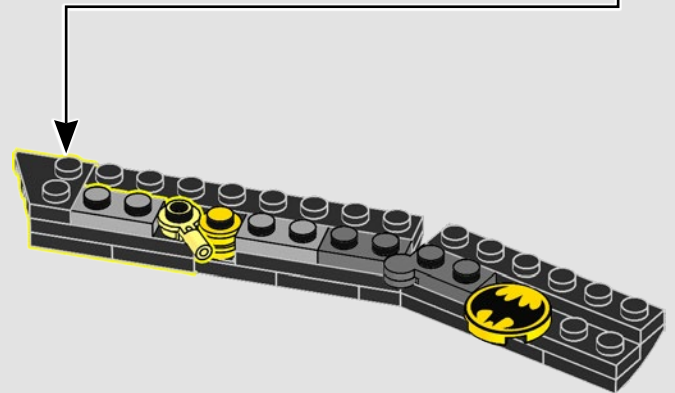
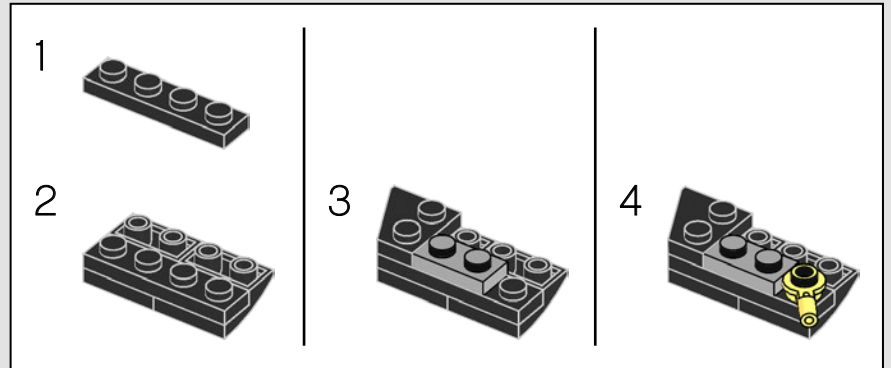

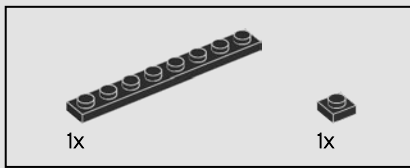

295

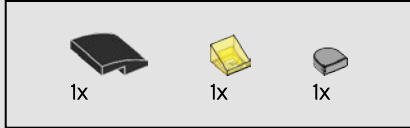
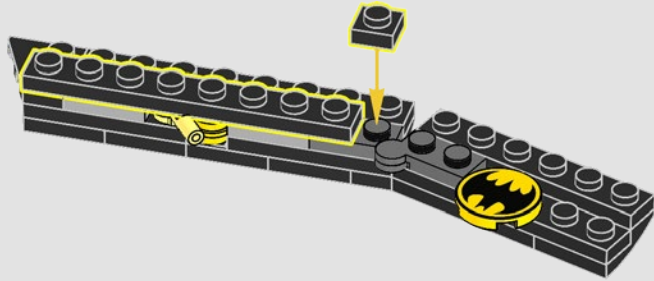

296

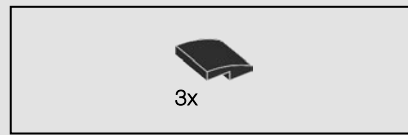
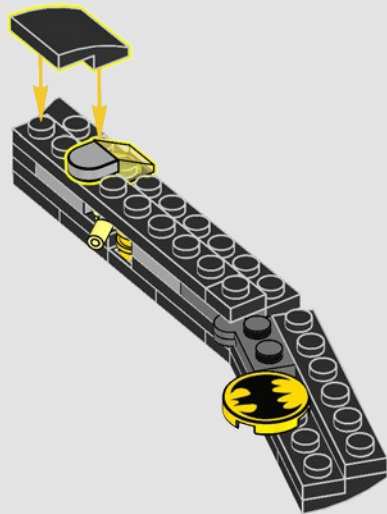

297

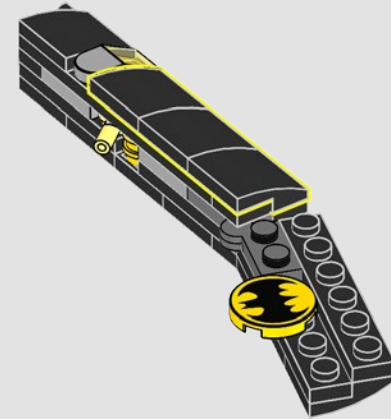

298

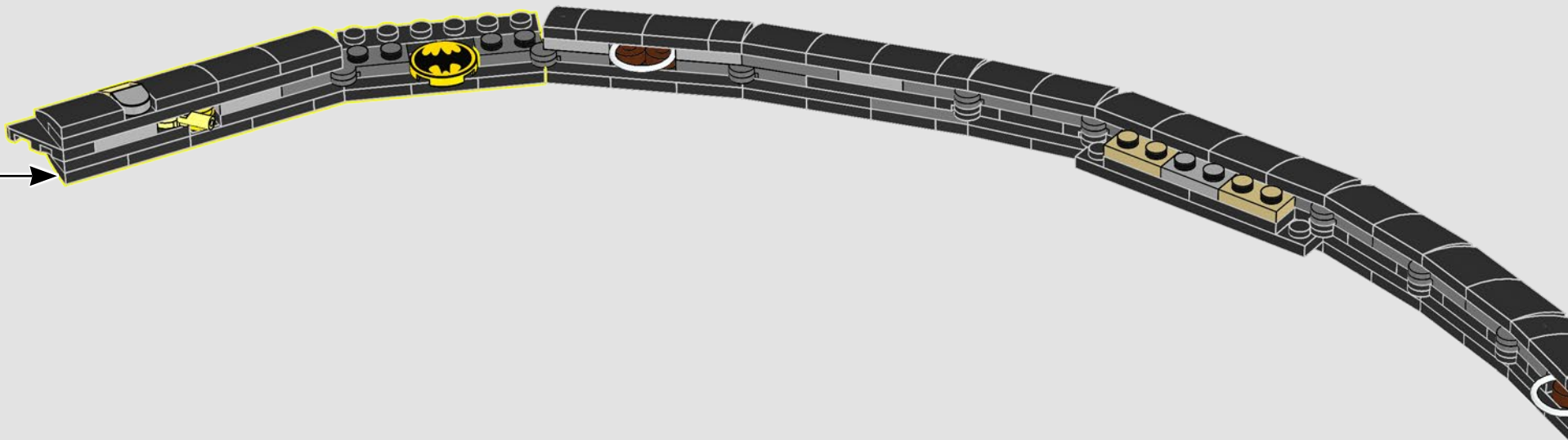



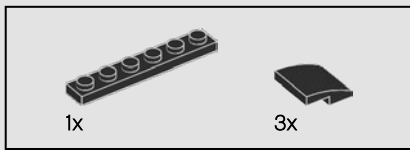

299

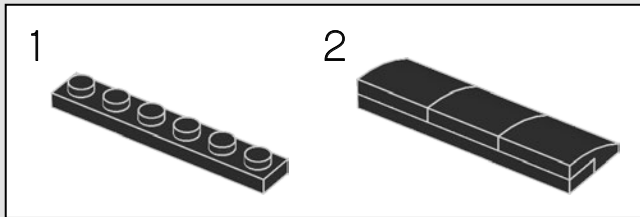

300

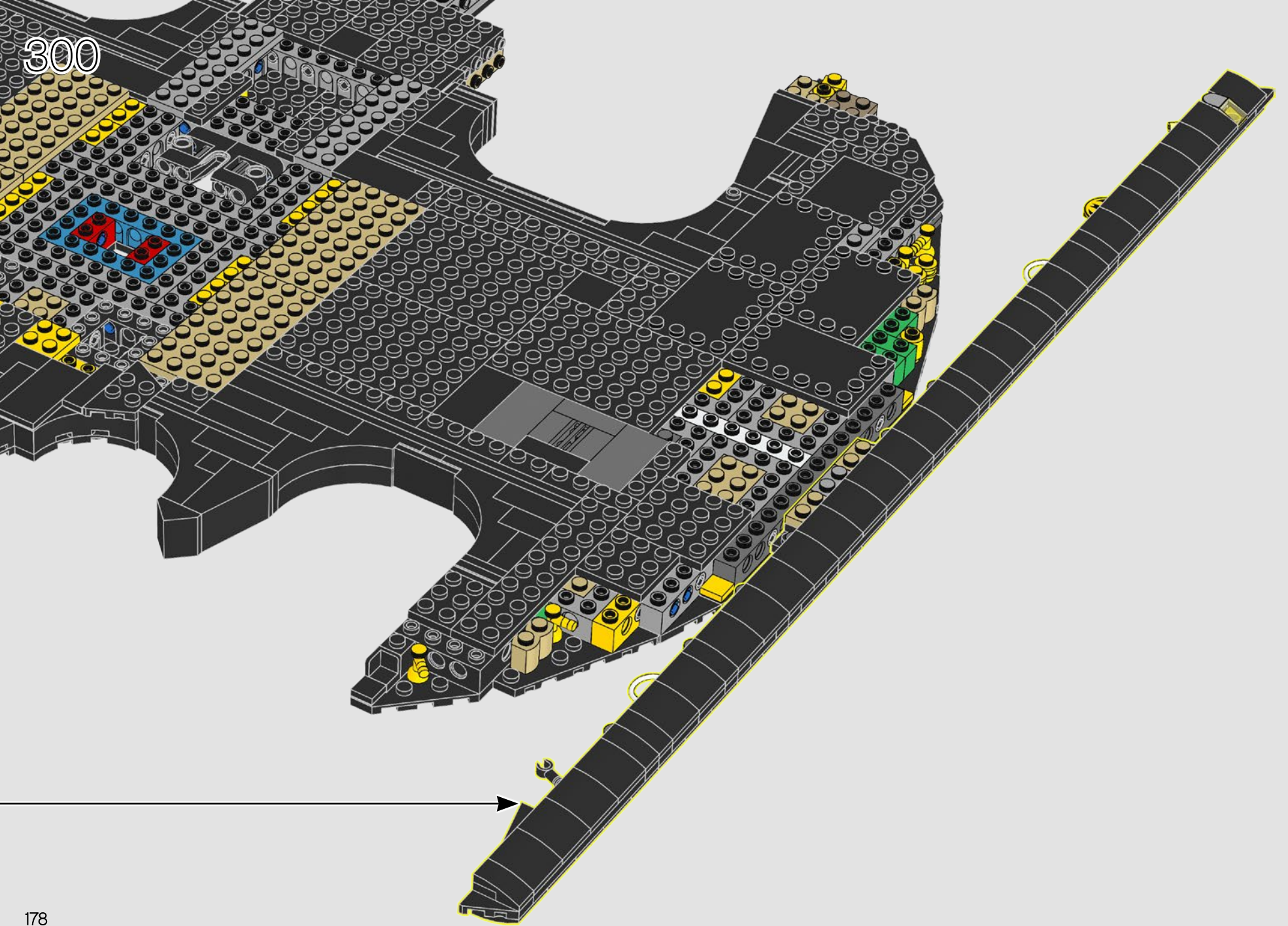

301

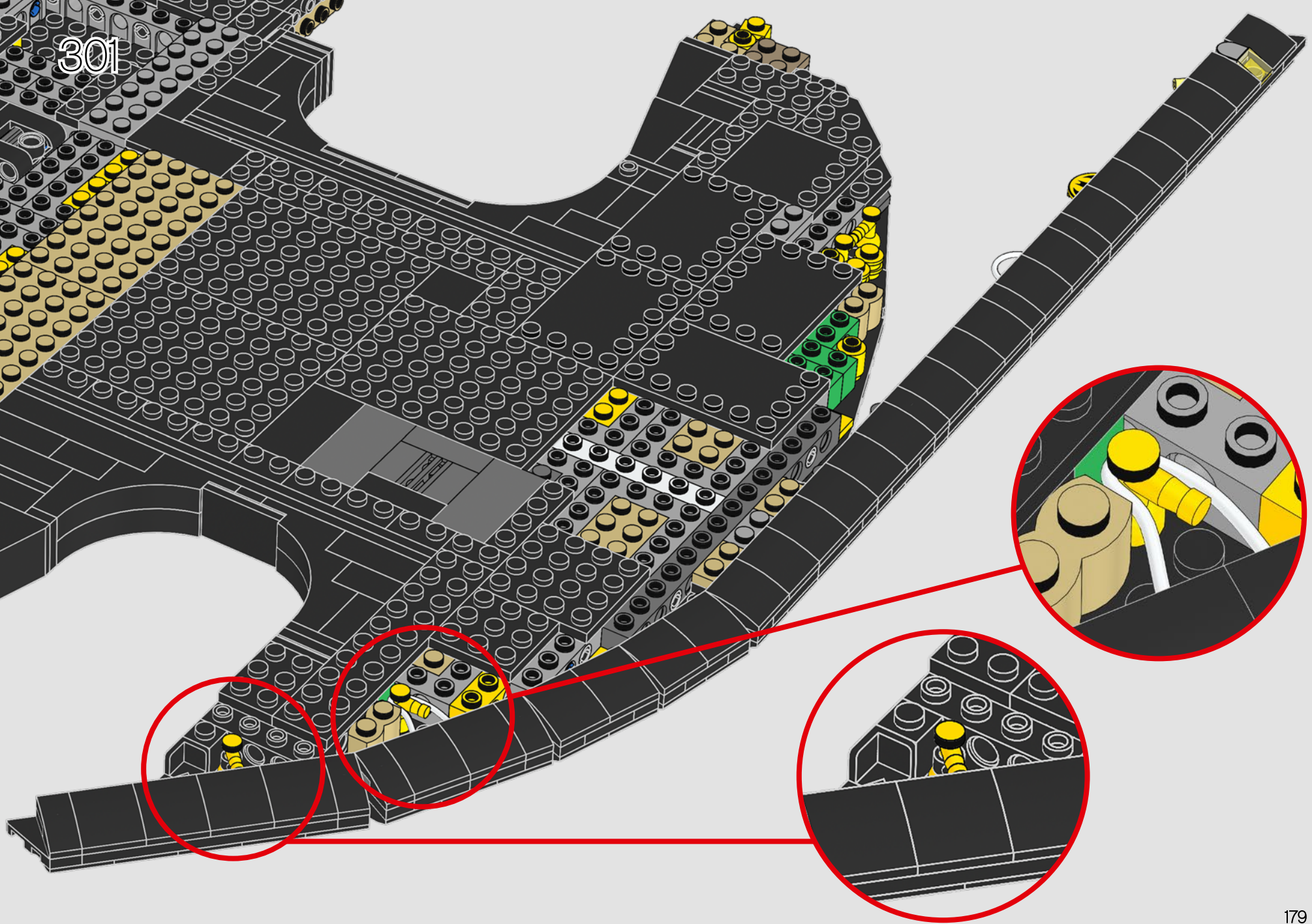



2x

302

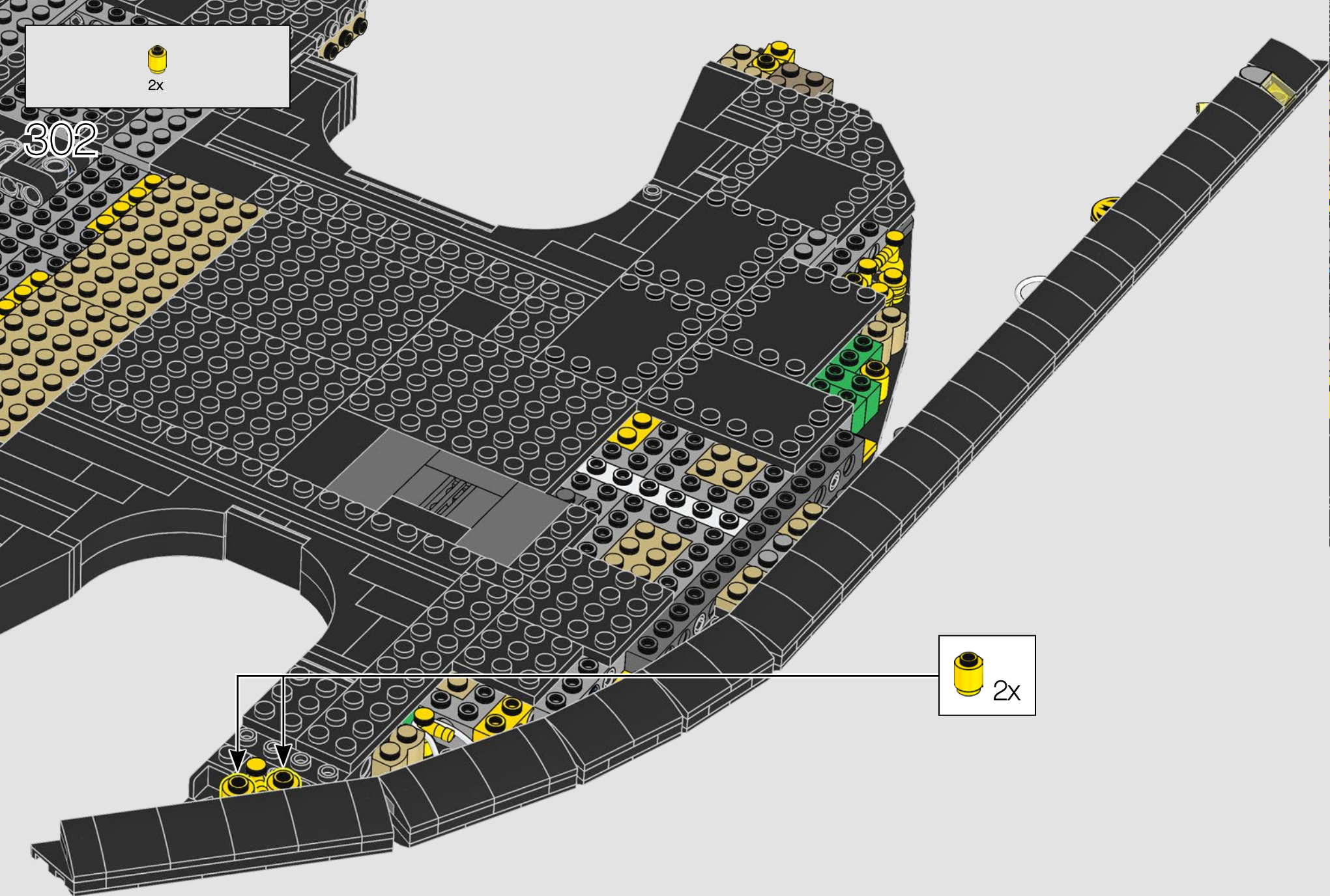

2x

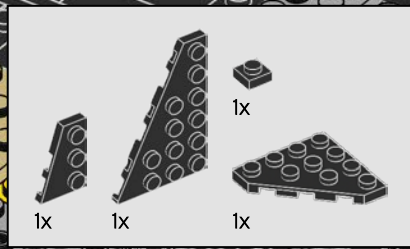

303

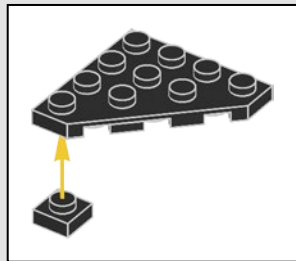

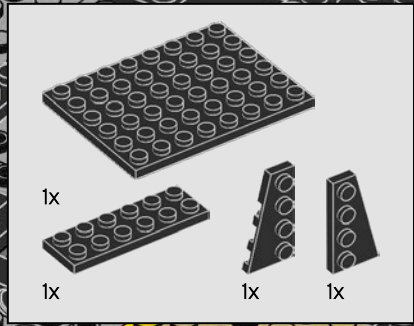

304

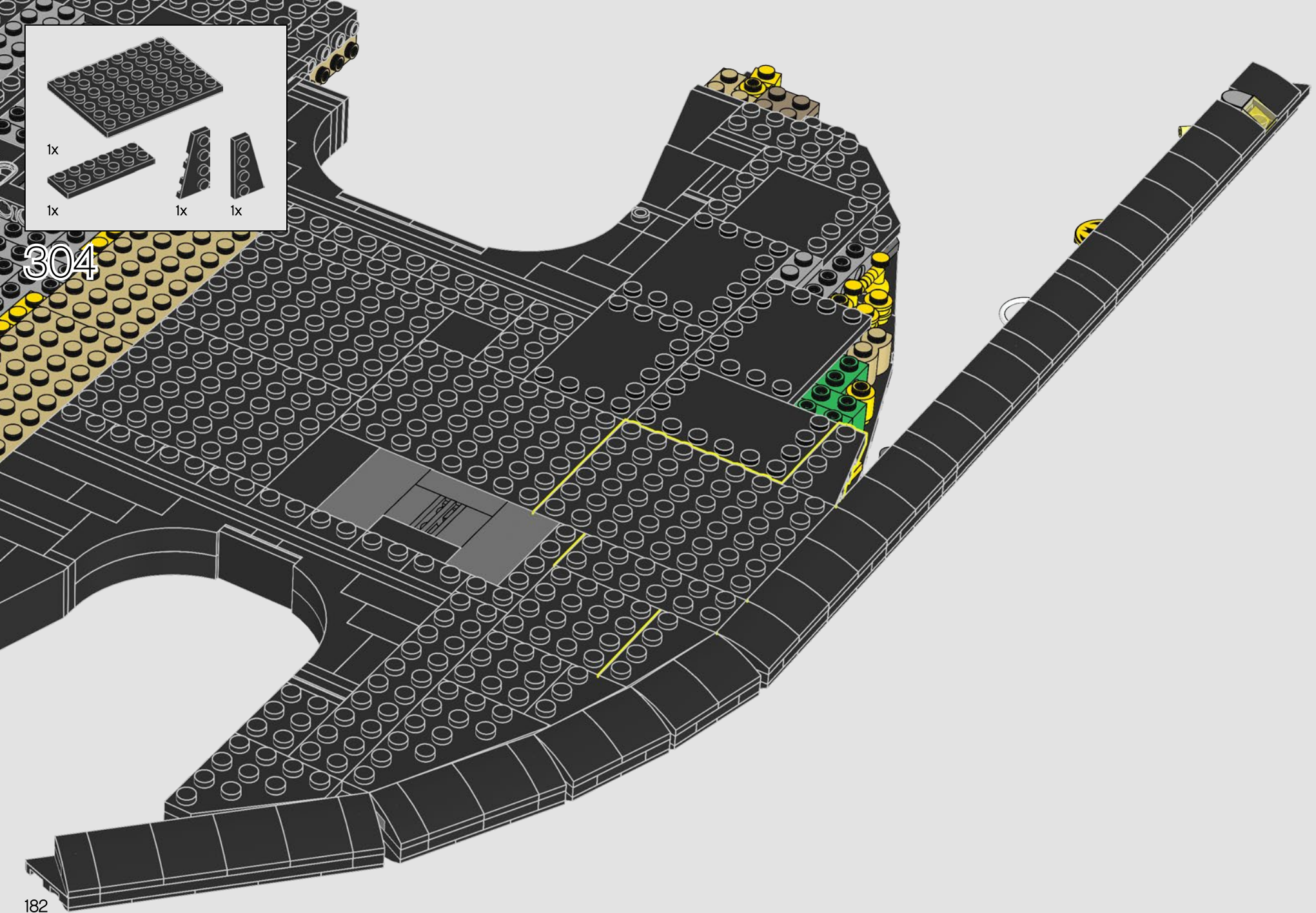

305

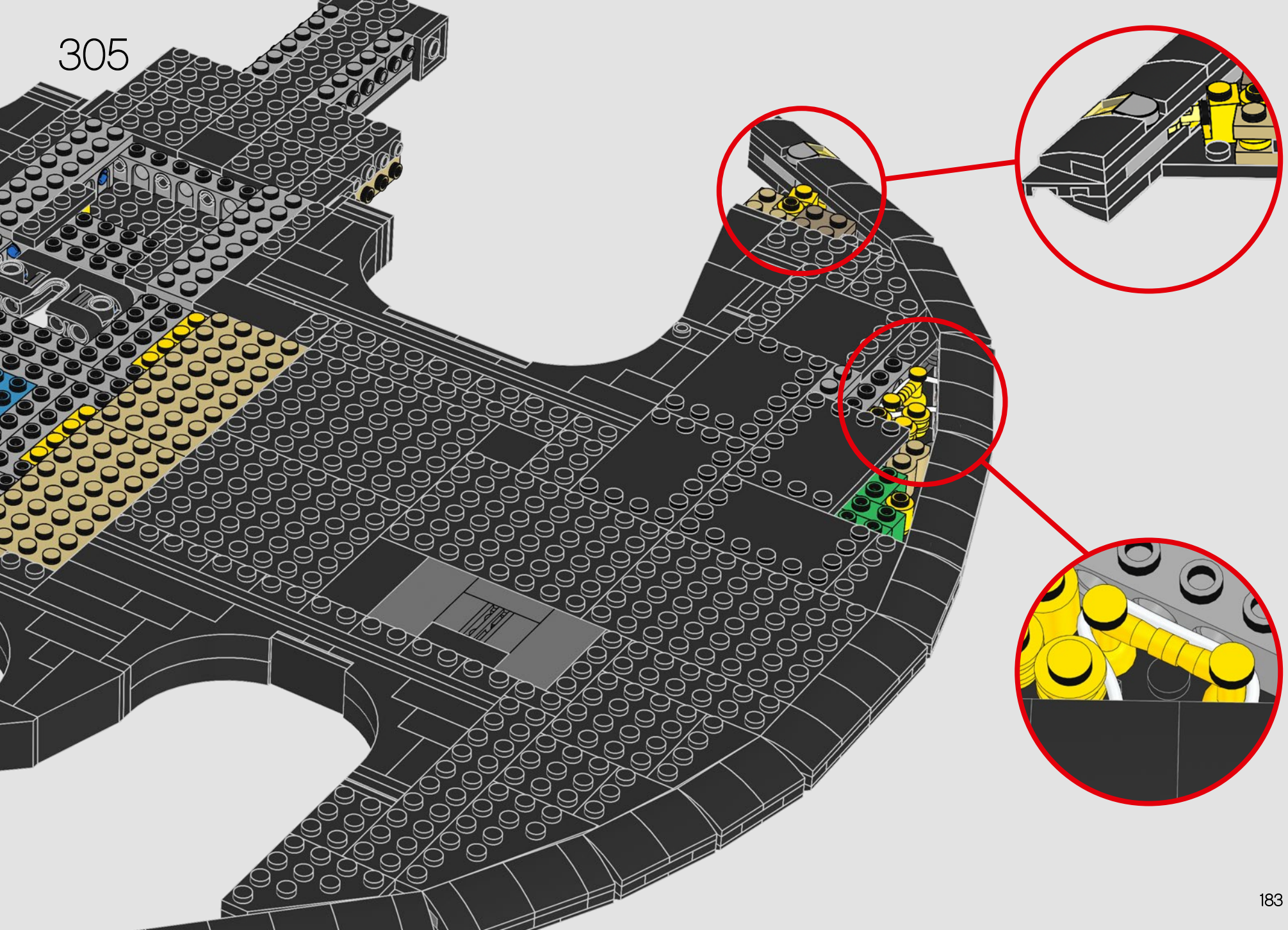

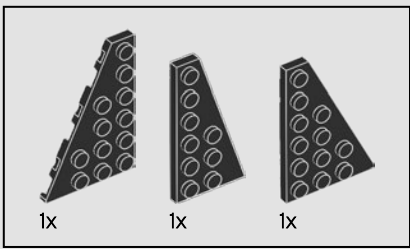

306

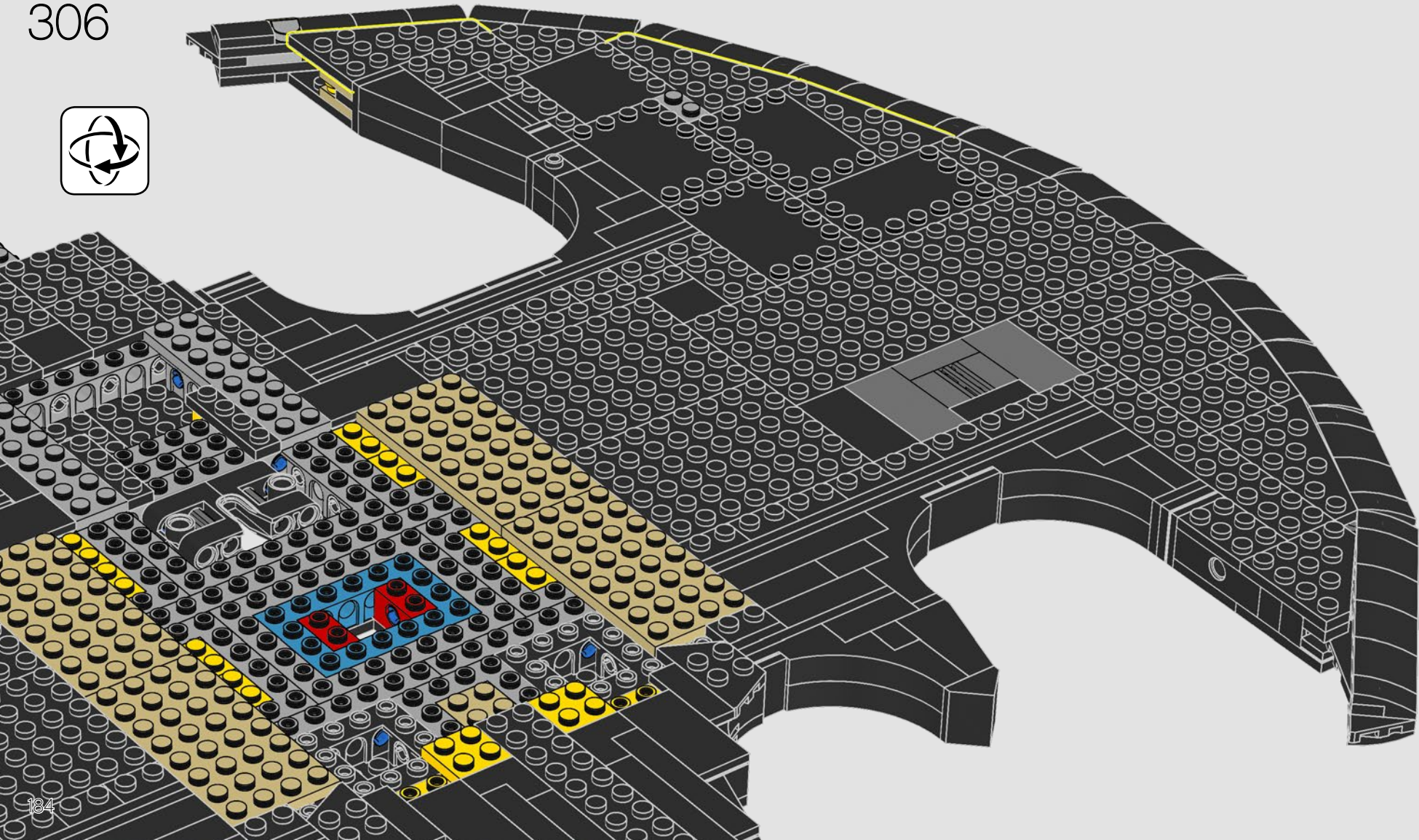



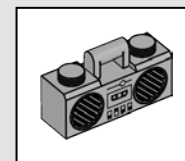
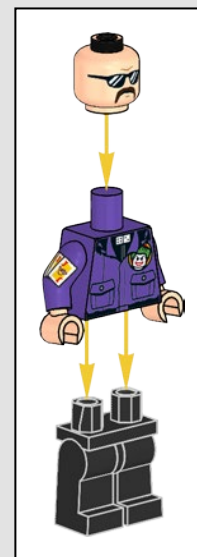
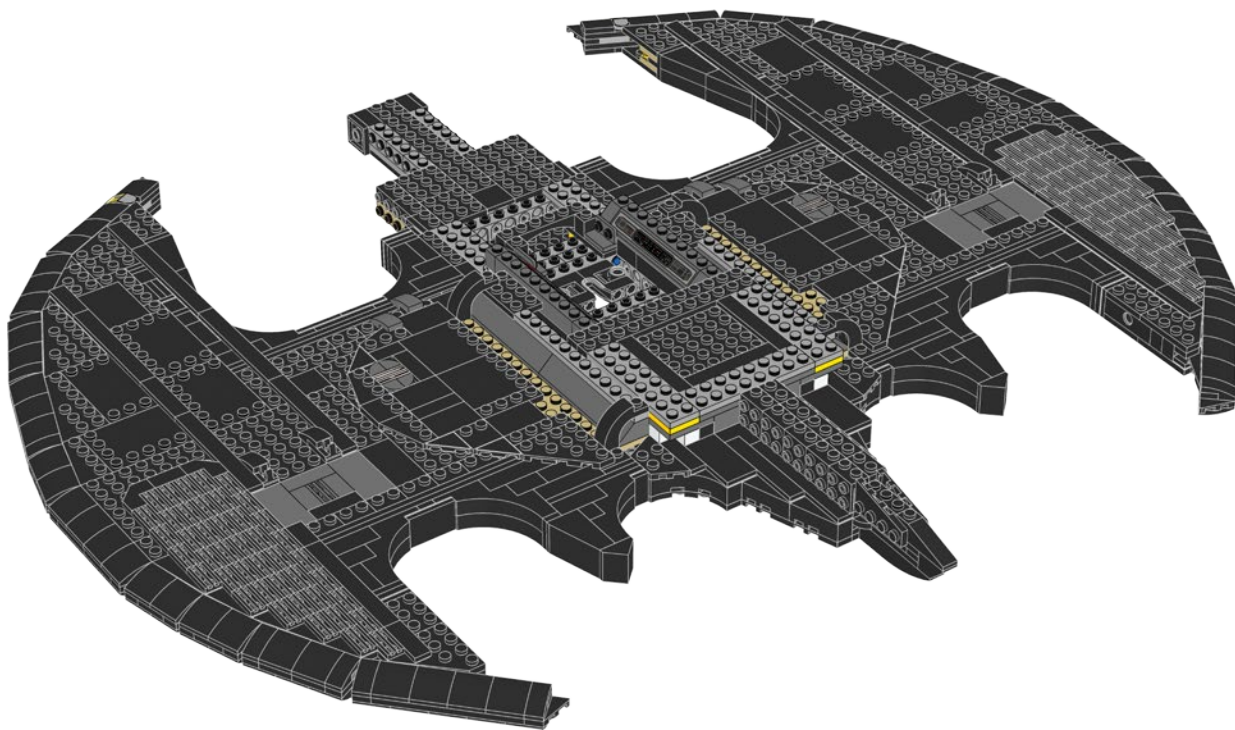
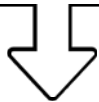

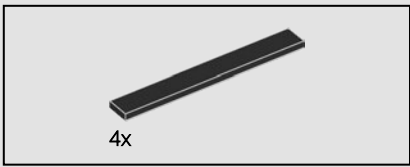

307

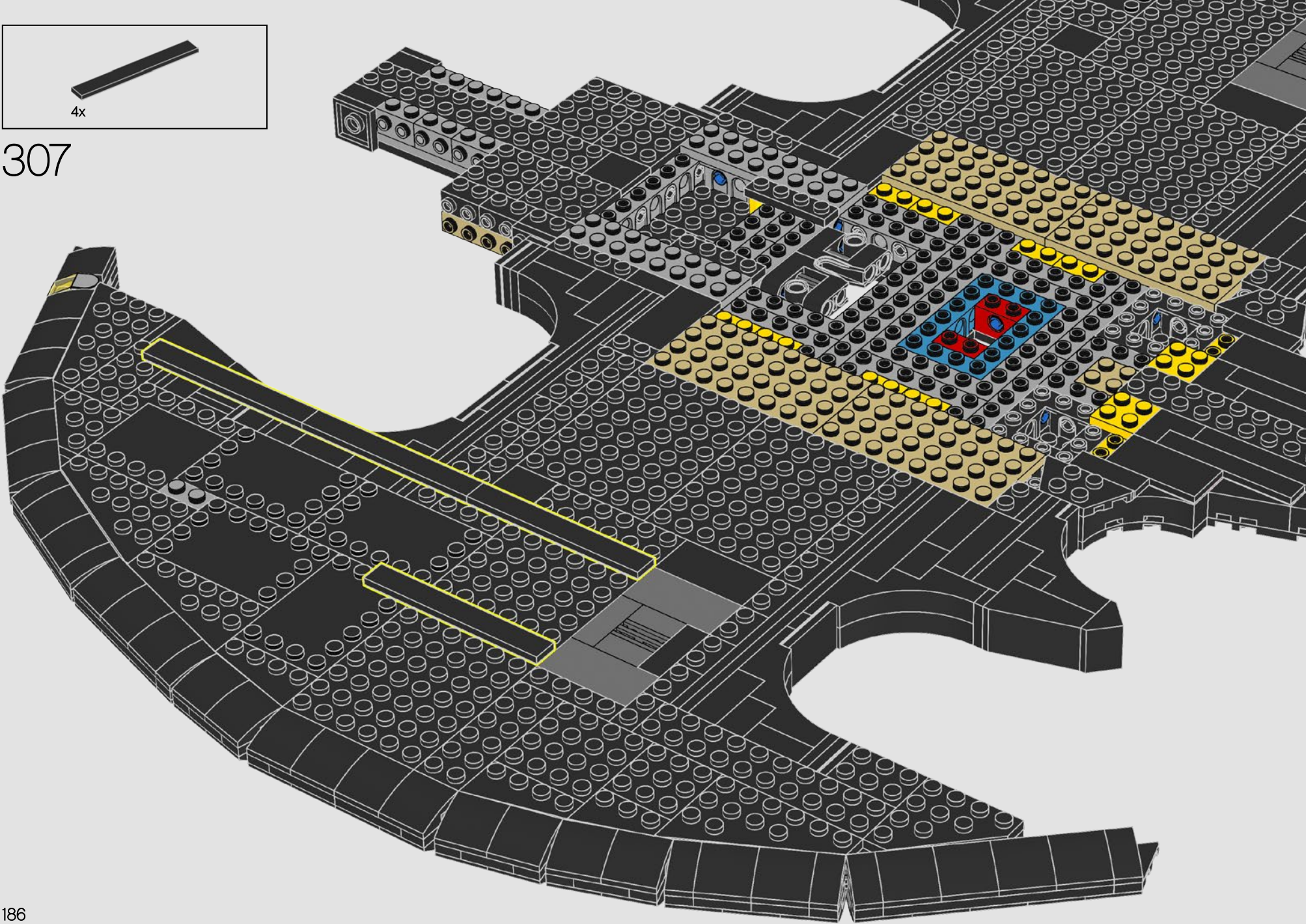

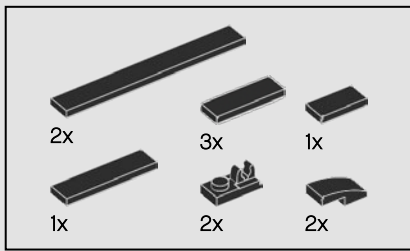

308

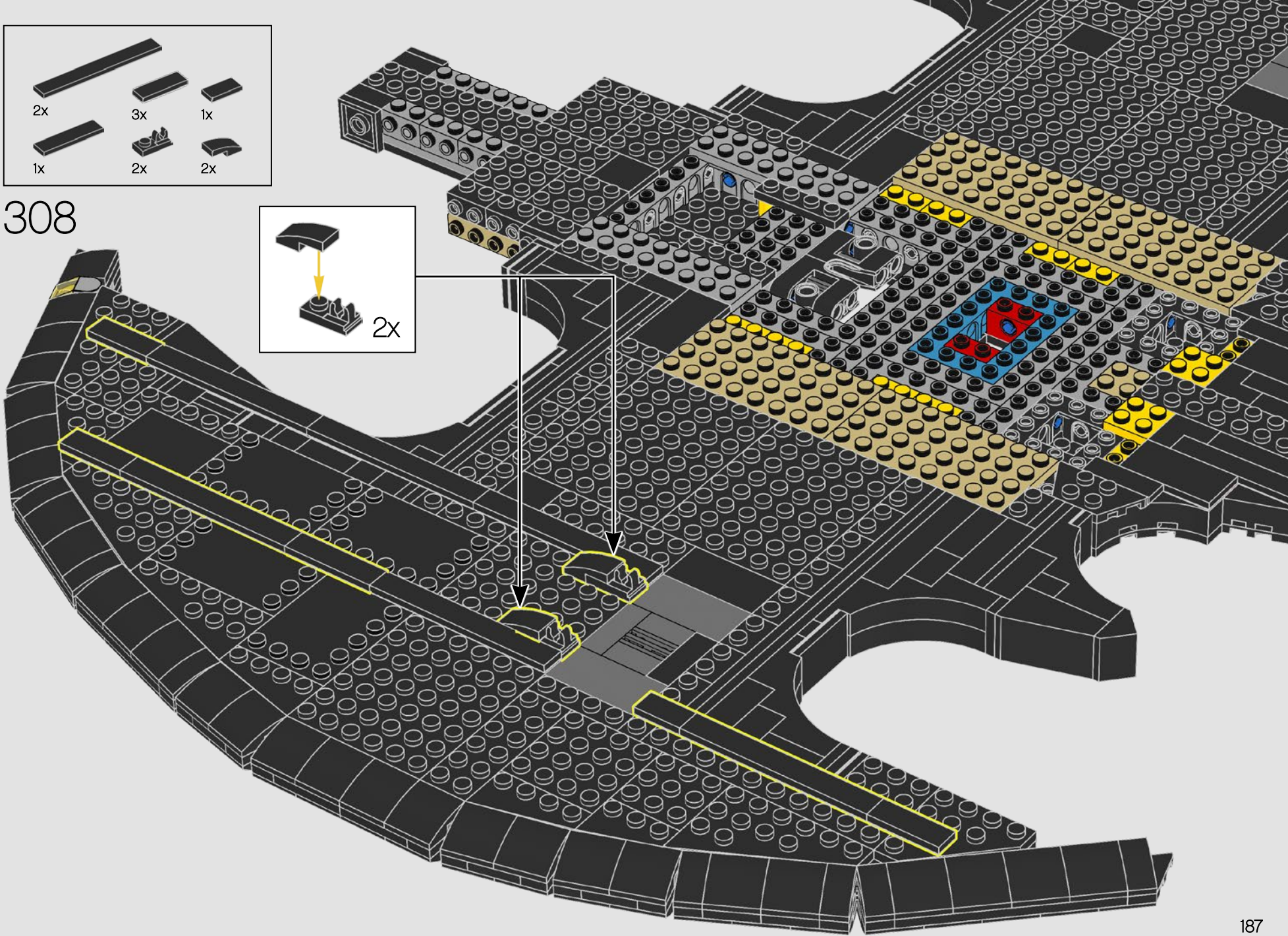
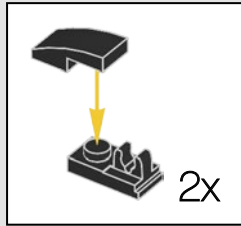

43x 1x 2x

309

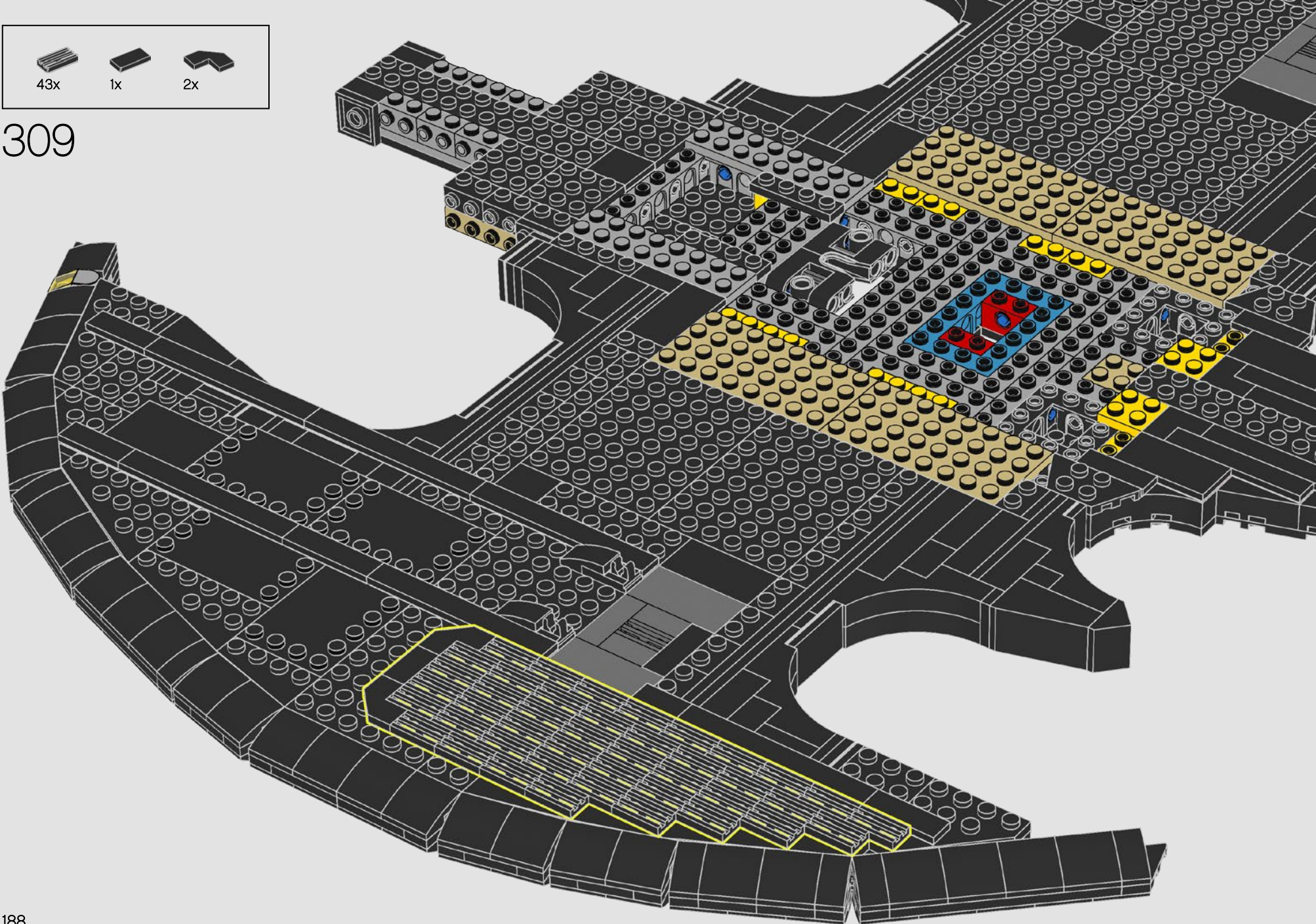

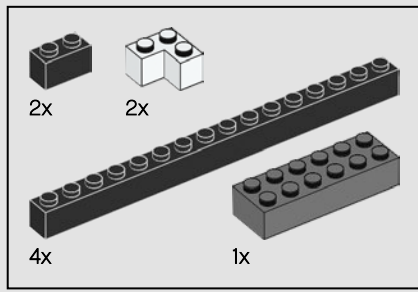

310

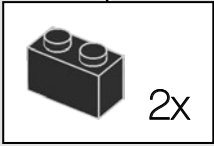
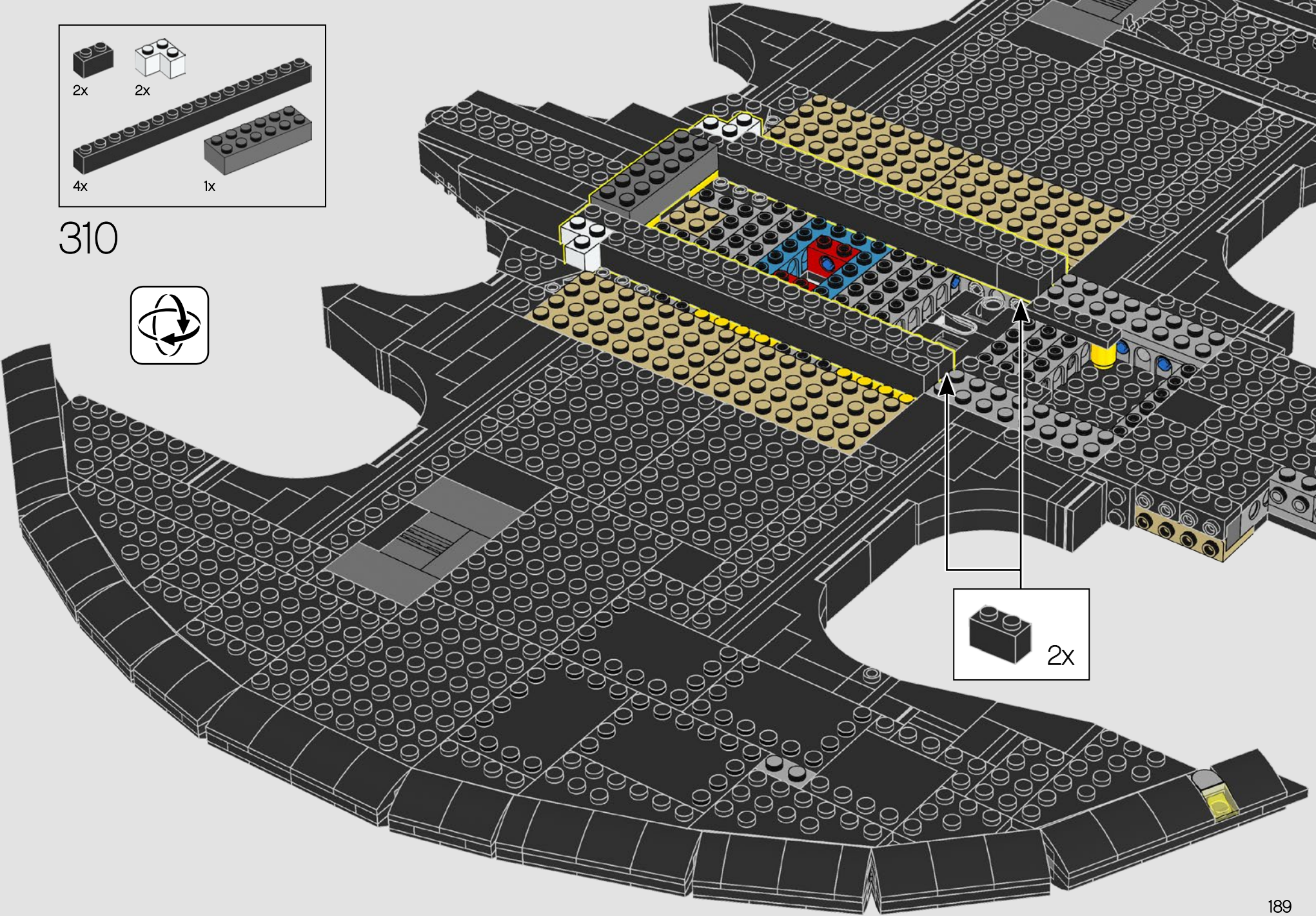

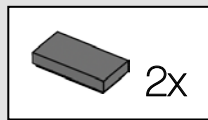
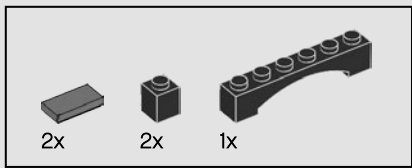

311

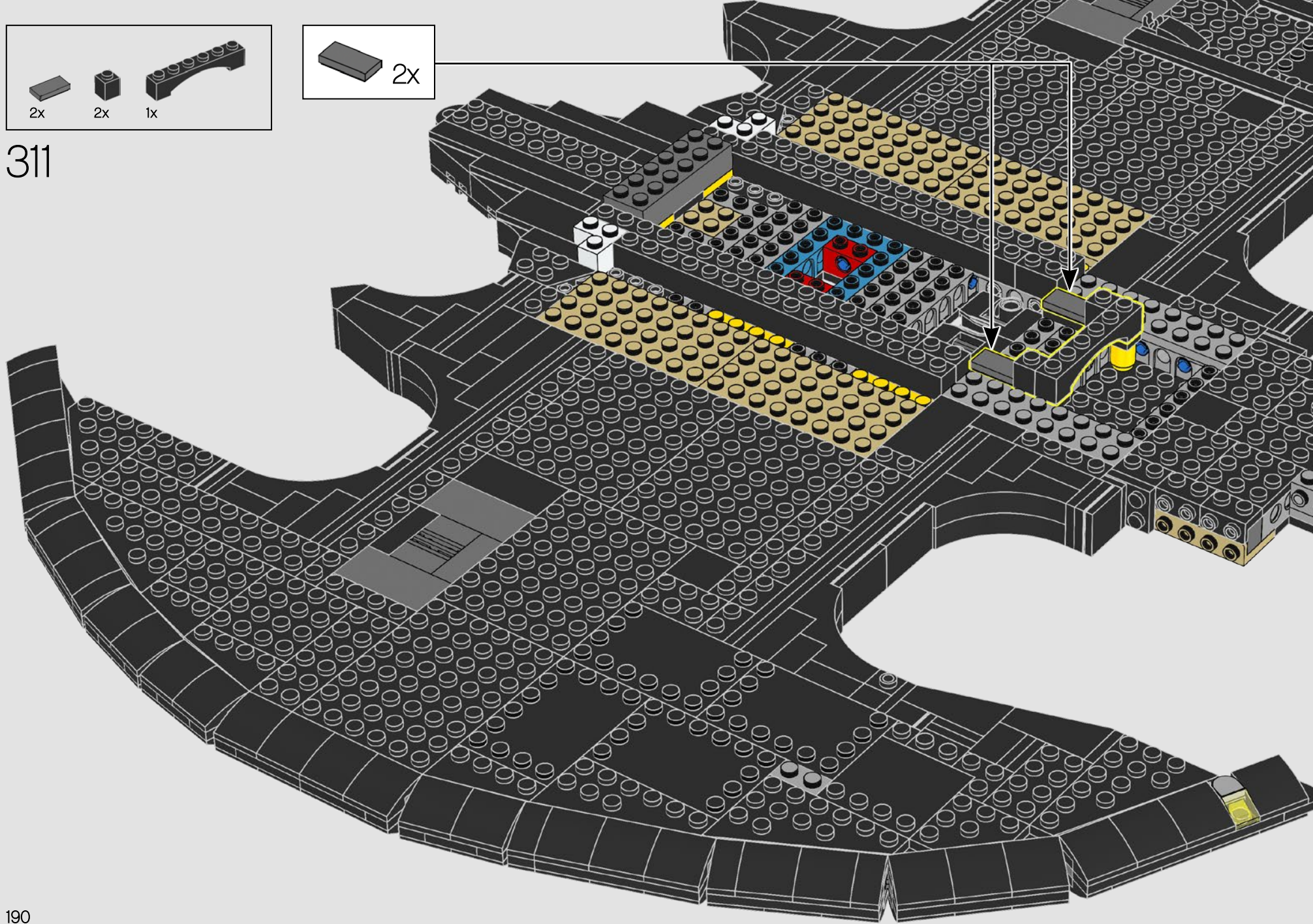

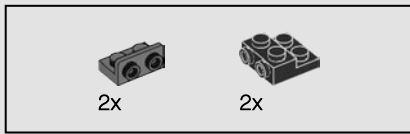

312

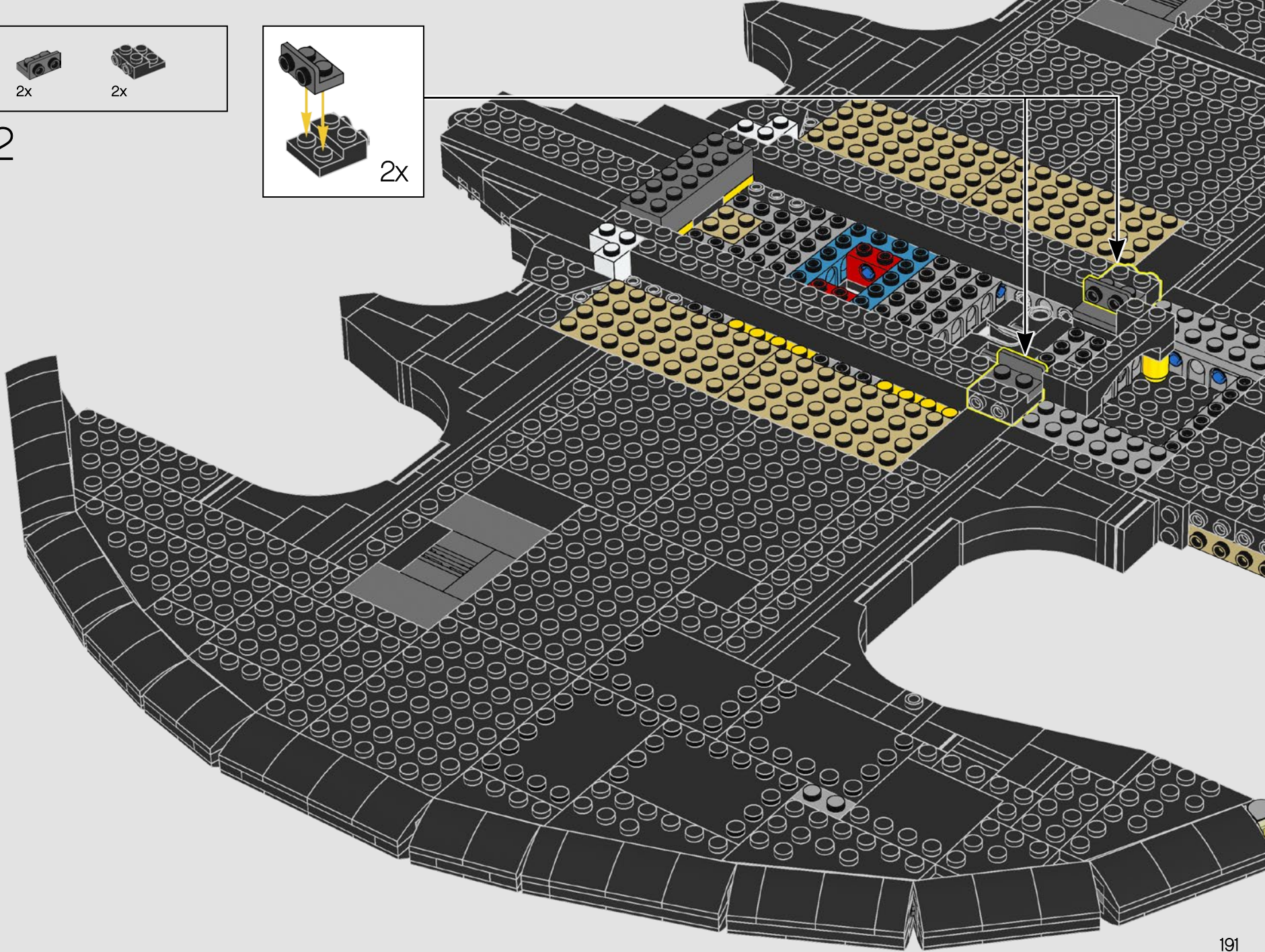
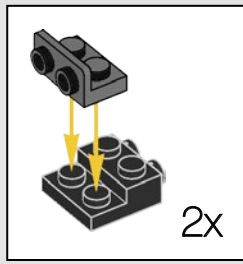

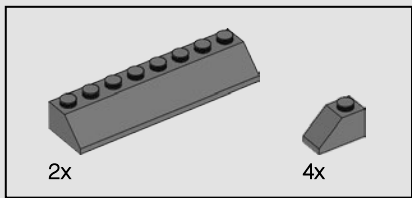

313

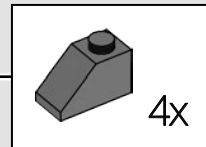
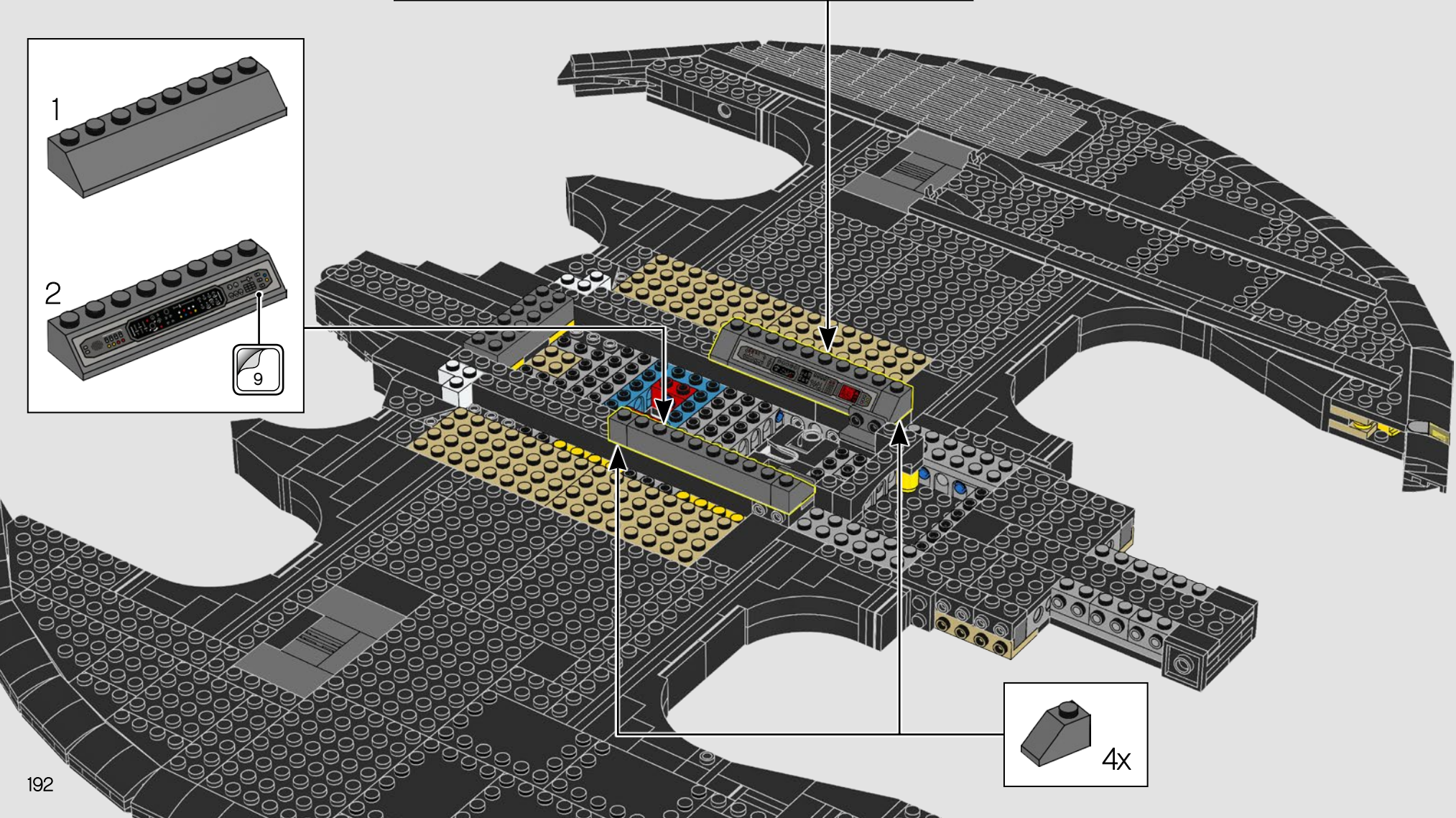
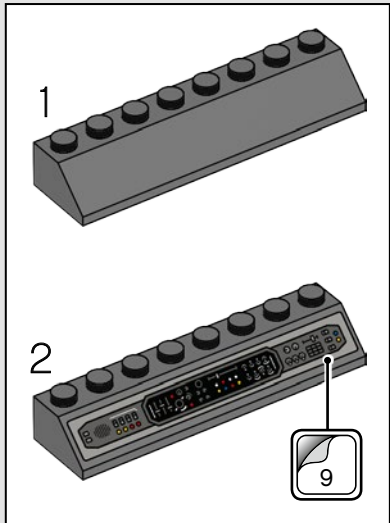
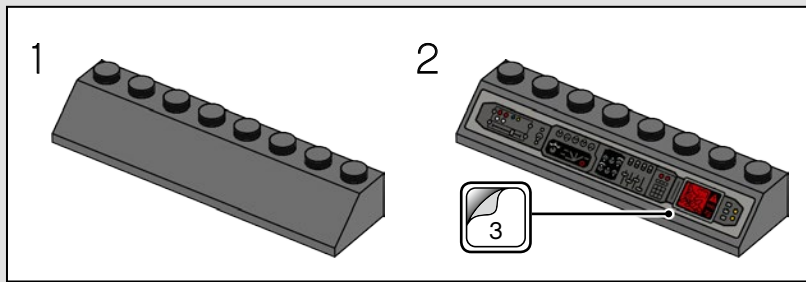



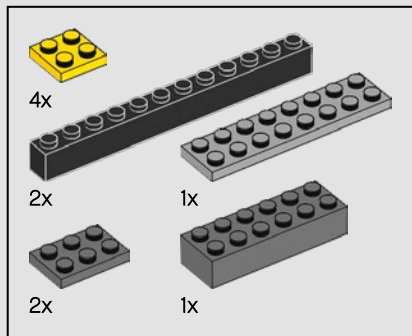

314

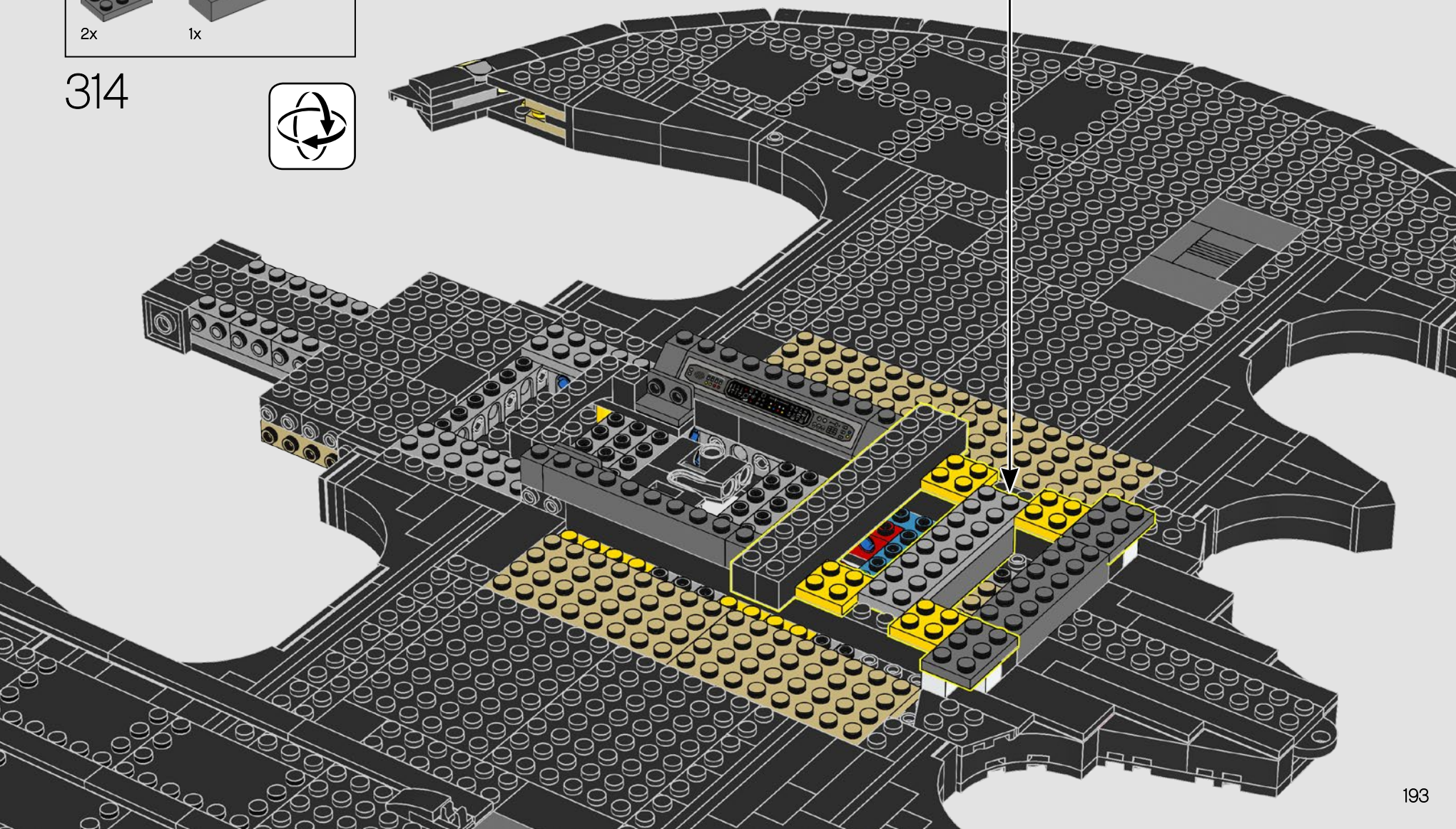
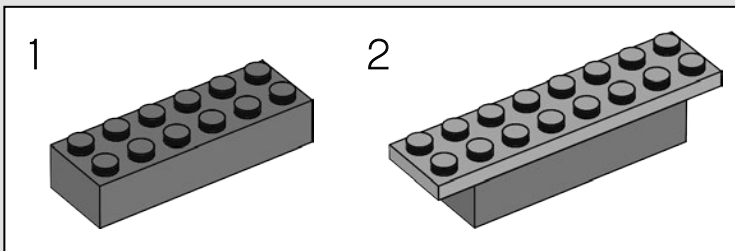

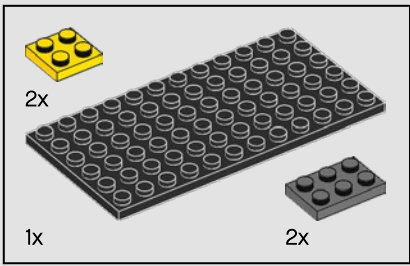

315

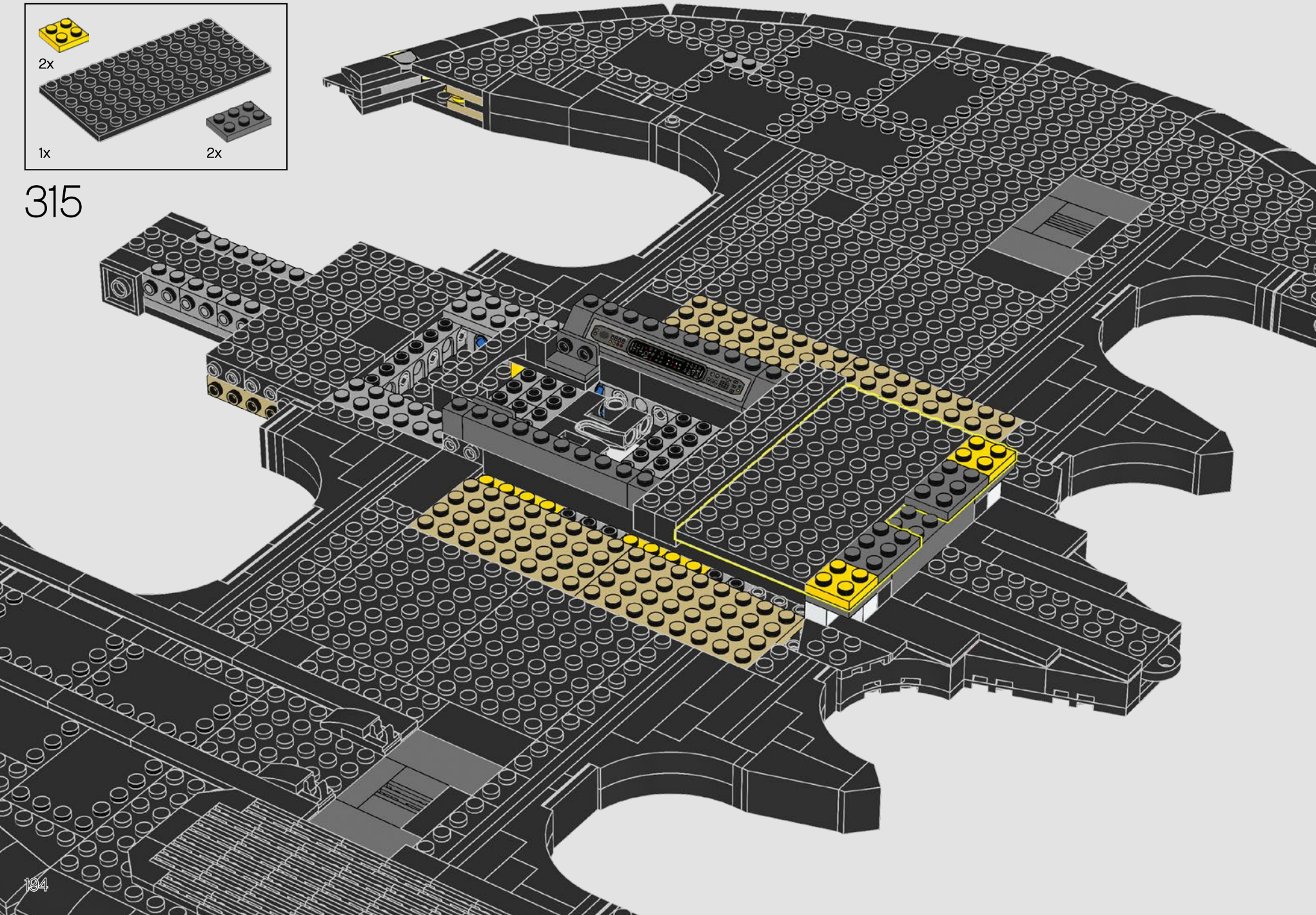

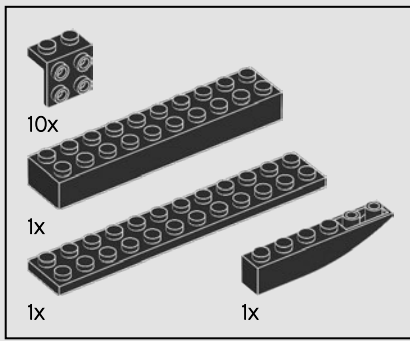

316

1

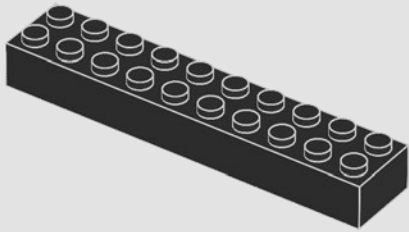

2

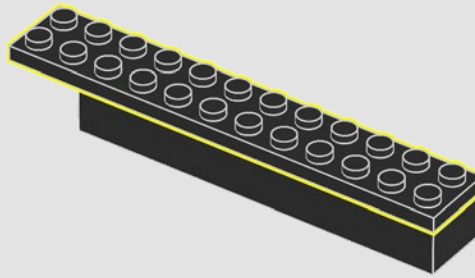

3

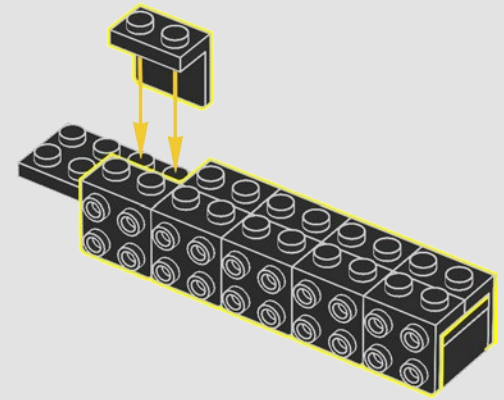

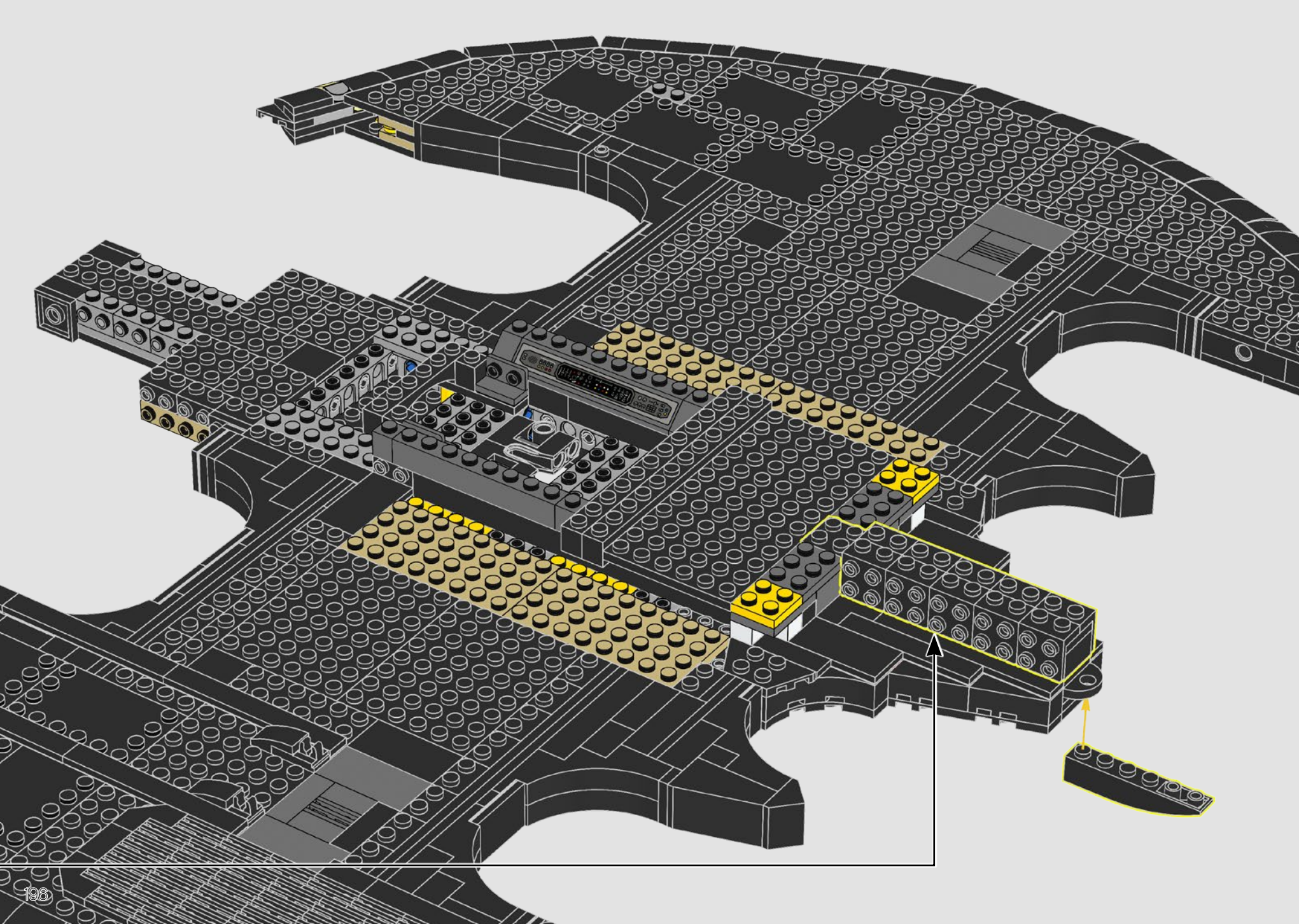

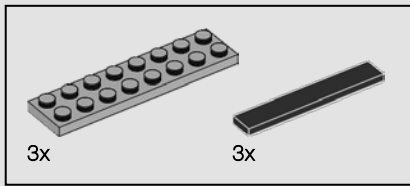

317

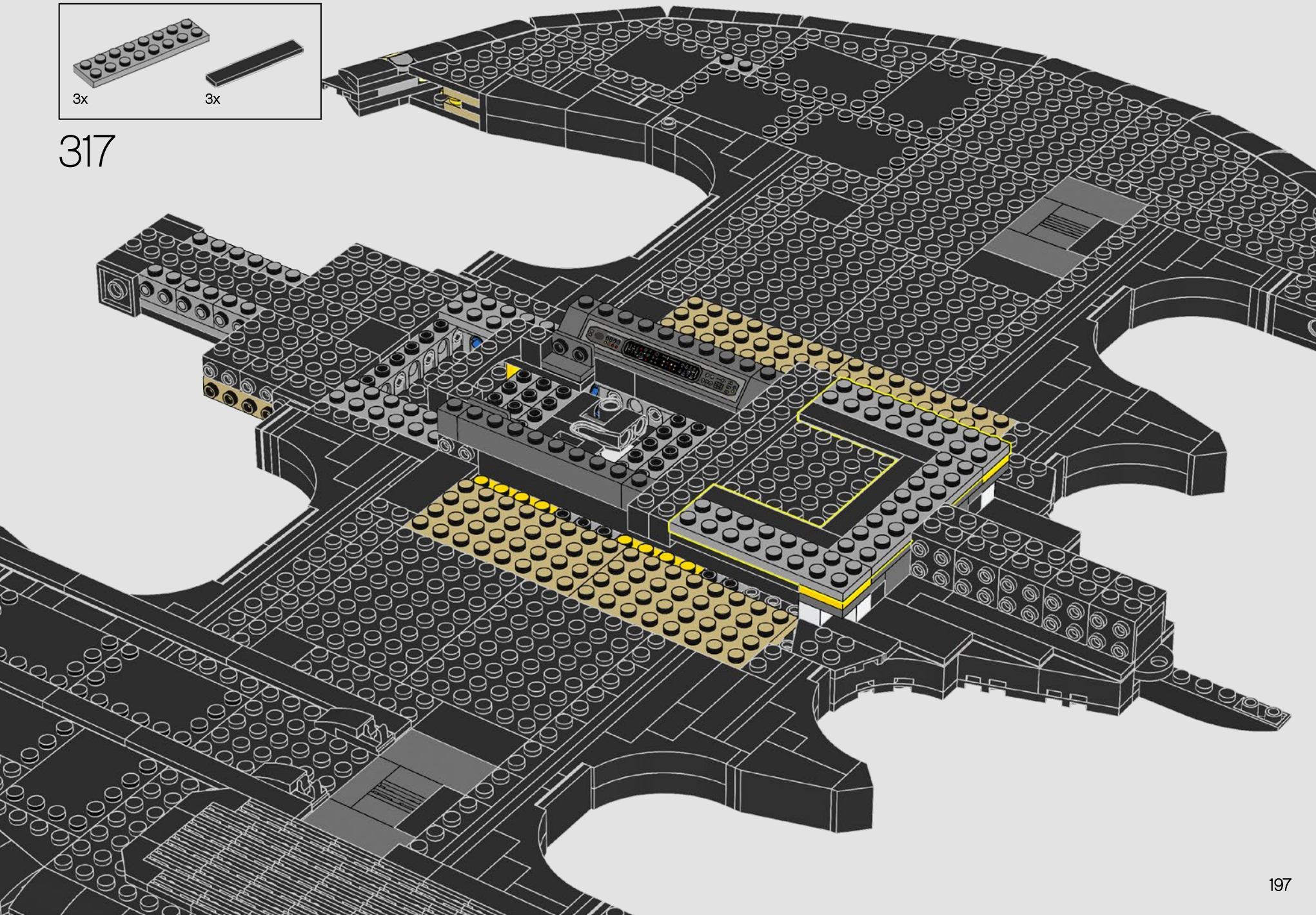

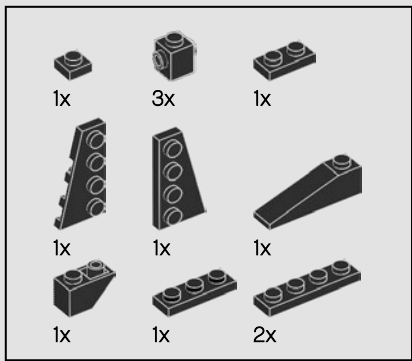

318

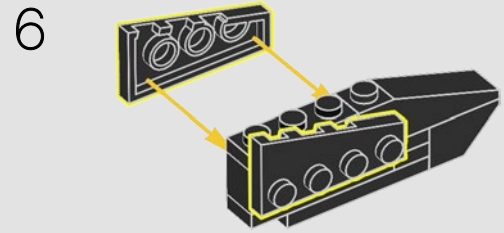
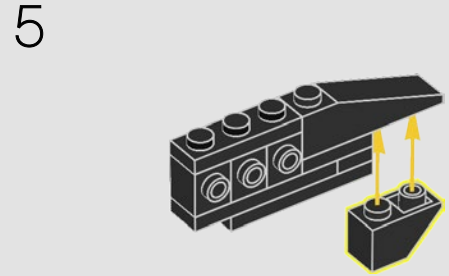
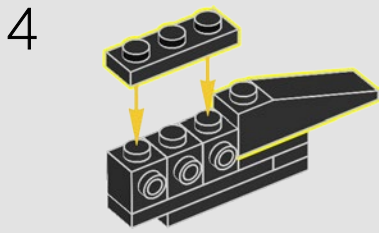
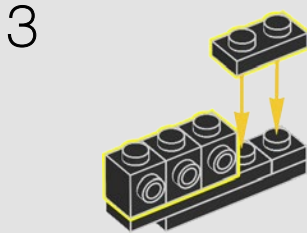
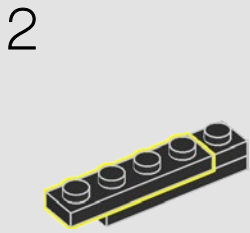
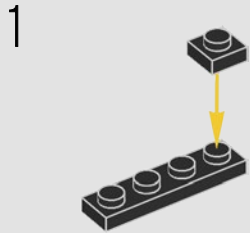

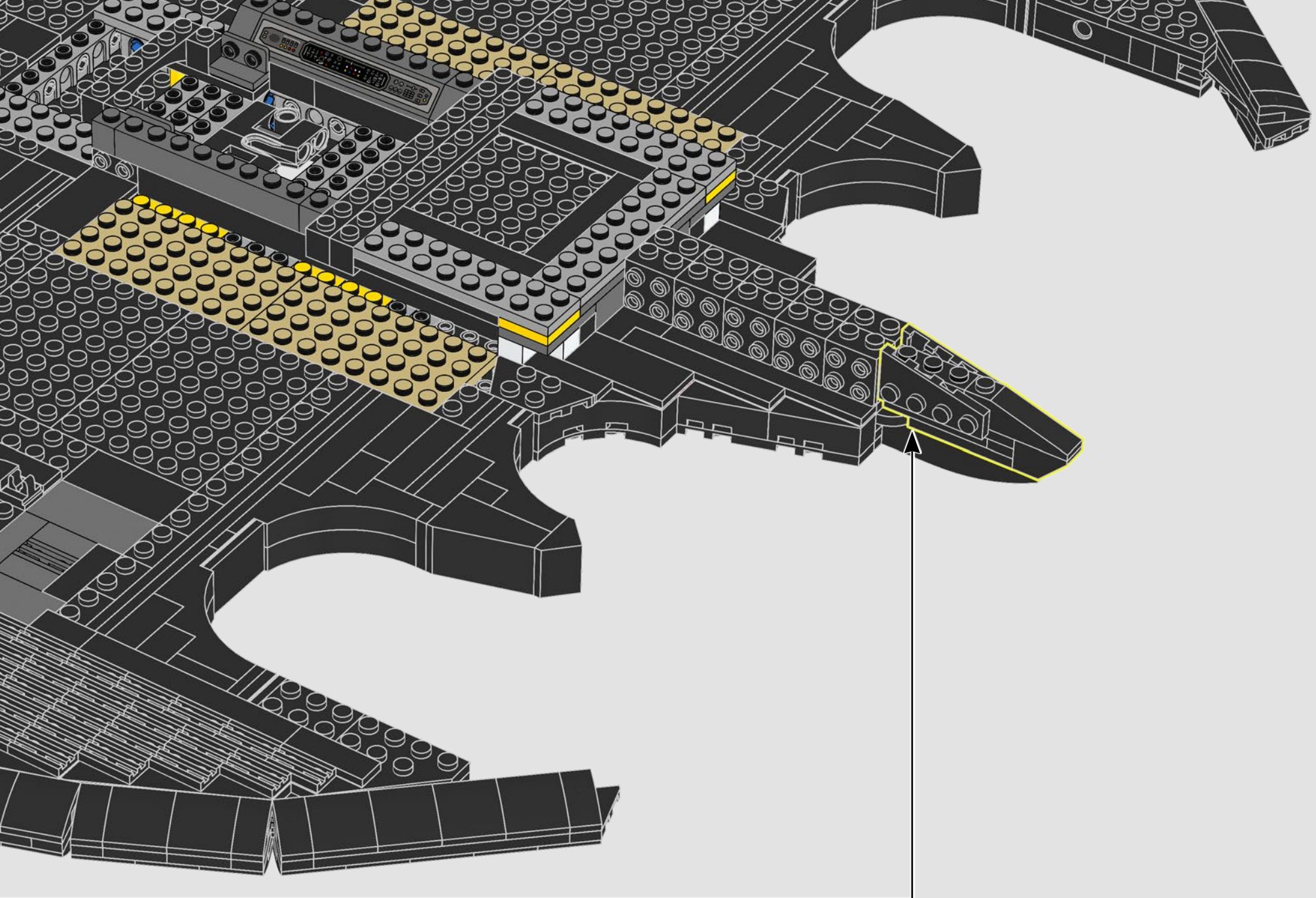

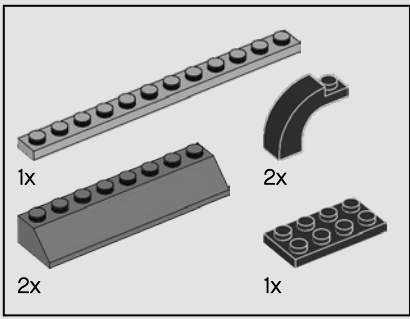

319

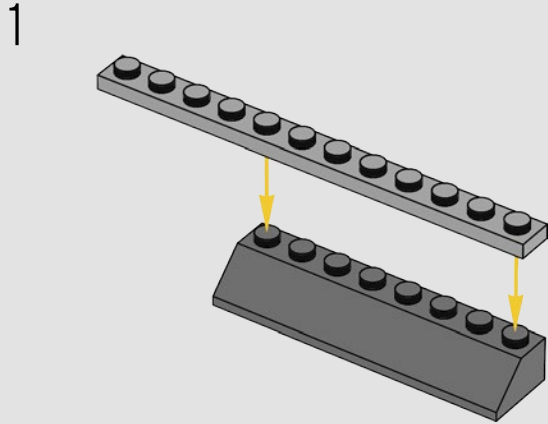

2

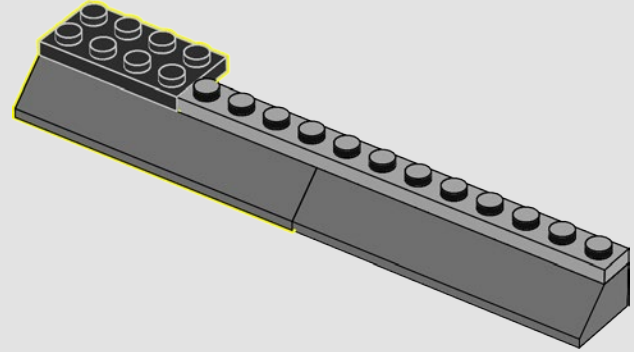

3

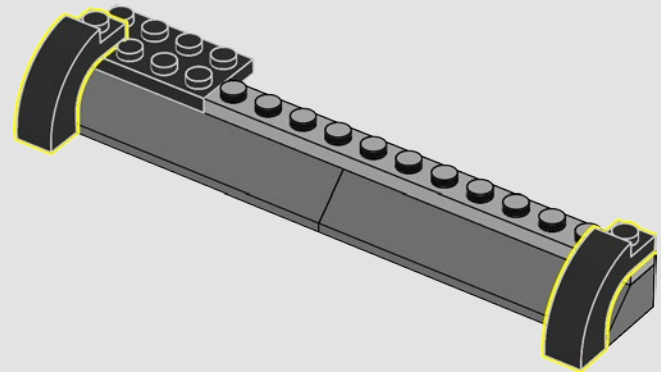



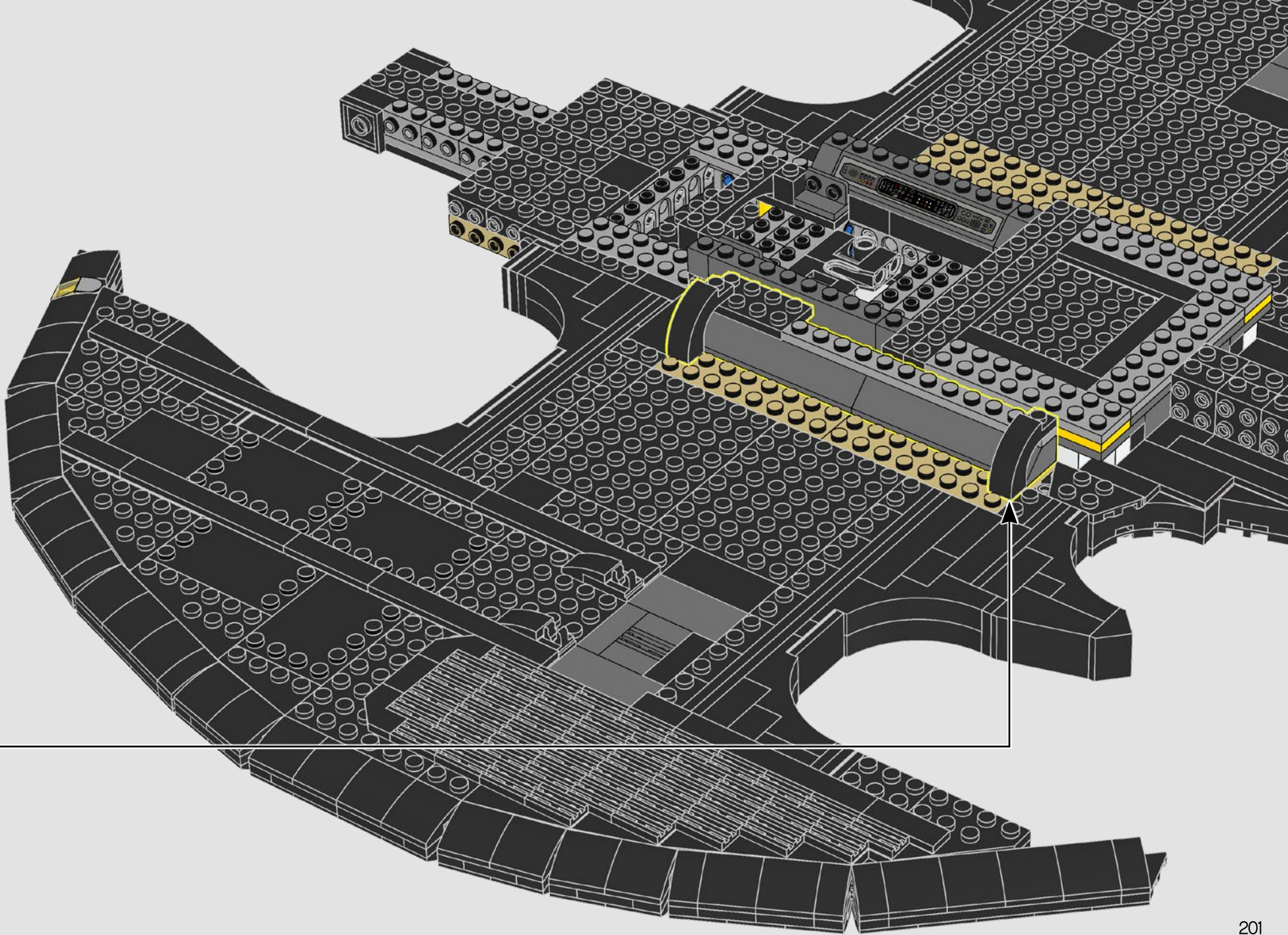

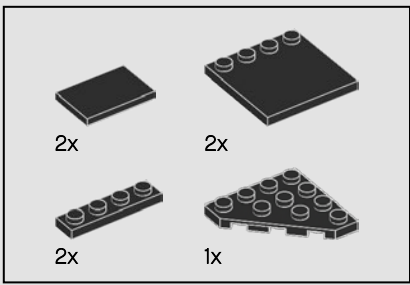

320

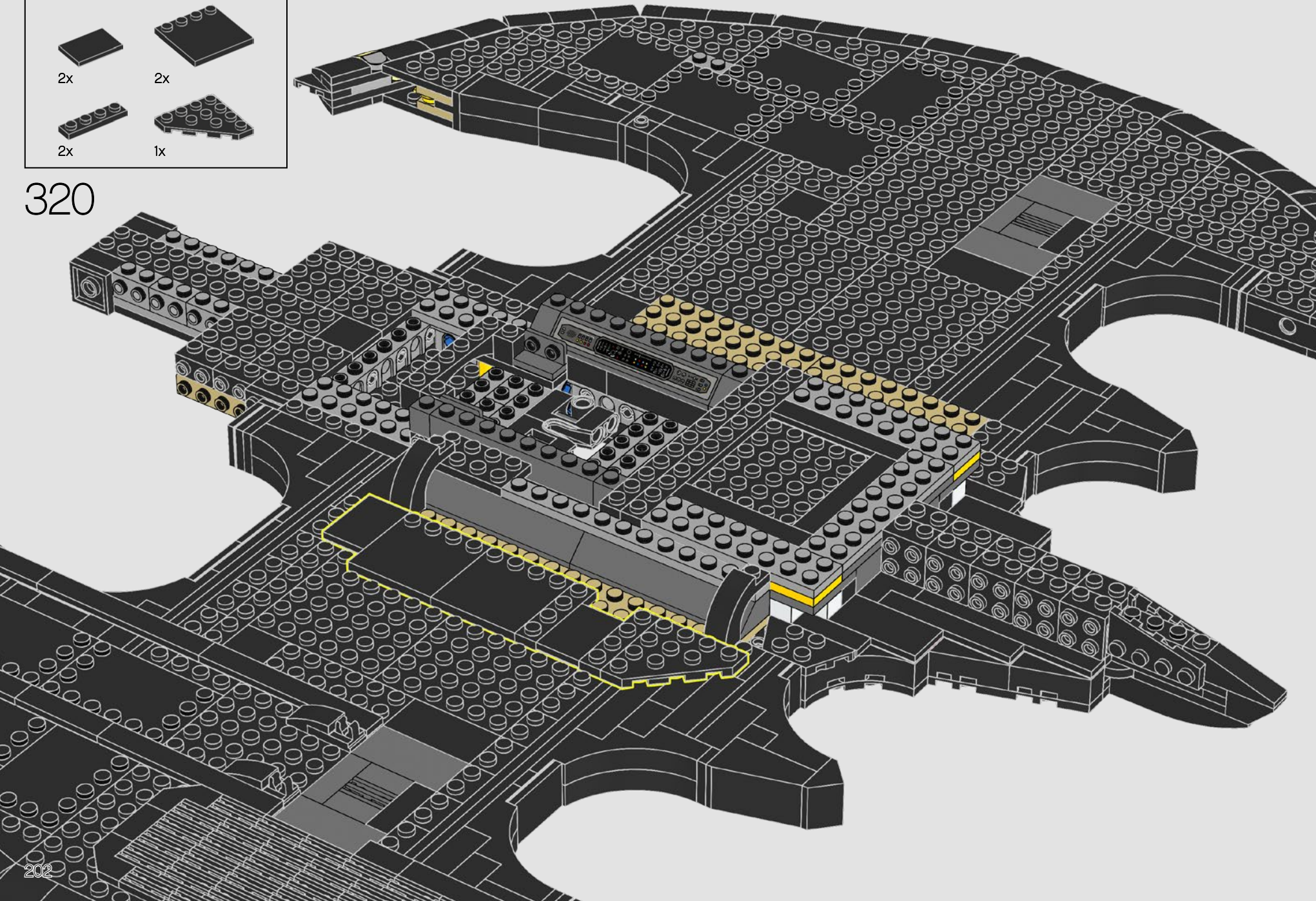

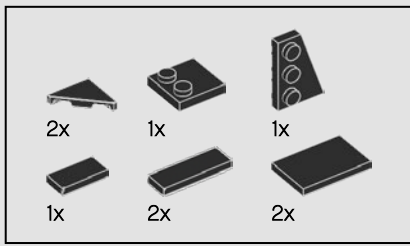

321

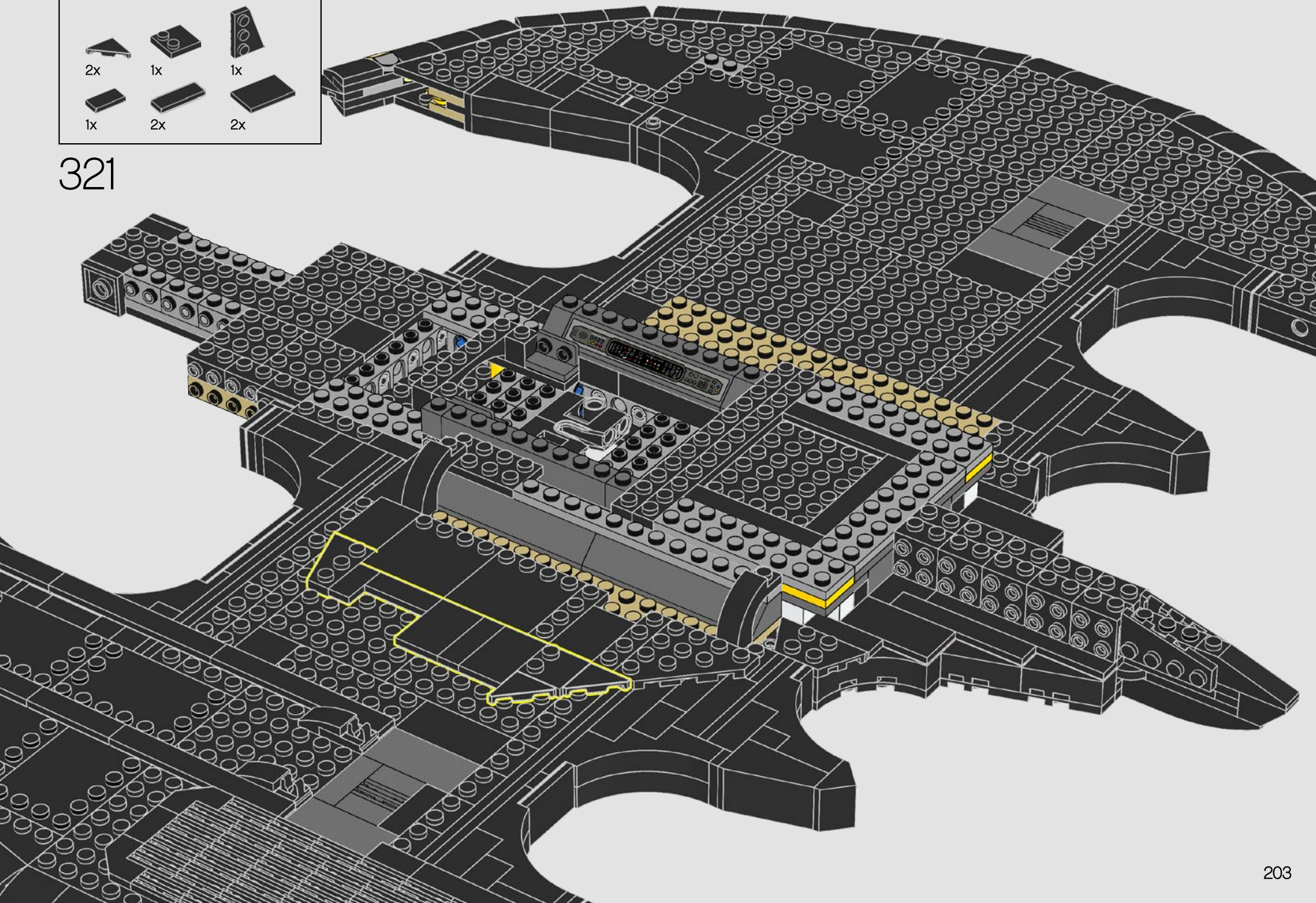

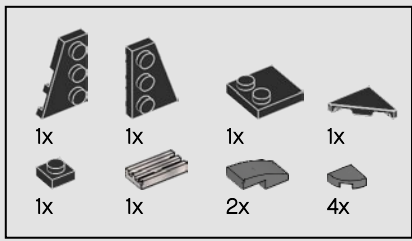

322

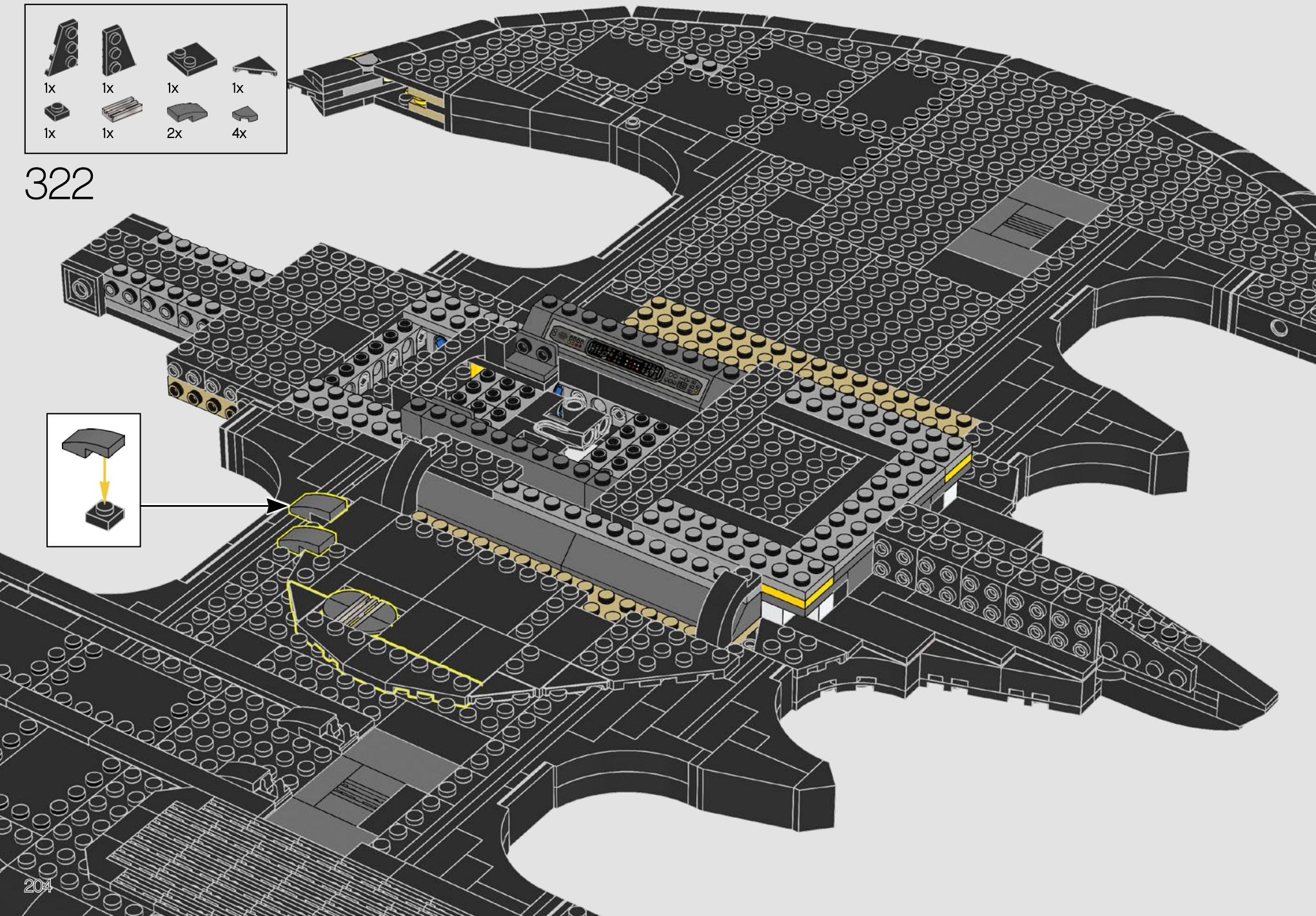
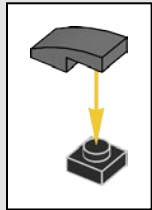

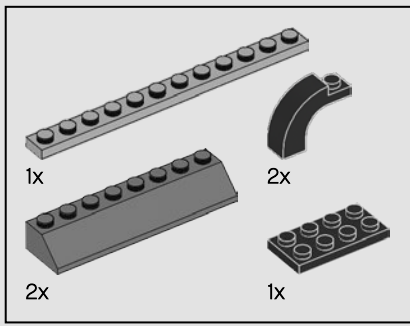

323

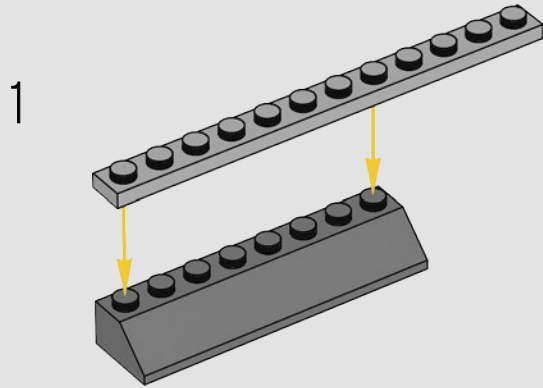

2

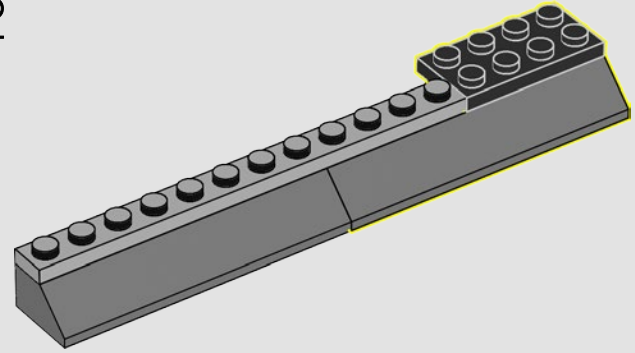

3

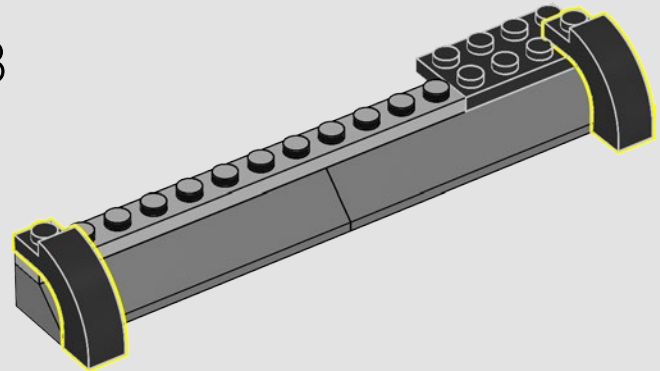

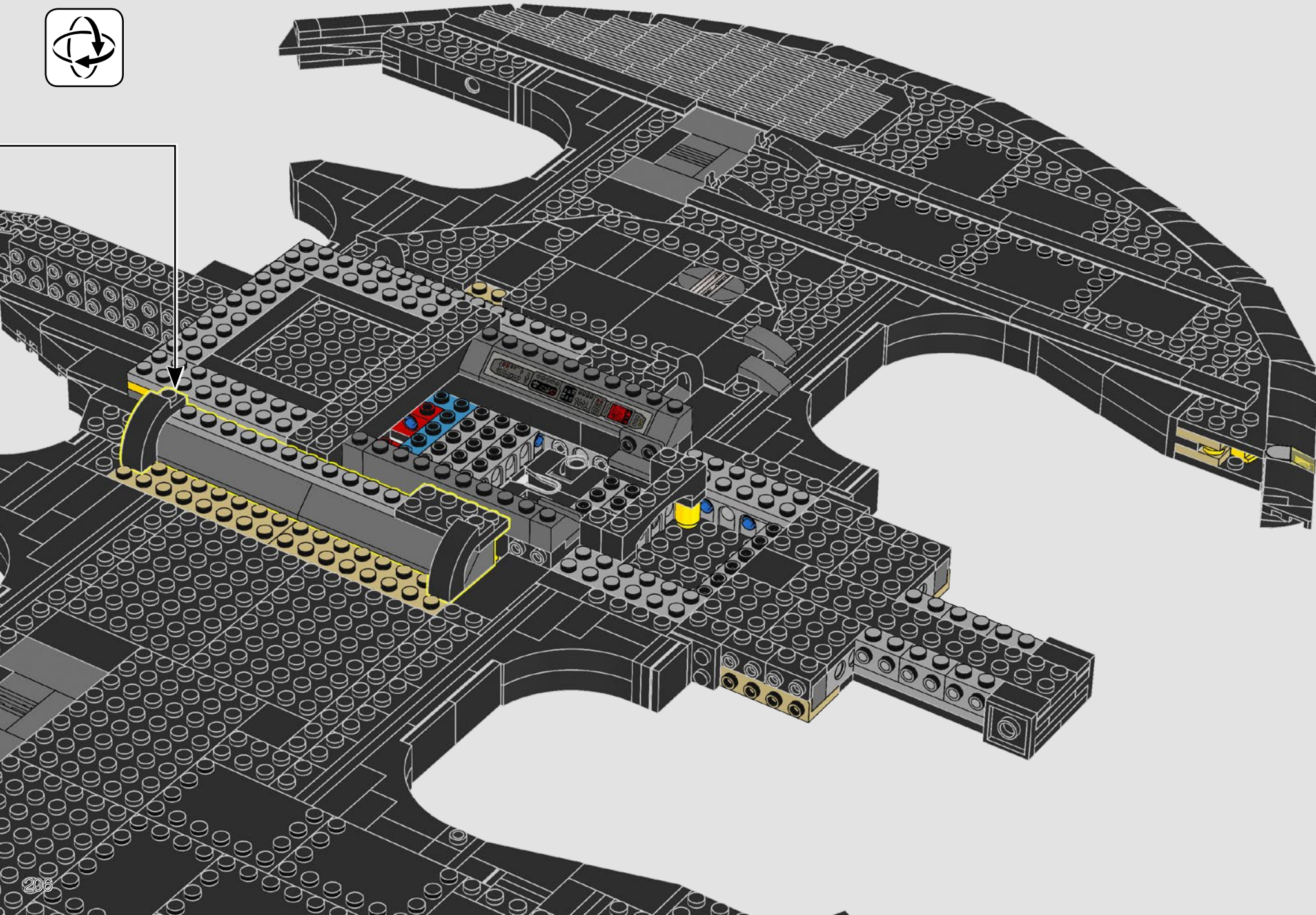

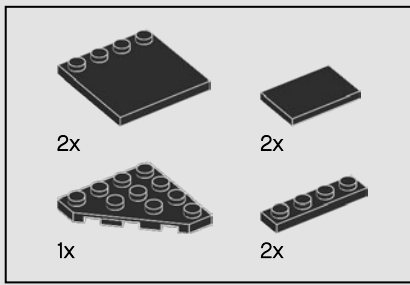

324

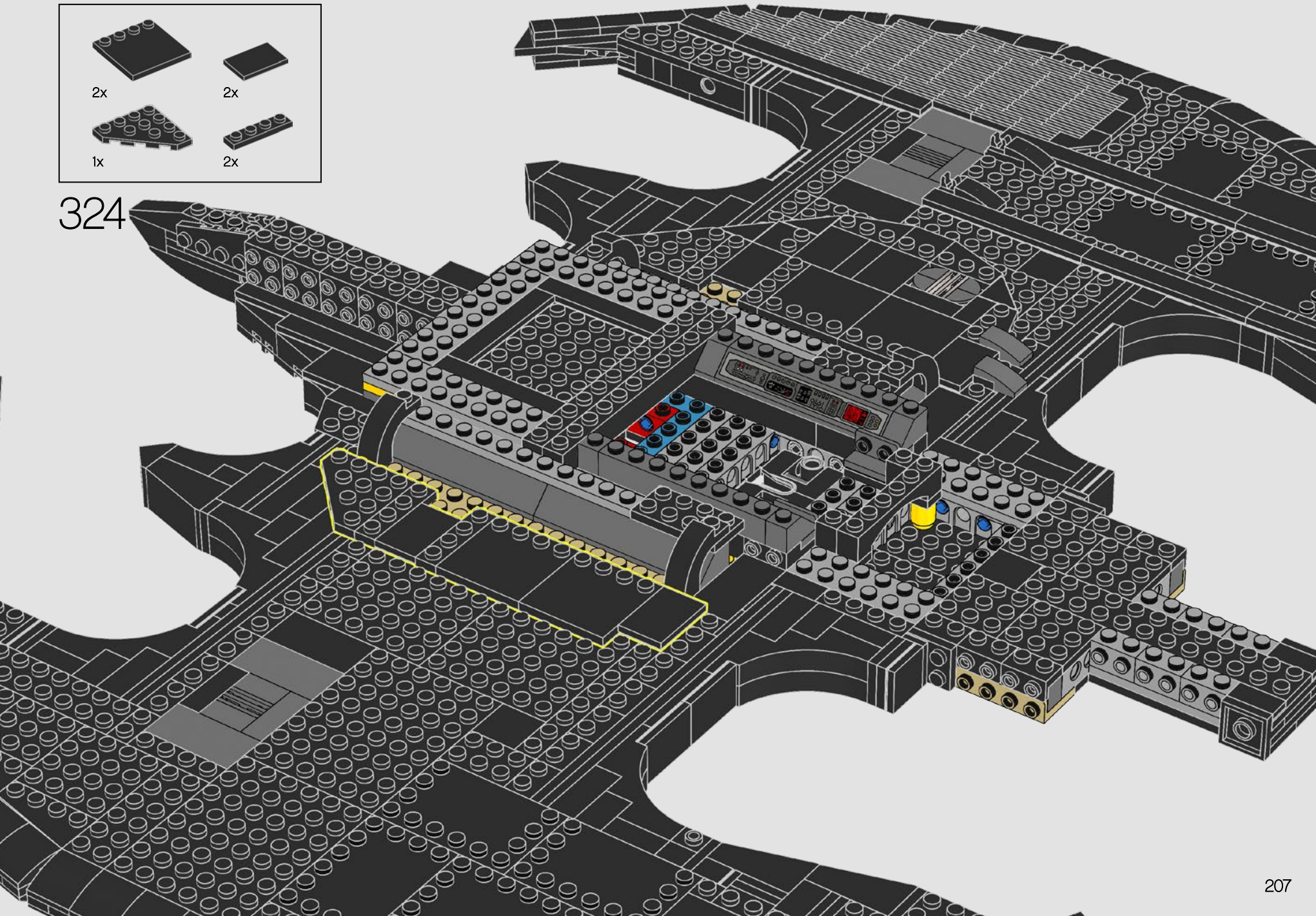

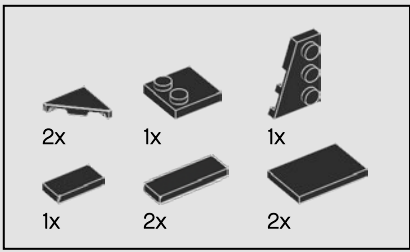

325

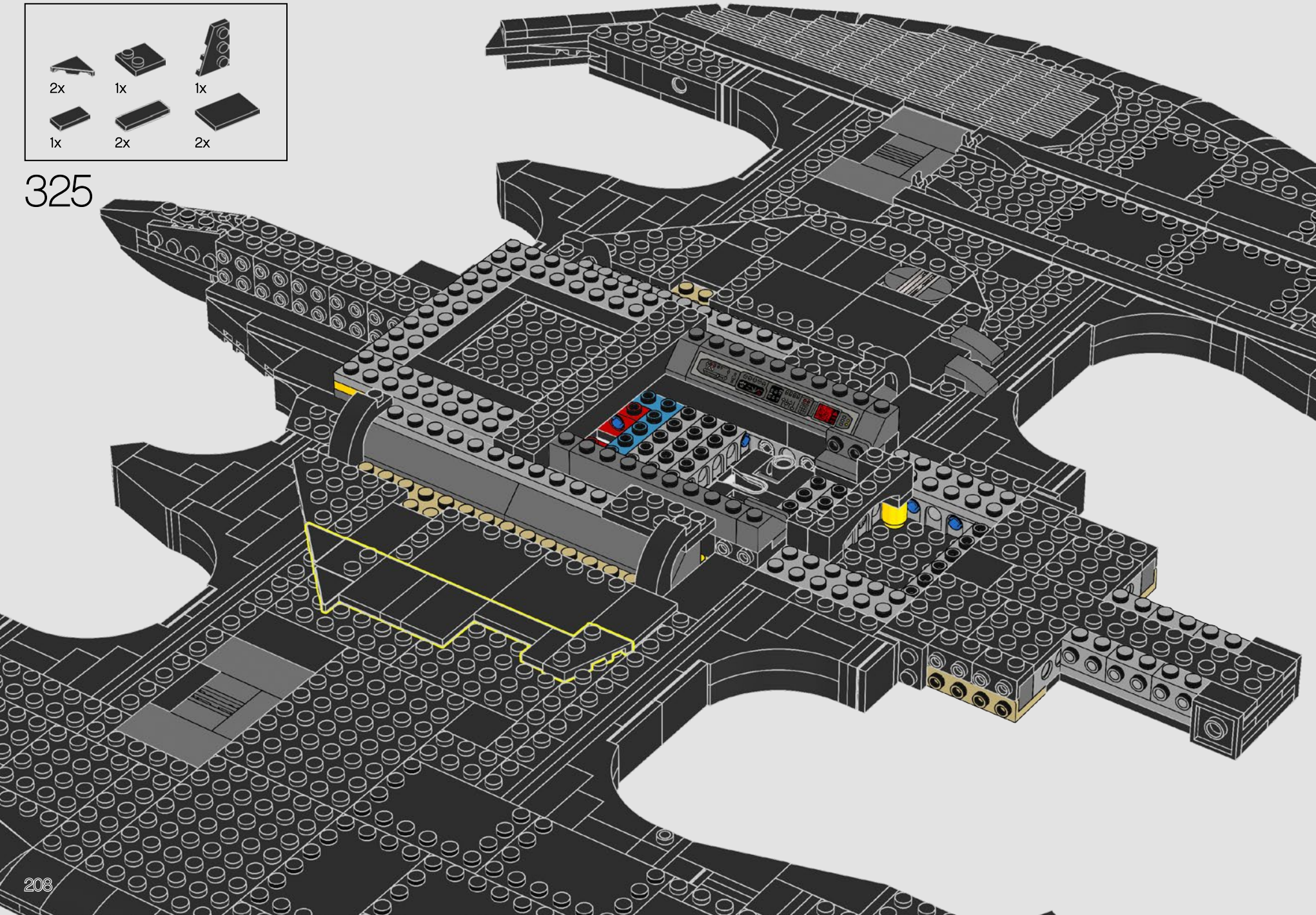



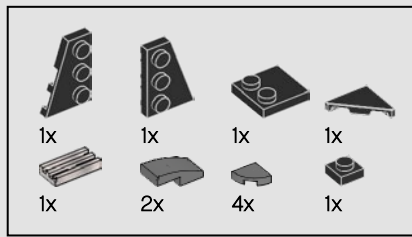

326

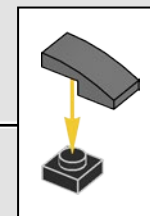
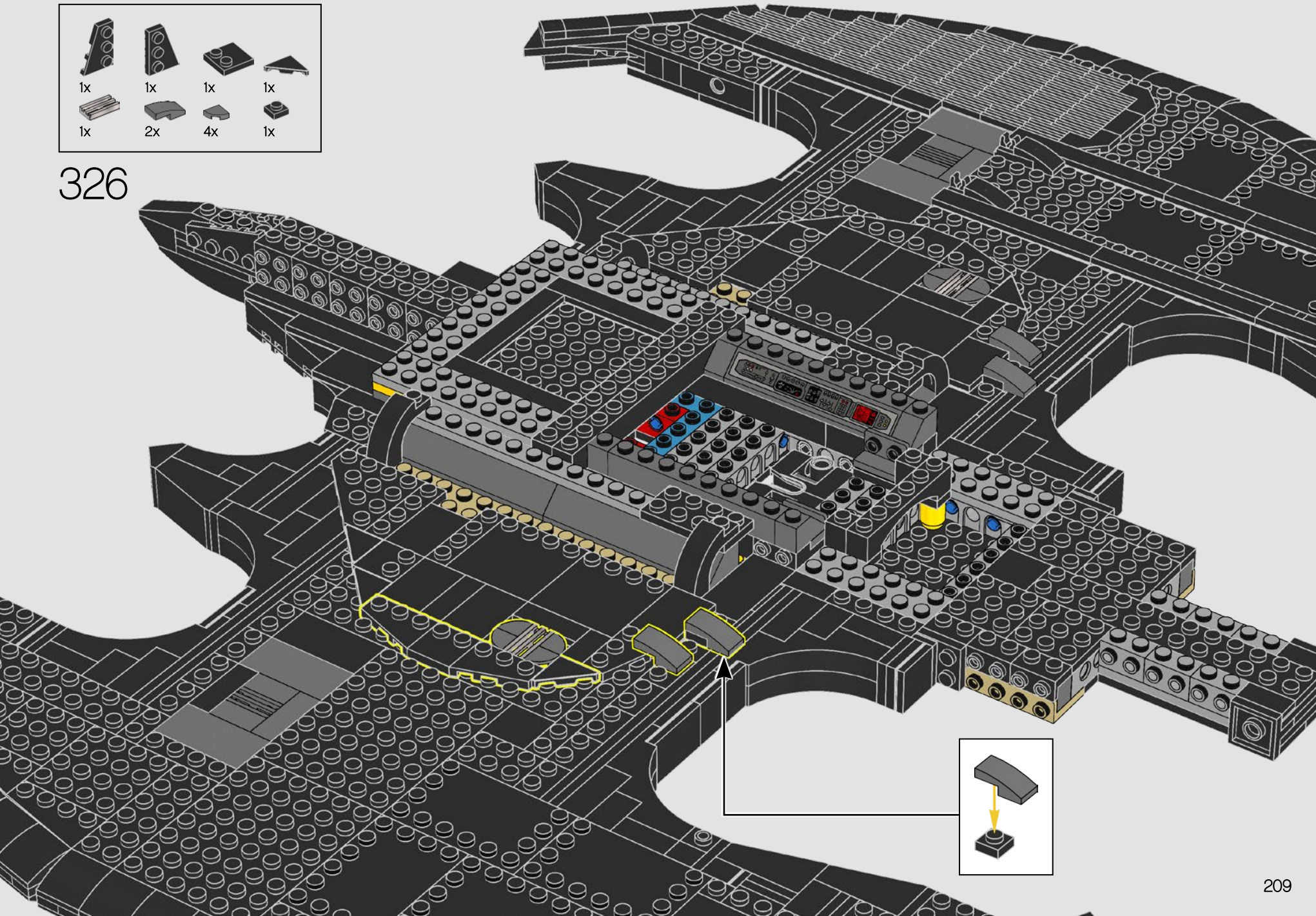

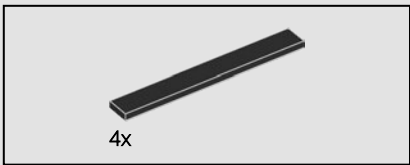

327

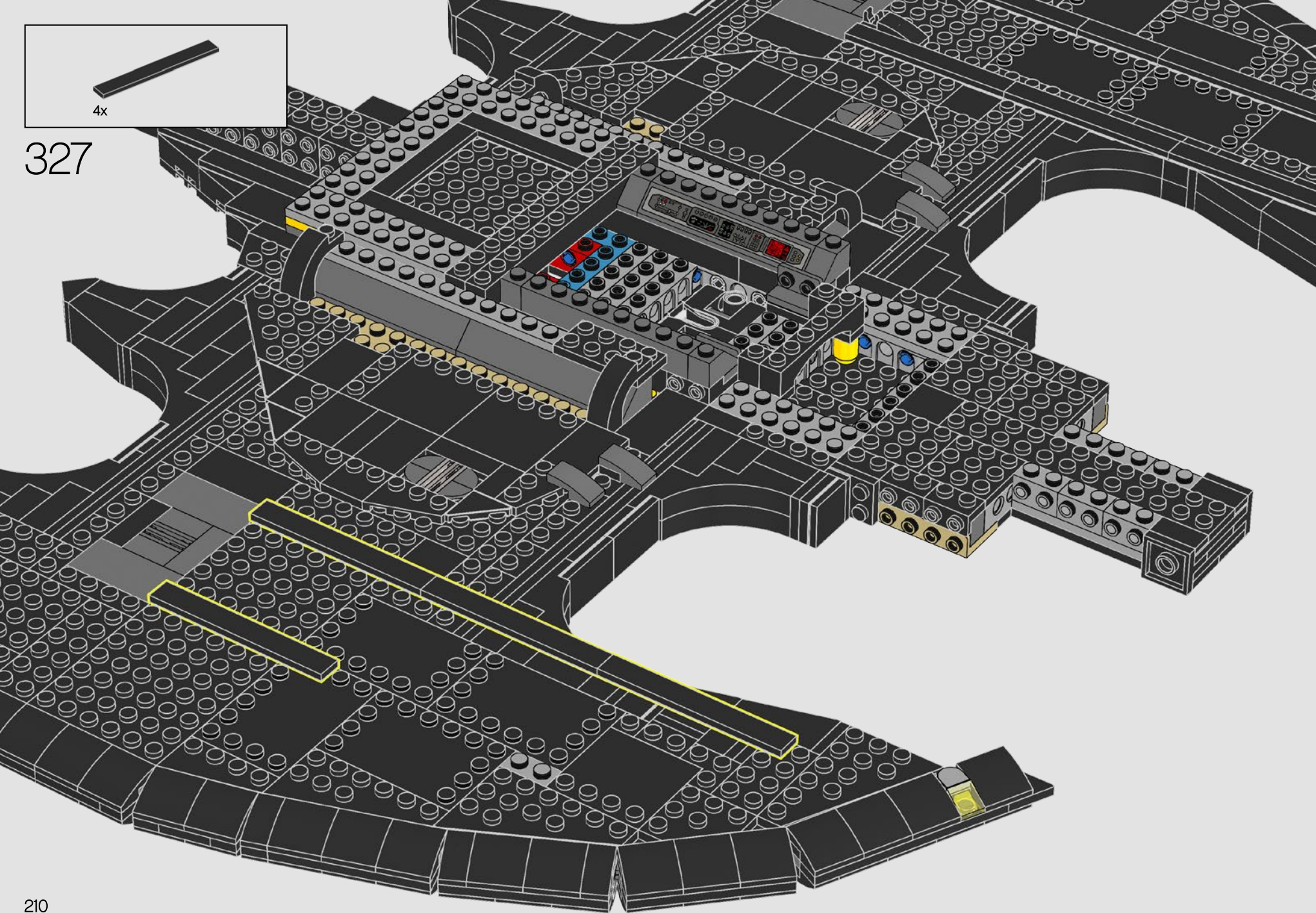

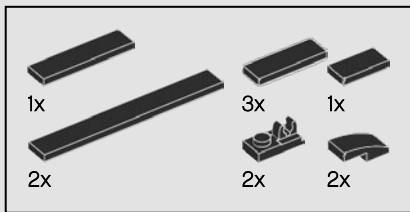

328

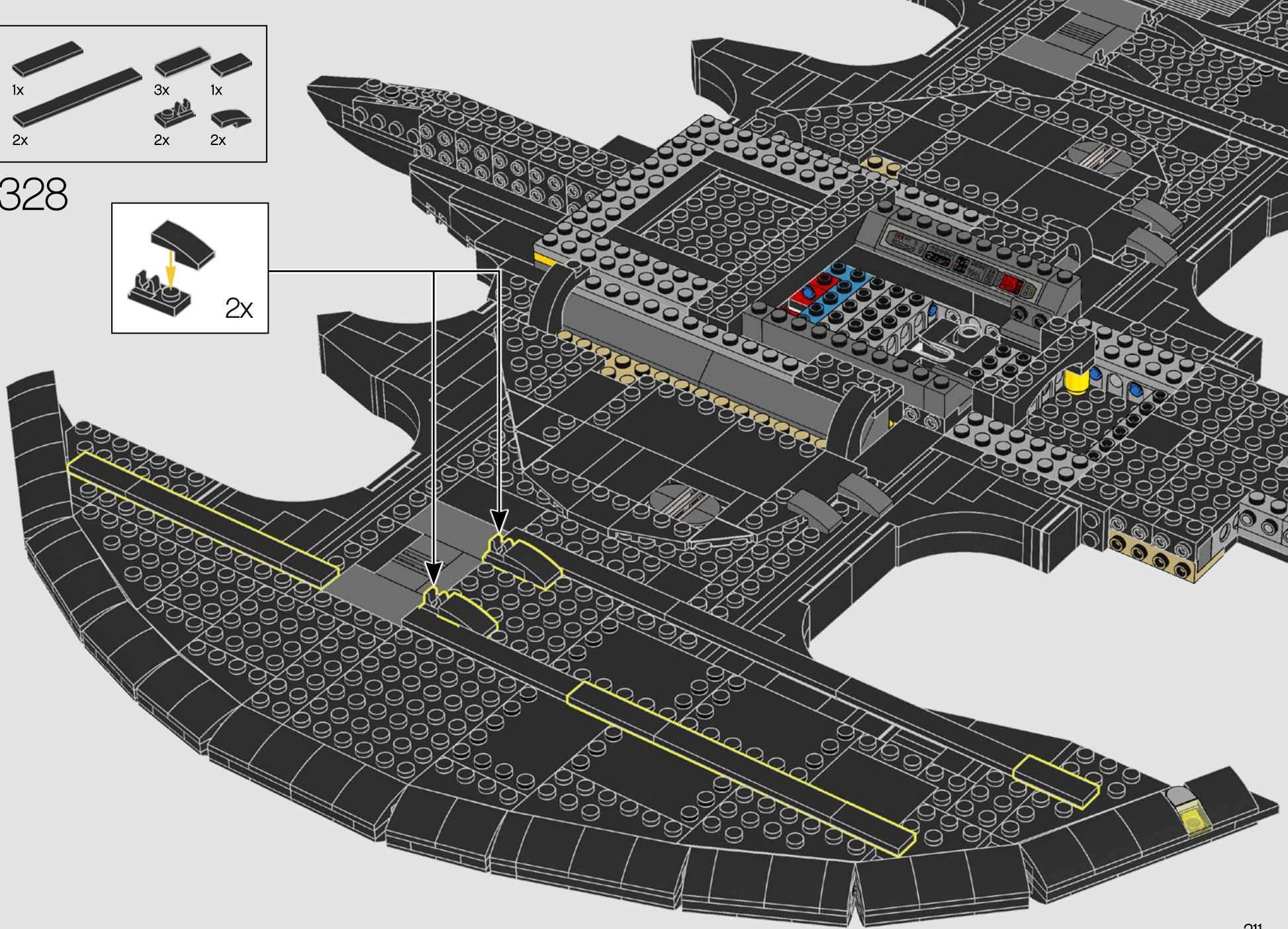
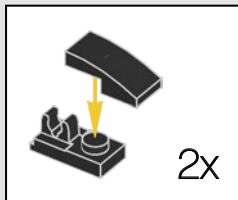

43x    1x    2x

329

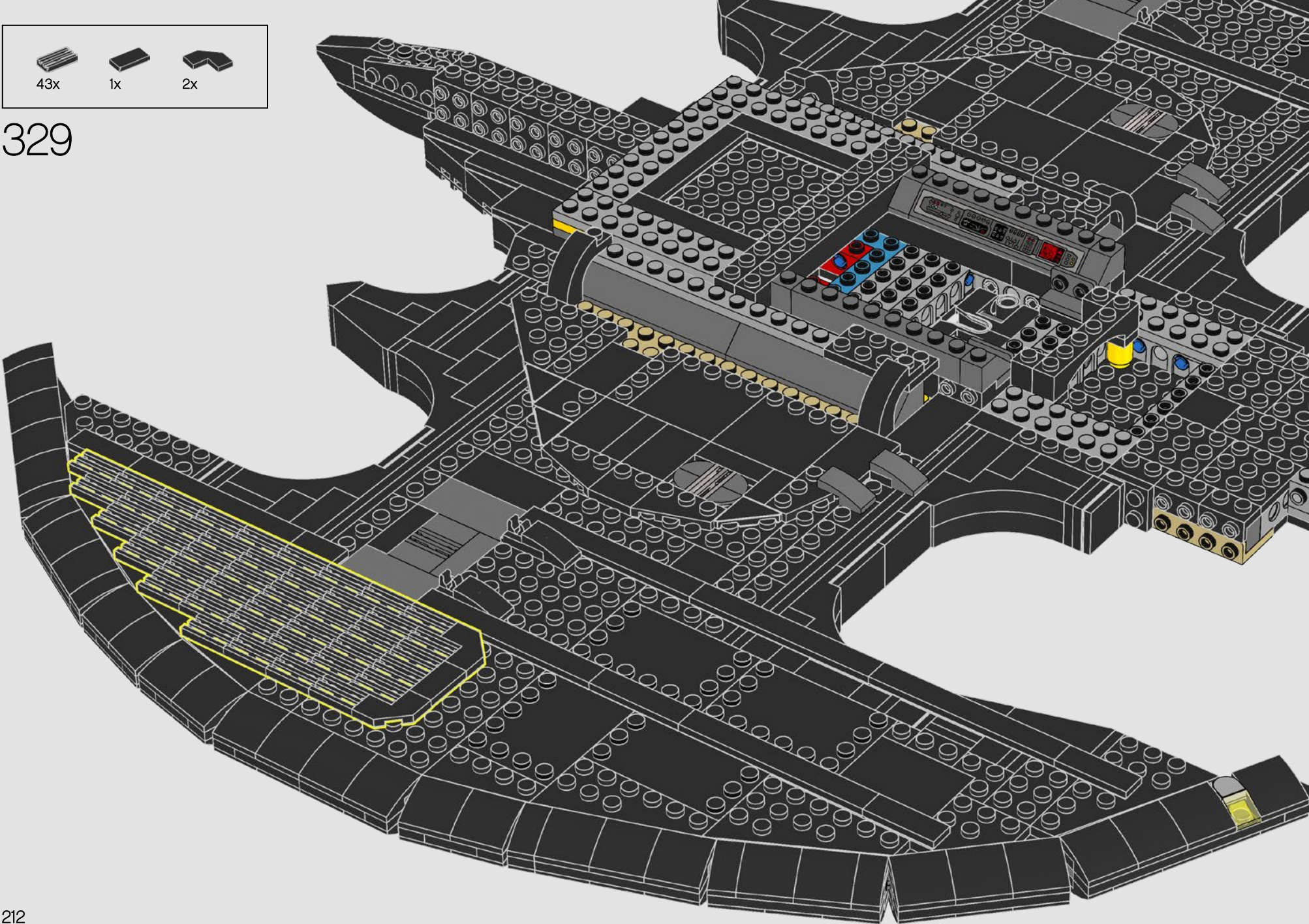

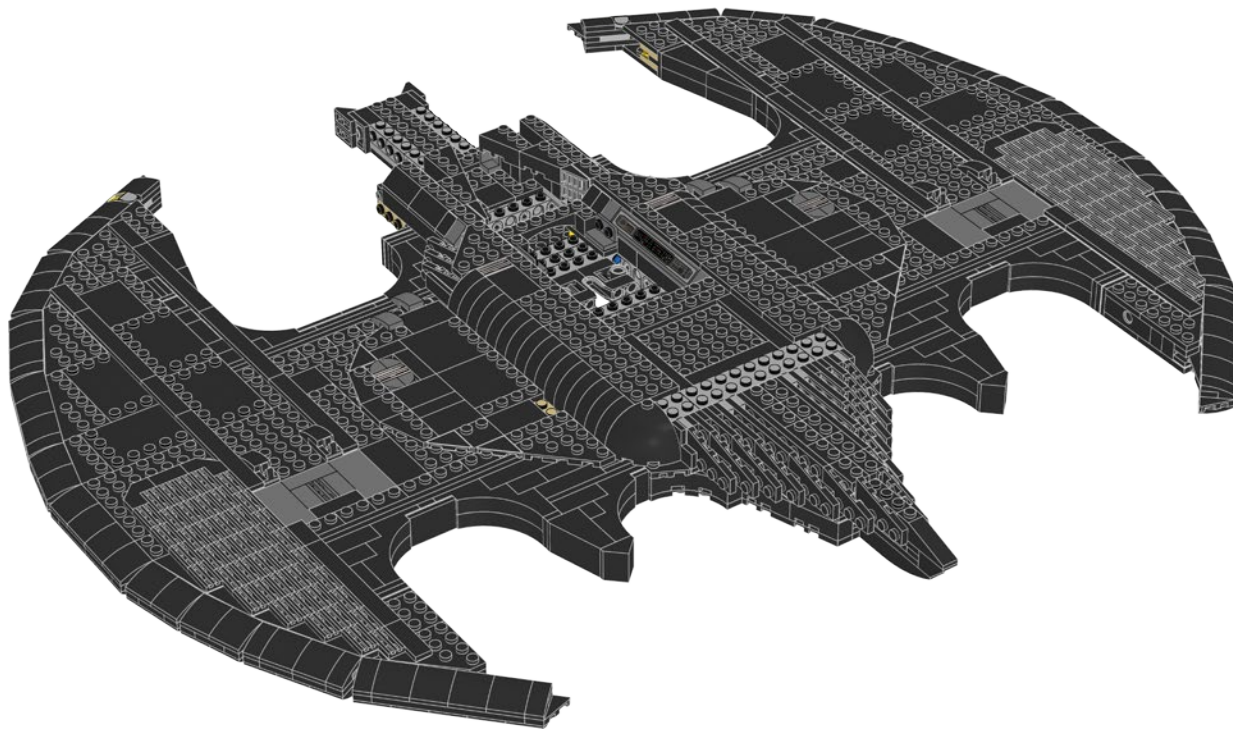
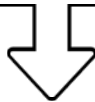

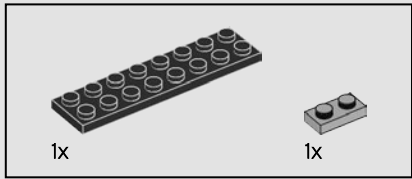
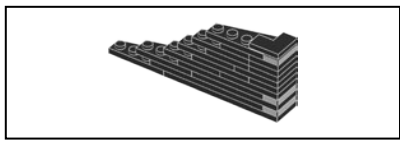

330

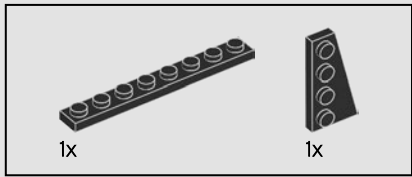
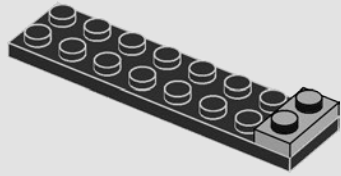

331

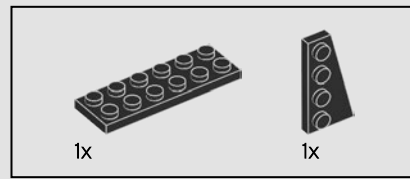
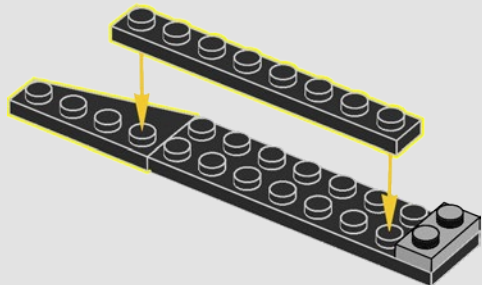

332

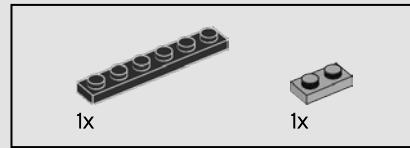
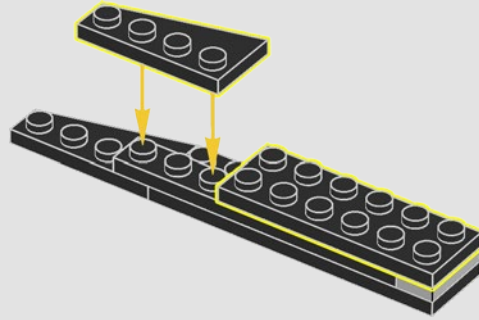

333

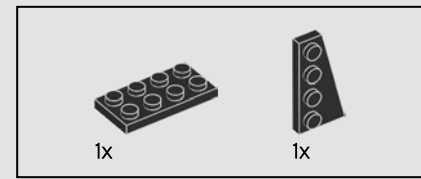
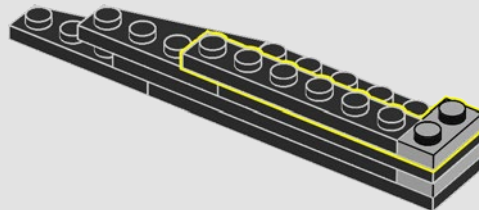

334

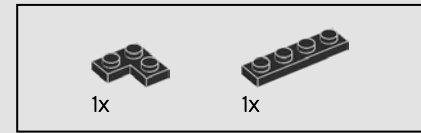
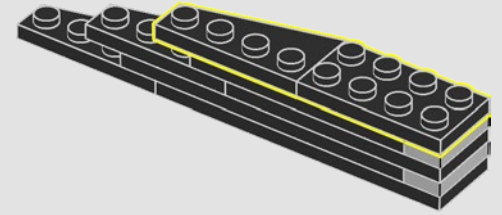

335

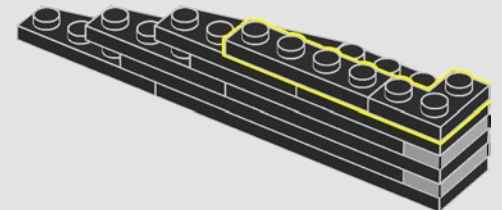

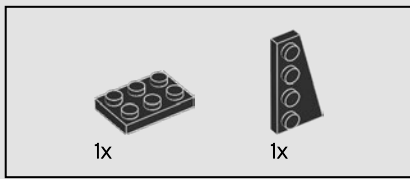

336

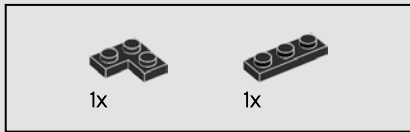
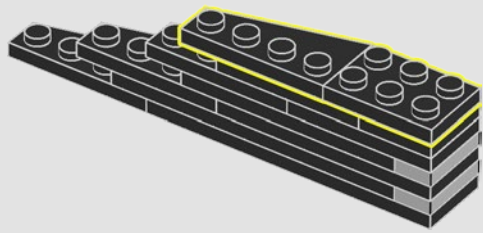

337

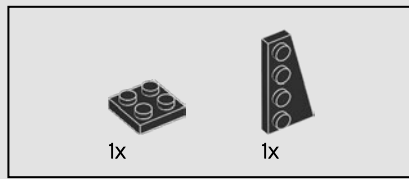
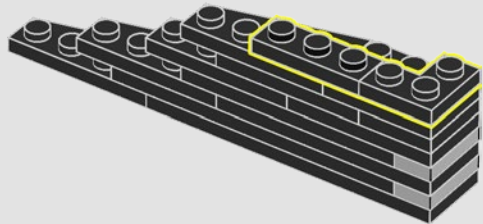

338

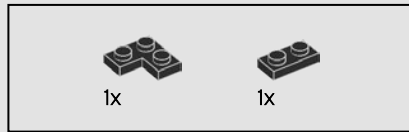
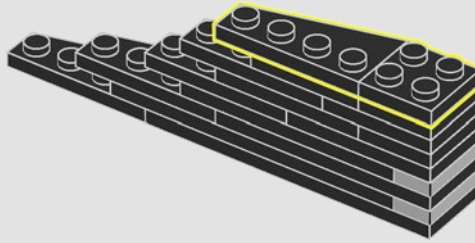

339

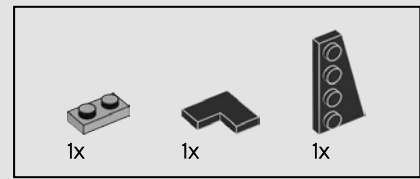
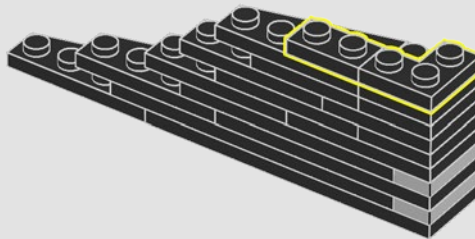

340

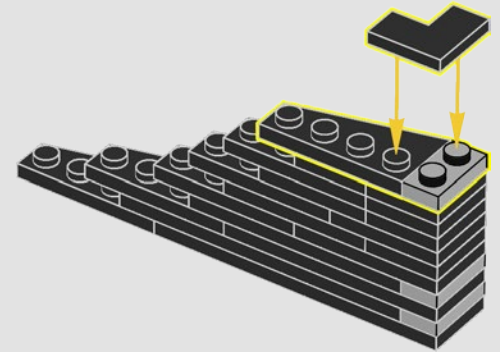

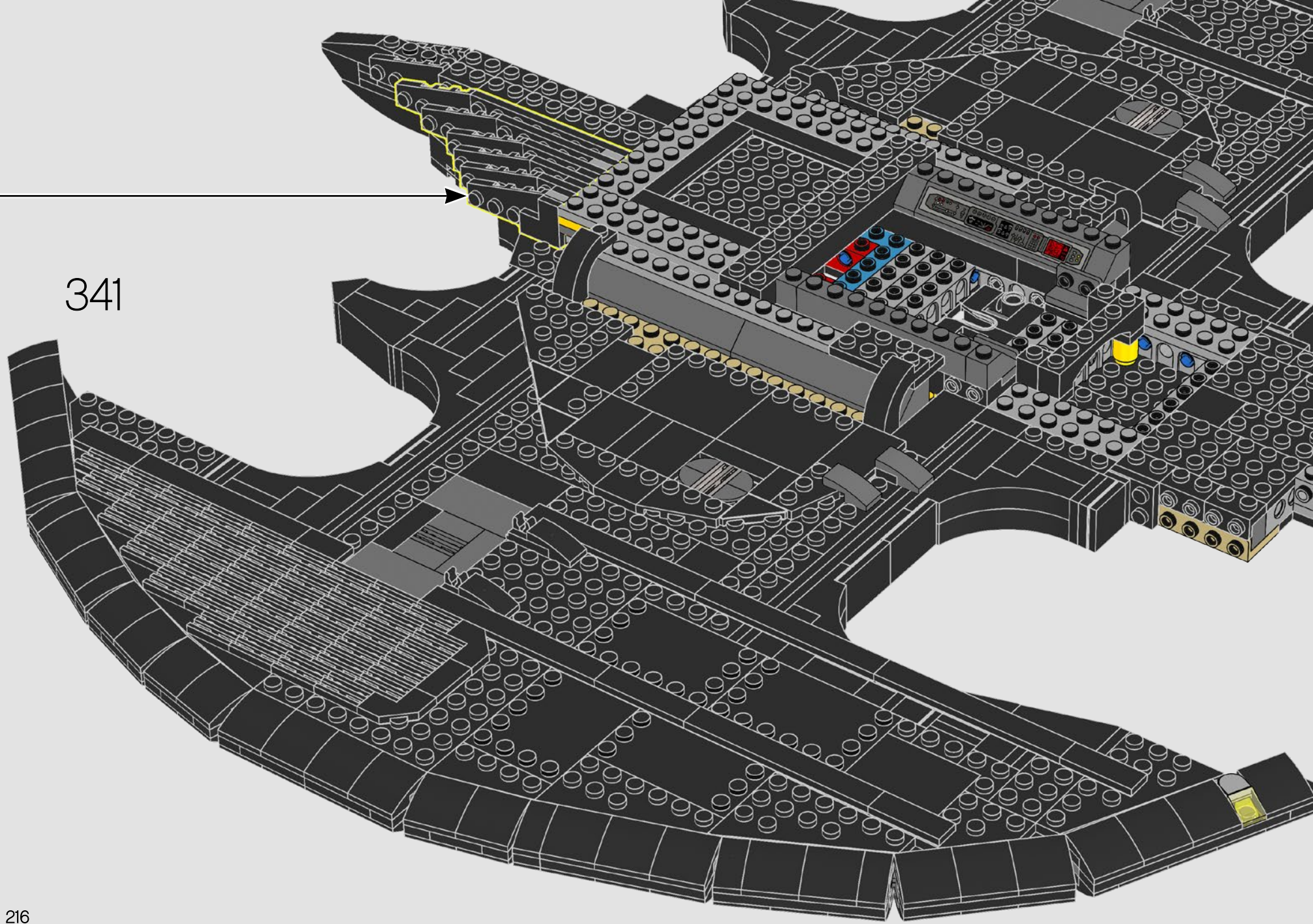

341



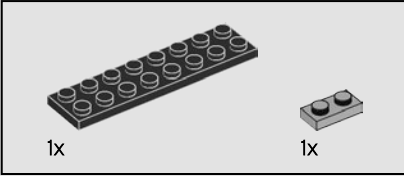
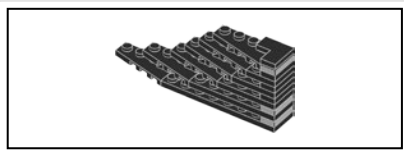

342

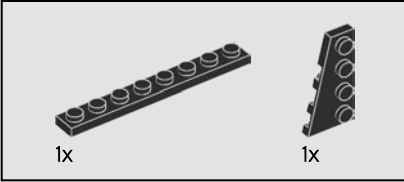
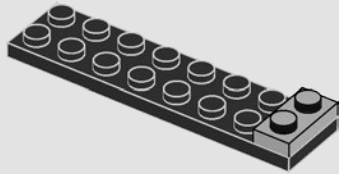

343

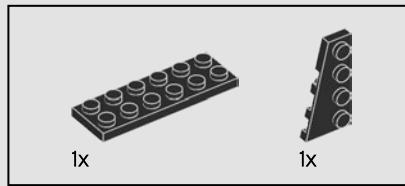
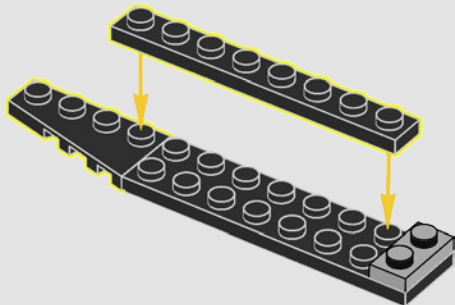

344

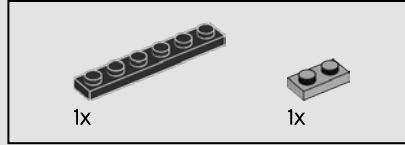
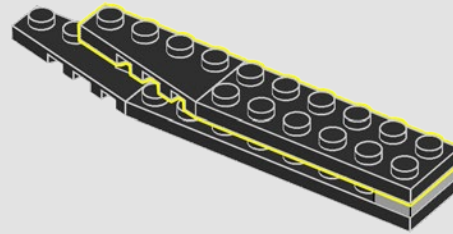

345

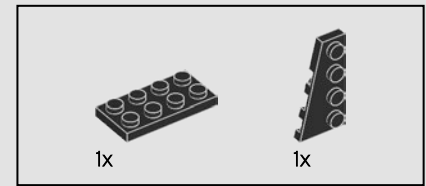
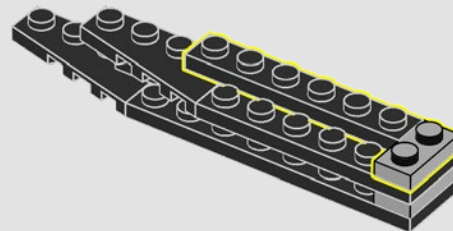

346

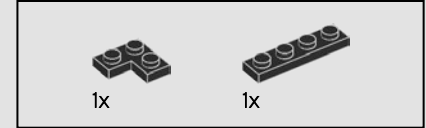
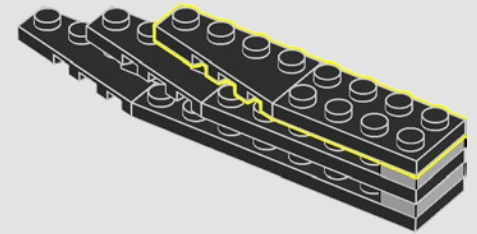

347

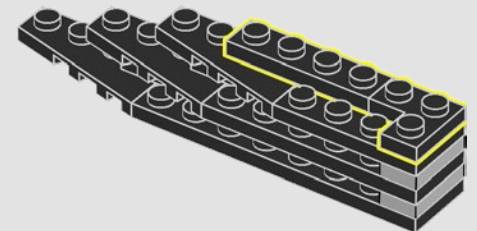

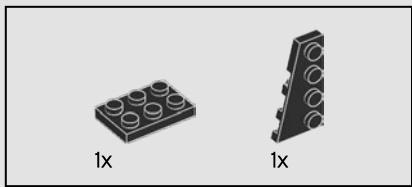

348

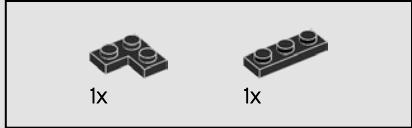
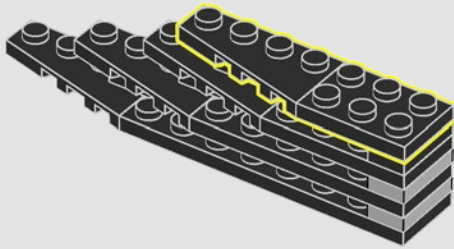

349

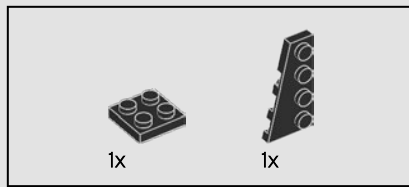
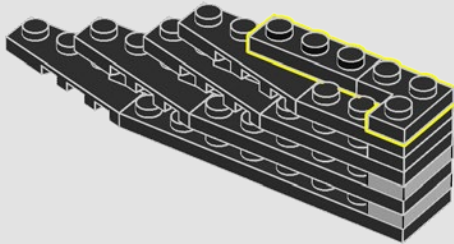

350

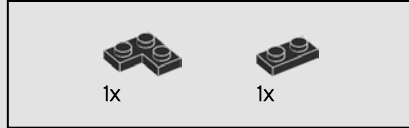
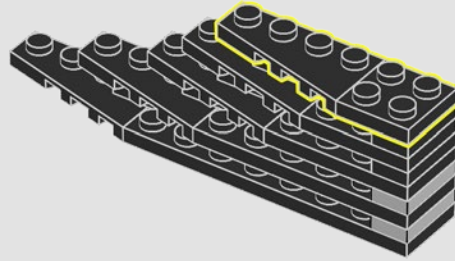

351

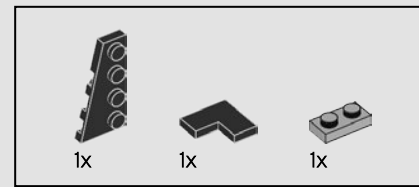
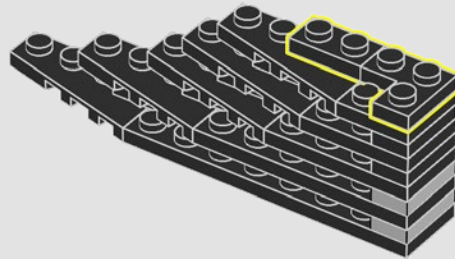

352

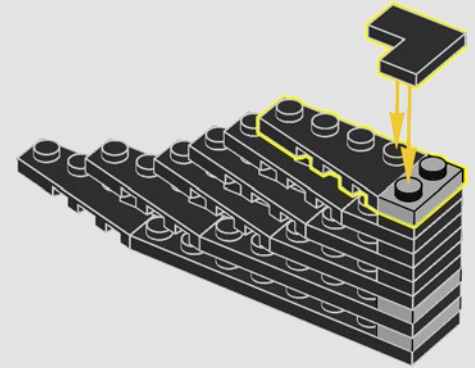

353

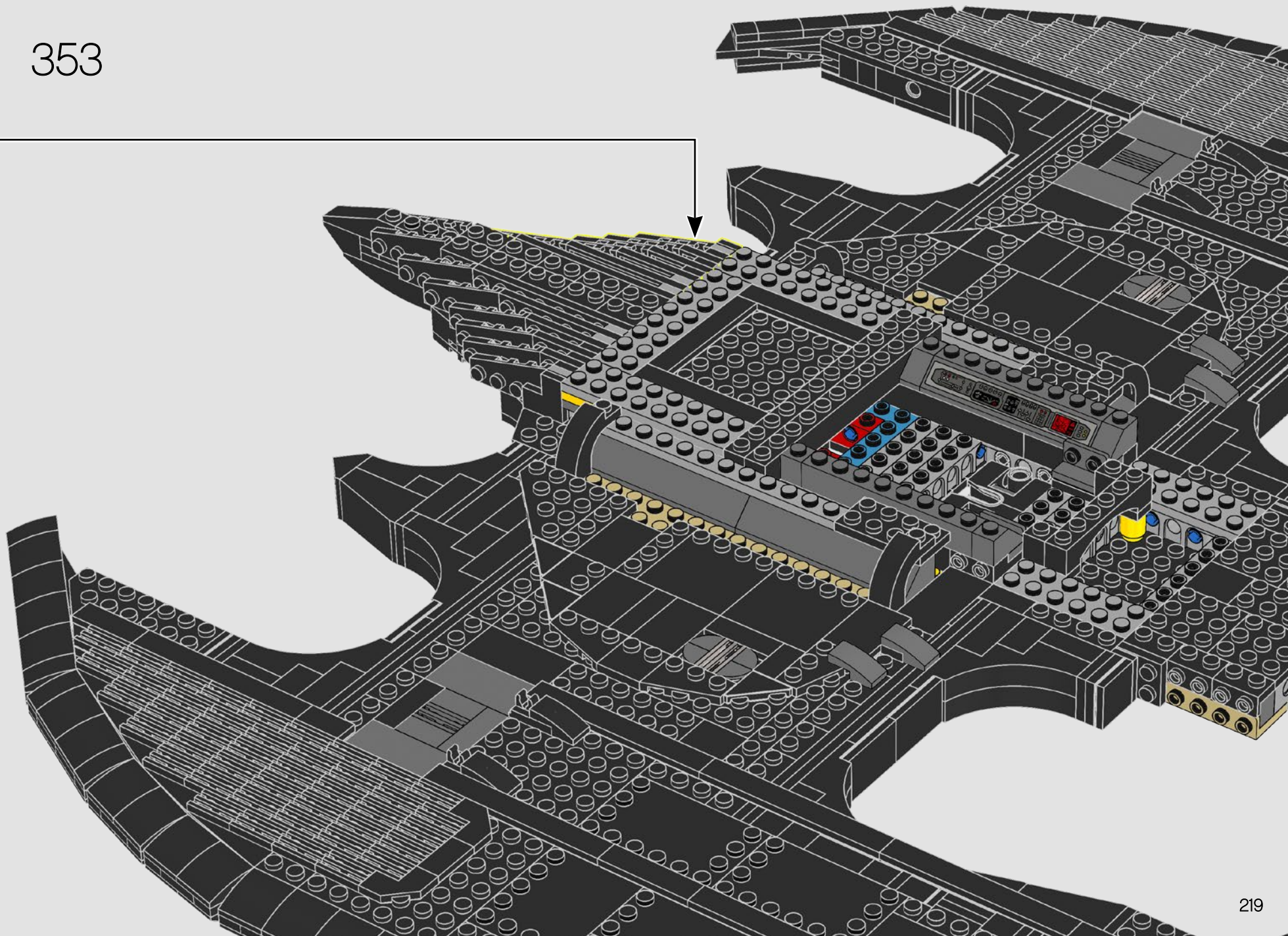



4x

354

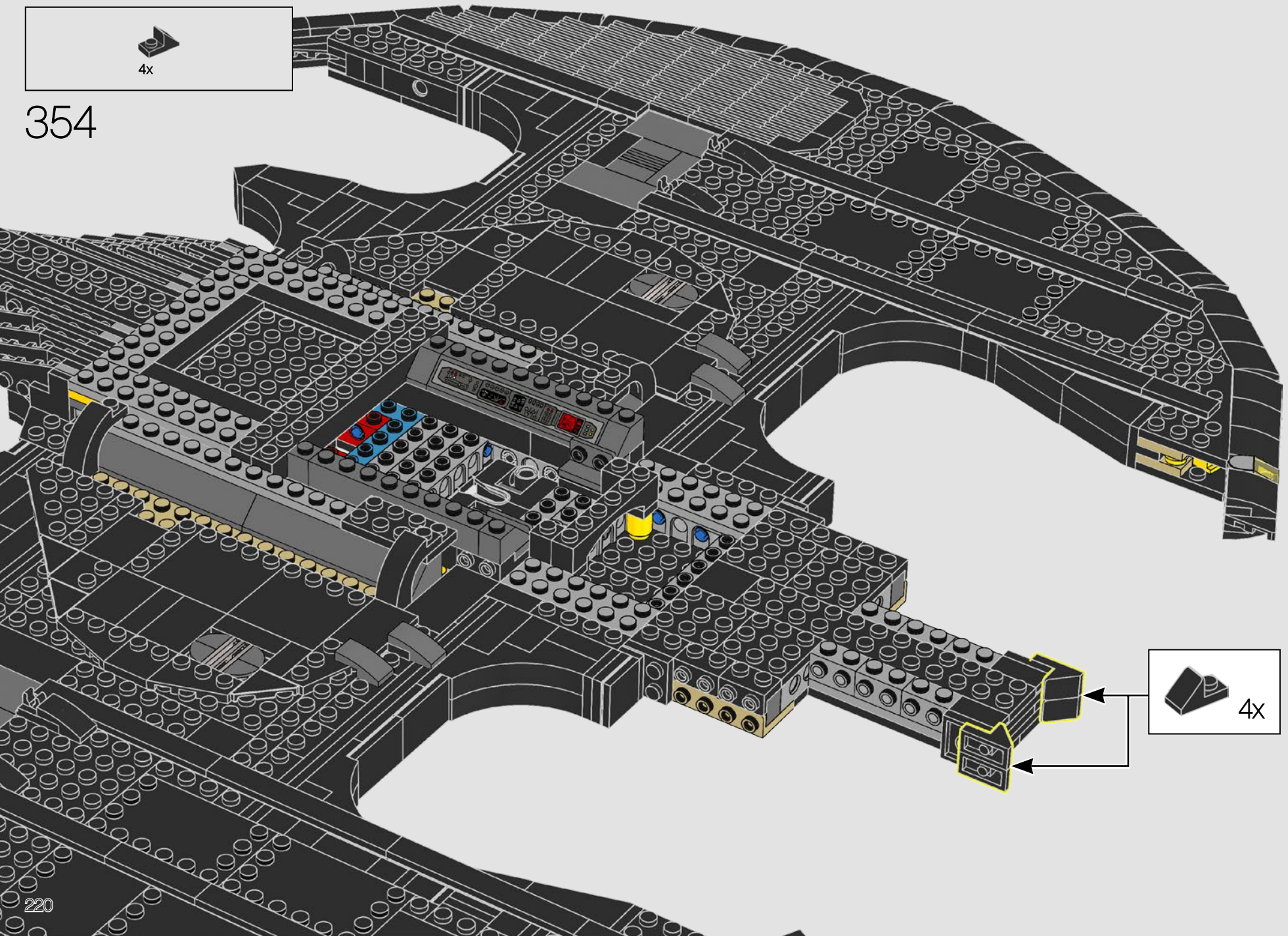

4x

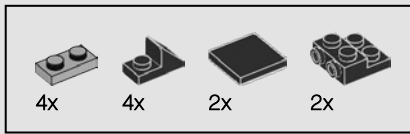

355

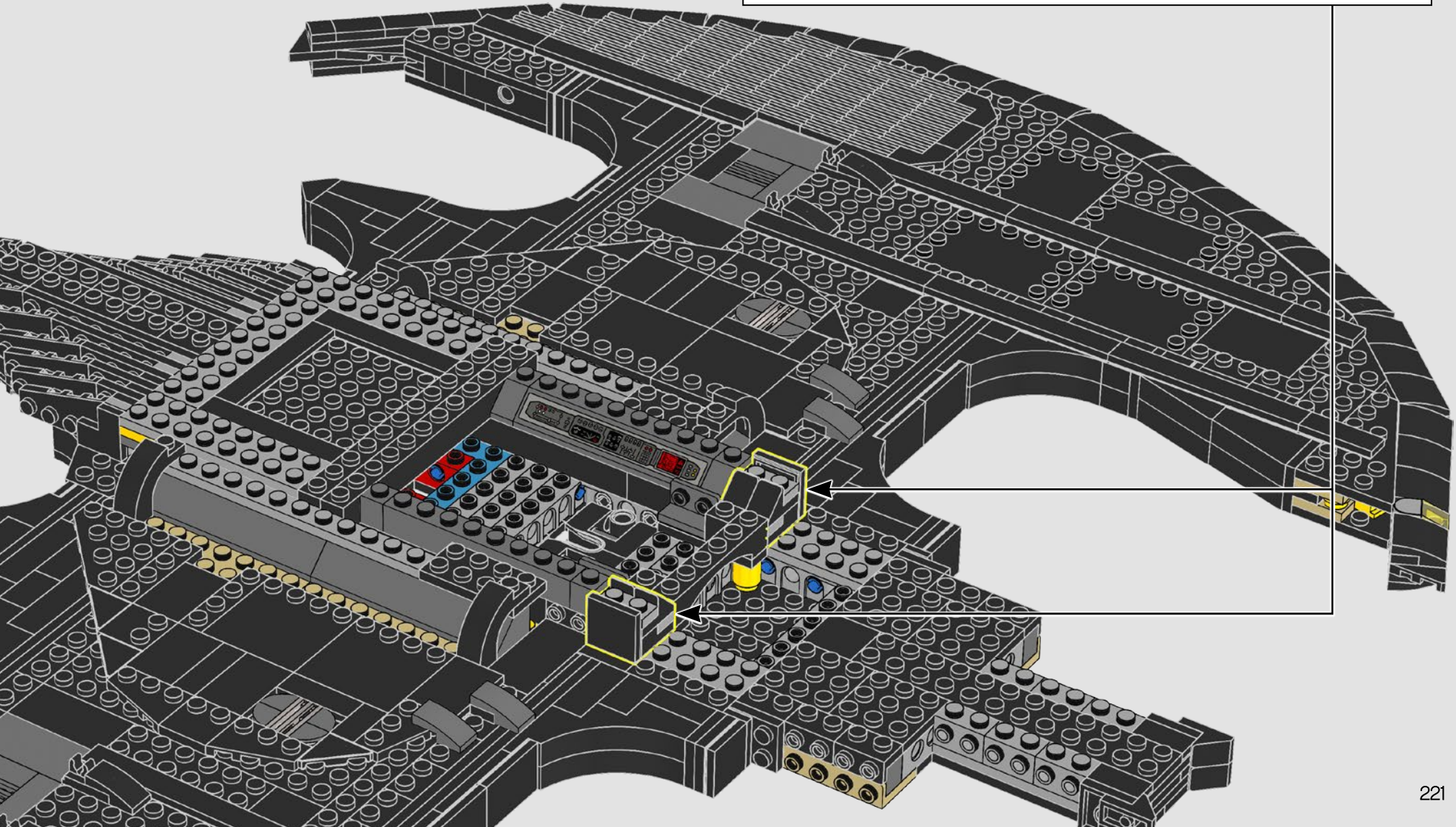
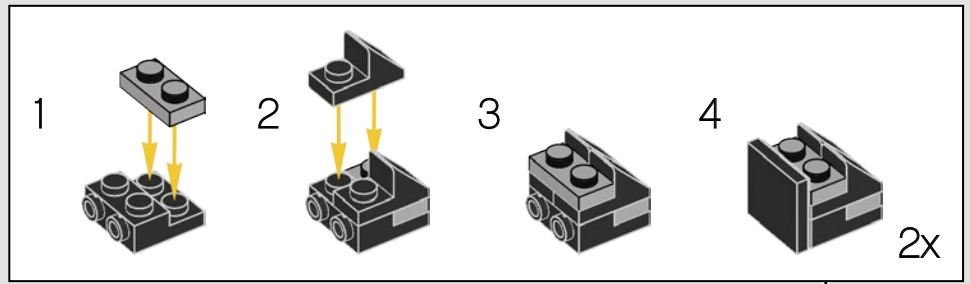

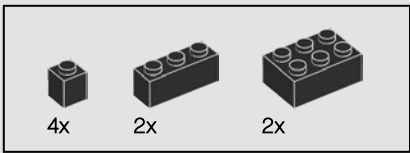

356

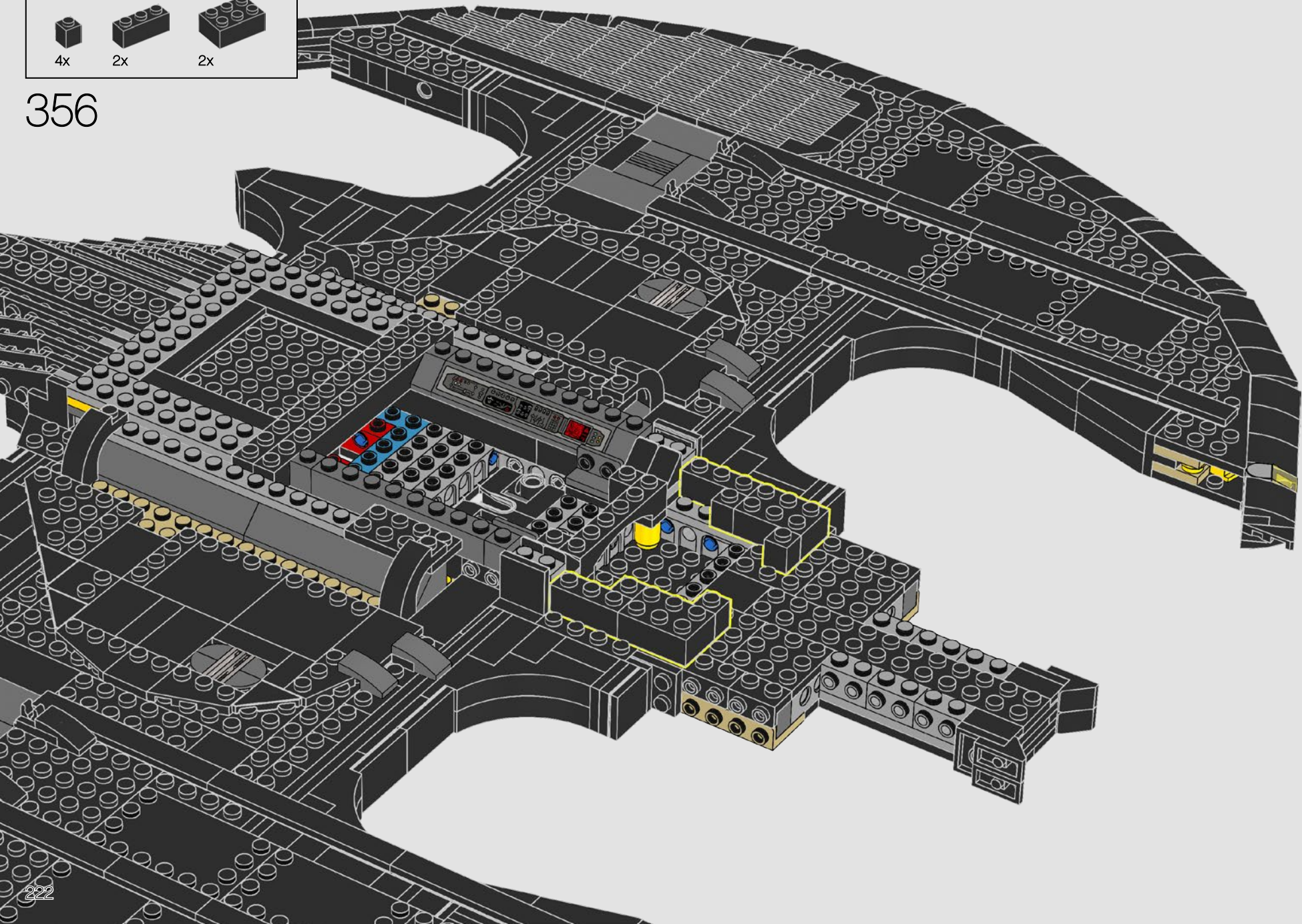

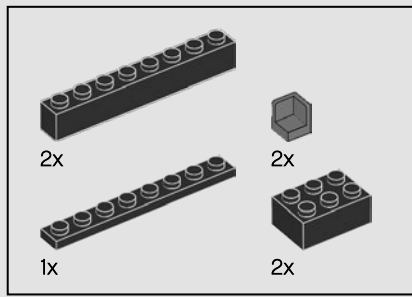

357

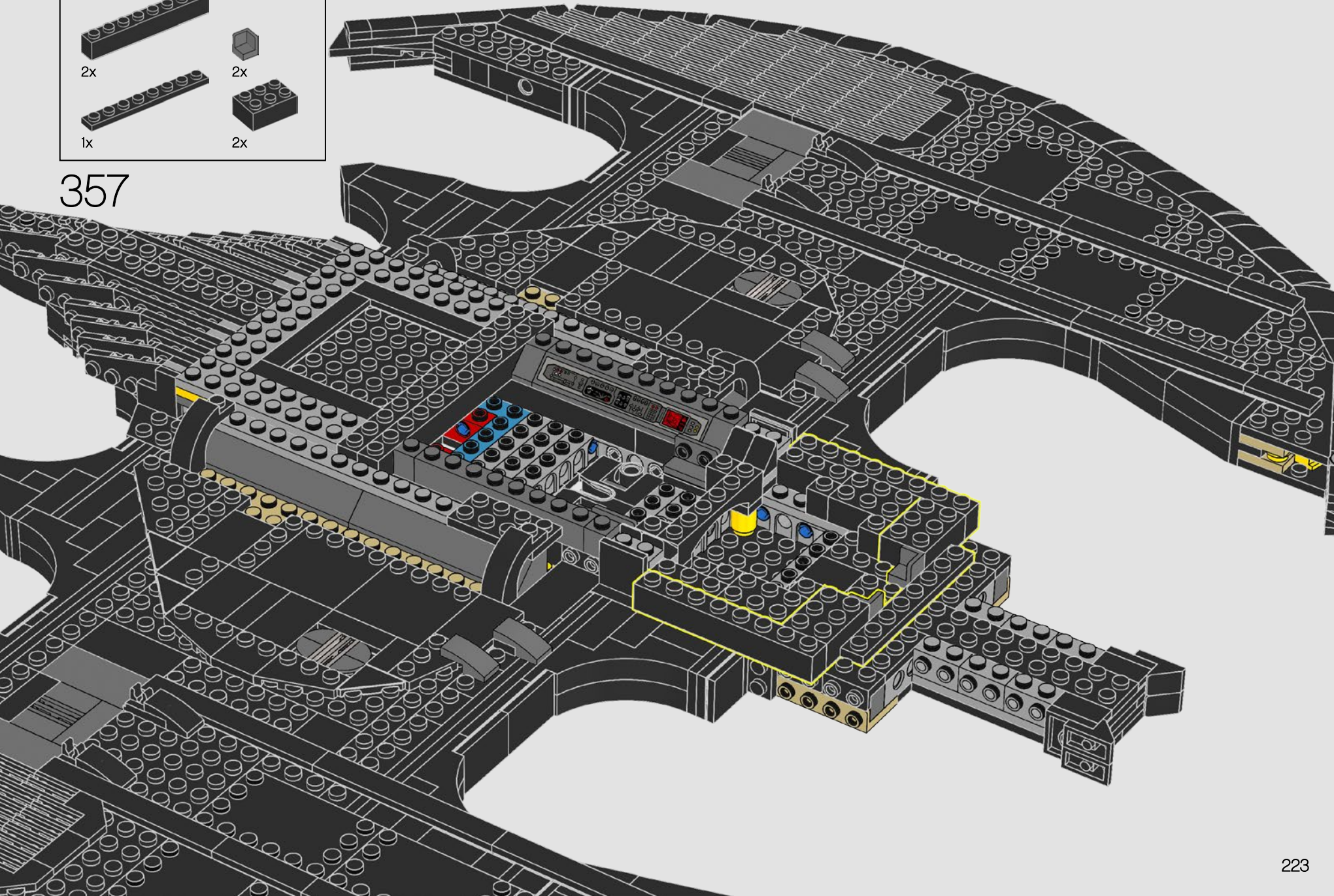

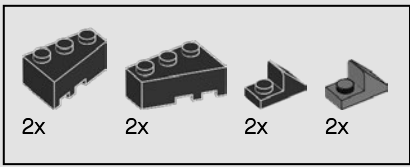

358

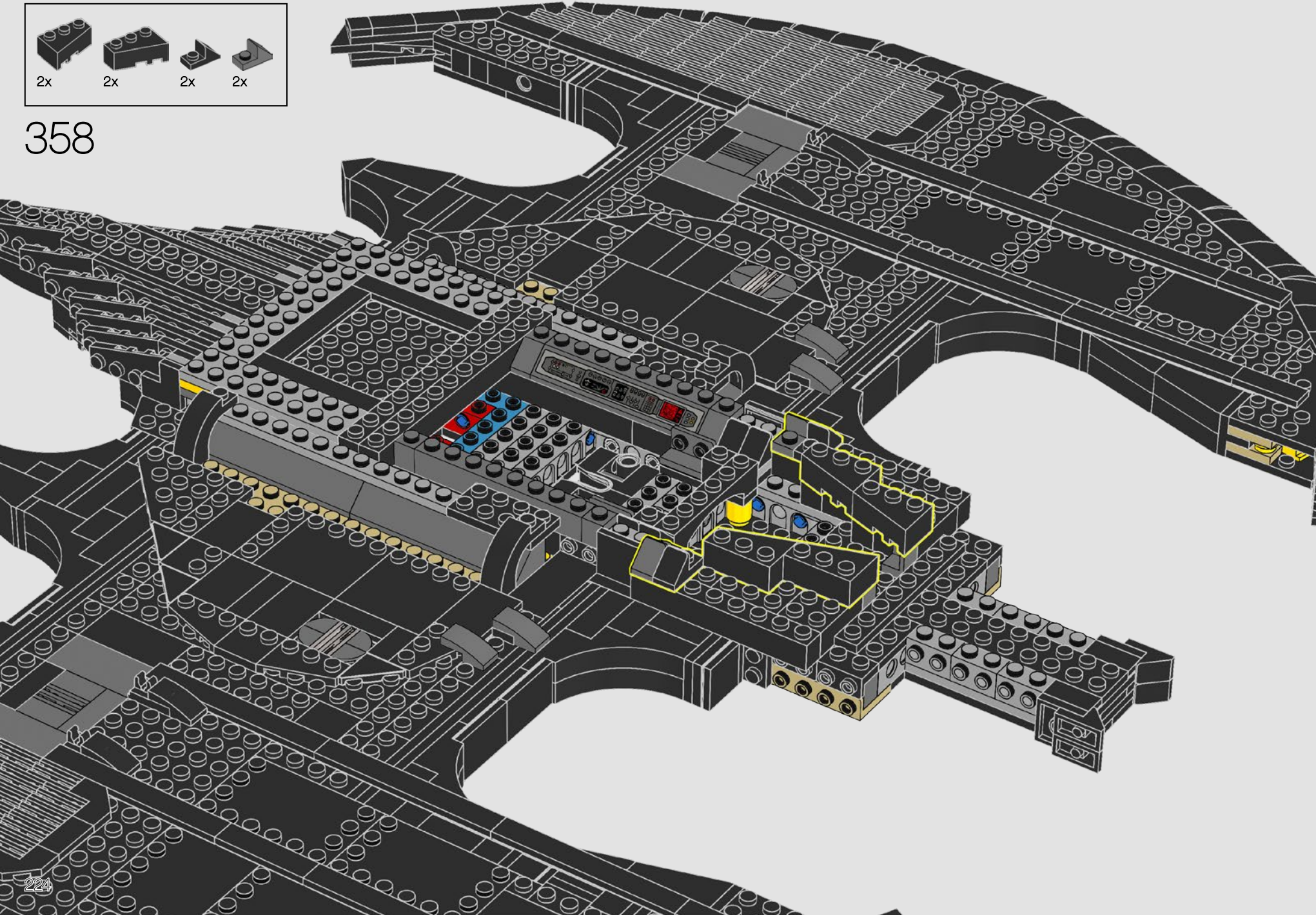



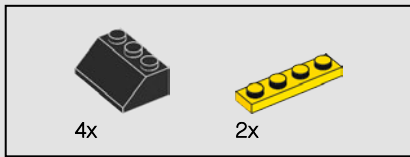

359

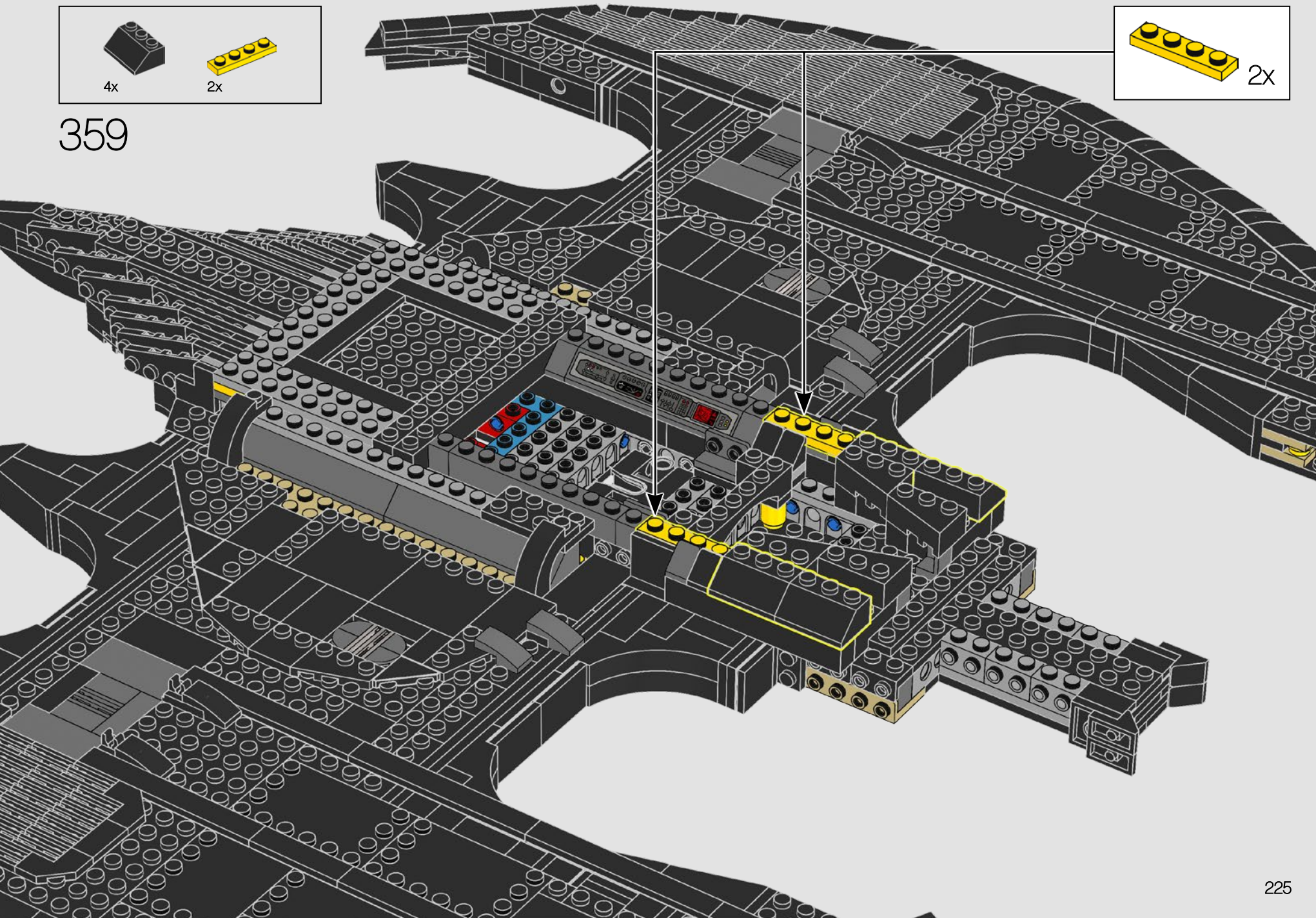
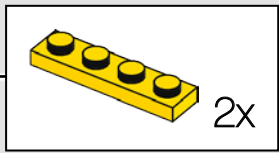



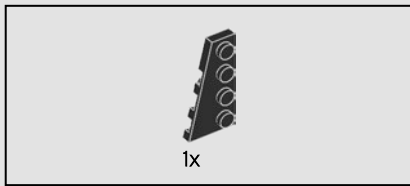

364

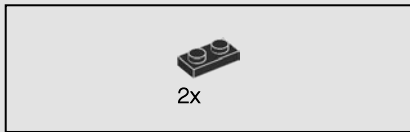
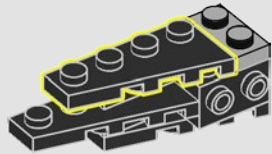

365

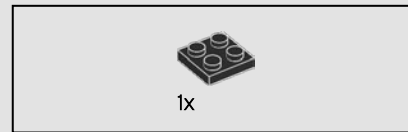
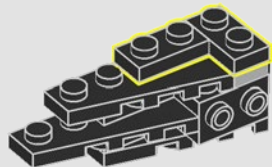

366

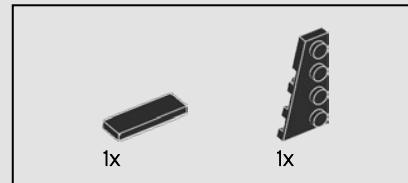
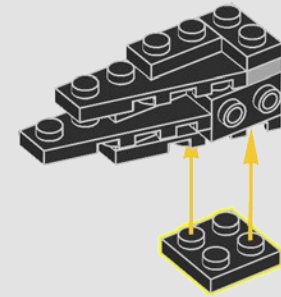

367

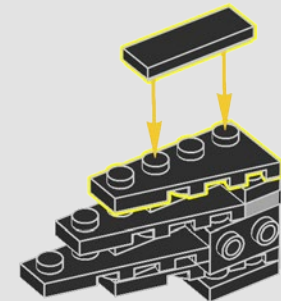

368

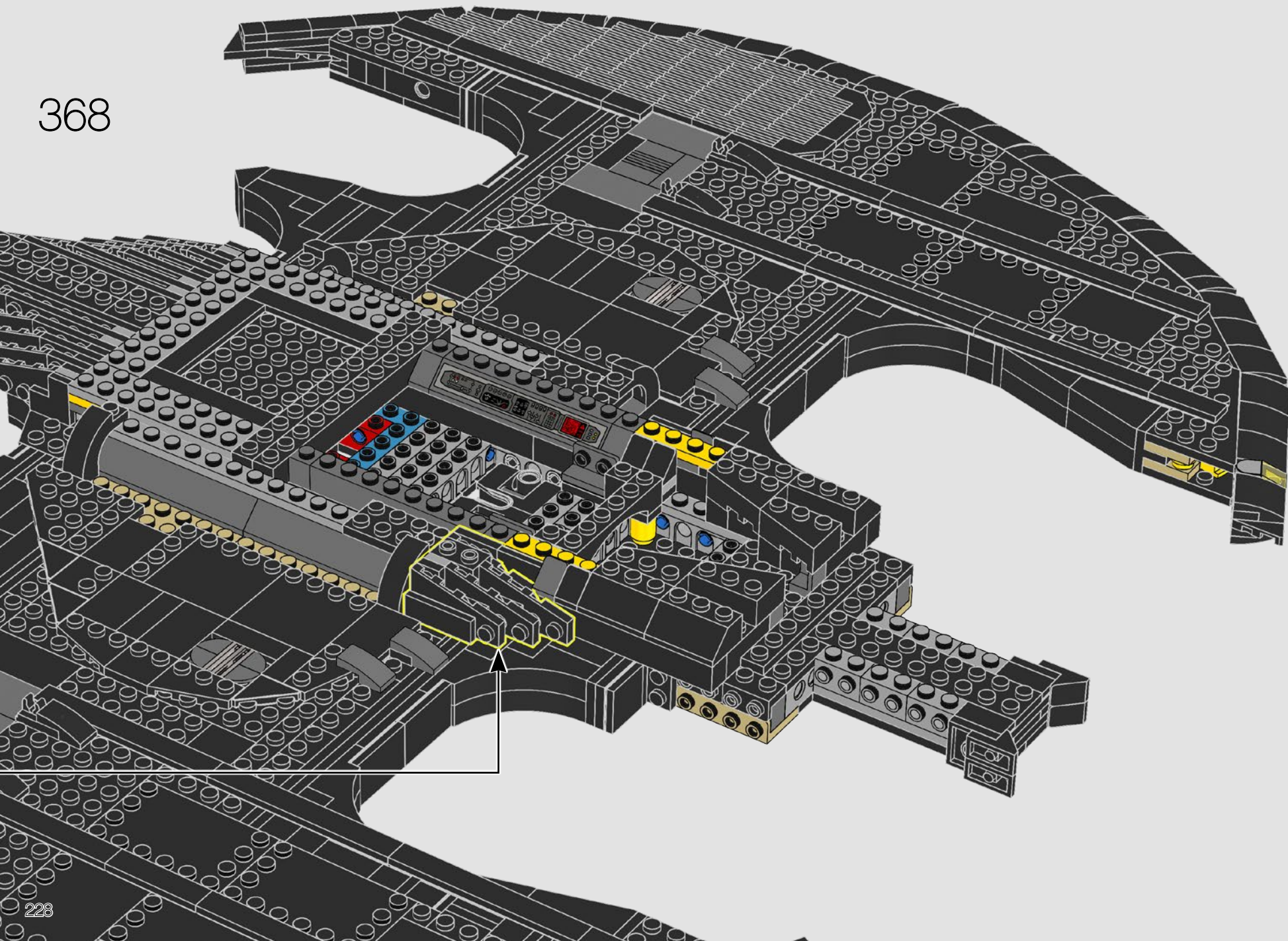

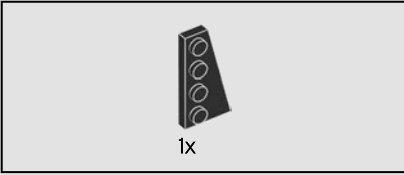
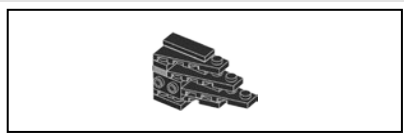

369

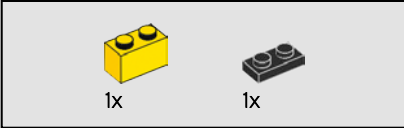
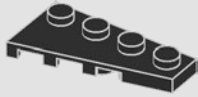

370

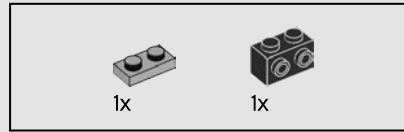
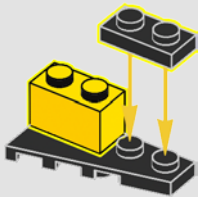

371

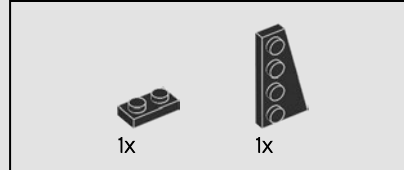
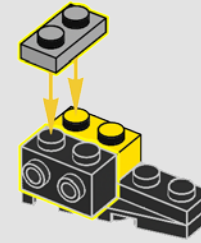

372

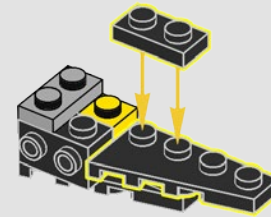



1x

373

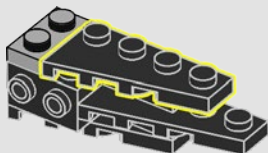

2x

374

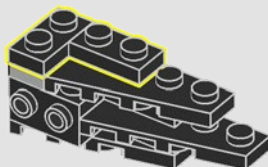

1x

375

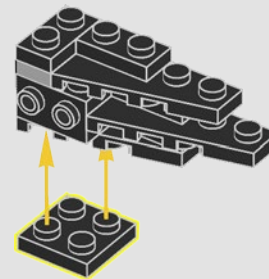

1x



1x

376

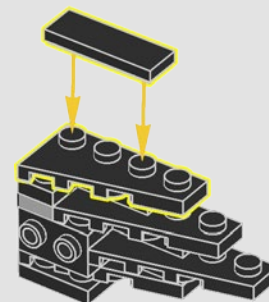

377

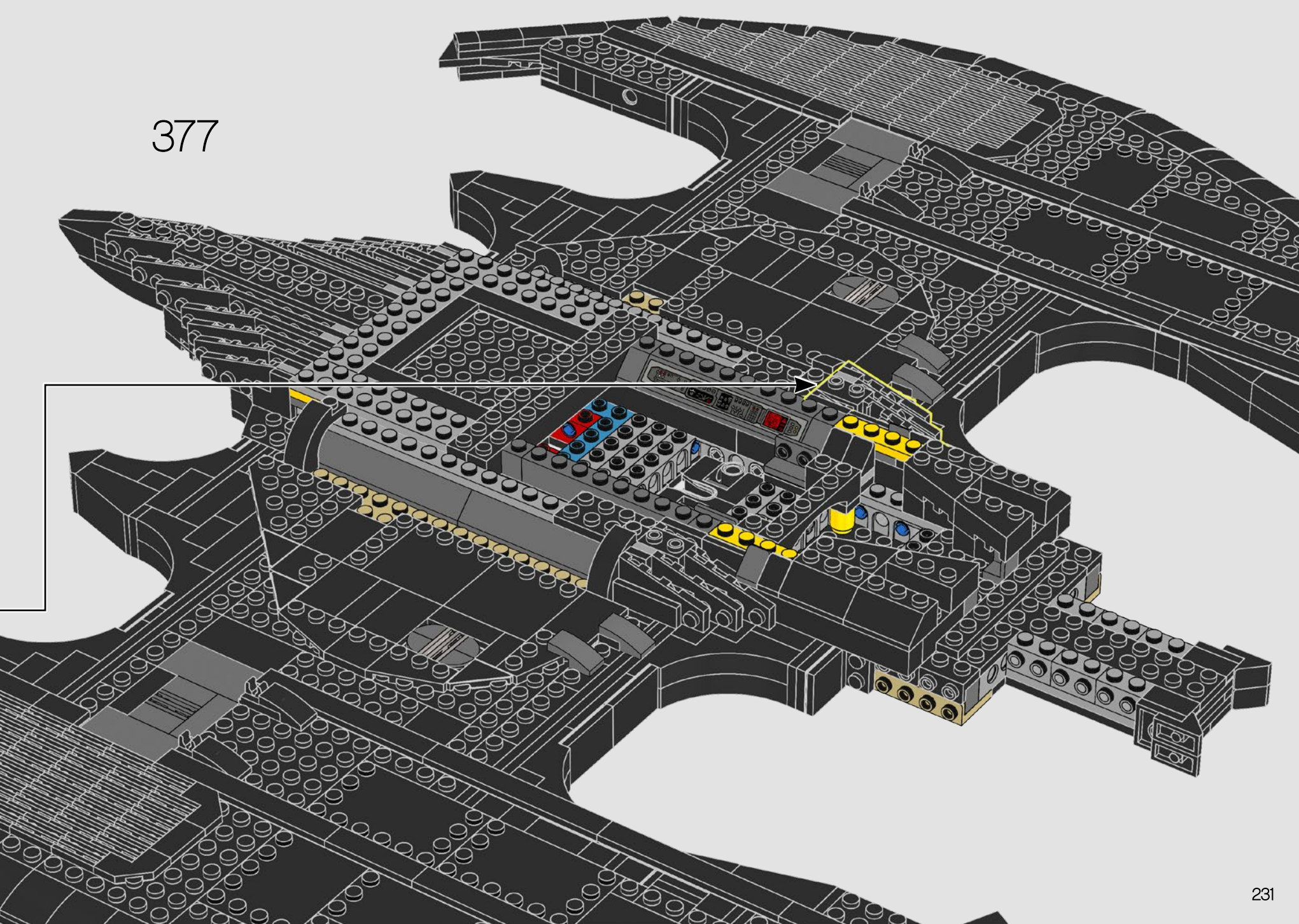

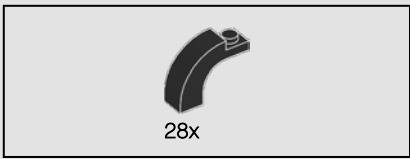

378

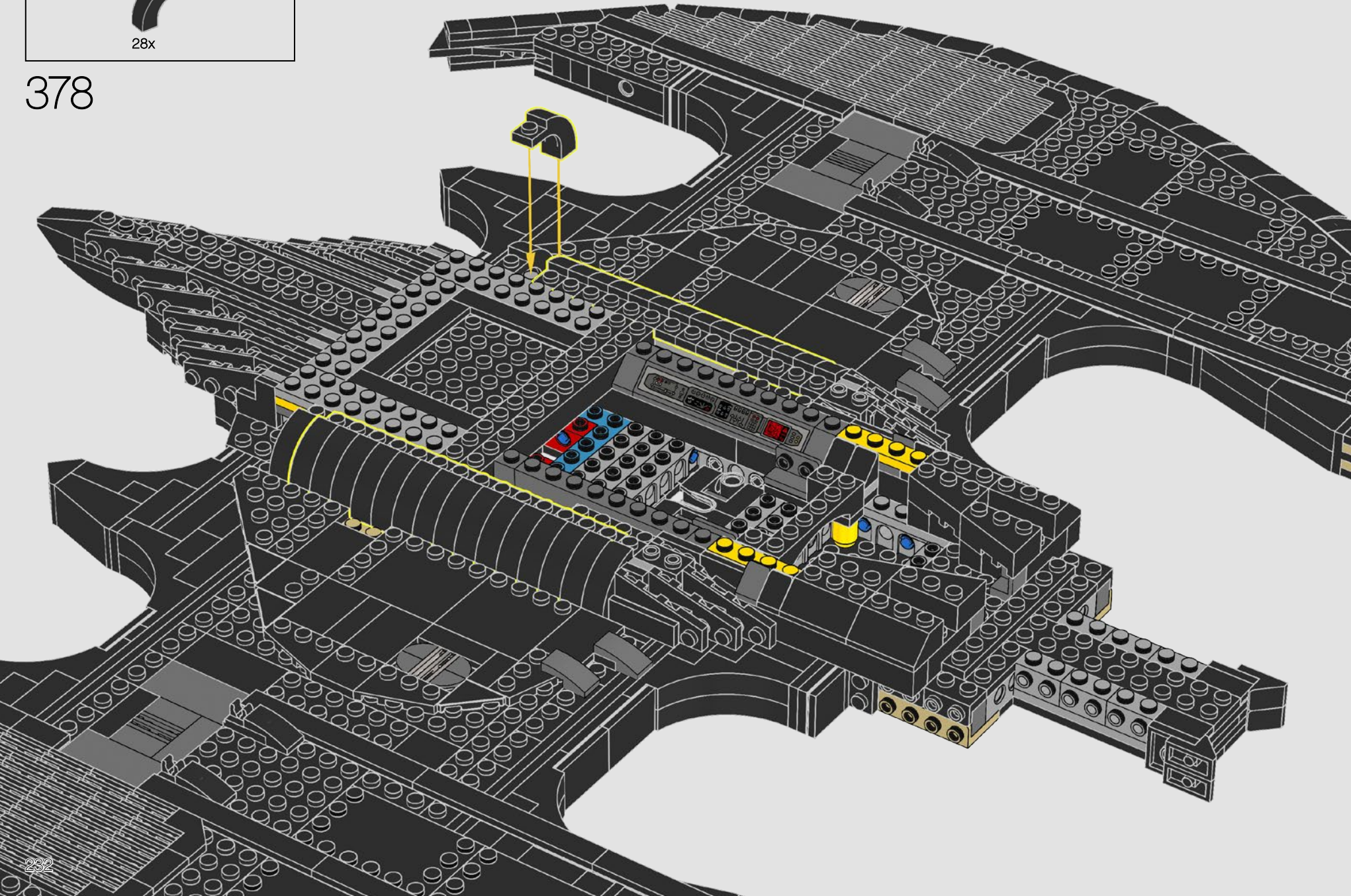



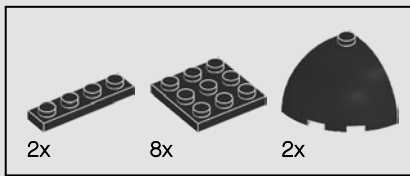

379

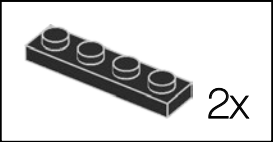
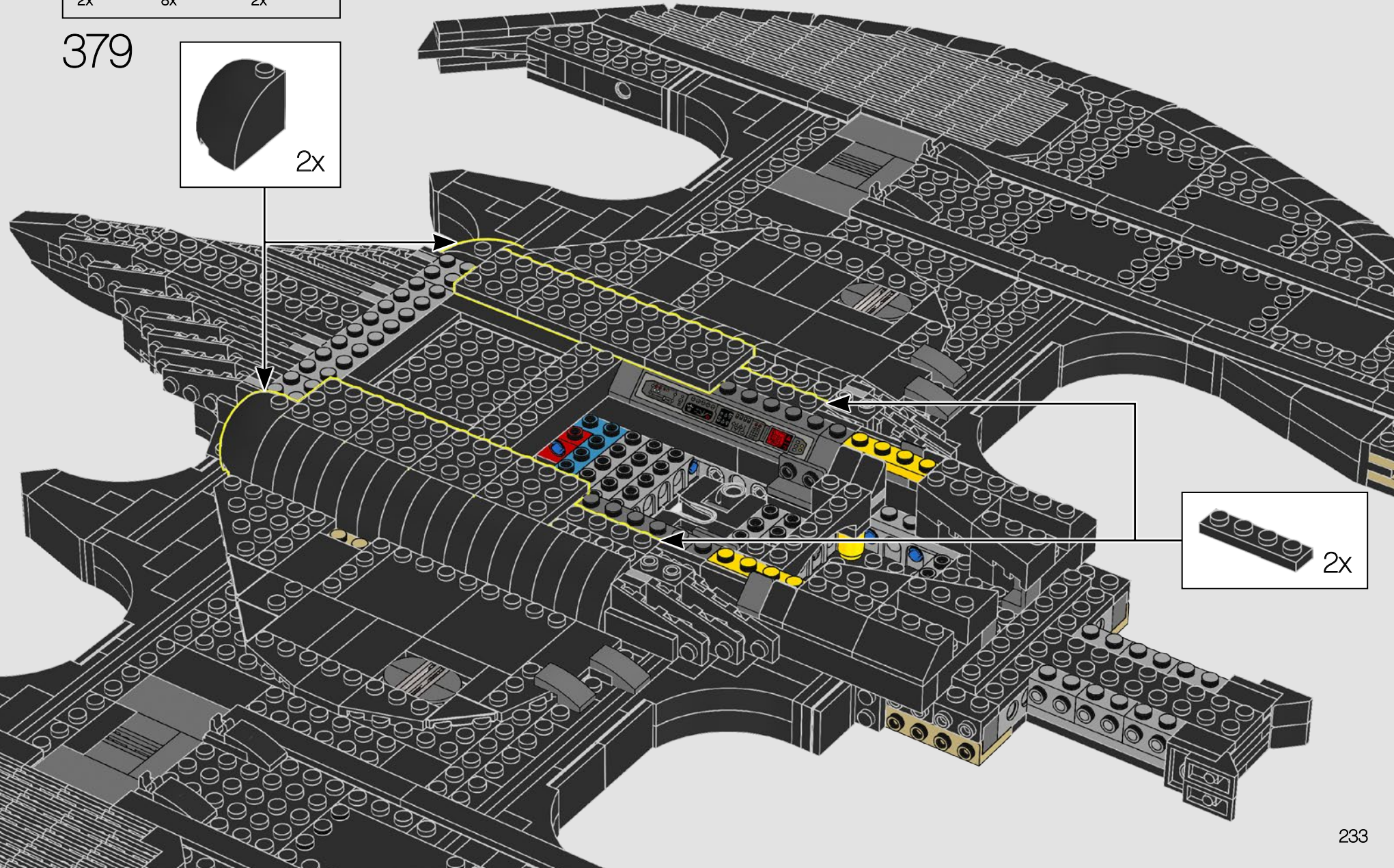
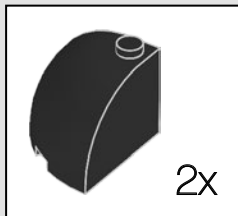

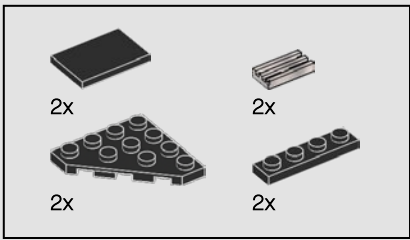

380

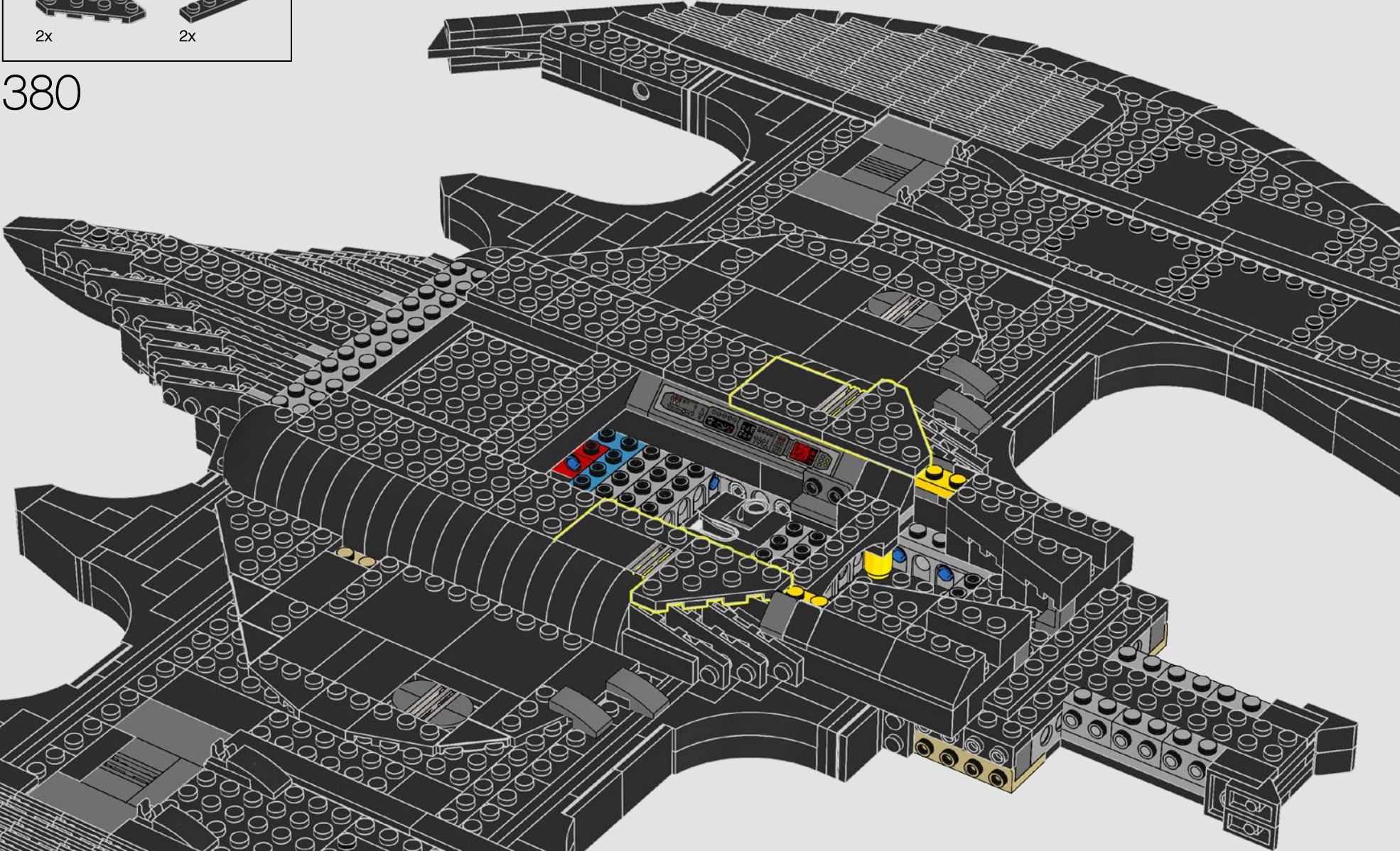

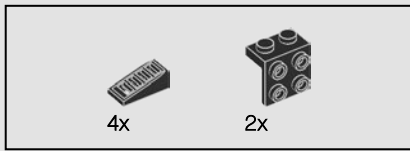

381

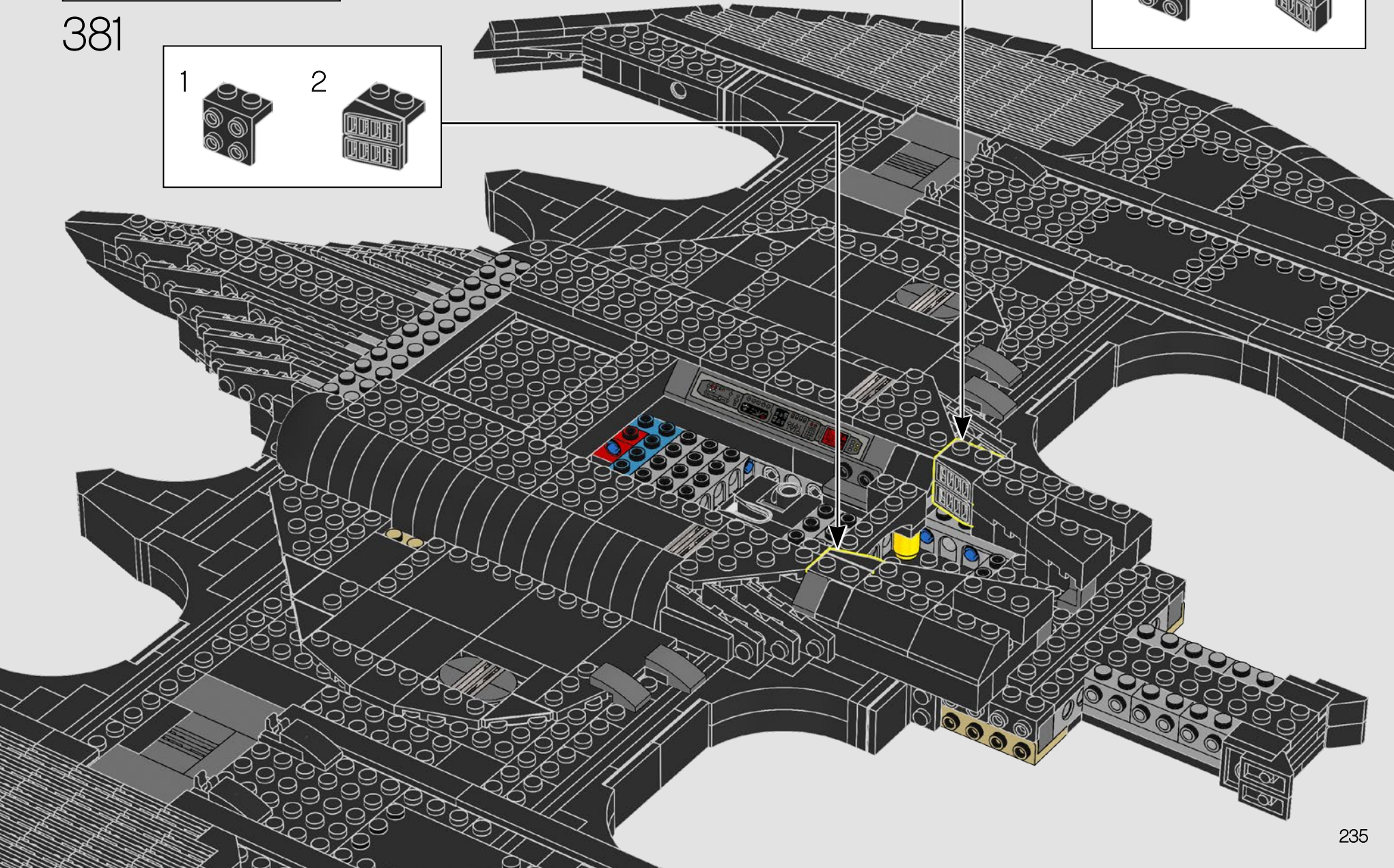
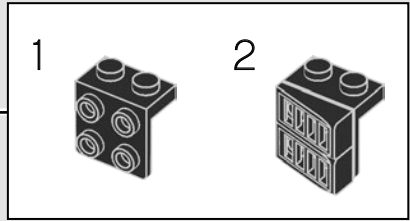
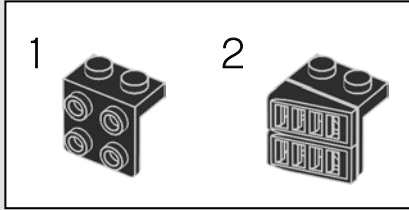

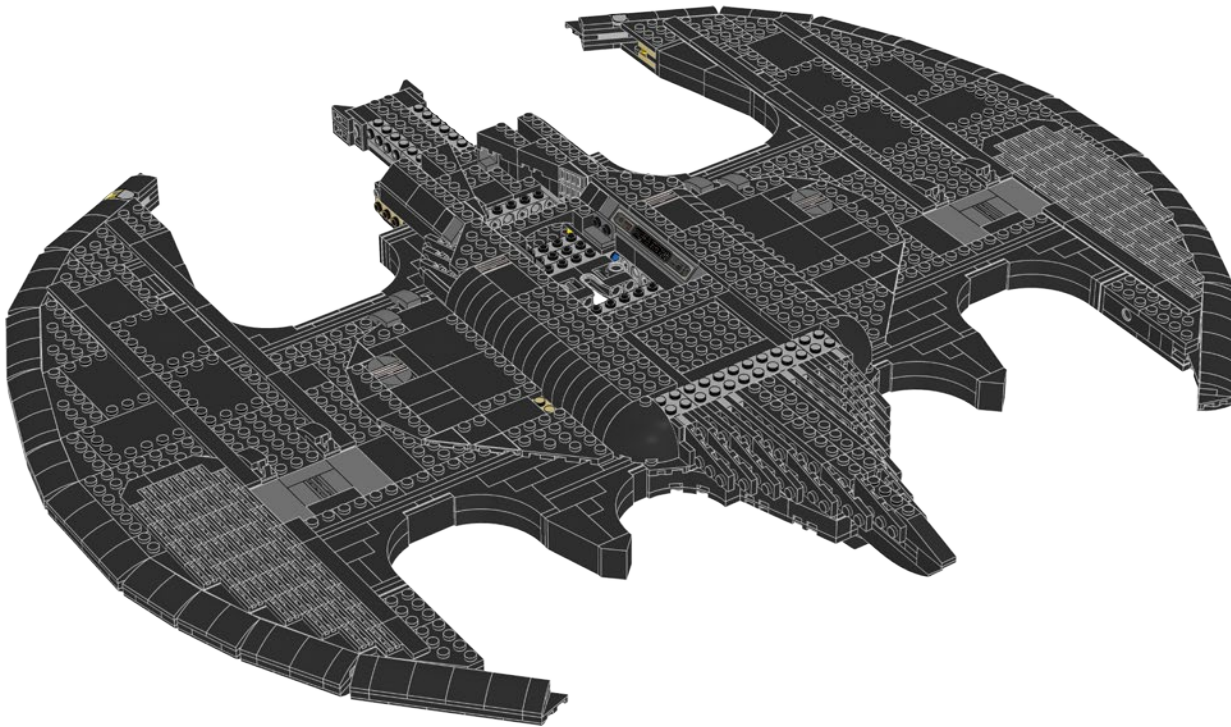
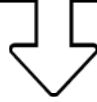
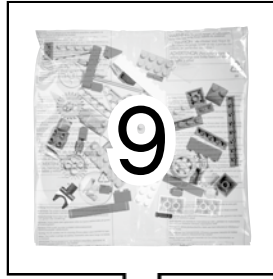

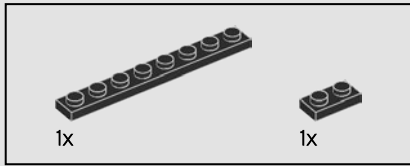
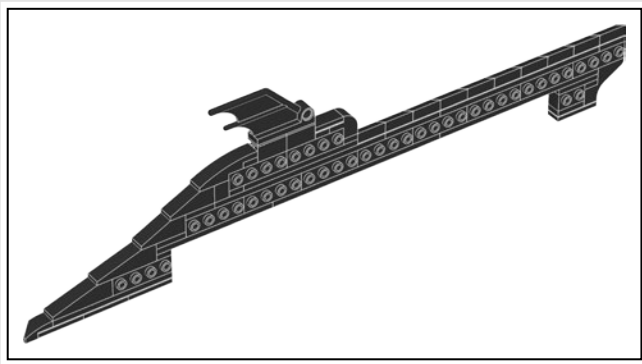

382

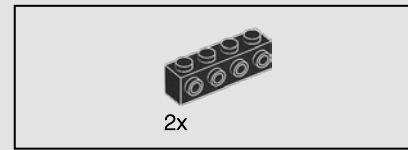
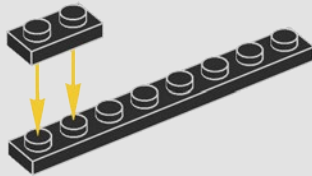

383

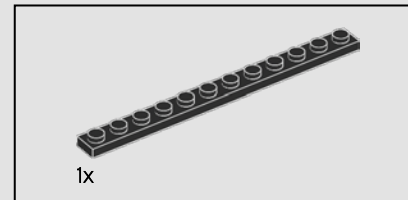
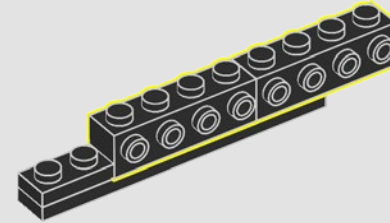

384

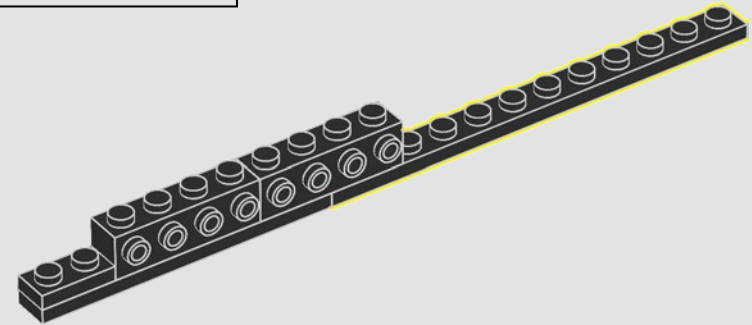

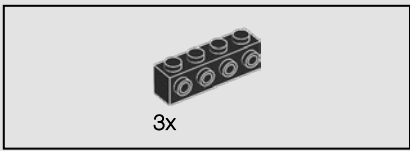

3x

385

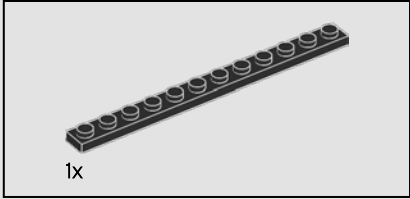
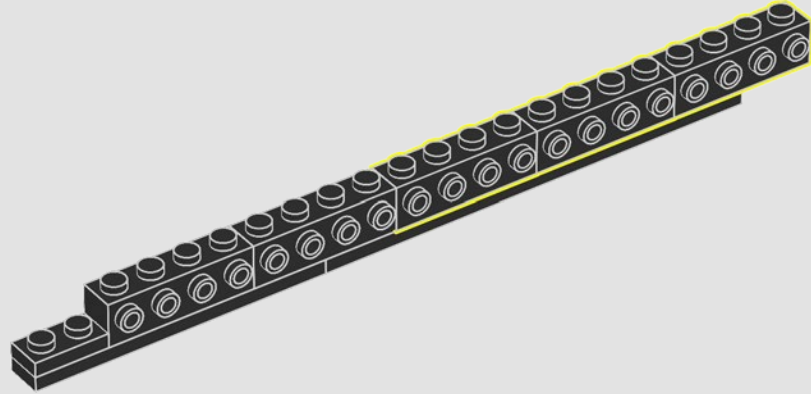

1x

386

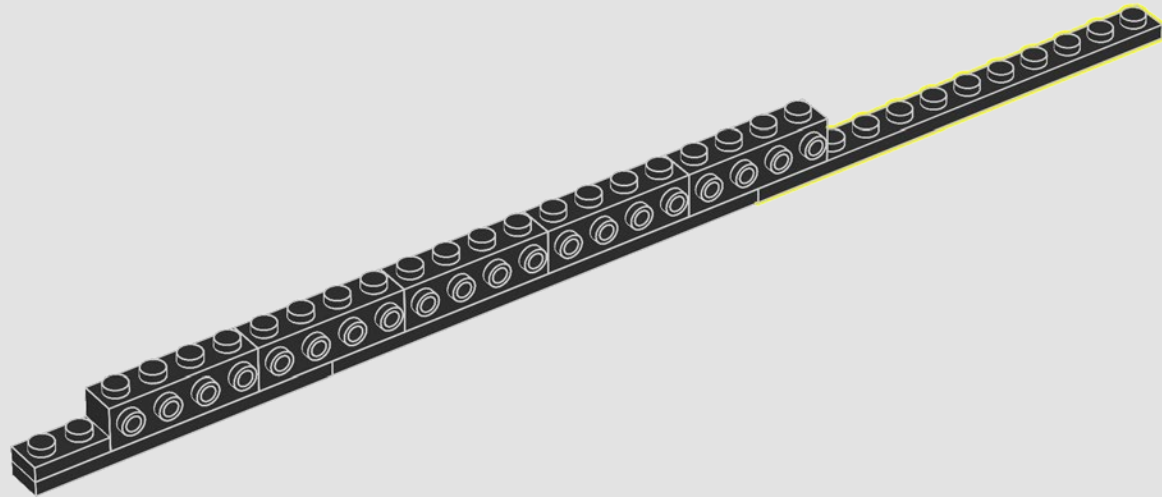

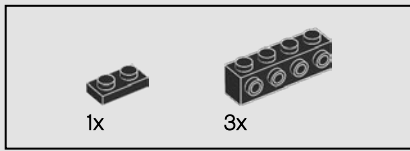

387

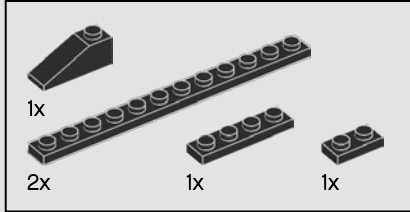
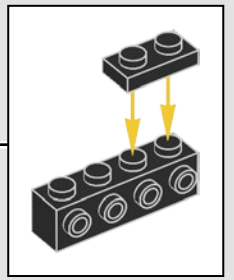
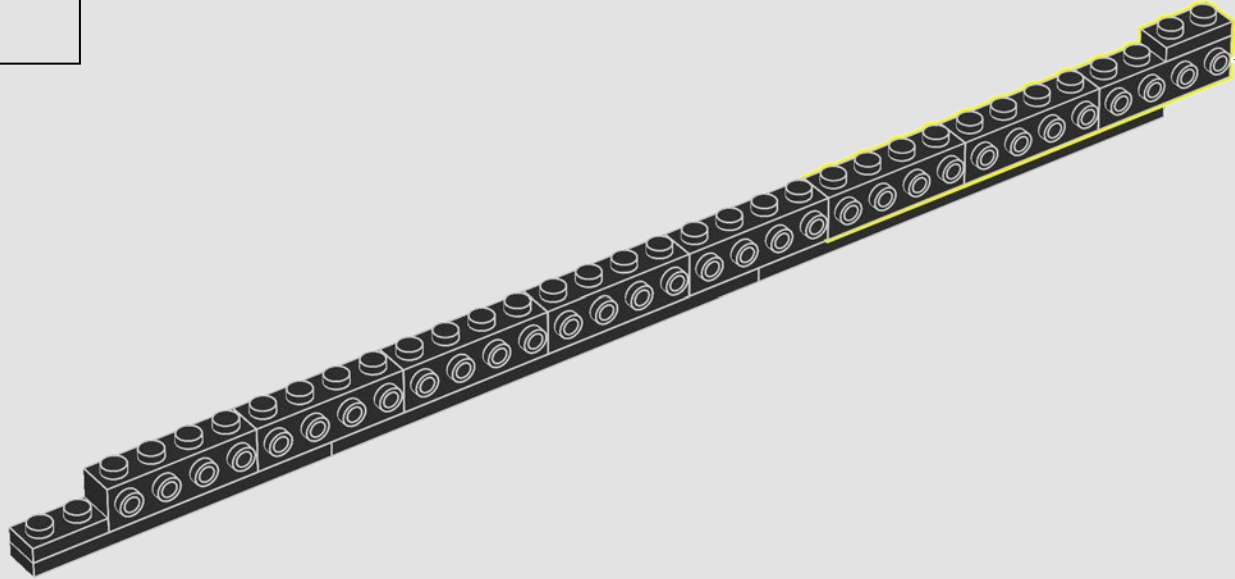

388

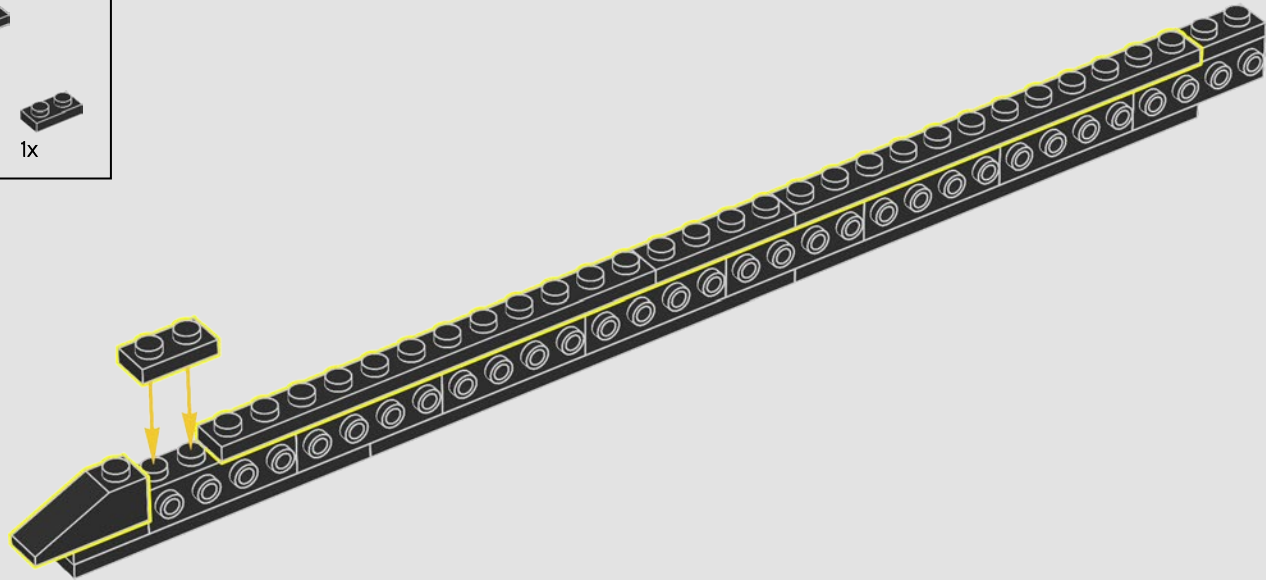

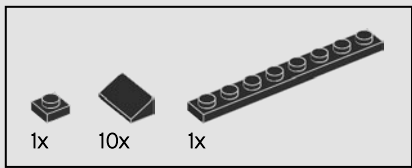

389

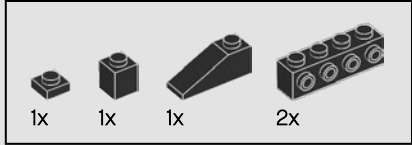
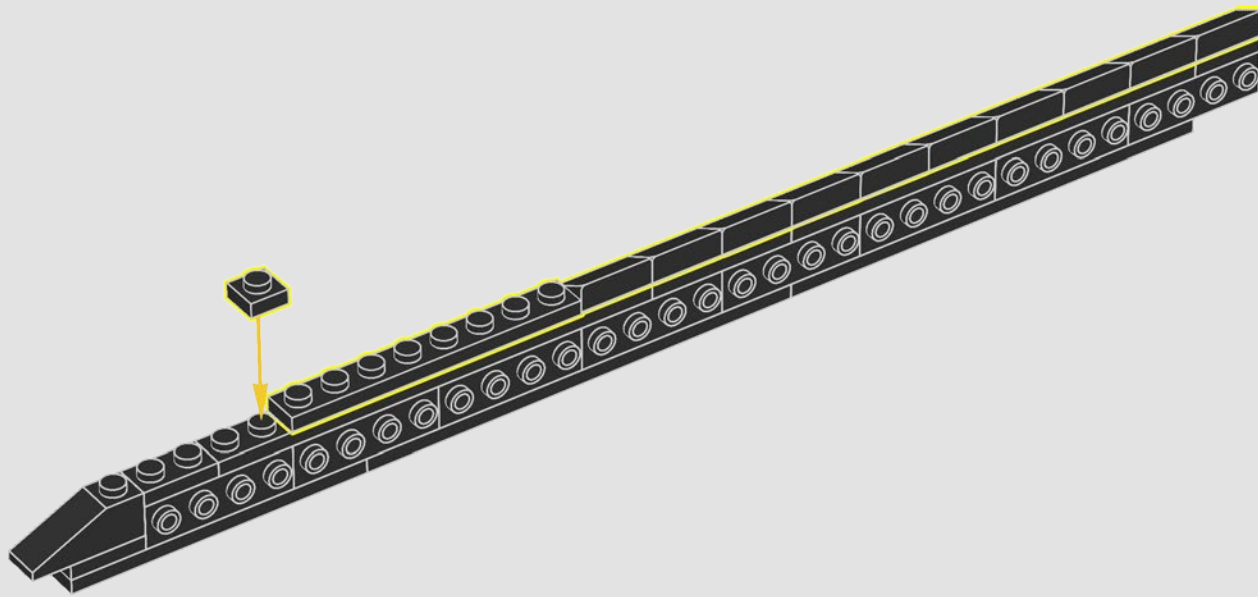

390

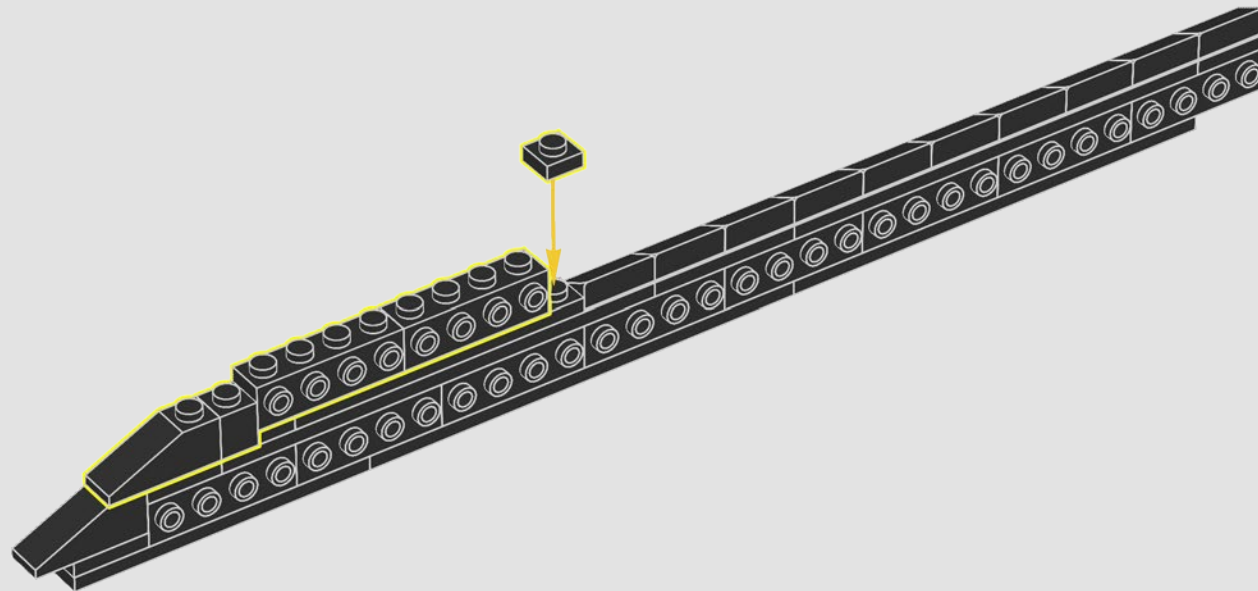





391

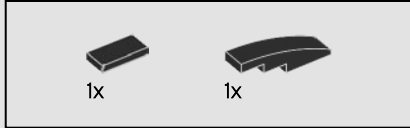
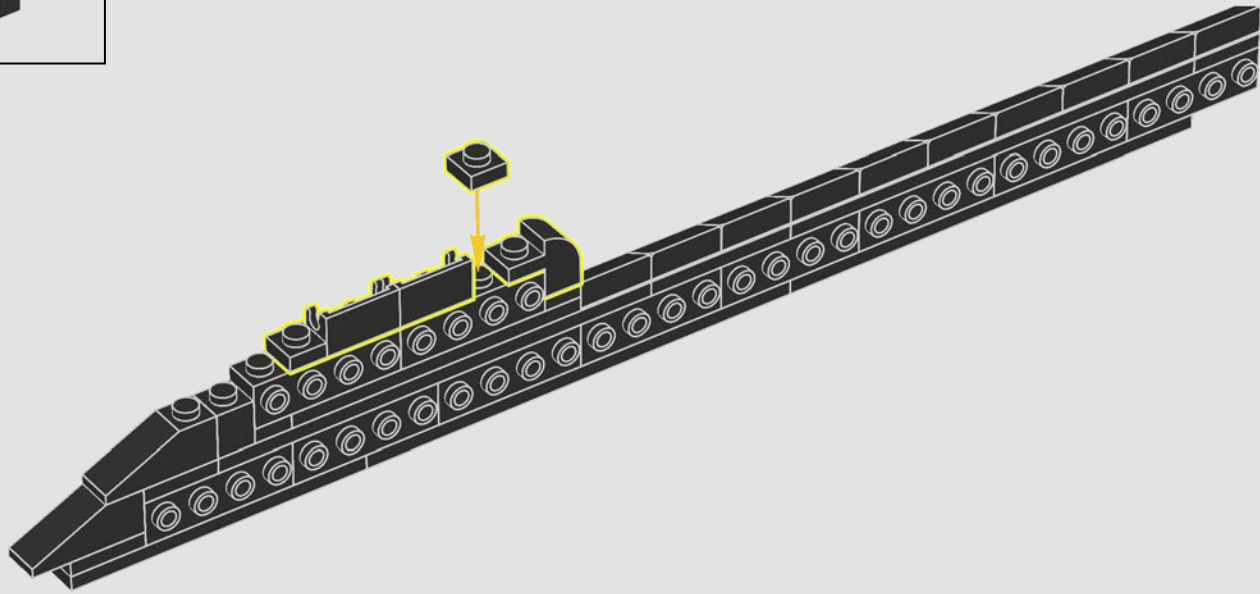

392

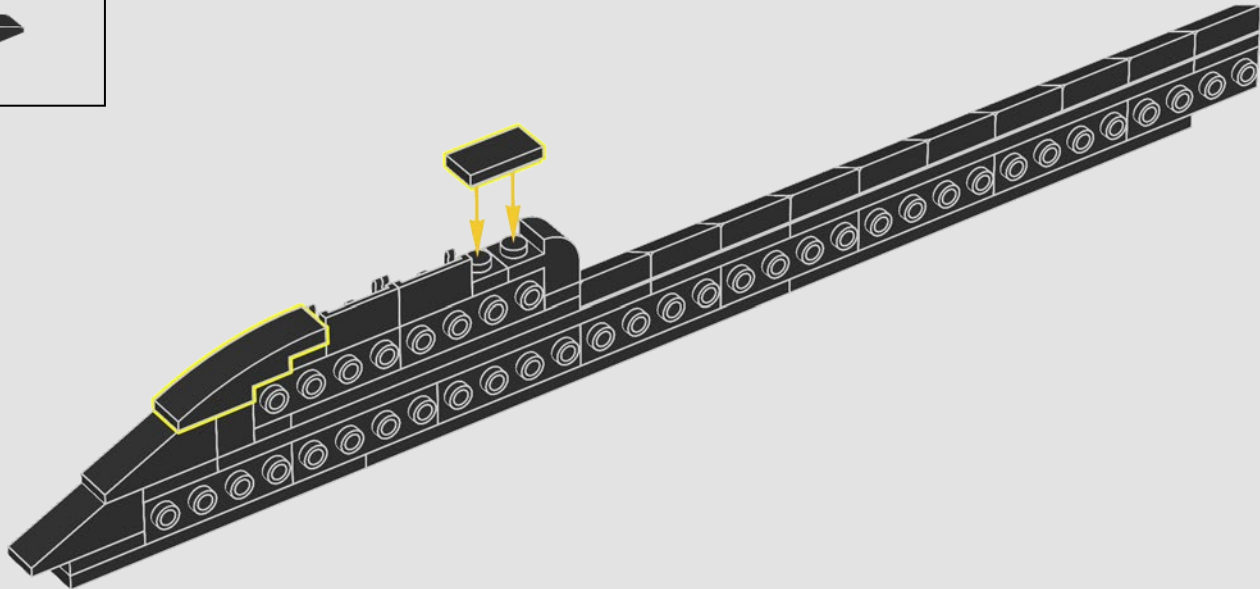

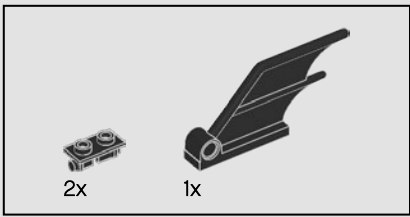

393

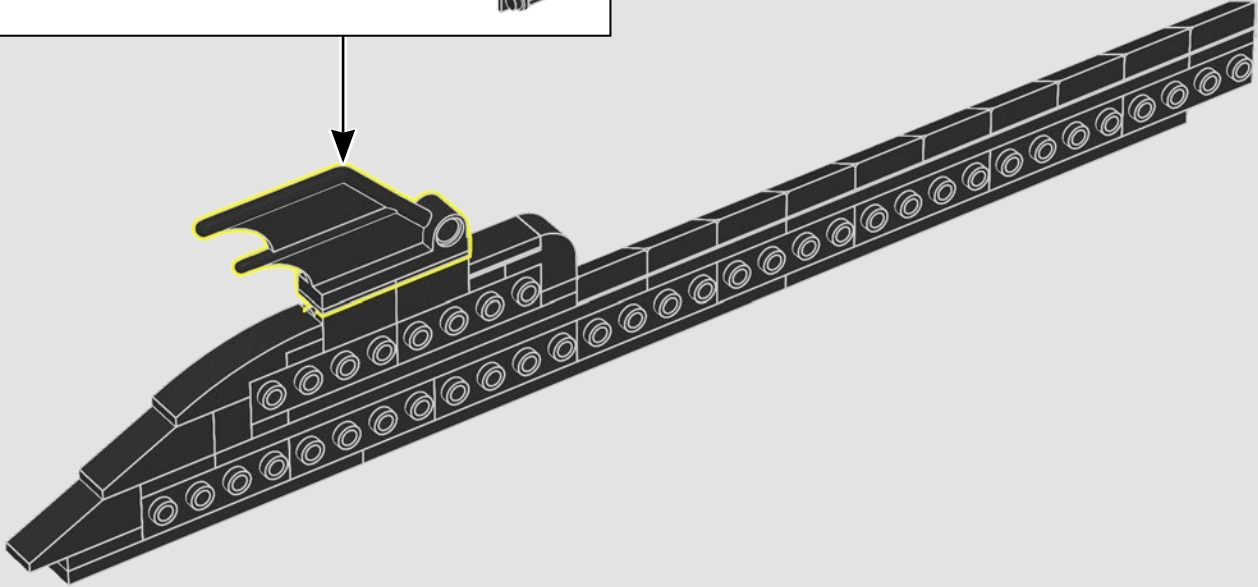
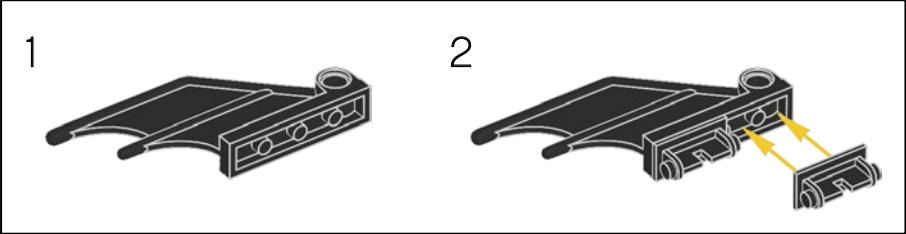

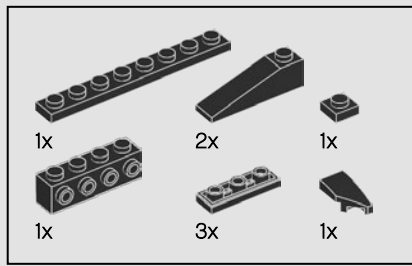

394

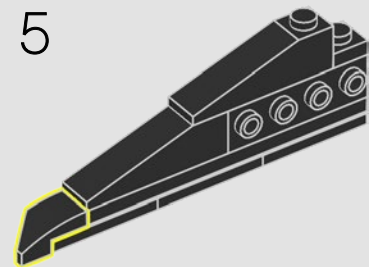
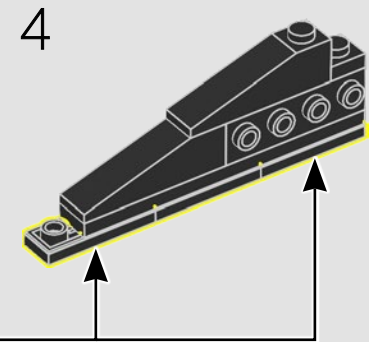
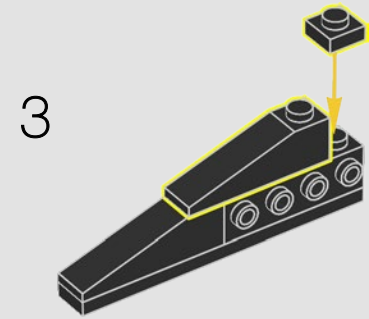
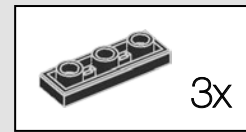
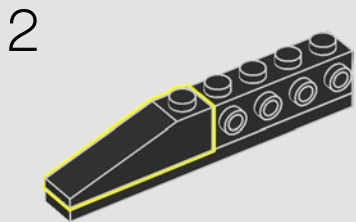
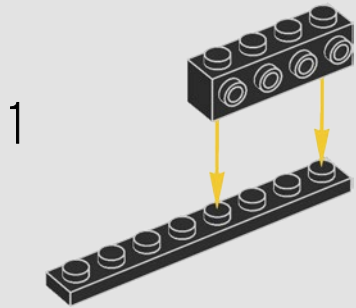

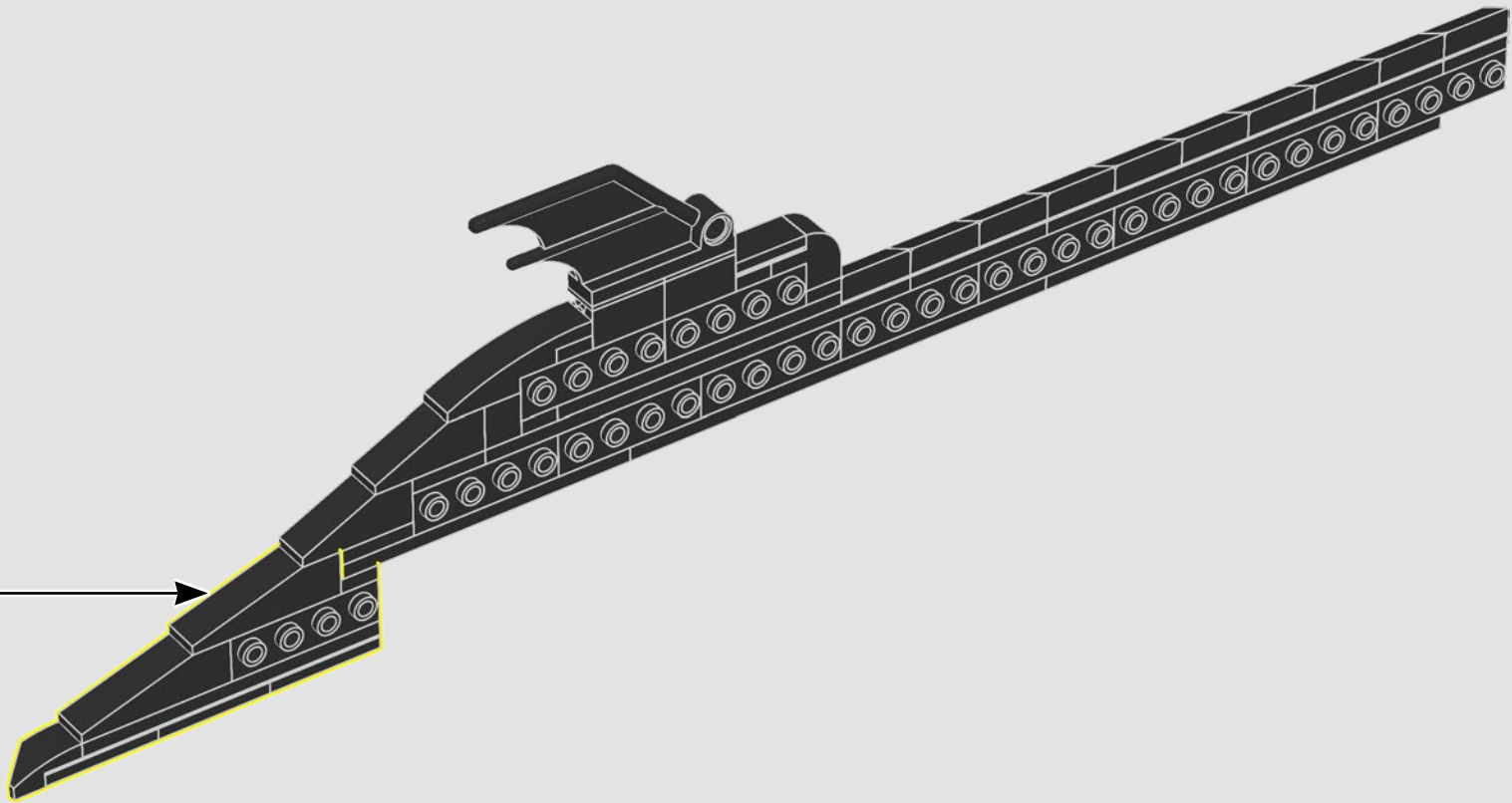

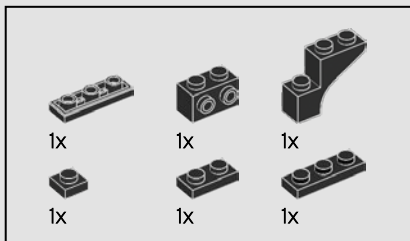

395

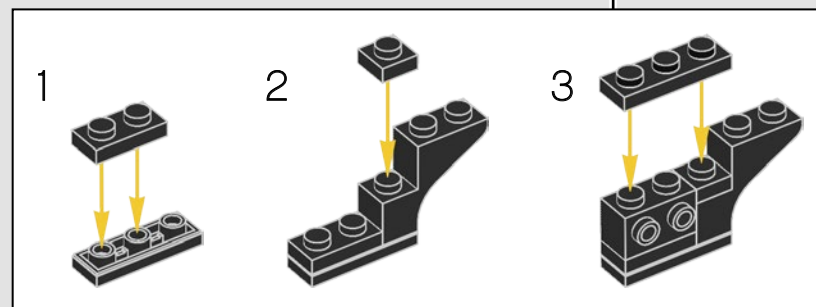
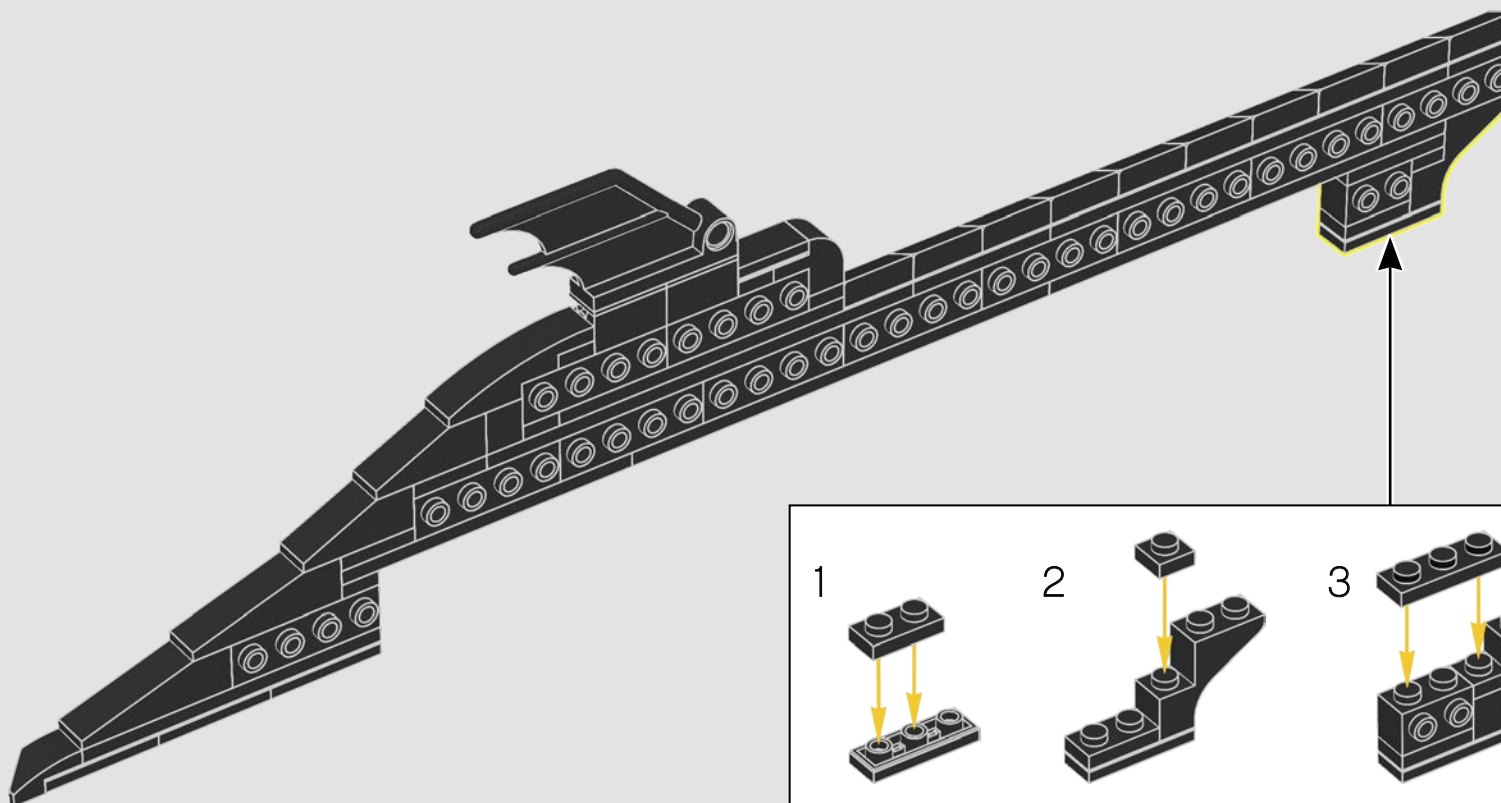

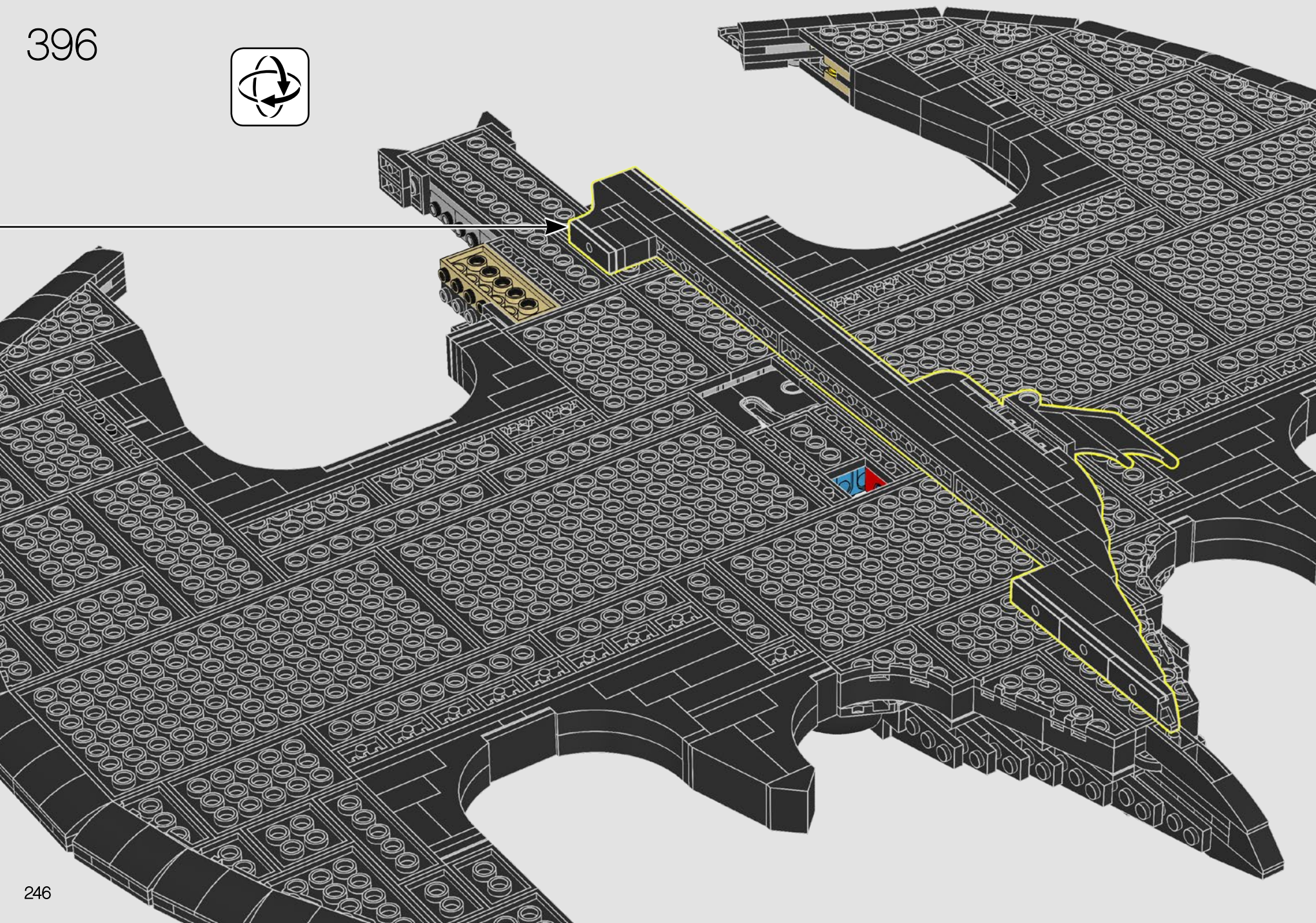

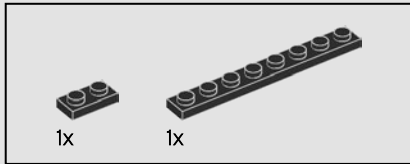
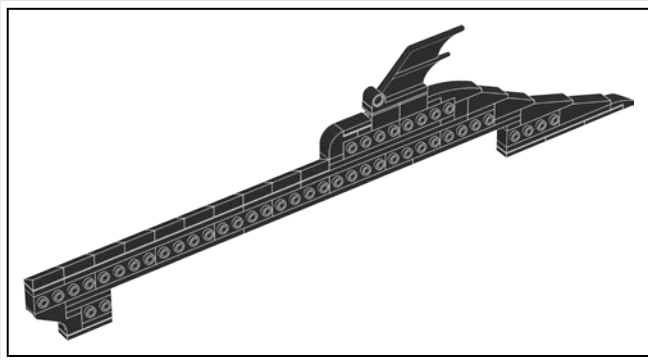

397

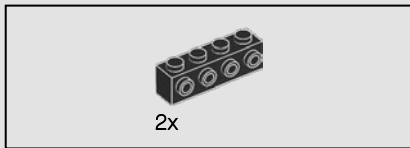
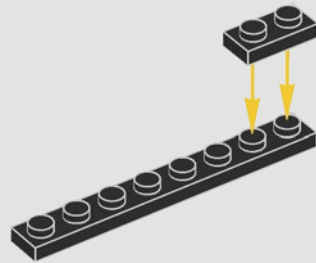

398

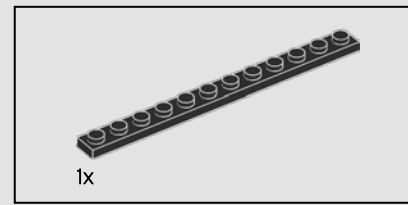
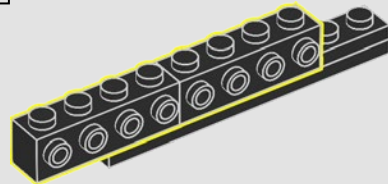

399

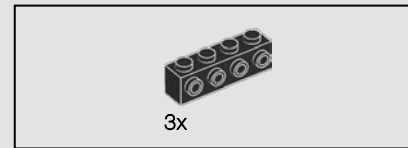
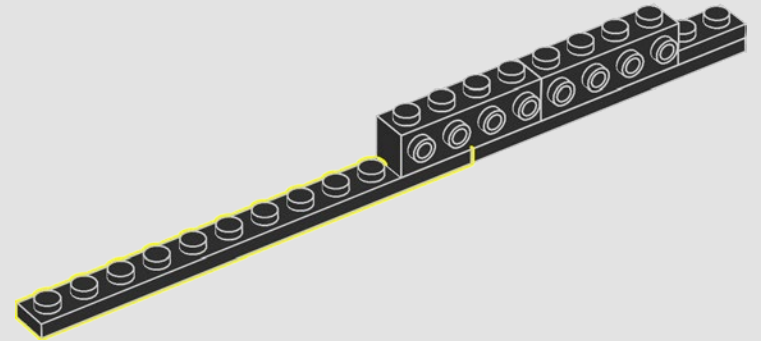

400

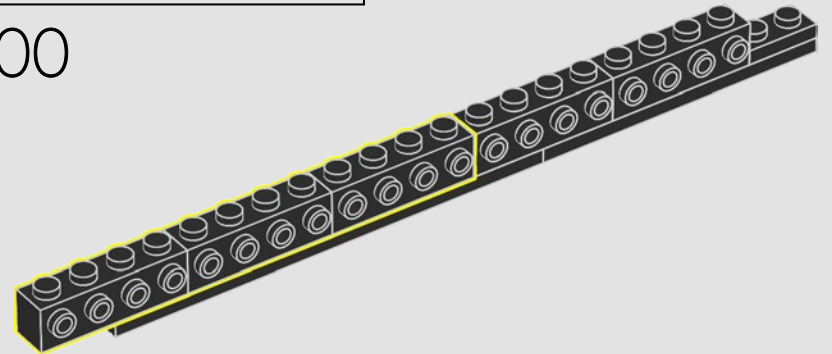

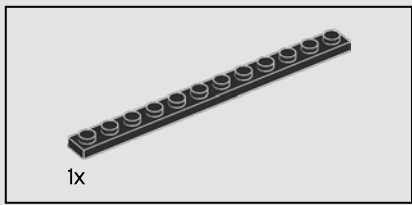

401

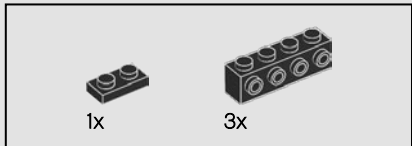
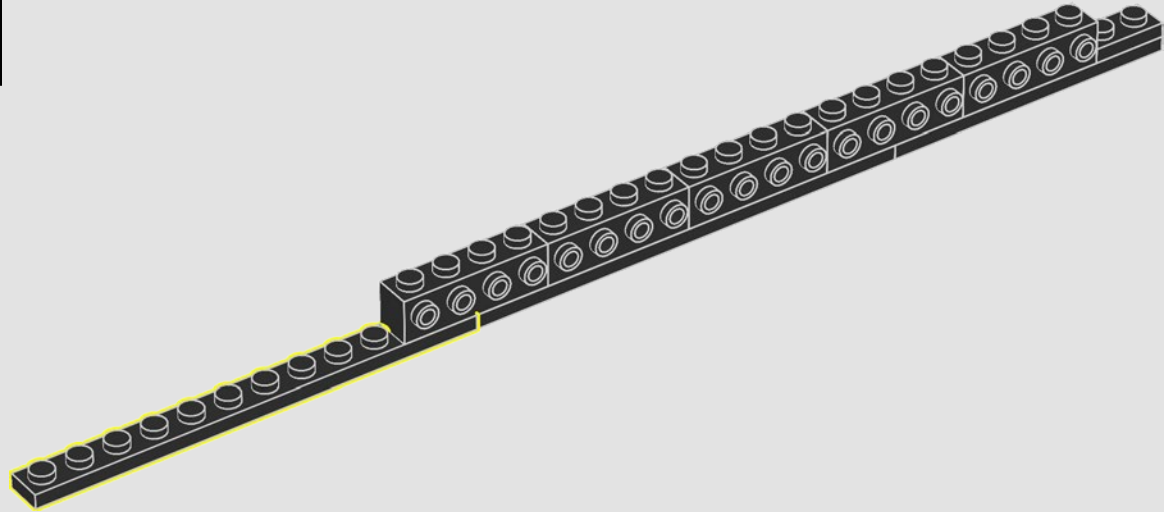

402

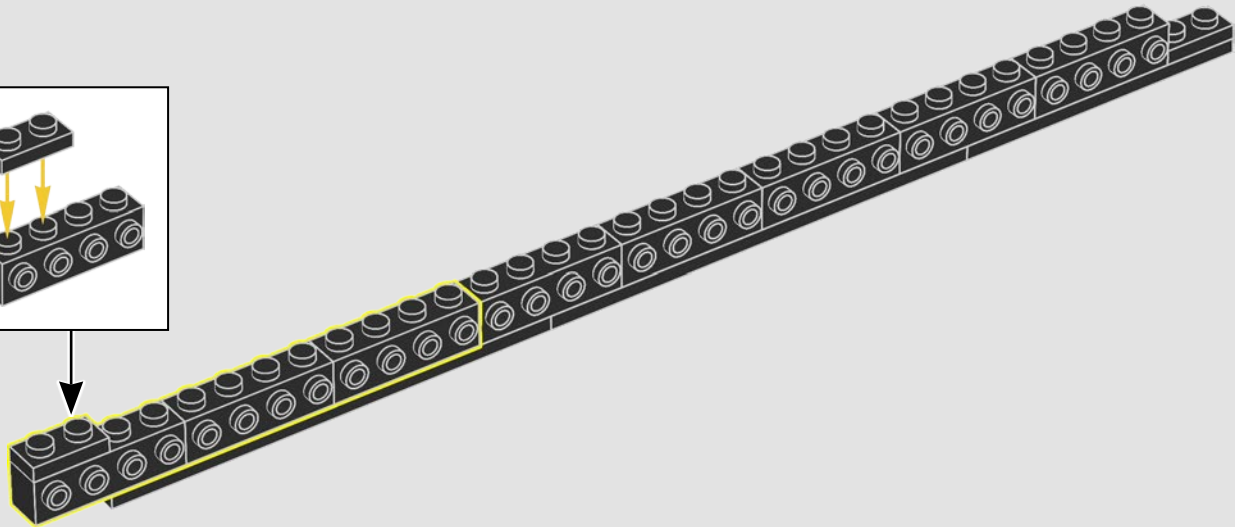
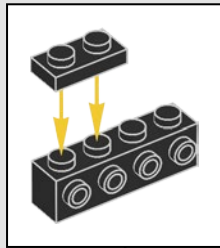



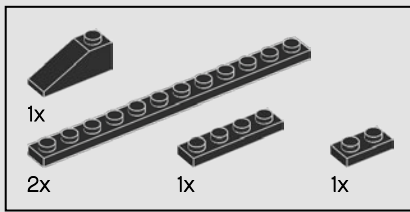

403

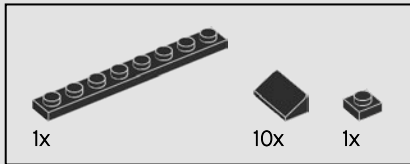
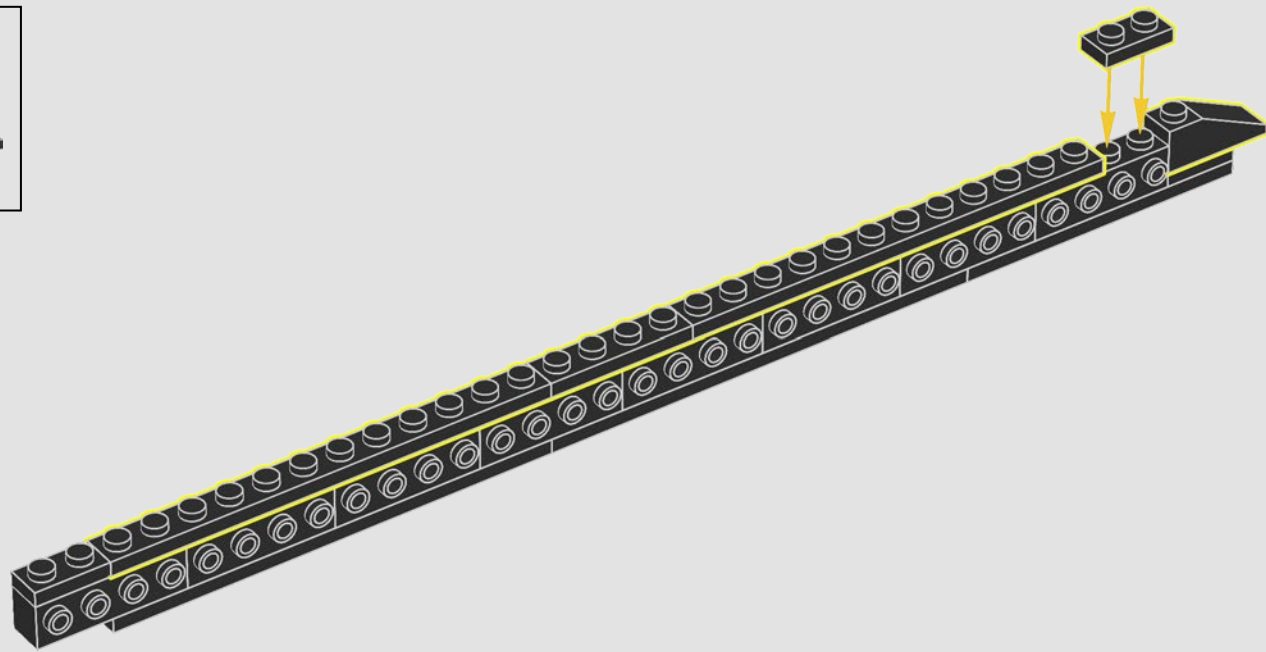

404

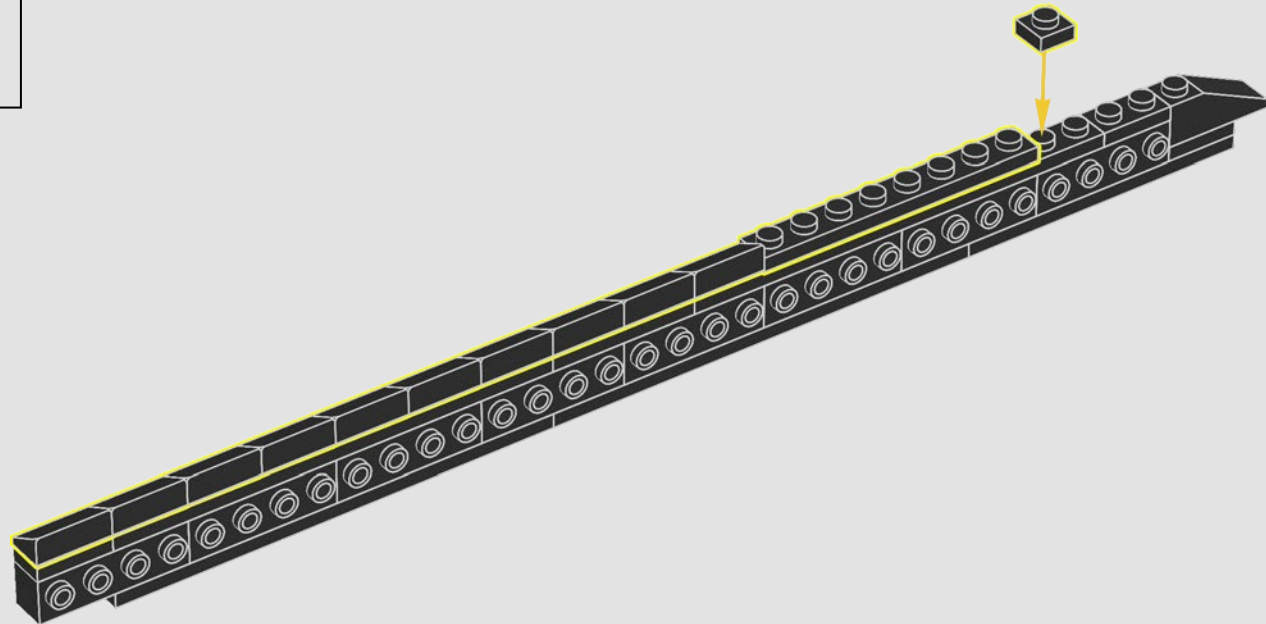

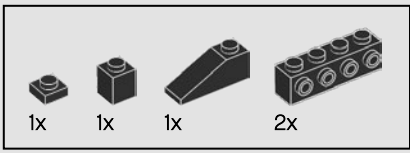

405

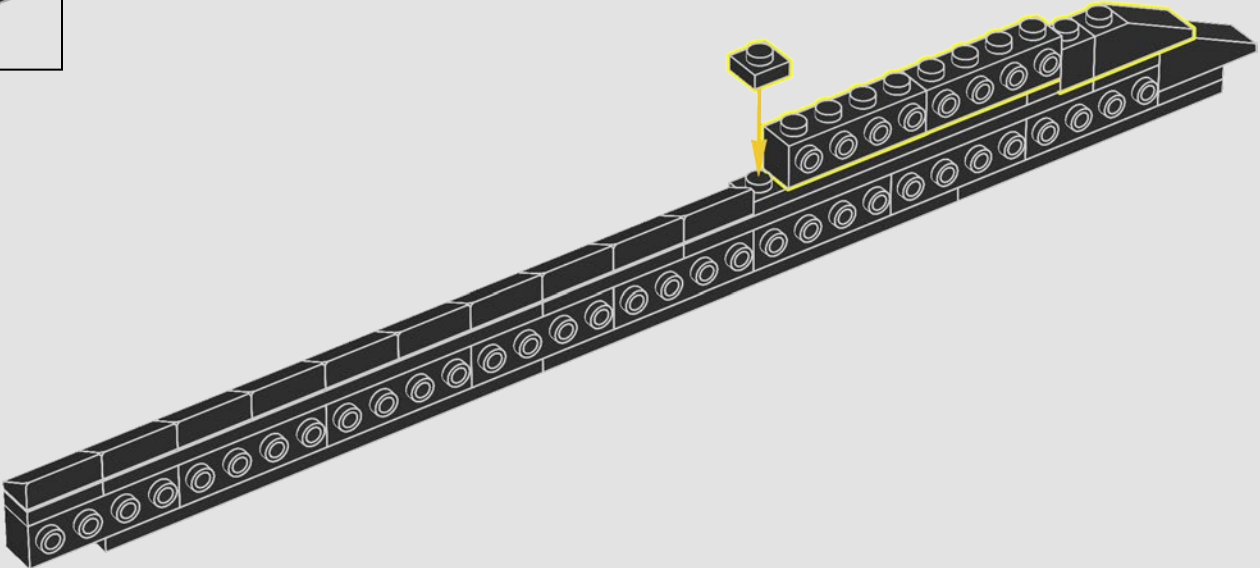

406

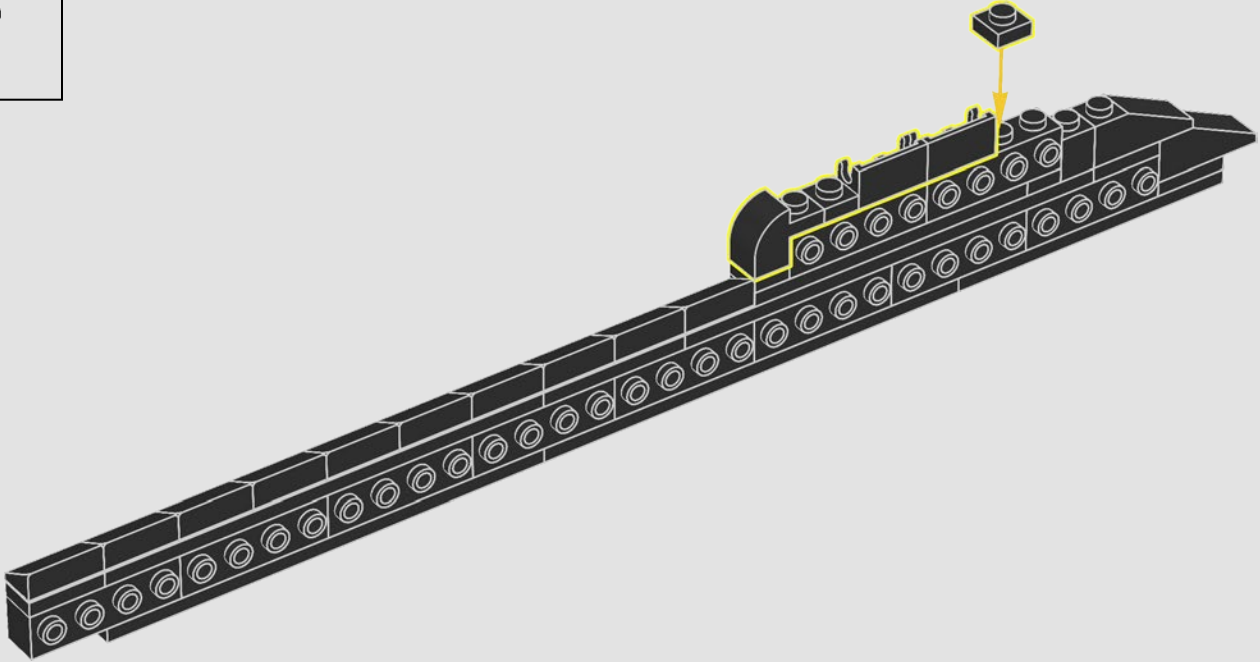

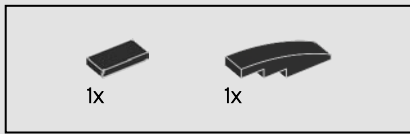

407

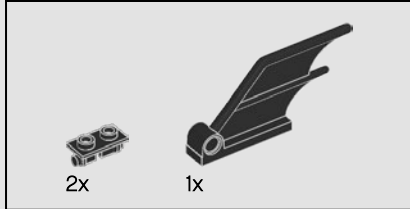
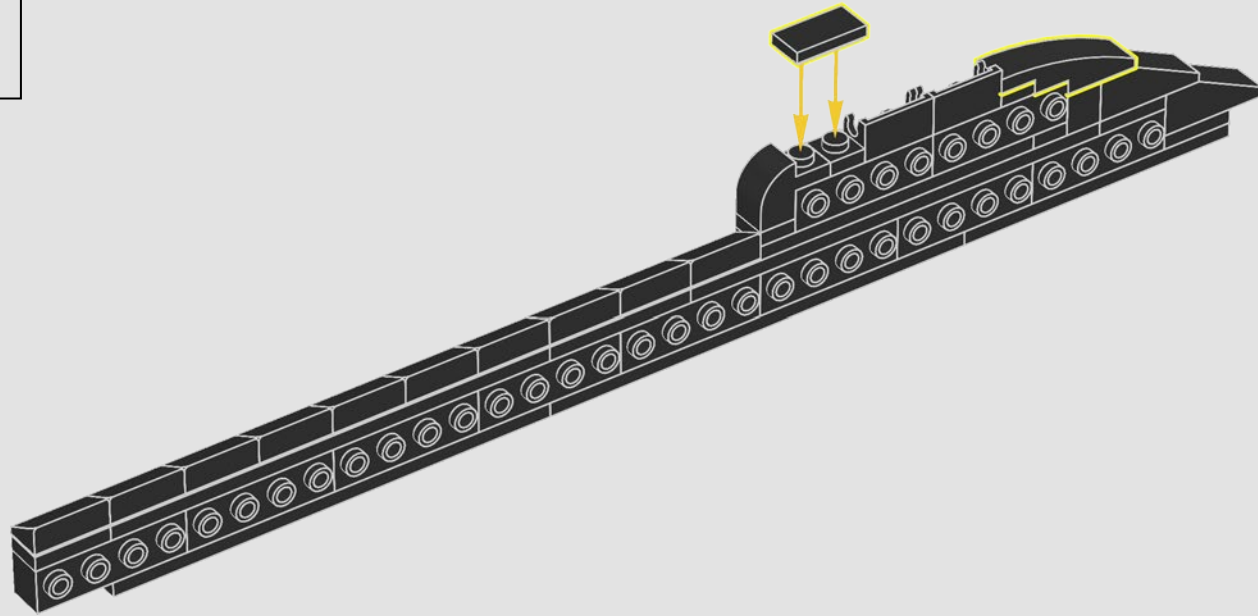

408

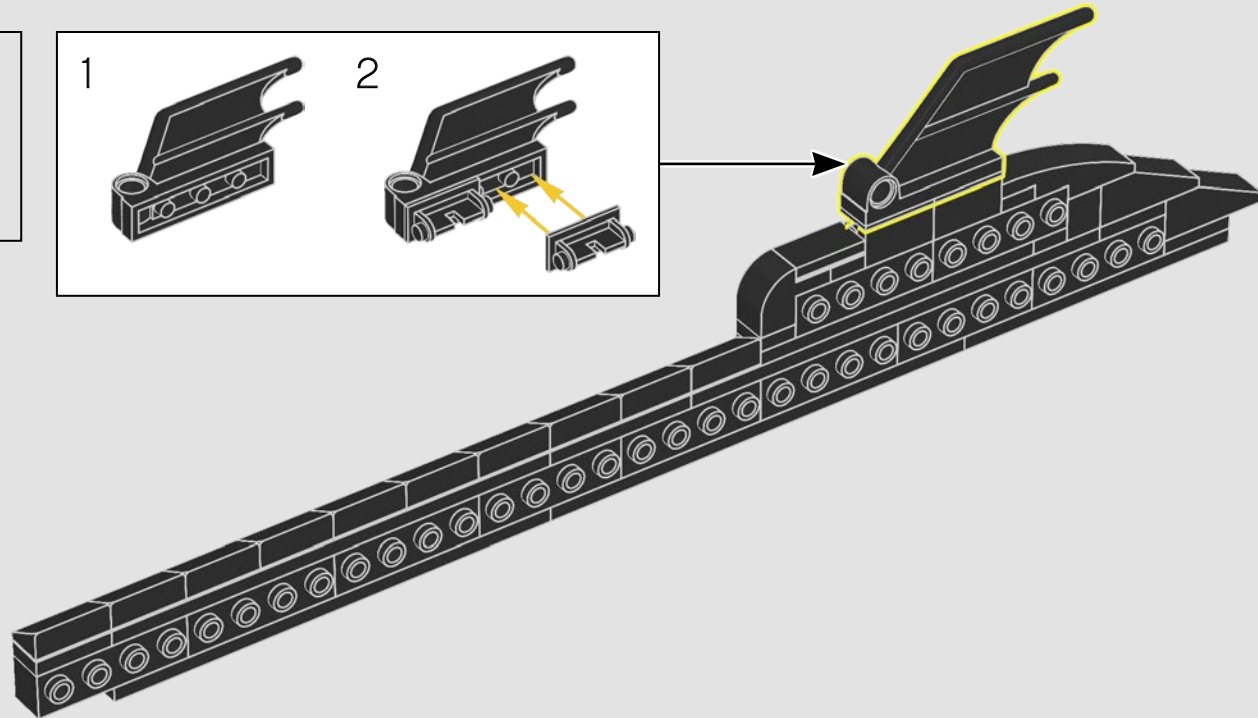
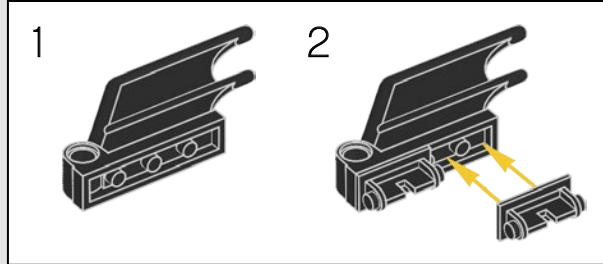

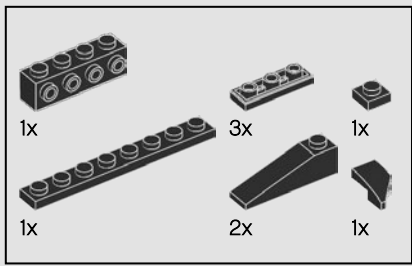

409

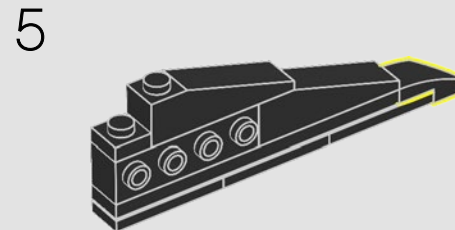
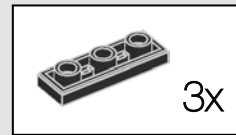
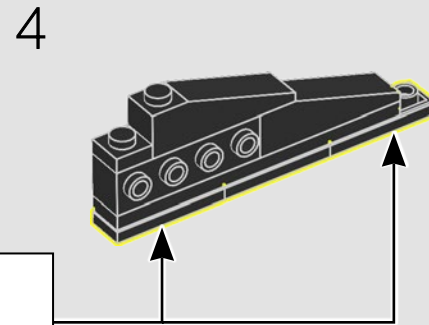
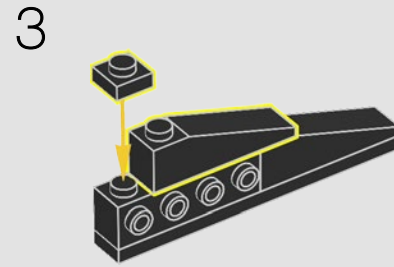
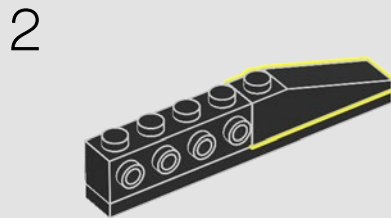
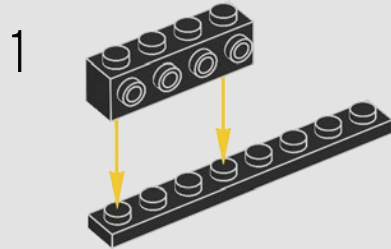

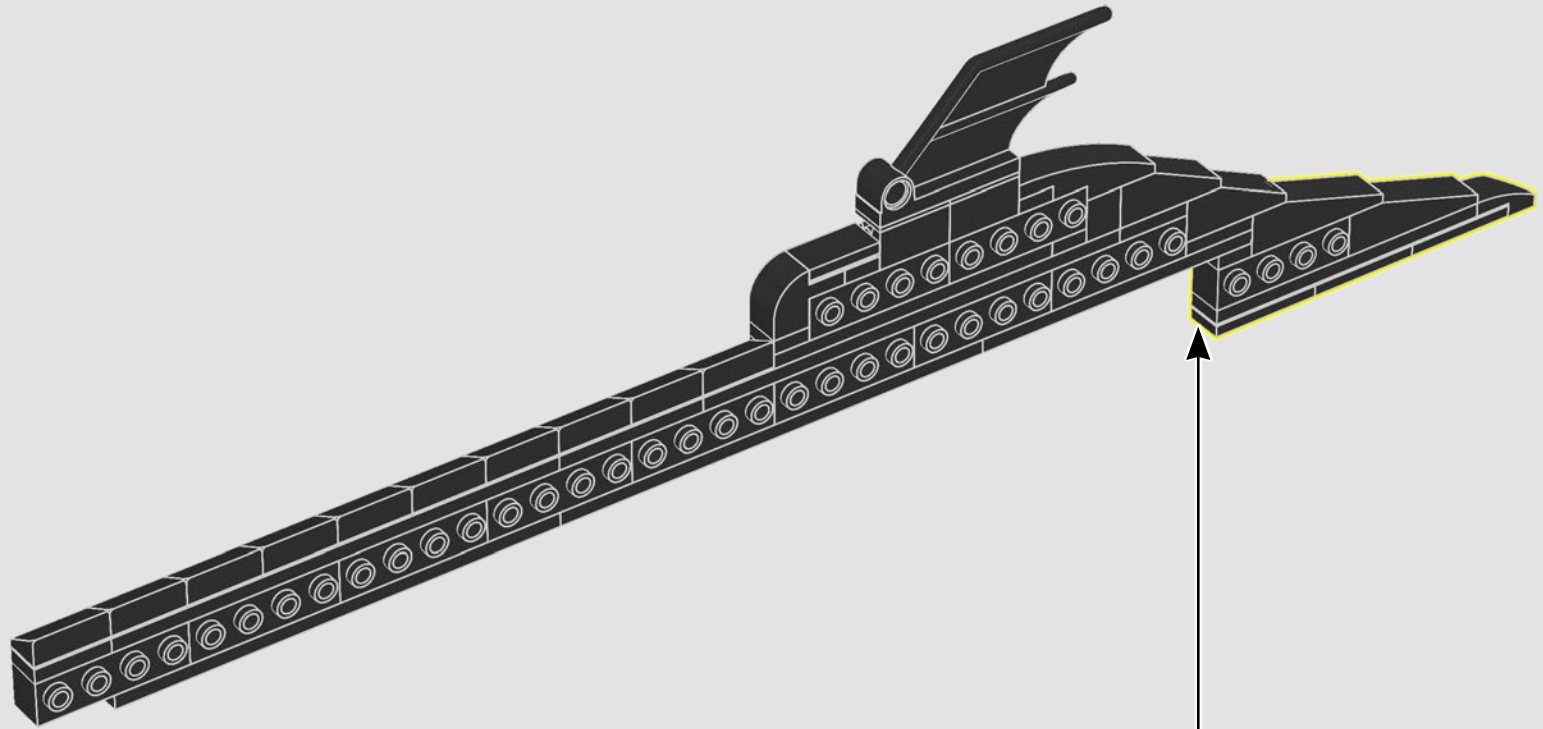

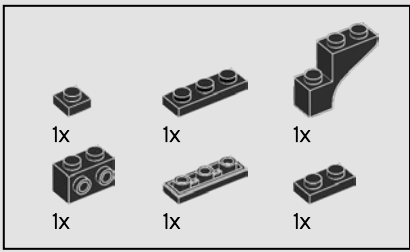

410

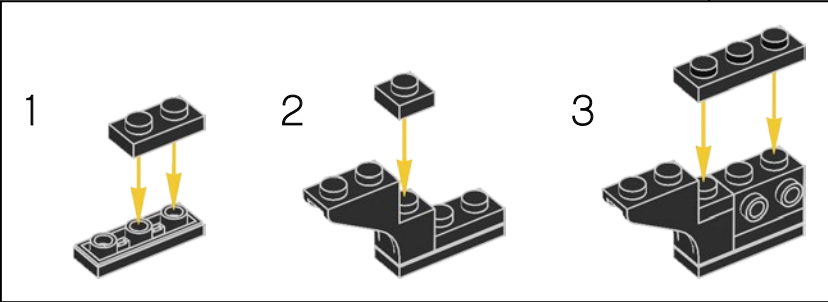
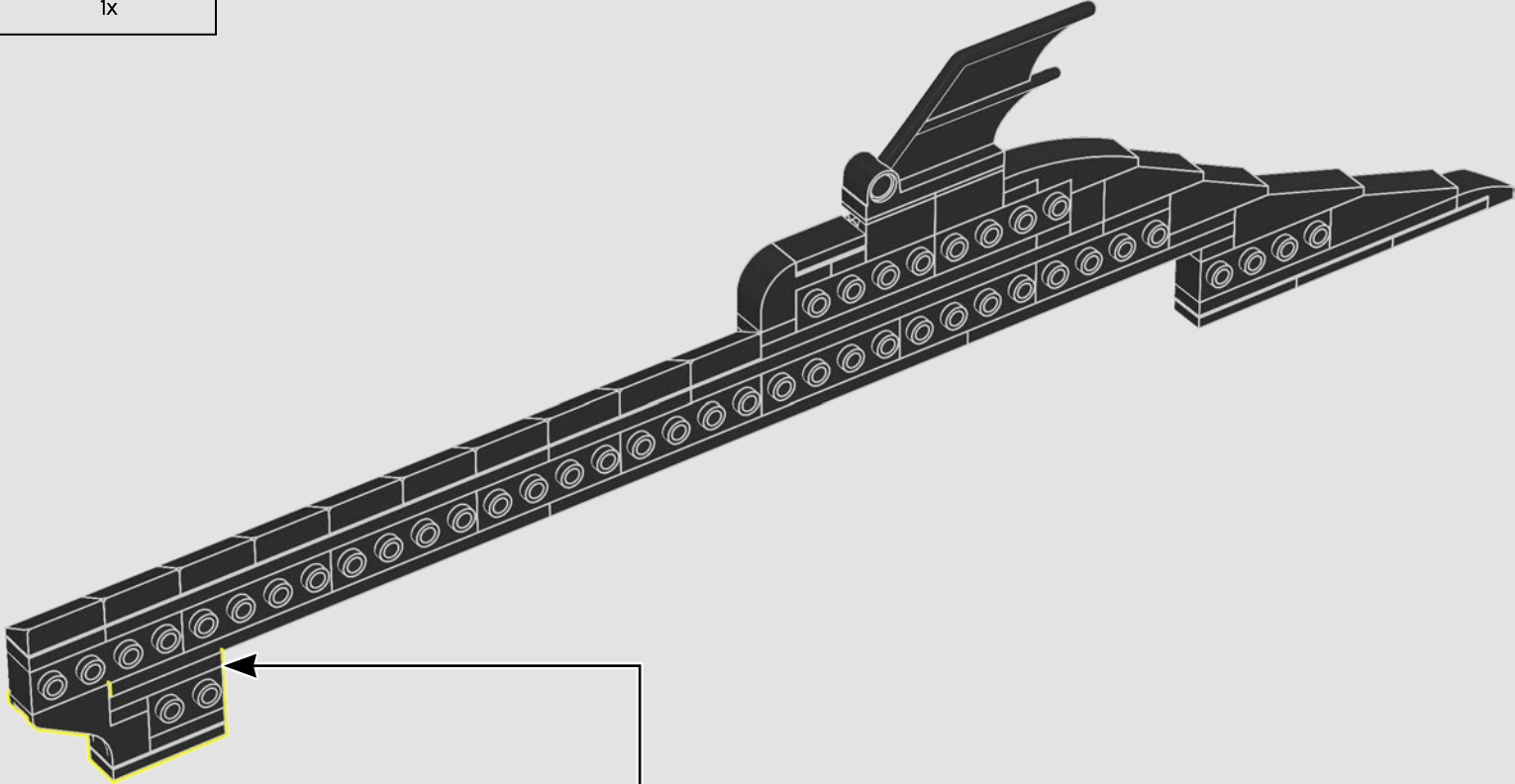

411

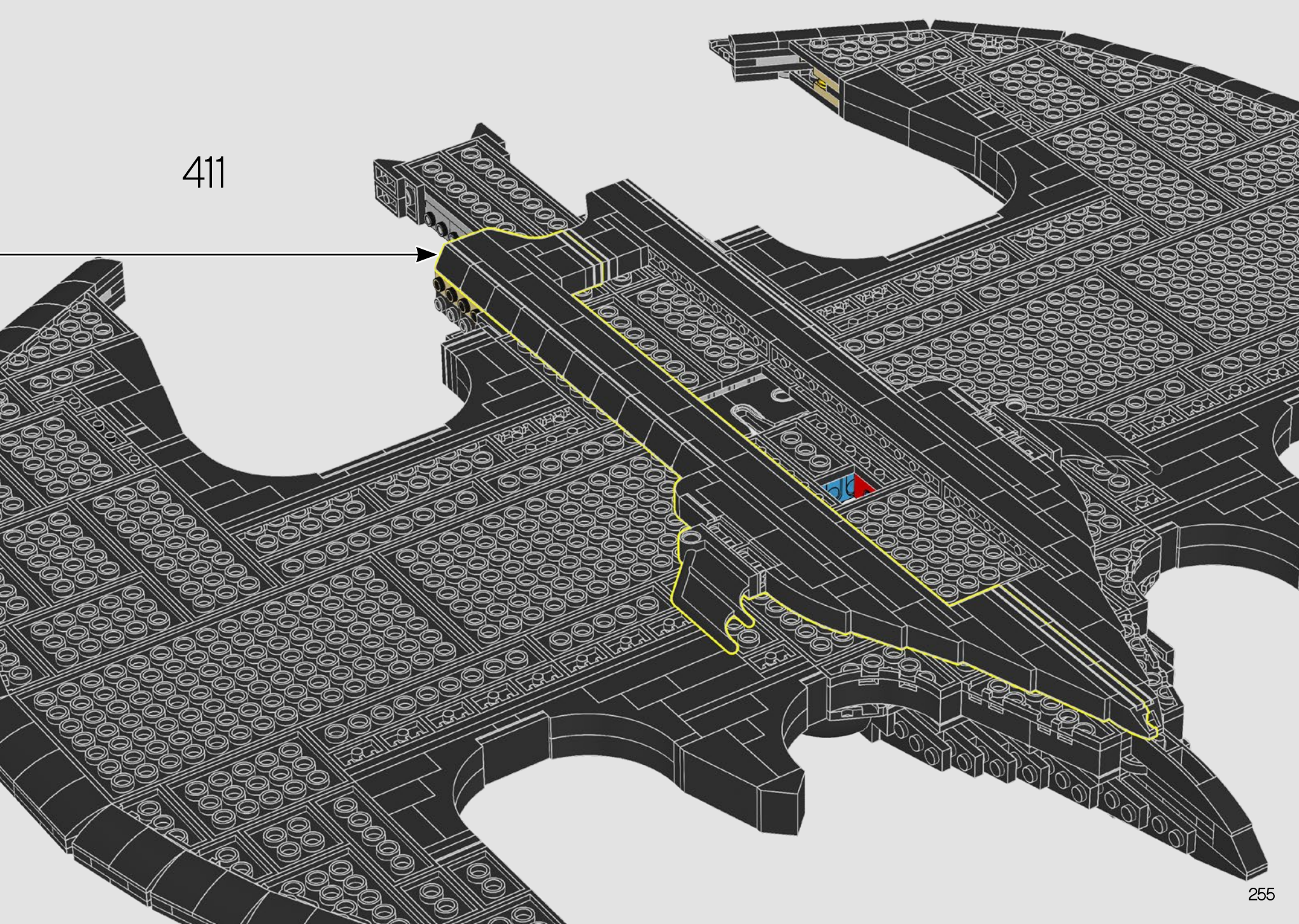

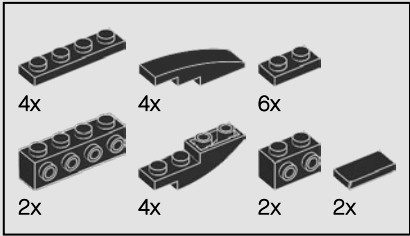
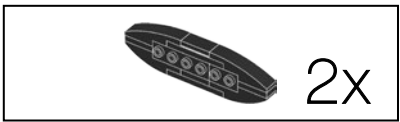

412

1

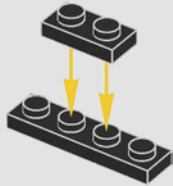

2

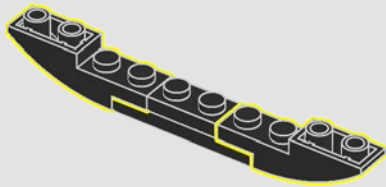

3

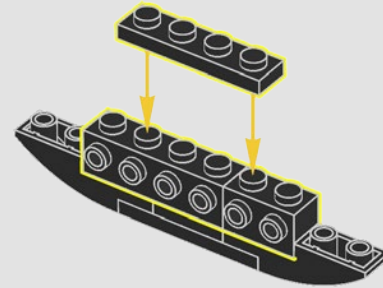

4

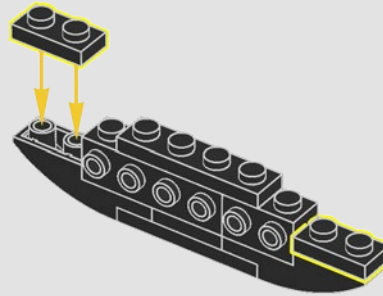

5

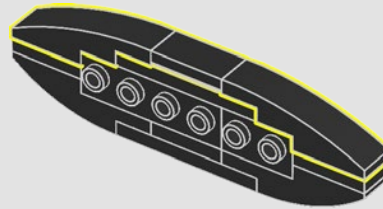

2x



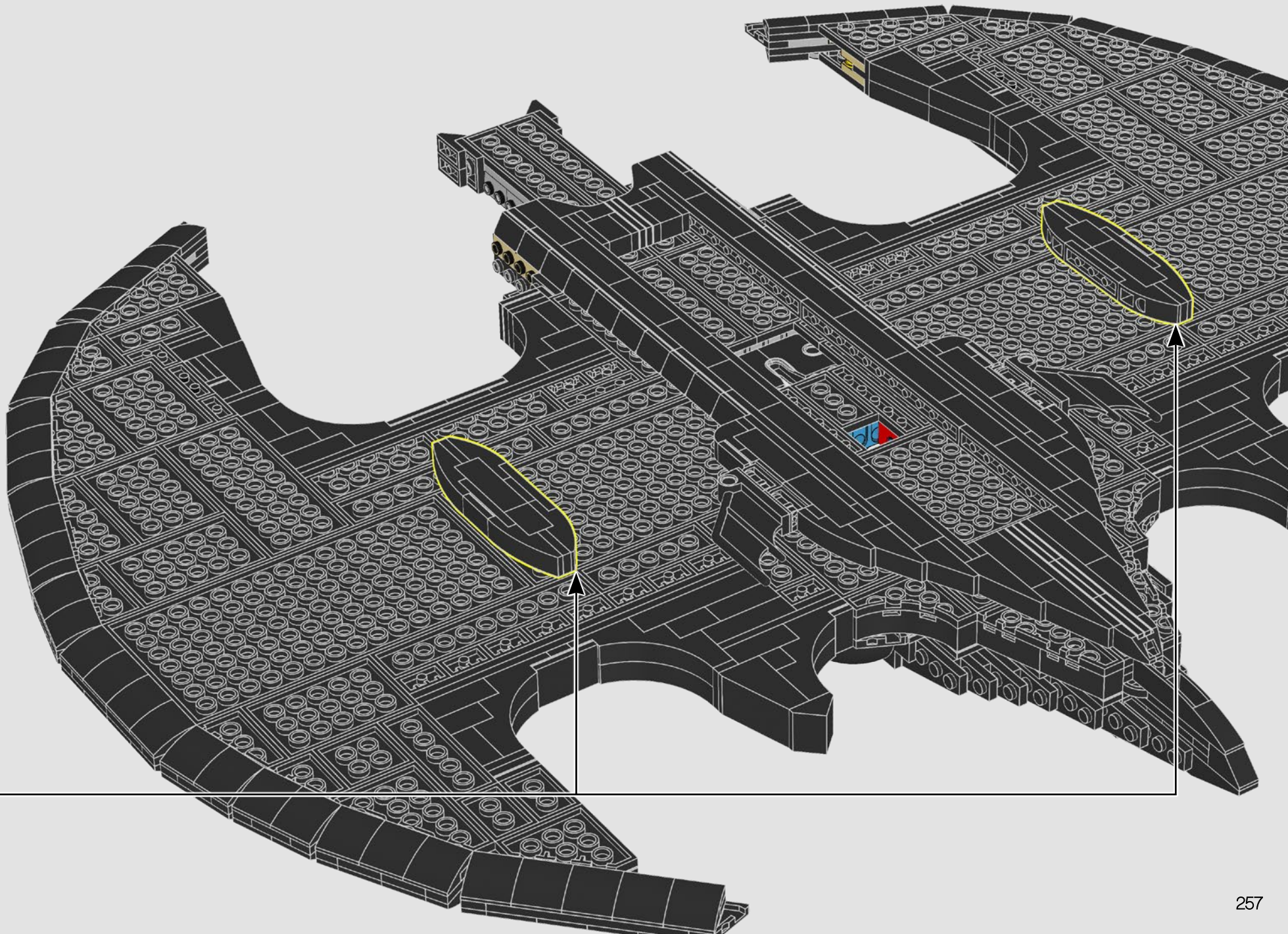

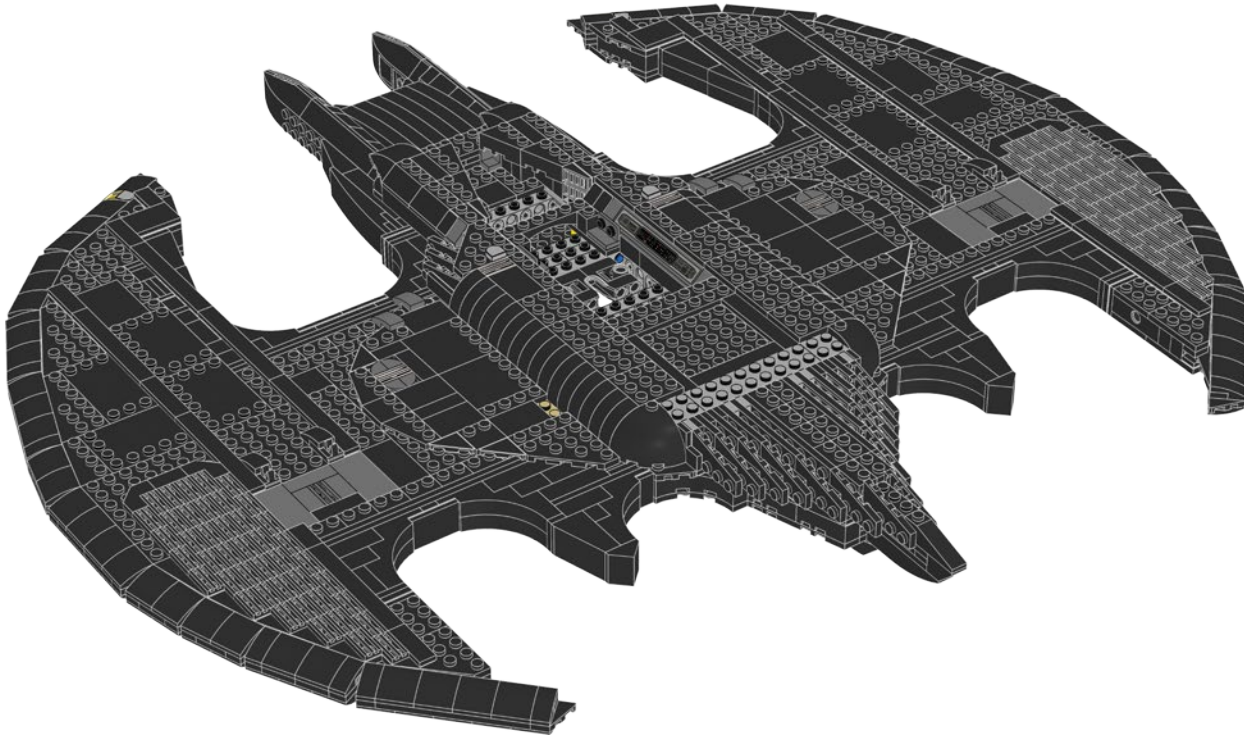
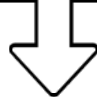

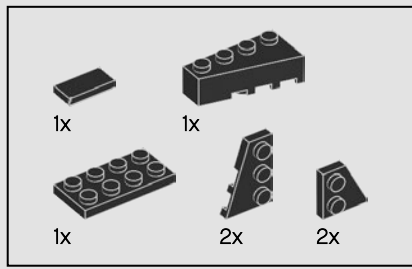

413

1

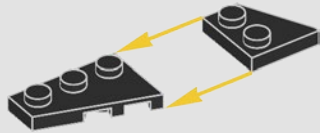

2

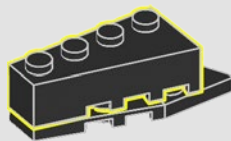

3

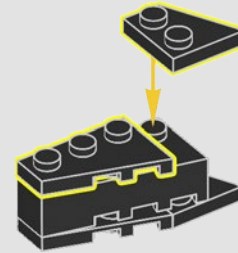

4

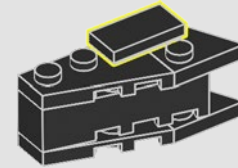

5

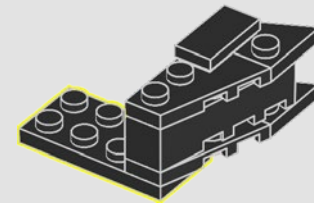

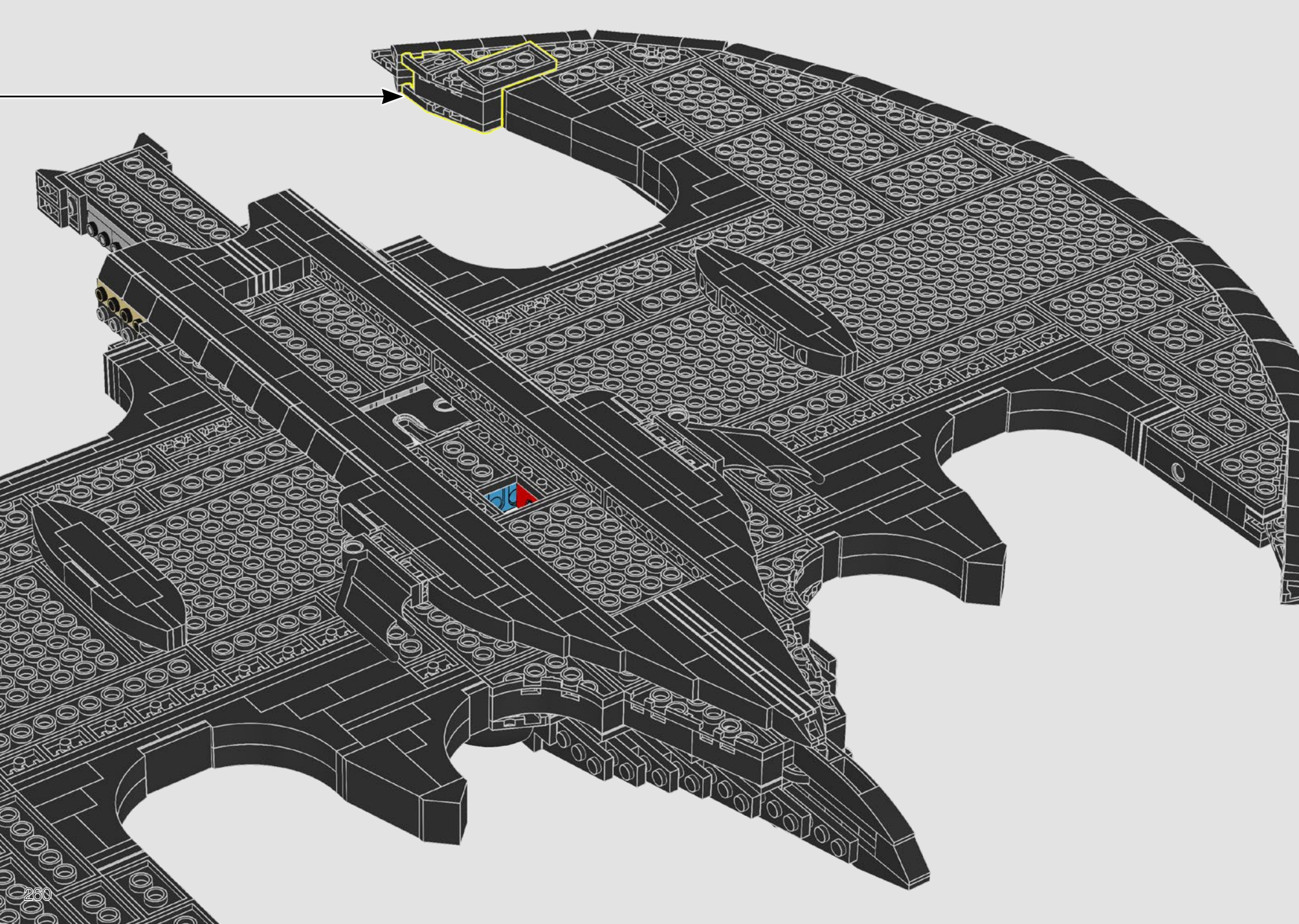

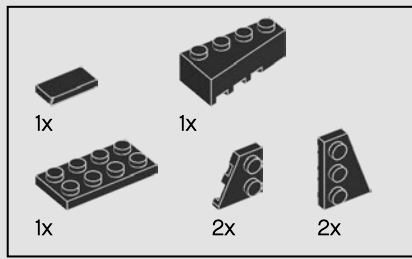

414

1

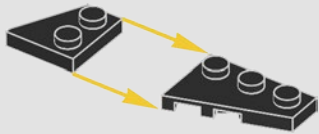

2

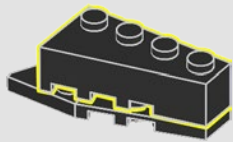

3

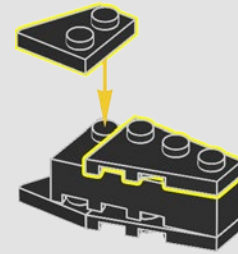

4

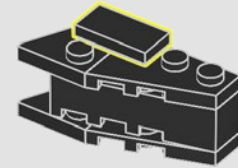

5

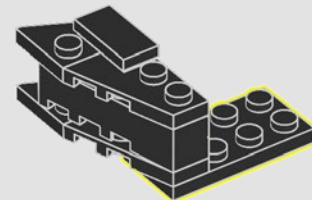

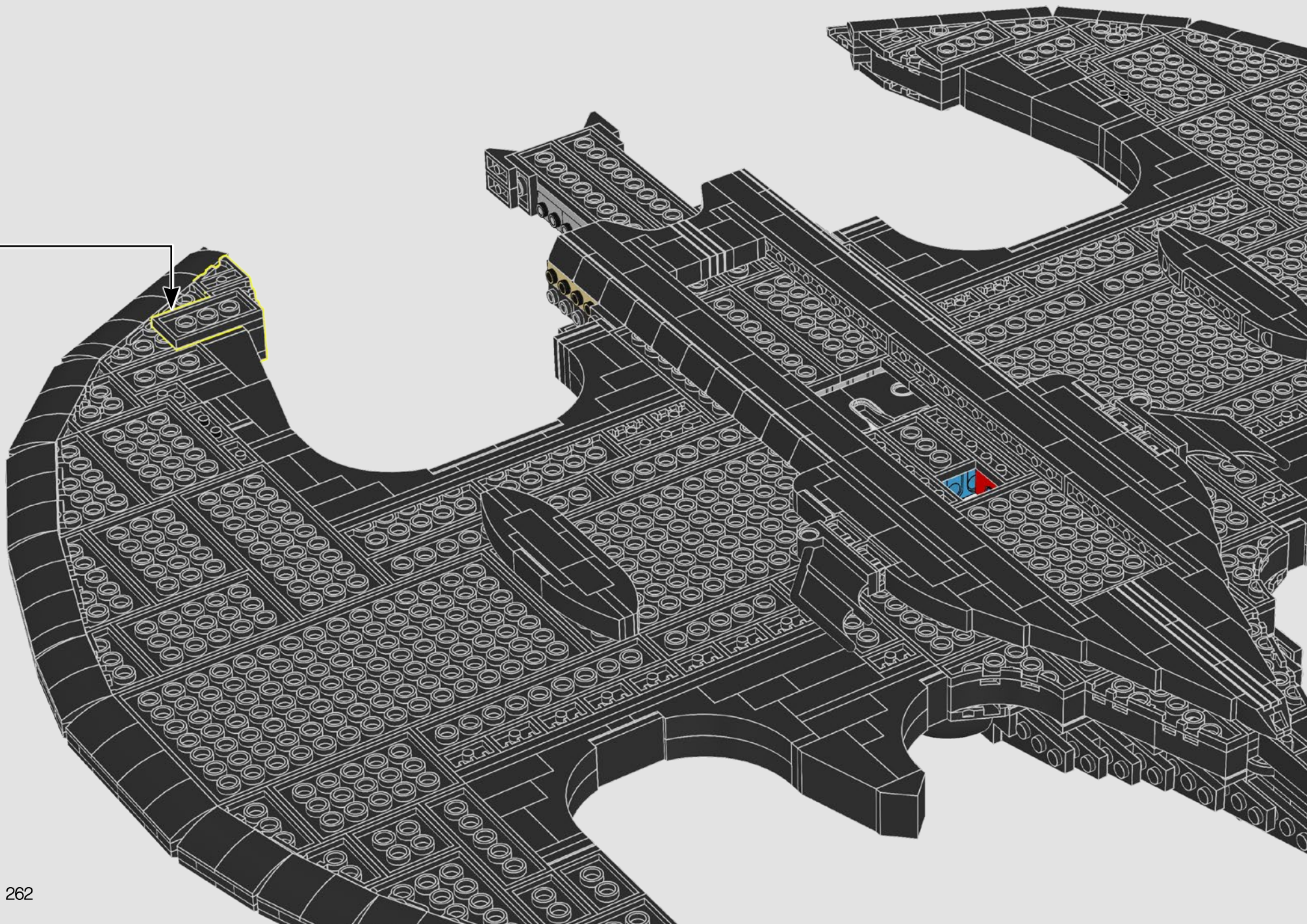



415

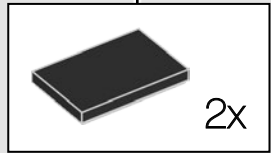

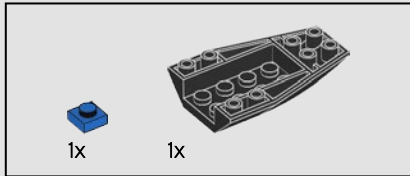
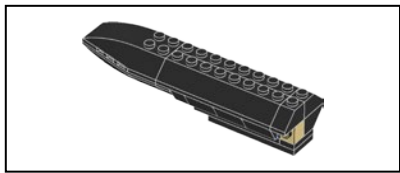

416

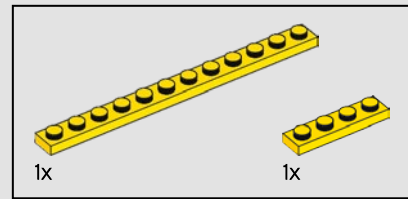
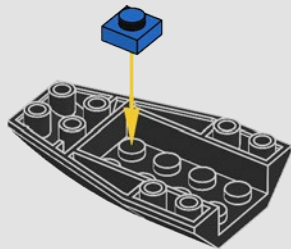

417

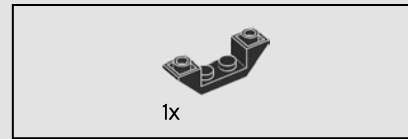
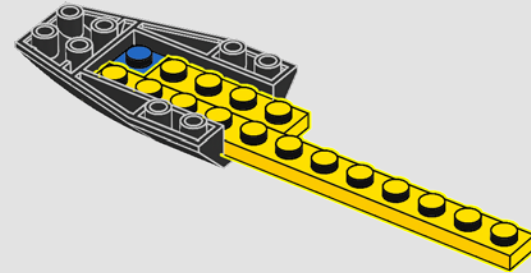

418

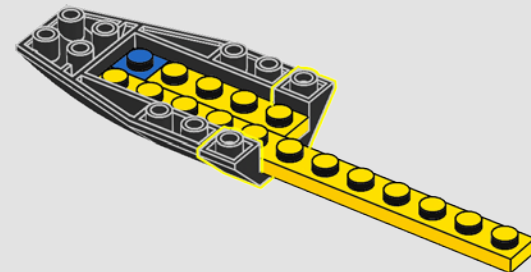



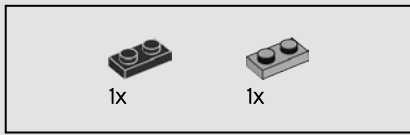

419

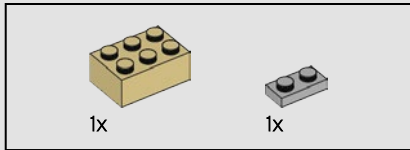
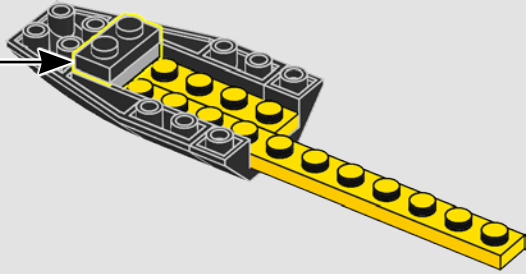
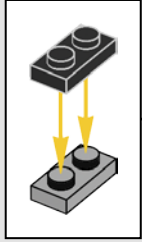

420

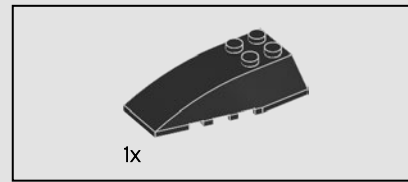
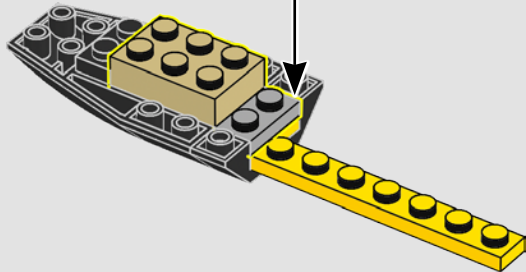
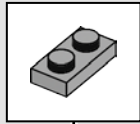

421

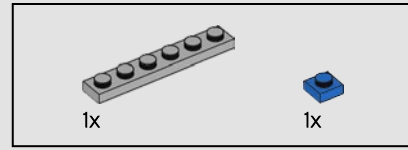
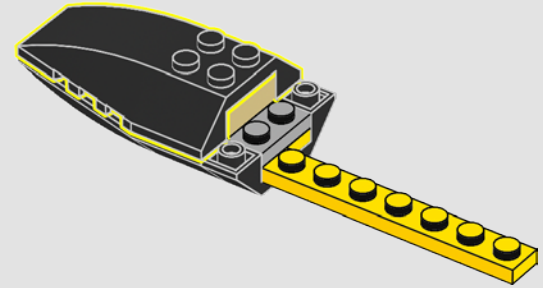

422

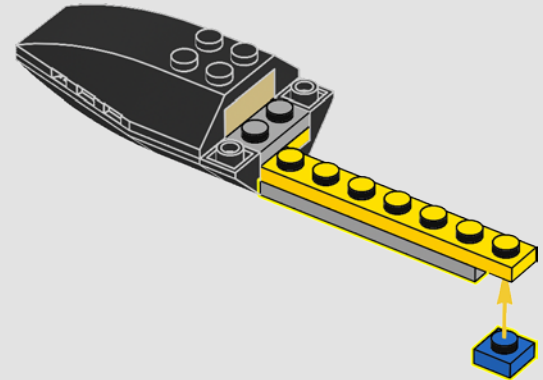

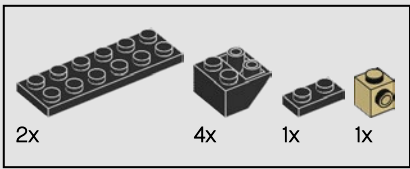

423

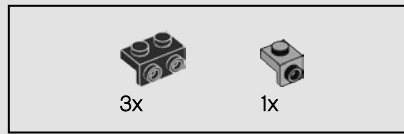
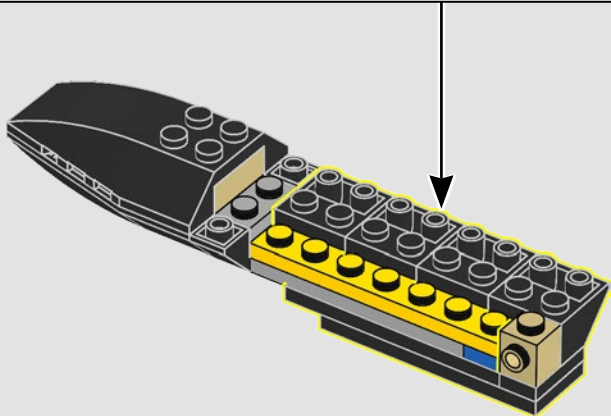
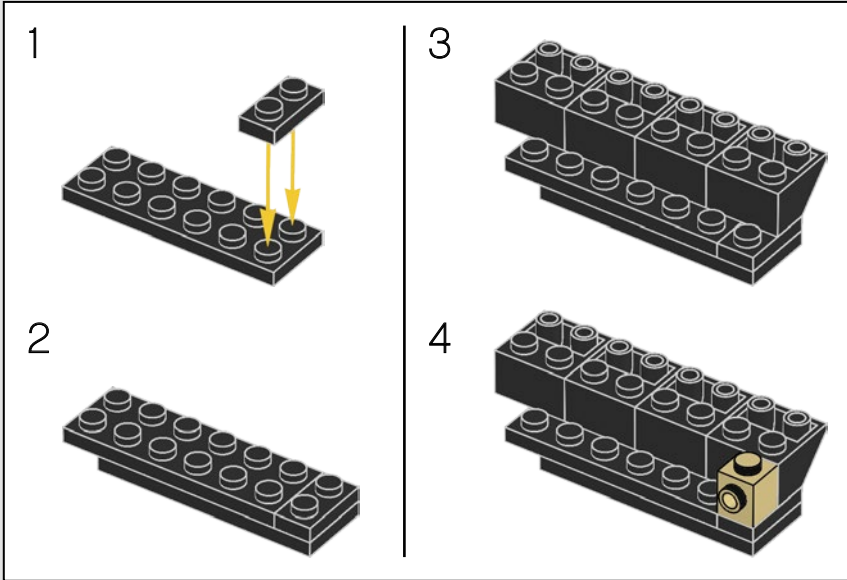

424

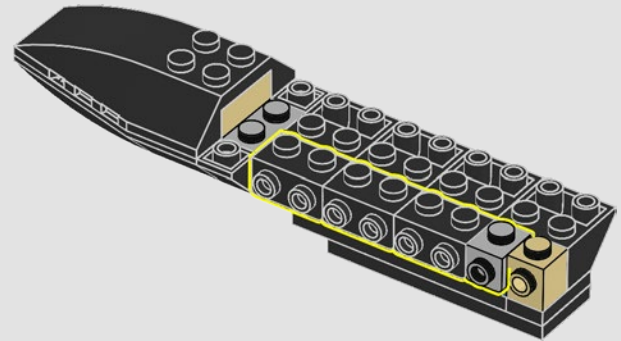

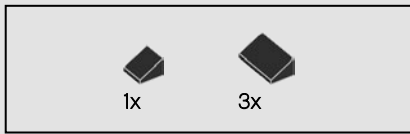

425

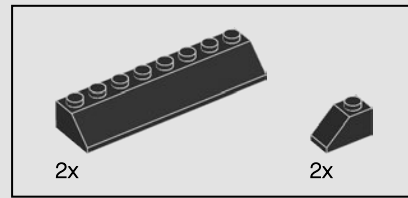
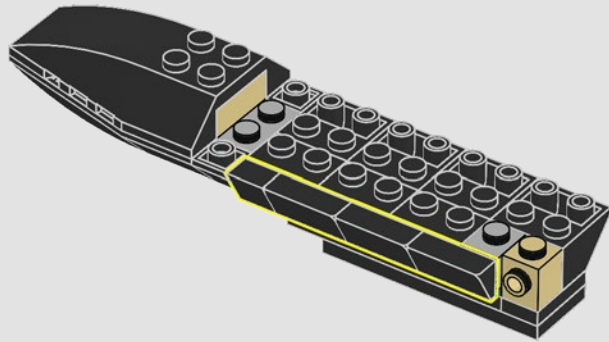

426

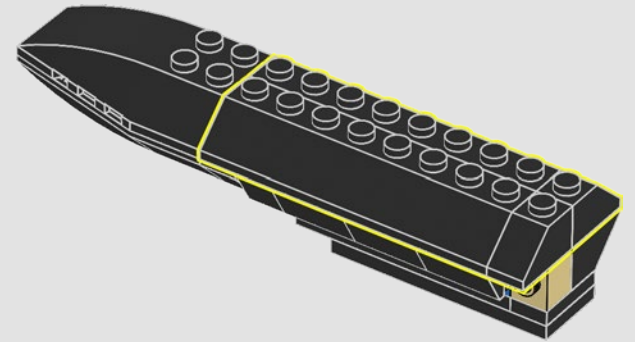

427

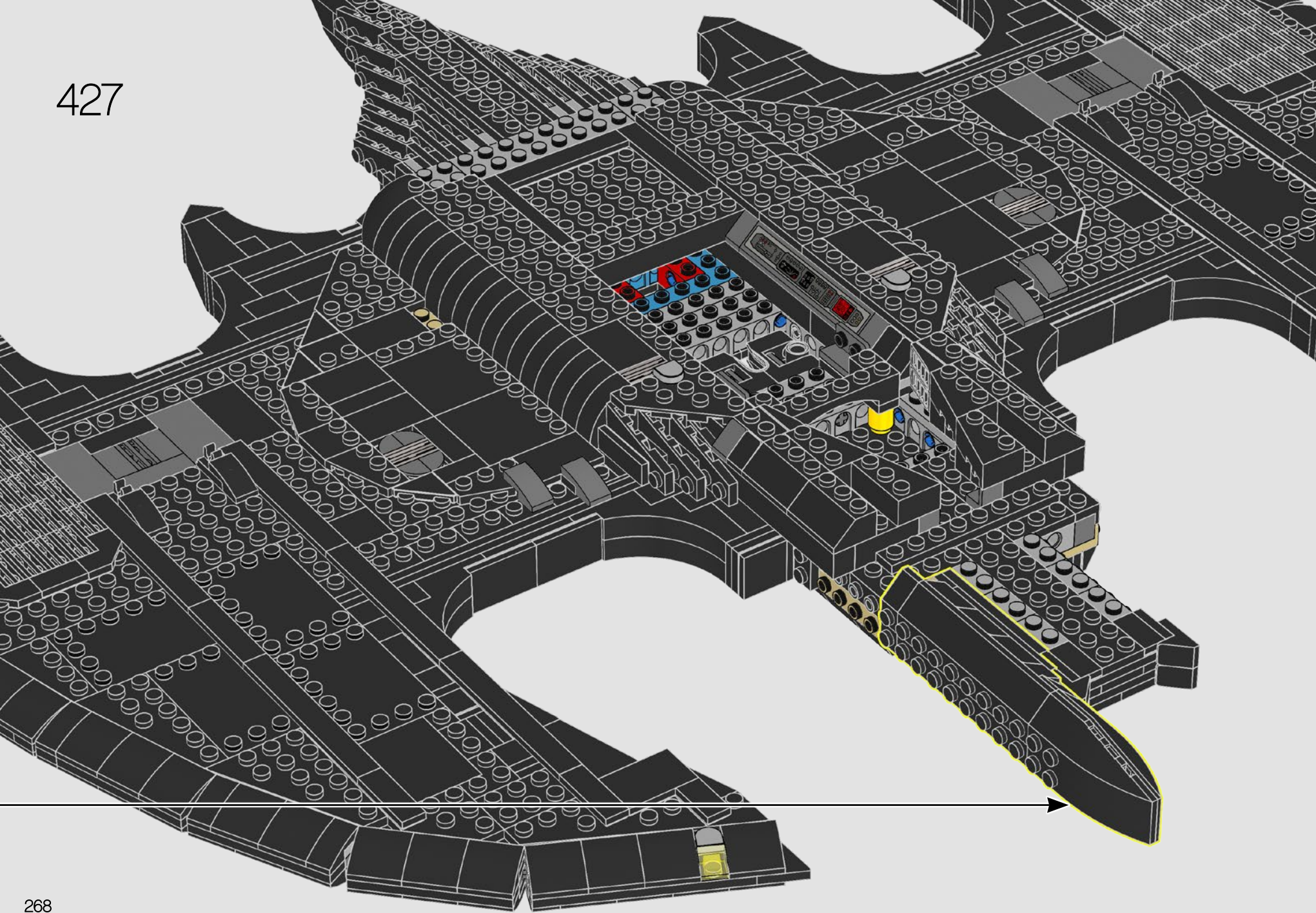

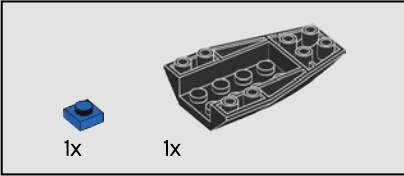
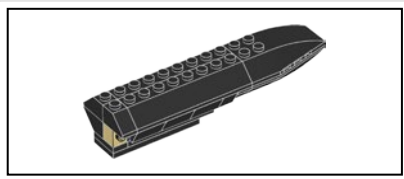

428

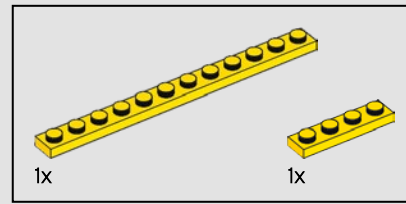
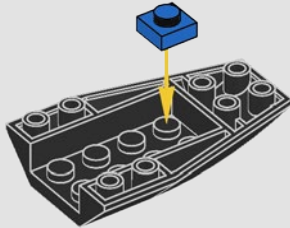

429

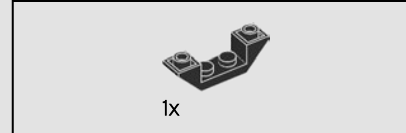
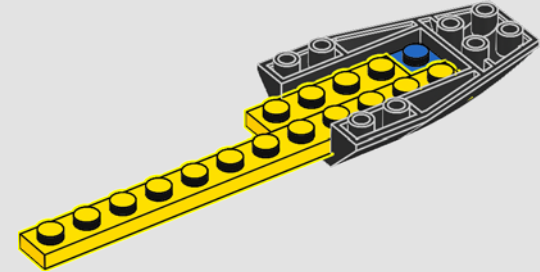

430

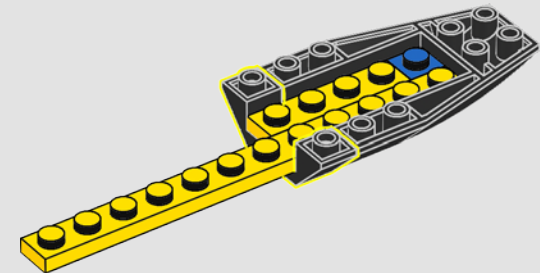

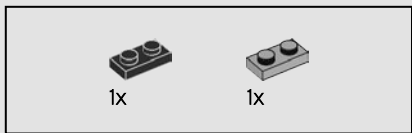

431

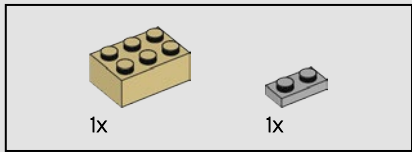
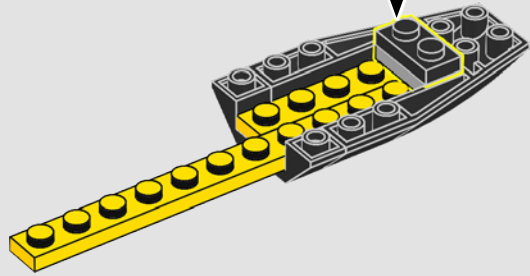
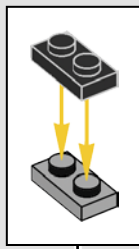

432

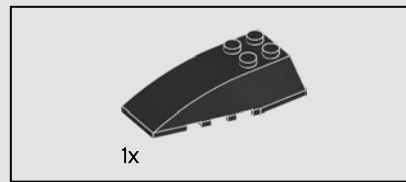
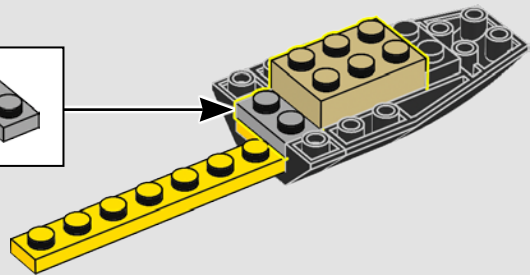
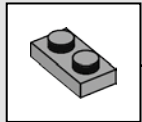

433

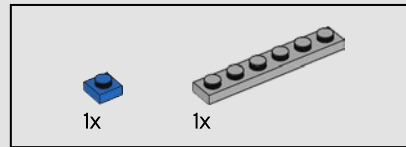
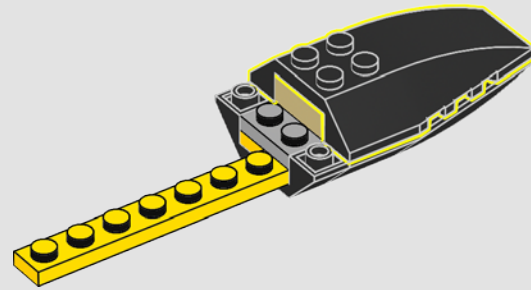

434

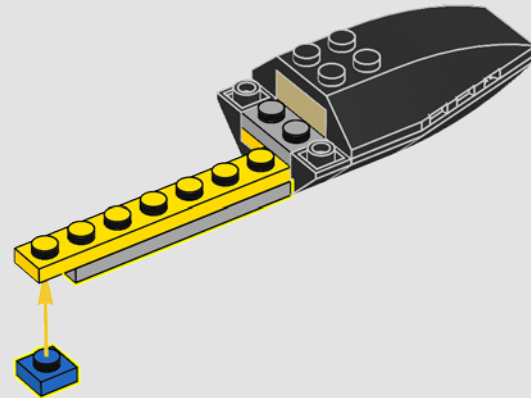

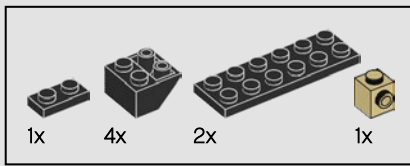

435

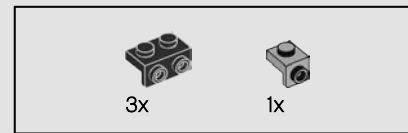
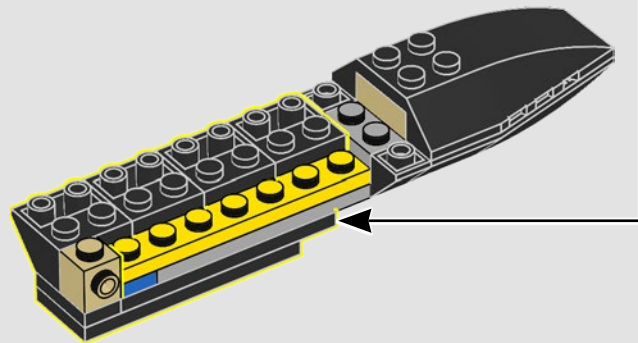
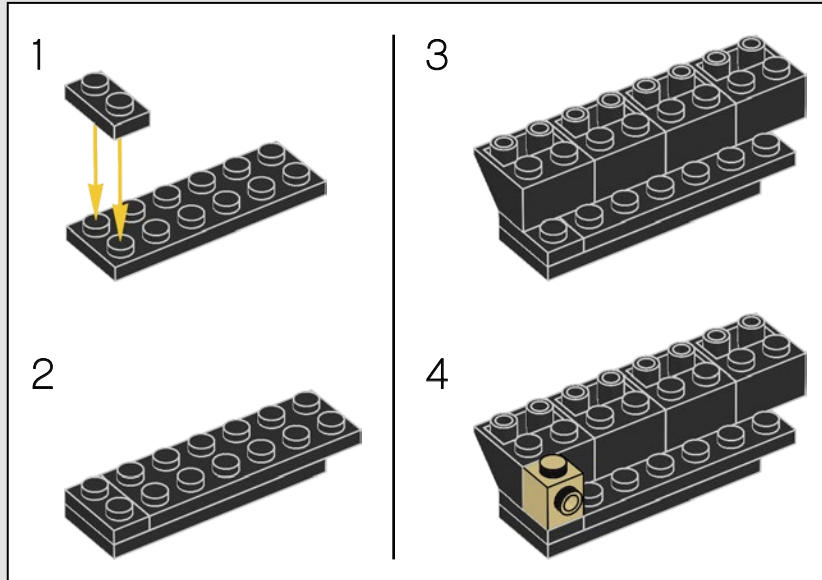

436

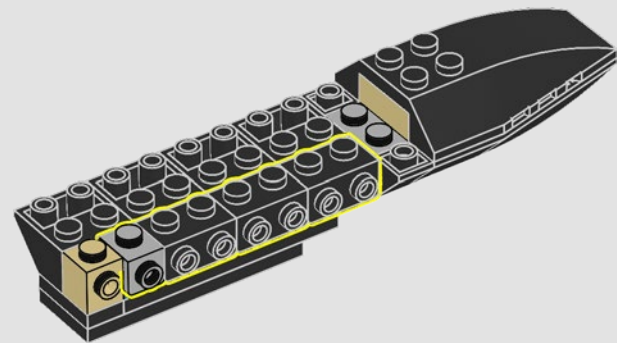



437

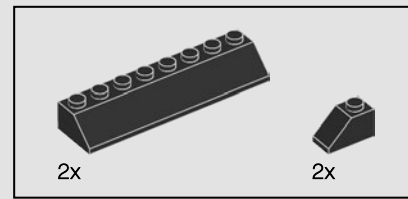
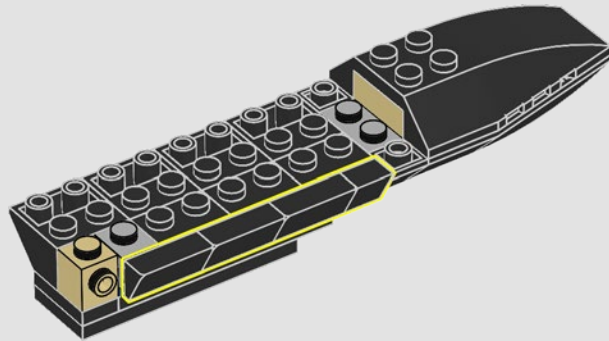

438

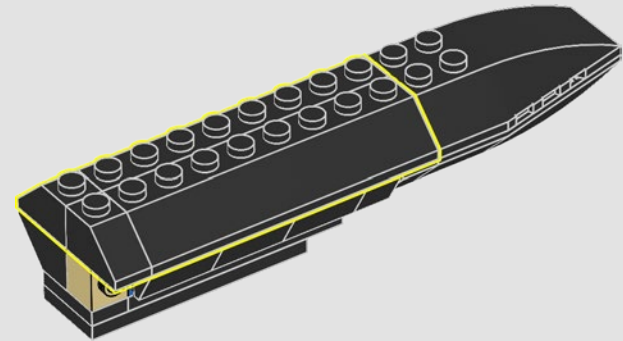



439

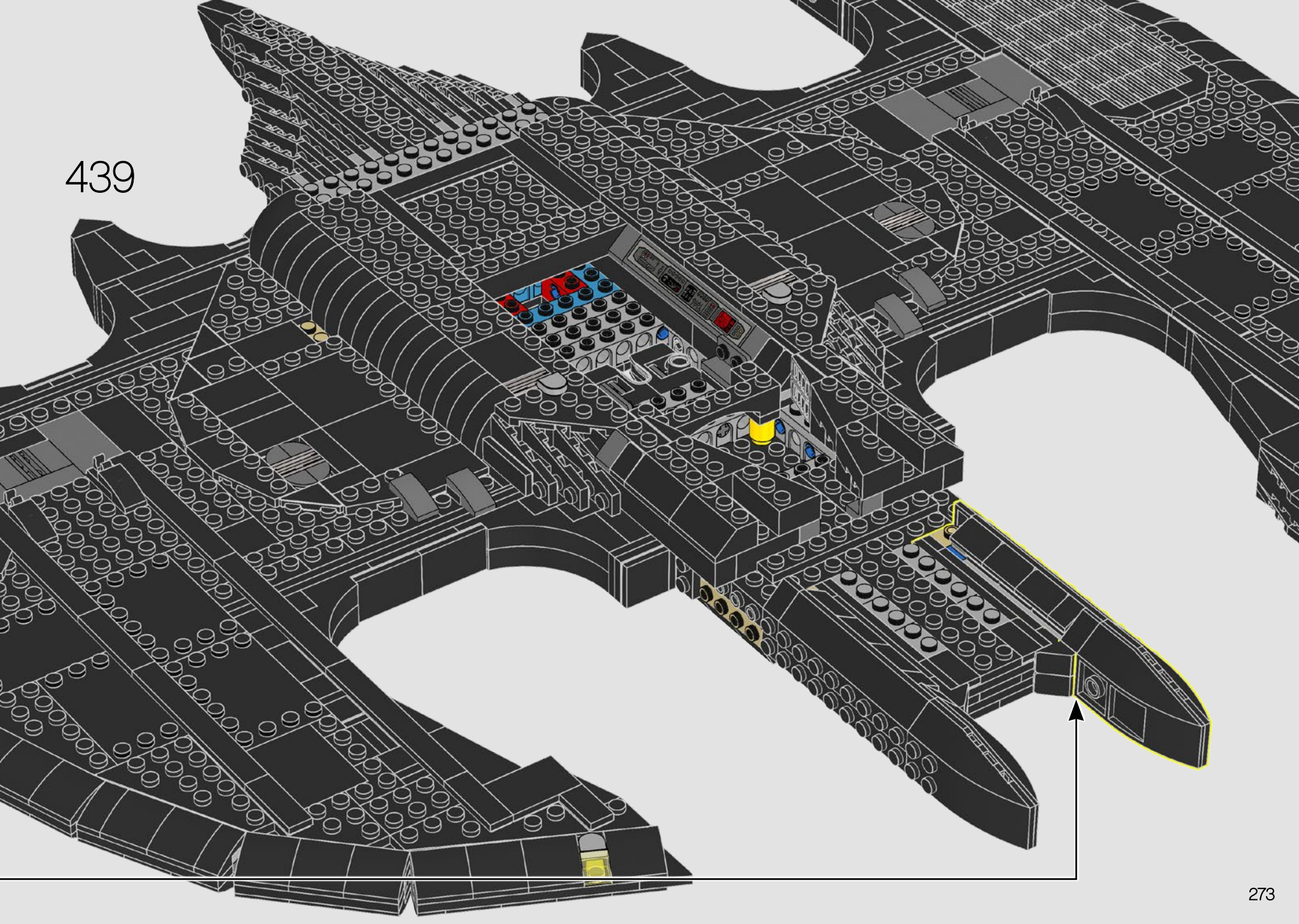

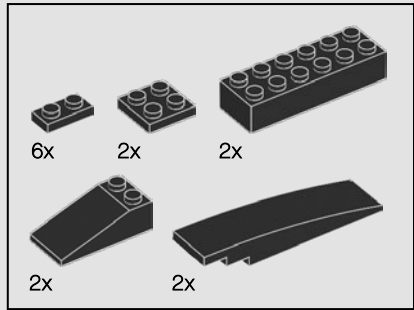
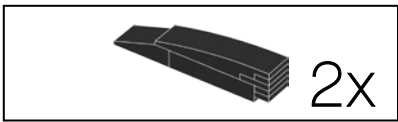

440

1

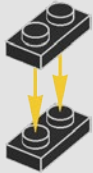

2

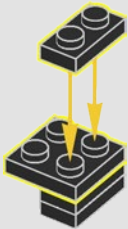

3

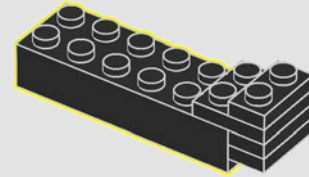

4

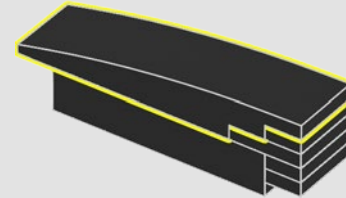

5

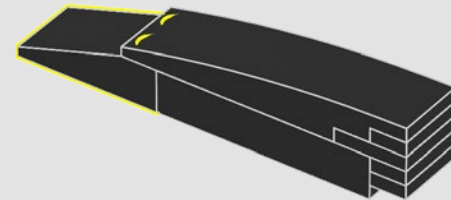

2x

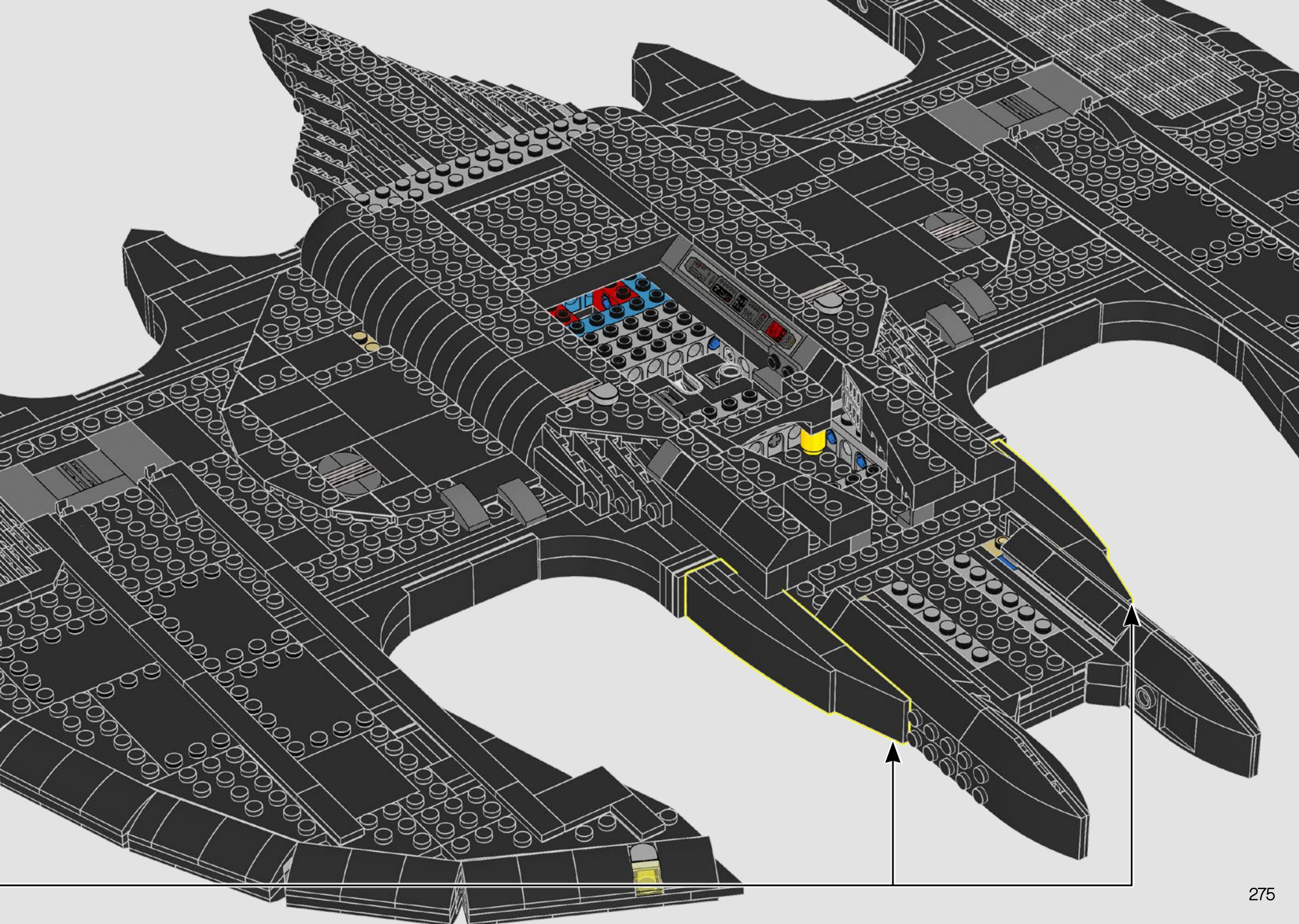

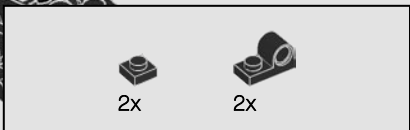

2x      2x

441

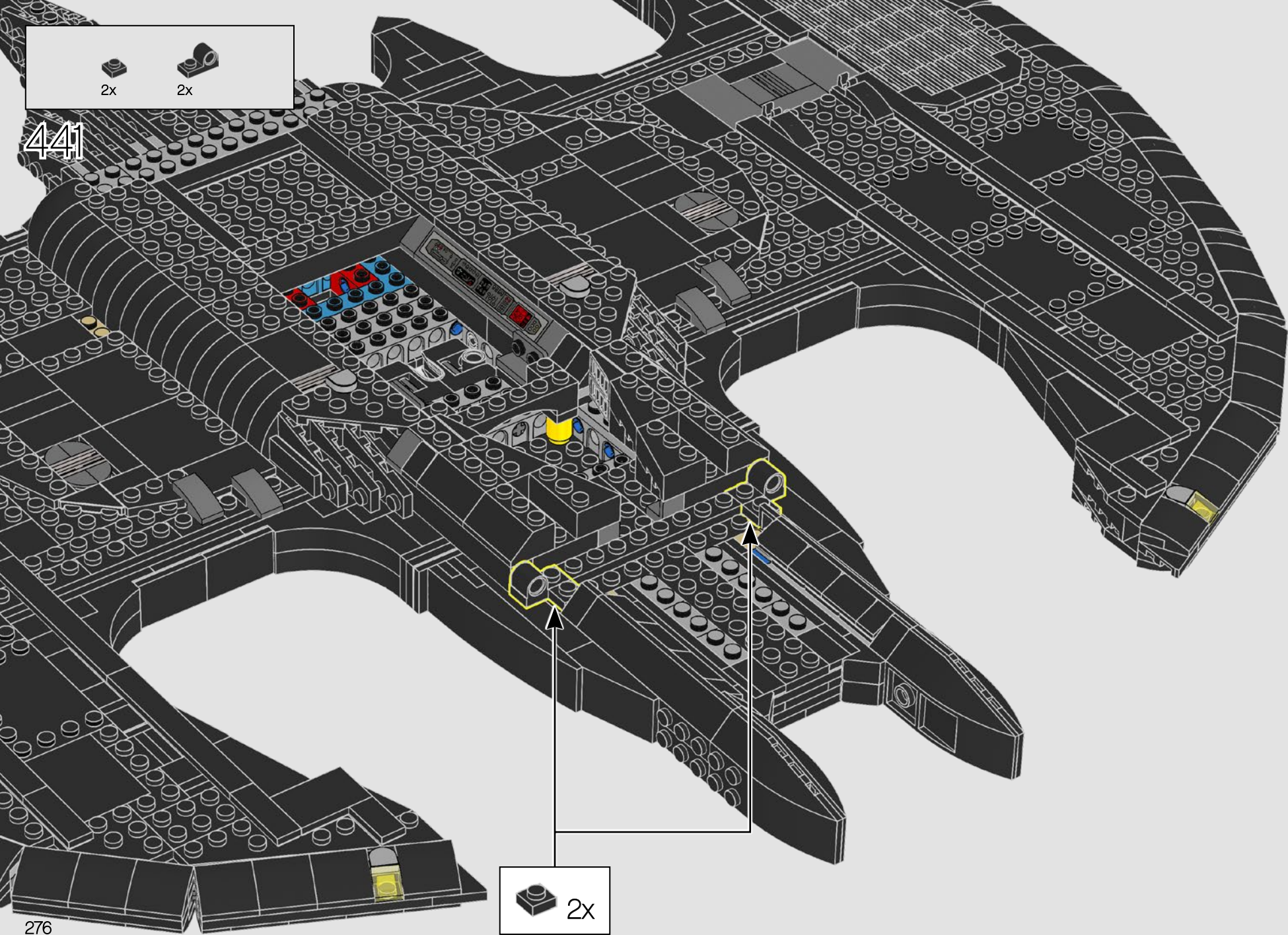

2x

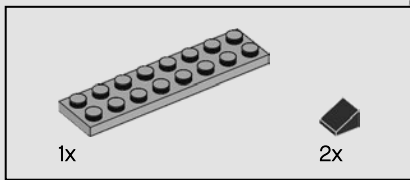

442

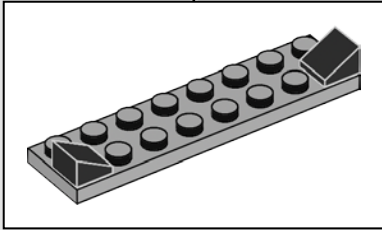
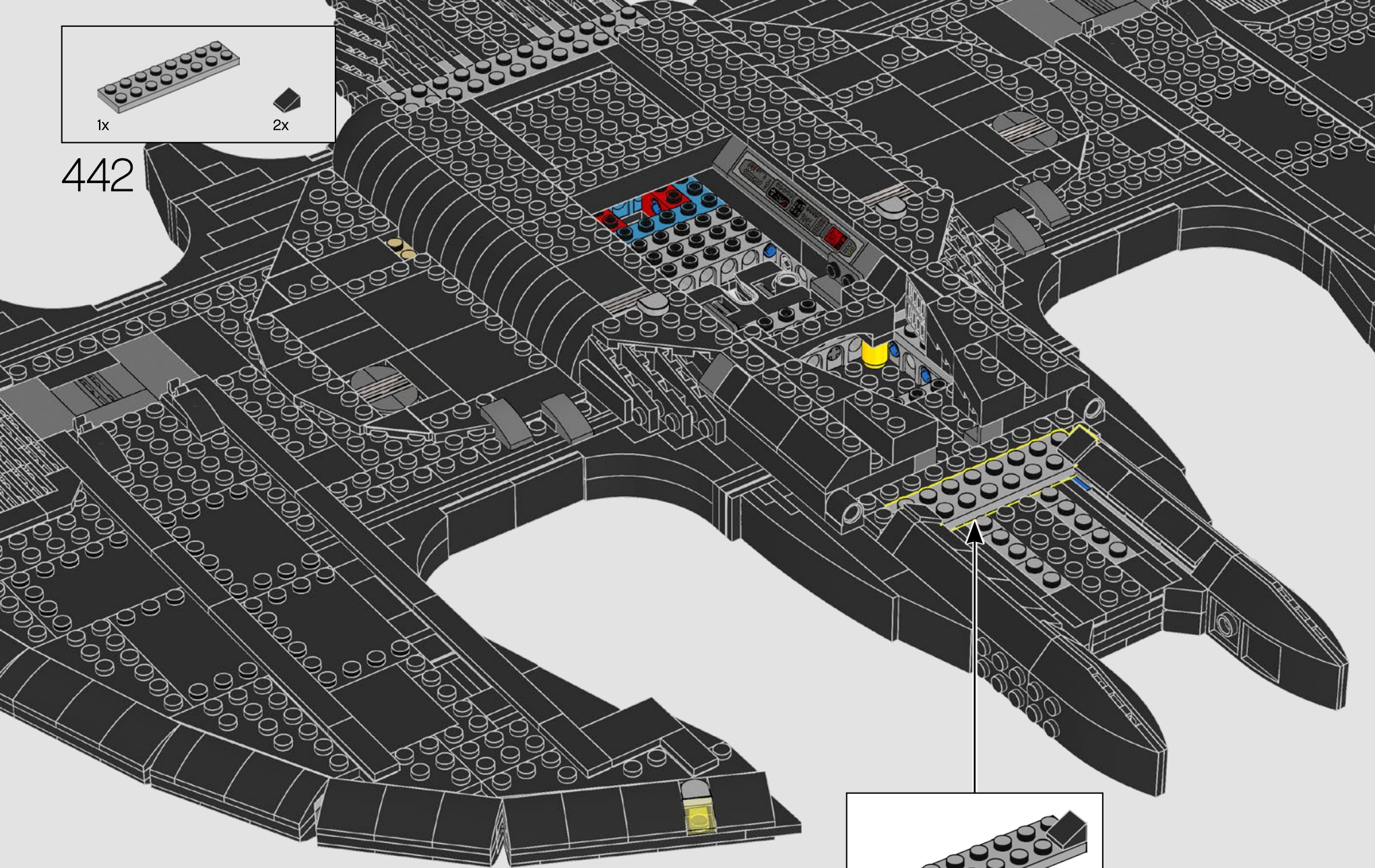

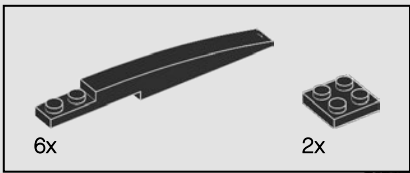

443

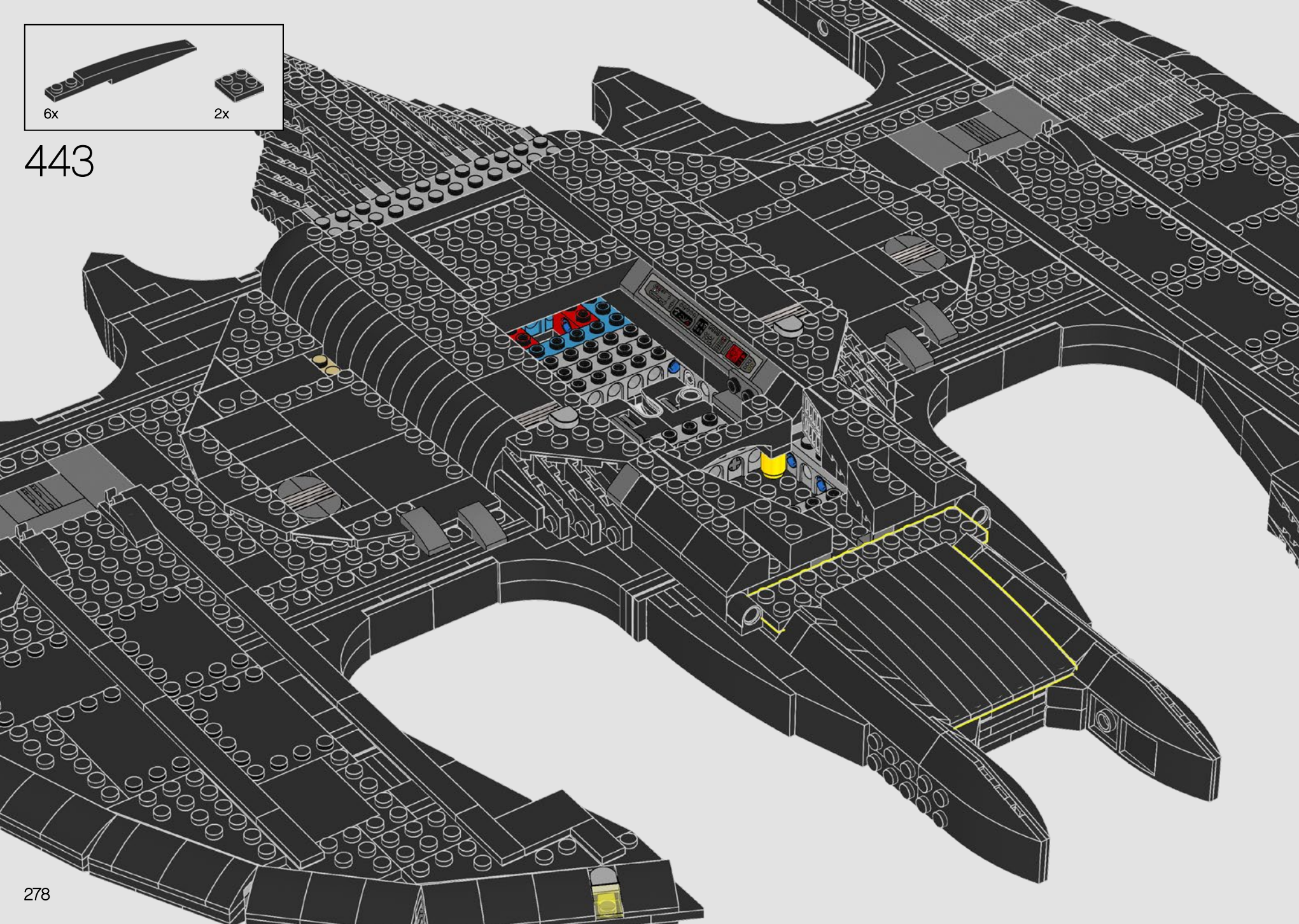

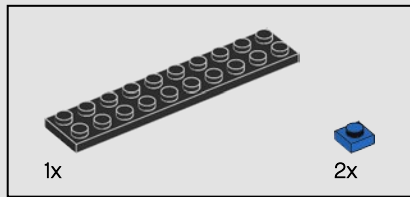

444

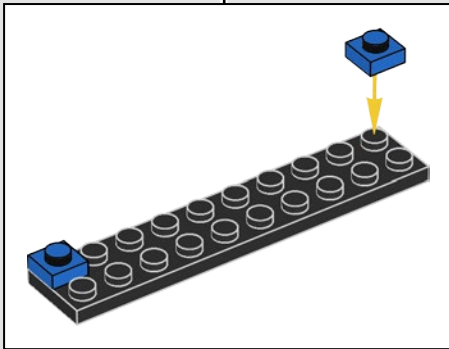
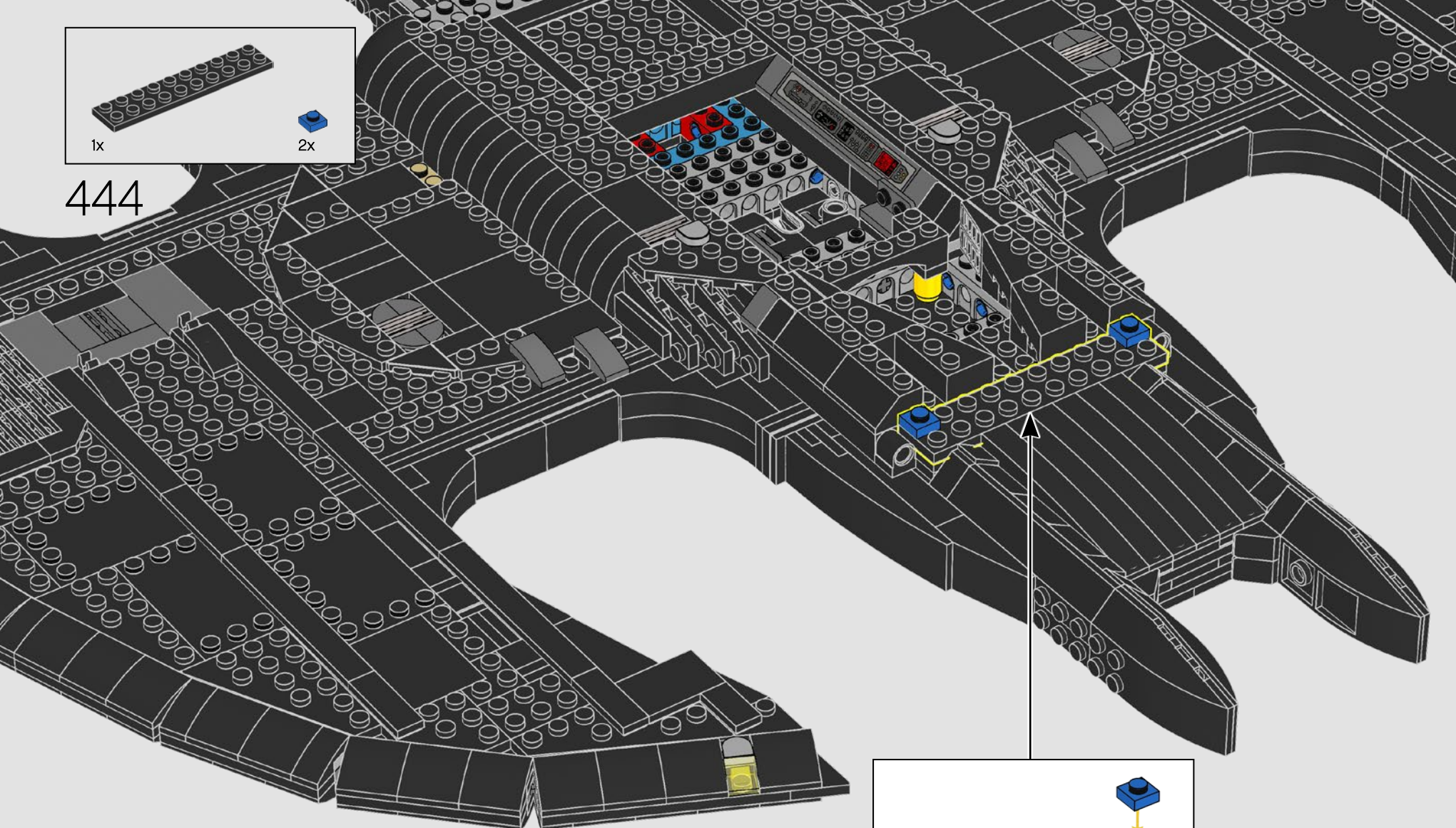

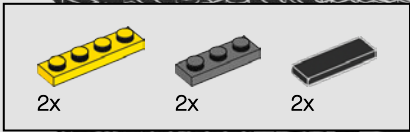

445

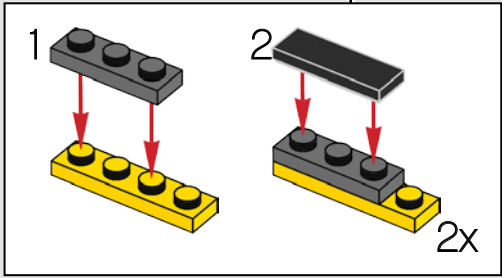
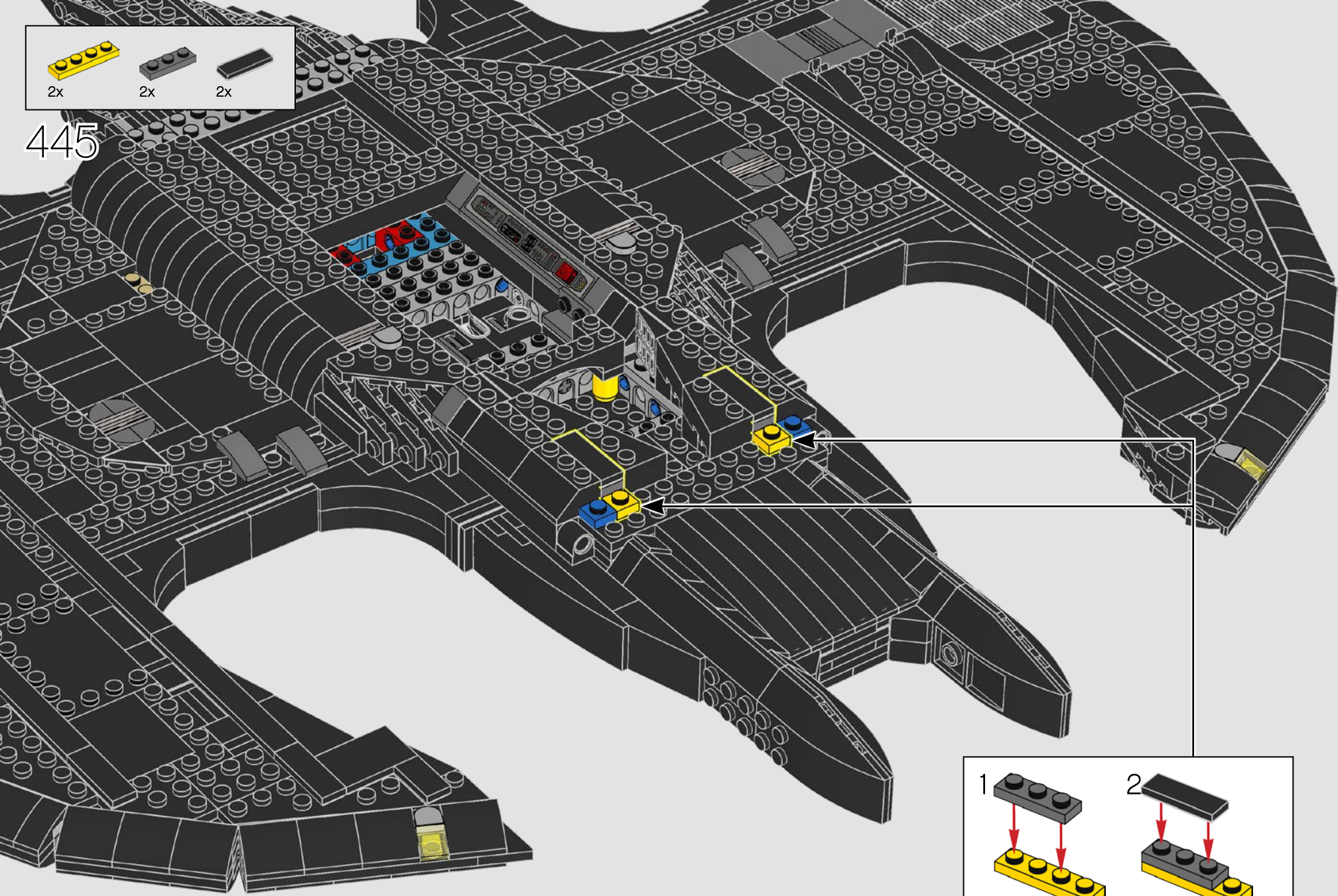





446

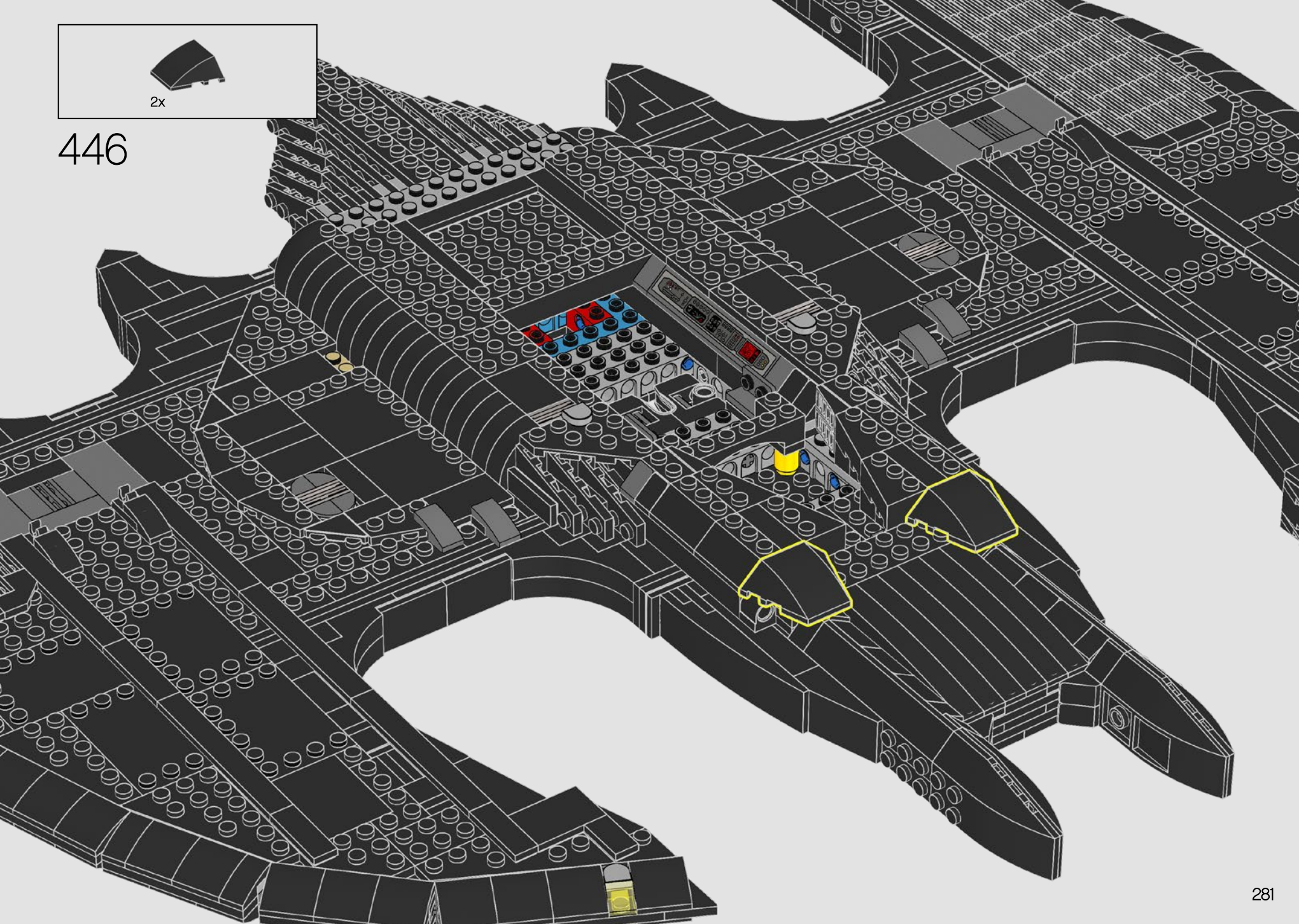

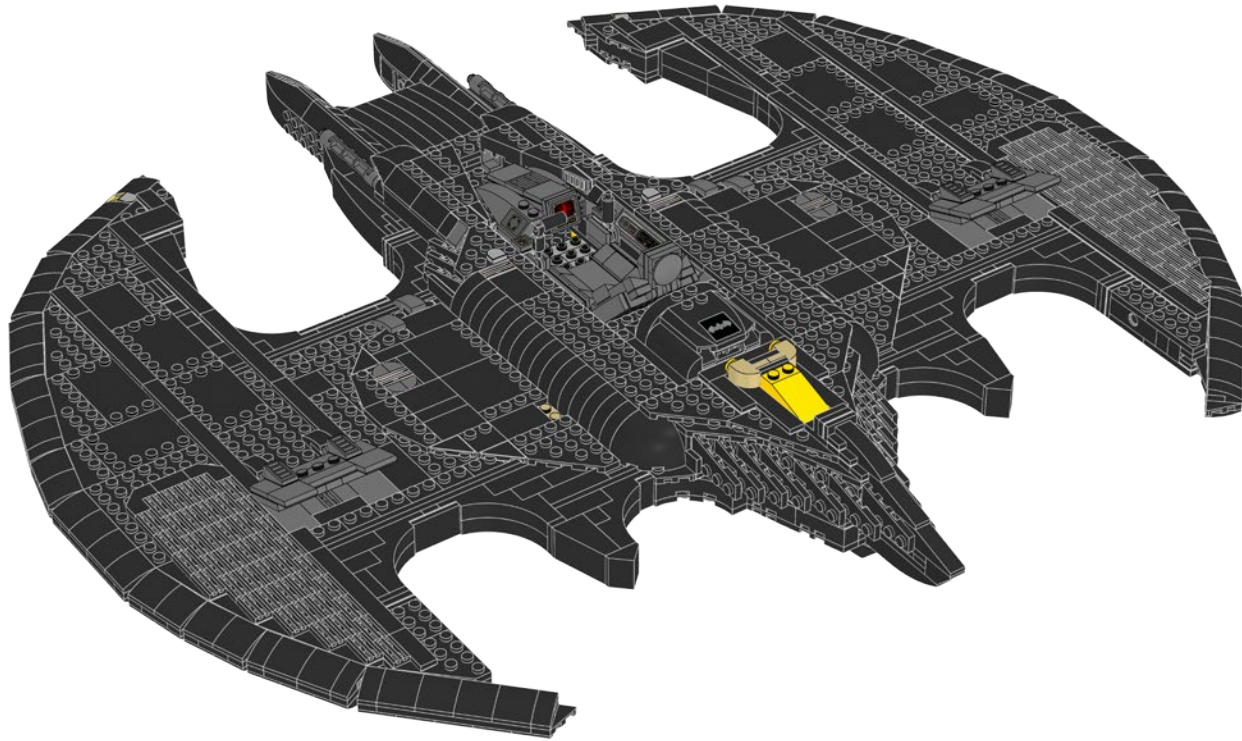
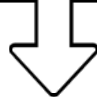



447

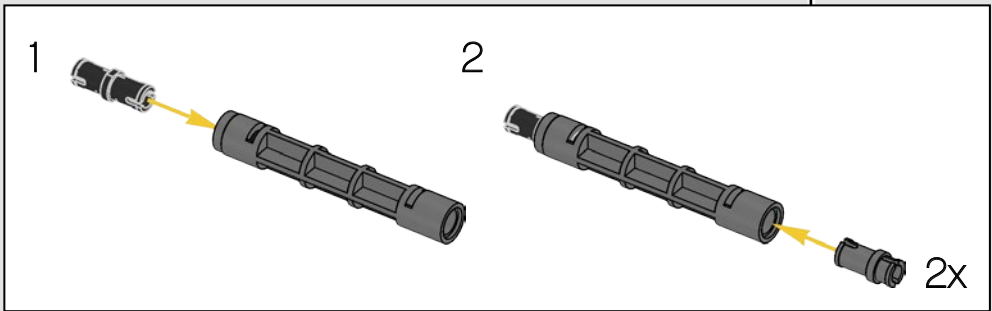
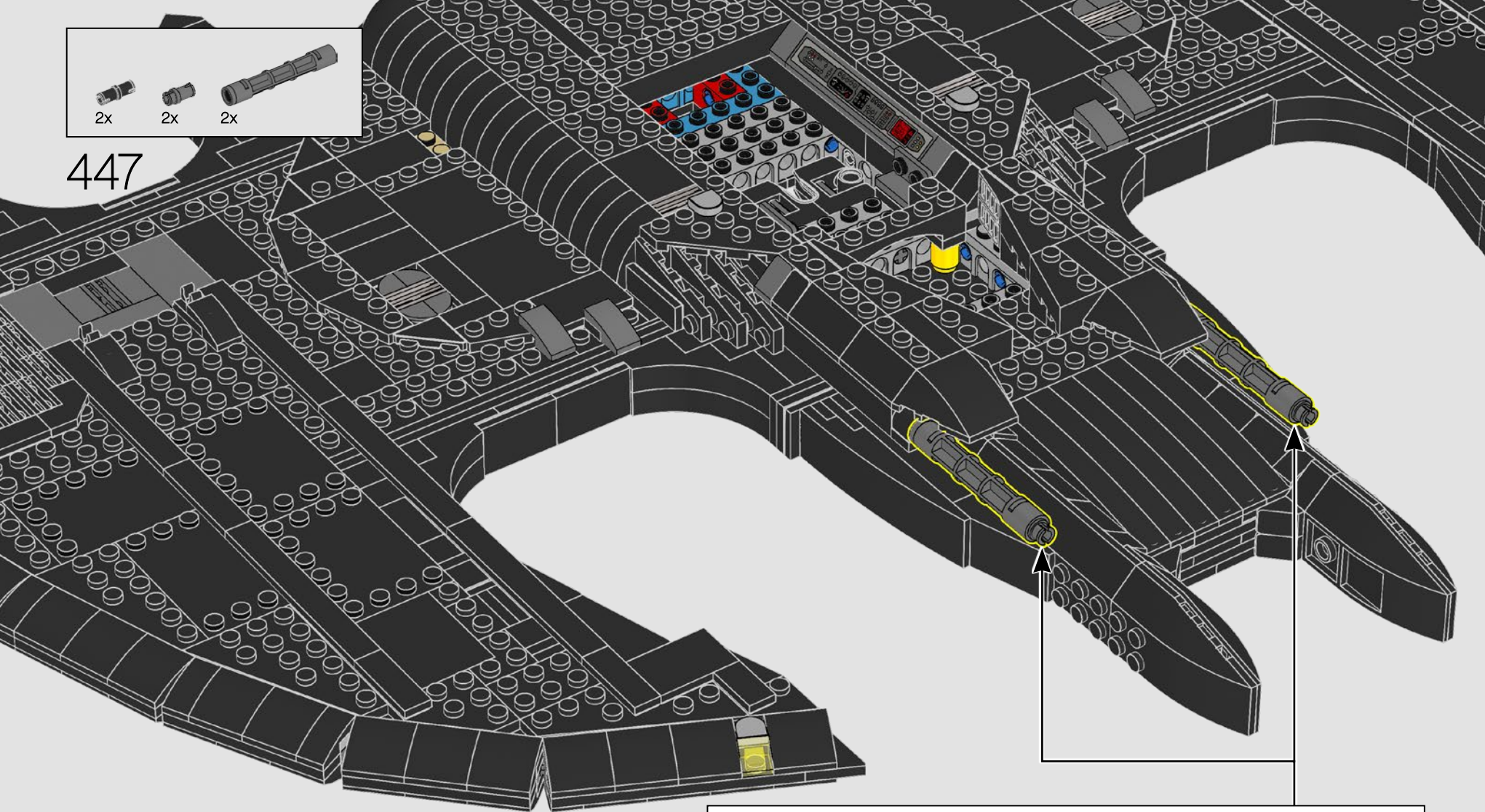

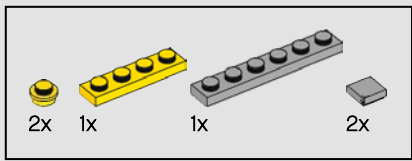

448

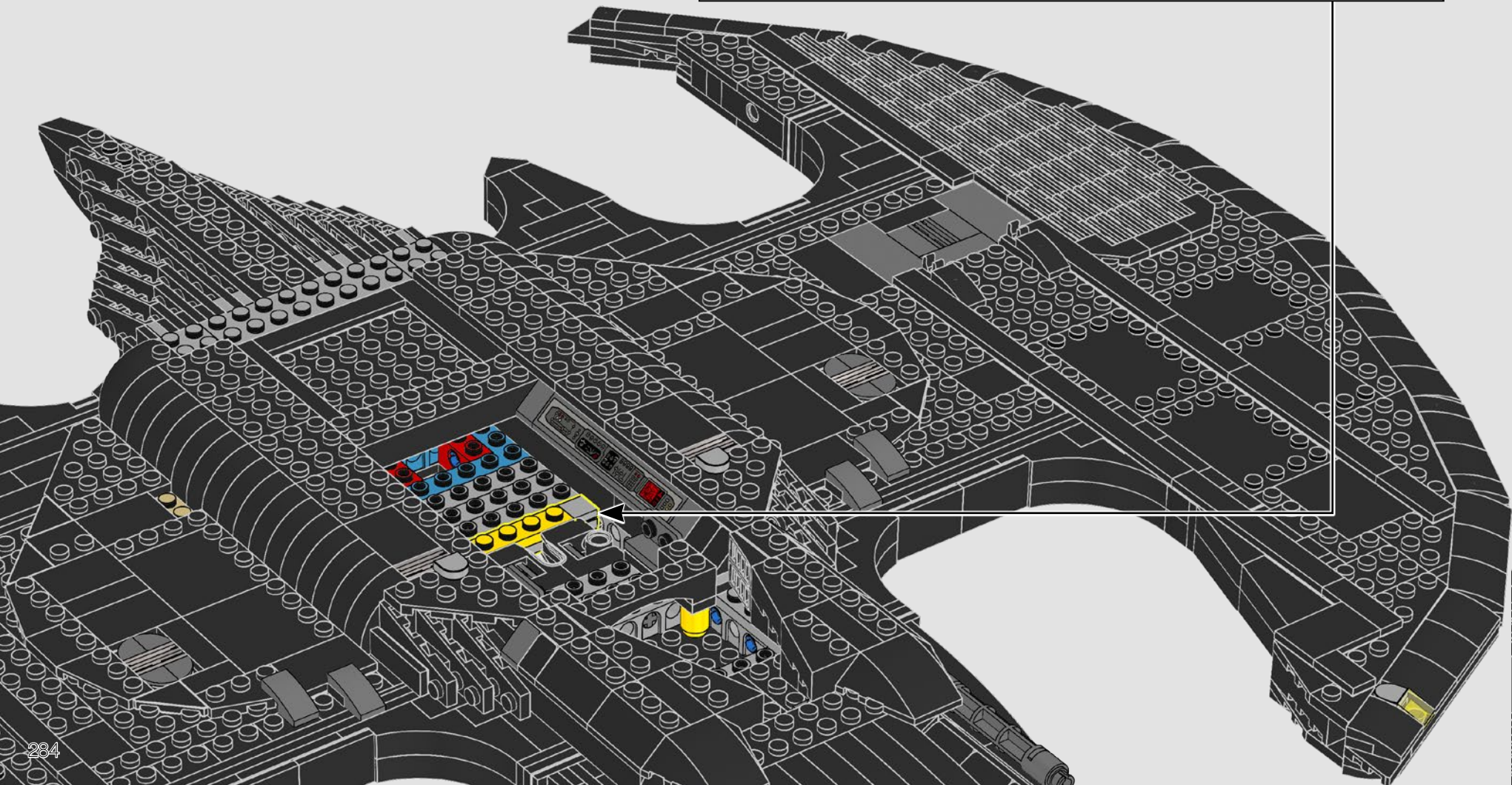
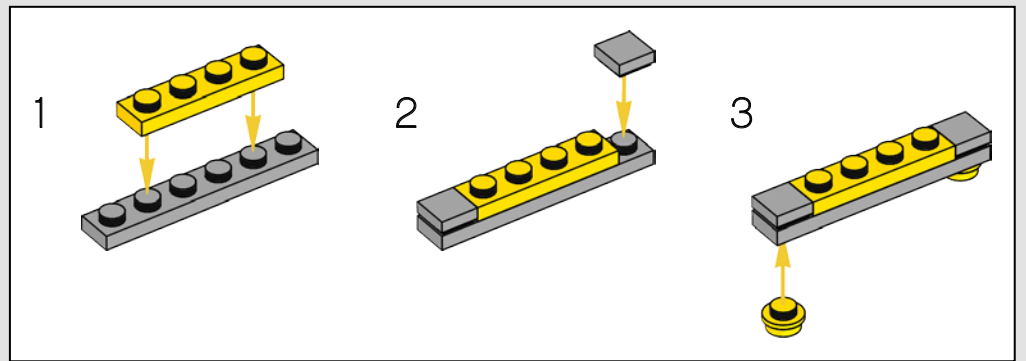

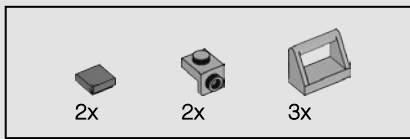

449

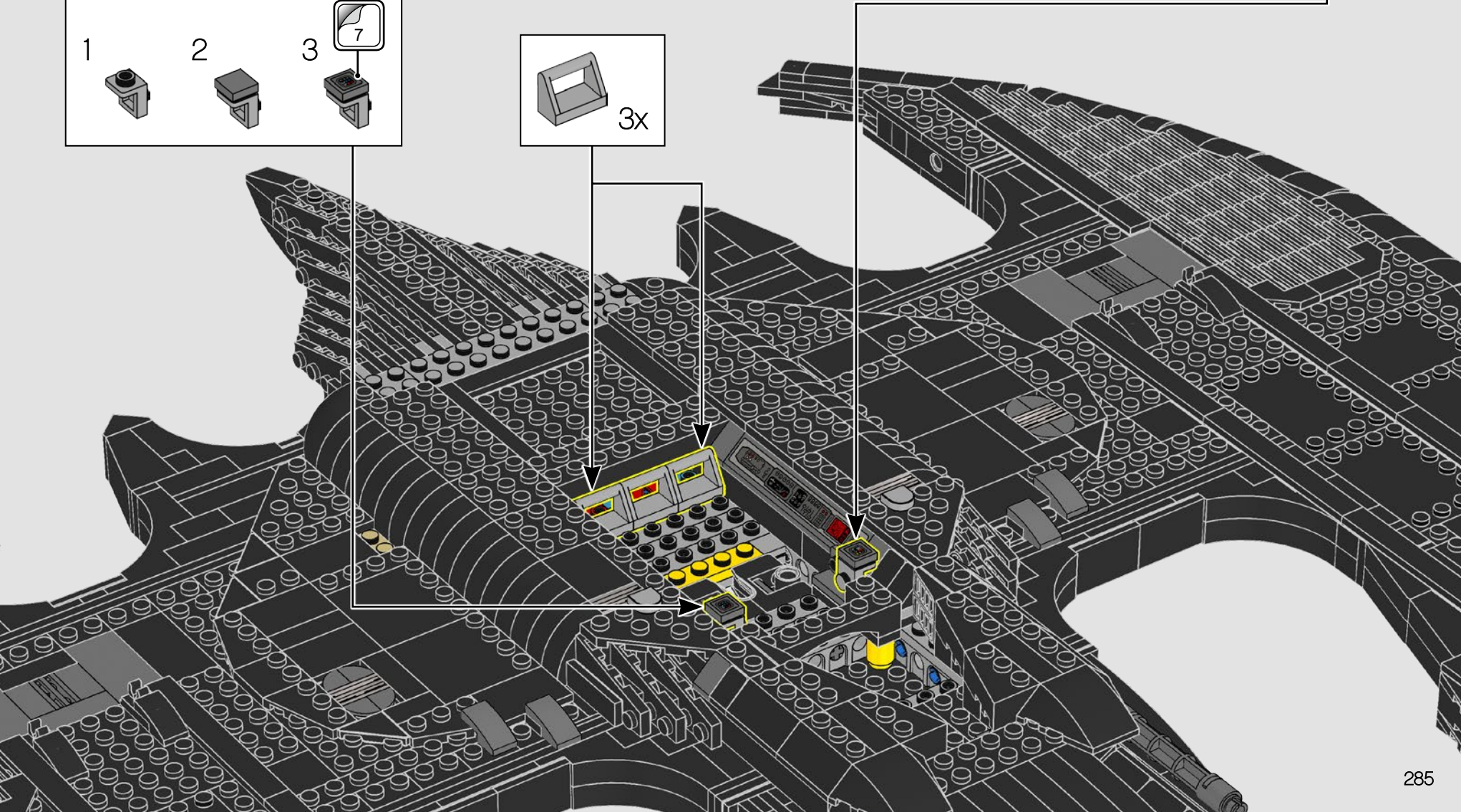
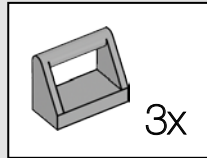
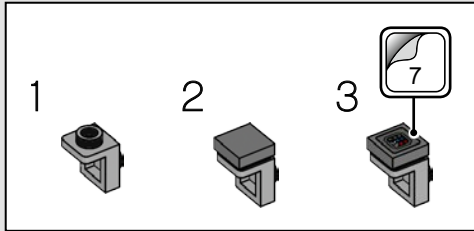
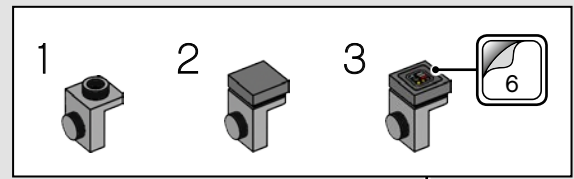

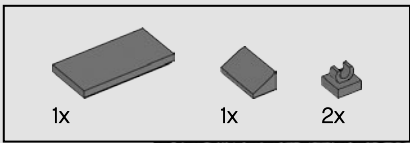

450

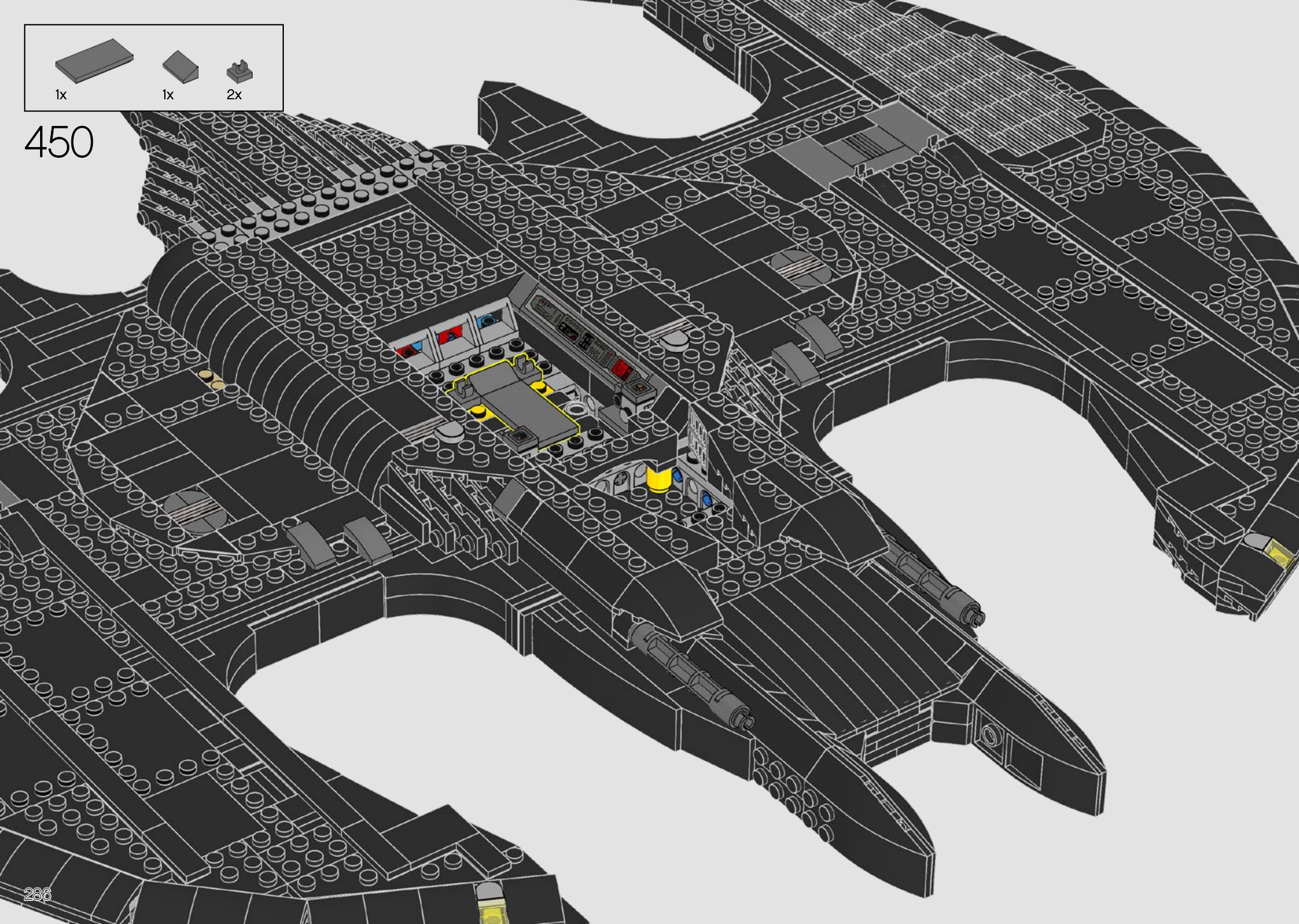

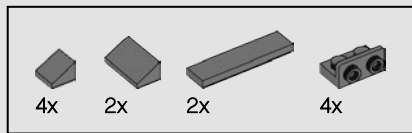

451

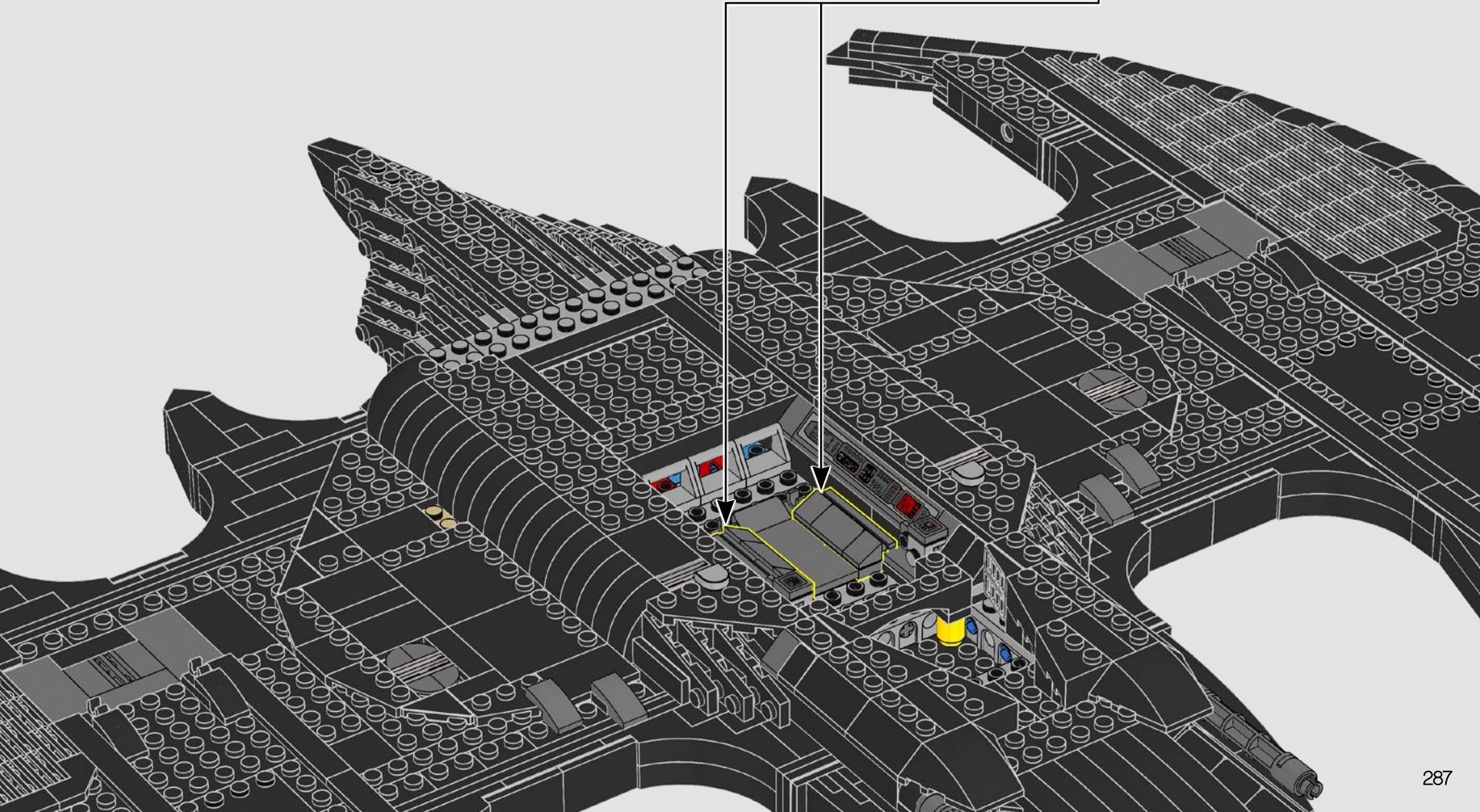
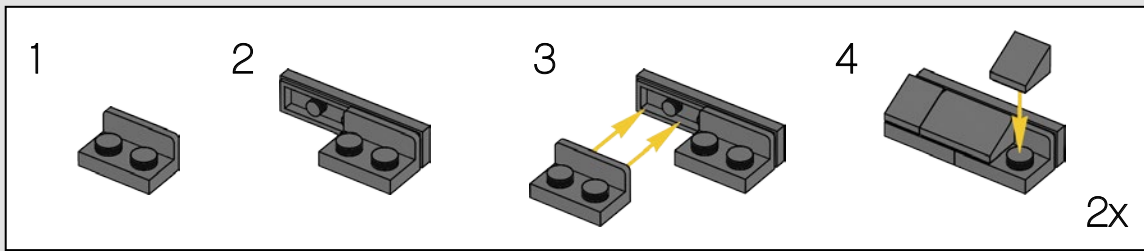

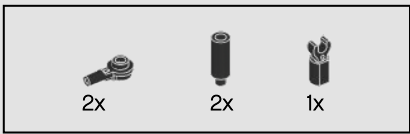

452

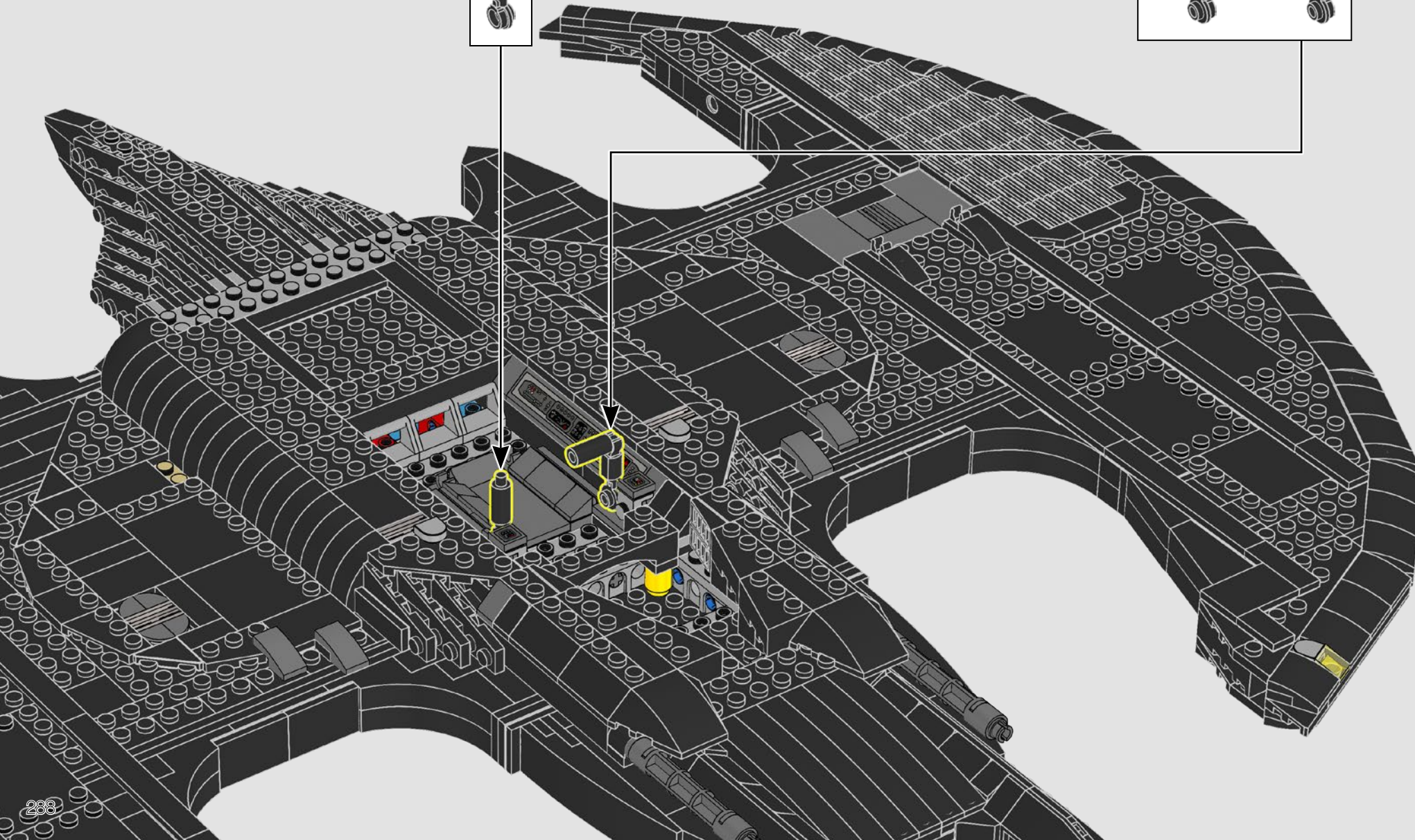
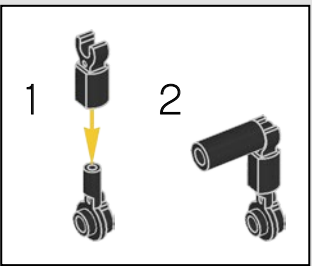
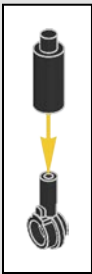



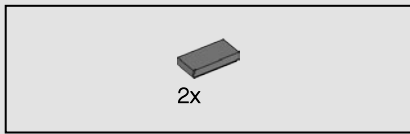

453

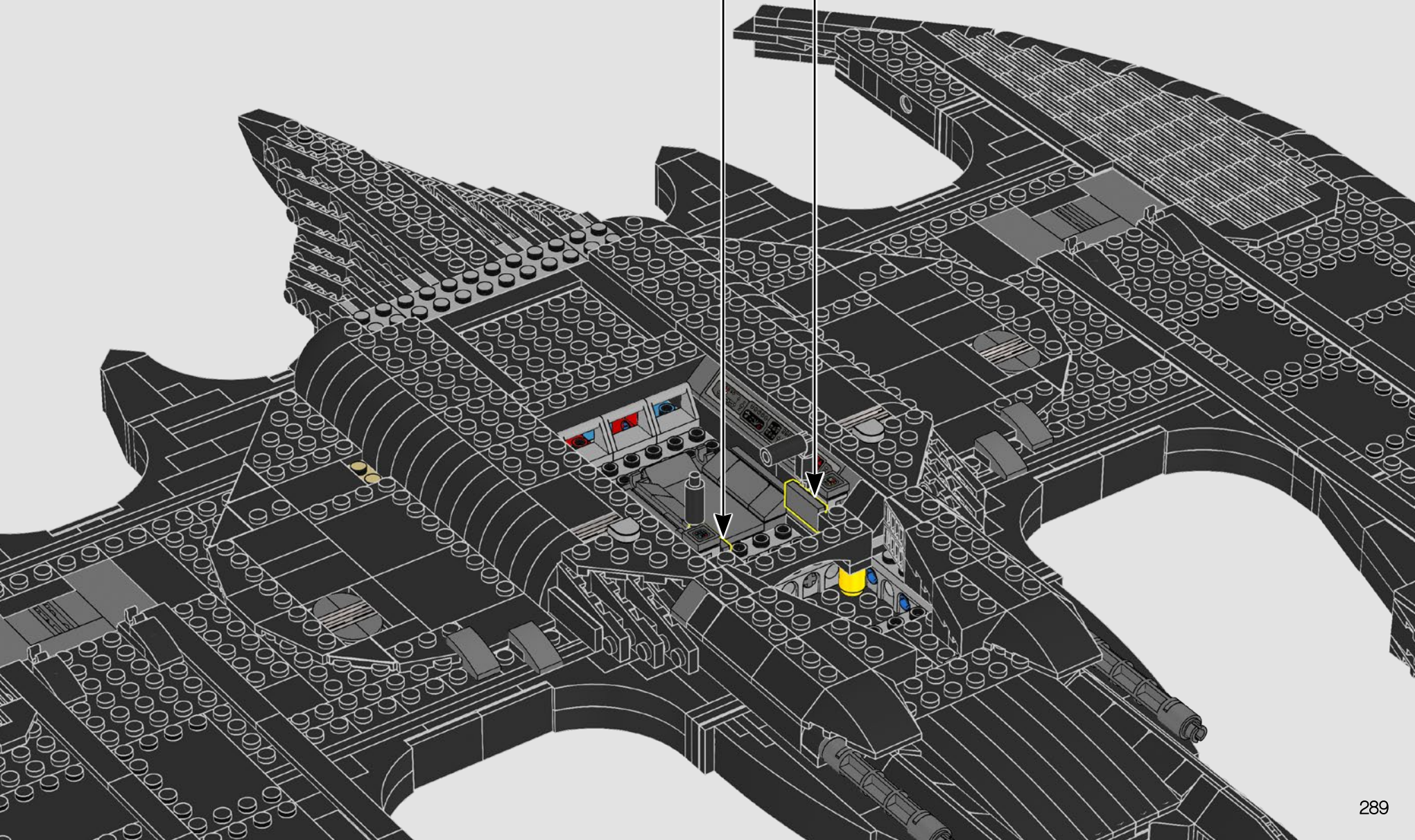
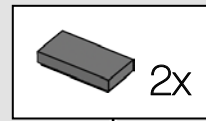

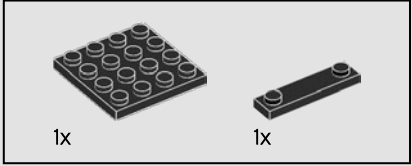
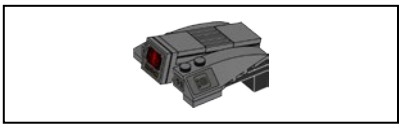

454

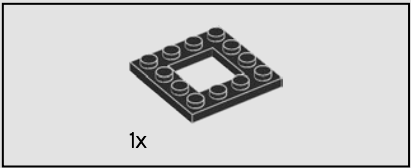
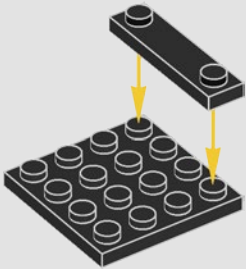

455

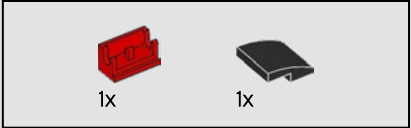
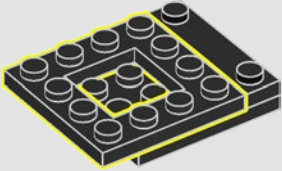

456

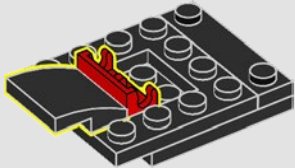

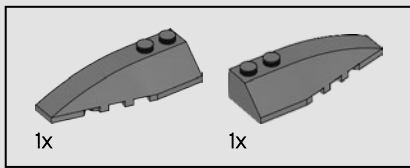

457

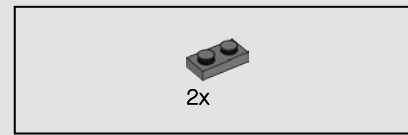
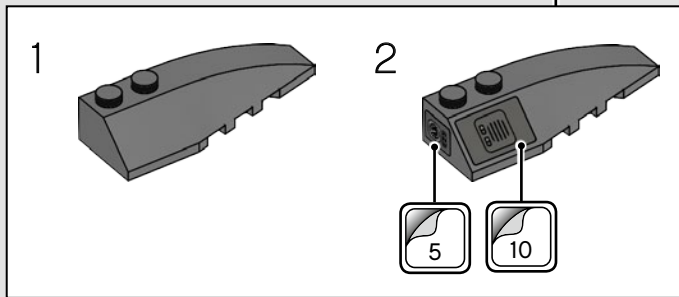
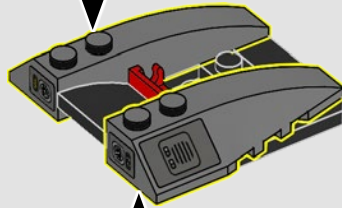
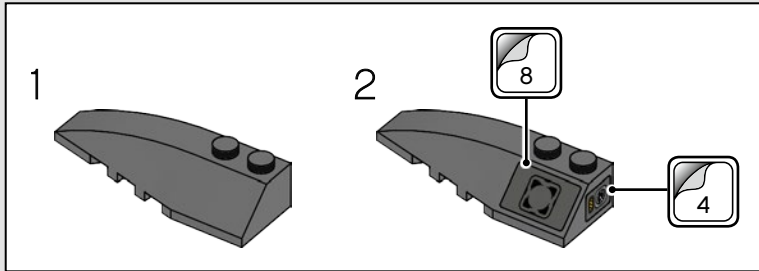

458

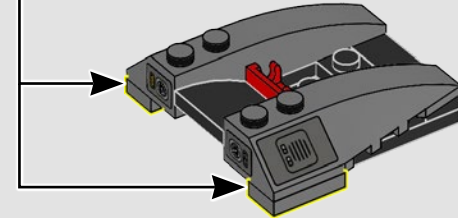
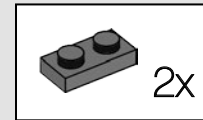

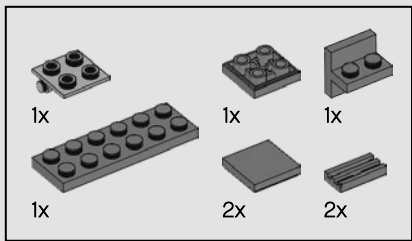

459

1

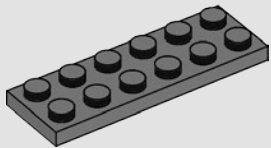

2

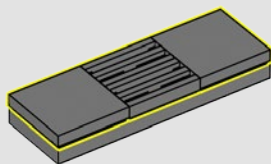

3

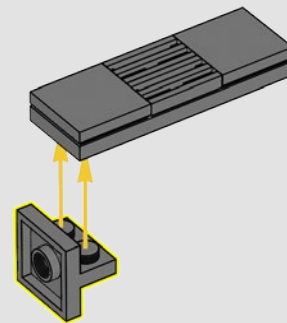

4

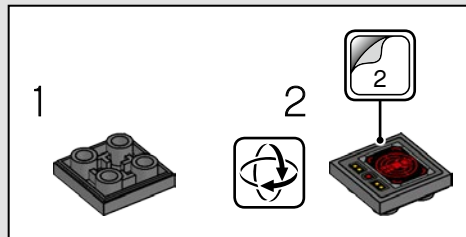

5

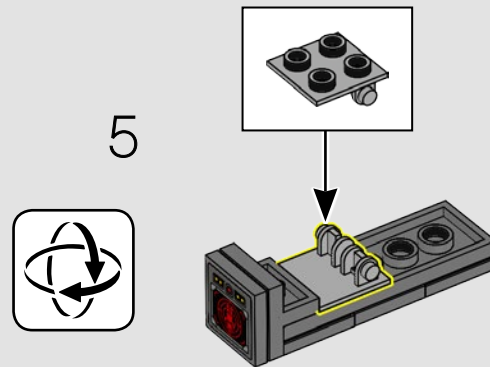

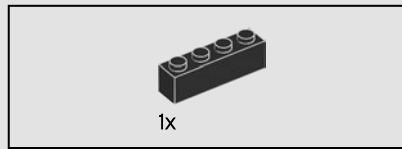

460

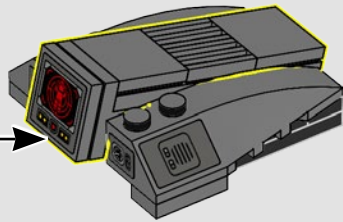
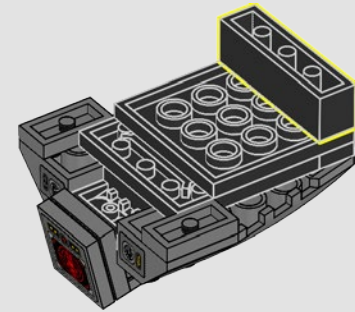
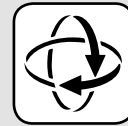

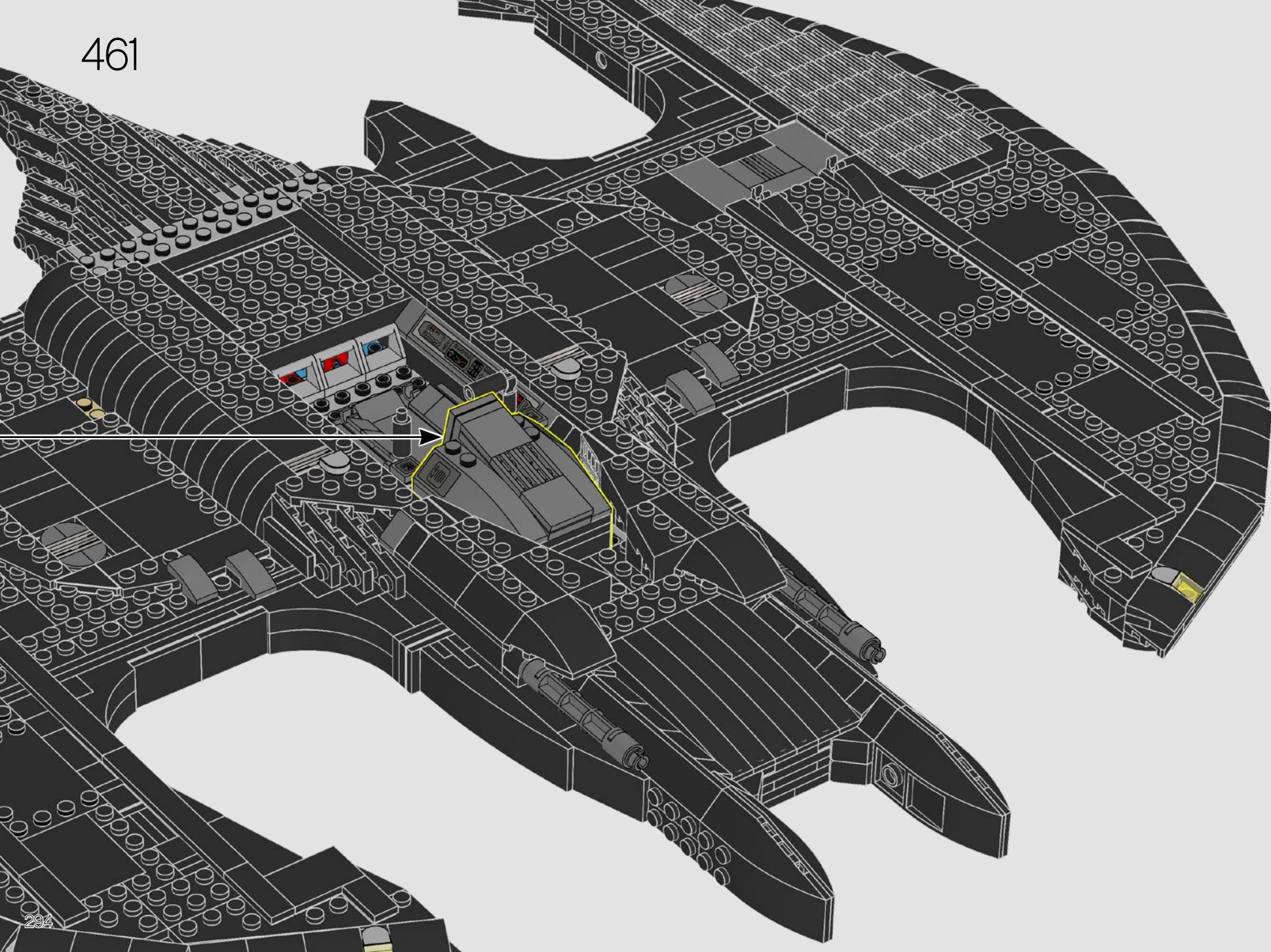

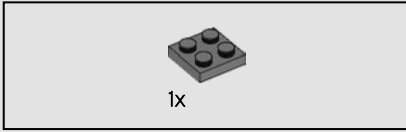
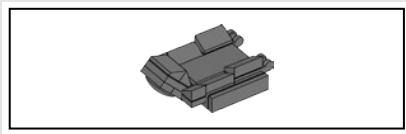

462

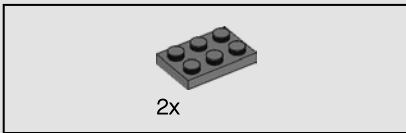
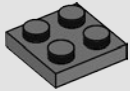

463

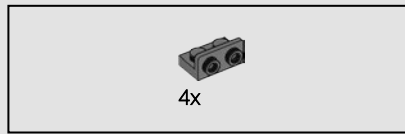
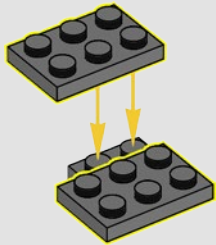

464

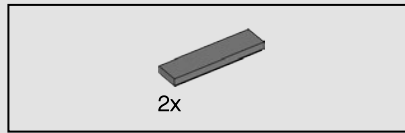
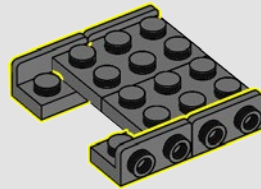

465

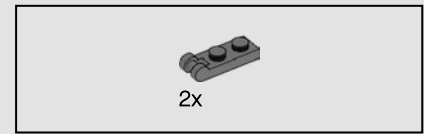
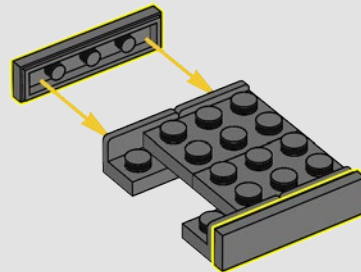

466

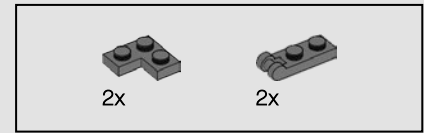
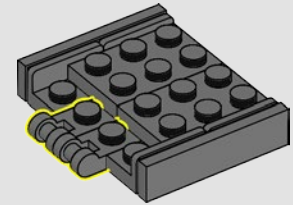

467

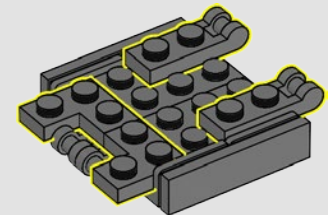

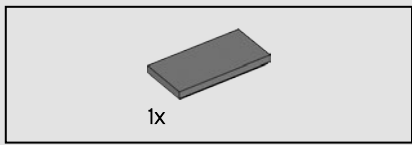

468

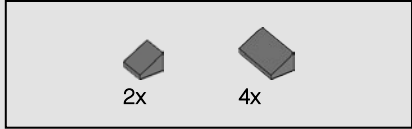
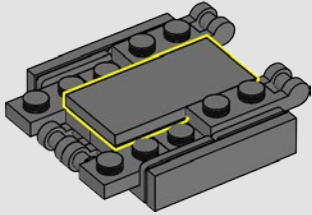

469

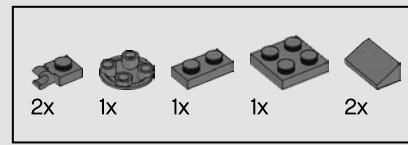
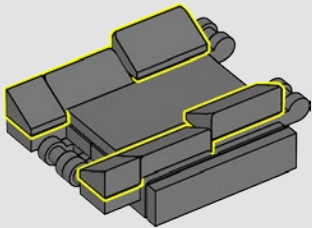

470

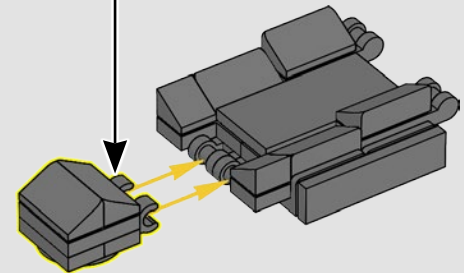
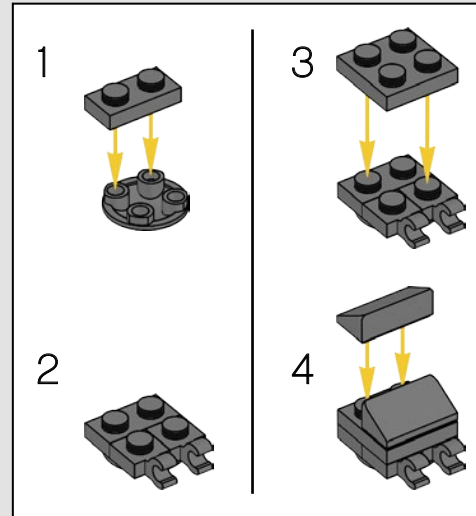



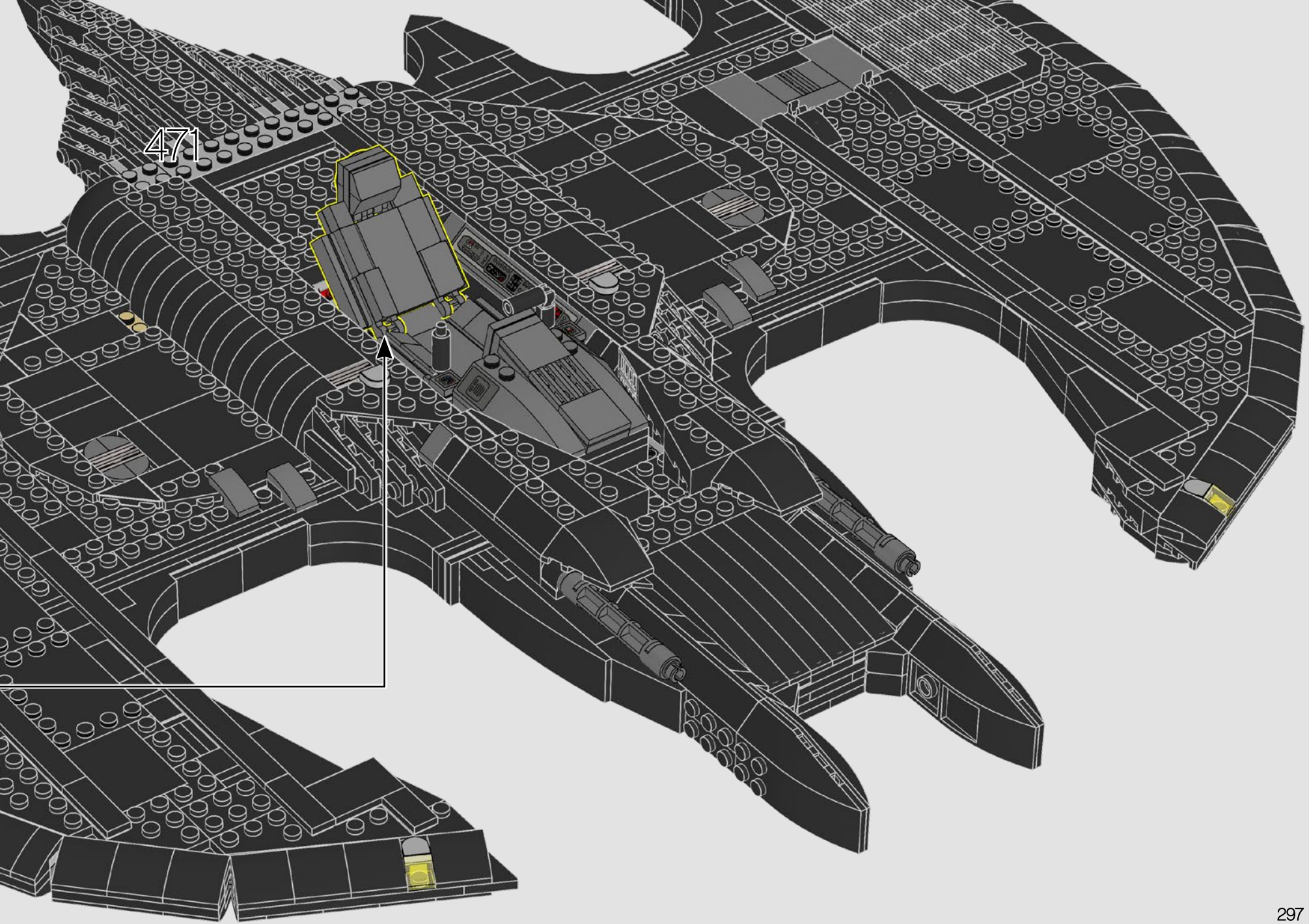

471

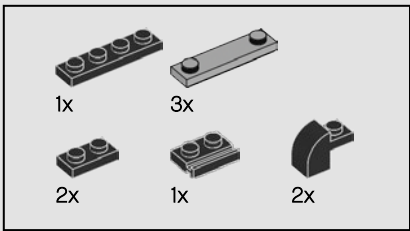

472

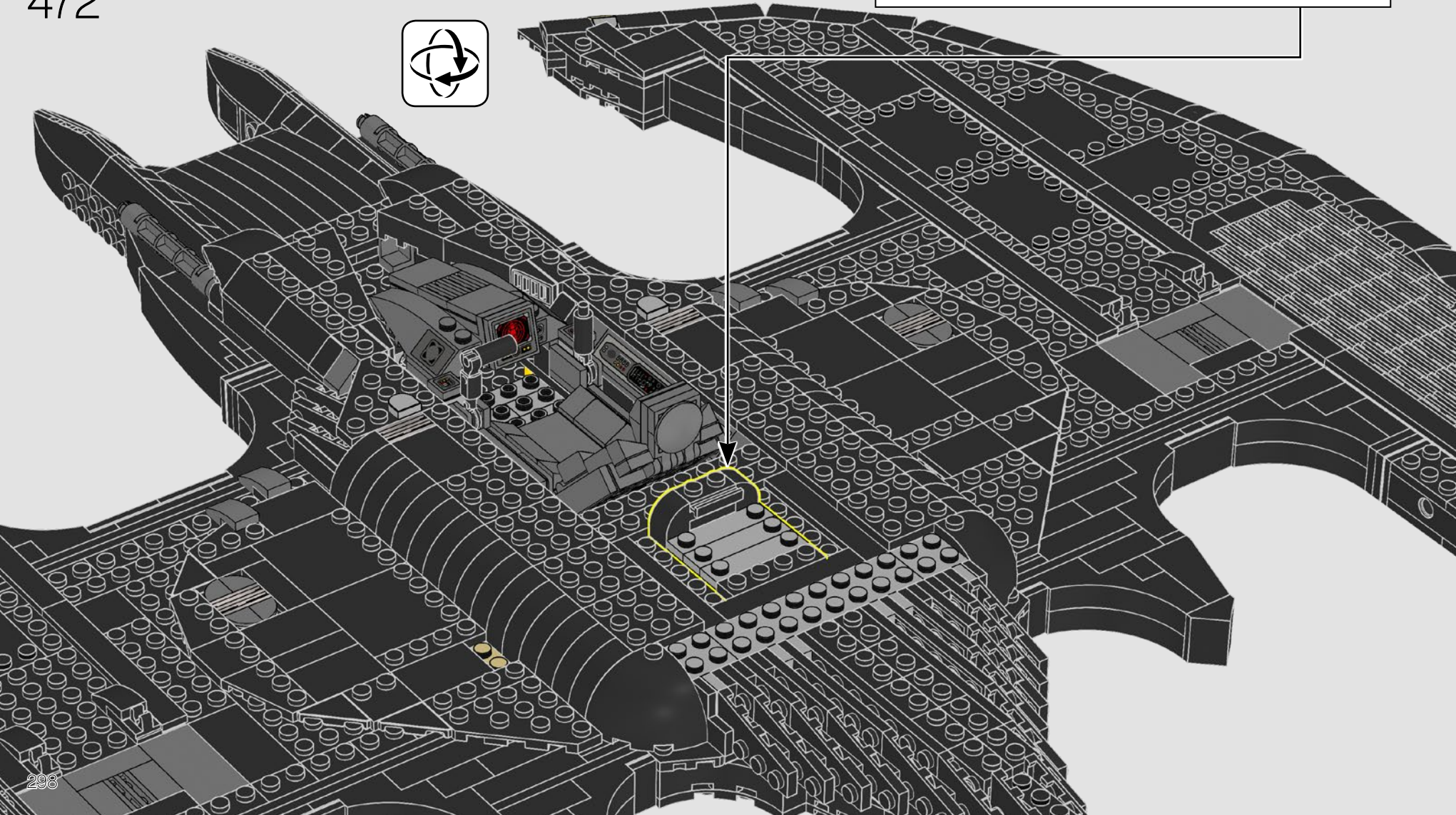
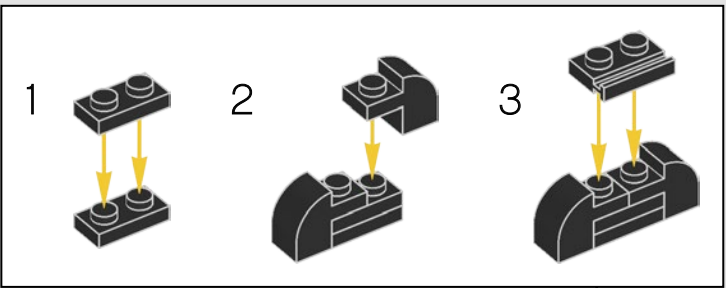

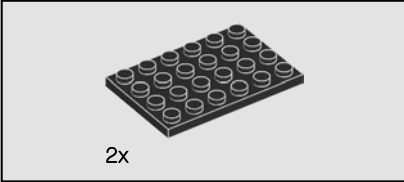
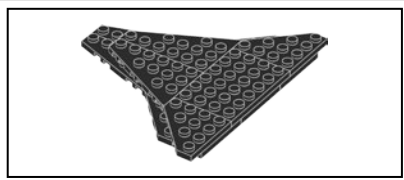

2x

473

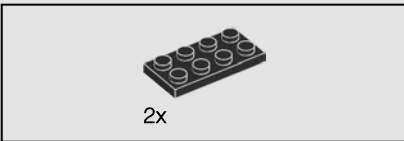
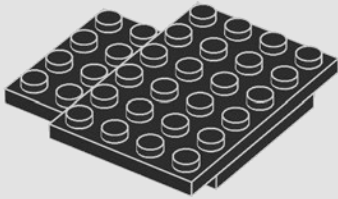

2x

474

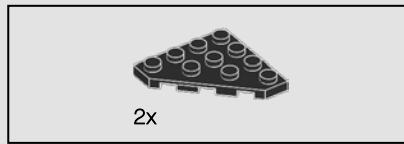
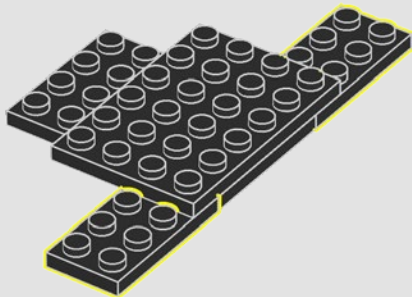

2x

475

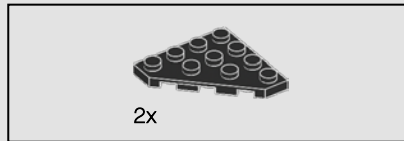
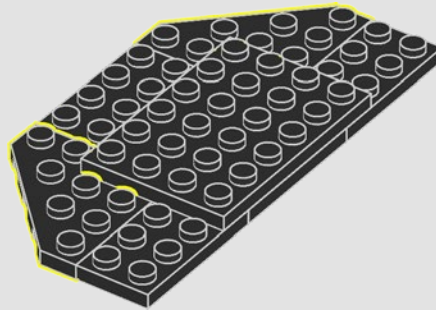

2x

476

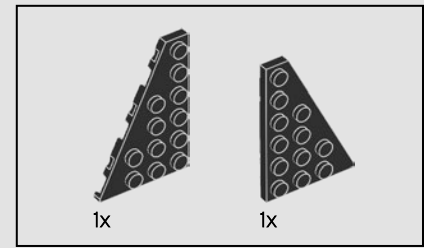
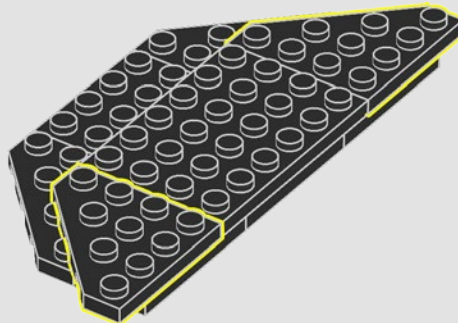

1x

1x

477

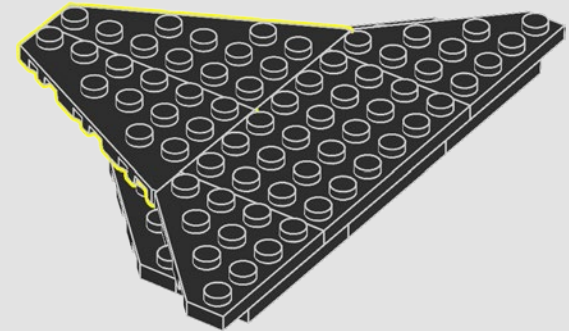

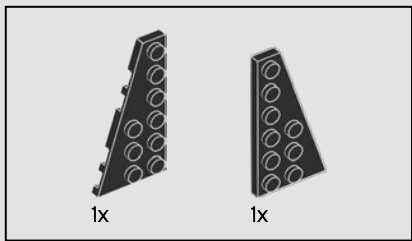

478

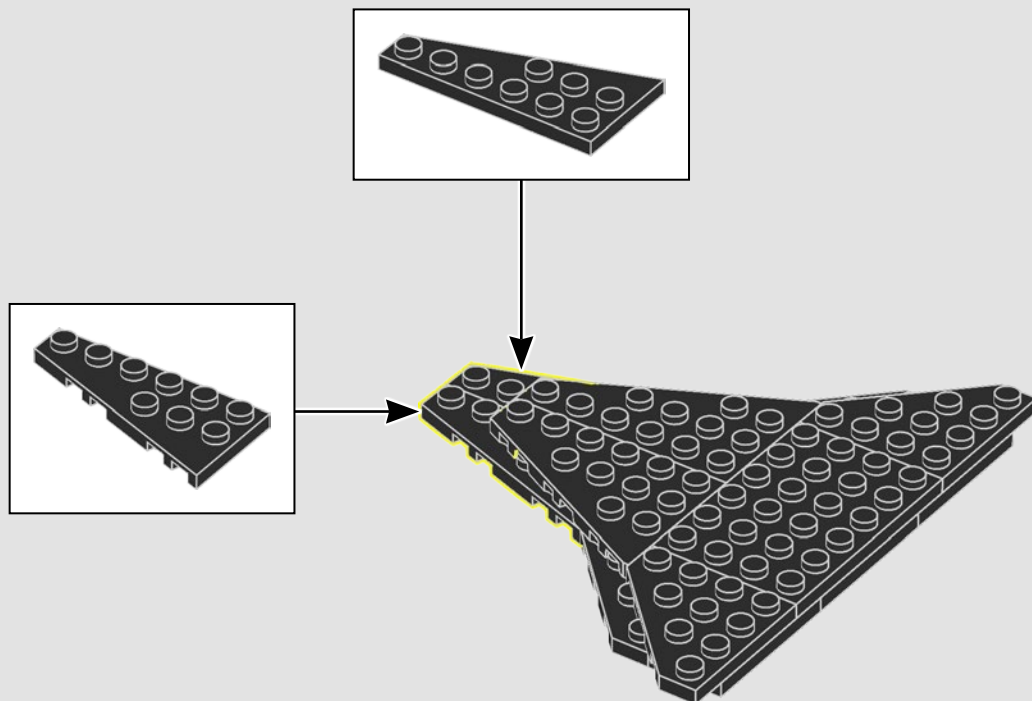

479

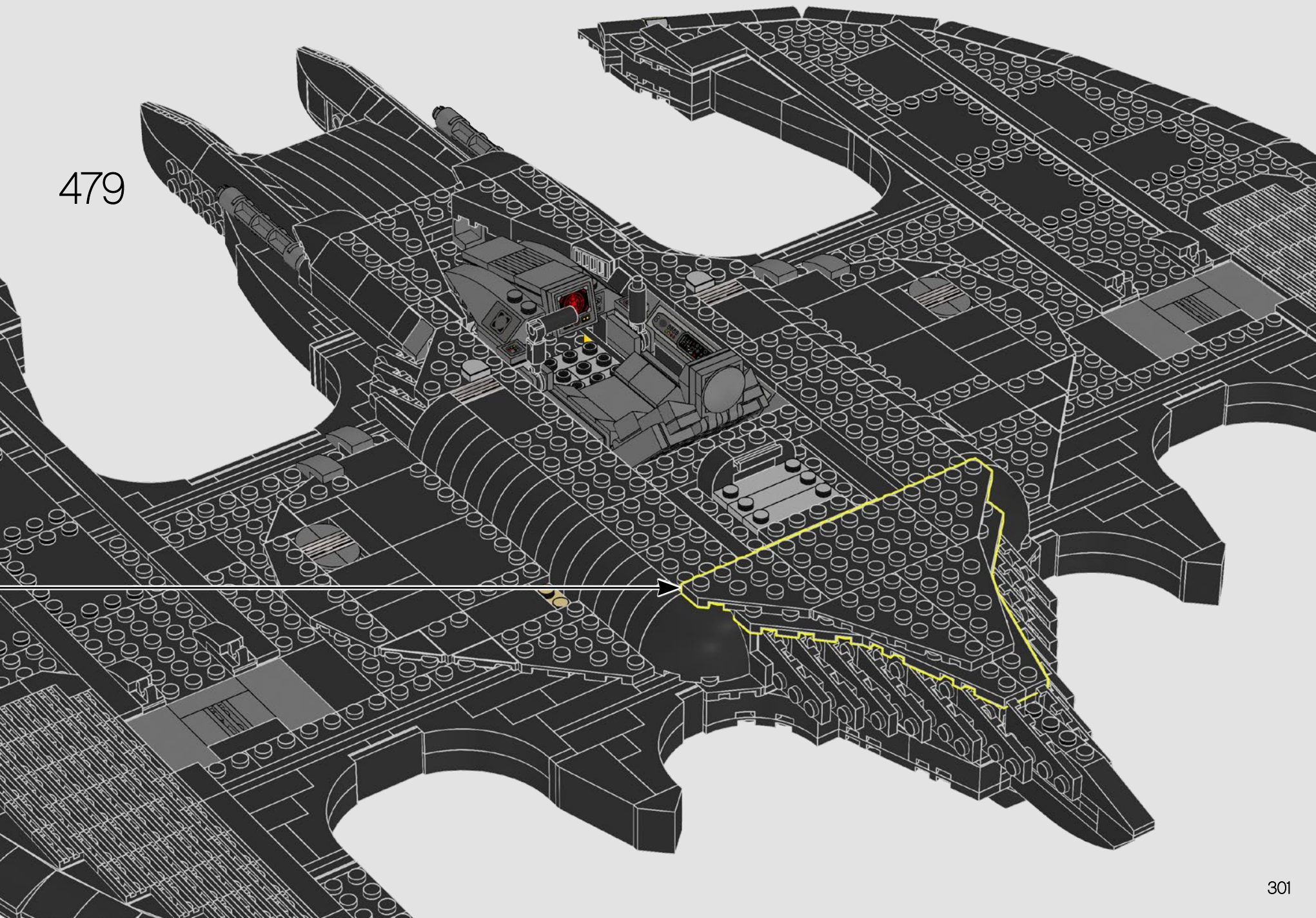

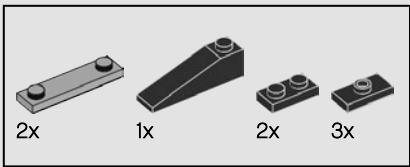

480

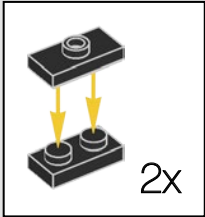
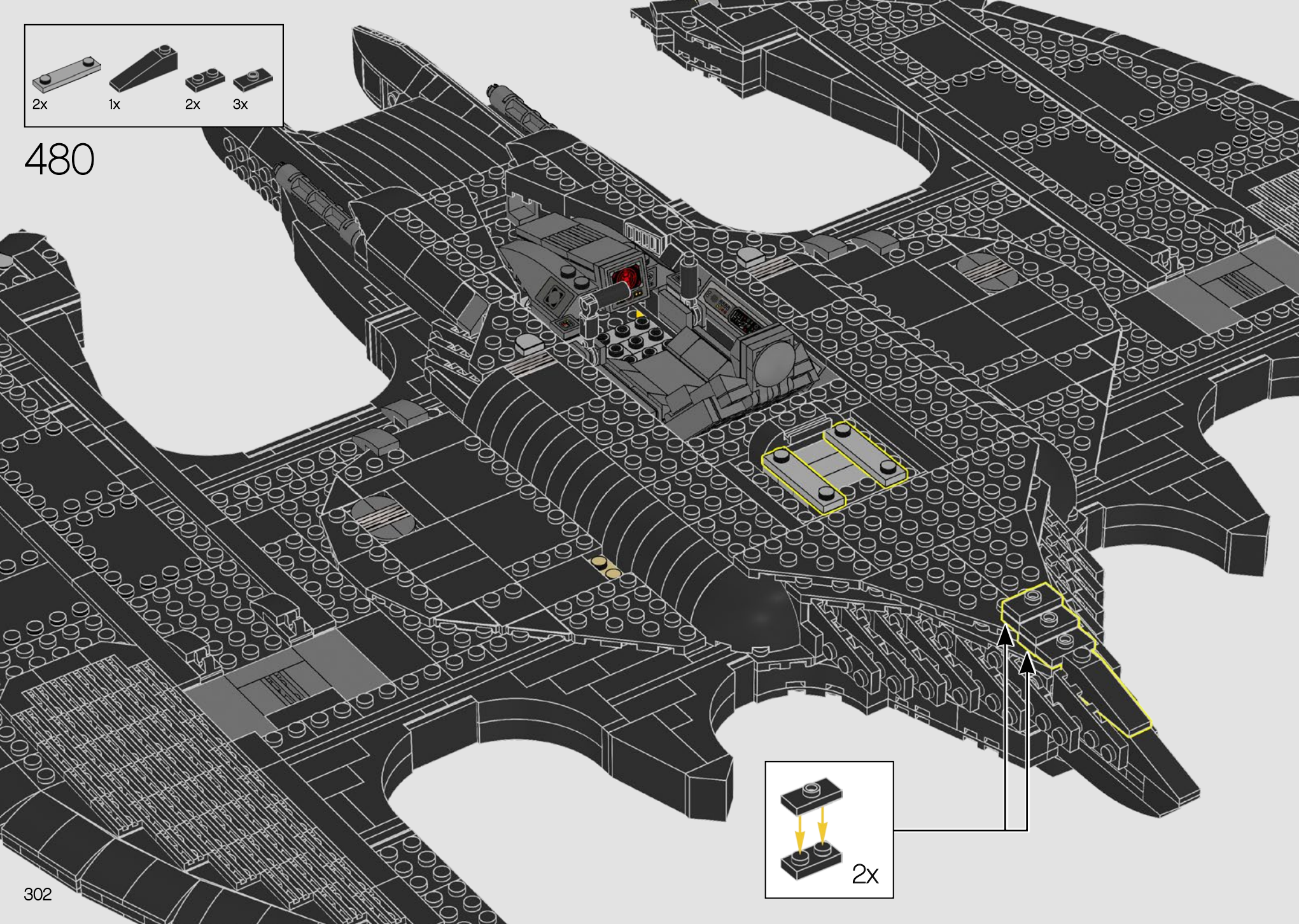

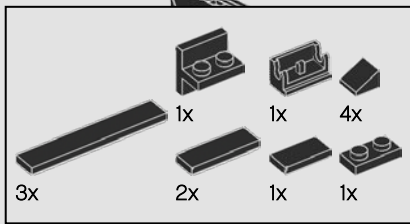

481

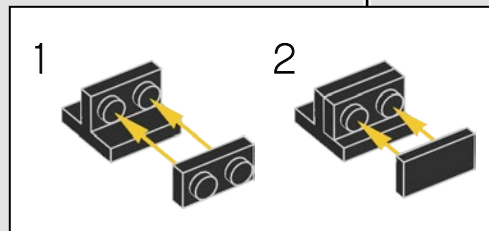
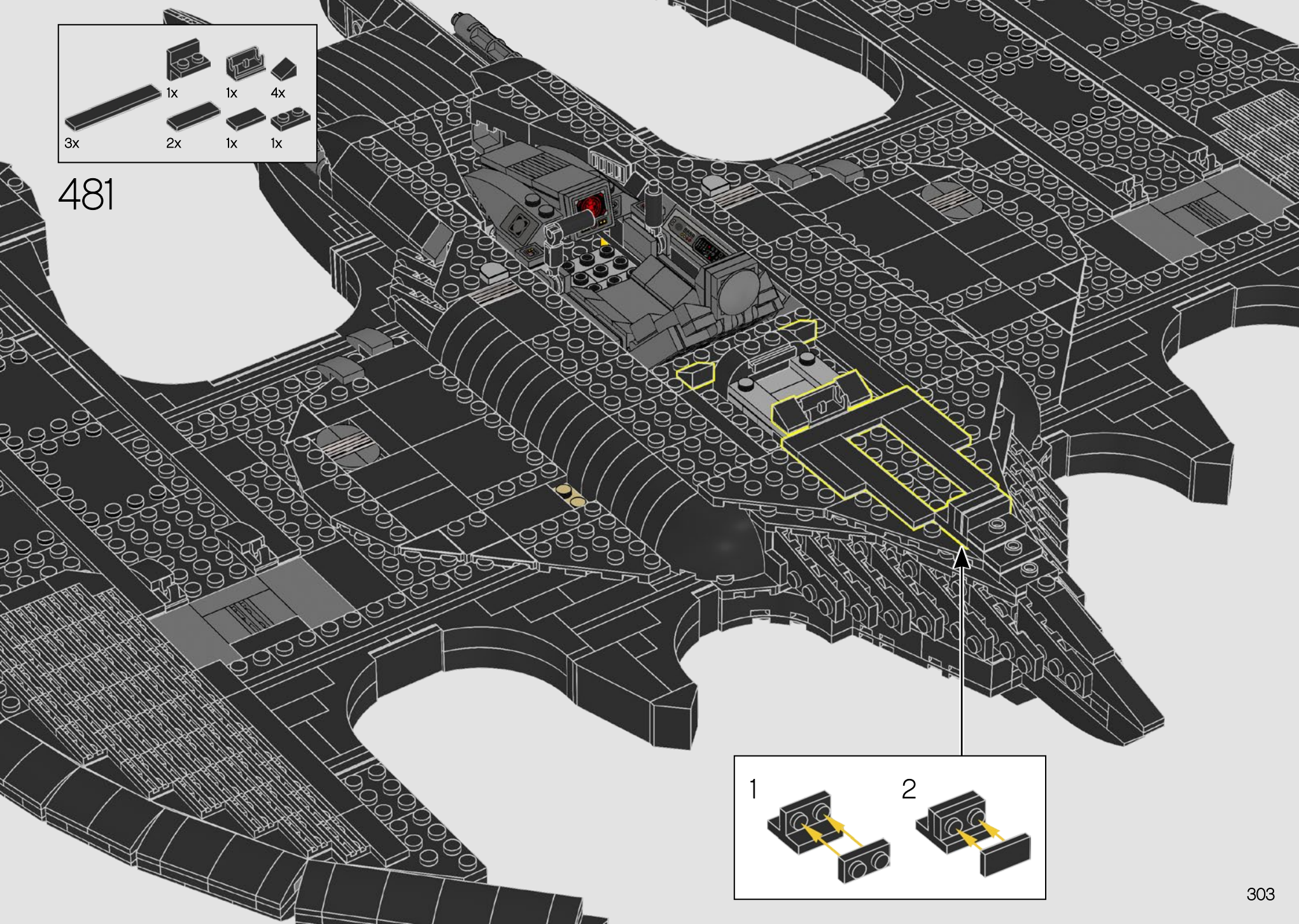

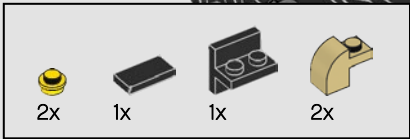

482

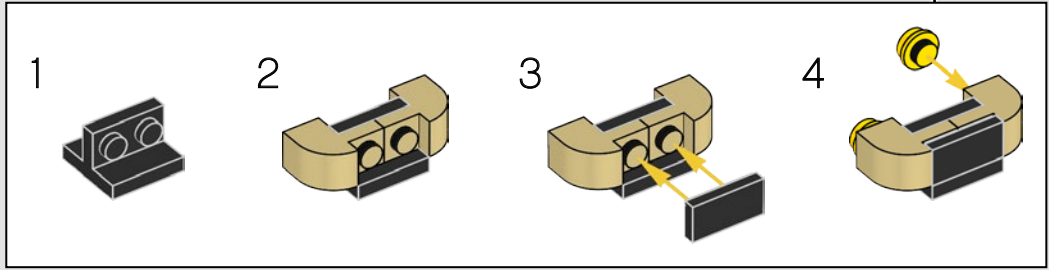
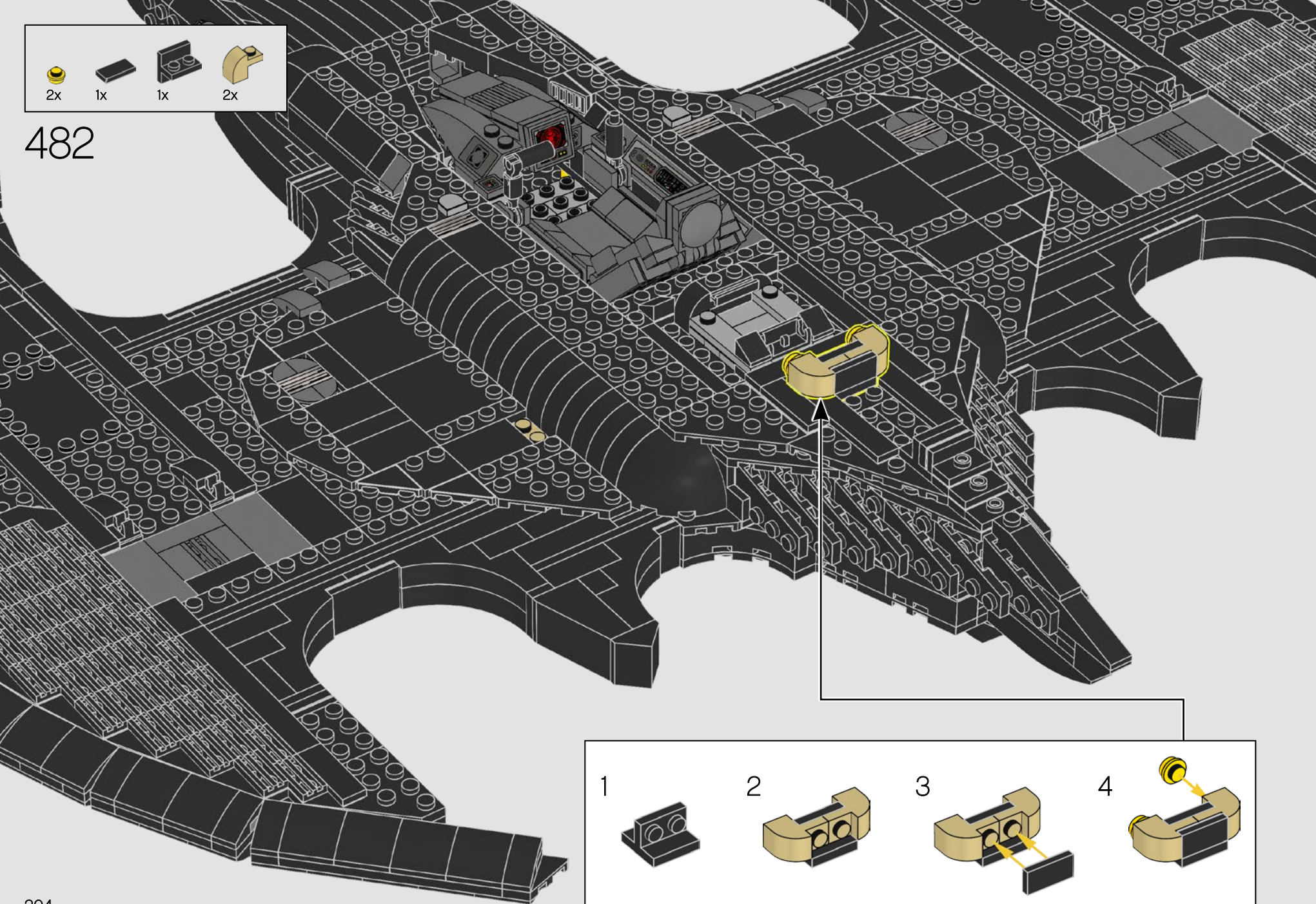



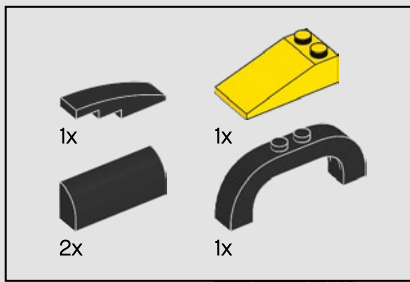

483

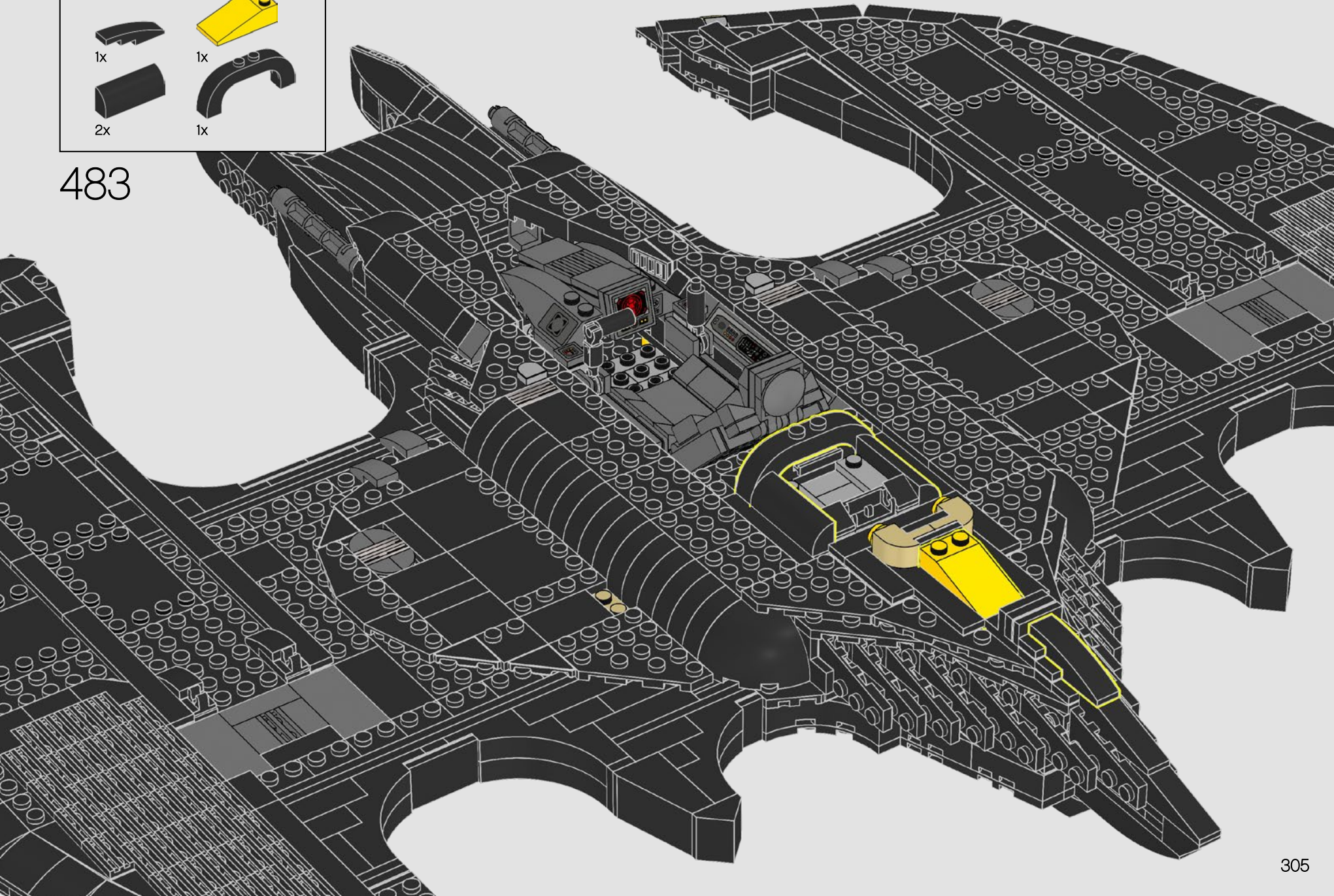

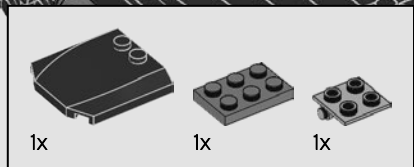

484

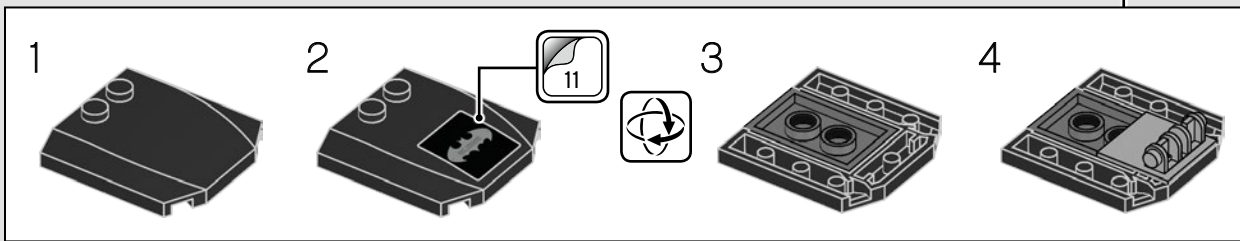
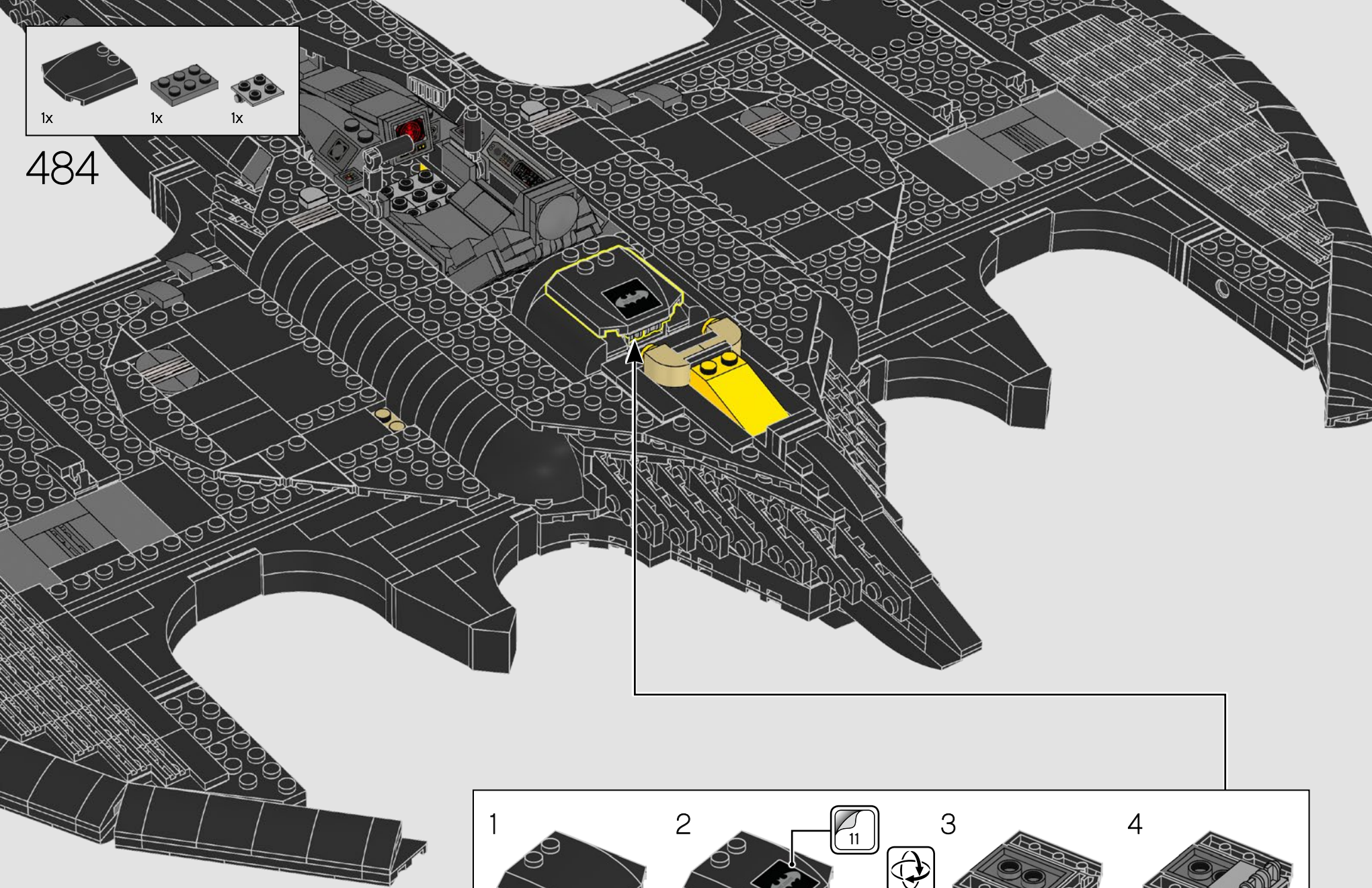

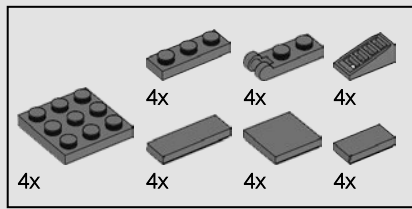

485

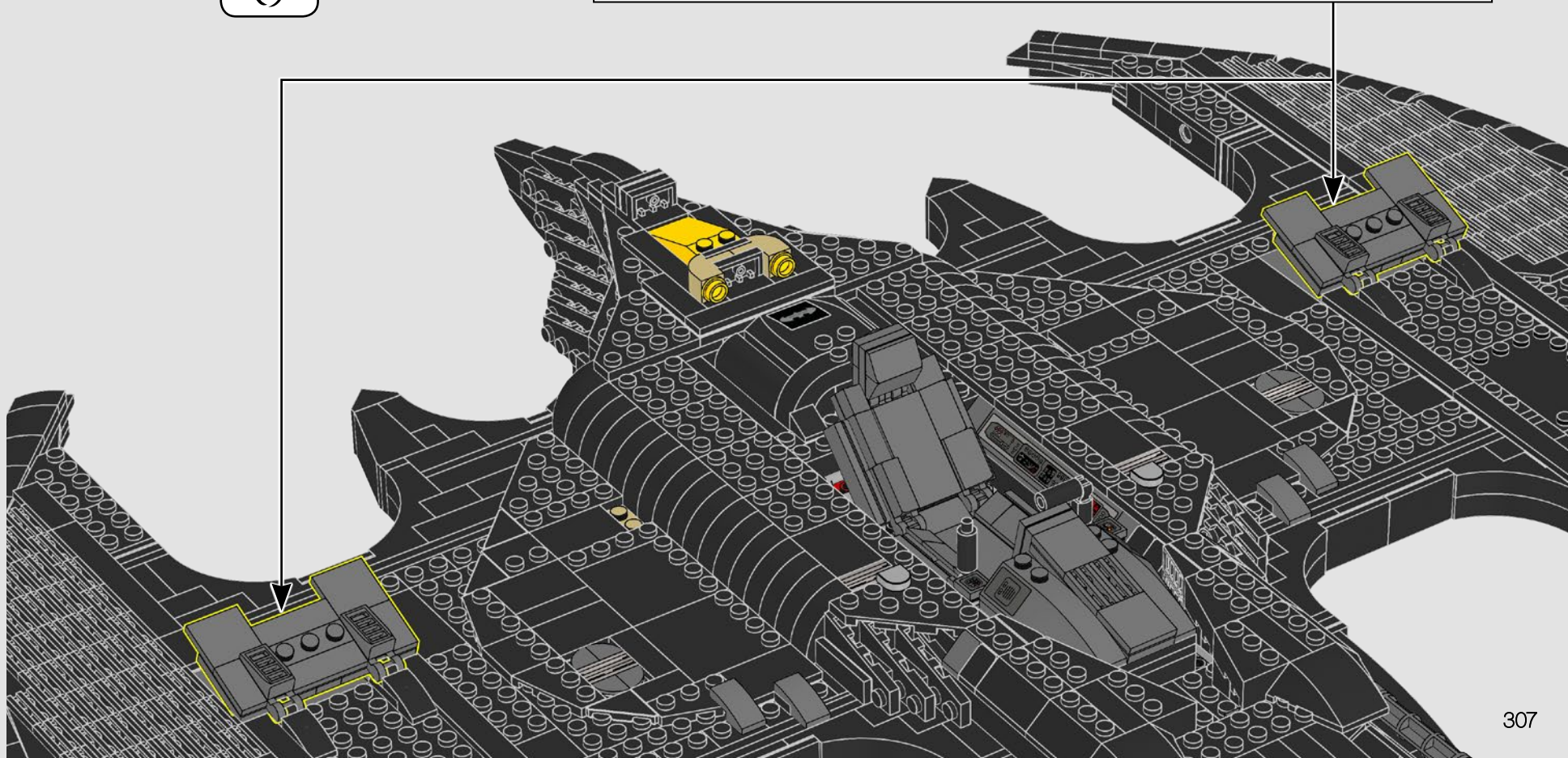
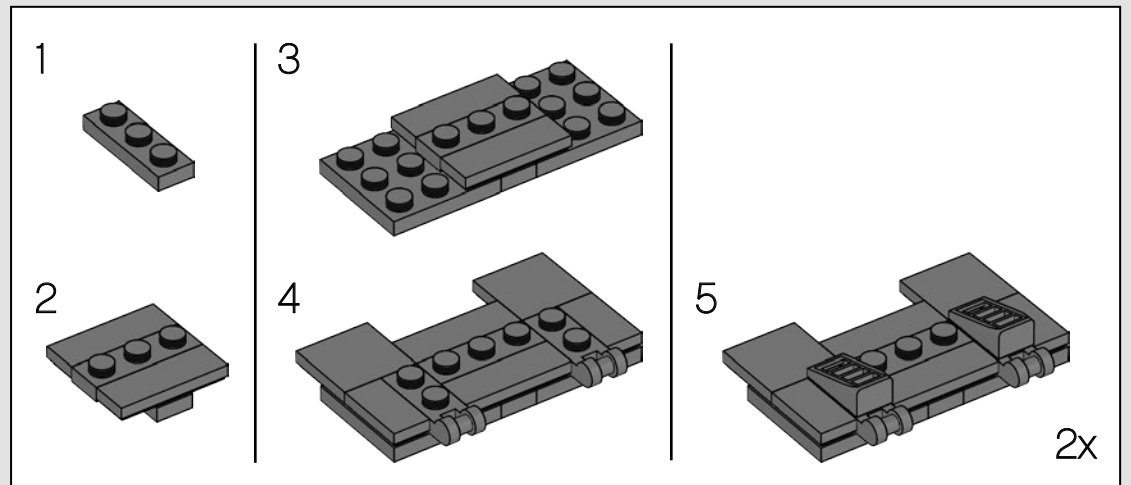

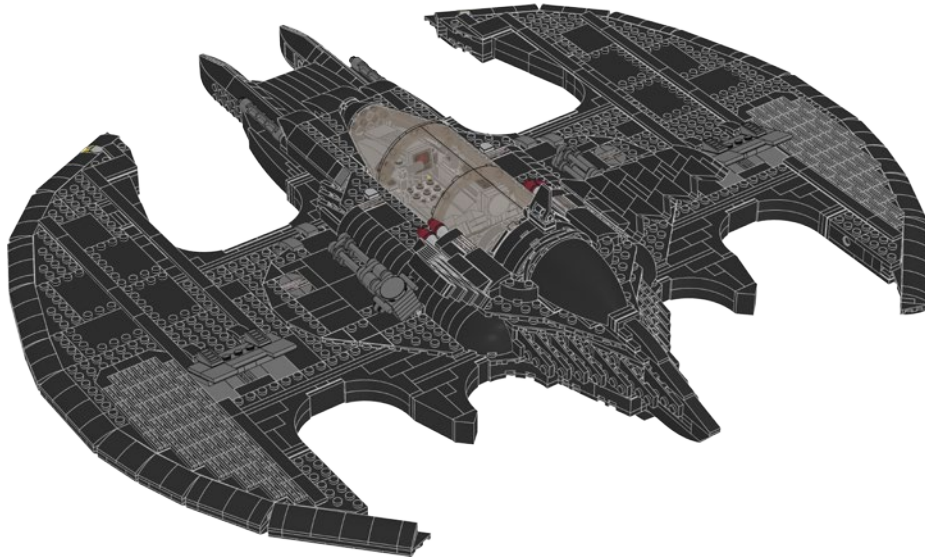
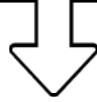



486

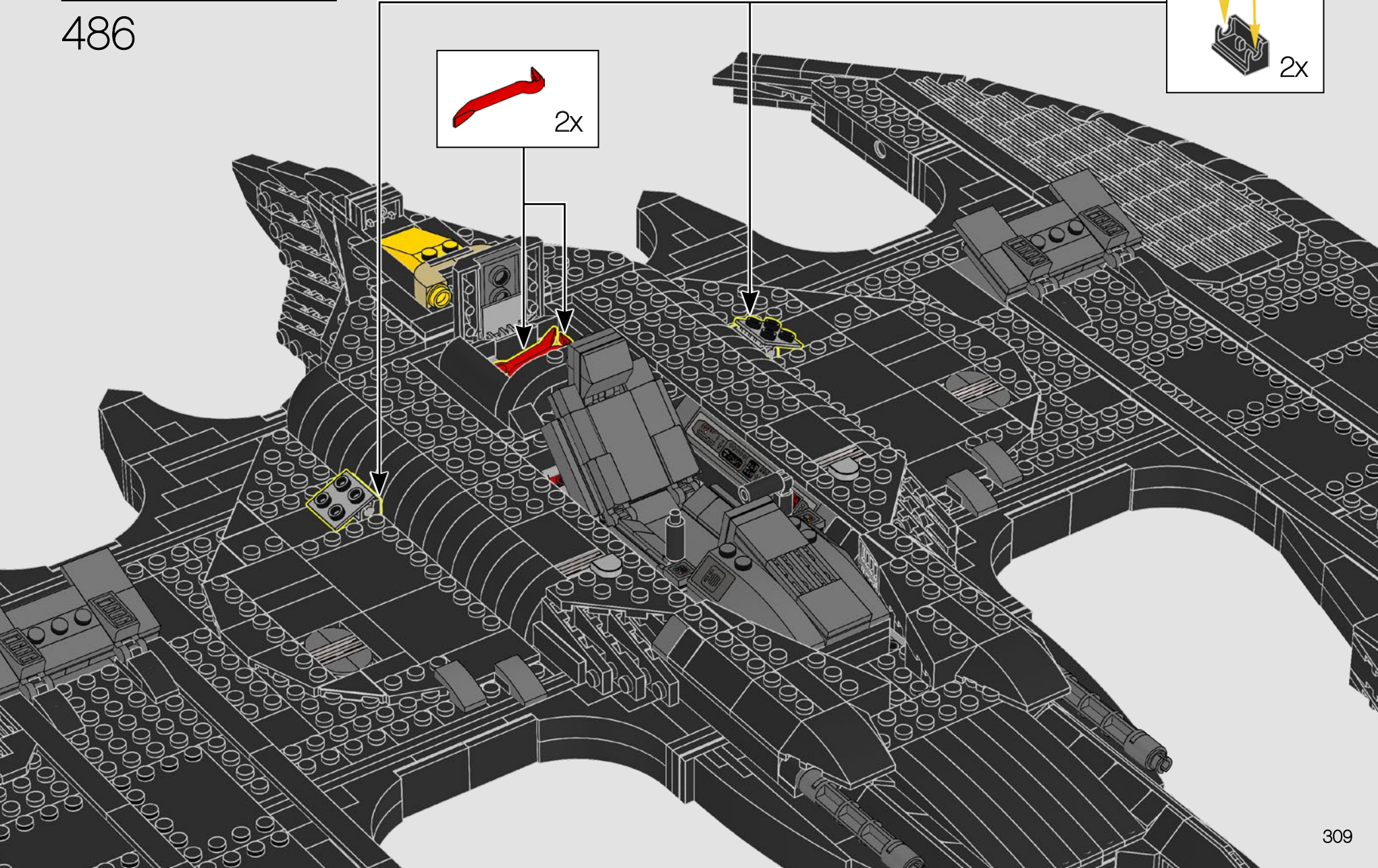
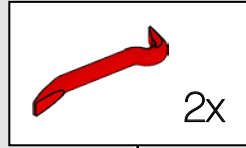
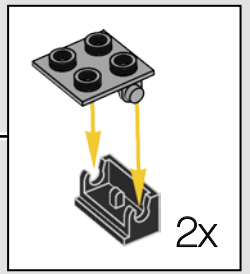

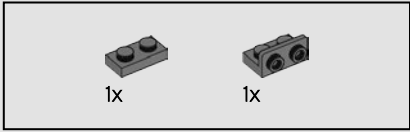
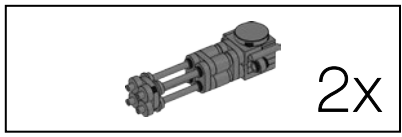

487

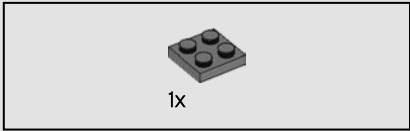
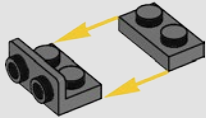

488

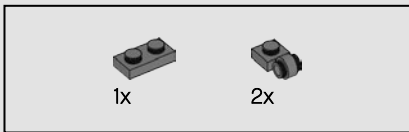
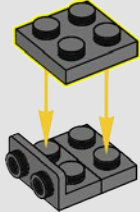

489

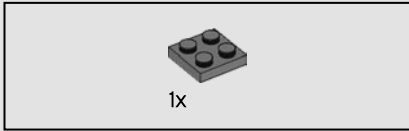
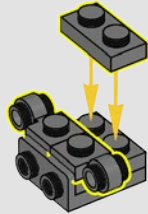

490

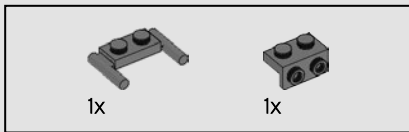
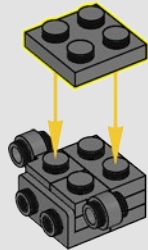

491

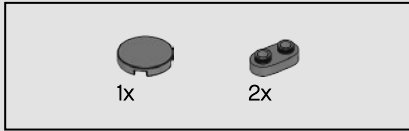
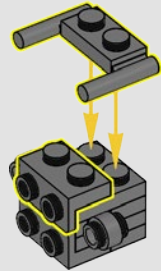

492

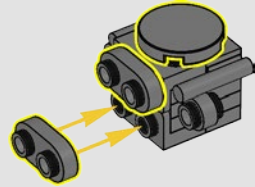

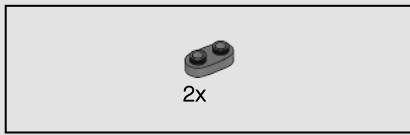

493

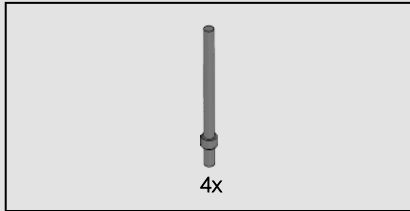
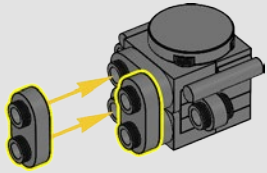

494

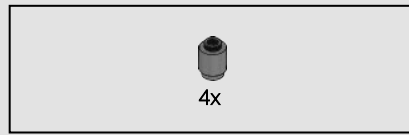
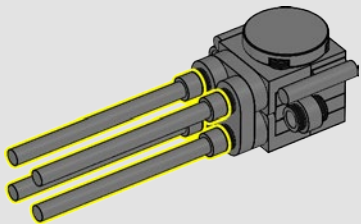

495

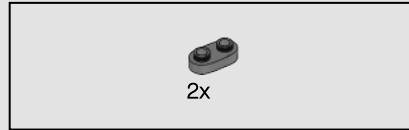
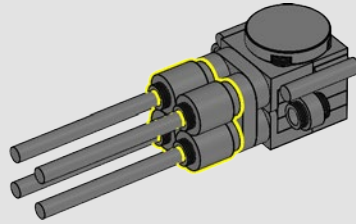

496

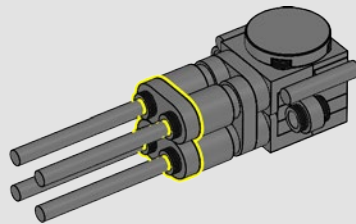

497

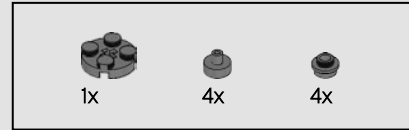
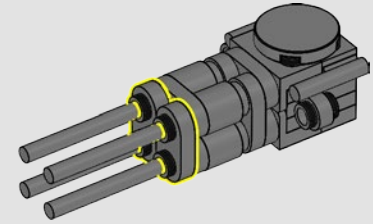

498

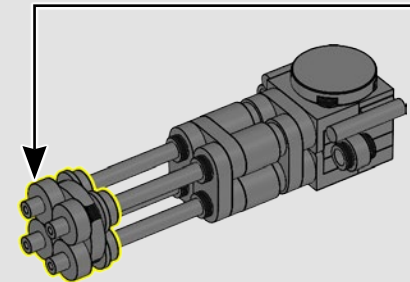
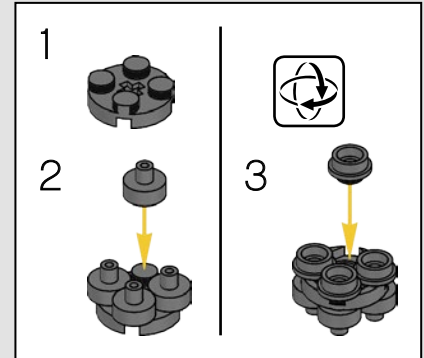

2x

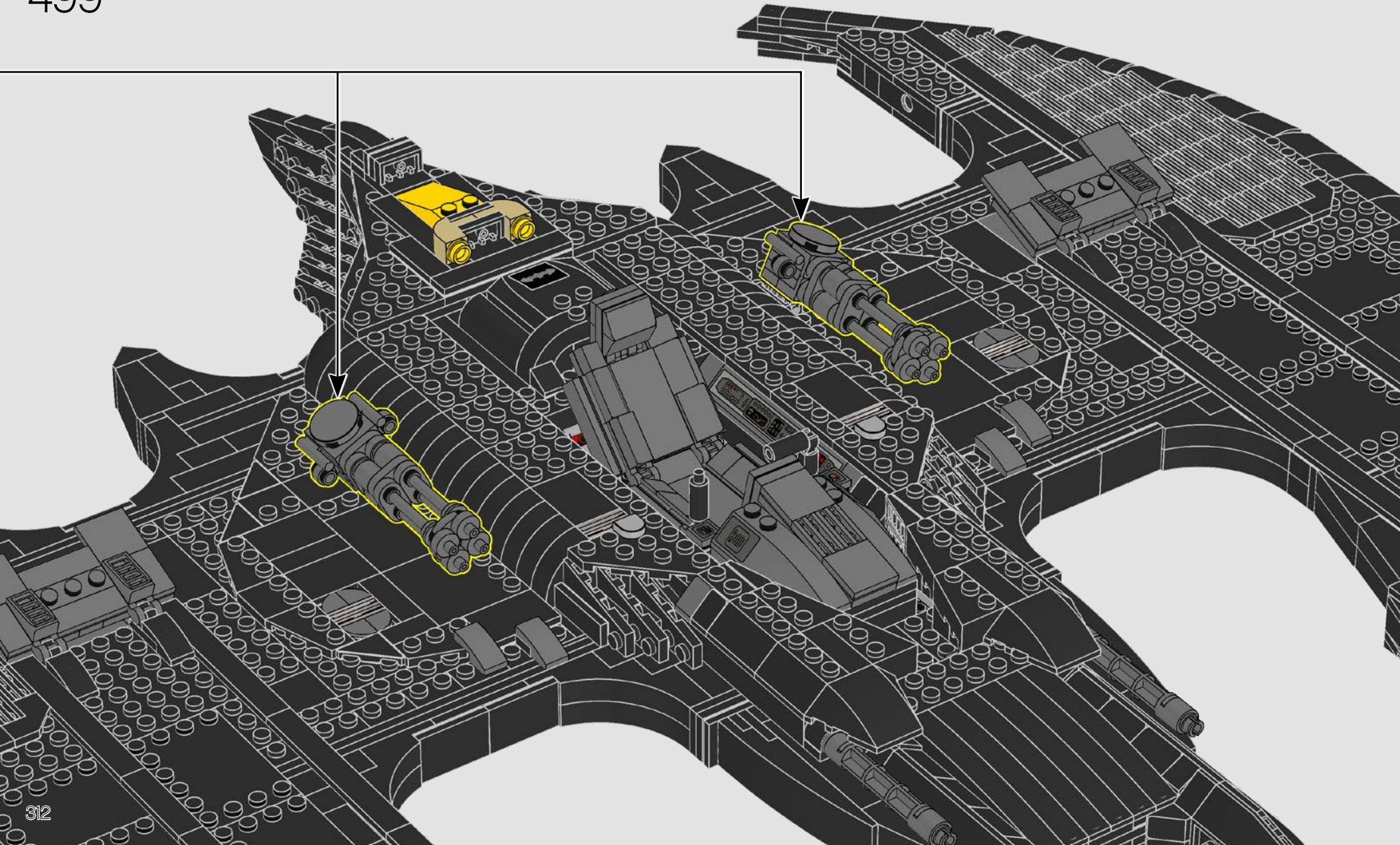





8x

500

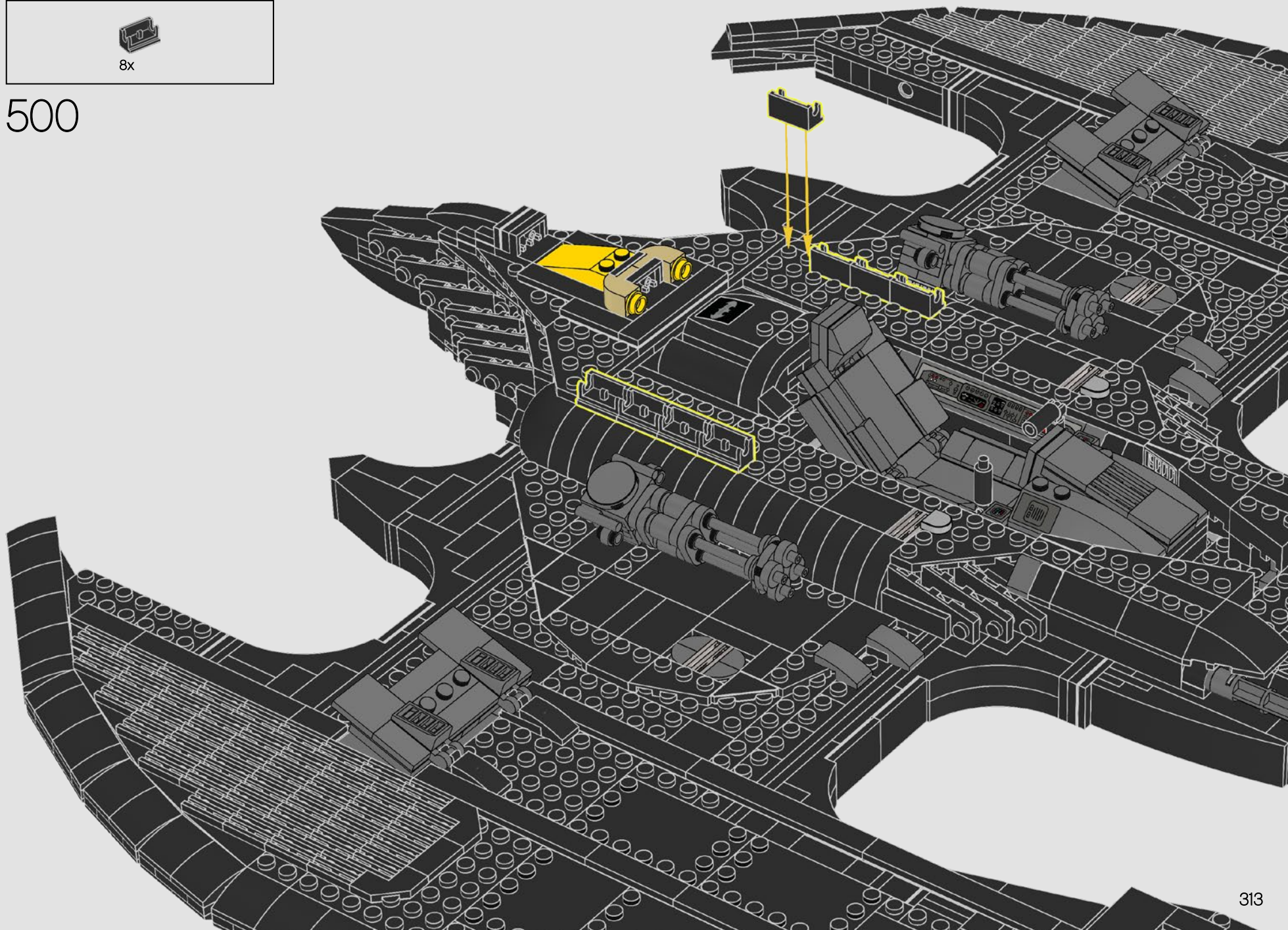

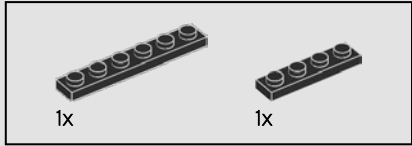
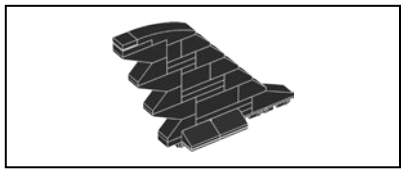

501

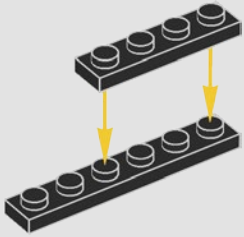

502

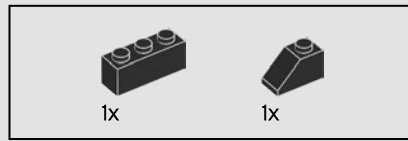
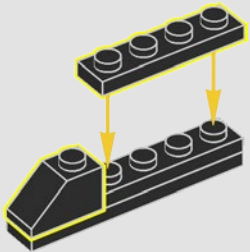

503

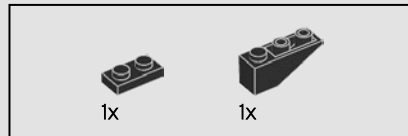
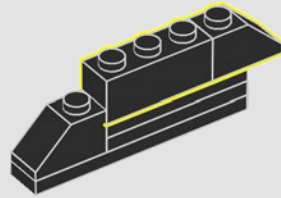

504

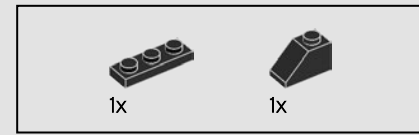
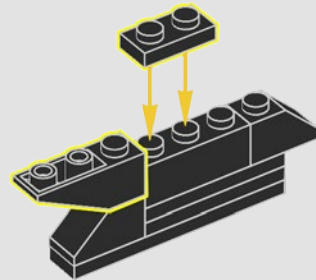

505

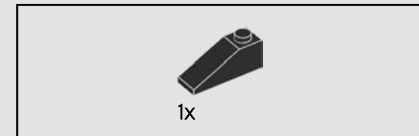
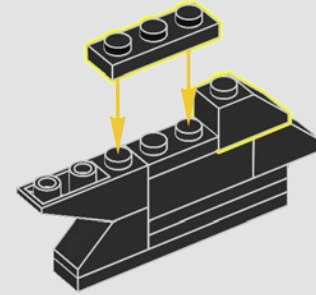

506

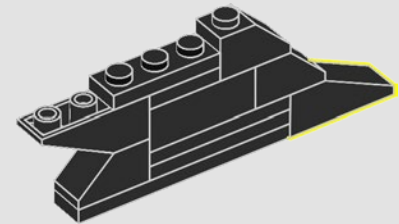

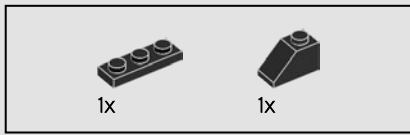

507

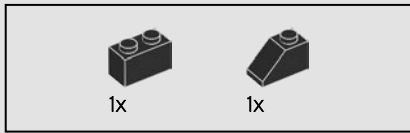
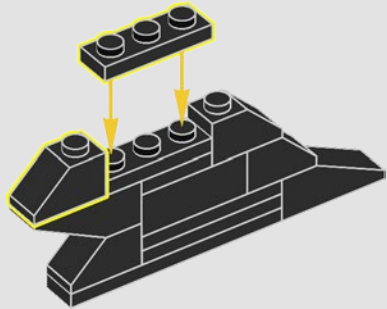

508

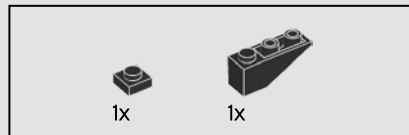
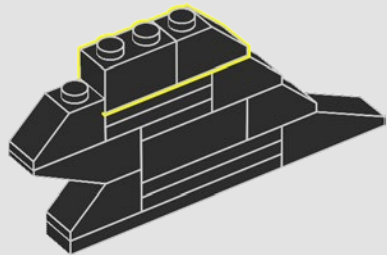

509

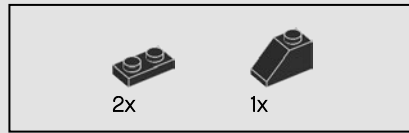
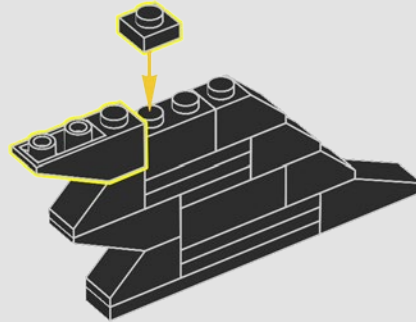

510

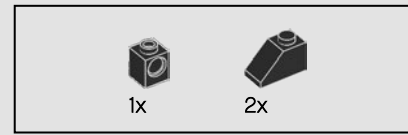
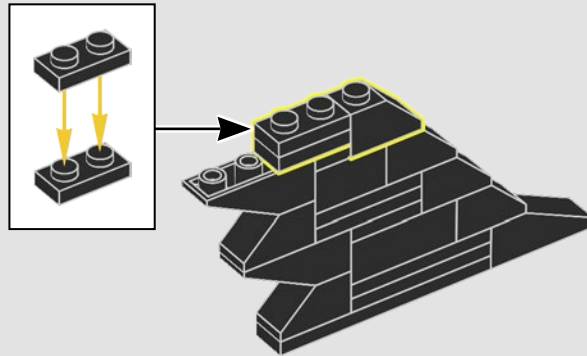

511

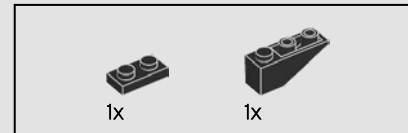
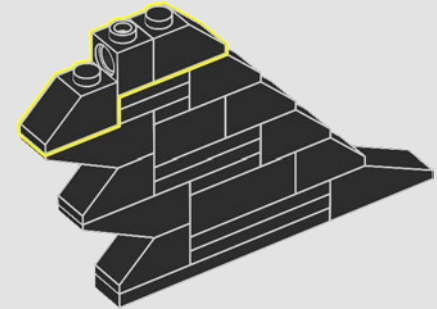

512

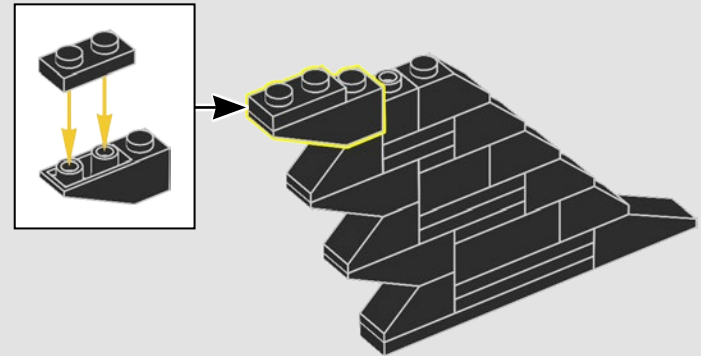

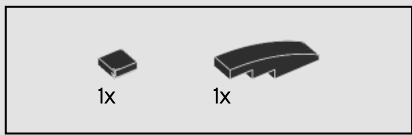

513

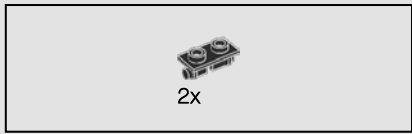
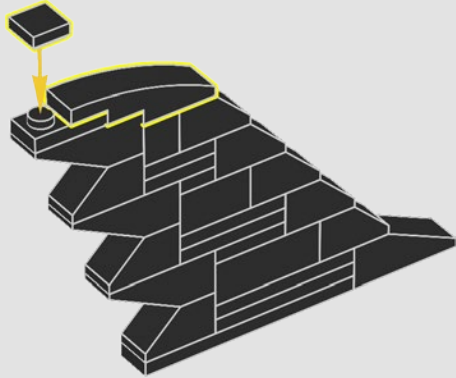

514

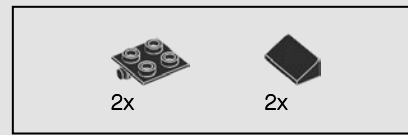
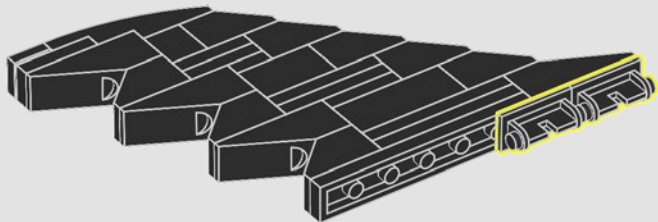

515

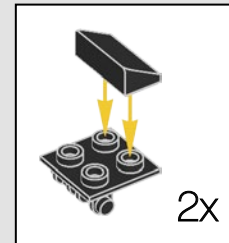
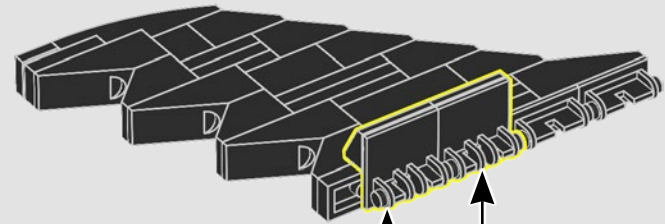

516

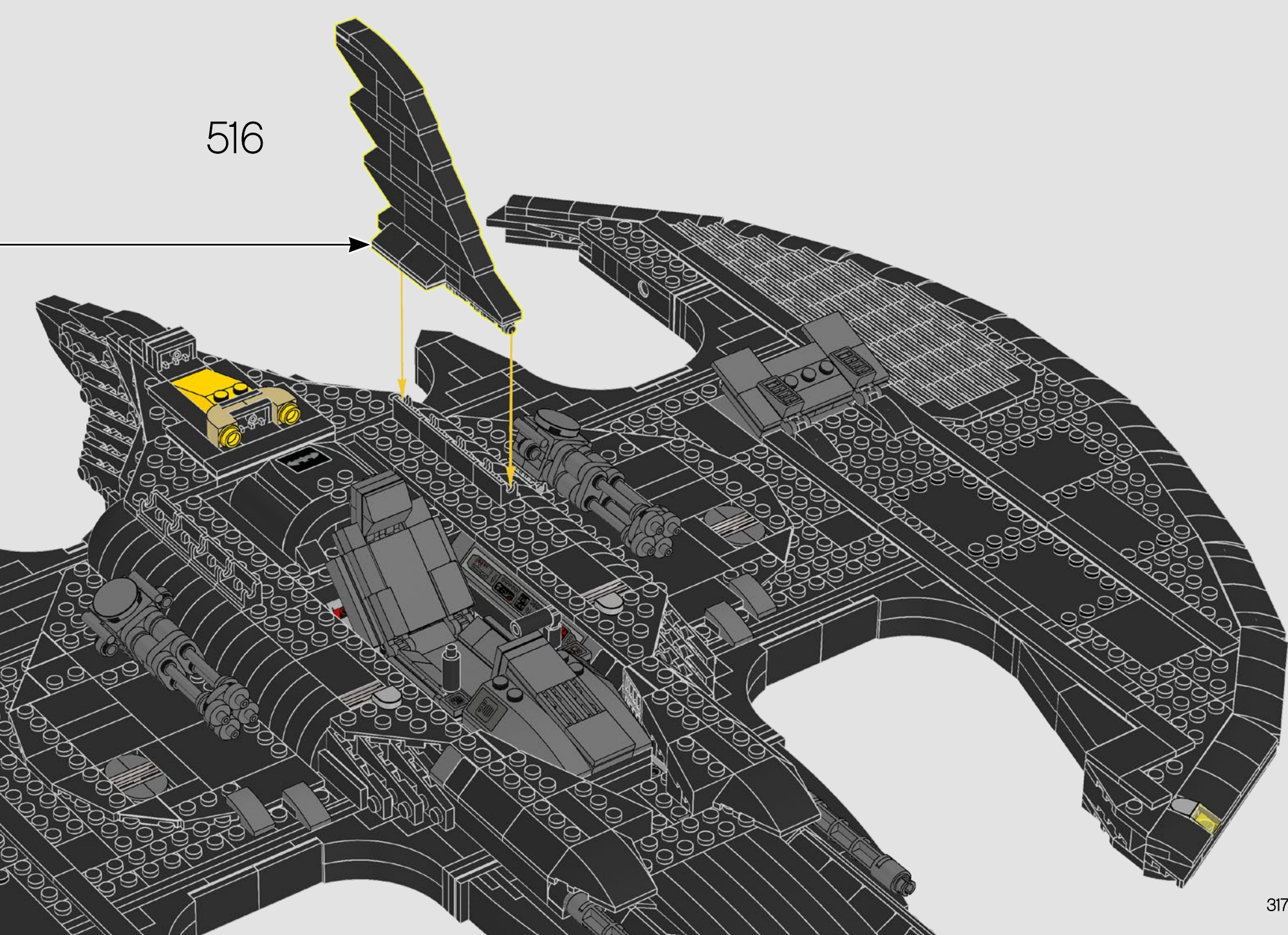

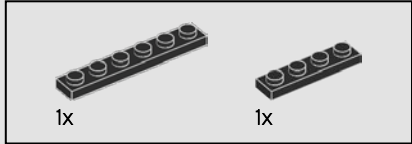
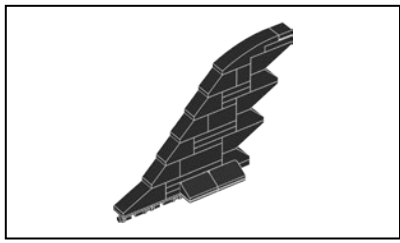

517

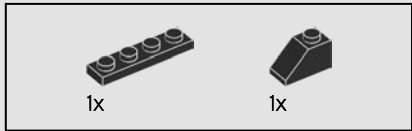
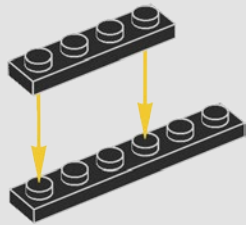

518

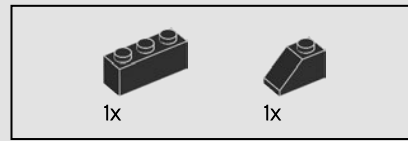
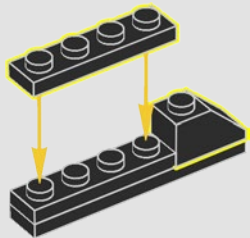

519

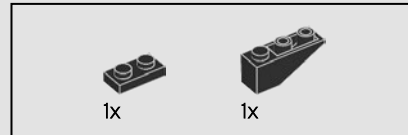
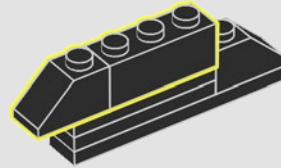

520

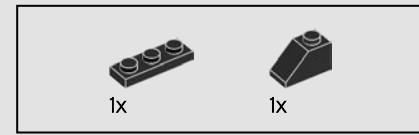
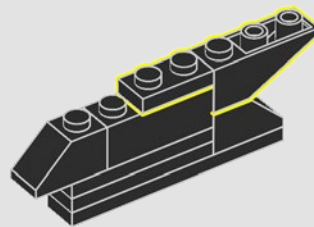

521

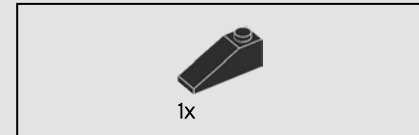
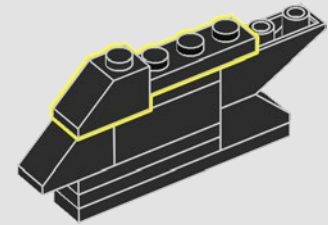

522

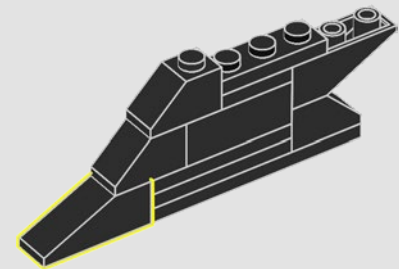

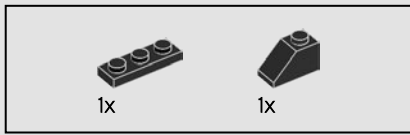

523

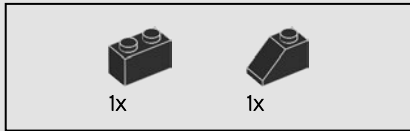
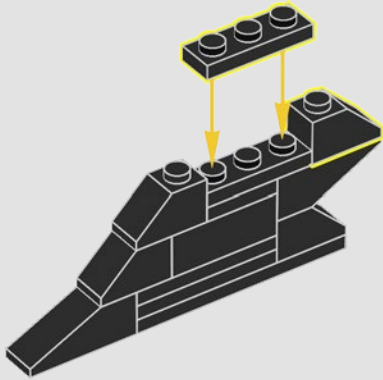

524

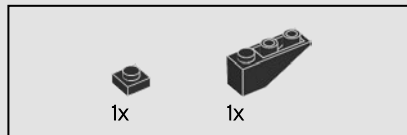
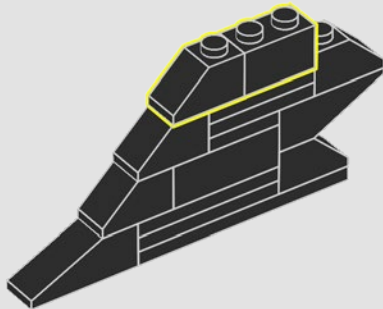

525

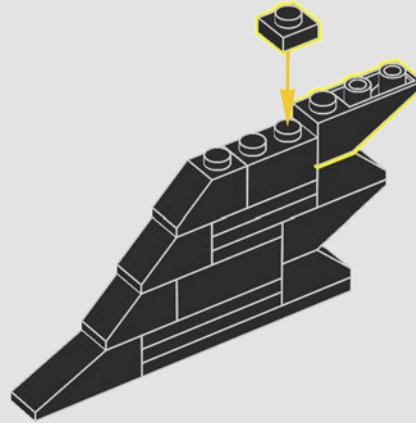

526

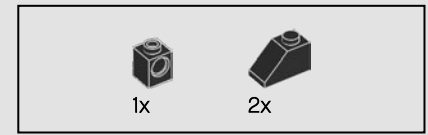
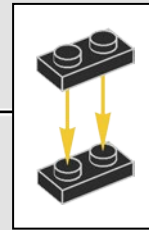
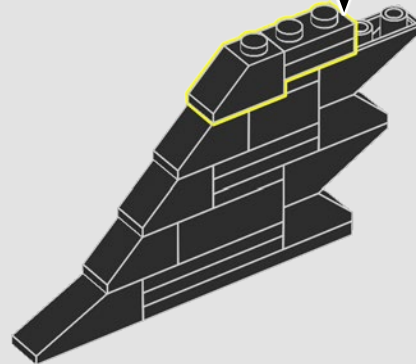

527

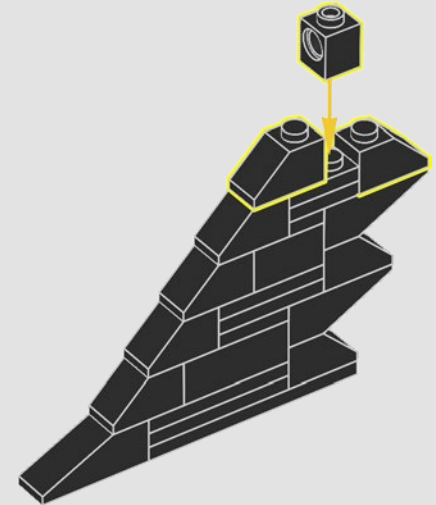

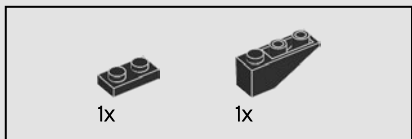

528

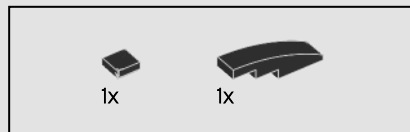
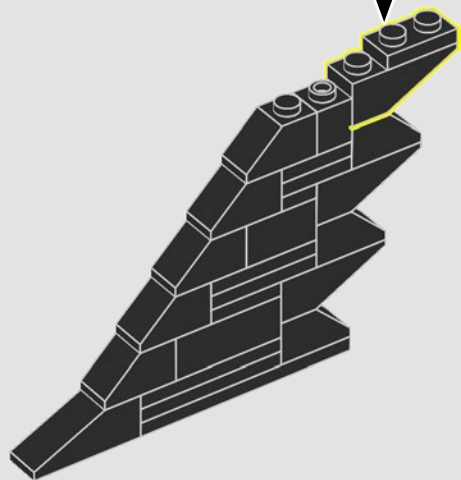
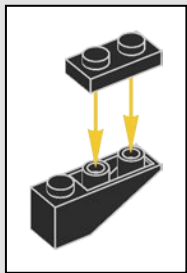

529

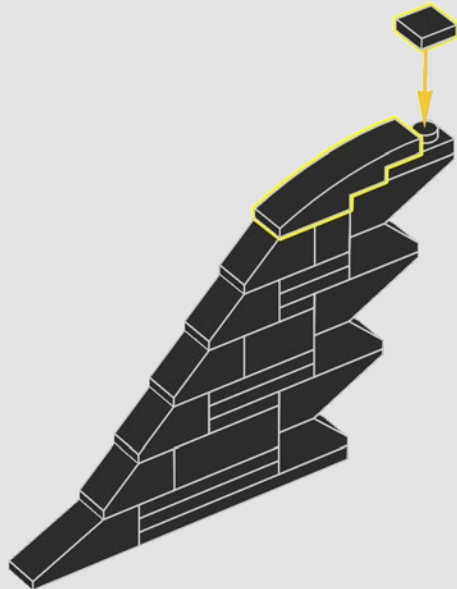

530

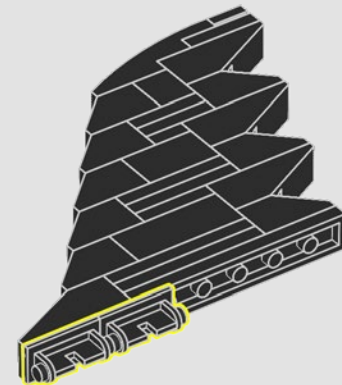
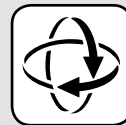

531

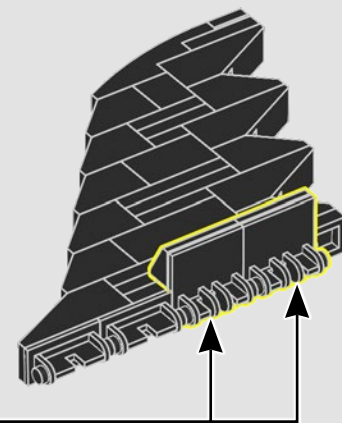
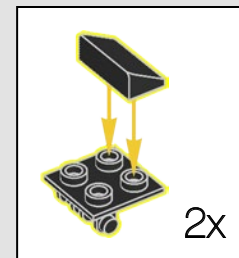



532

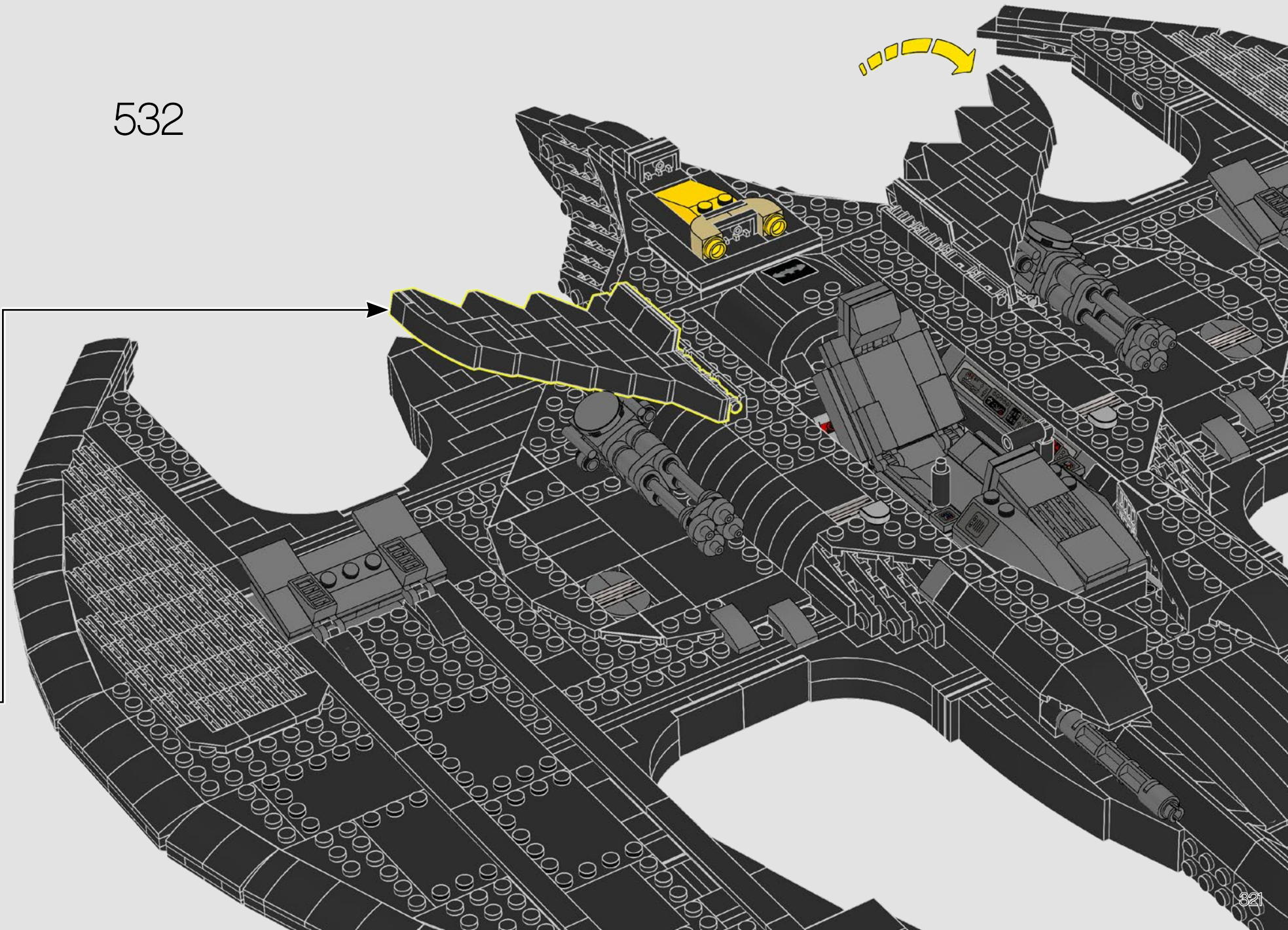

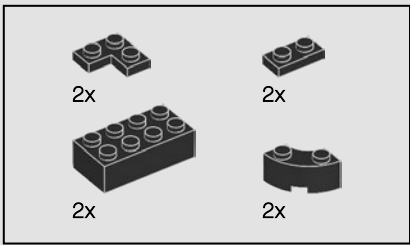

533

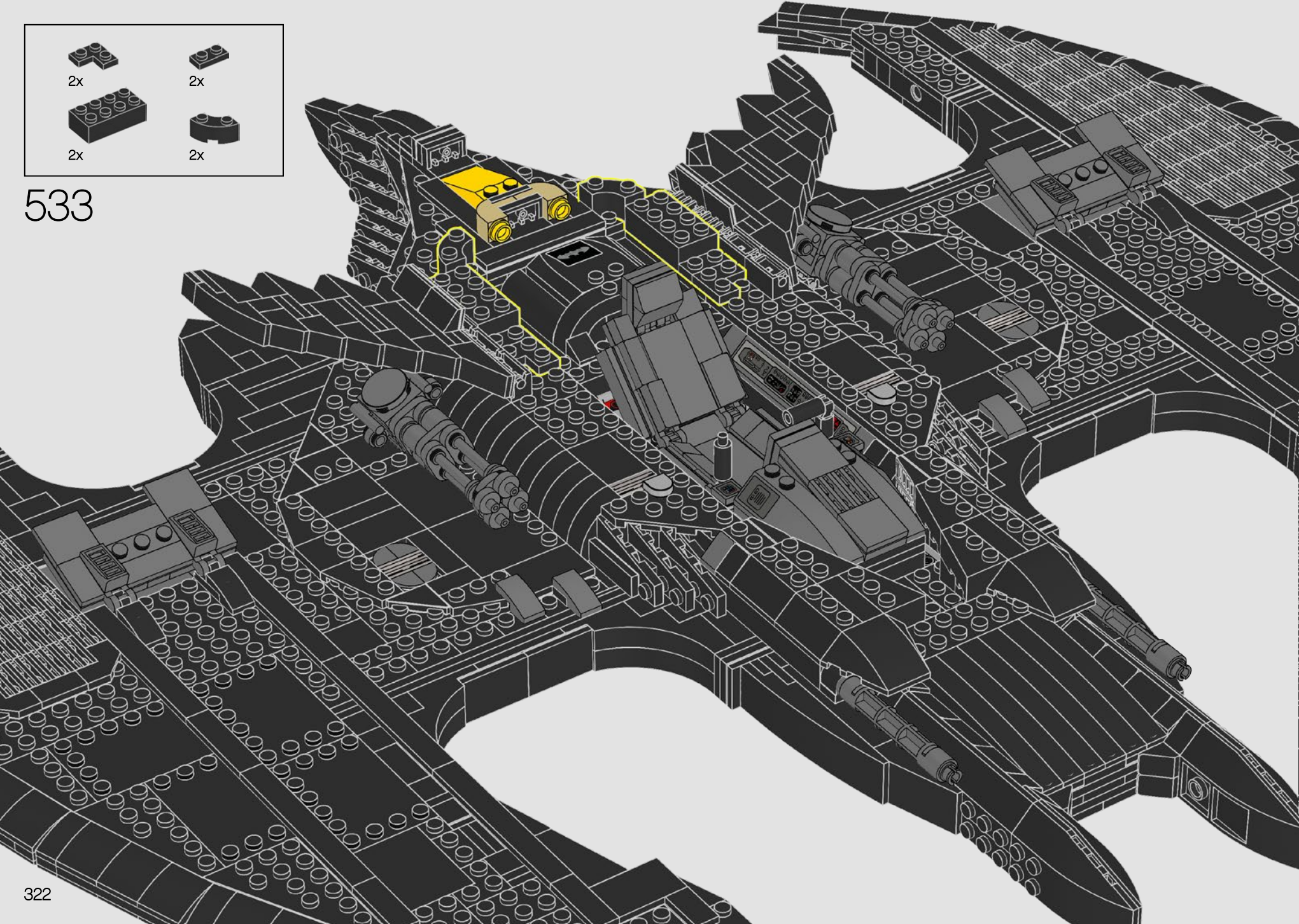

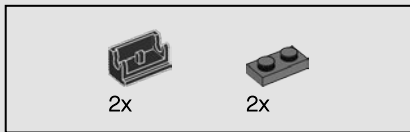

534





535

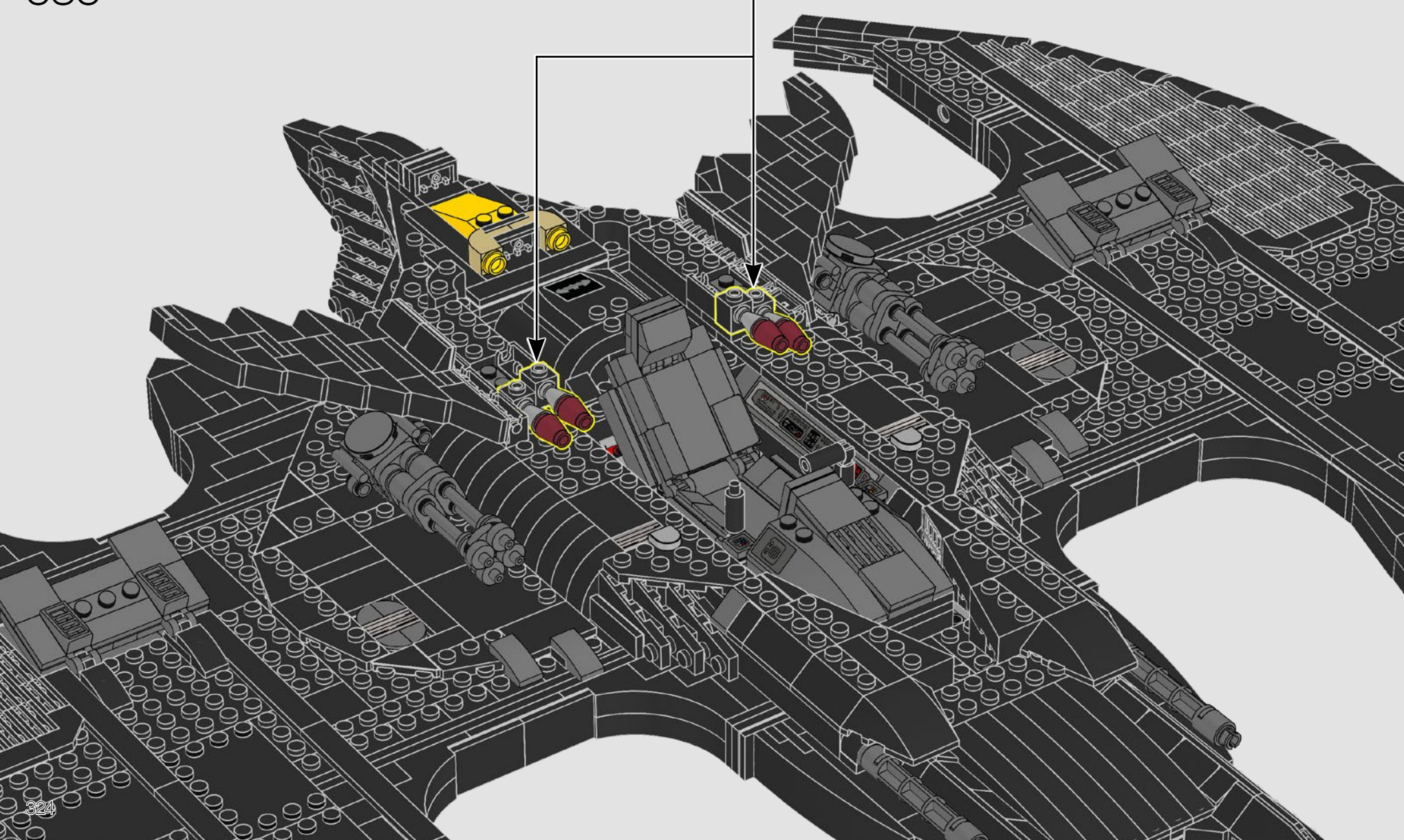
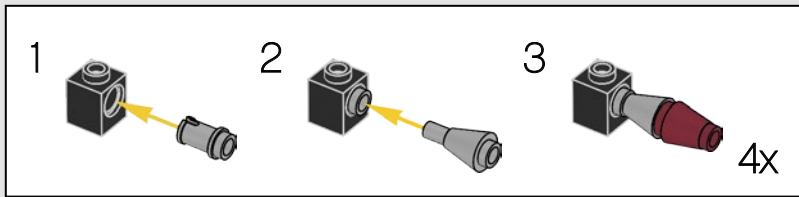

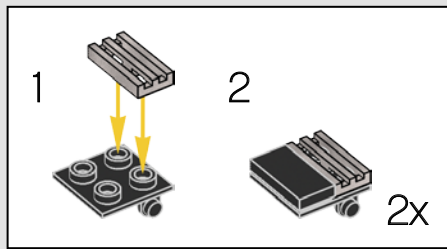
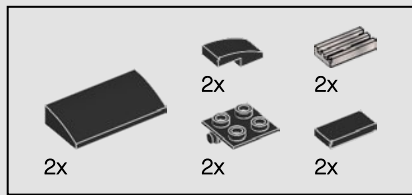

536

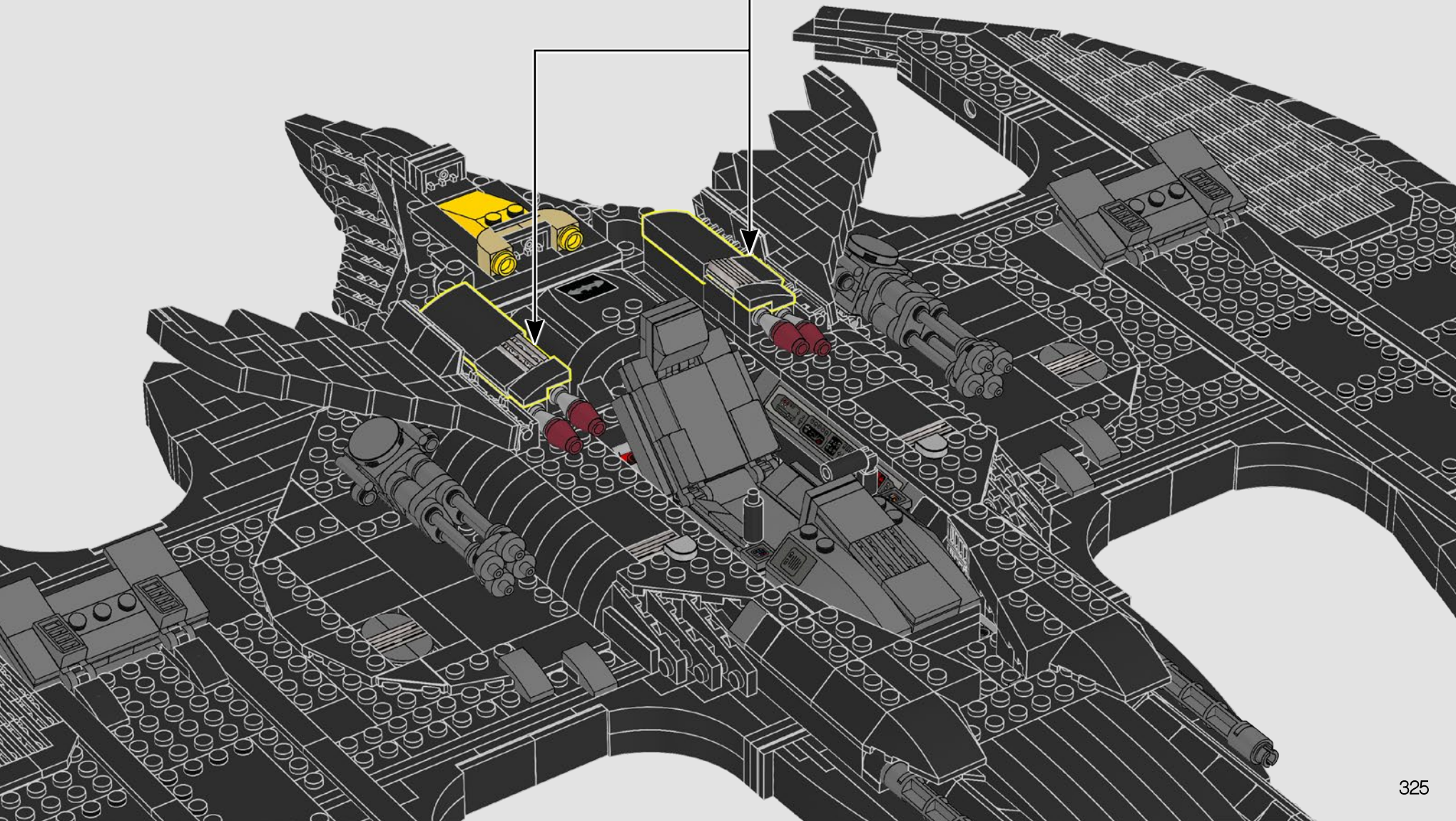

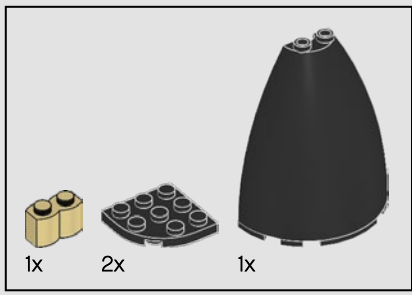

537

1

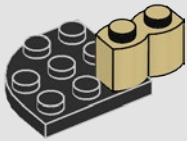

2

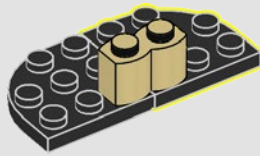

3

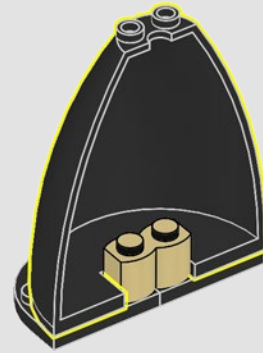

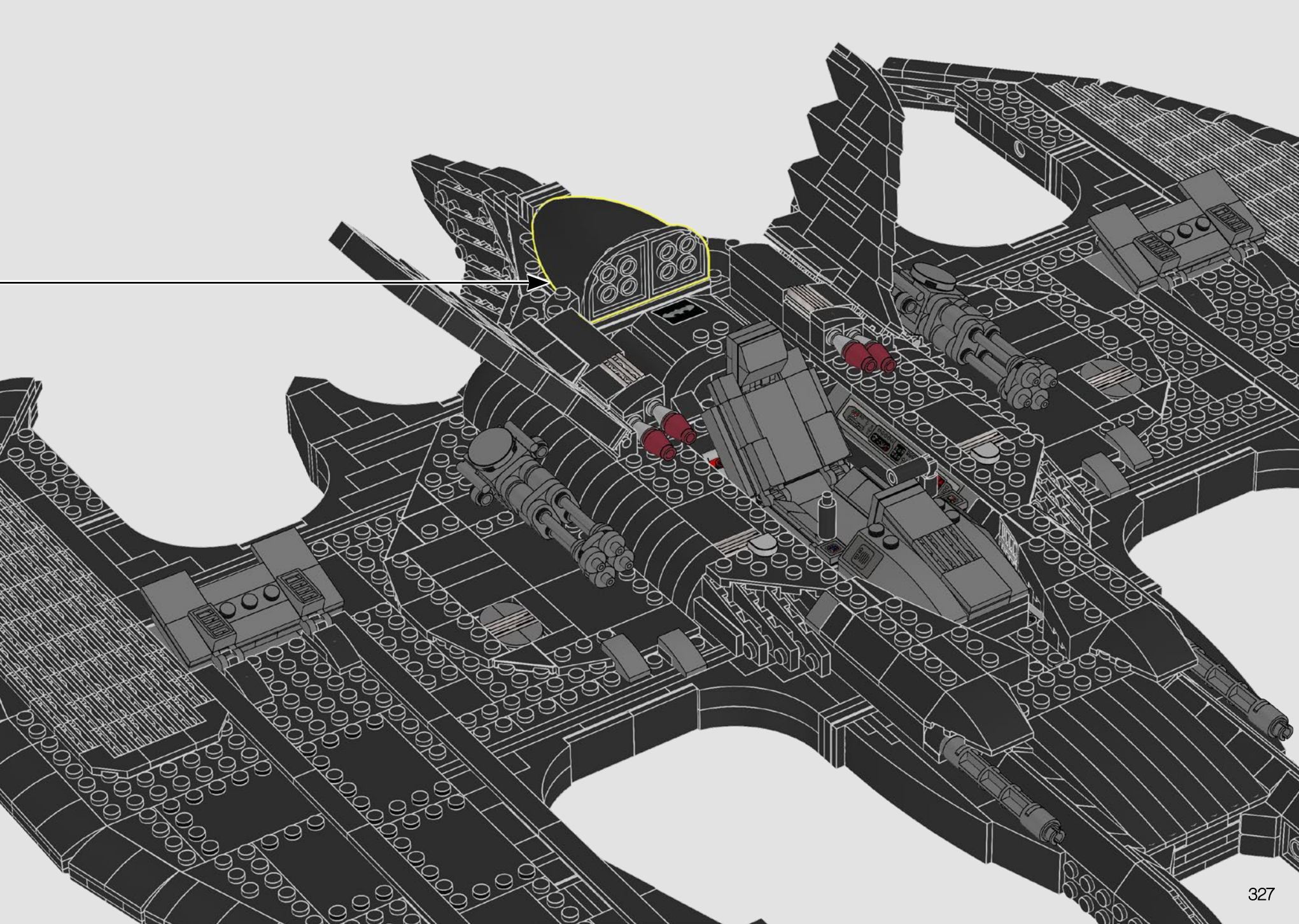

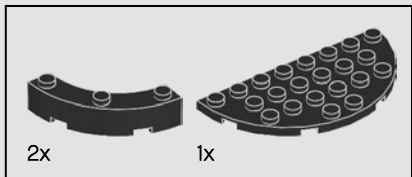
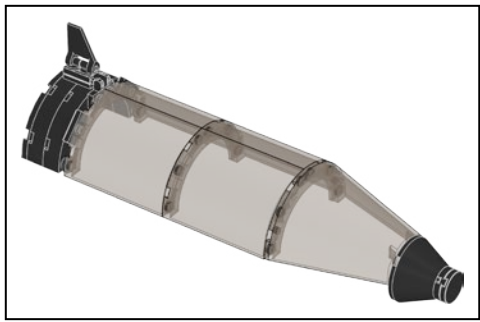

538

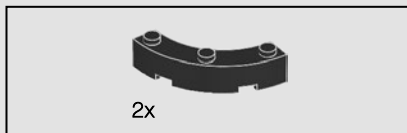
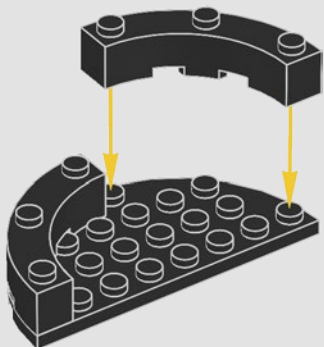

539

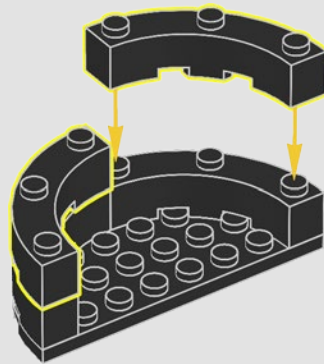

540

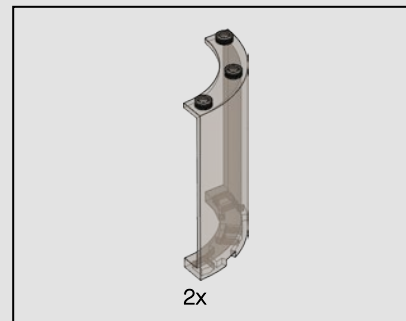
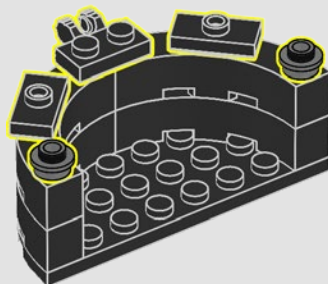

541

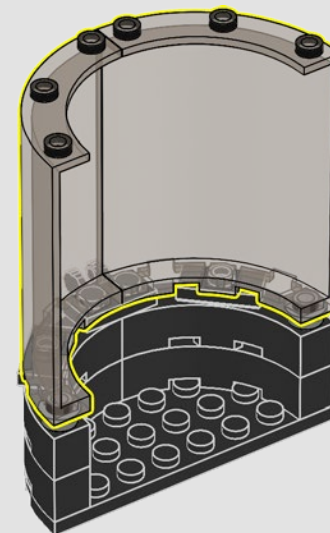



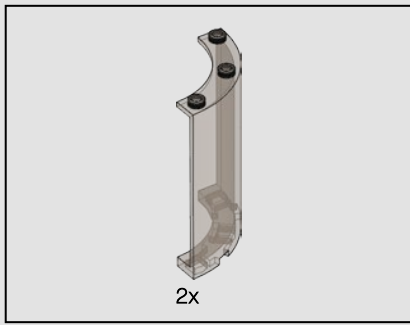

542

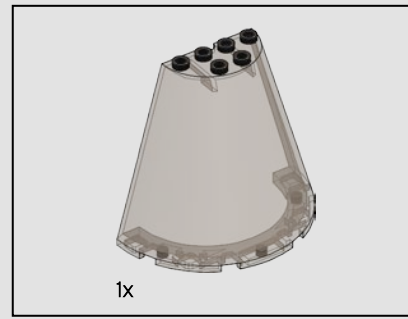
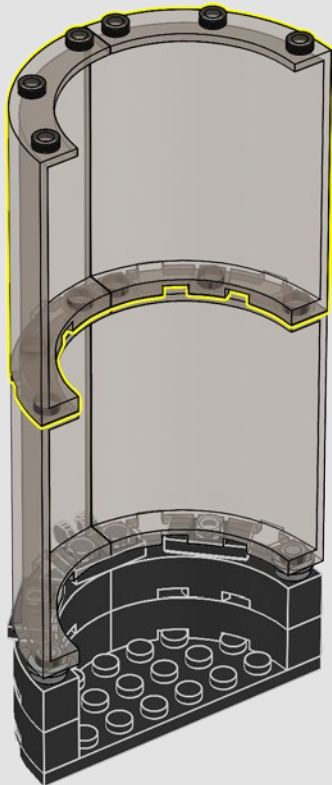

543

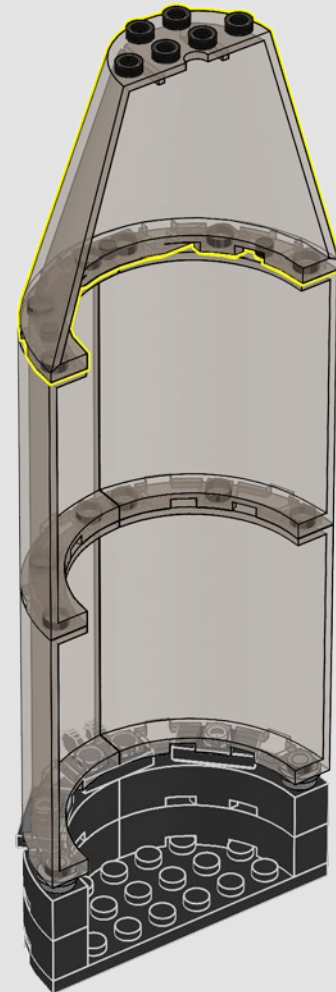

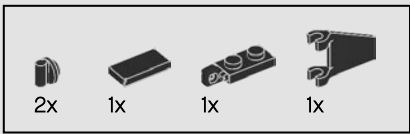

544

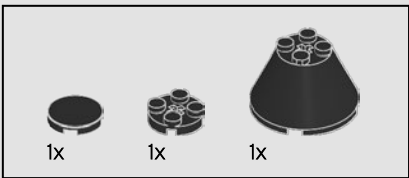
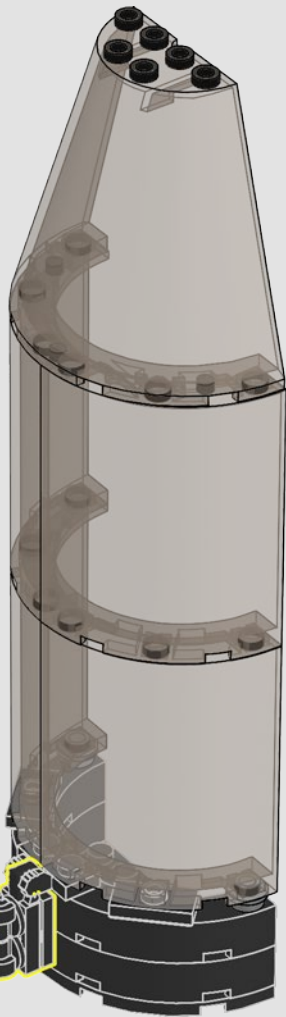
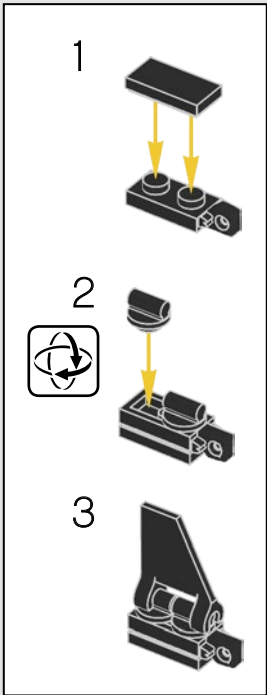

545

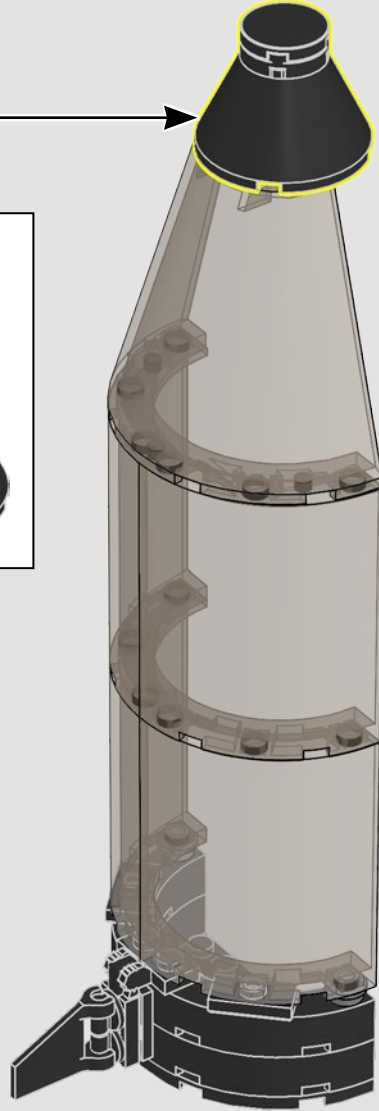
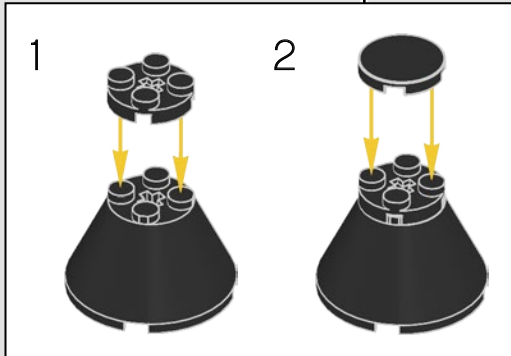

546

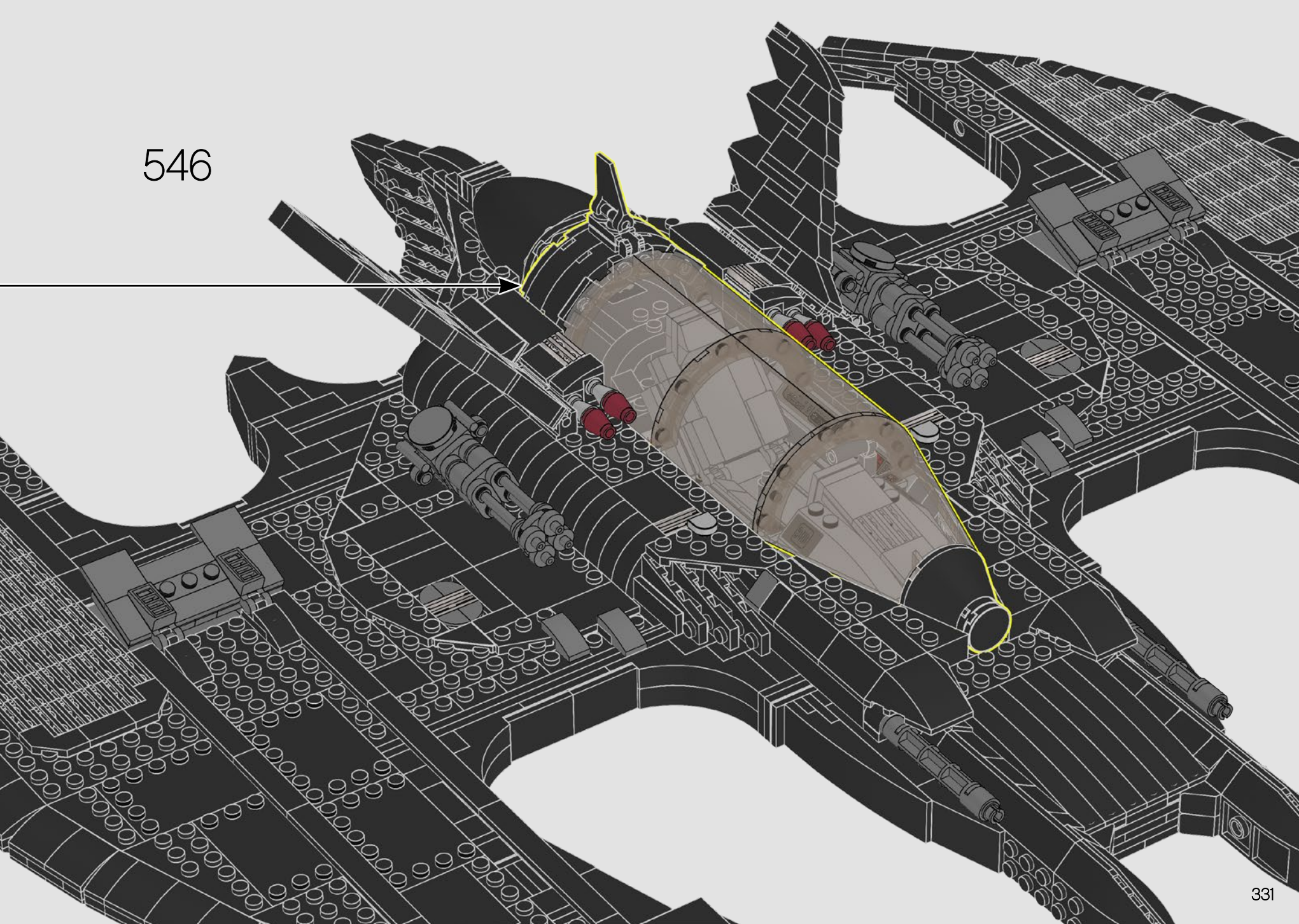

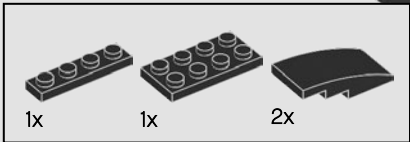

547

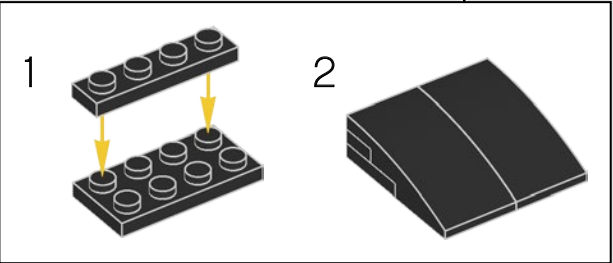
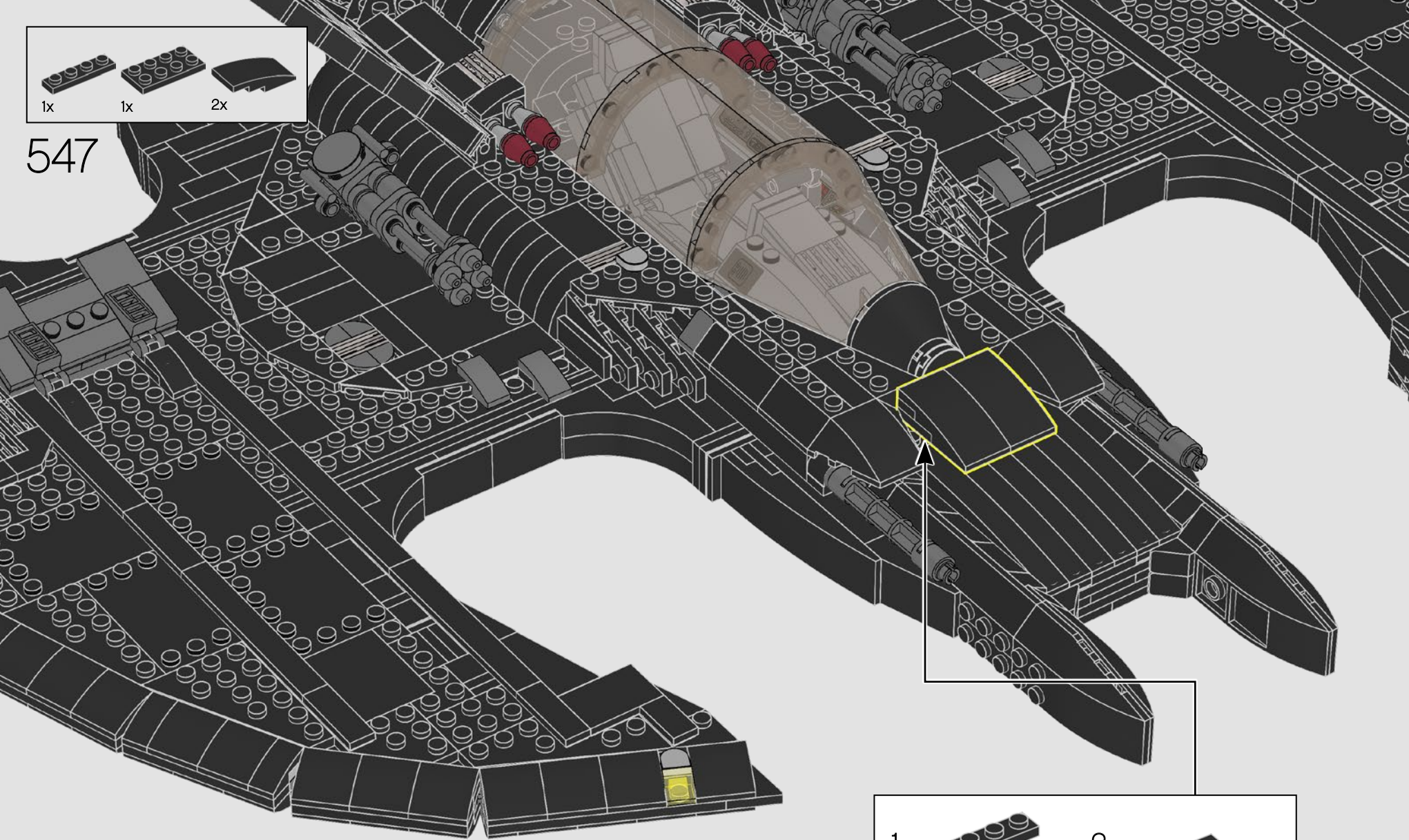

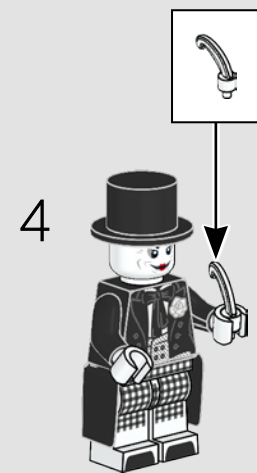
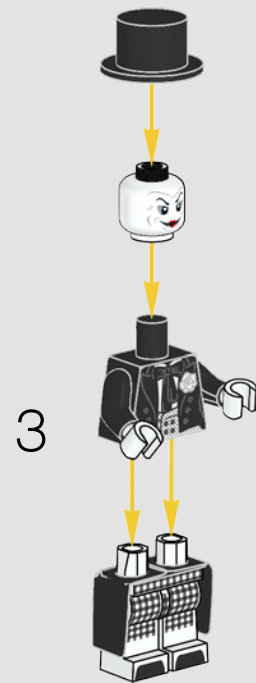
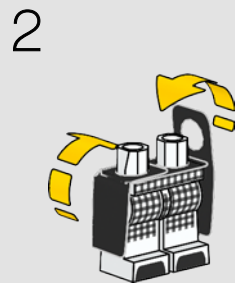
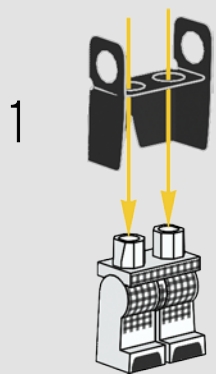
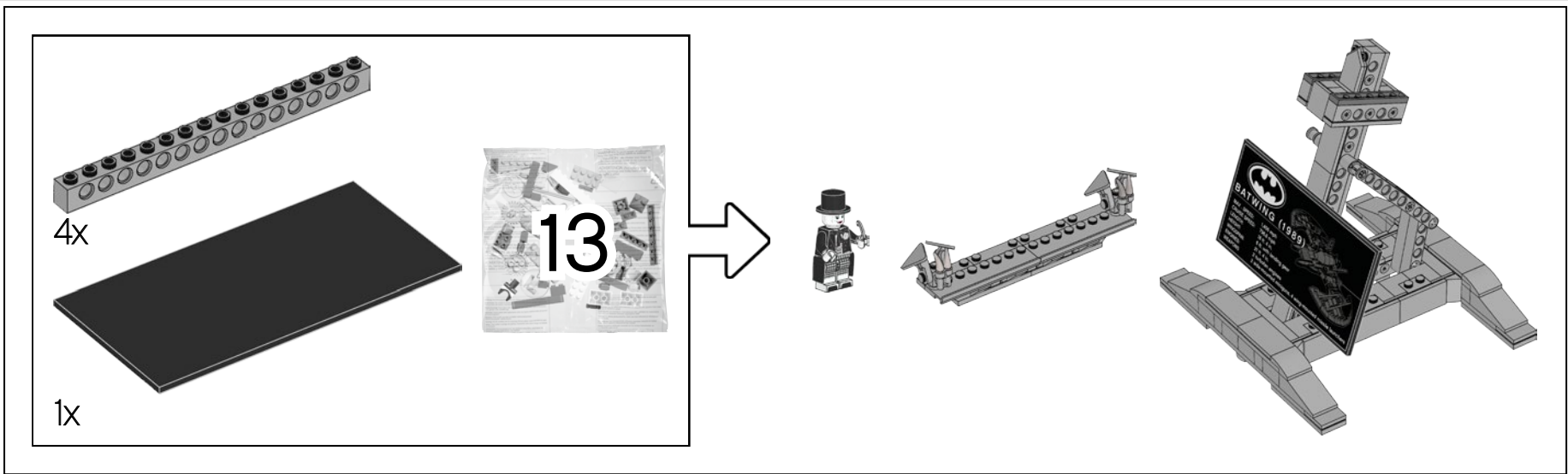

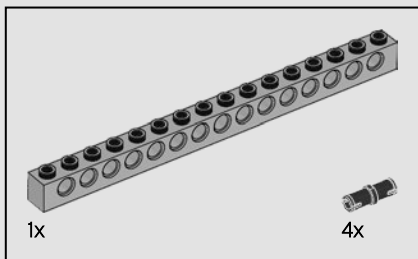

1

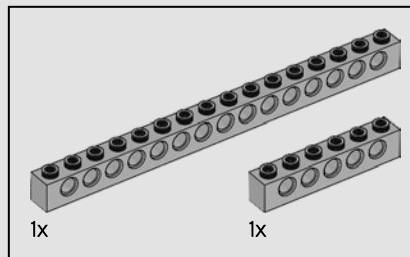
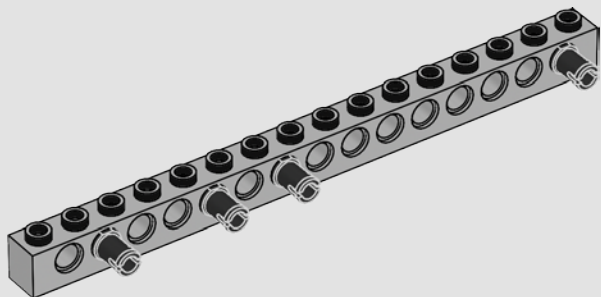

2

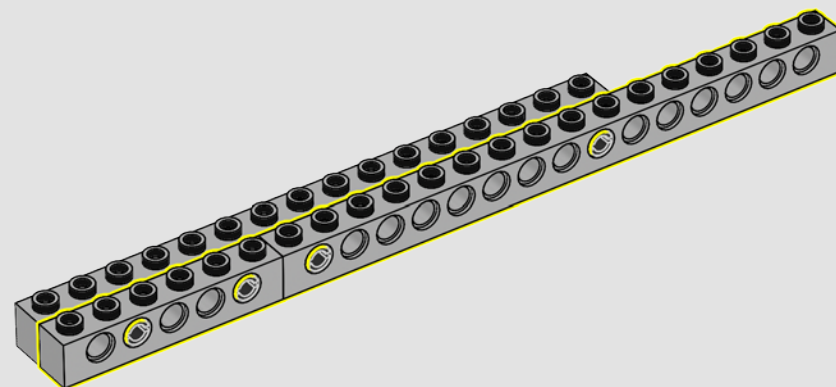

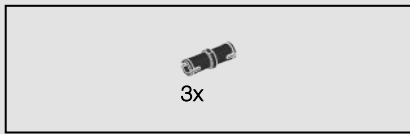

3

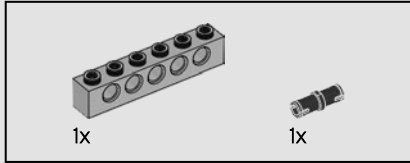
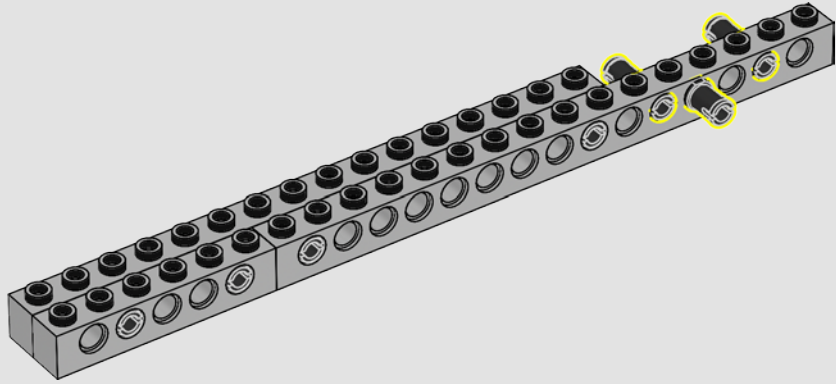

4

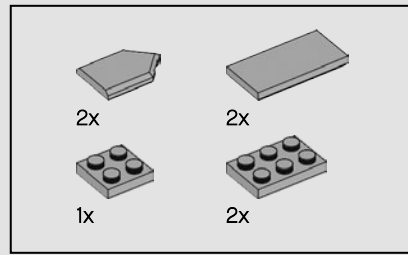
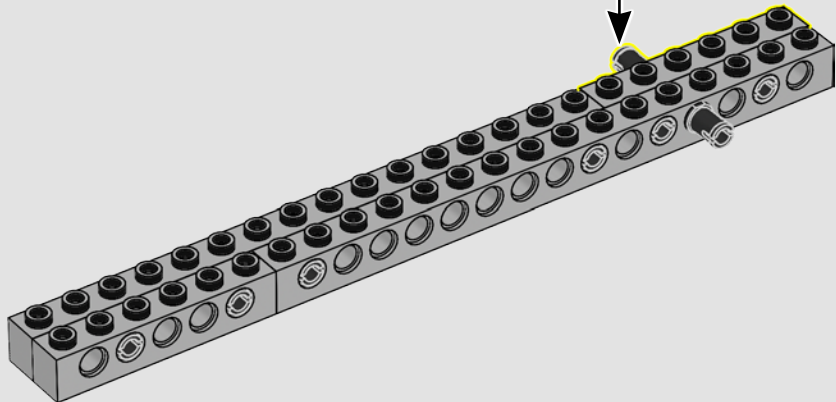
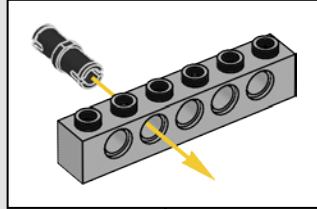

5

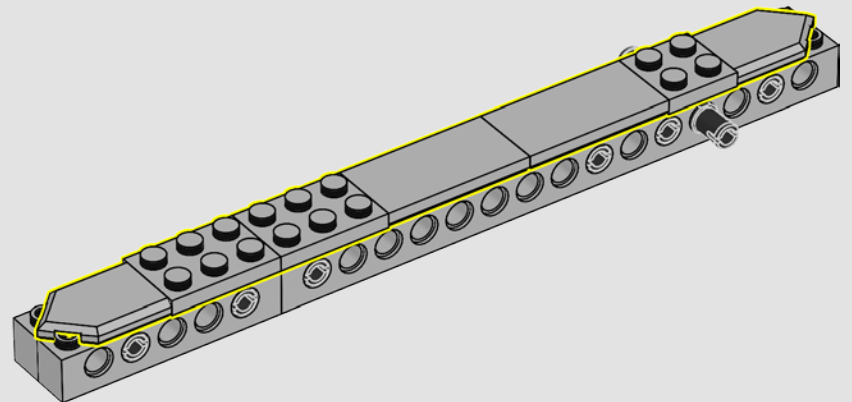

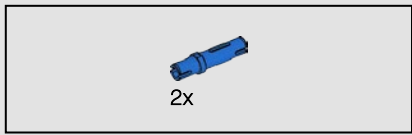

6

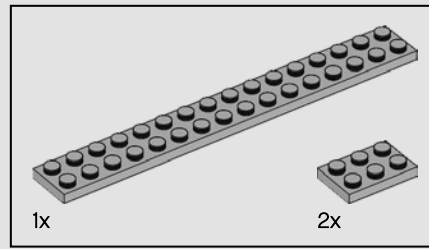
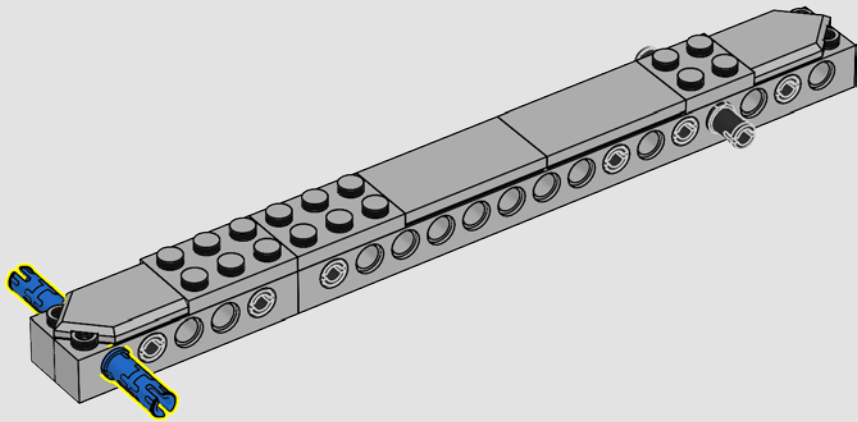

7

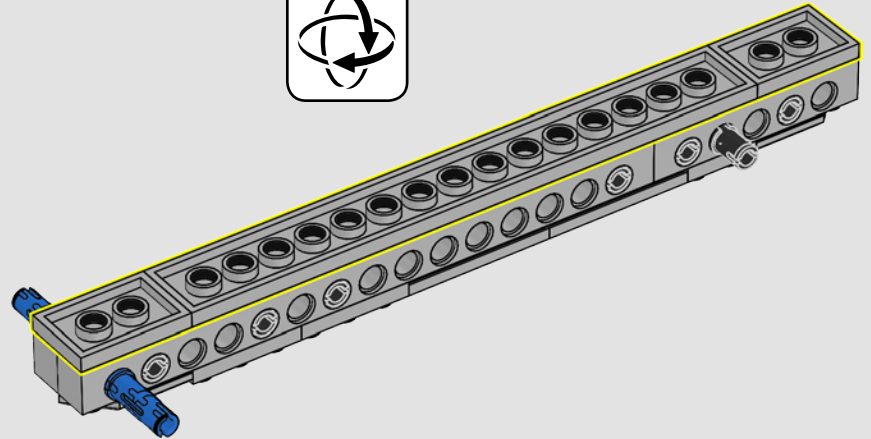
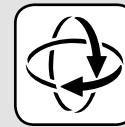



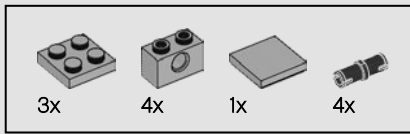

8

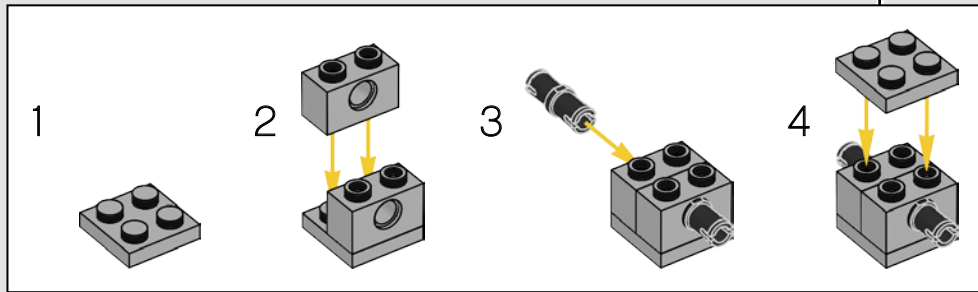
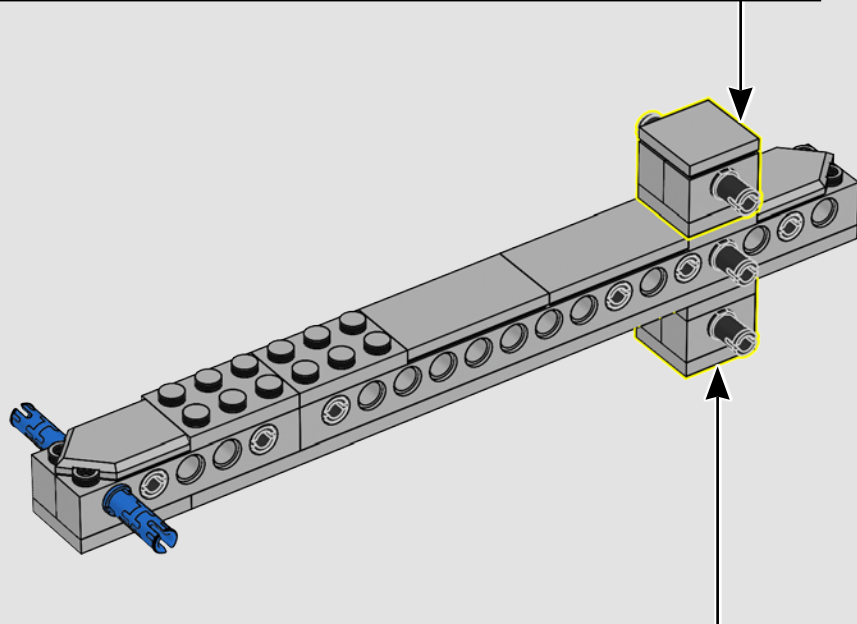
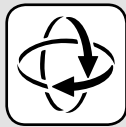
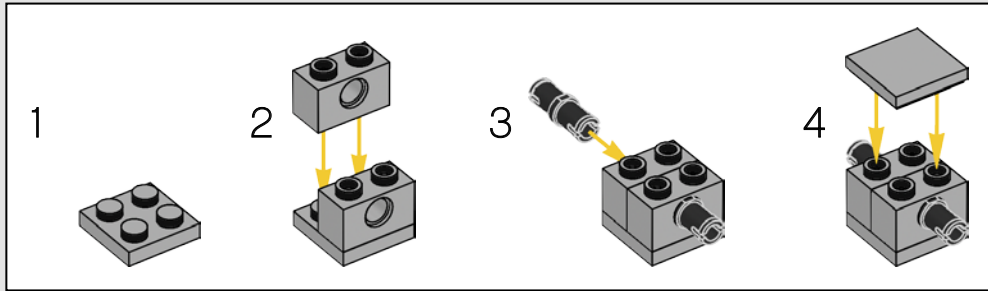

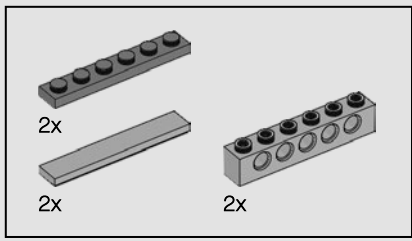

9

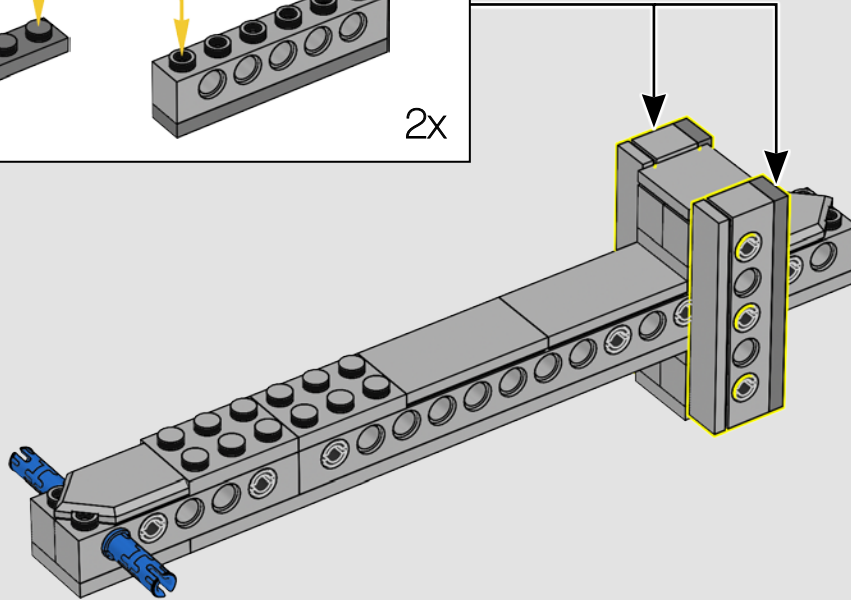
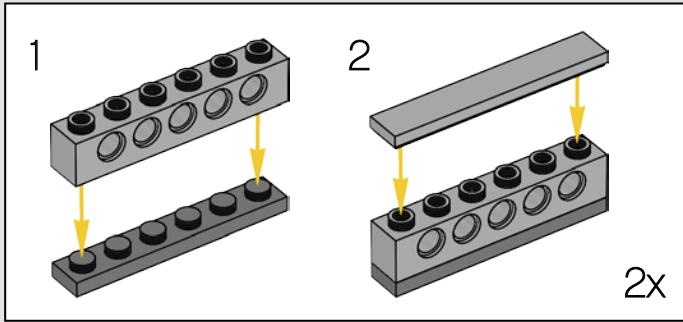

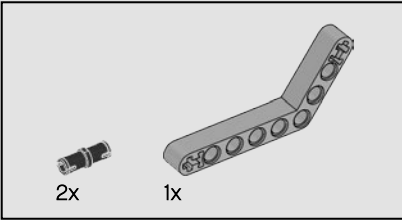
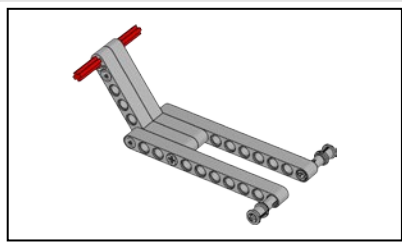

10

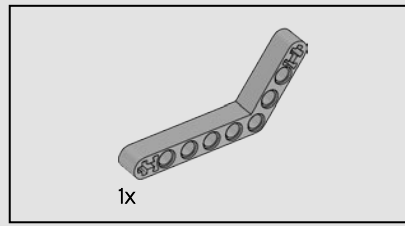
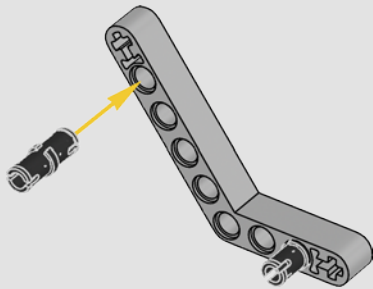

11

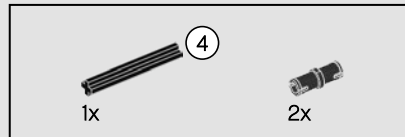
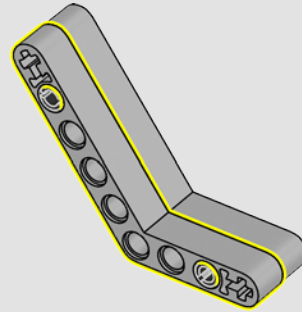

12

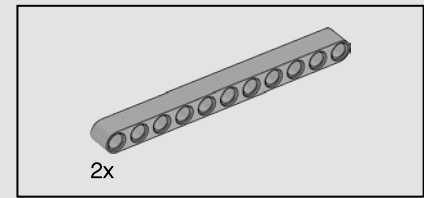
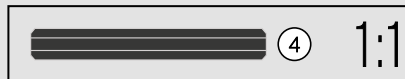
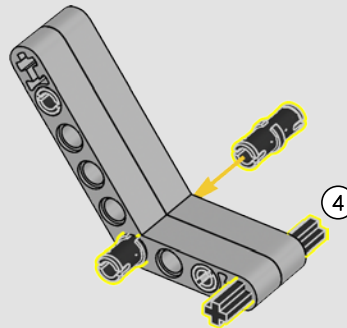

13

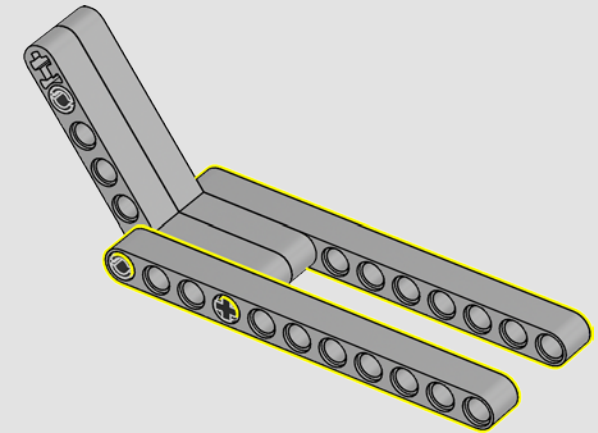

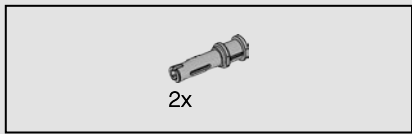

14

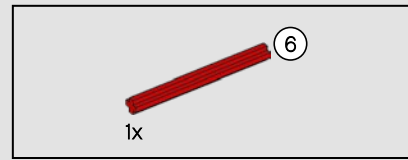
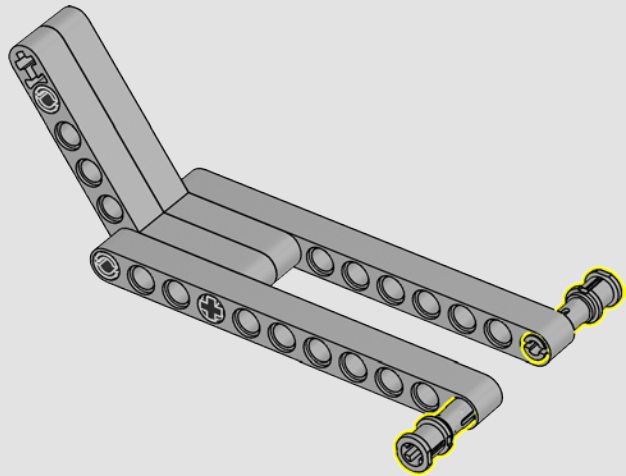

15

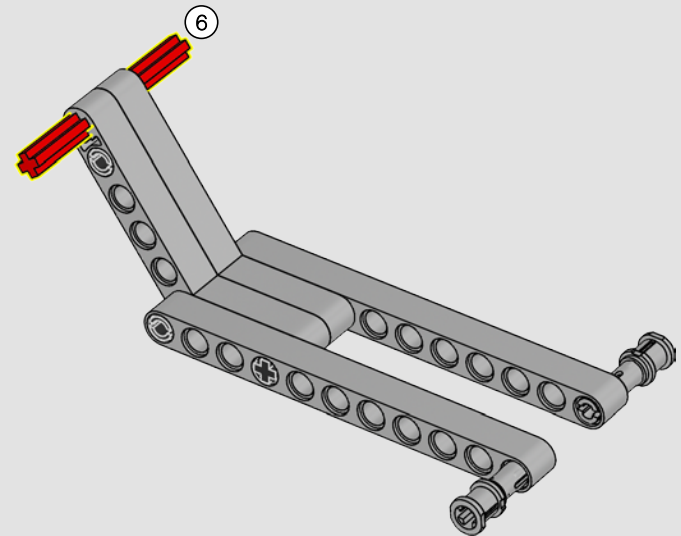

16

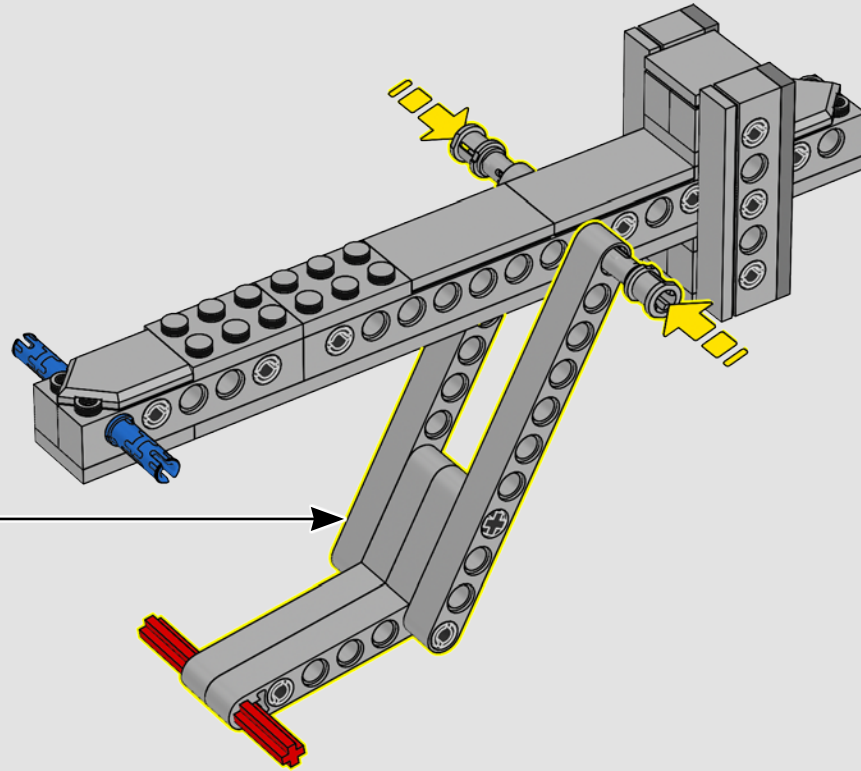

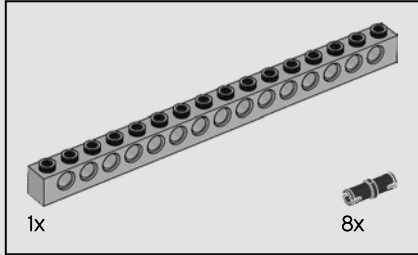
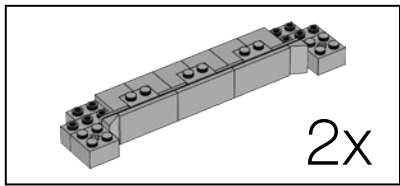

17

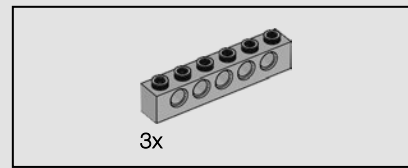
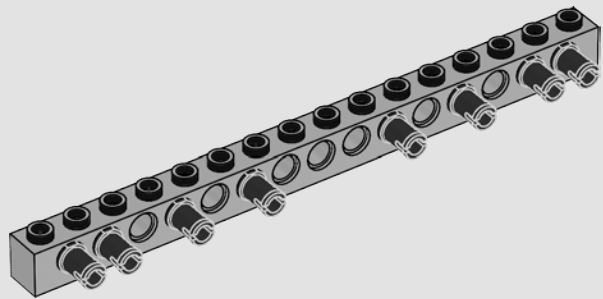

18

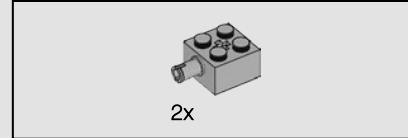
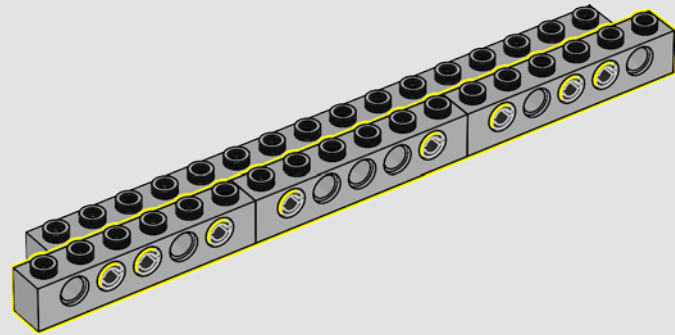

19

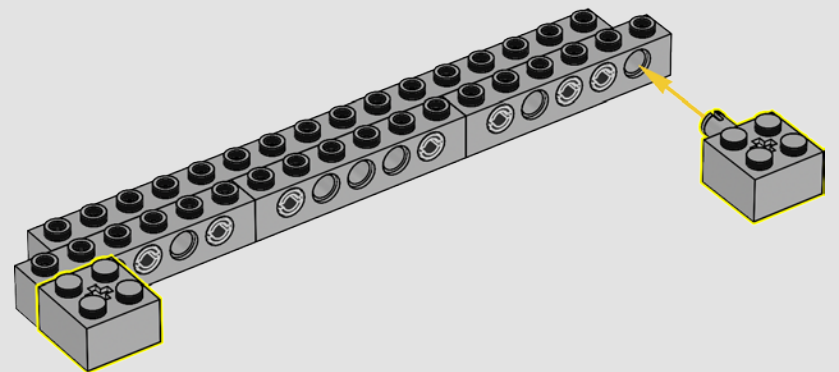

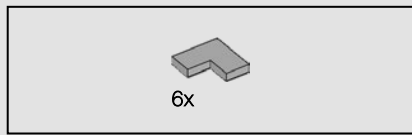

20

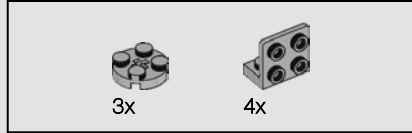
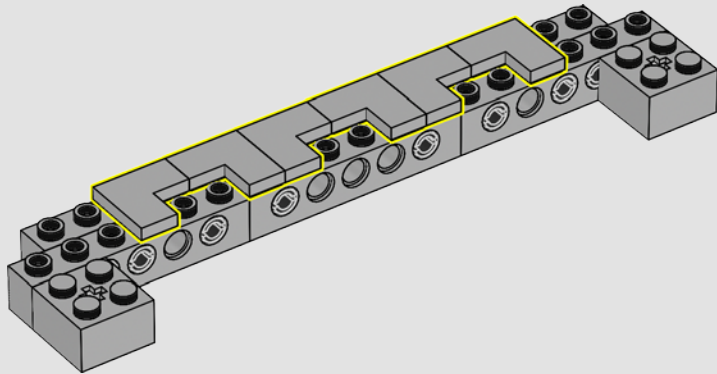

21

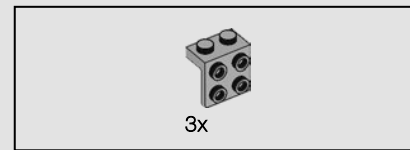
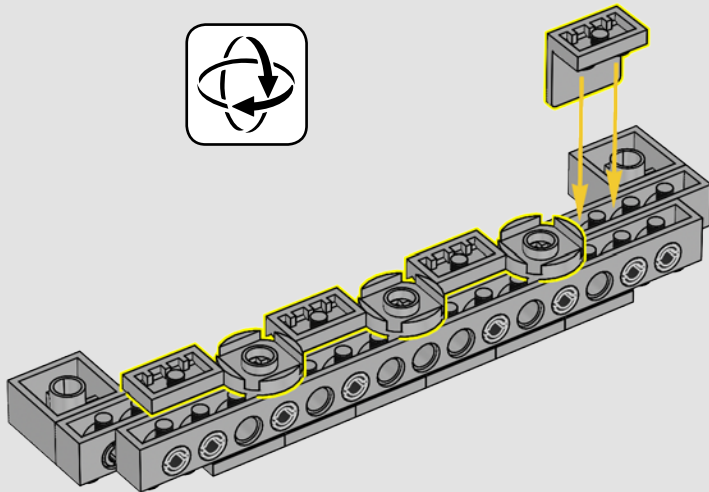

22

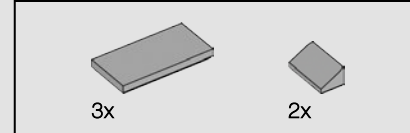
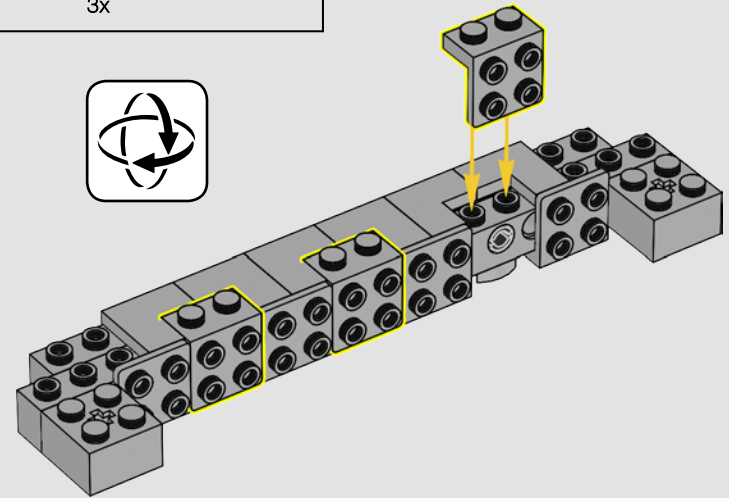

23

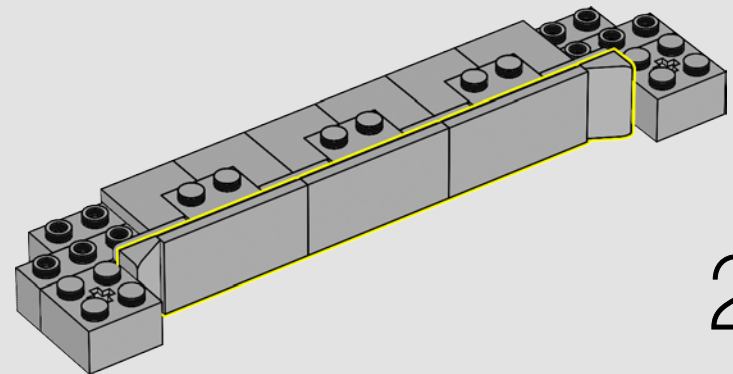

2x

24

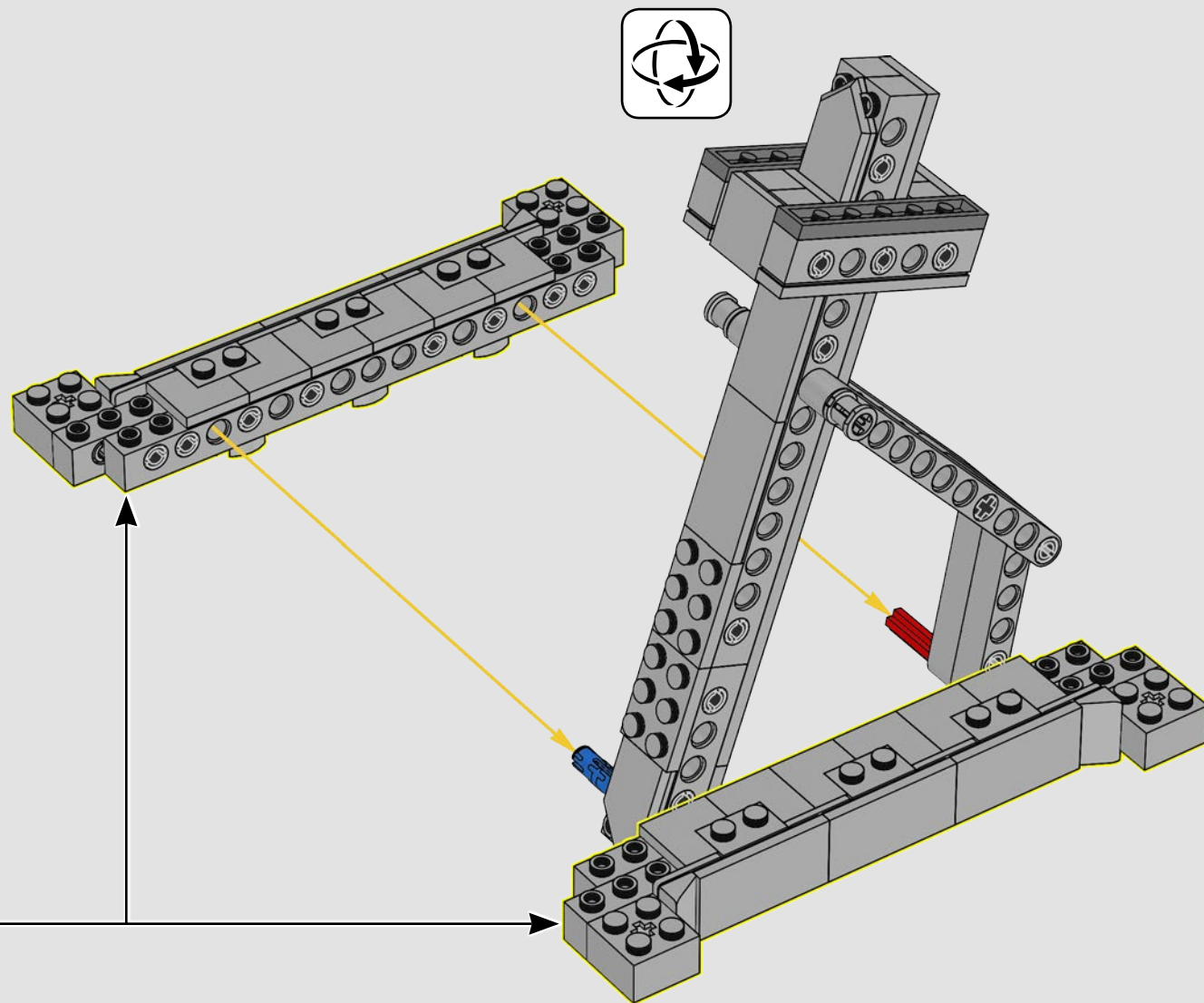



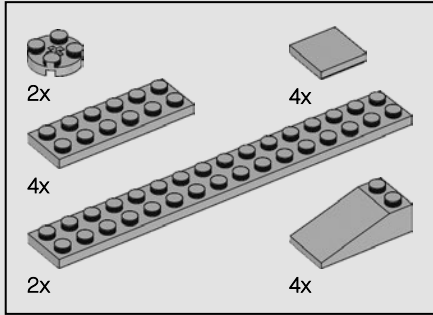
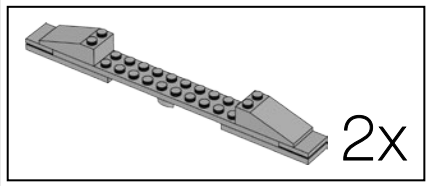

25

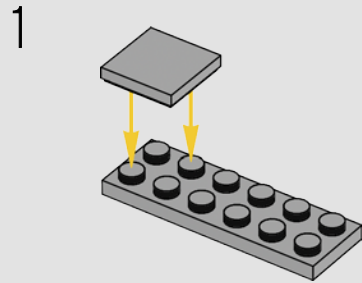

2

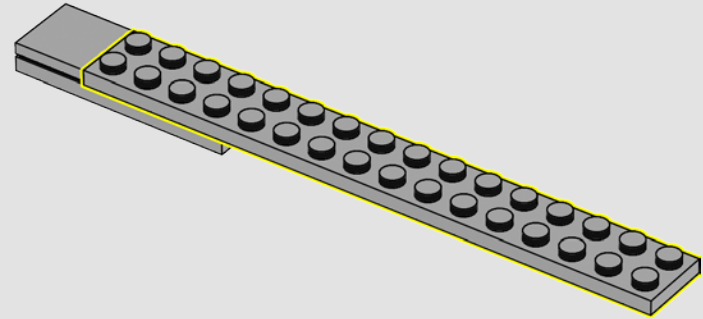

3

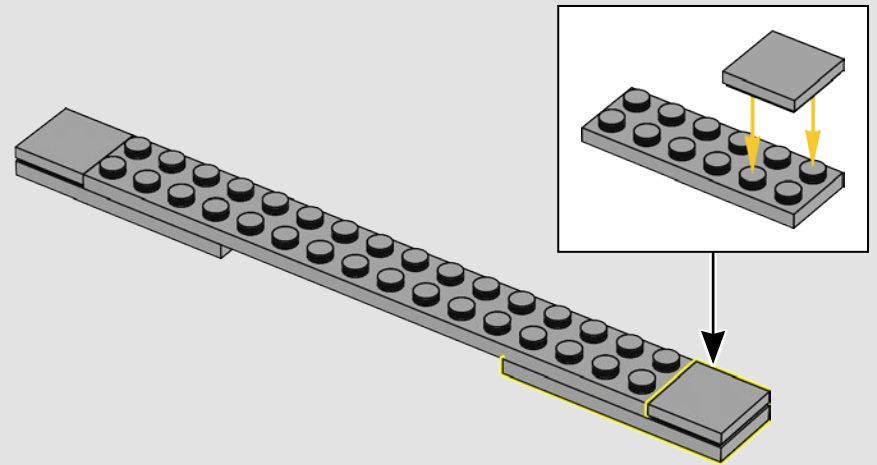

4

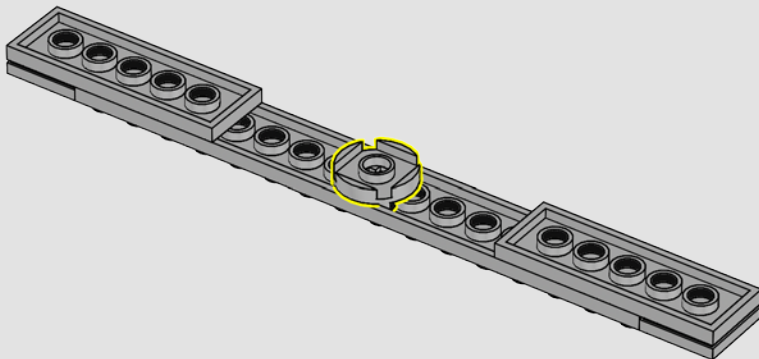

5

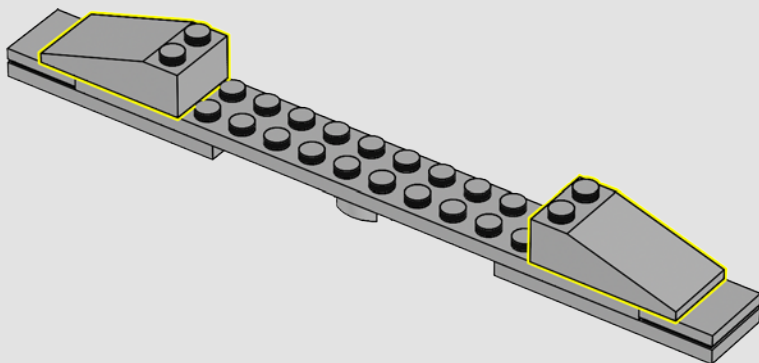

2x

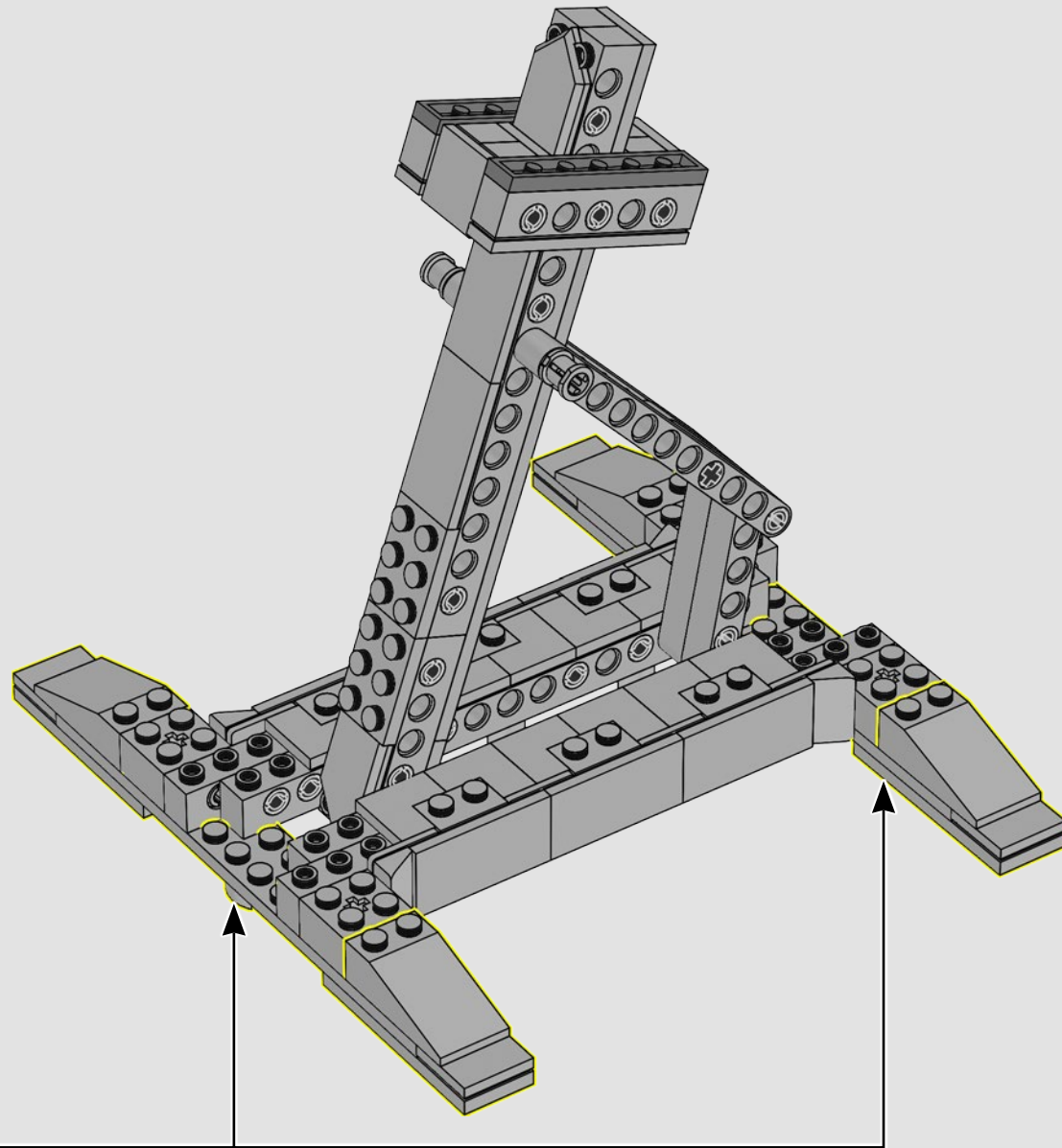

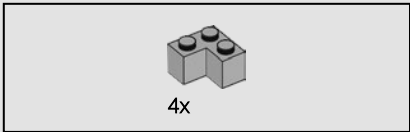

26

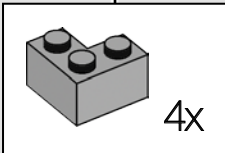
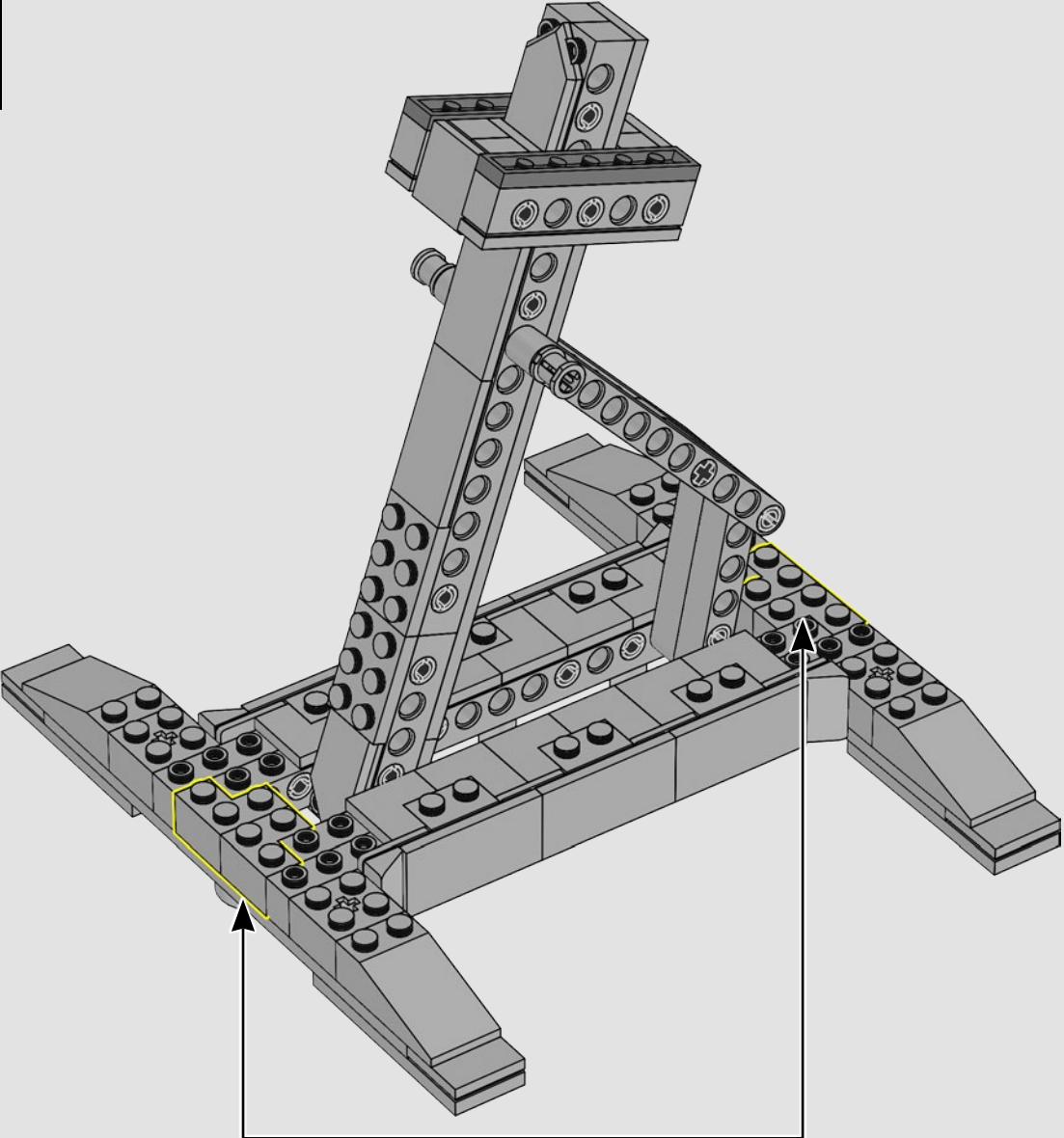

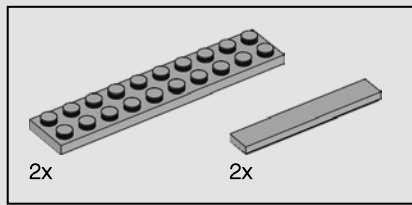

27

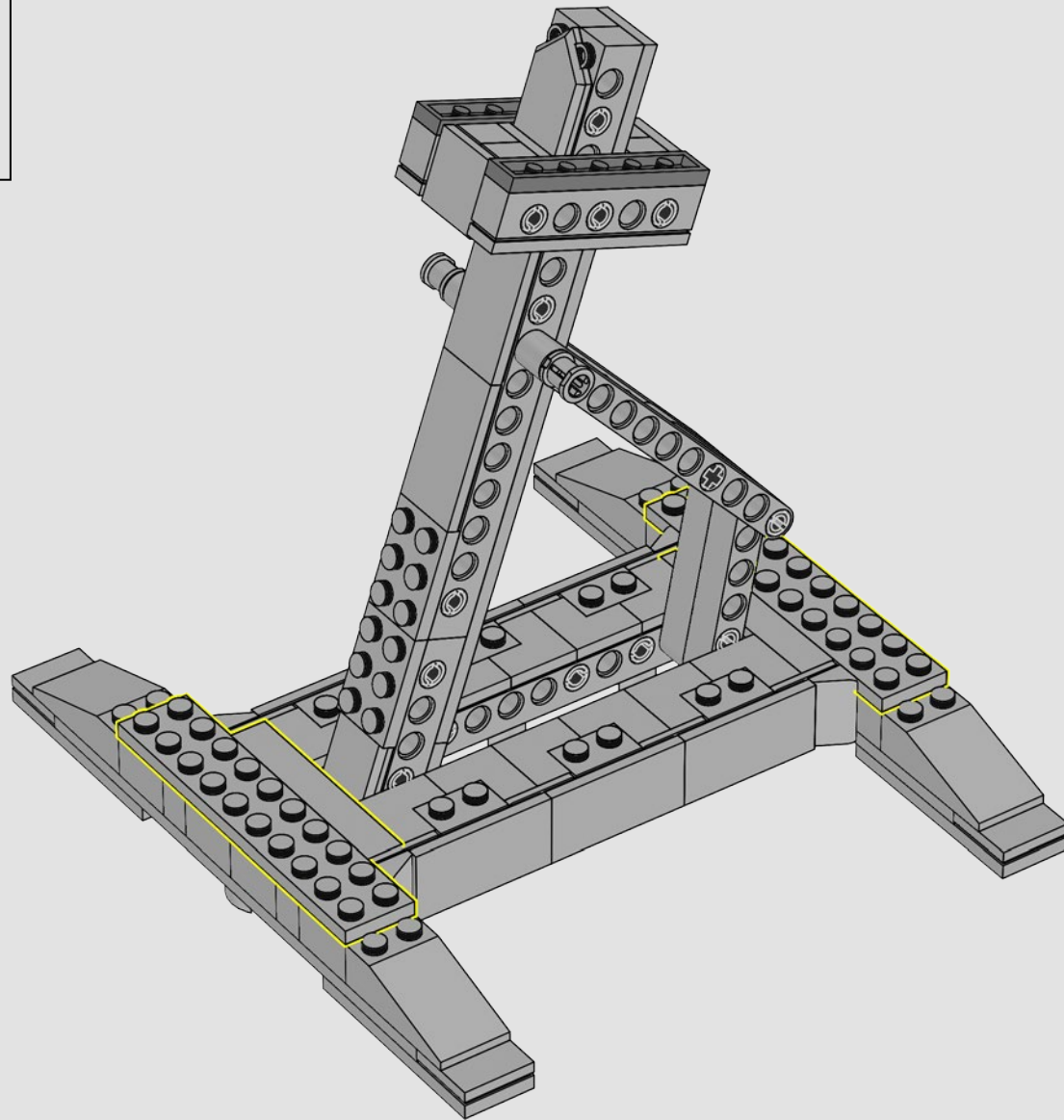

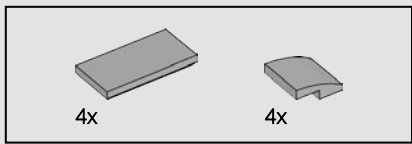

28

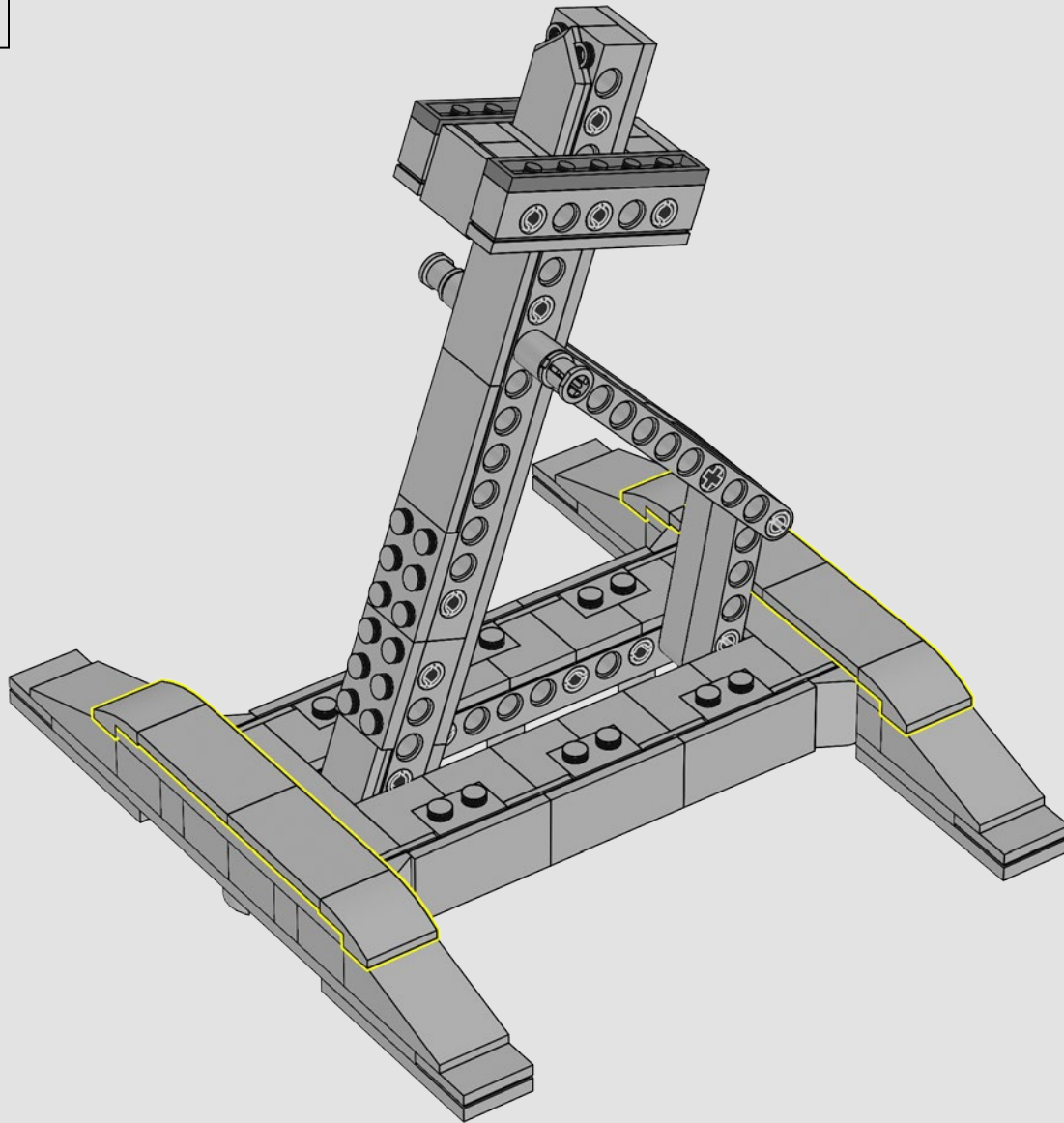

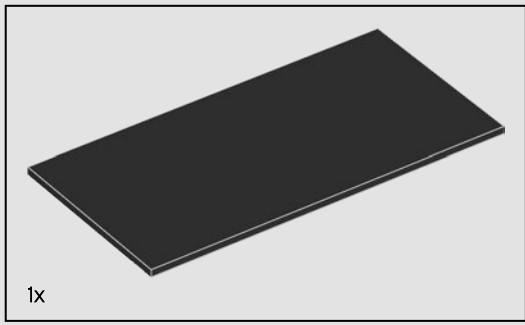

29

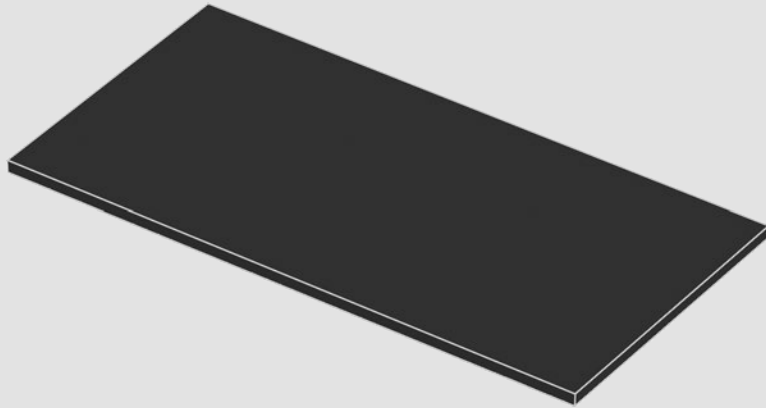

30

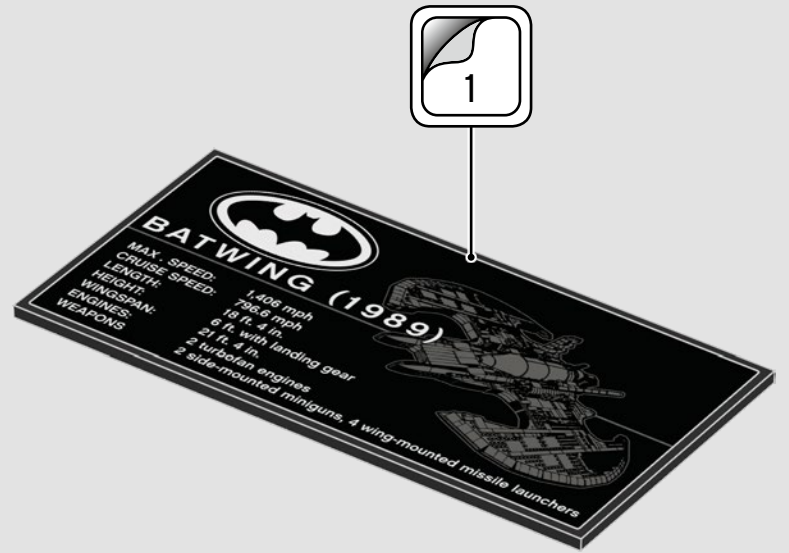

31

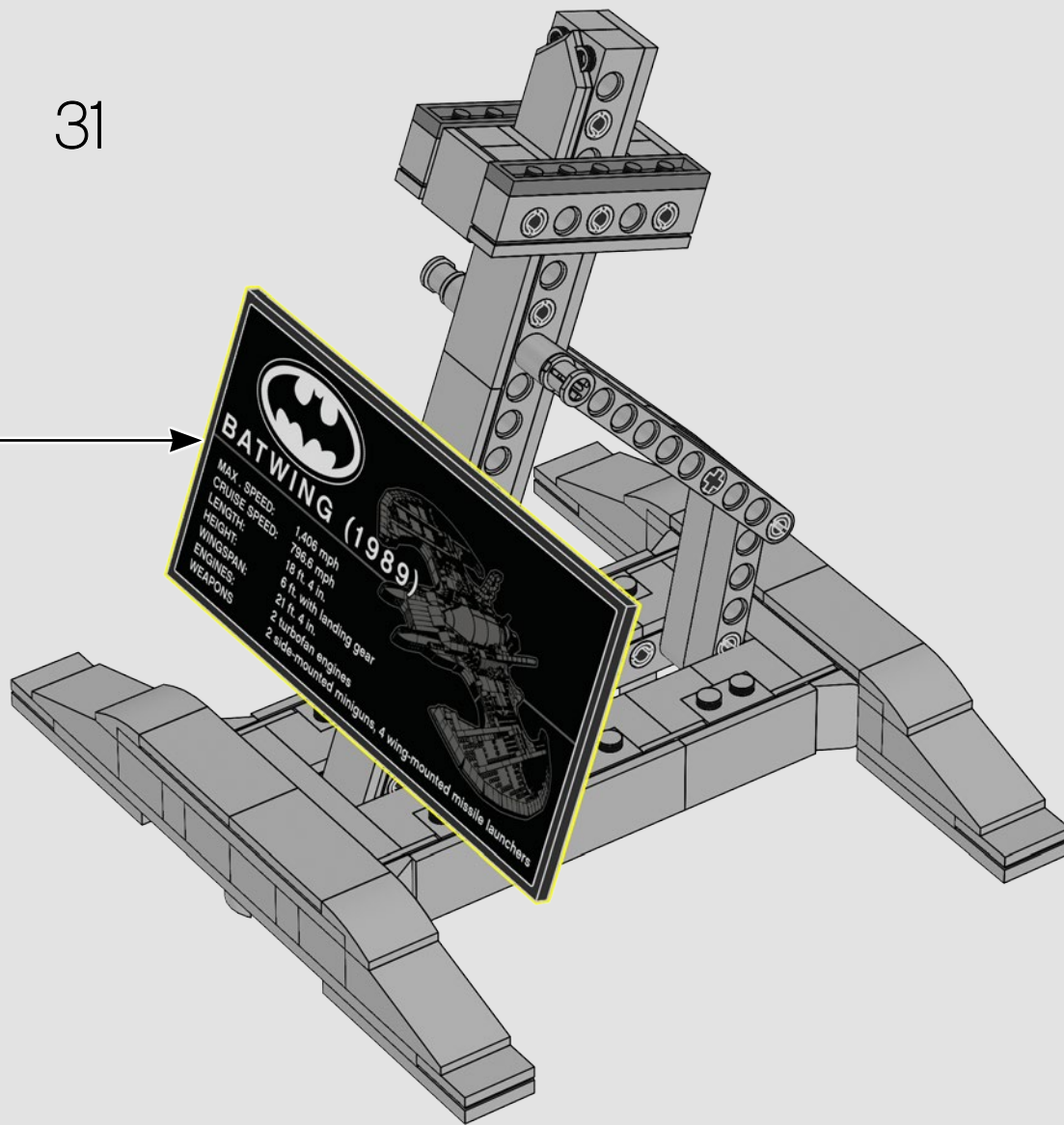



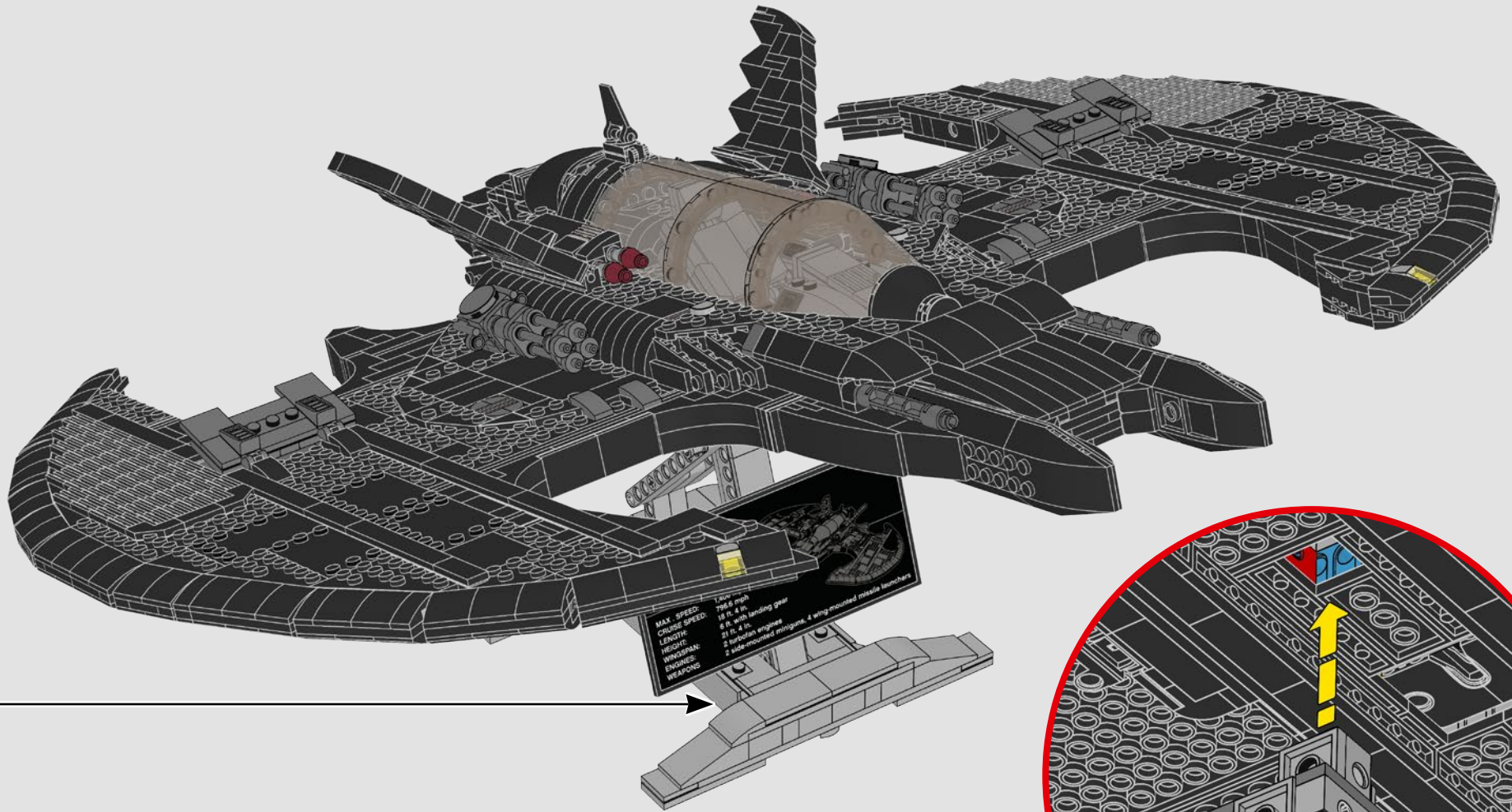

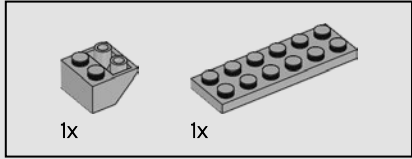
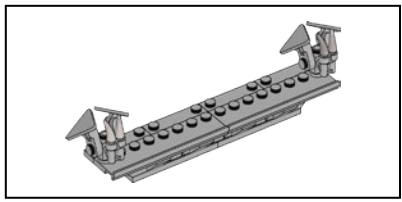

1

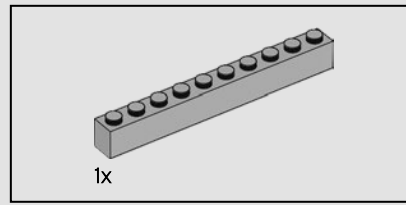
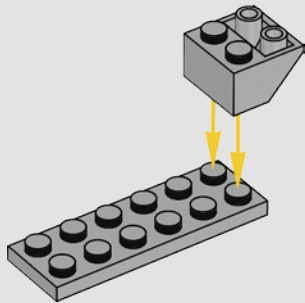

2

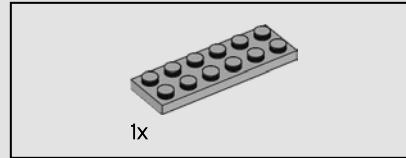
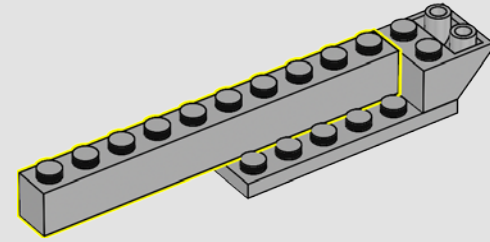

3

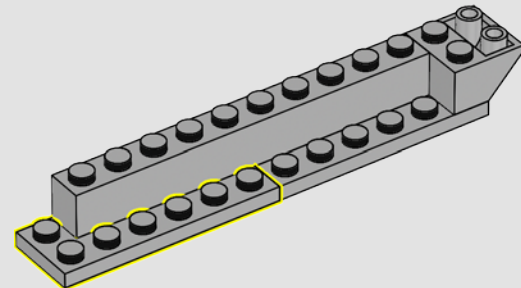

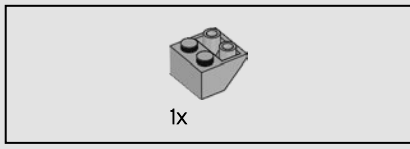

4

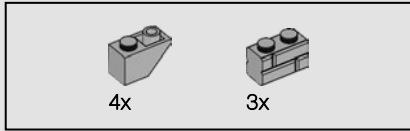
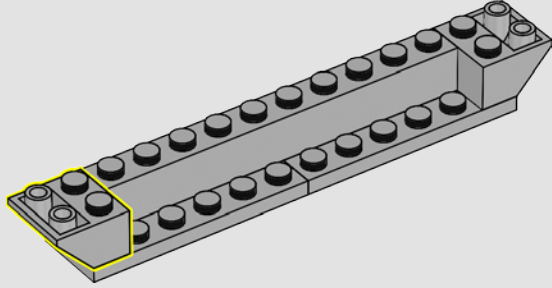

5

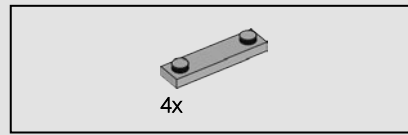
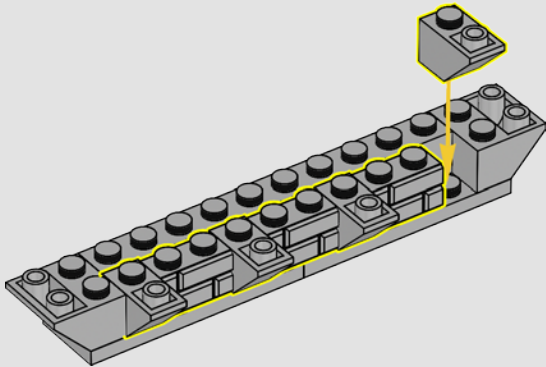

6

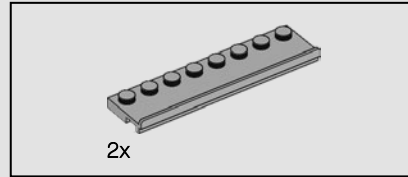
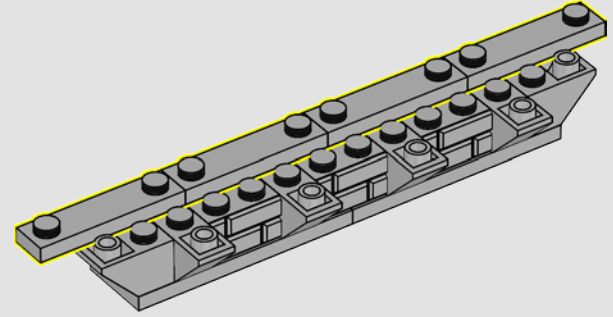

7

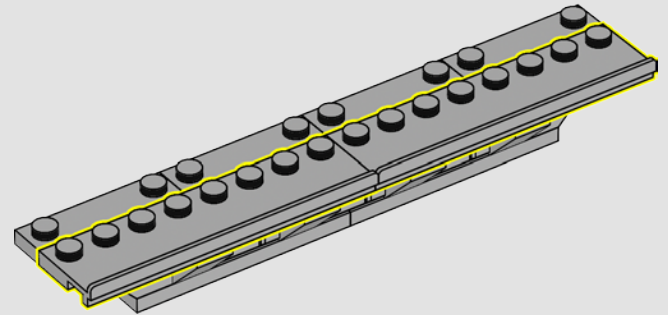

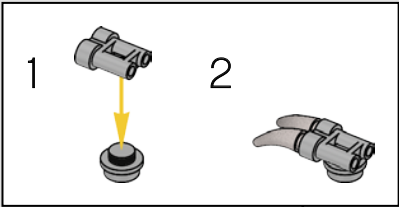
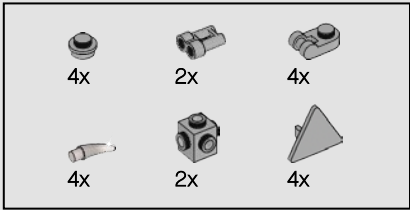
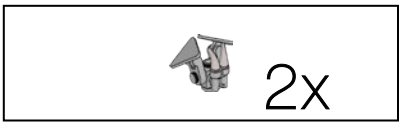

8

1

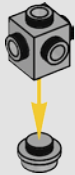

2



3

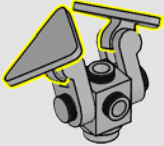

4

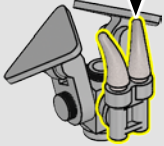

2x

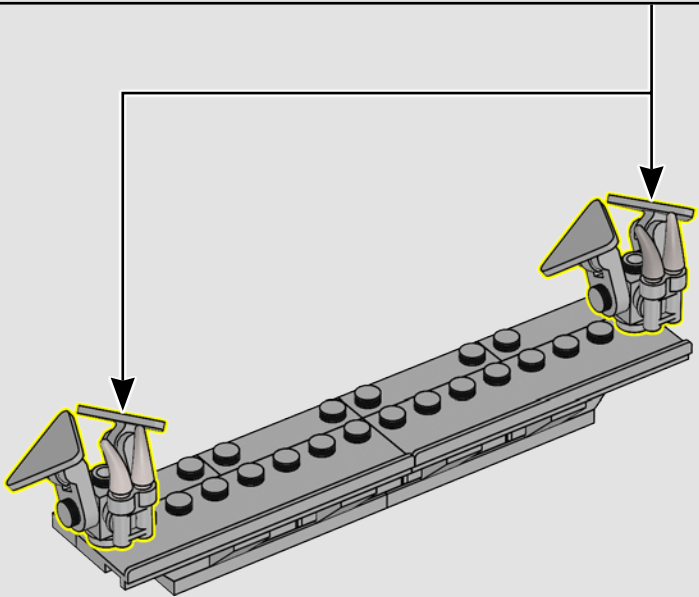

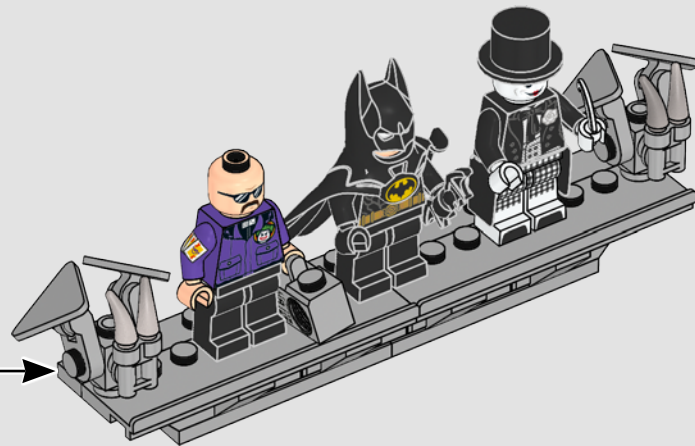

## STEP BY STEP

- 1 Make sure you use the right type and size of anchor and flat head screw for drywall, concrete, or brick. The screw head should fit the Batwing™ mounting bracket.
- 2 Fit your anchor and screw.
- 3 Use one of the red LEGO® crowbars to remove the seat in the cockpit. Now you can see the built-in mounting bracket.
- 4 Align the mounting bracket and screw and carefully place your Batwing.
- 5 Re-attach the cockpit seat.
- 6 Stand back and enjoy. Mission accomplished.

## ÉTAPE PAR ÉTAPE

- 1 Assurez-vous d'utiliser le bon type et la bonne taille d'ancrage et de vis à tête plate pour le plâtre, le béton ou la brique. La tête de vis doit être adaptée aux supports de montage du Batwing™.
- 2 Ajustez l'ancrage et la vis.
- 3 Utilisez l'un des pieds-de-biche LEGO® rouges pour retirer le siège du poste de pilotage. Ceci découvrira le support de montage intégré.
- 4 Alignez le support de montage et la vis et mettez délicatement votre Batwing en place.
- 5 Remettez le siège dans le poste de pilotage.
- 6 Prenez un peu de recul et admirez. Mission accomplie.

## PASO A PASO

- 1 Asegúrate de usar el tipo y el tamaño correctos de tornillo de cabeza plana y anclaje según el material donde lo vayas a colgar (pared de yeso, concreto o ladrillo). La cabeza del tornillo debe encajar en el soporte de montaje del Batiplano.
- 2 Coloca el anclaje y el tornillo.
- 3 Usa una de las palancas LEGO® rojas para retirar el asiento de la cabina. Debajo verás el soporte de montaje integrado.
- 4 Alinea el soporte de montaje y el tornillo, y coloca cuidadosamente el Batiplano.
- 5 Vuelve a acoplar el asiento de la cabina.
- 6 Aléjate un poco y disfruta. Misión cumplida.

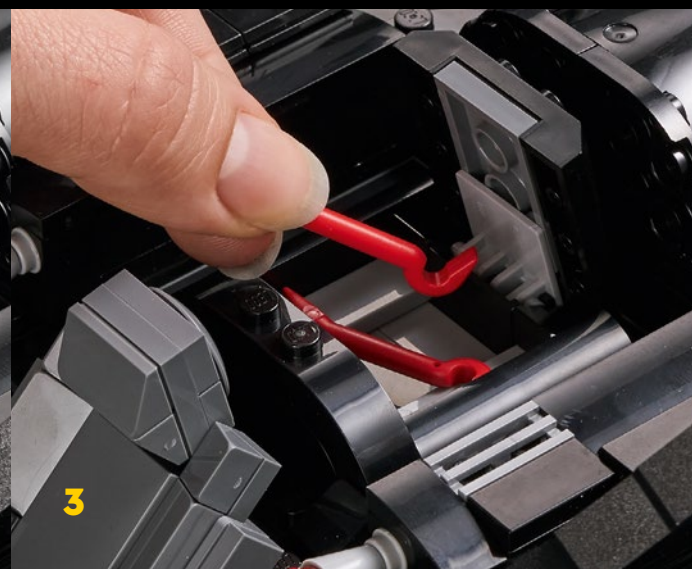
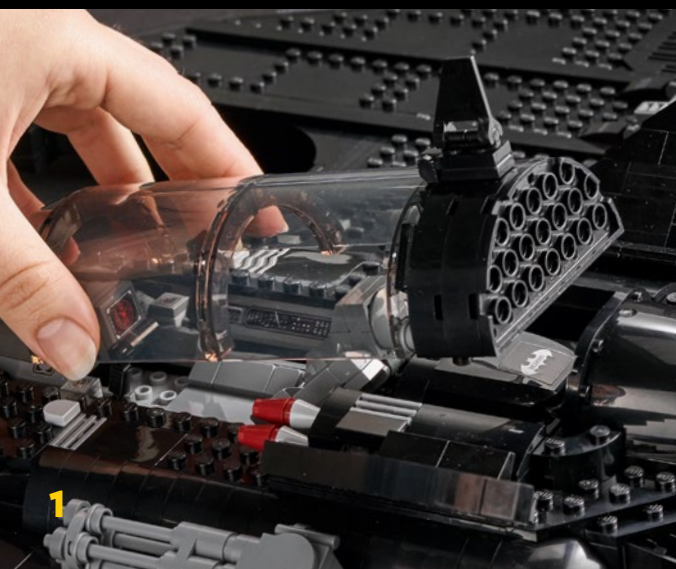



**"GIANT, MENACING, SUPERNATURAL FORM.  
KIND OF LIKE A BAT."**

- Lt. Max Eckhardt, Batman™ (1989)

**« UNE MENAÇANTE FORME SURNATURELLE GÉANTE.  
UNE SORTE DE CHAUVÉ-SOURIS. »**

- Lt Max Eckhardt, Batman™ (1989)

**"AMENAZADOR, FORMA SOBRENATURAL.  
COMO MURCIÉLAGO".**

- Teniente Max Eckhardt, Batman™ (1989)

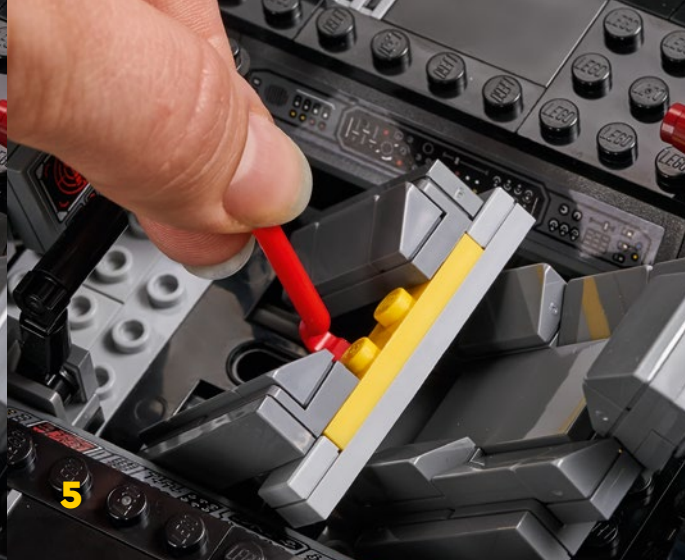



# FEEDBACK AND WIN



## FEEDBACK AND WIN

Your feedback will help shape the future development of this product series.

Please visit:

## FEEDBACK UND GEWINNEN

Dein Feedback trägt zur Weiterentwicklung dieser Produktreihe bei.

Geh auf:

## COMMENTEZ ET GAGNEZ

Vos commentaires nous aideront à concevoir les futurs produits de cette gamme.

Rendez-vous sur :

## COMENTA Y GANA

Tu opinión nos ayudará a dar forma al desarrollo de esta serie de productos en el futuro.

Visita:

## 反馈有奖

您的反馈将有助于我们在今后改进本系列产品。

请访问：

[LEGO.com/productfeedback](https://www.lego.com/productfeedback)

By completing, you will automatically enter a drawing to win a LEGO® set.

Terms & Conditions apply.

Durch Ausfüllen nimmst du automatisch an der Verlosung eines LEGO® Preises teil.

Es gelten die Teilnahmebedingungen.

En envoyant vos commentaires, vous serez automatiquement inscrit(e) à un tirage au sort qui vous permettra de remporter un prix LEGO®.

Offre soumise à conditions.

Al contestar, participarás automáticamente en el sorteo y podrás ganar un set LEGO®.

Sujeto a Términos y Condiciones.

完成我们的反馈调查，即可自动进入抽奖环节，赢取乐高®套装。

适用《条款和条件》。



6x 302423	1x 6139343	15x 371024	6x 654126	4x 6184784	1x 4184617	10x 300326	20x 4558170	14x 300226	42x 6016172
75x 4514553	1x 6302582	1x 4124463	10x 300526	1x 6266207	6x 6214807	16x 242026	2x 4581280	4x 4527766	1x 4105175
2x 4579260	4x 4544140	2x 6290456	3x 4214559	20x 4121966	1x 6266224	6x 4124096	1x 6274859	4x 4527766	1x 6070695
5x 4218749	1x 6318104	1x 6315887	5x 6141554	8x 300426	4x 4283047	4x 6133722	1x 317626	1x 370526	4x 616859
2x 4273526	12x 306224	2x 6318701	5x 6141556	27x 306926	2x 4567436	2x 235726	1x 4650620	2x 6019726	8x 4636202
10x 4114077	20x 614124	2x 4558954	7x 4180536	1x 366526	2x 4567436	2x 4567436	1x 4650620	1x 4599499	2x 9339
10x 4114077	8x 4256320	2x 6196548	7x 4180536	2x 6196548	4x 4283046	4x 6052126	4x 303826	1x 4599499	2x 9339
2x 4159739	4x 307024	8x 4504382	2x 6196548	4x 6147050	9x 306826	11x 362326	4x 303826	1x 4599499	2x 9339
2x 4159739	2x 407024	4x 307026	16x 4161332	17x 393726	37x 302226	11x 362326	4x 303826	1x 4599499	2x 9339
11x 4114319	2x 6151937	1x 6181720	1x 6181713	14x 6117973	57x 6053077	32x 4618880	7x 6258209	1x 301026	1x 6078886
2x 6288331	4x 307024	1x 6181720	1x 6181713	14x 6117973	57x 6053077	32x 4618880	7x 6258209	1x 301026	1x 6078886
11x 4114319	2x 6151937	1x 6181720	1x 6181713	14x 6117973	57x 6053077	32x 4618880	7x 6258209	1x 301026	1x 6078886
2x 6288331	4x 307024	1x 6181720	1x 6181713	14x 6117973	57x 6053077	32x 4618880	7x 6258209	1x 301026	1x 6078886
11x 4114319	2x 6151937	1x 6181720	1x 6181713	14x 6117973	57x 6053077	32x 4618880	7x 6258209	1x 301026	1x 6078886
2x 6288331	4x 307024	1x 6181720	1x 6181713	14x 6117973	57x 6053077	32x 4618880	7x 6258209	1x 301026	1x 6078886
11x 4114319	2x 6151937	1x 6181720	1x 6181713	14x 6117973	57x 6053077	32x 4618880	7x 6258209	1x 301026	1x 6078886
2x 6288331	4x 307024	1x 6181720	1x 6181713	14x 6117973	57x 6053077	32x 4618880	7x 6258209	1x 301026	1x 6078886
11x 4114319	2x 6151937	1x 6181720	1x 6181713	14x 6117973	57x 6053077	32x 4618880	7x 6258209	1x 301026	1x 6078886
2x 6288331	4x 307024	1x 6181720	1x 6181713	14x 6117973	57x 6053077	32x 4618880	7x 6258209	1x 301026	1x 6078886
11x 4114319	2x 6151937	1x 6181720	1x 6181713	14x 6117973	57x 6053077	32x 4618880	7x 6258209	1x 301026	1x 6078886
2x 6288331	4x 307024	1x 6181720	1x 6181713	14x 6117973	57x 6053077	32x 4618880	7x 6258209	1x 301026	1x 6078886
11x 4114319	2x 6151937	1x 6181720	1x 6181713	14x 6117973	57x 6053077	32x 4618880	7x 6258209	1x 301026	1x 6078886
2x 6288331	4x 307024	1x 6181720	1x 6181713	14x 6117973	57x 6053077	32x 4618880	7x 6258209	1x 301026	1x 6078886
11x 4114319	2x 6151937	1x 6181720	1x 6181713	14x 6117973	57x 6053077	32x 4618880	7x 6258209	1x 301026	1x 6078886
2x 6288331	4x 307024	1x 6181720	1x 6181713	14x 6117973	57x 6053077	32x 4618880	7x 6258209	1x 301026	1x 6078886
11x 4114319	2x 6151937	1x 6181720	1x 6181713	14x 6117973	57x 6053077	32x 4618880	7x 6258209	1x 301026	1x 6078886
2x 6288331	4x 307024	1x 6181720	1x 6181713	14x 6117973	57x 6053077	32x 4618880	7x 6258209	1x 301026	1x 6078886
11x 4114319	2x 6151937	1x 6181720	1x 6181713	14x 6117973	57x 6053077	32x 4618880	7x 6258209	1x 301026	1x 6078886
2x 6288331	4x 307024	1x 6181720	1x 6181713	14x 6117973	57x 6053077	32x 4618880	7x 6258209	1x 301026	1x 6078886
11x 4114319	2x 6151937	1x 6181720	1x 6181713	14x 6117973	57x 6053077	32x 4618880	7x 6258209	1x 301026	1x 6078886
2x 6288331	4x 307024	1x 6181720	1x 6181713	14x 6117973	57x 6053077	32x 4618880	7x 6258209	1x 301026	1x 6078886
11x 4114319	2x 6151937	1x 6181720	1x 6181713	14x 6117973	57x 6053077	32x 4618880	7x 6258209	1x 301026	1x 6078886
2x 6288331	4x 307024	1x 6181720	1x 6181713	14x 6117973	57x 6053077	32x 4618880	7x 6258209	1x 301026	1x 6078886
11x 4114319	2x 6151937	1x 6181720	1x 6181713	14x 6117973	57x 6053077	32x 4618880	7x 6258209	1x 301026	1x 6078886
2x 6288331	4x 307024	1x 6181720	1x 6181713	14x 6117973	57x 6053077	32x 4618880	7x 6258209	1x 301026	1x 6078886
11x 4114319	2x 6151937	1x 6181720	1x 6181713	14x 6117973	57x 6053077	32x 4618880	7x 6258209	1x 301026	1x 6078886
2x 6288331	4x 307024	1x 6181720	1x 6181713	14x 6117973	57x 6053077	32x 4618880	7x 6258209	1x 301026	1x 6078886
11x 4114319	2x 6151937	1x 6181720	1x 6181713	14x 6117973	57x 6053077	32x 4618880	7x 6258209	1x 301026	



2x  
4185583



20x  
4116854

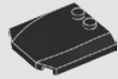

1x  
4191191



1x  
6272030



1x  
6314907



24x  
366626



1x  
6112323



1x  
6132770



8x  
663626



1x  
4620763

362

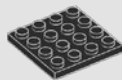

3x  
4243819

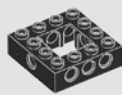

6x  
6222427

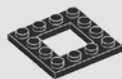

1x  
6058118

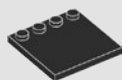

6x  
617926



2x  
6208787

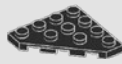

12x  
4160025



6x  
6252902



1x  
6302094



2x  
6171909



4x  
4181144

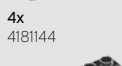

17x  
379526

379526

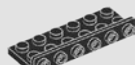

4x  
6314878

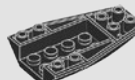

2x  
4180469



2x  
6123844



2x  
300826



17x  
346026



14x  
416226



10x  
303226

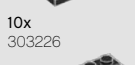

8x  
4100378



1x  
6133200



2x  
6296083



4x  
303426

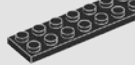

4x  
303426

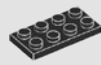

16x  
302026



12x  
6102782



4x  
4163334



2x  
4106977



2x  
447726



6x  
6037664



1x  
303526

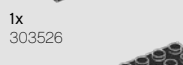

1x  
4617860



9x  
383226



10x  
303626



8x  
4514845



8x  
428226

428226



6x  
4560182



2x  
4587844



4x  
300126



1x  
6078889



2x  
611226

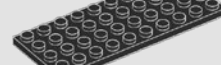

2x  
303026

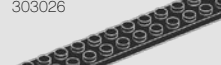

3x  
244526



2x  
6001494



1x  
302826

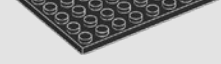

4x  
246526

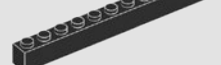

8x  
428226



8x  
428226

428226



60x  
302326



4x  
4598528



4x  
4541191



10x  
6069000



5x  
6092585



86x  
241226



8x  
393826



6x  
4618852



6x  
6138173



2x  
6114987



2x  
4647286



5x  
6094066



1x  
4603646



1x  
393721



11x  
370021



2x  
4599453



1x  
6130002



4x  
6289504



1x  
6259941



1x  
6259941



1x  
6259941



1x  
6259941



1x  
6259941



1x  
6259941

6



4x  
4211440



3x  
6000066



32x  
4211398



4x  
4211437



6x  
6015344



6x  
6117967



8x  
4654580



2x  
6217876



6x  
4211397



4x  
6102357



5x  
4211413



4x  
4211349



12x  
6065824

6065824

5x  
4211438

4x  
4211549

4211549





TM

76161



BATMAN and all related characters and elements  
© & TM DC Comics and Warner Bros. Entertainment Inc.  
WB SHIELD: © & TM WBEI. (s20)



LEGO and the LEGO logo are trademarks of the/sont des marques de commerce du/son marcas registradas de LEGO Group. ©2020 The LEGO Group.

6343711