

6493 1996

# TIME CRUISERS

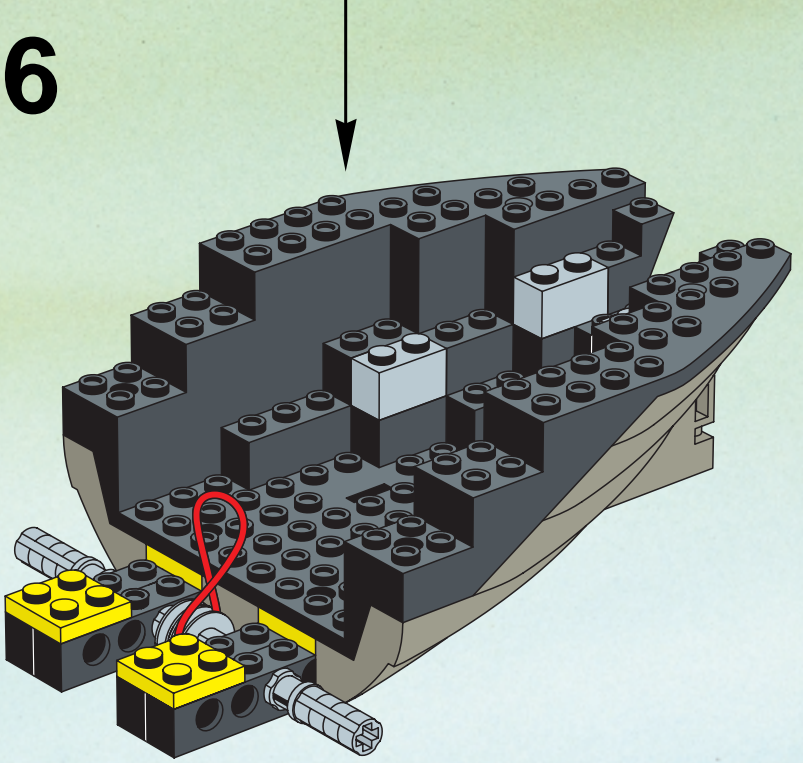

1:1 10

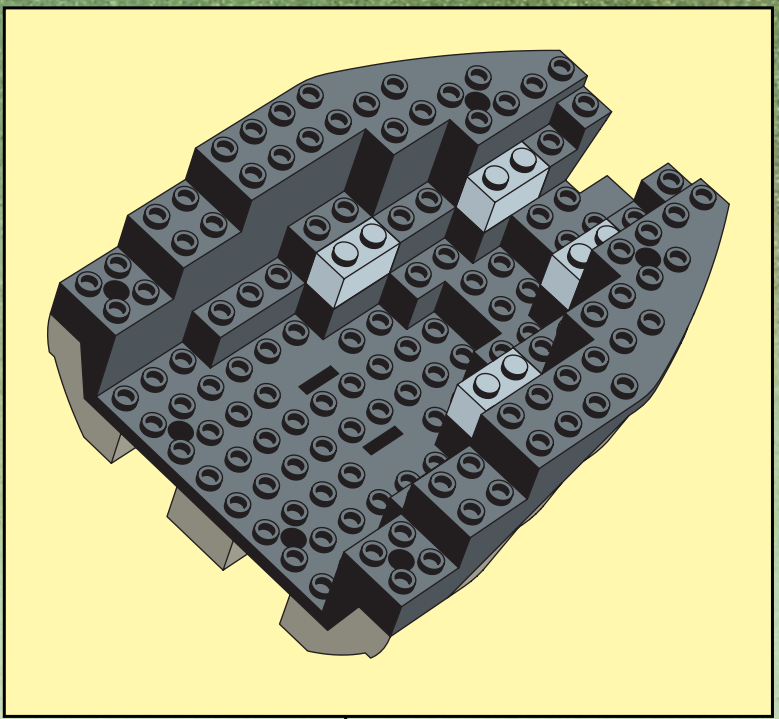
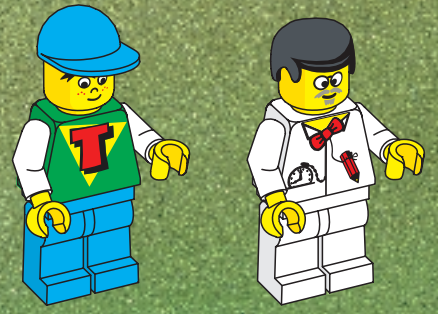
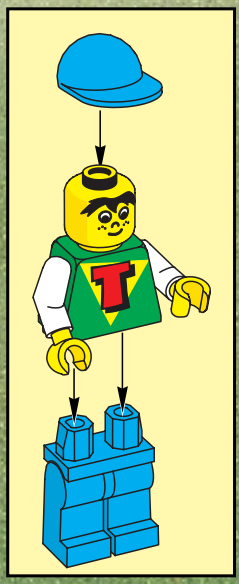
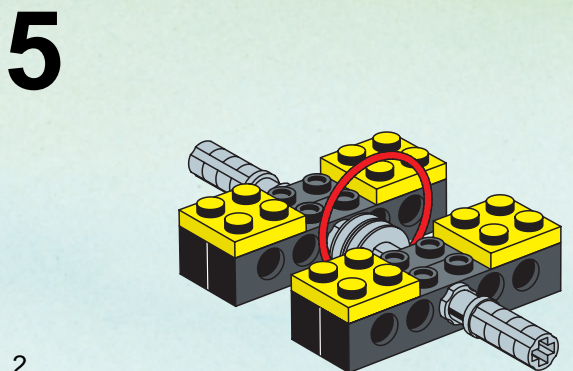
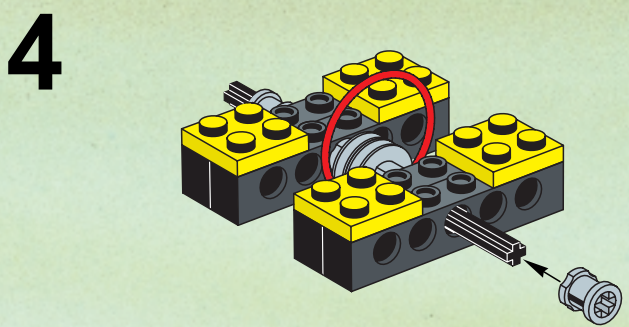
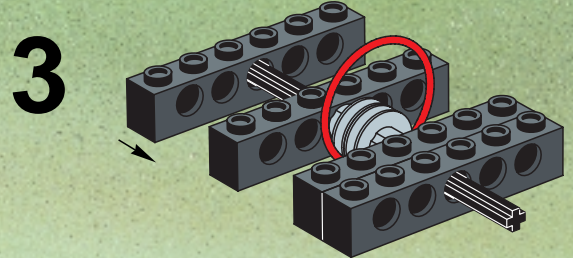
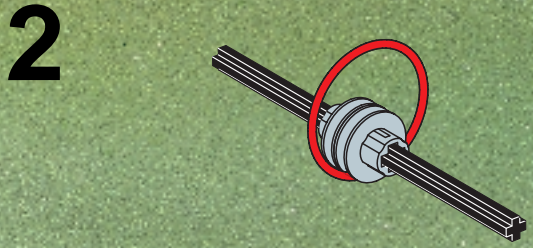
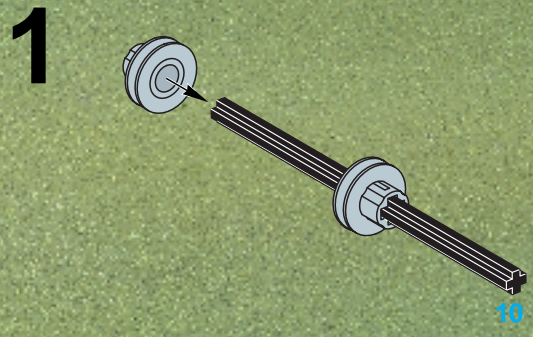

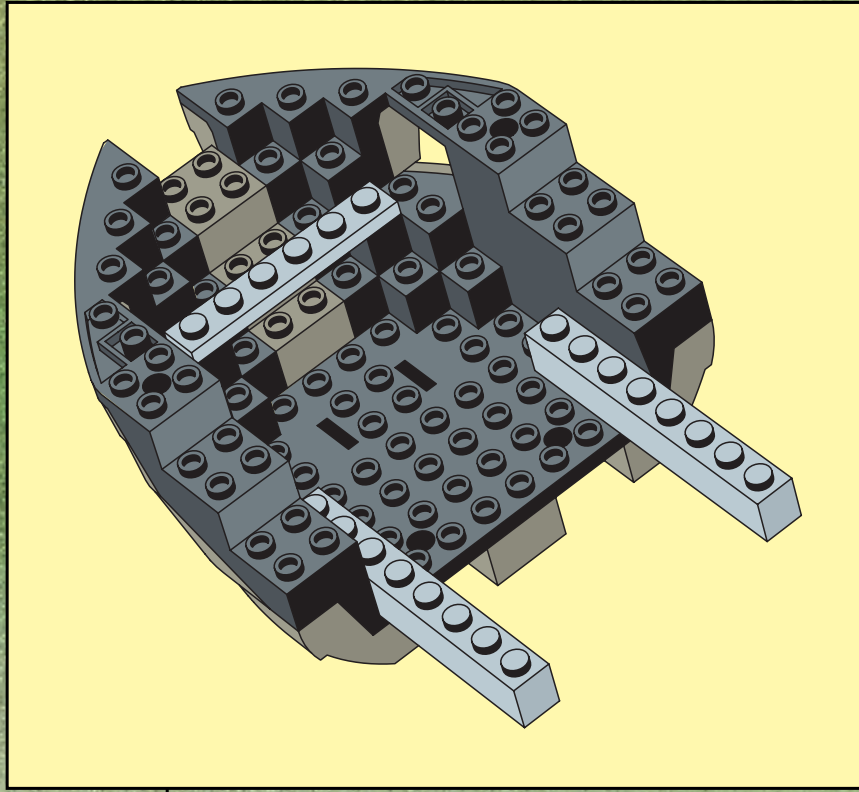

7

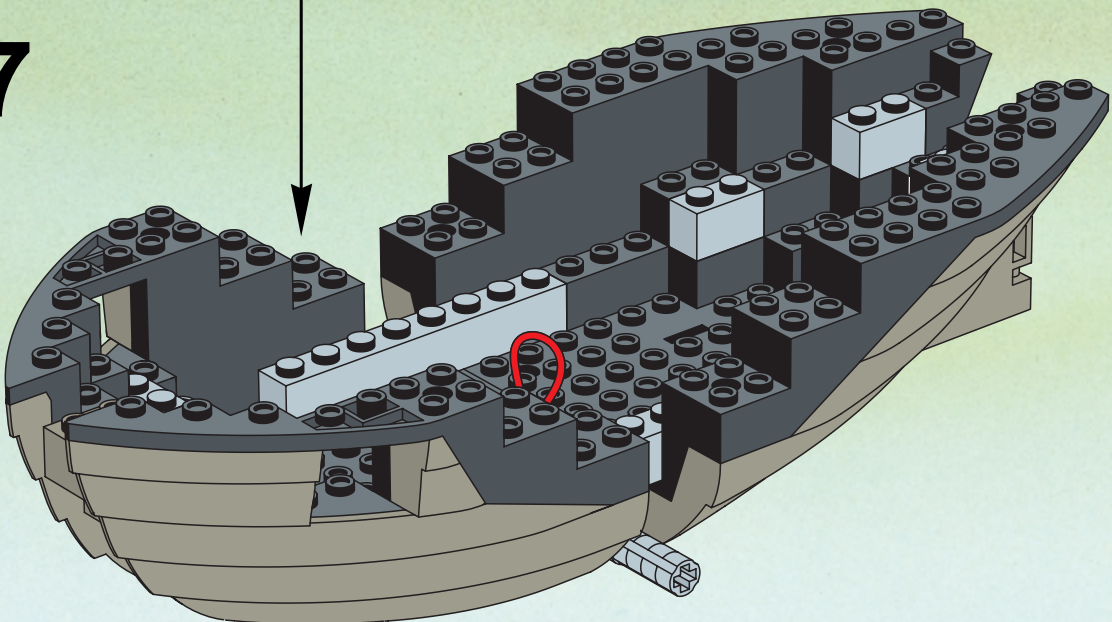

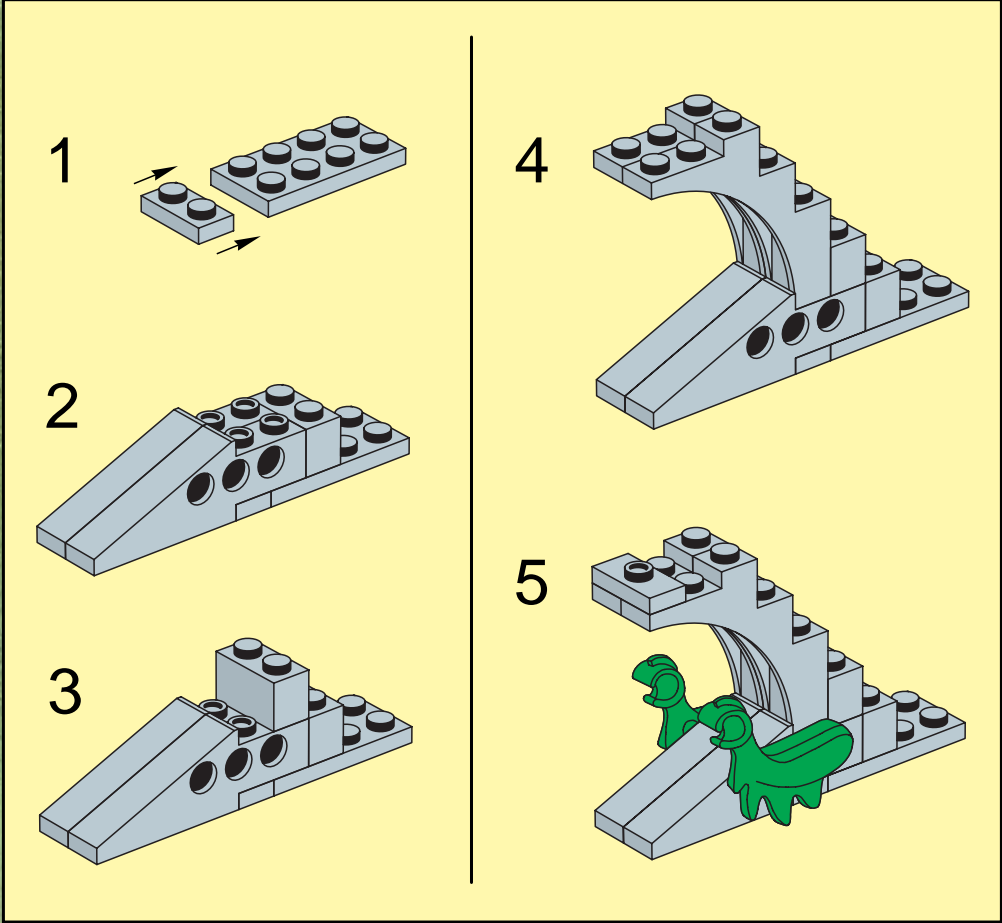

8

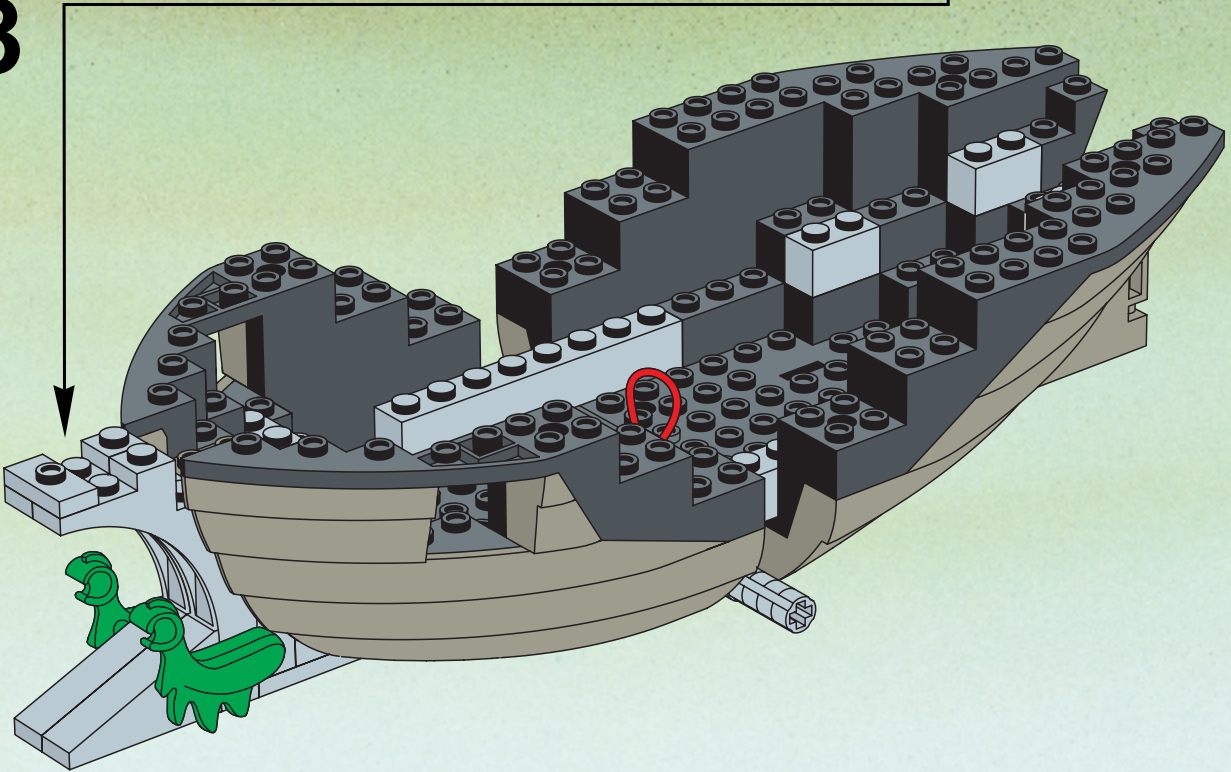

# 9

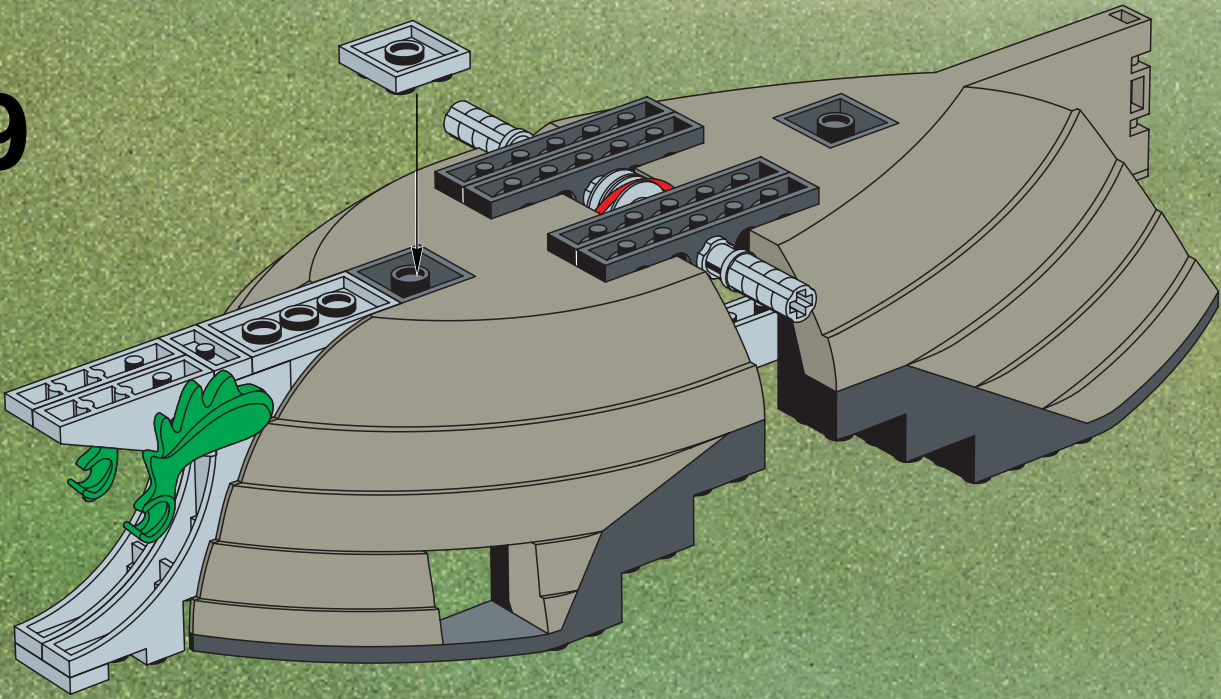

## 1

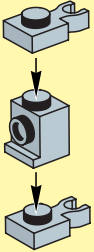

## 2

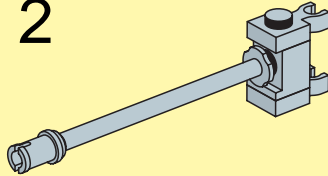

## 3

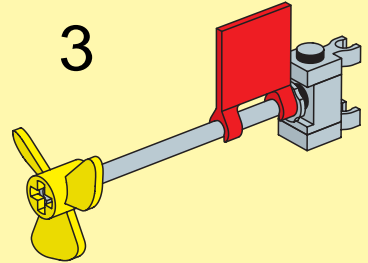

# 10

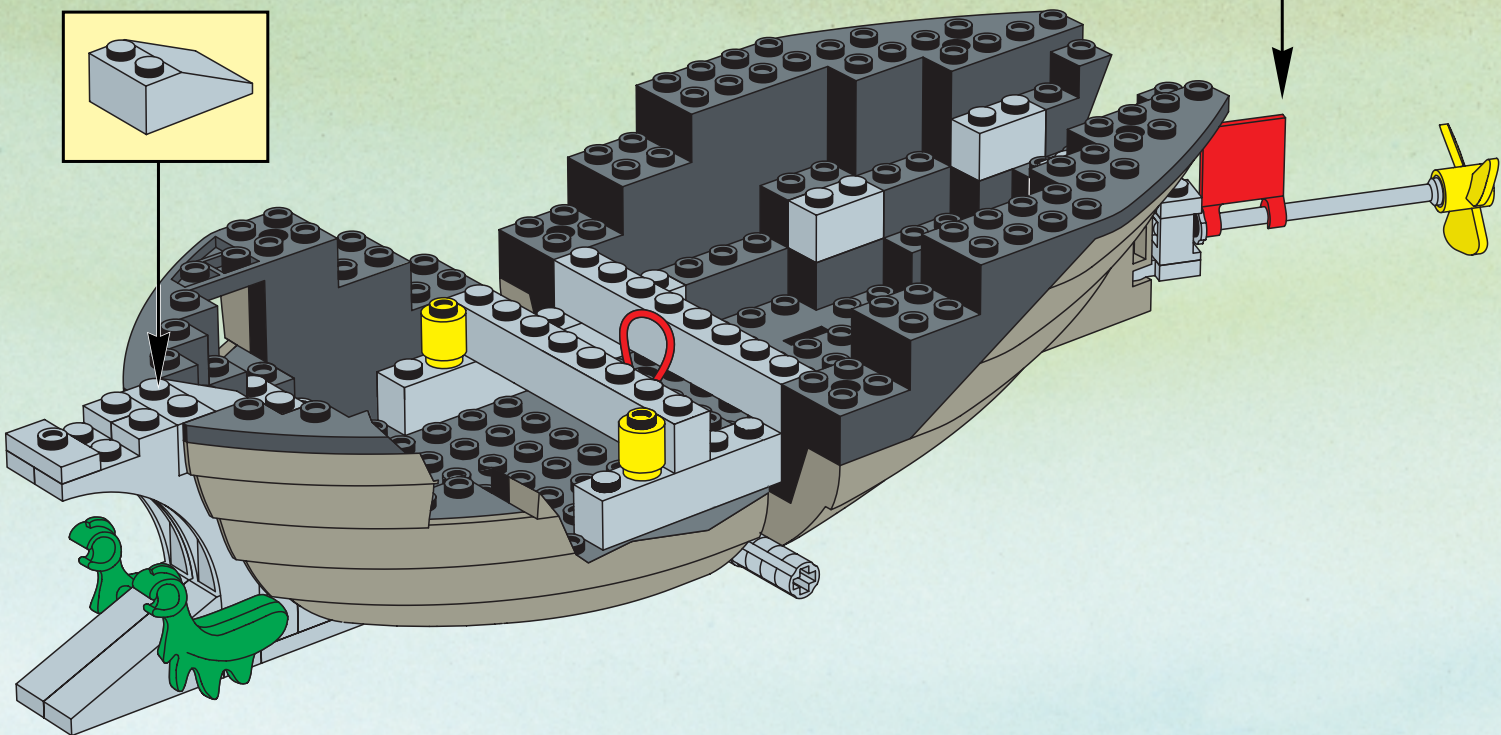
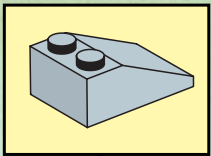

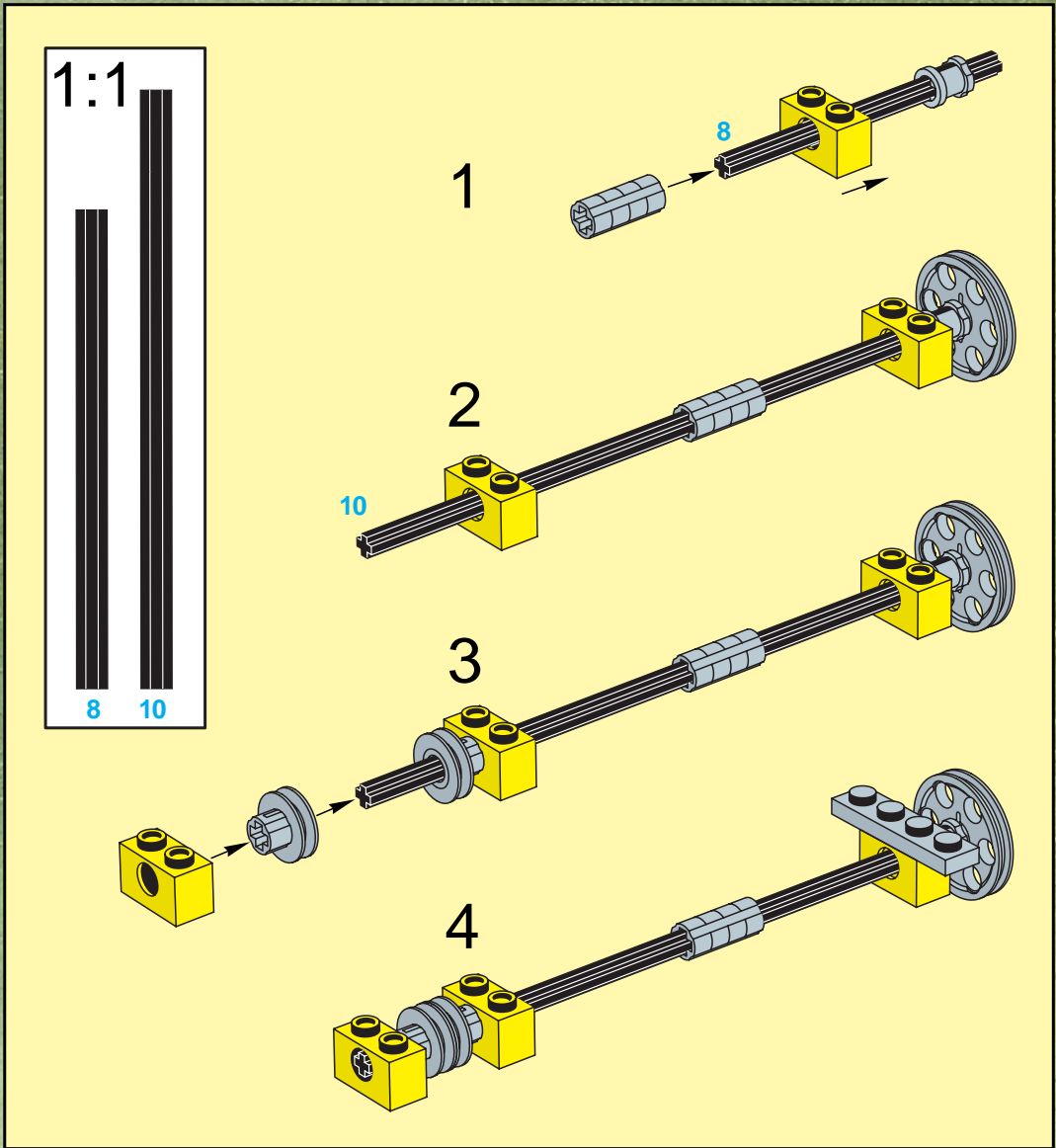

11

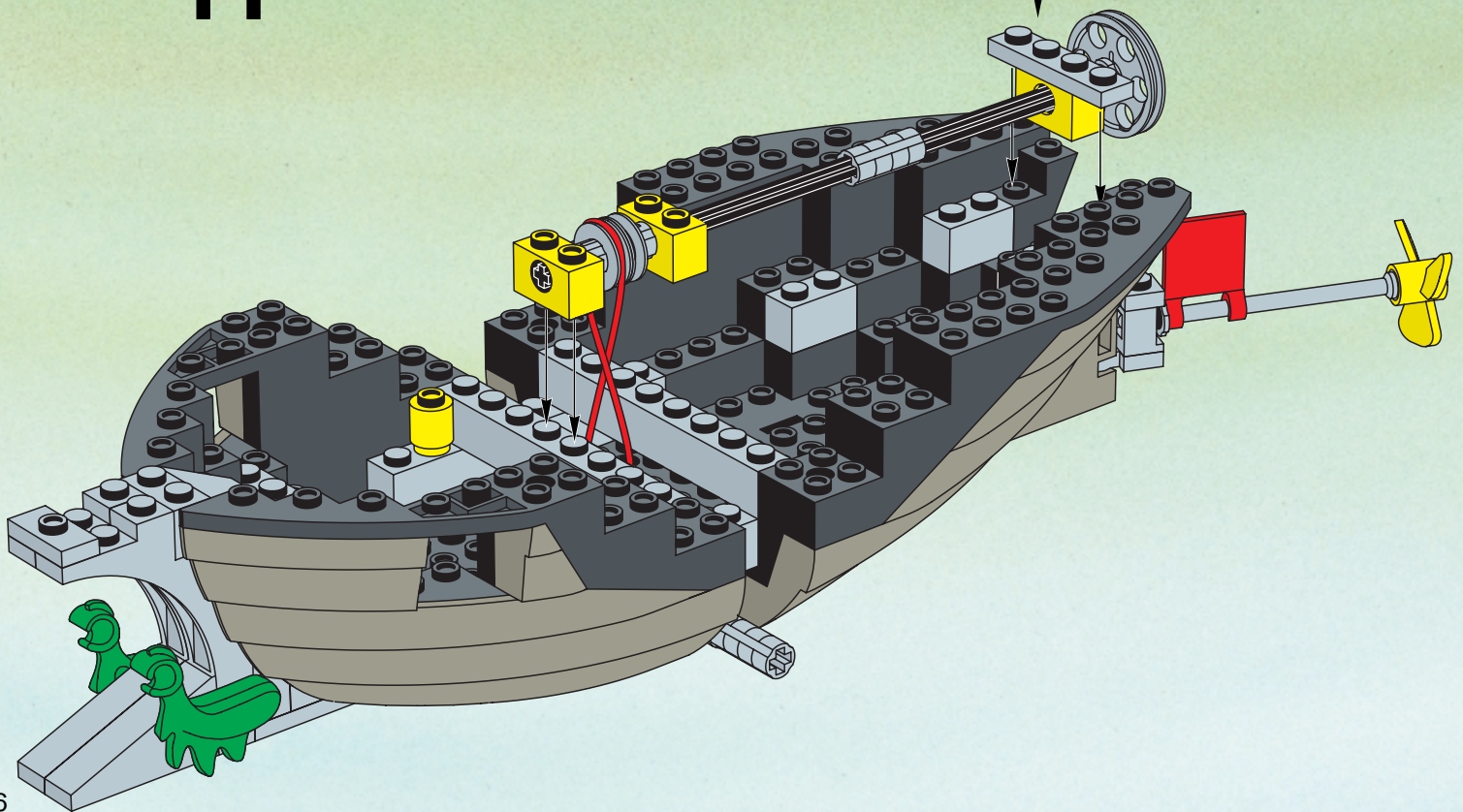

1

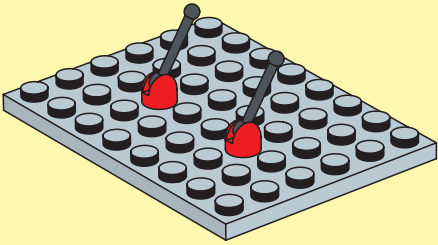

2

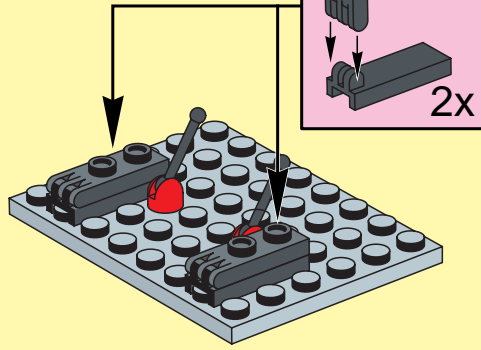

3

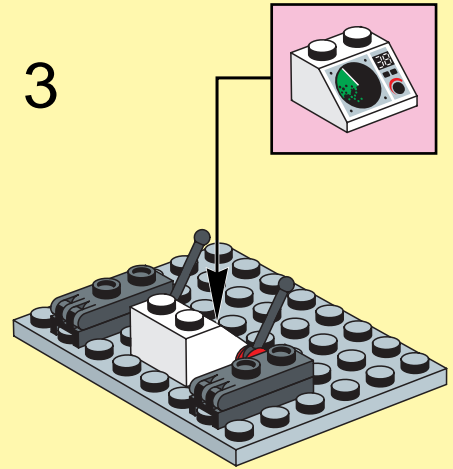

12

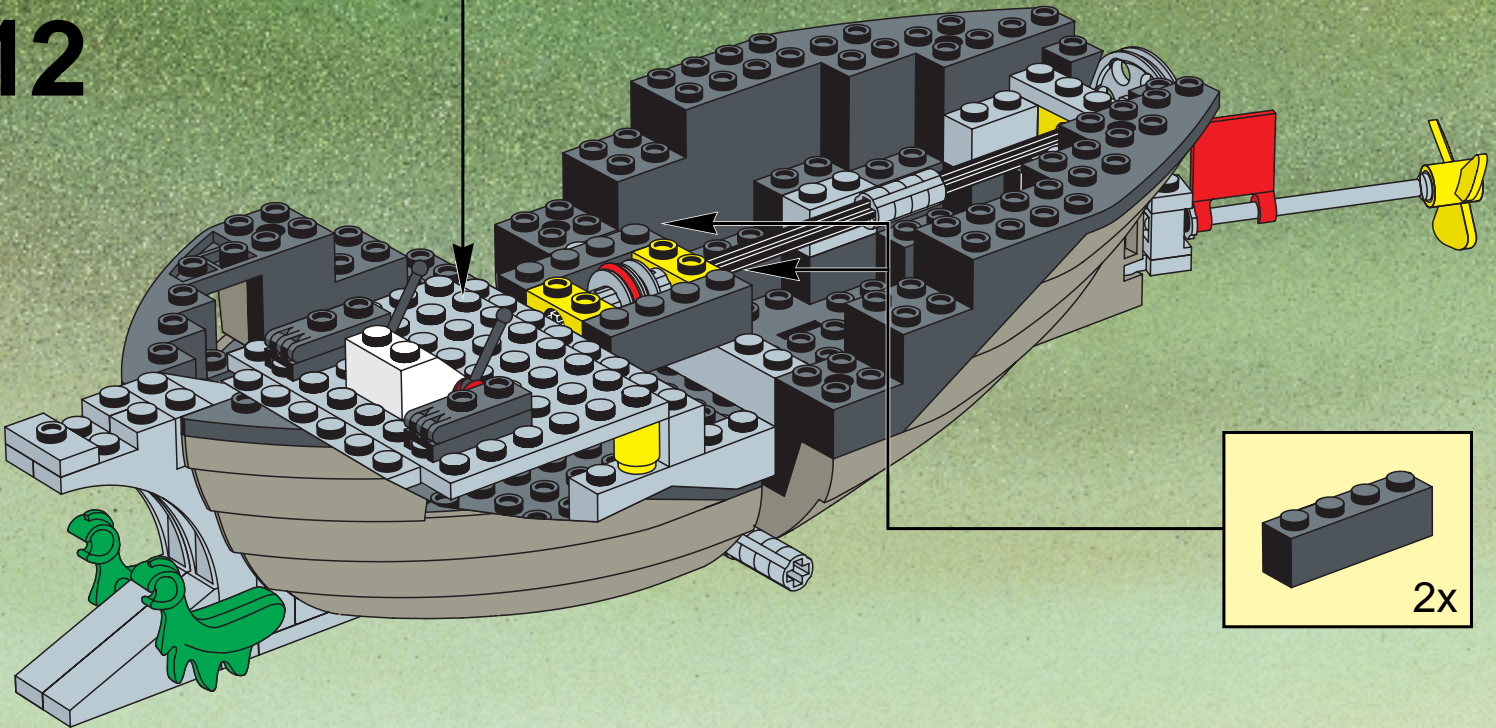

13

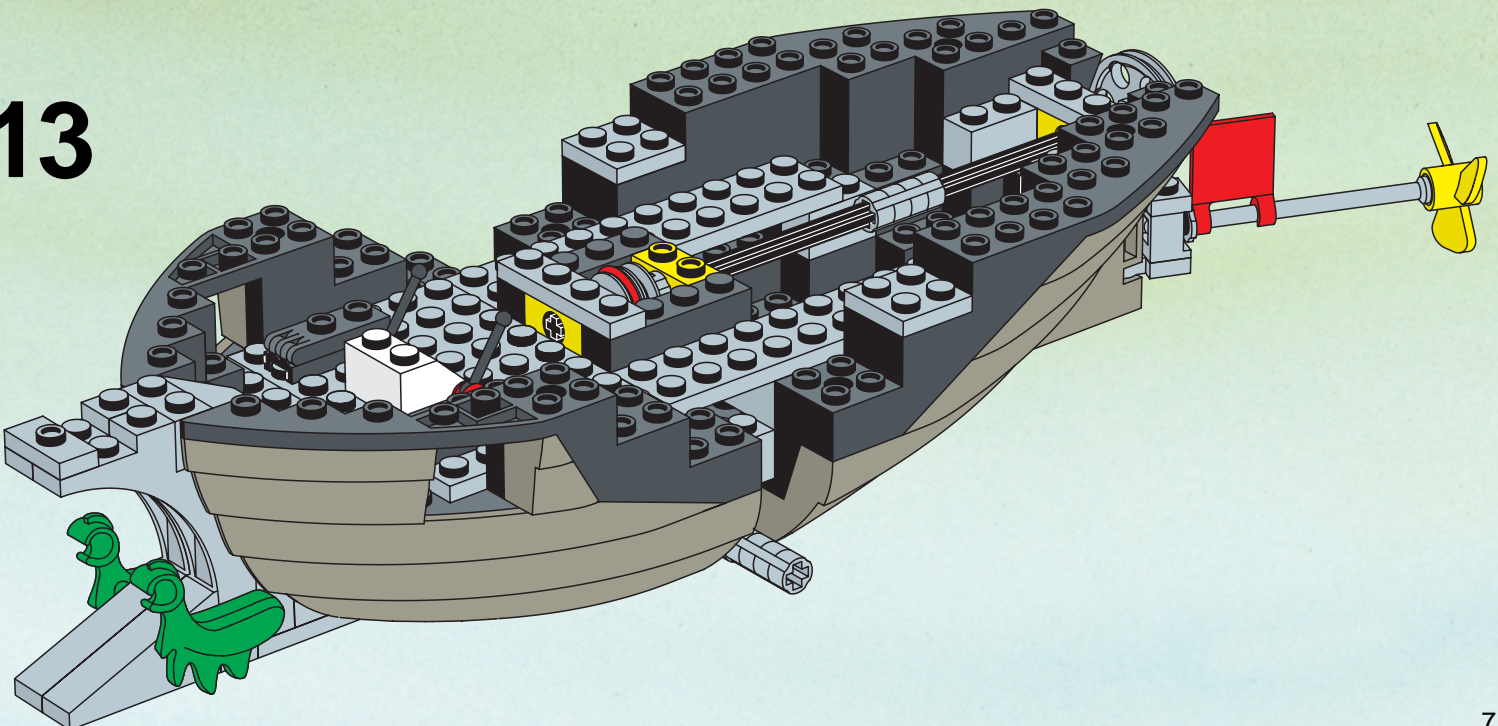

14

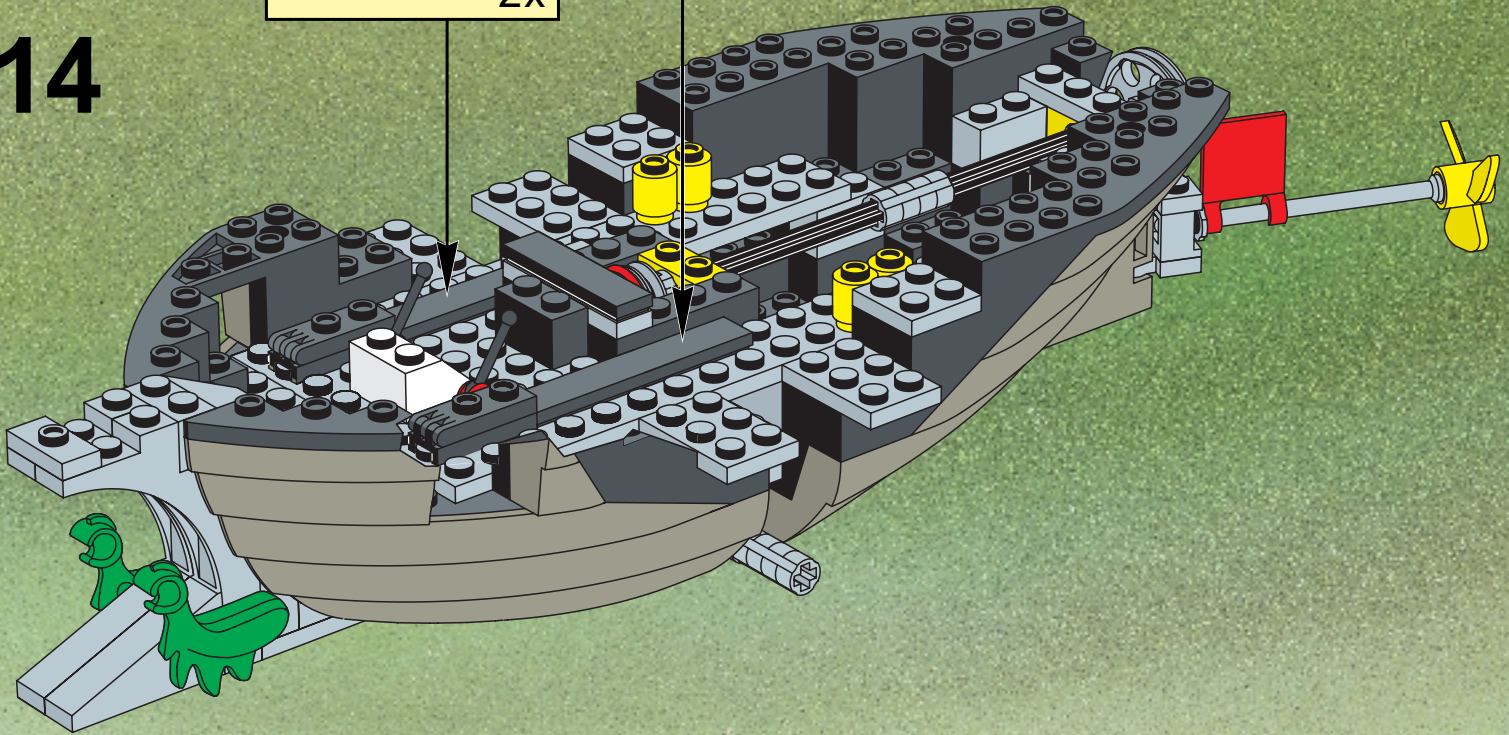
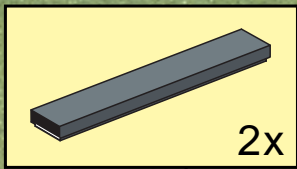

15

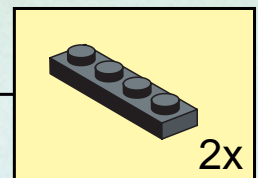
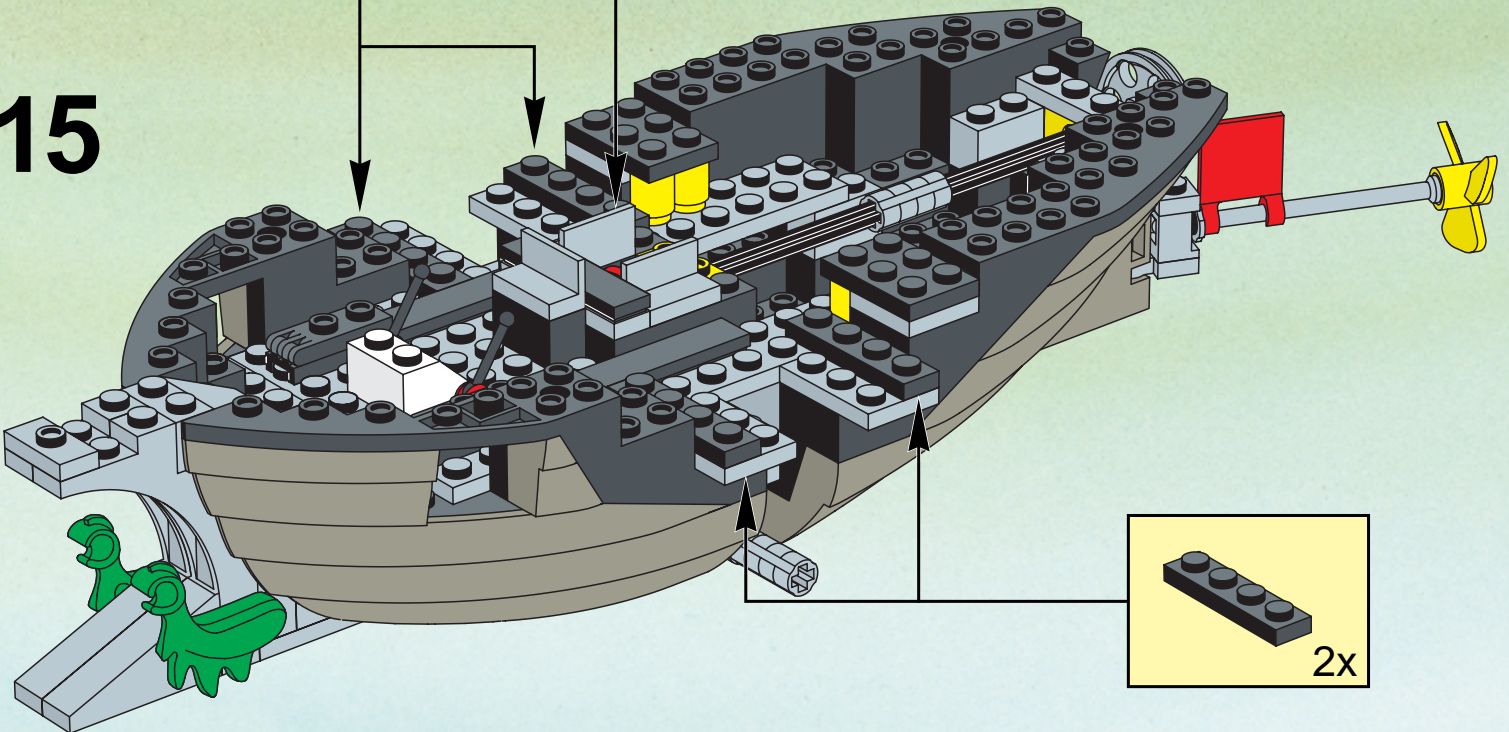
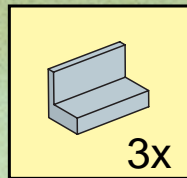
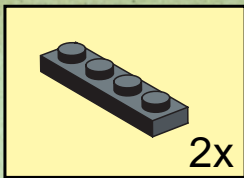



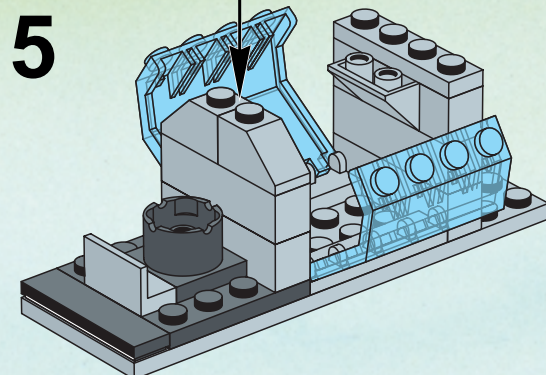
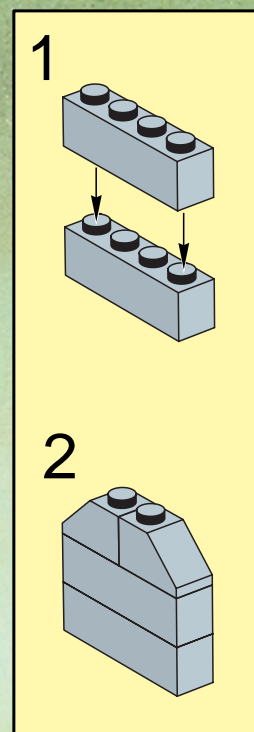
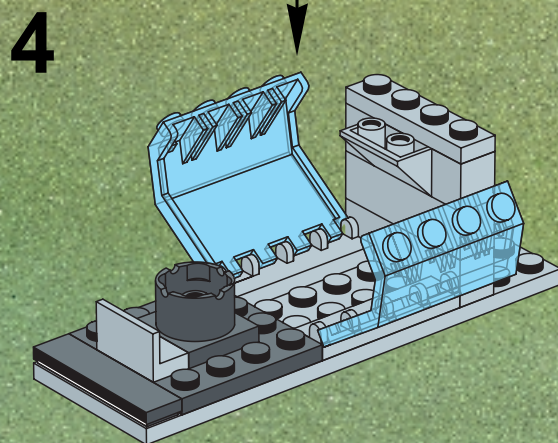
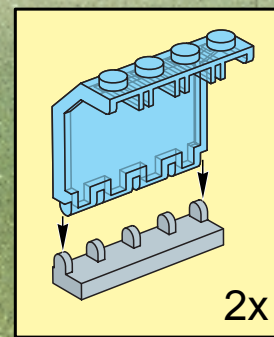
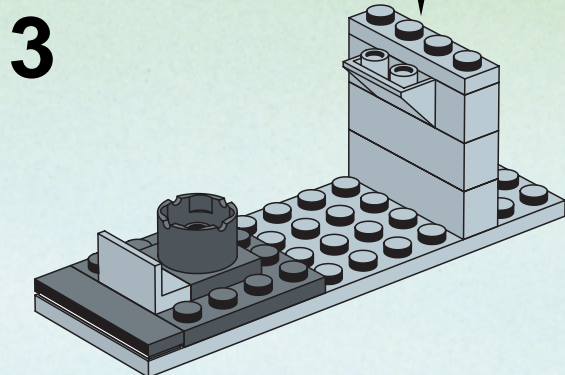
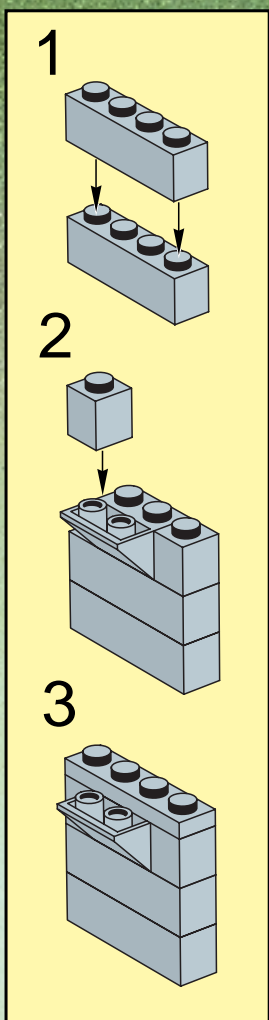
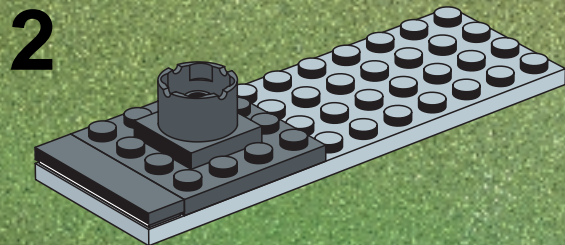
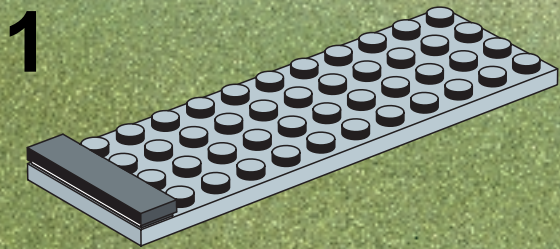

1:1

8

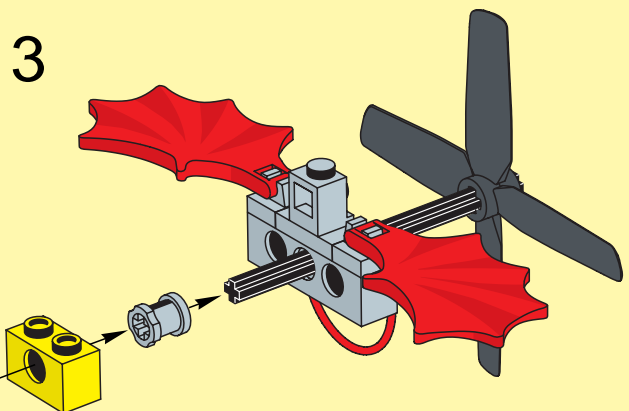
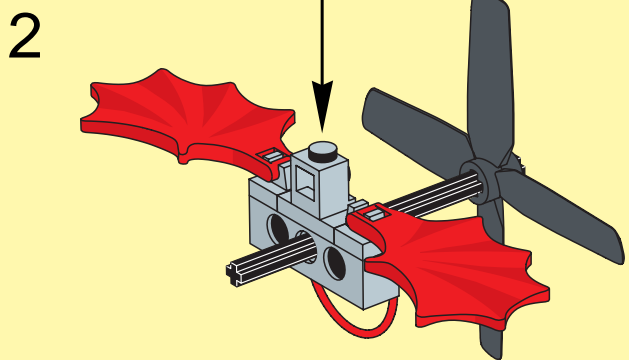
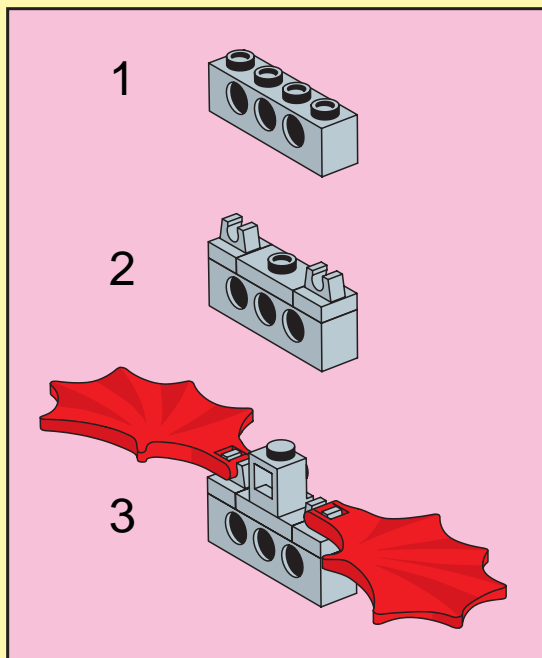
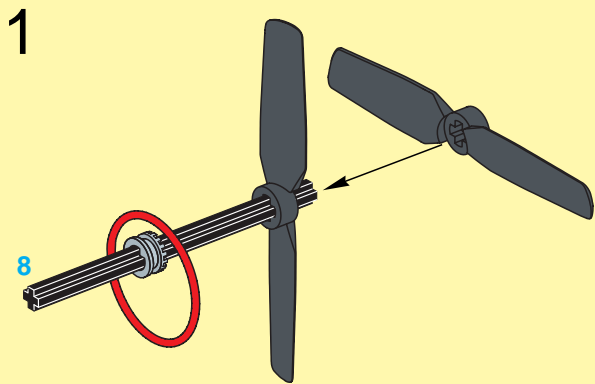

4

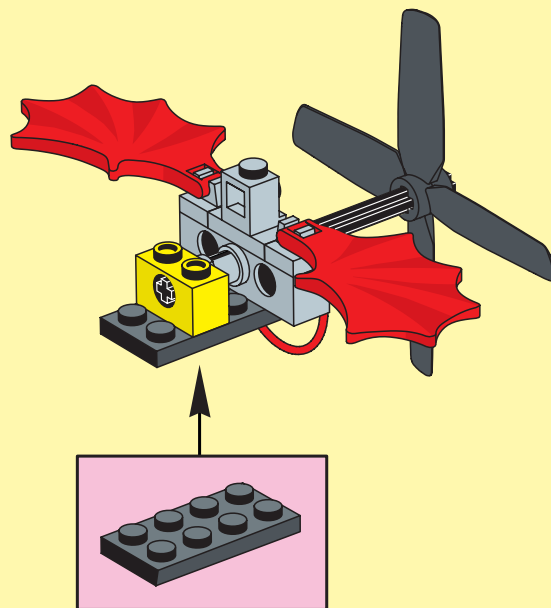

6

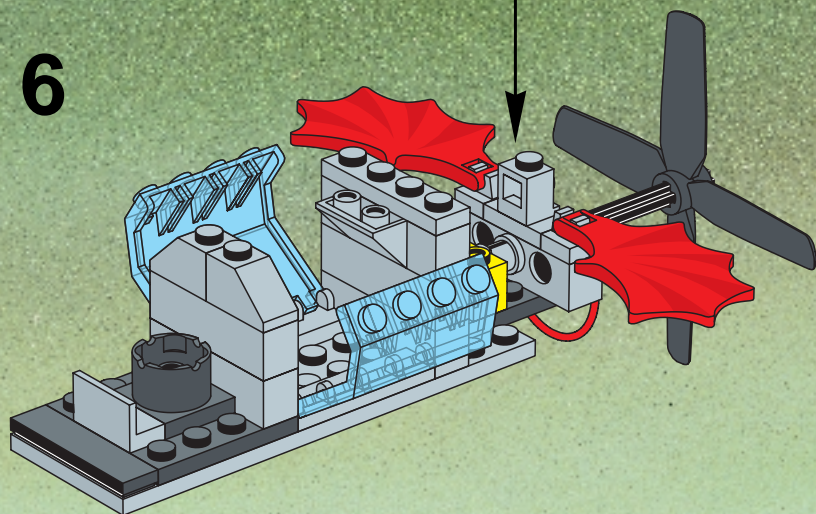

7

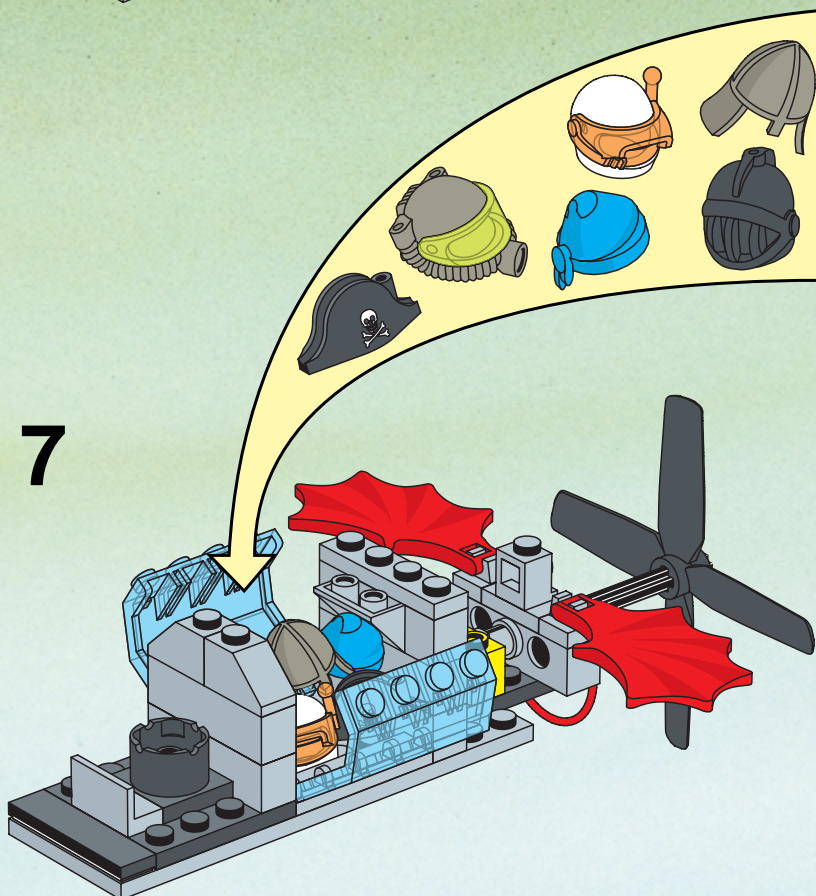

16

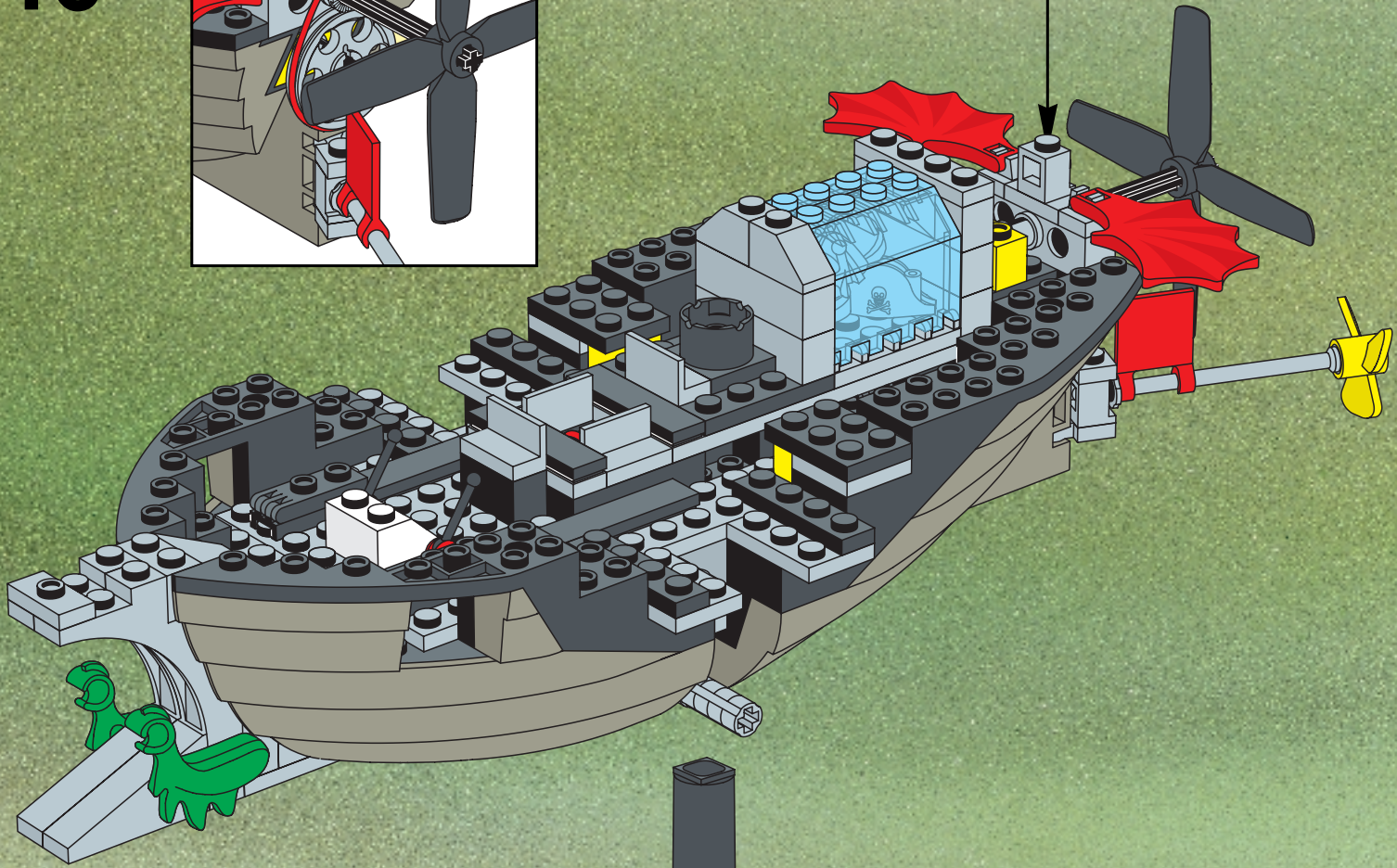
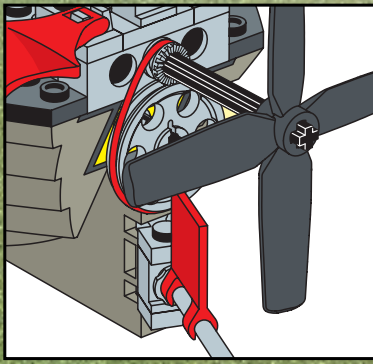

17

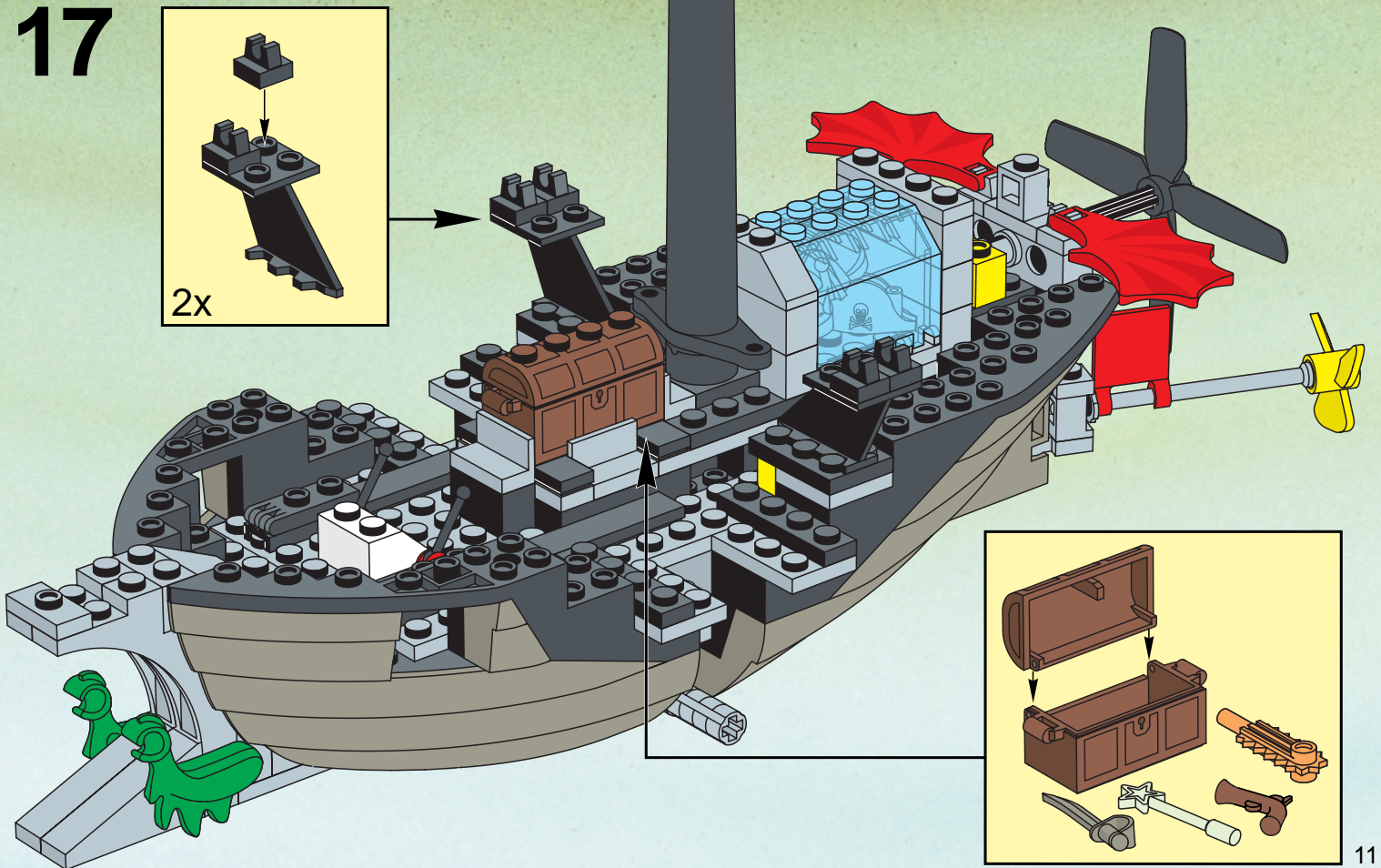
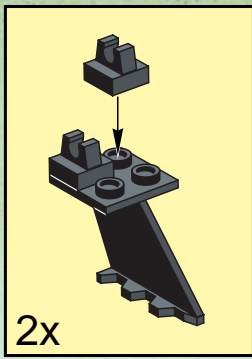

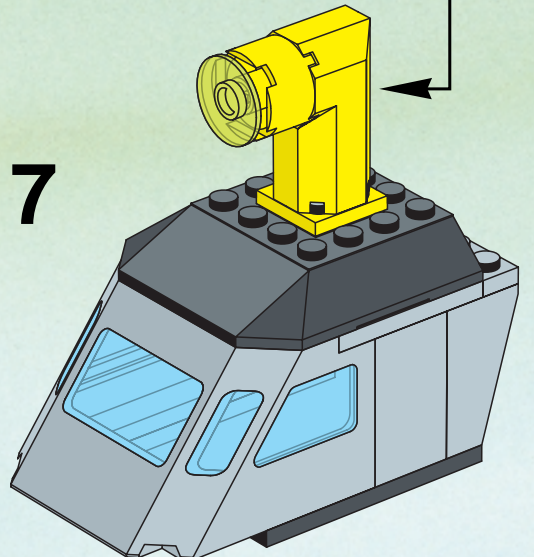
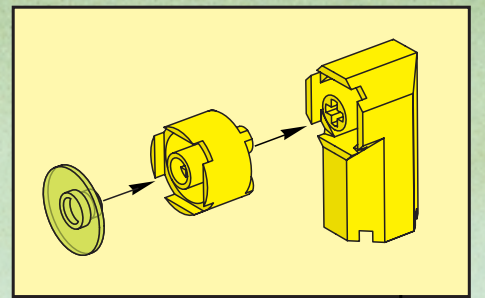
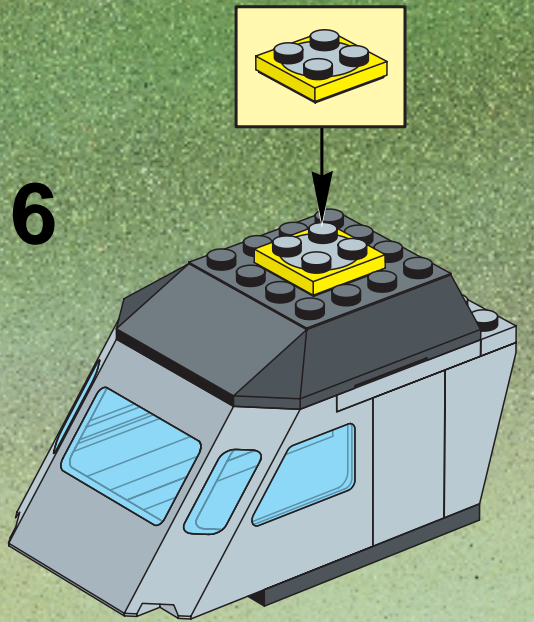
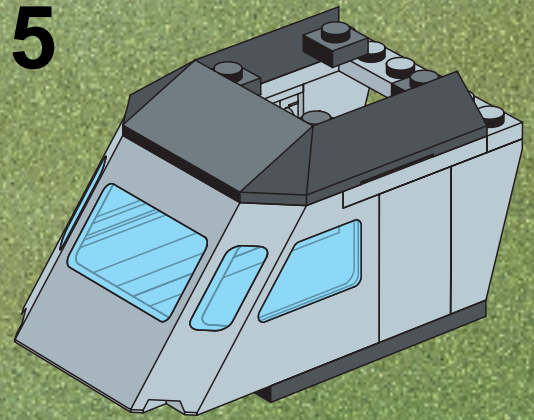
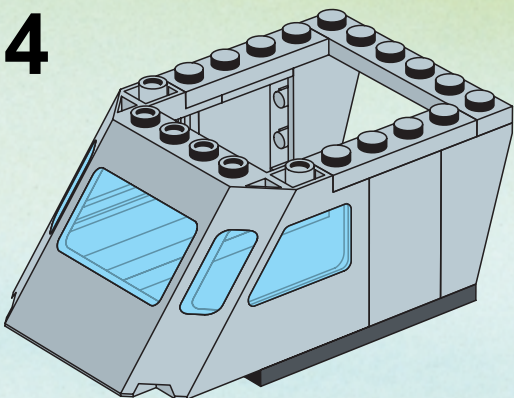
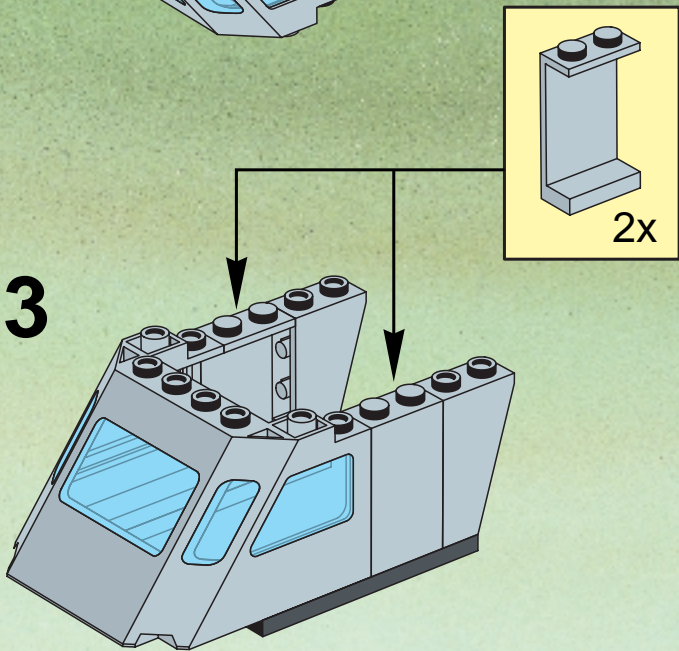
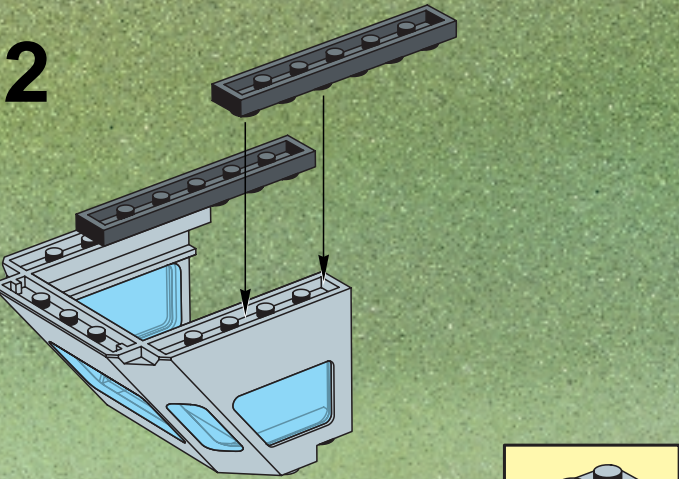
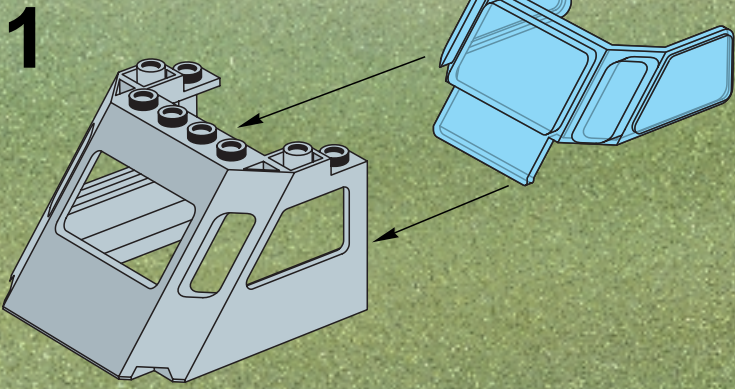

18

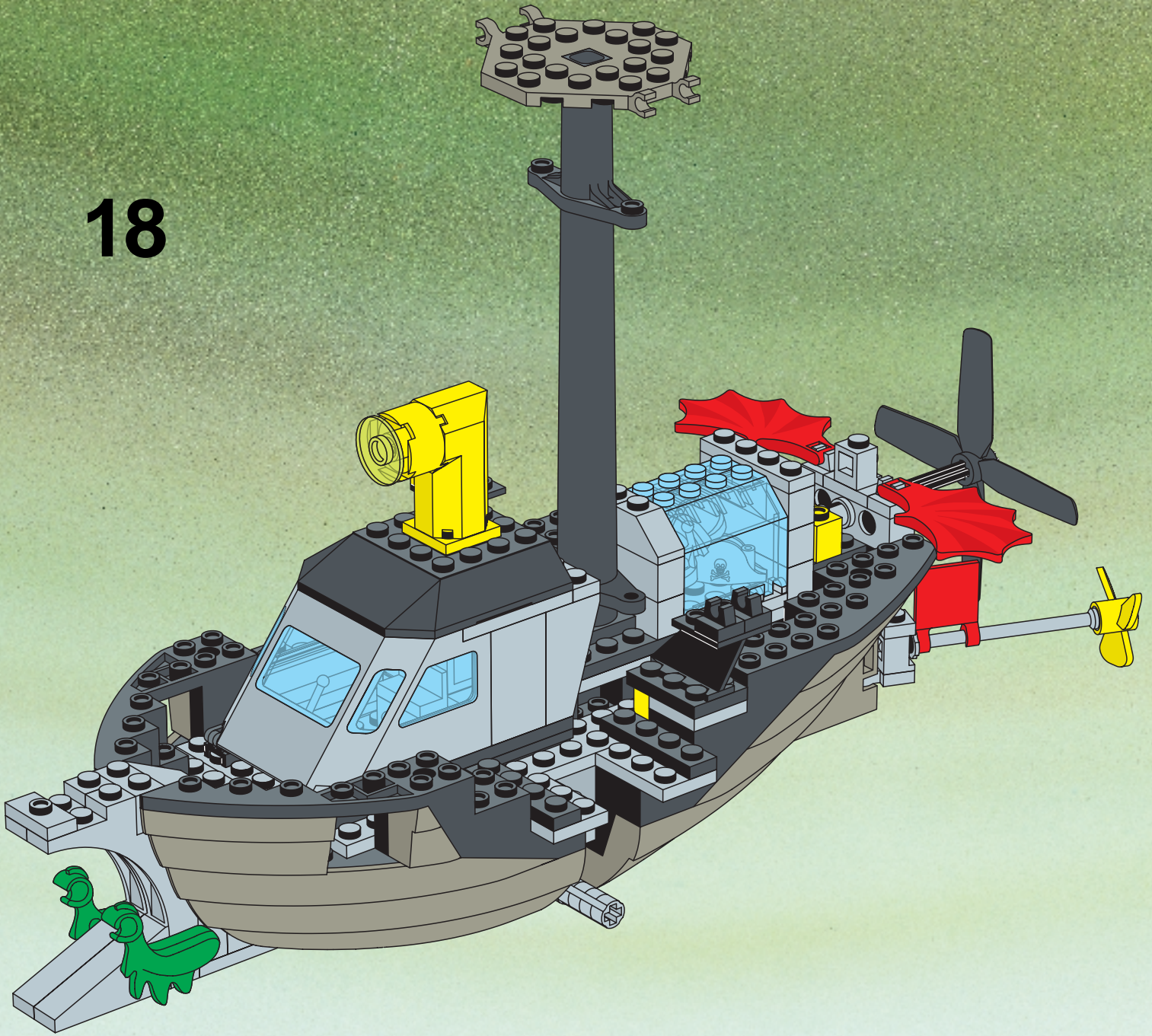

19

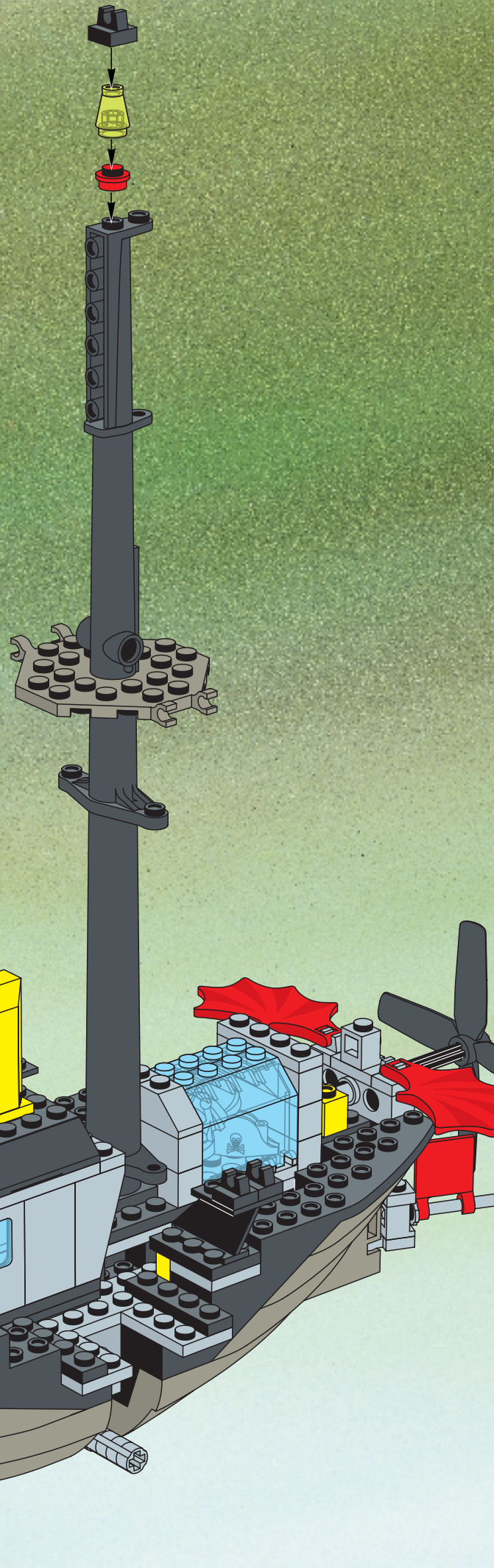
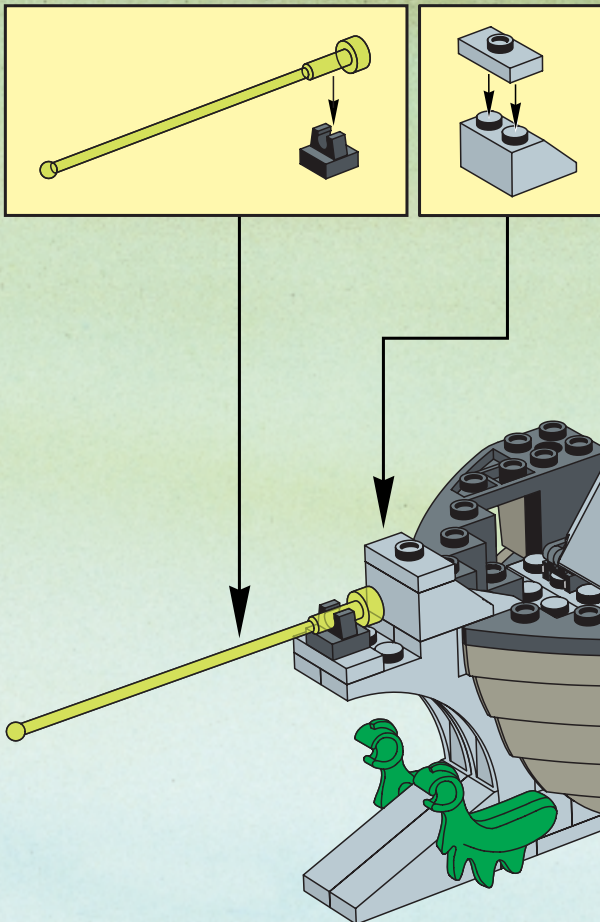

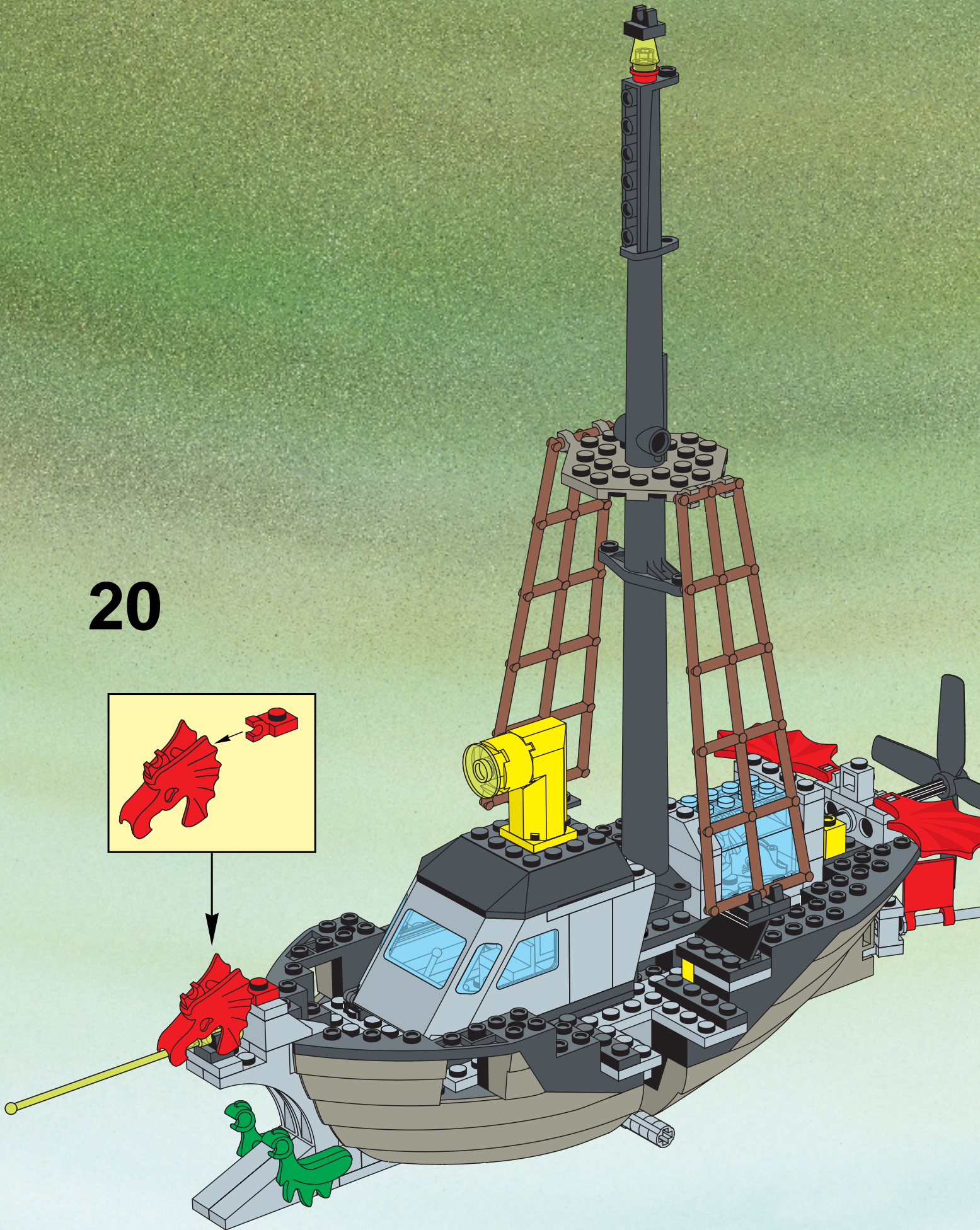
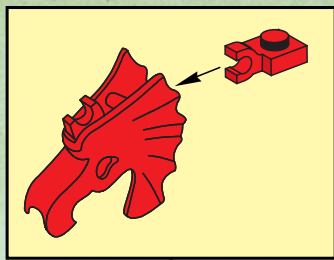

20



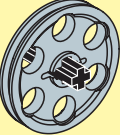

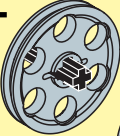
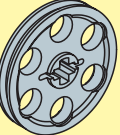
21

1 

2  

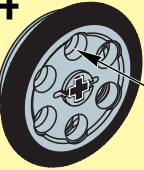
3 

4  

 2  
1:1

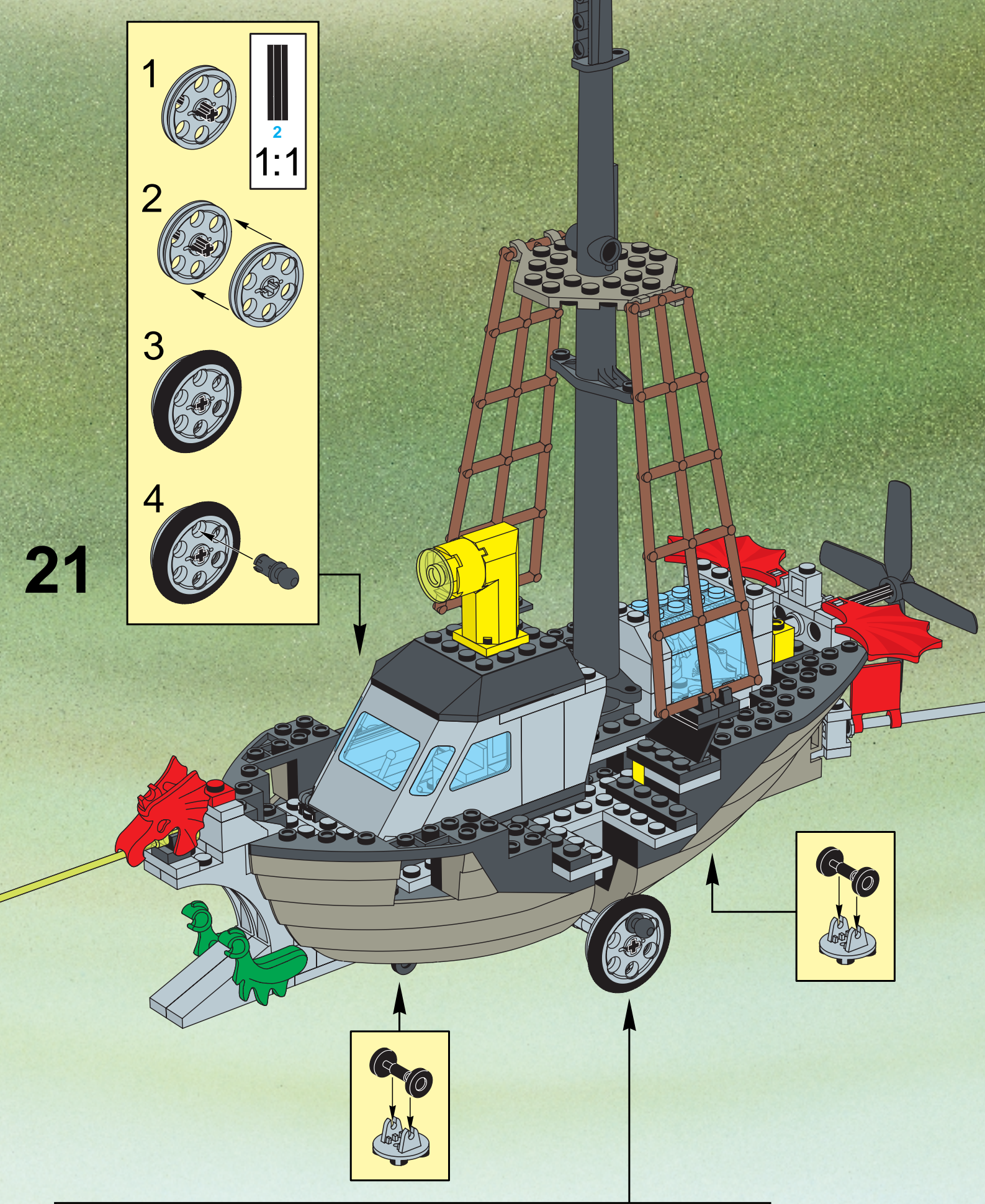



A sub-diagram showing a LEGO axle being inserted into a motor or gear mechanism.

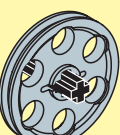

A sub-diagram showing a LEGO axle being inserted into a motor or gear mechanism.

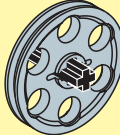
 2  
1:1

1 

2  

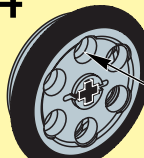
3 

4  



1

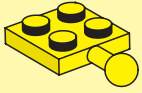

2

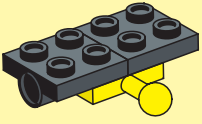

3

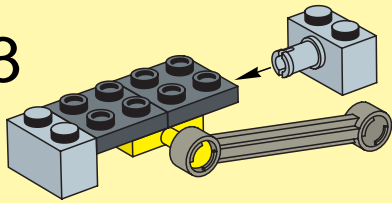

4

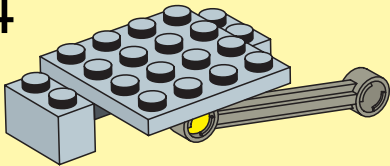

5

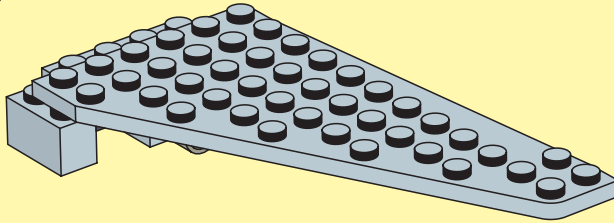

6

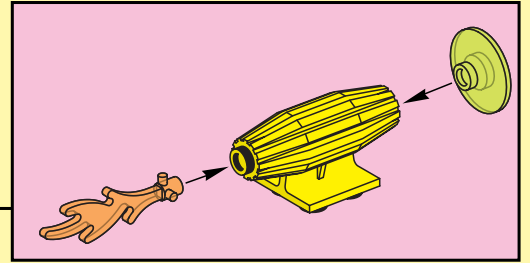
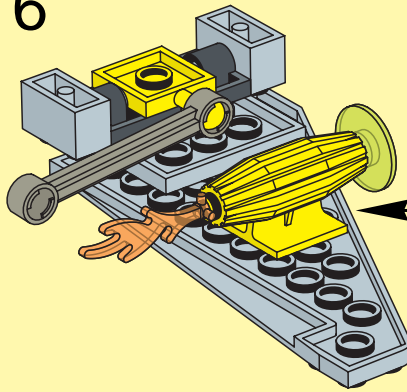

7

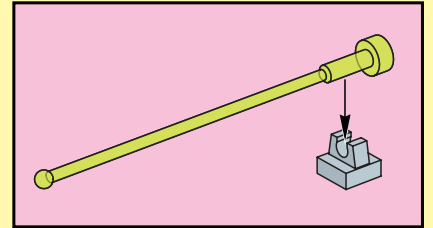
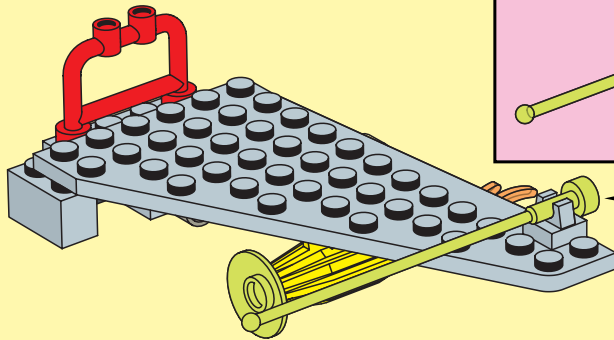

22

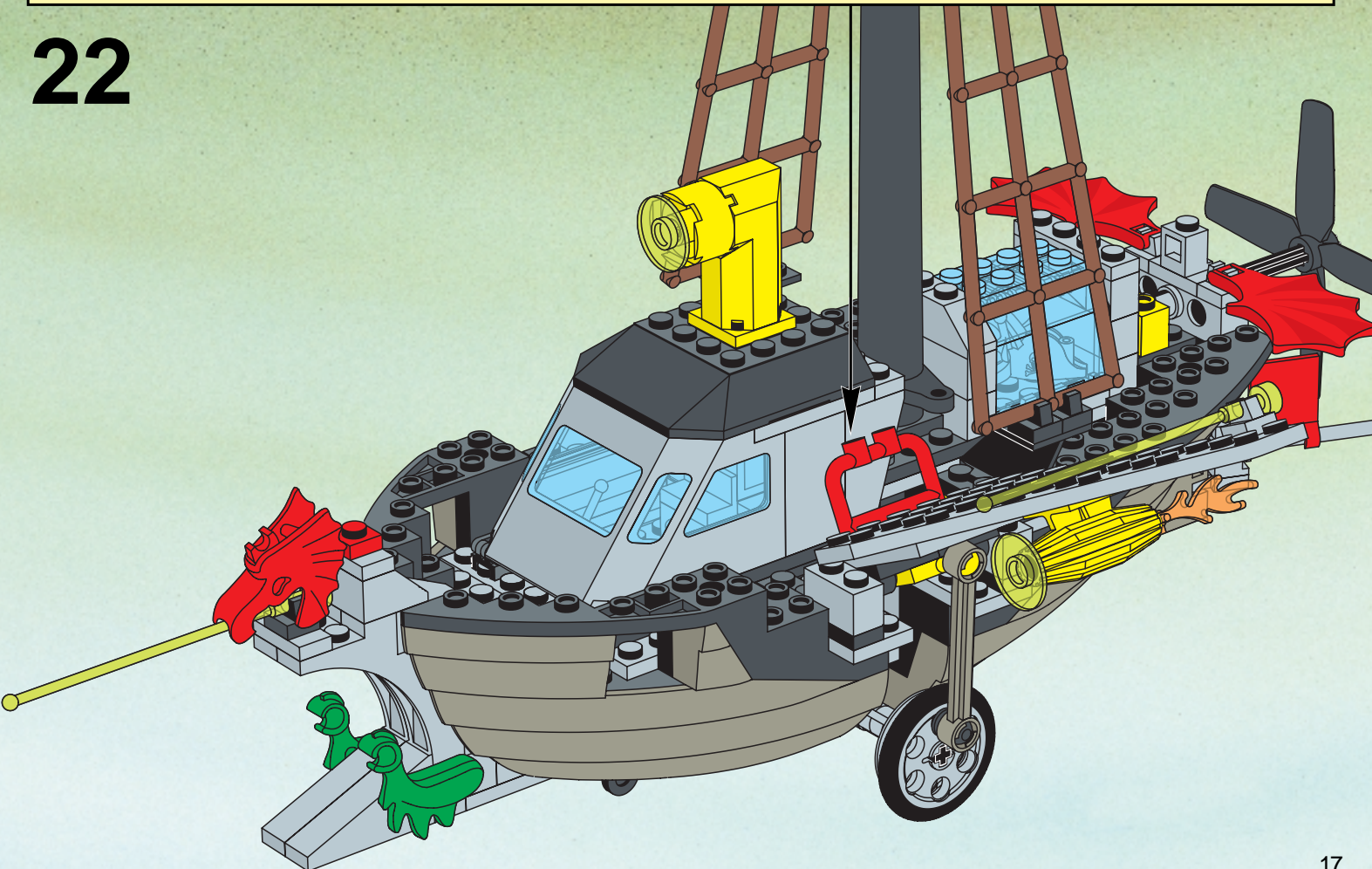

1

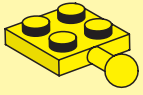

2

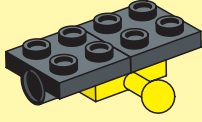

3

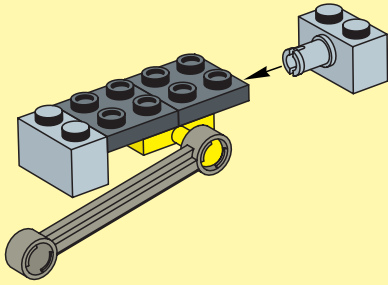

4

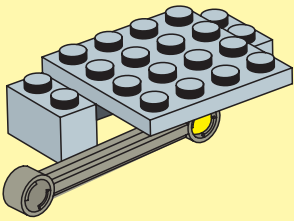

5

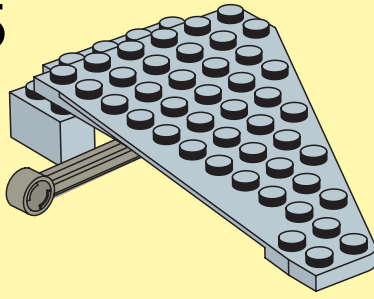

6

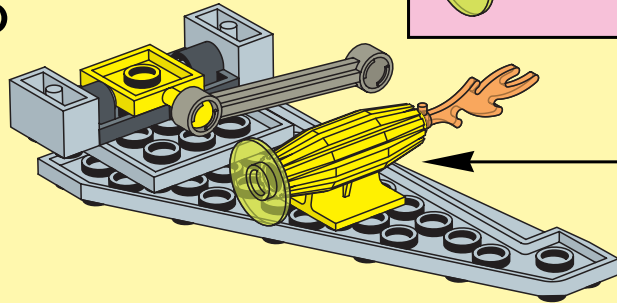

7

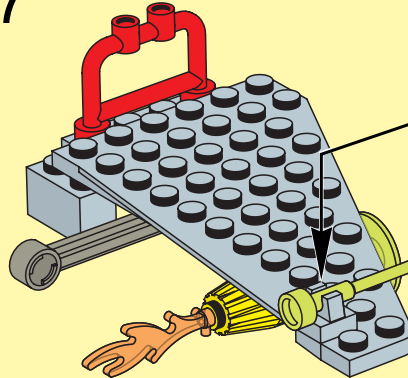

23

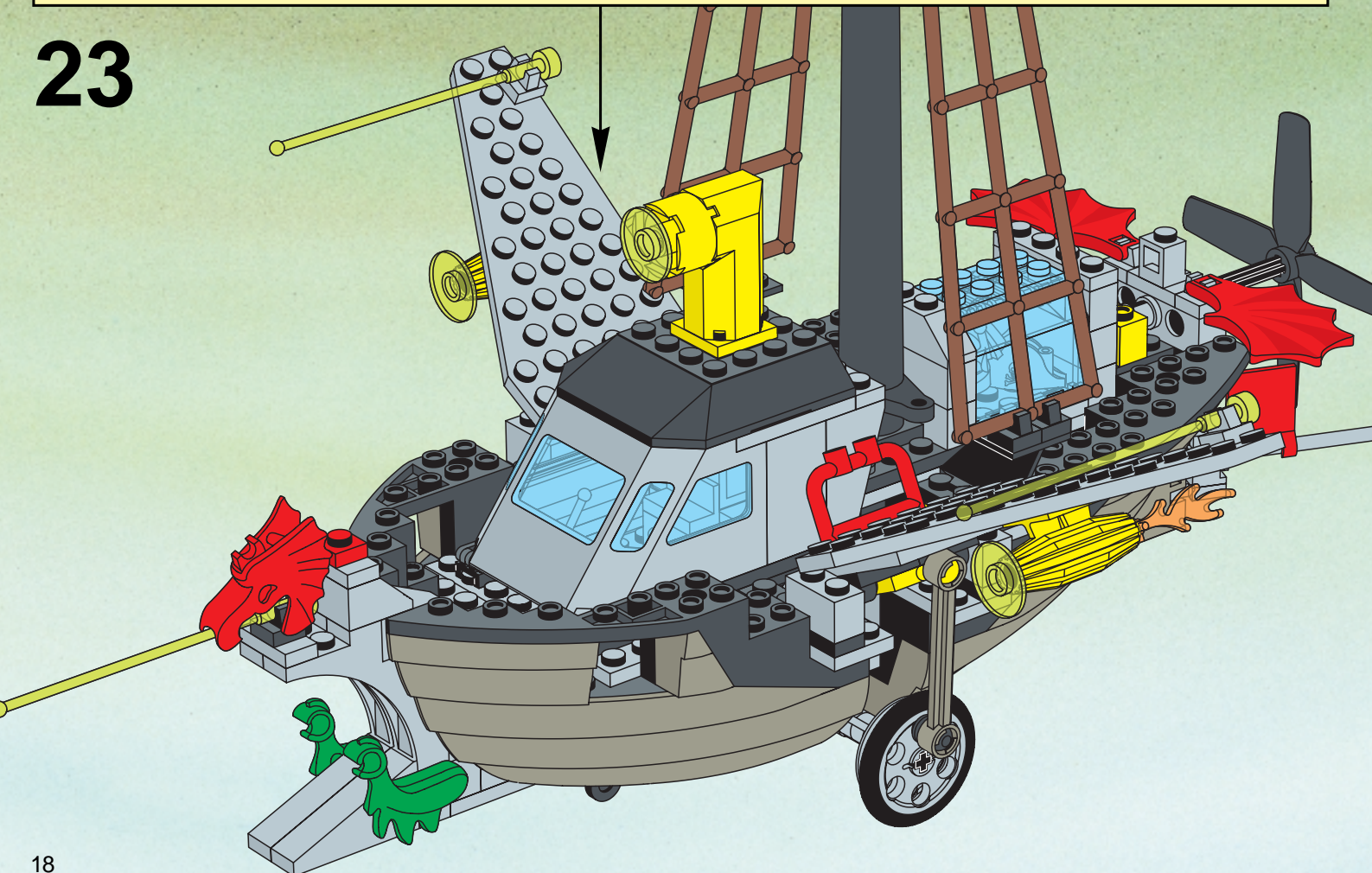

24

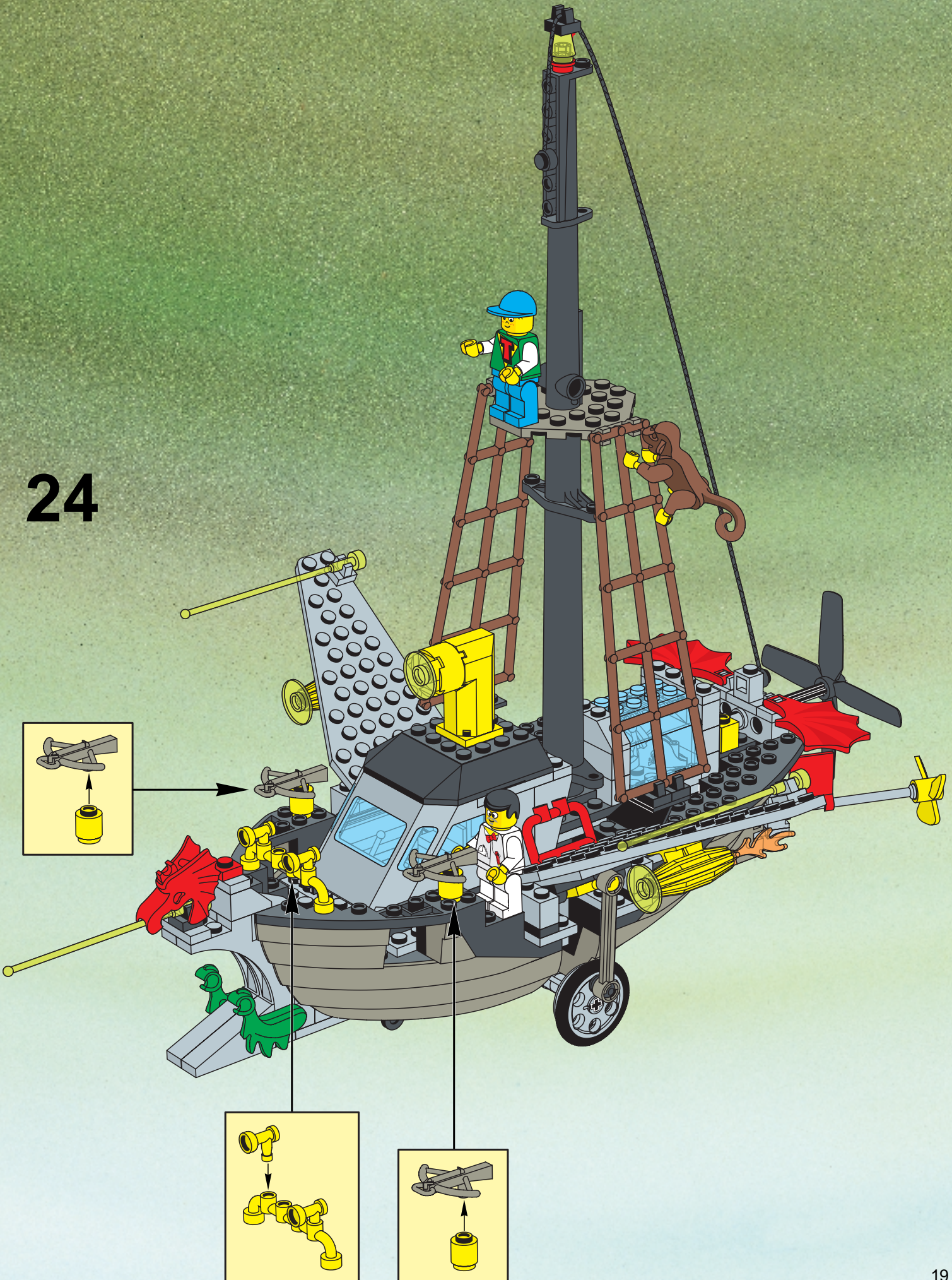

6493 1996

# TIME CRUISERS

