

# LE TITANIC

LIVRET 3

---

# LE PAQUEBOT INSUBMERSIBLE

Le RMS Titanic est doté de nombreux dispositifs de sécurité de pointe, mais la réglementation désuète en matière de sécurité maritime n'exige que 20 canots de sauvetage à bord, soit juste assez pour accueillir un tiers de l'équipage et des passagers. Peu avant minuit le 14 avril 1912, le navire heurte un iceberg à haute vitesse et sombre. Le nombre limité de canots ne permet de sauver que 710 personnes, les 1 500 autres périssant en mer. Suite à cette tragédie, de nouvelles normes de sécurité internationales, dont plusieurs sont encore en vigueur aujourd'hui, sont instaurées.



↑ Canots de sauvetage dans leurs bossoirs sur le Titanic.

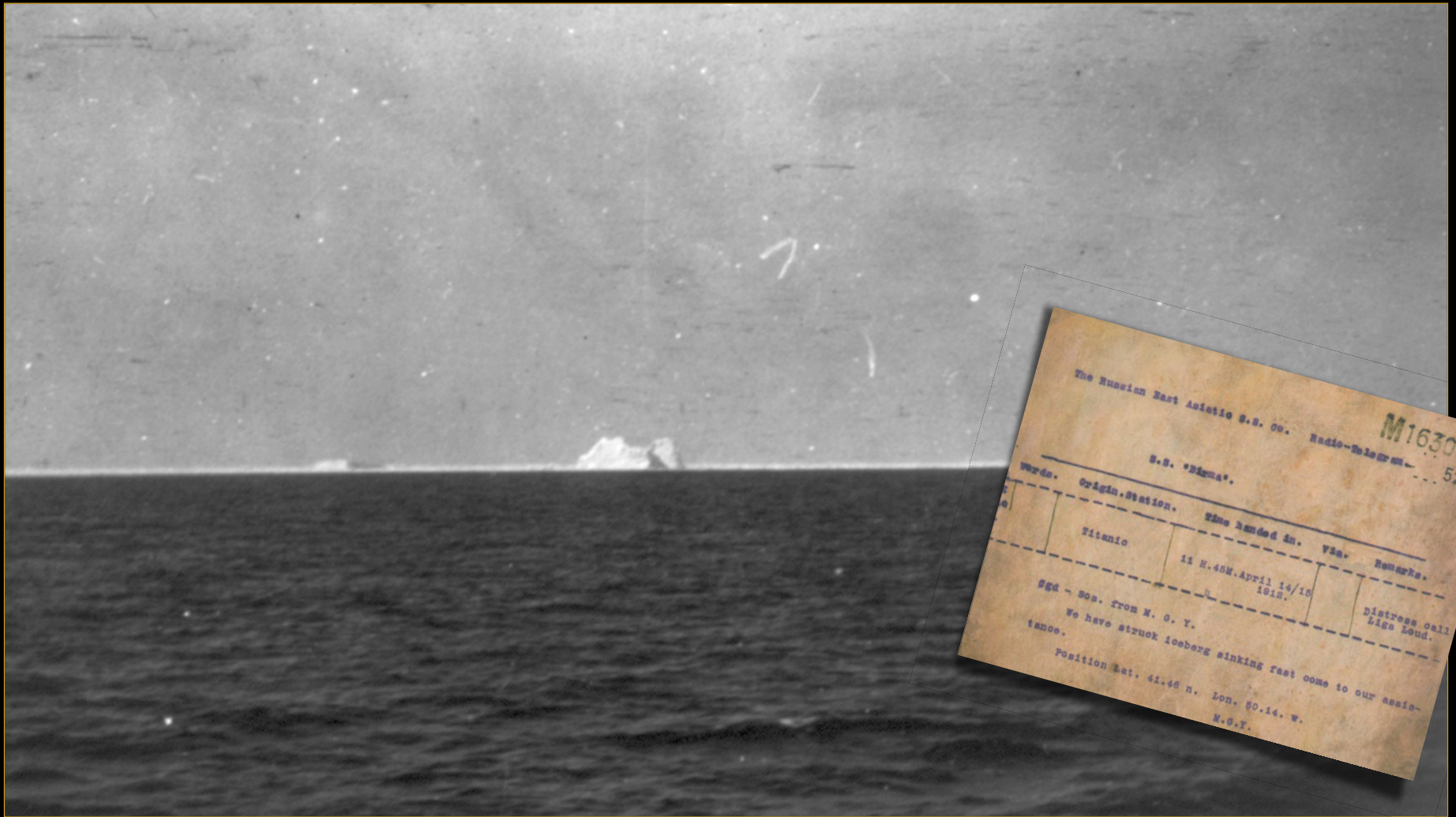

↑ Photo de l'emplacement présumé de la catastrophe prise depuis le SS Carpathia, qui a recueilli des survivants du Titanic.

↗ Un télégramme transmis du RMS Titanic au SS Birma, demandant de l'aide.

# UNE AMPLIEUR TITANESQUE

À son lancement, le Titanic est le plus grand navire jamais construit. Il mesure plus de 269 m de long et 53,3 m du fond de la coque jusqu'au sommet de ses cheminées. De même, la version LEGO® du RMS Titanic est le modèle LEGO le plus long jamais créé, et l'un des plus complexes.

*La version LEGO du Titanic est construite à l'échelle 1:200, la même que celle du set LEGO Architecture La statue de la Liberté.*

*Le Titanic est 11 fois plus long que la baleine bleue, le plus grand animal ayant existé sur Terre.*

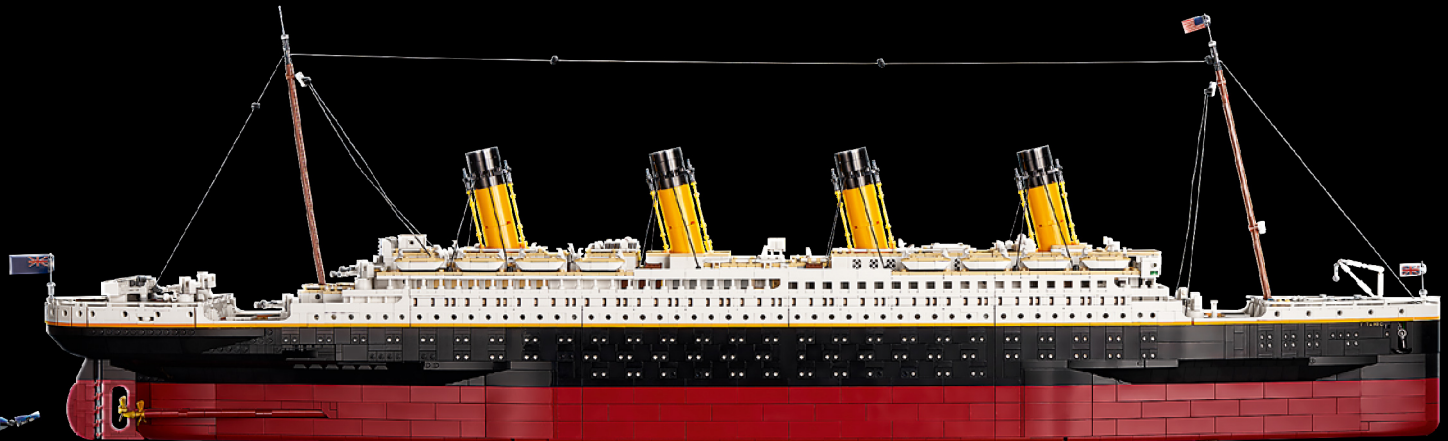



[LEGO.com/brickseparator](https://www.LEGO.com/brickseparator)

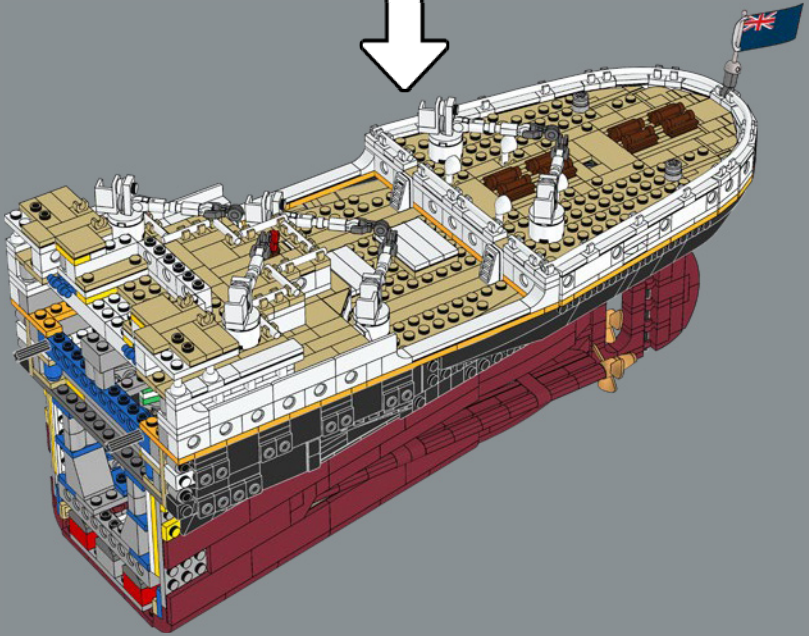
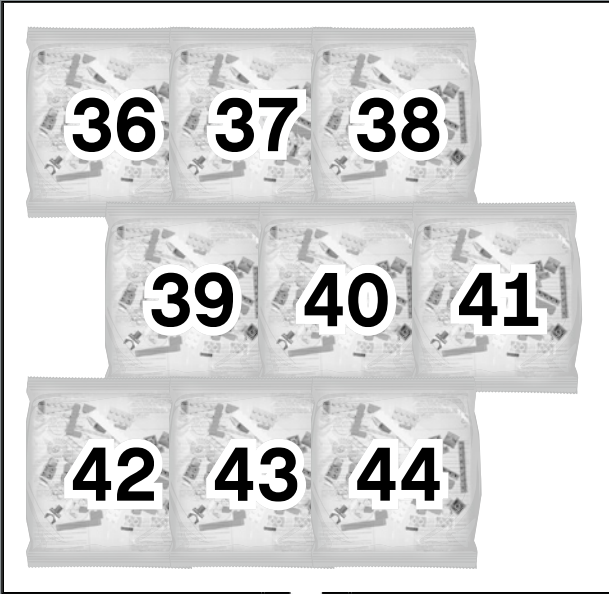
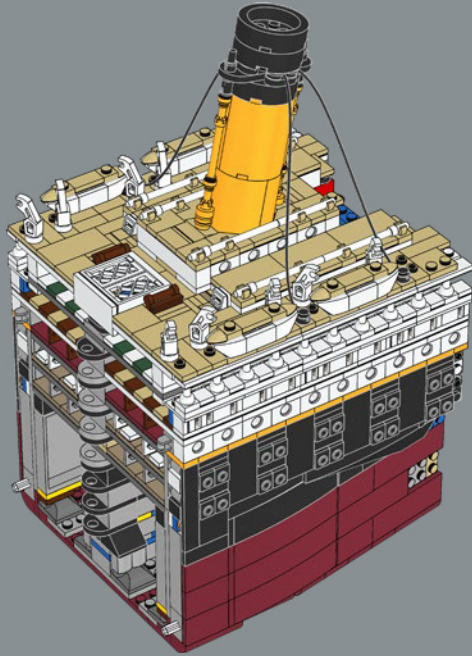
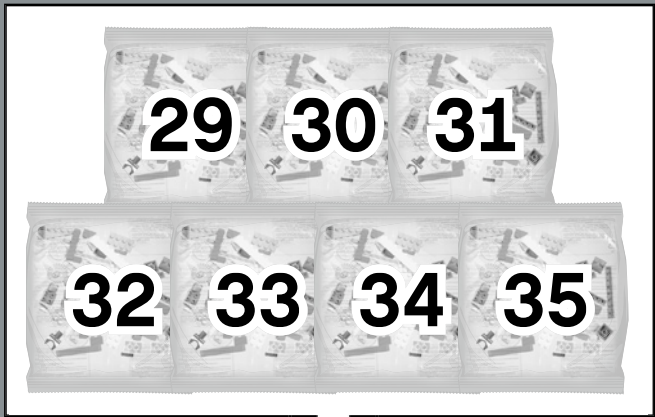

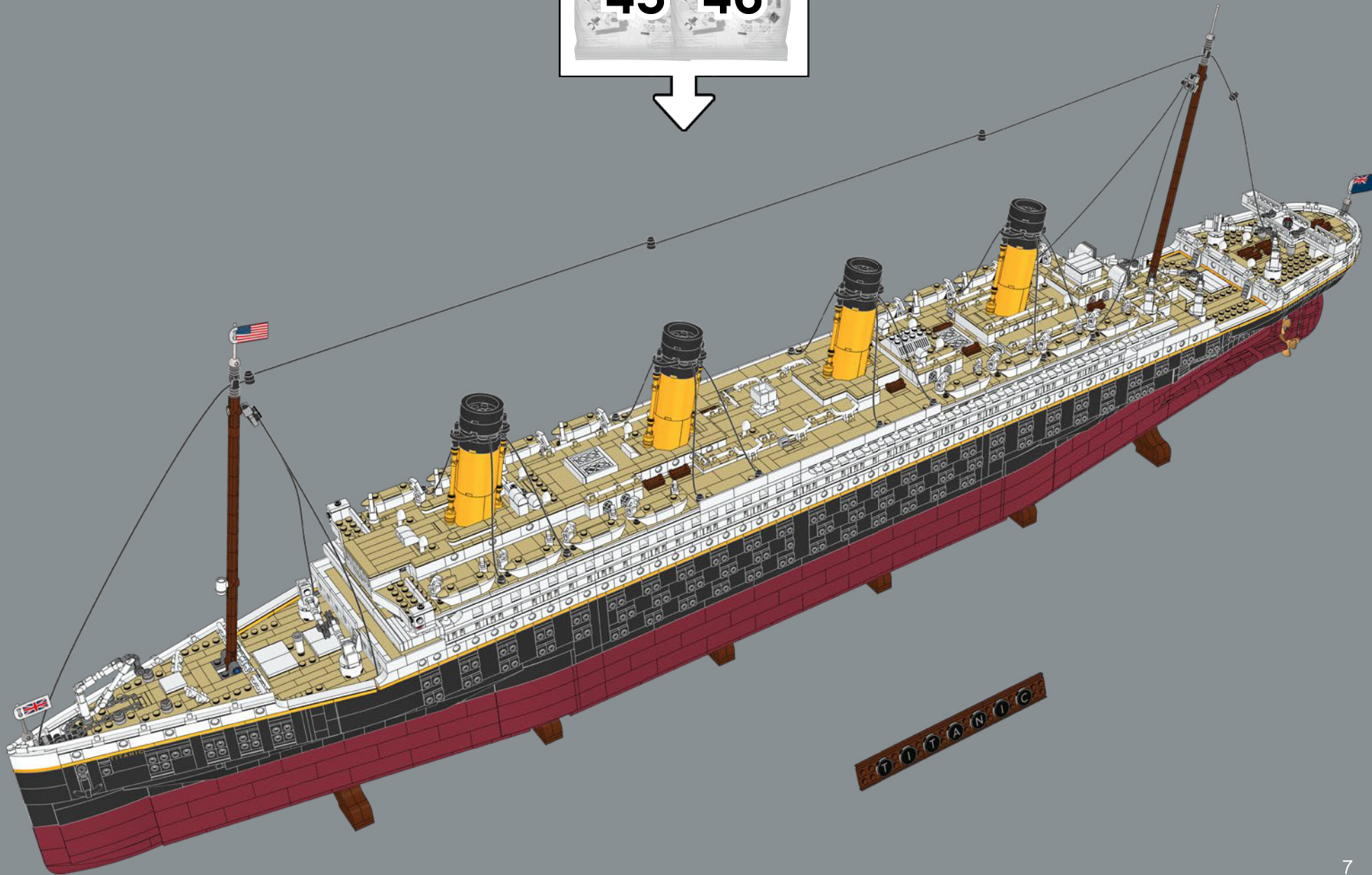
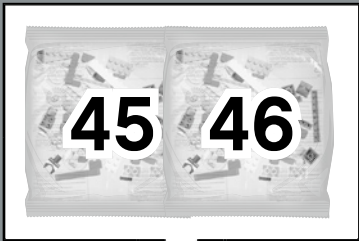

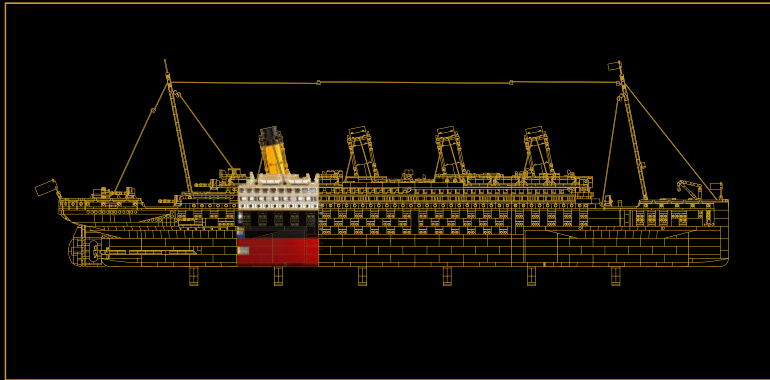

SECTION 5 :

## CHEMINÉE ET SALLE DES MACHINES

Dans cette section, le modèle s'affine vers la poupe du navire, où se trouvent les hélices et le gouvernail. Vous construirez également la dernière cheminée du modèle. Sur le vrai Titanic, cette cheminée n'est reliée à aucune chaudière, et fait tout simplement partie de la conception du navire pour lui donner une apparence plus élégante.

↓ Tout en haut de cette section, vous ajouterez la salle de lecture et certaines cabines de la 2e classe.





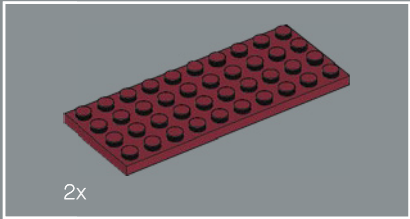
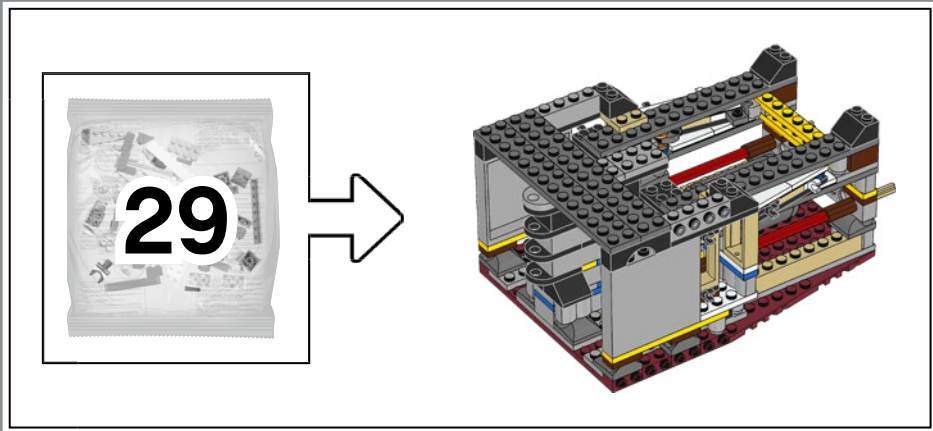

1

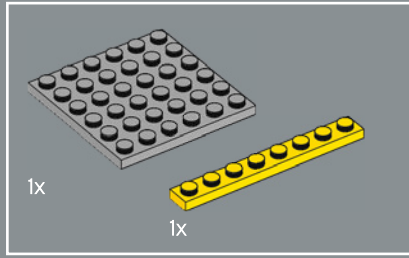
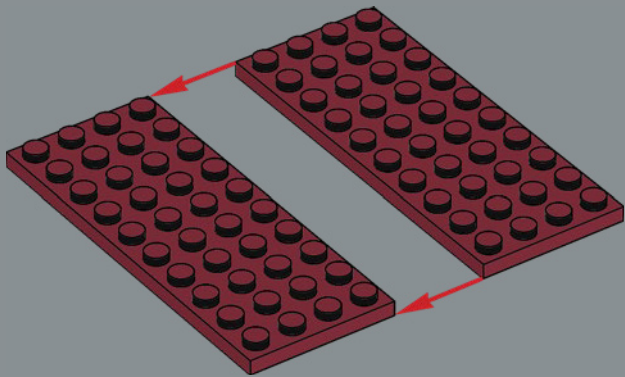

2

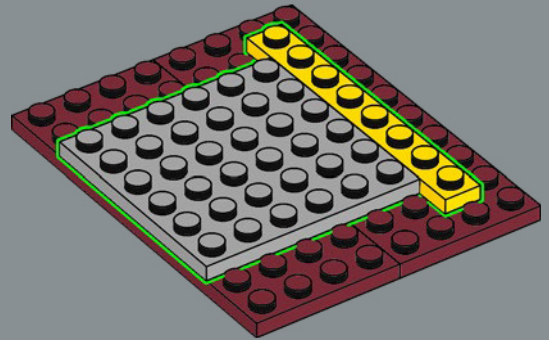

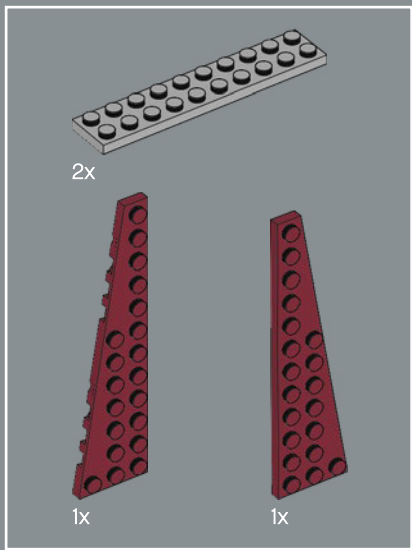

3

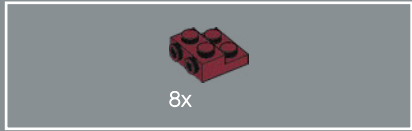
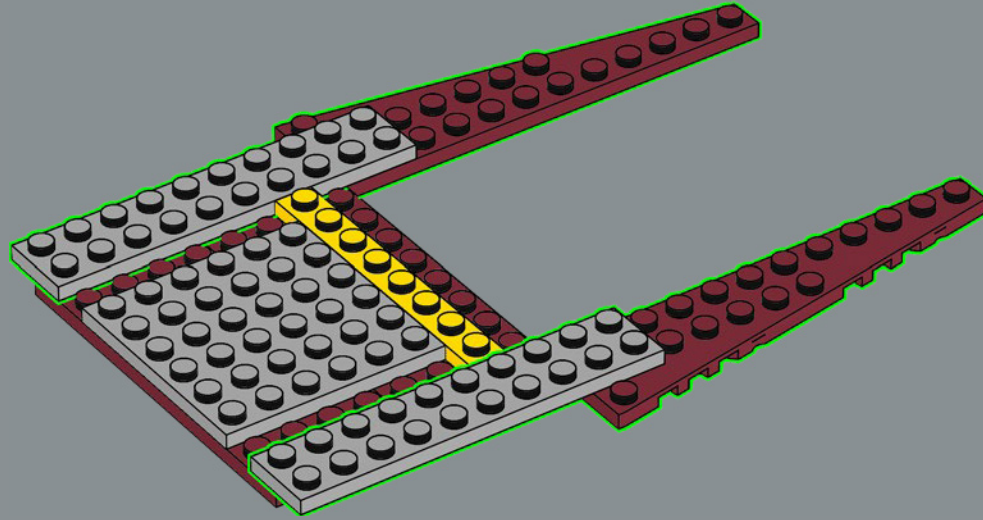

4

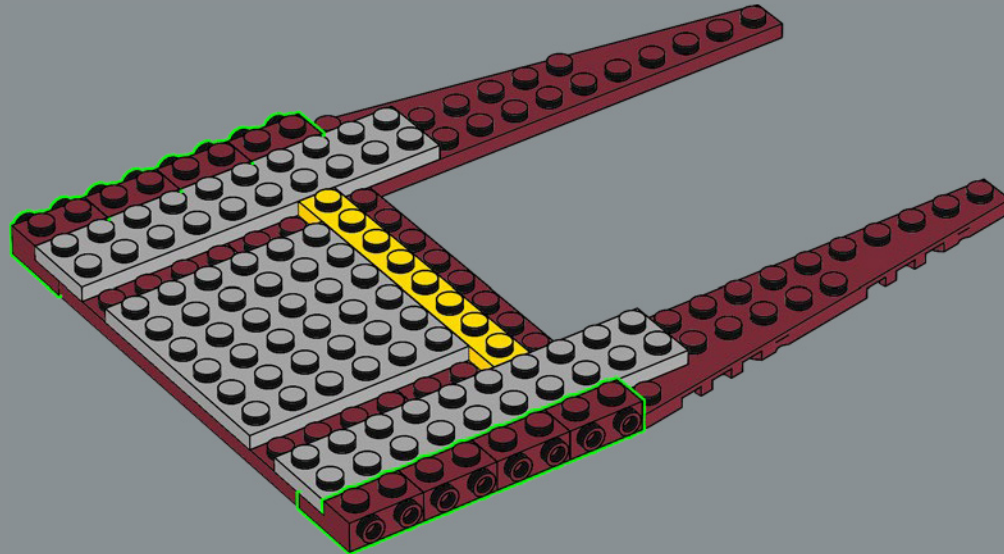

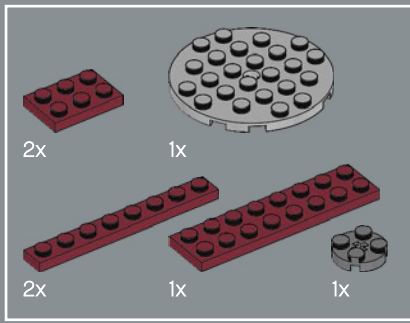

5

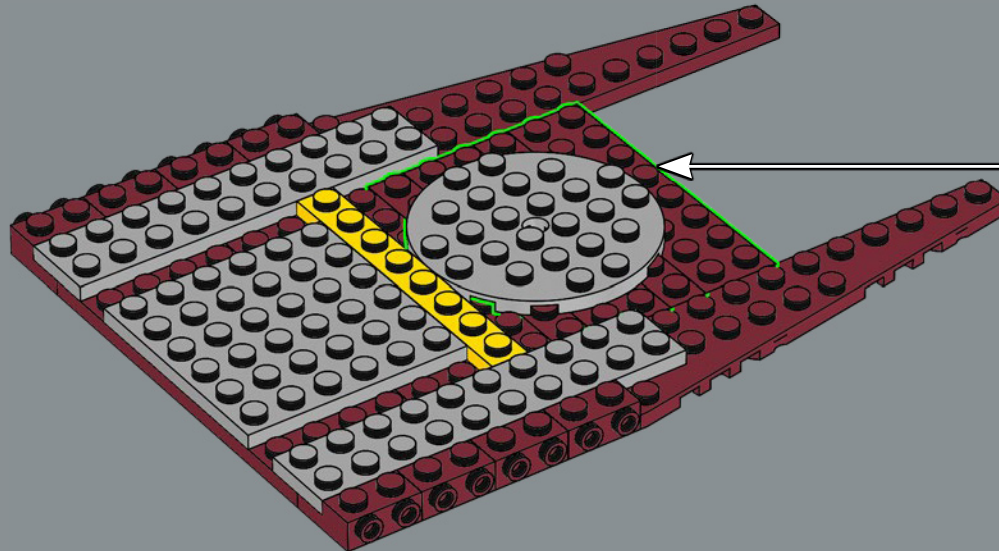
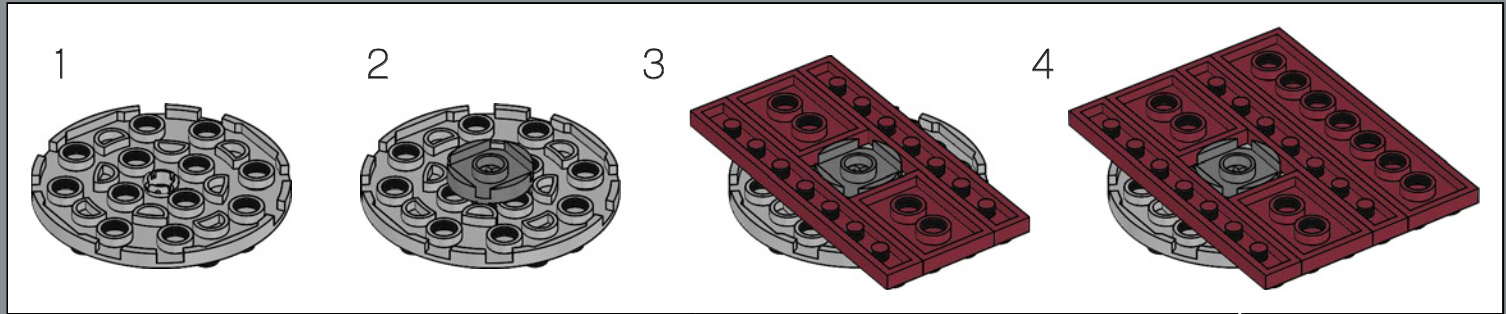

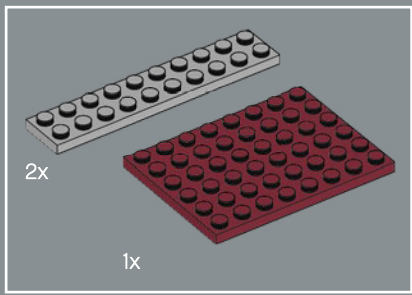

6

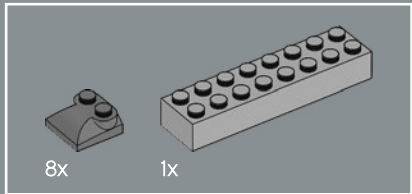
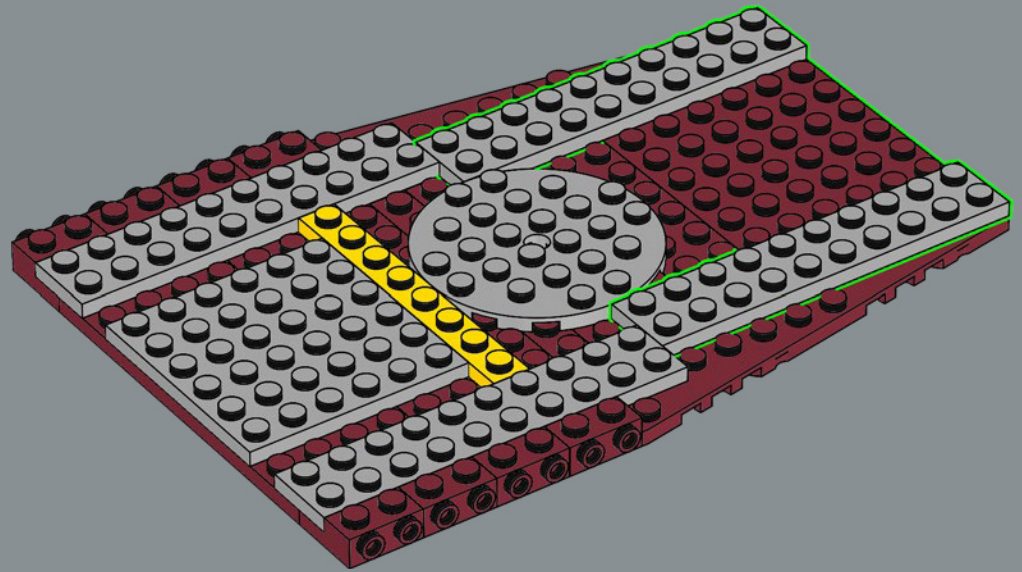

7

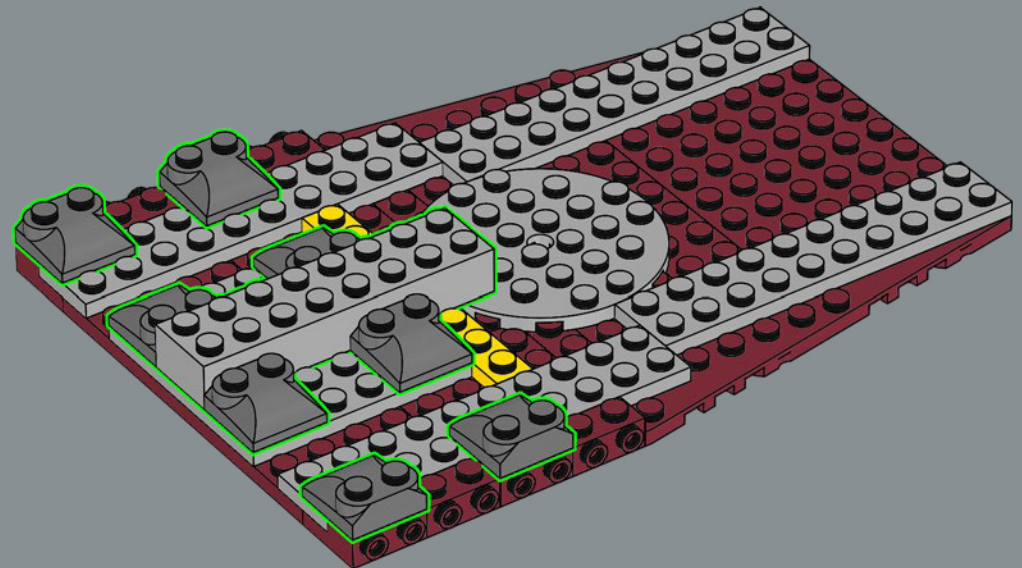



8

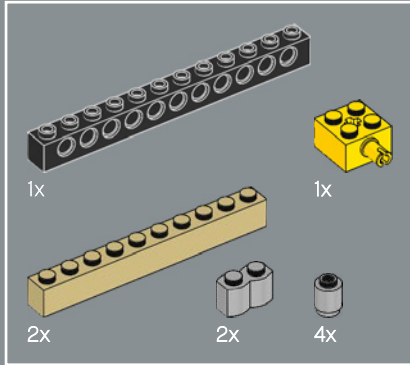
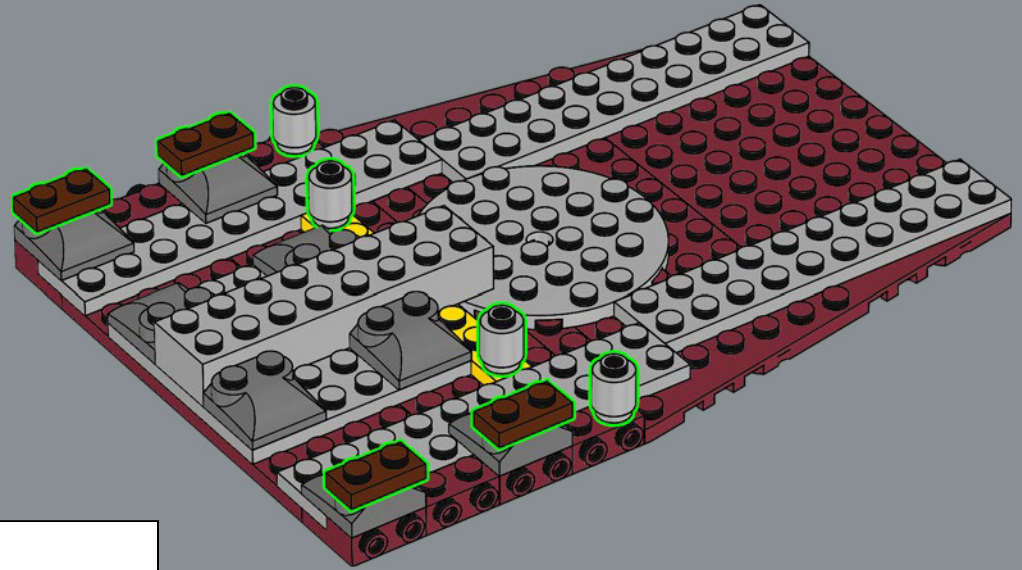

9

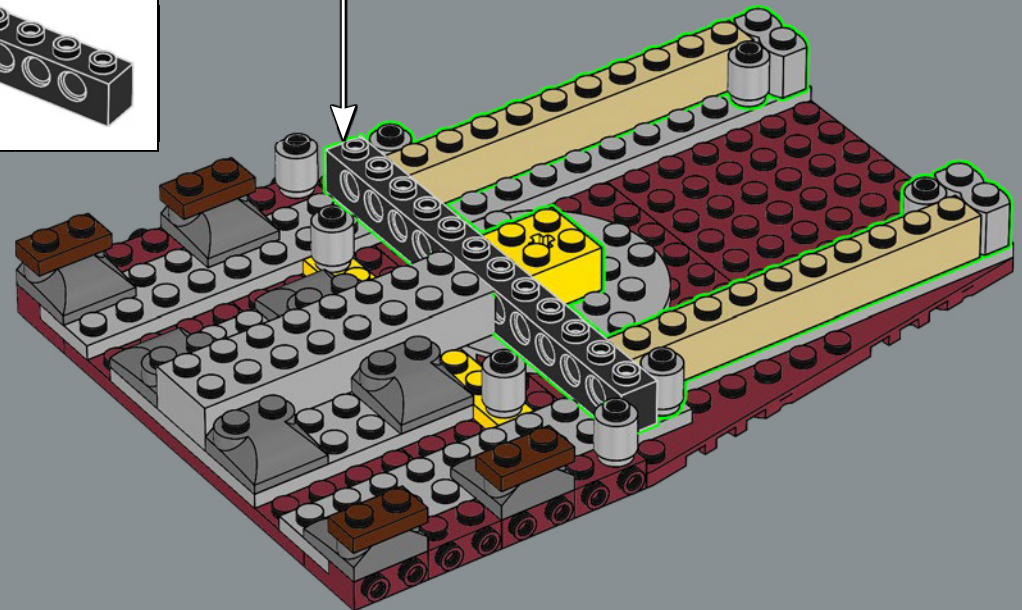
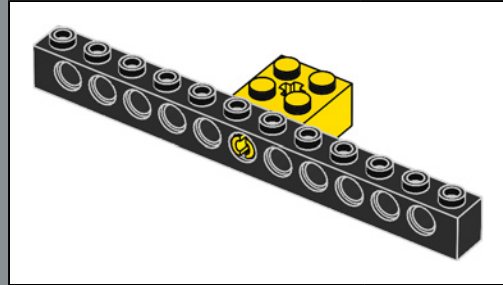

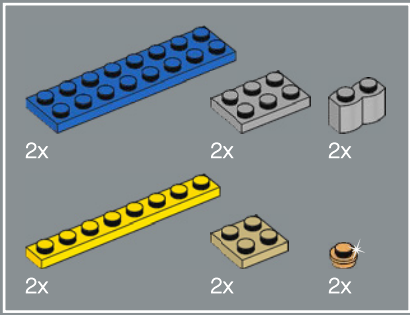

10

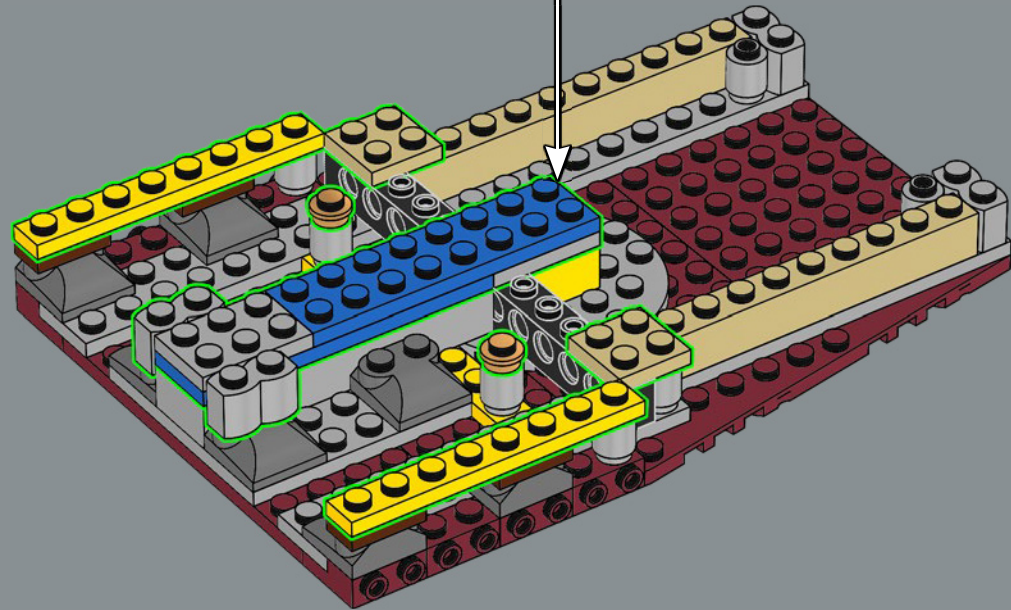
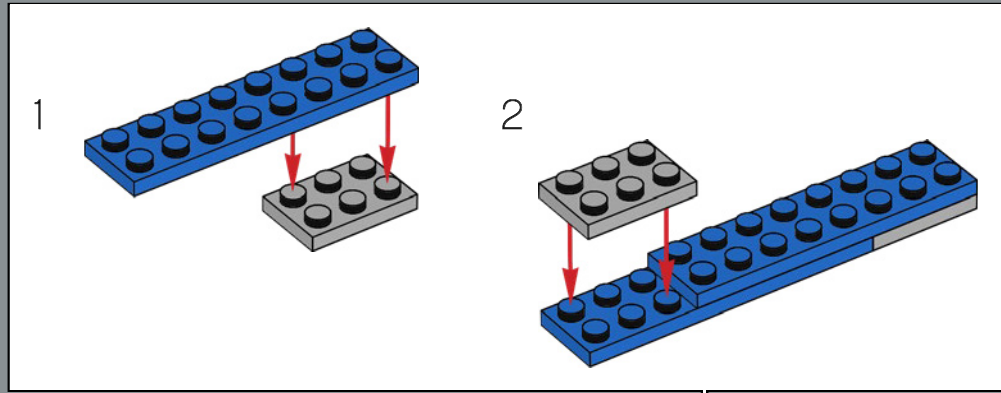



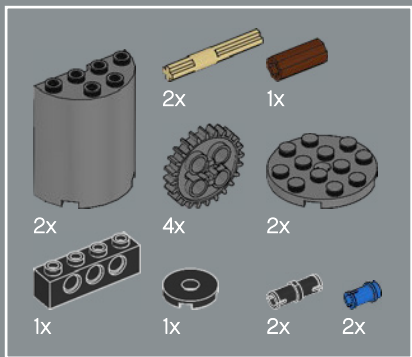

12

1

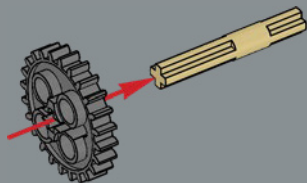

2

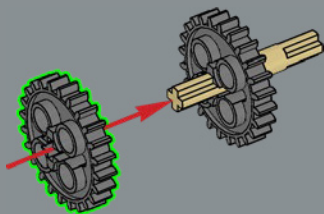

3

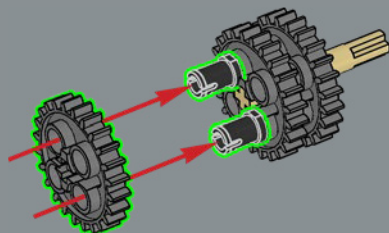

4

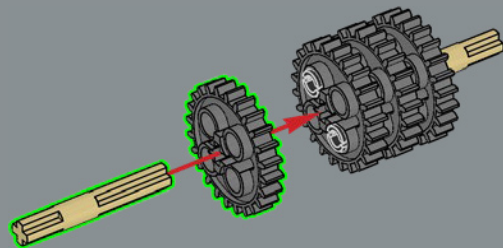

5

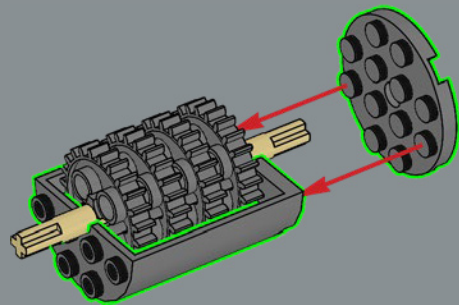

6

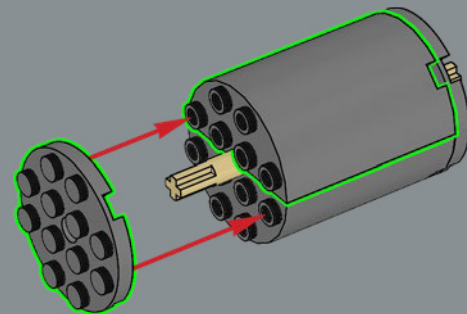

7

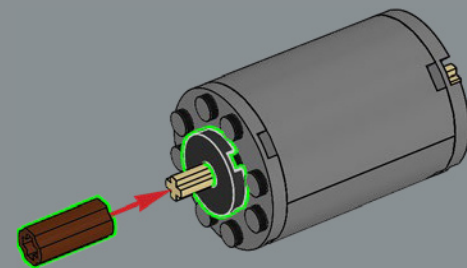

8

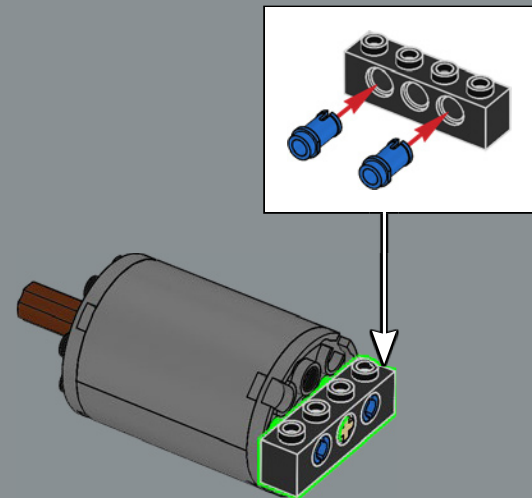



Les dynamos du Titanic peuvent produire plus d'énergie qu'une centrale électrique moyenne de l'époque.

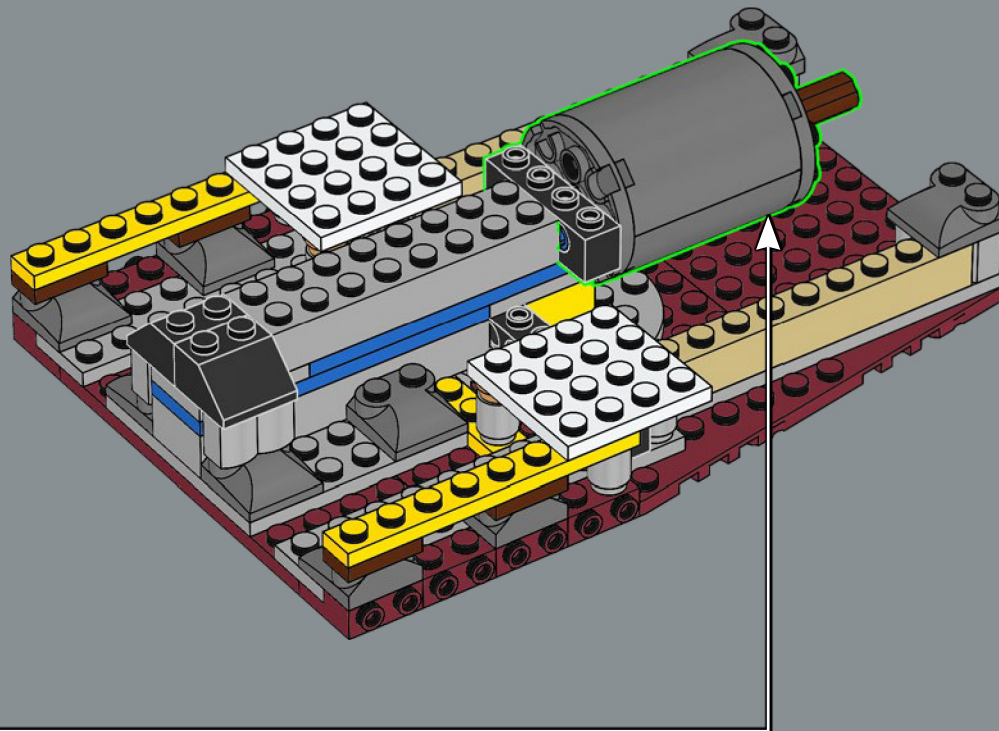

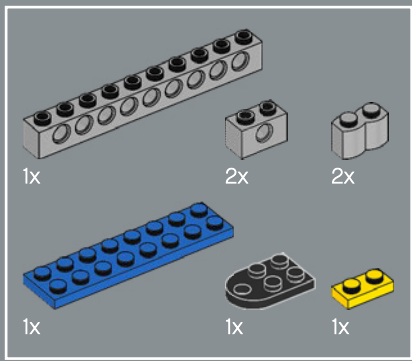

13

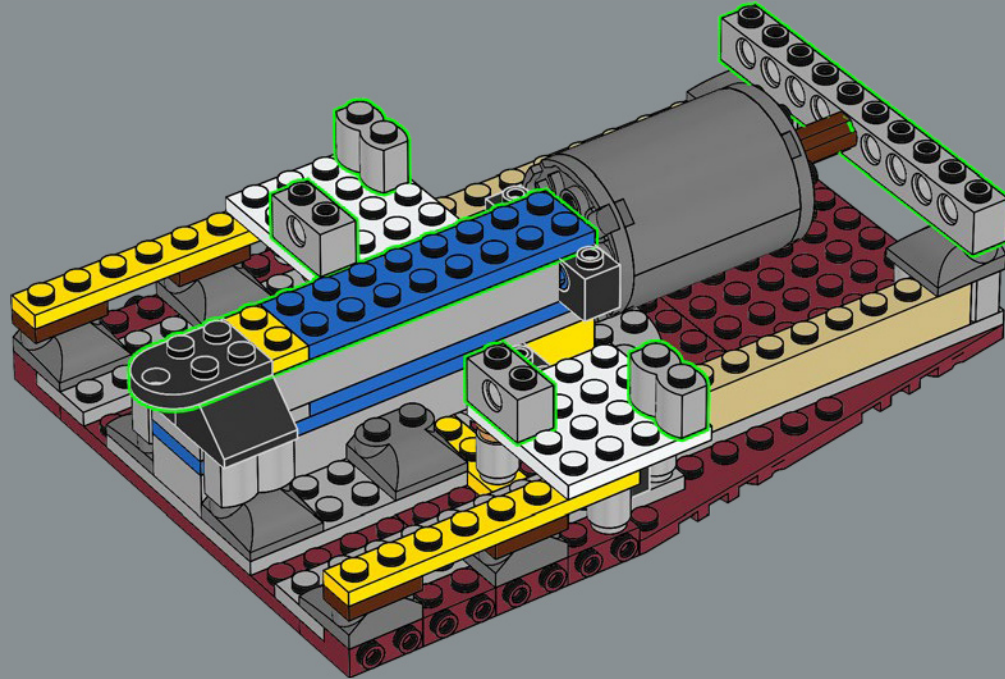

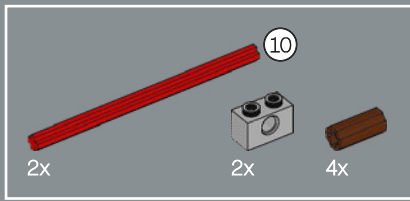

14

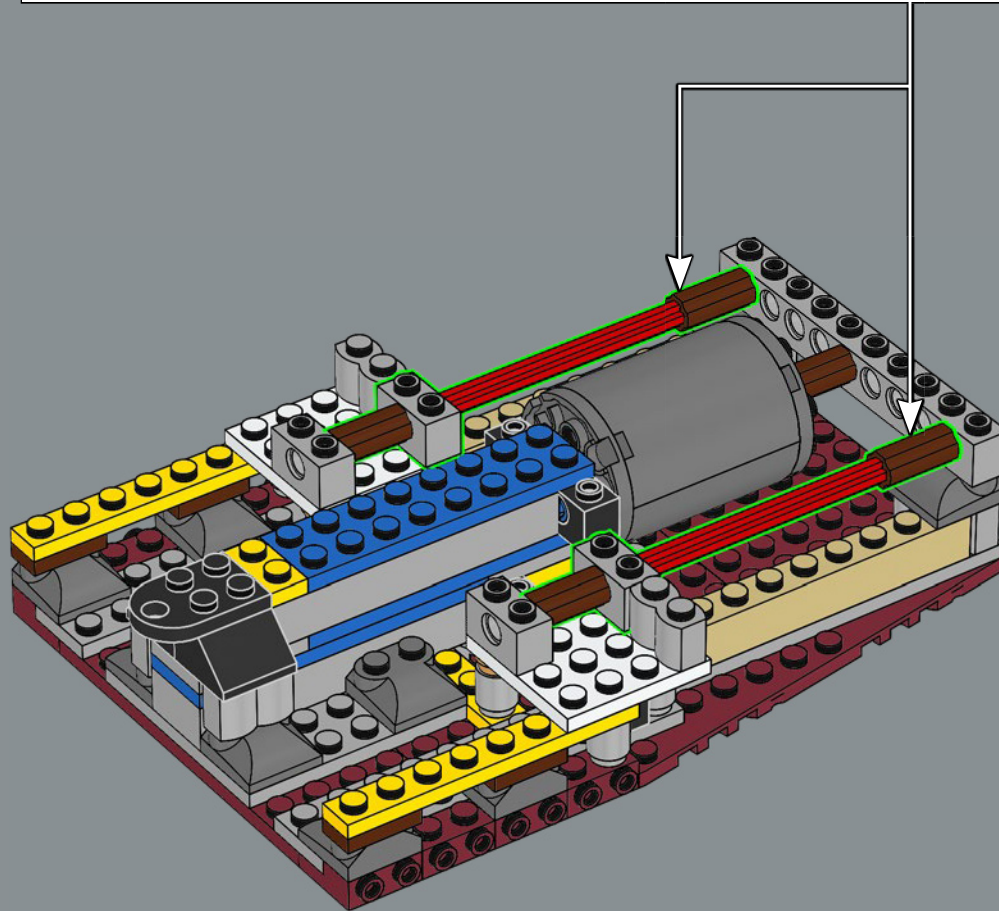
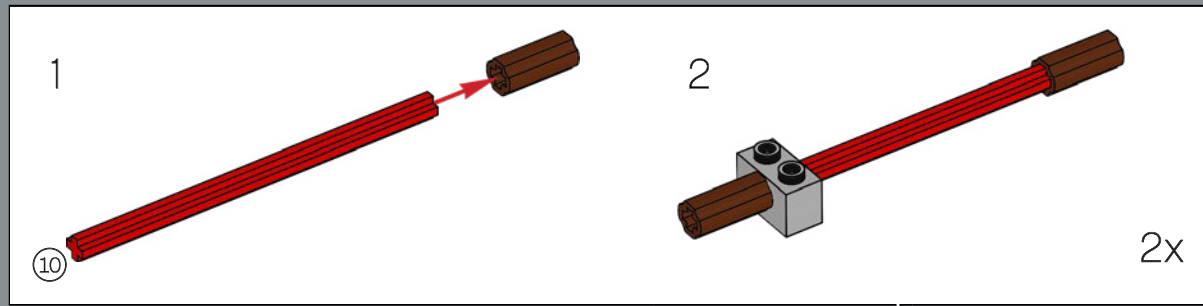

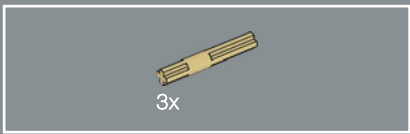

15

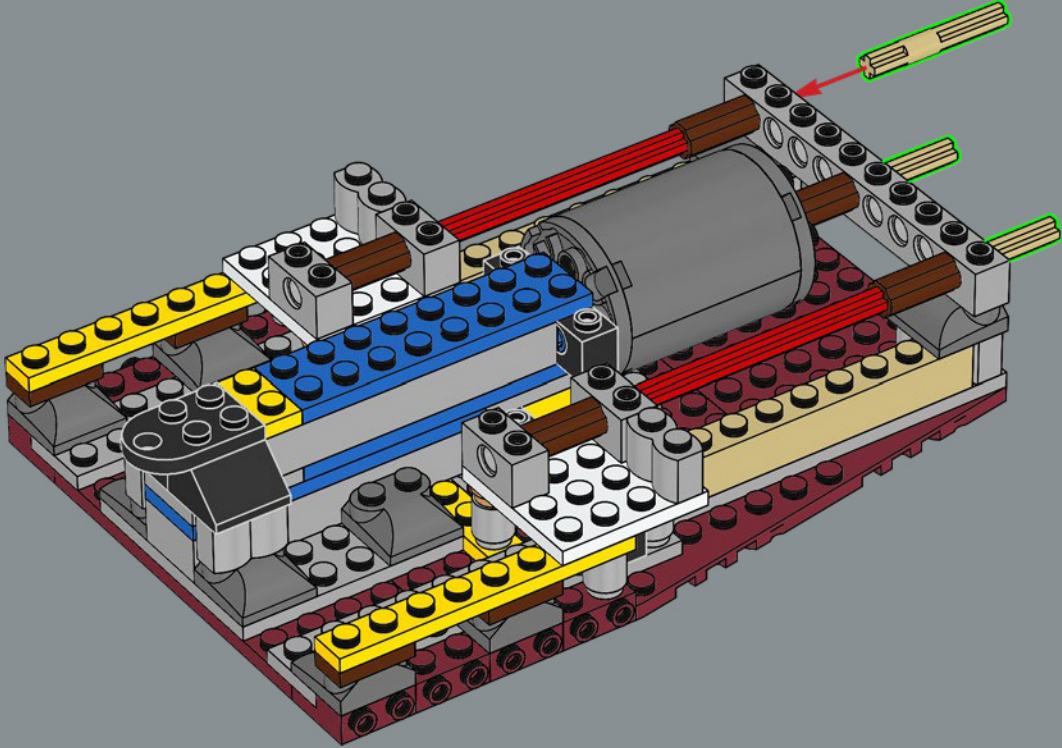

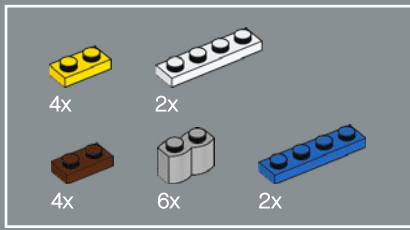

16

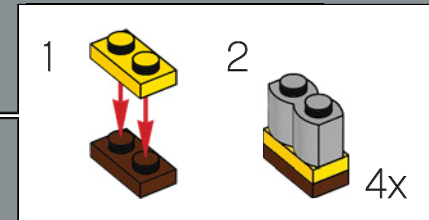
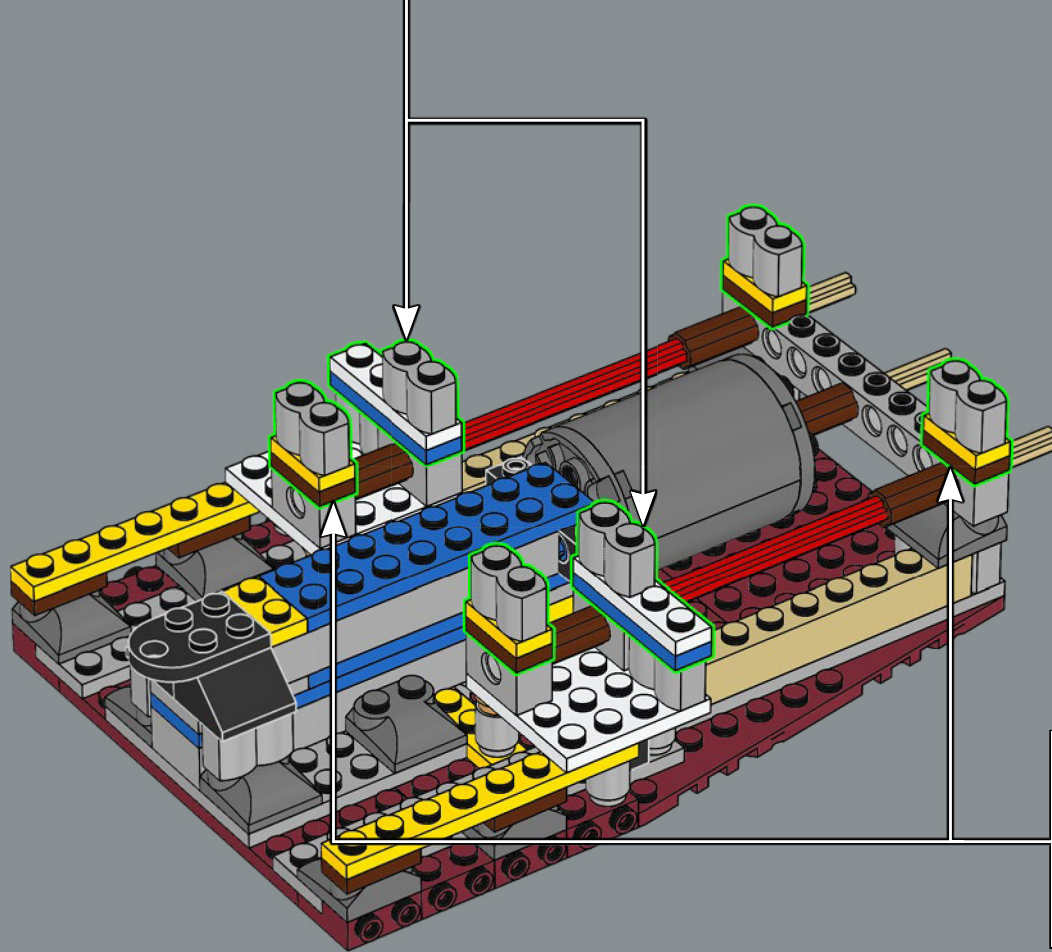
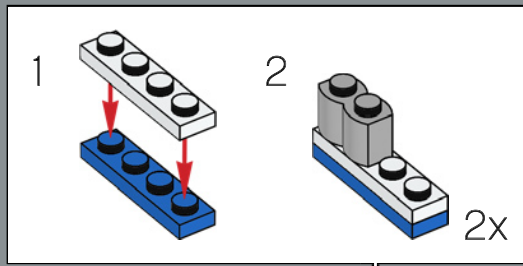

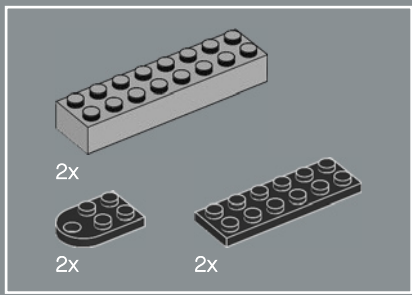

17

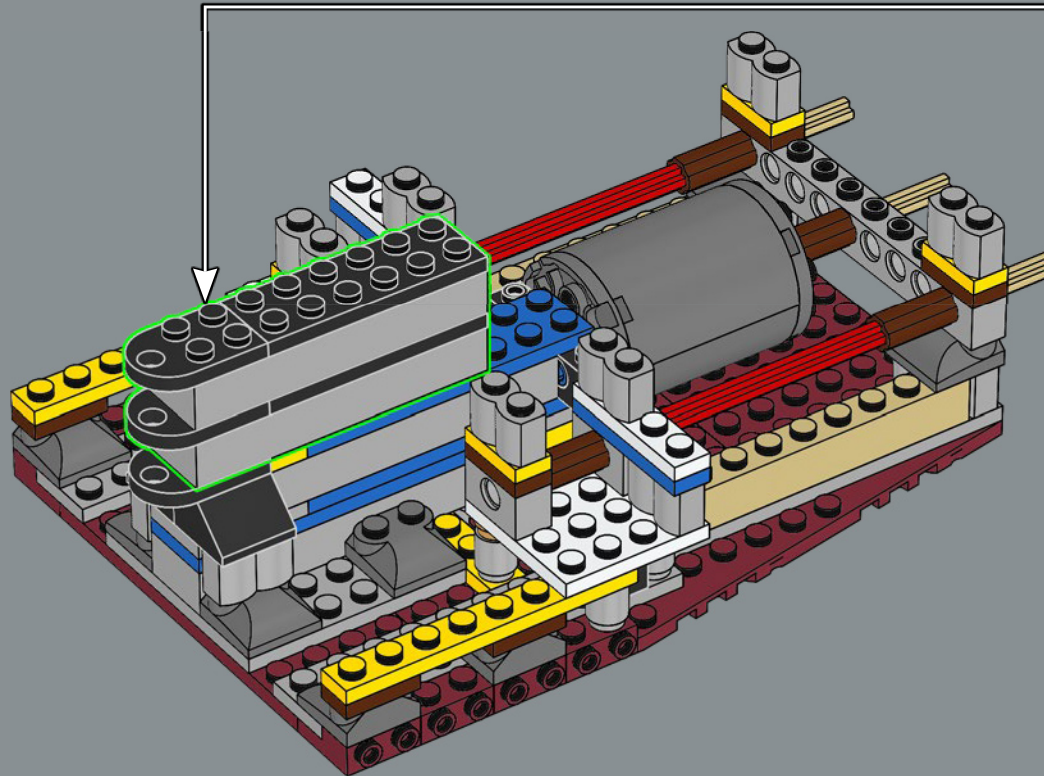
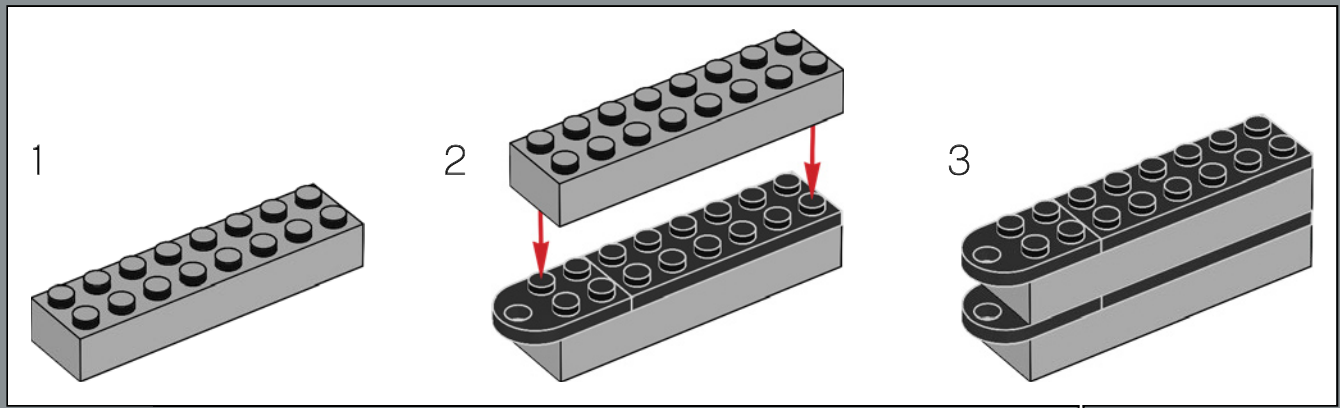

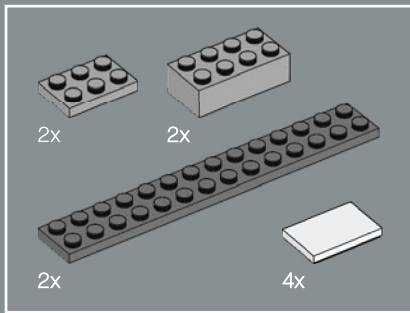

18

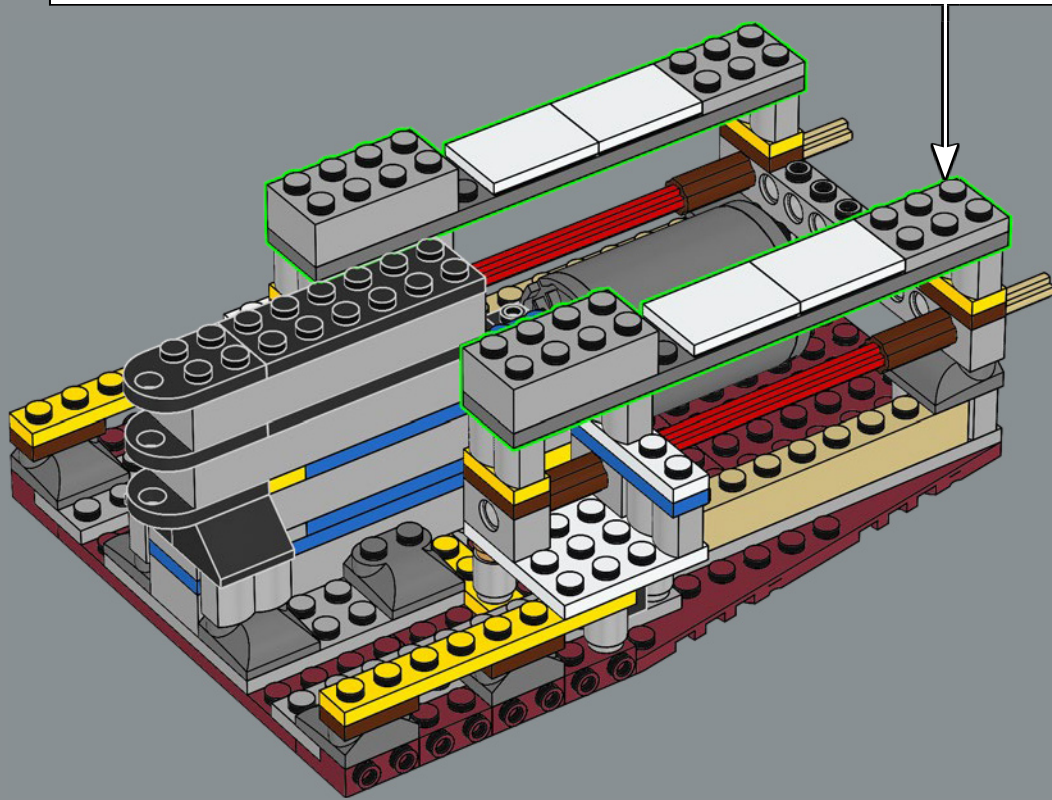
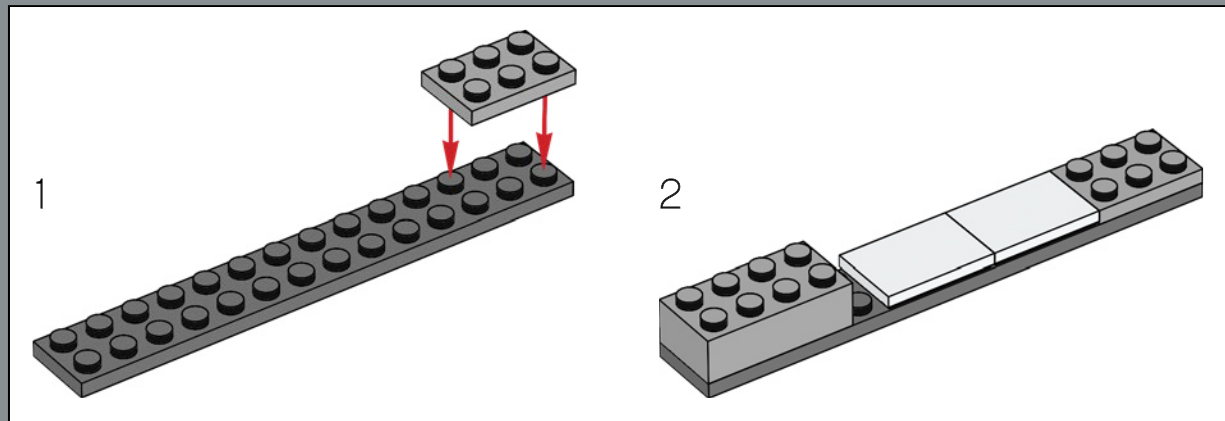



19

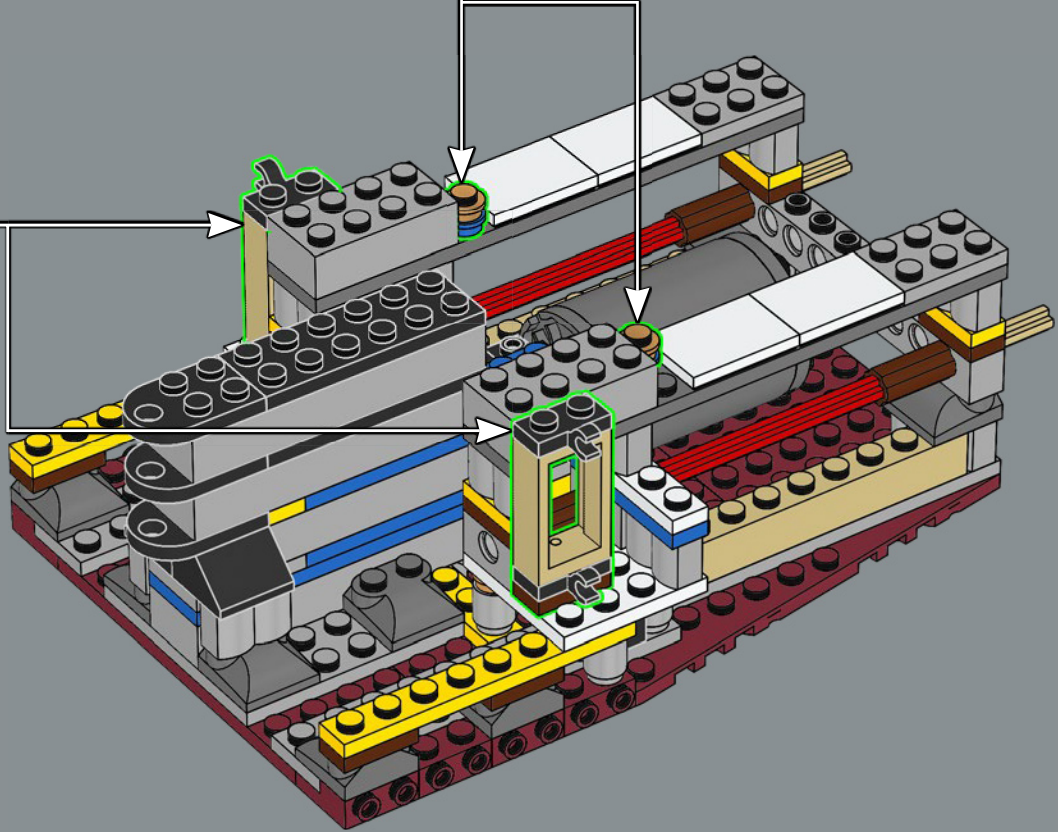
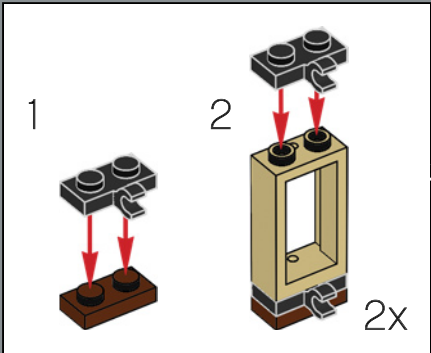
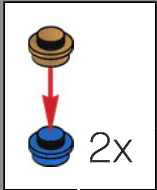



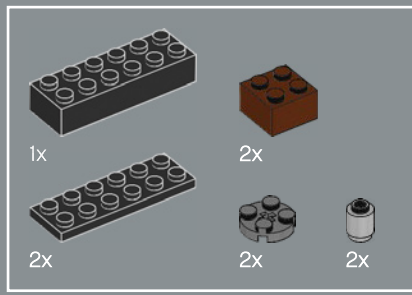

20

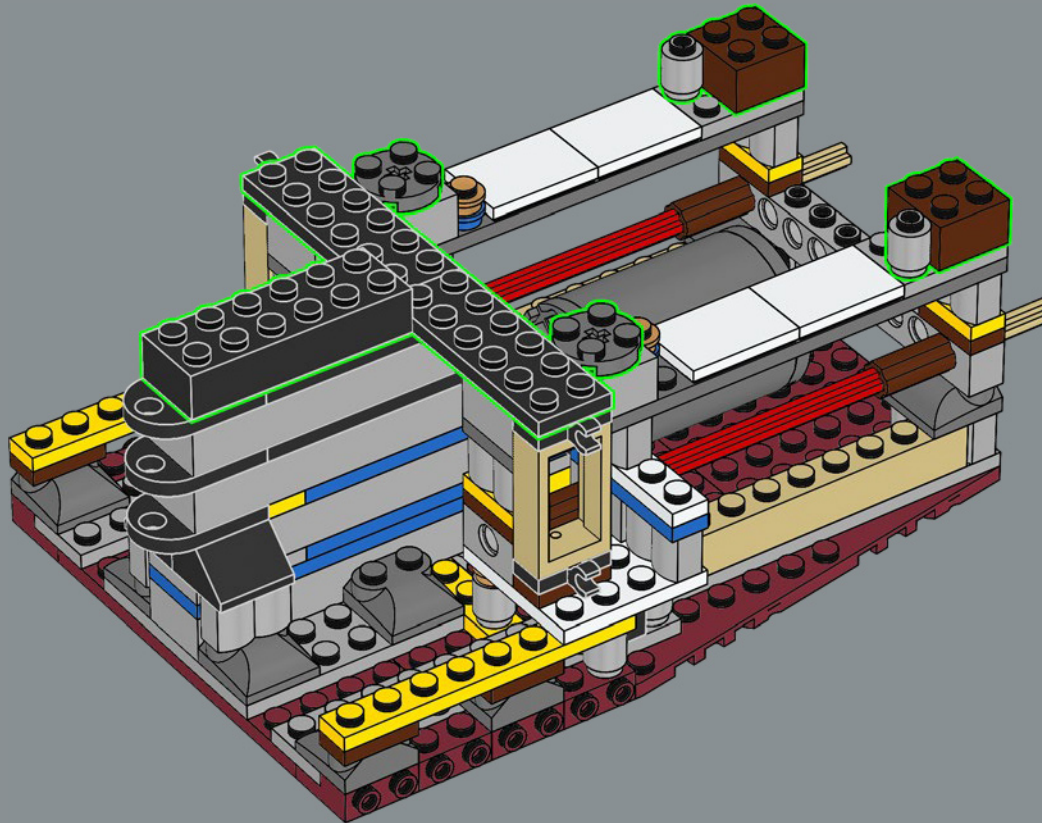



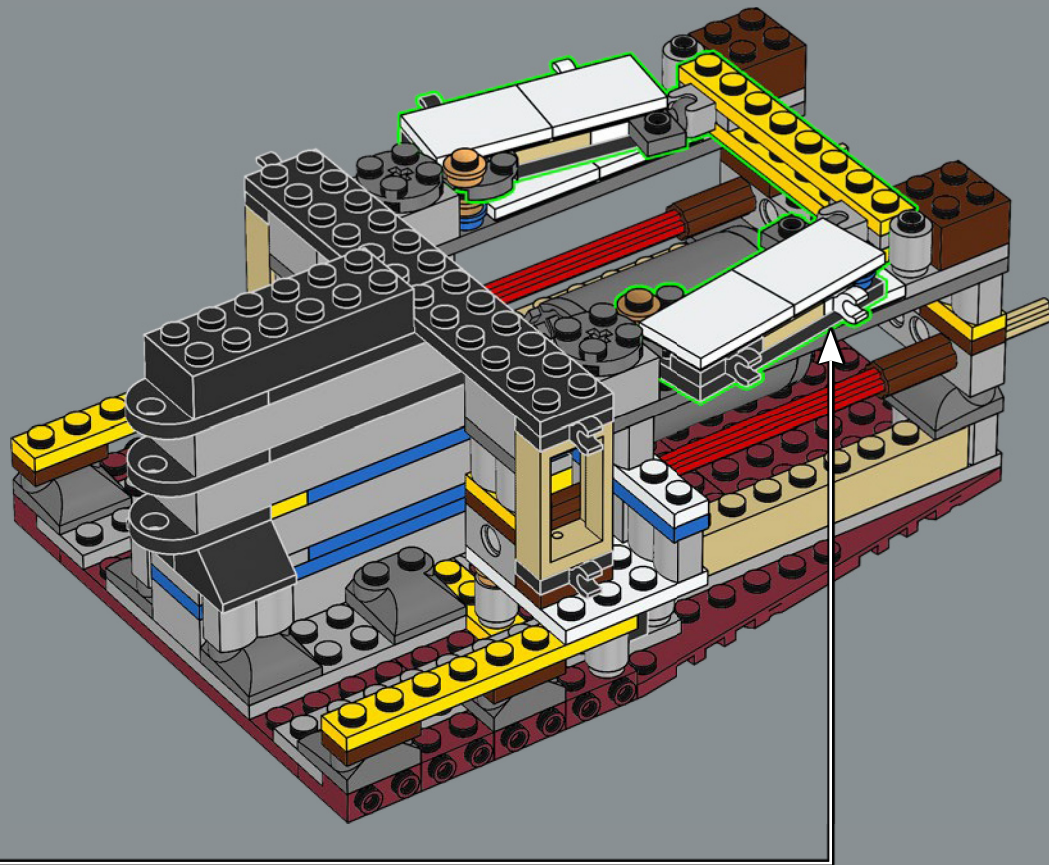

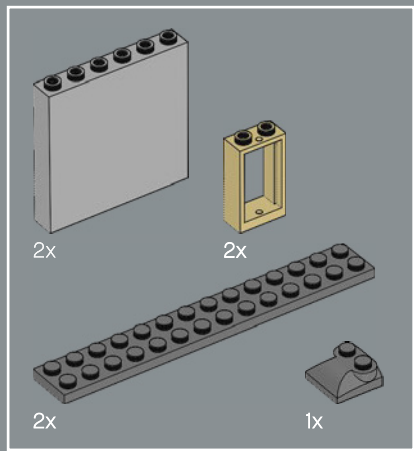

22

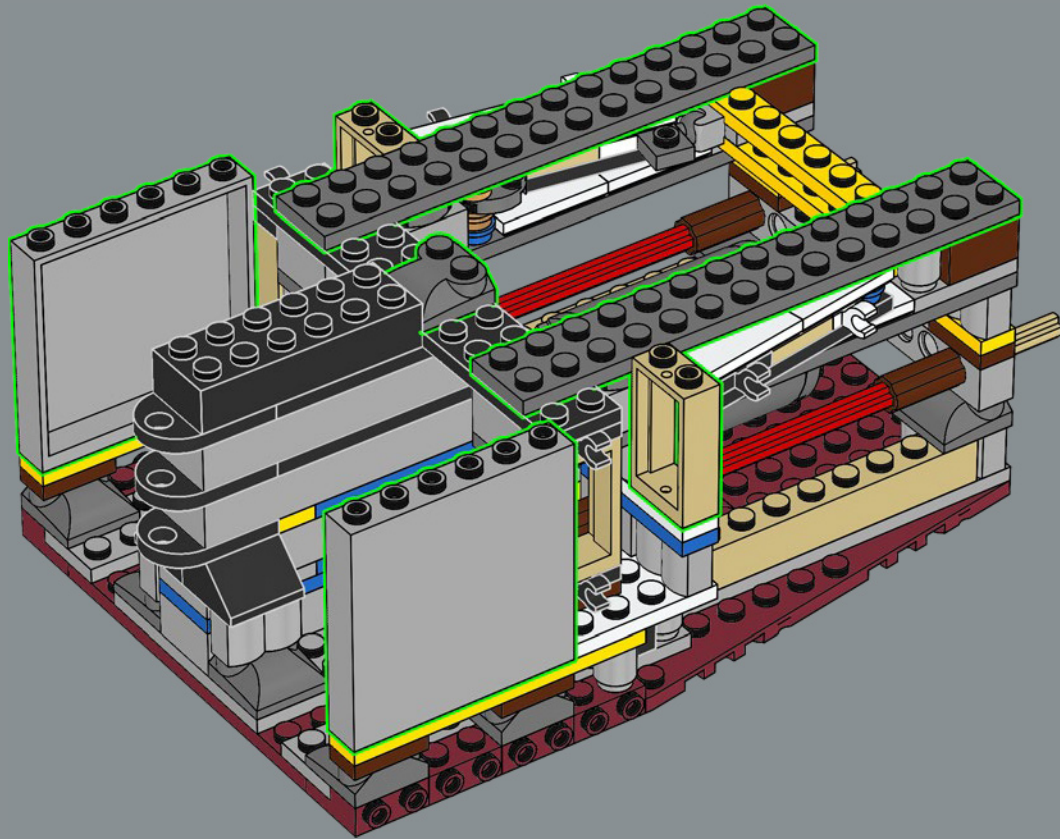

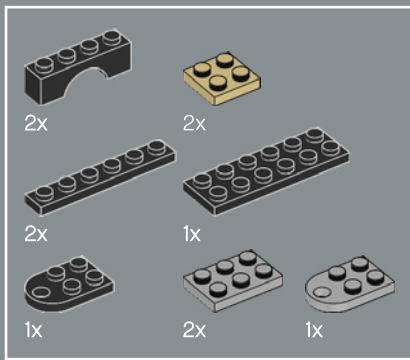

23

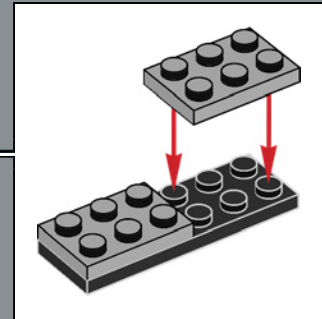
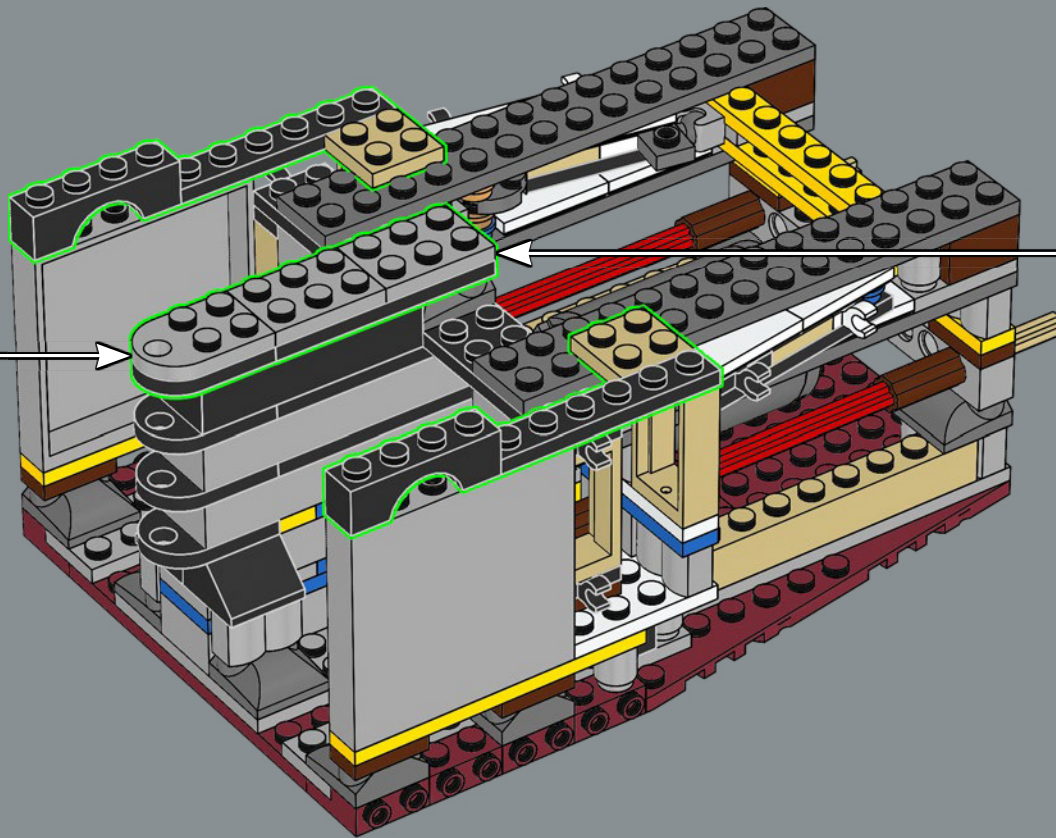
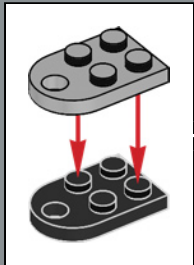

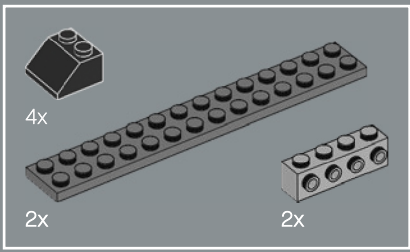

24

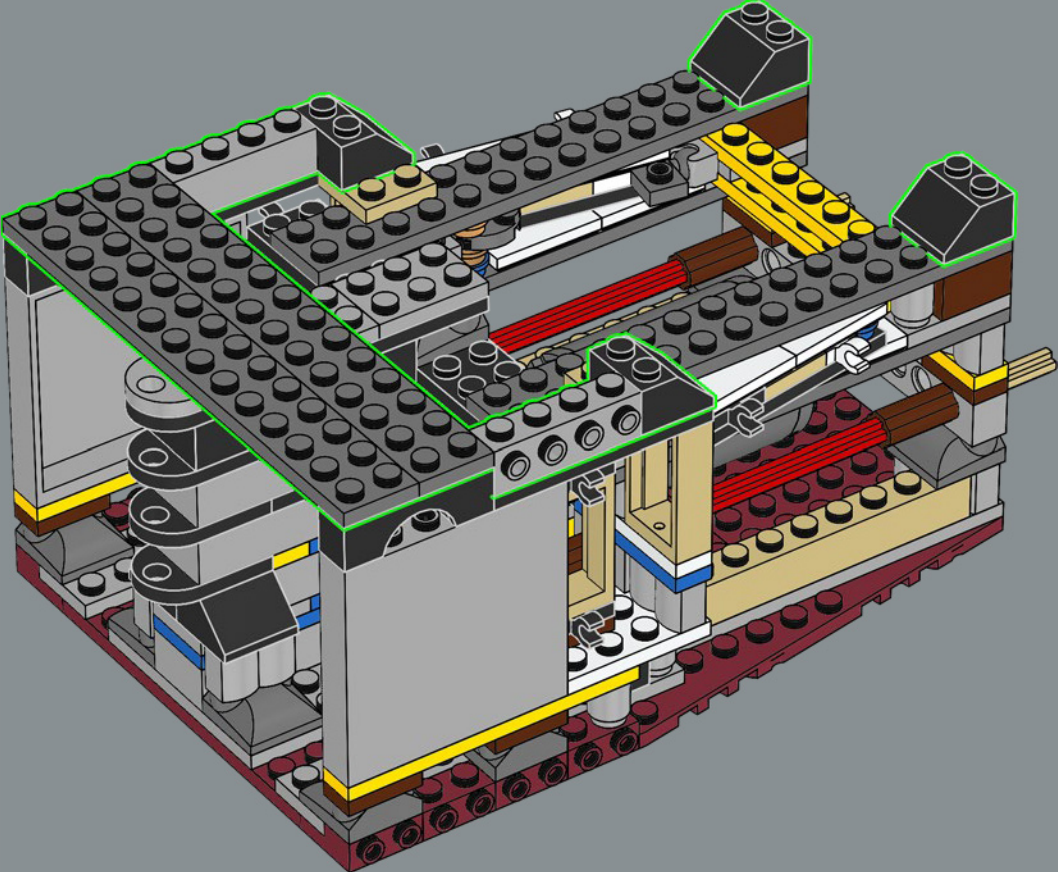

30

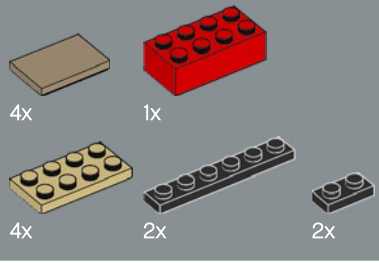
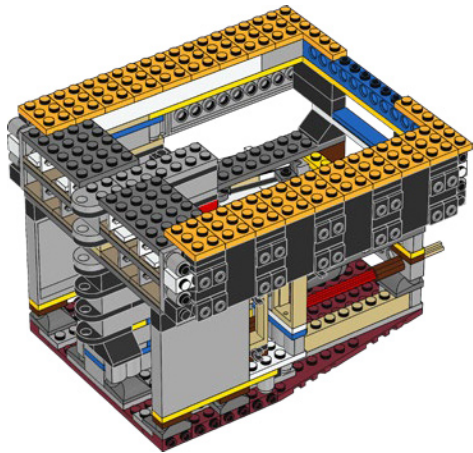
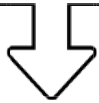

25

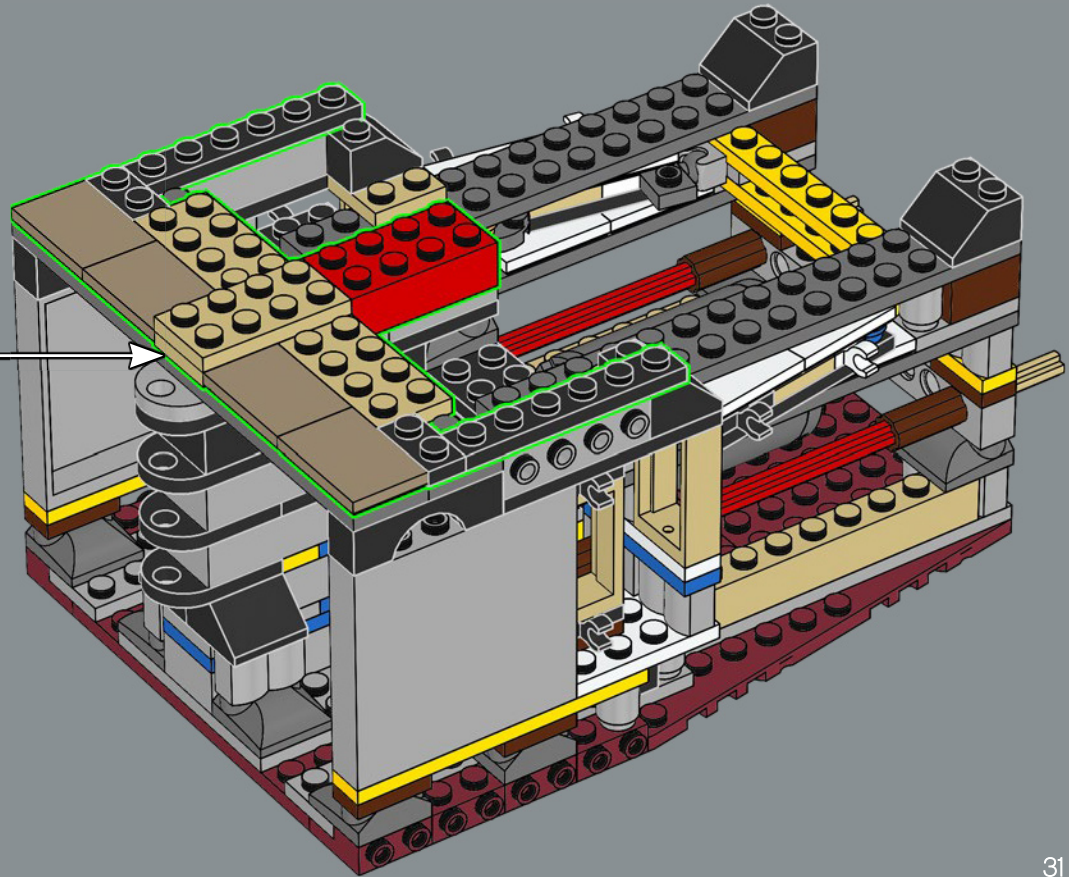
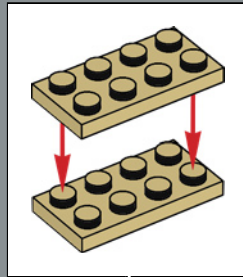

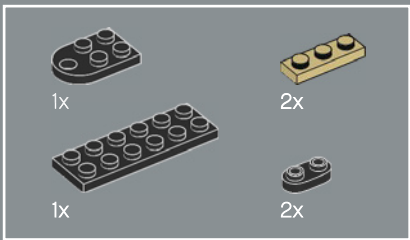

26

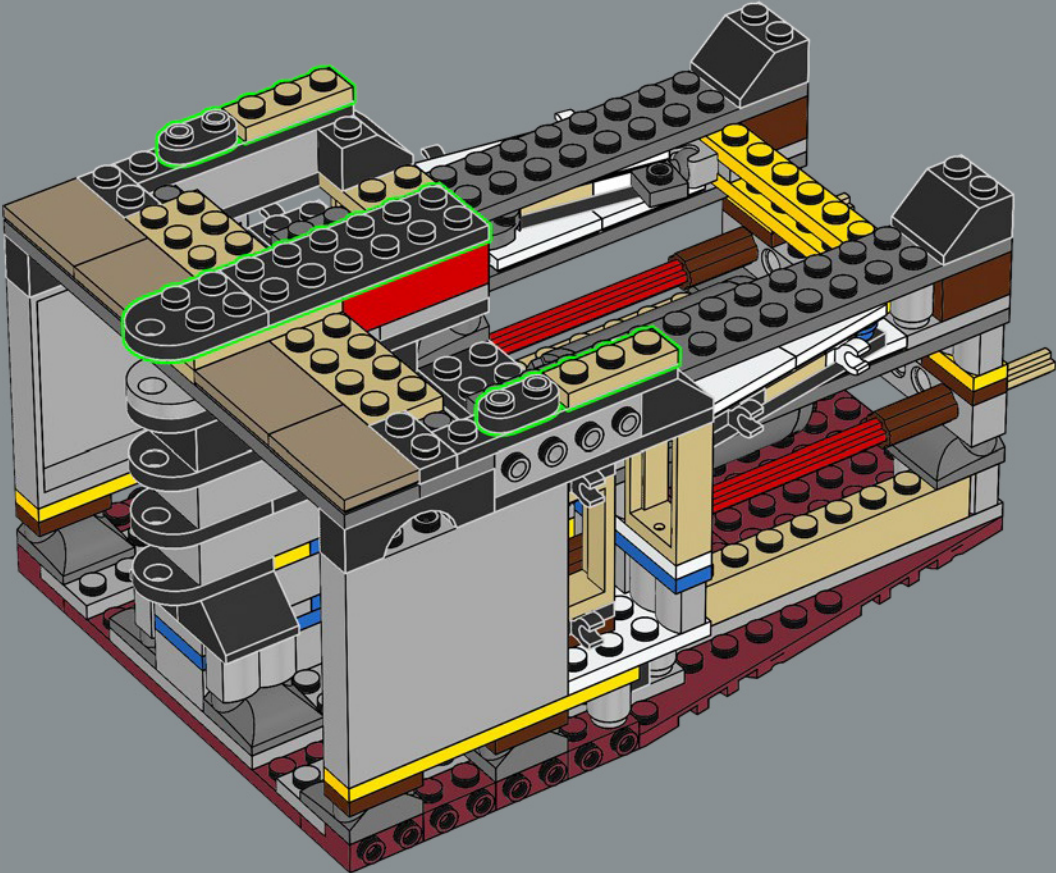



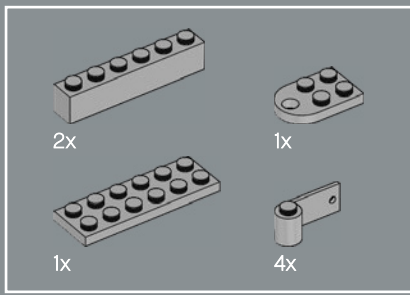

27

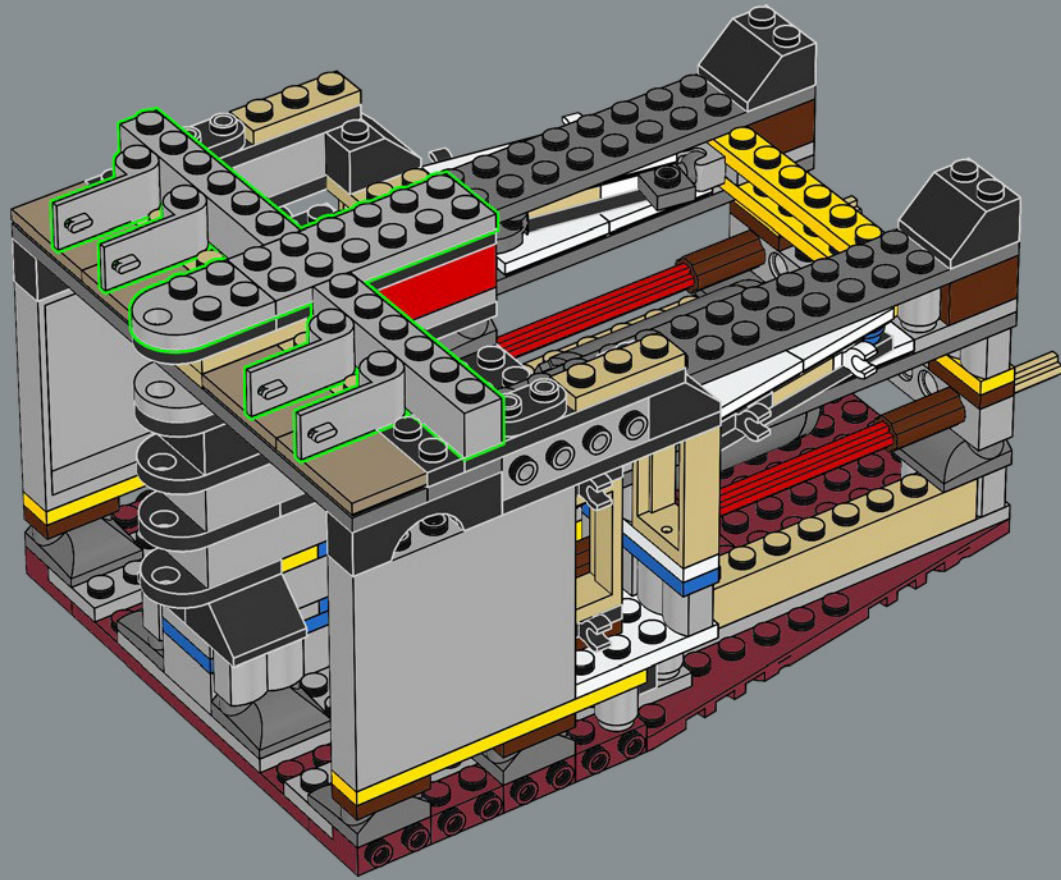

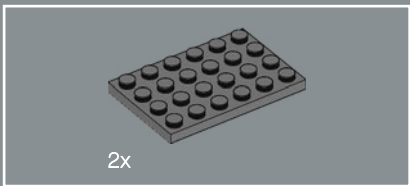

28

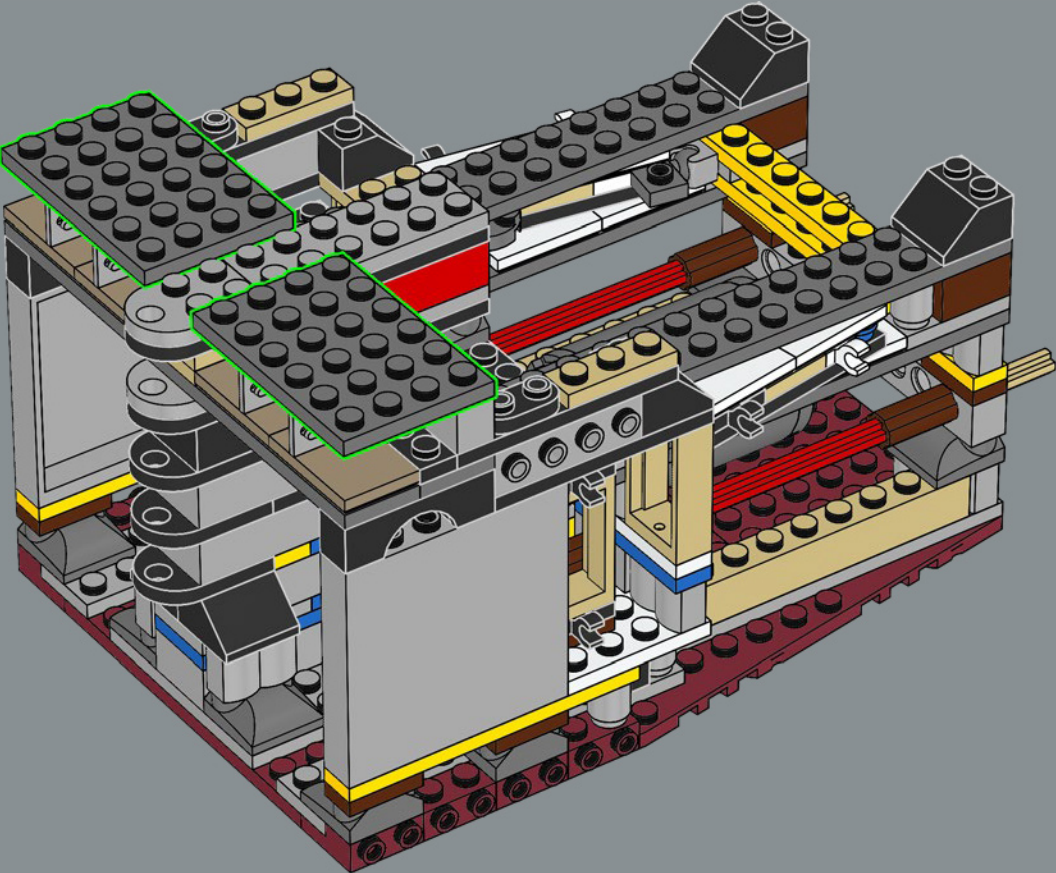

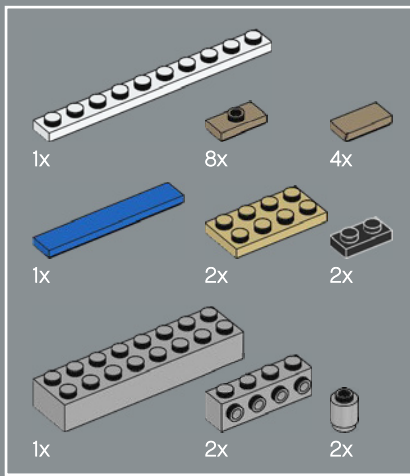

29

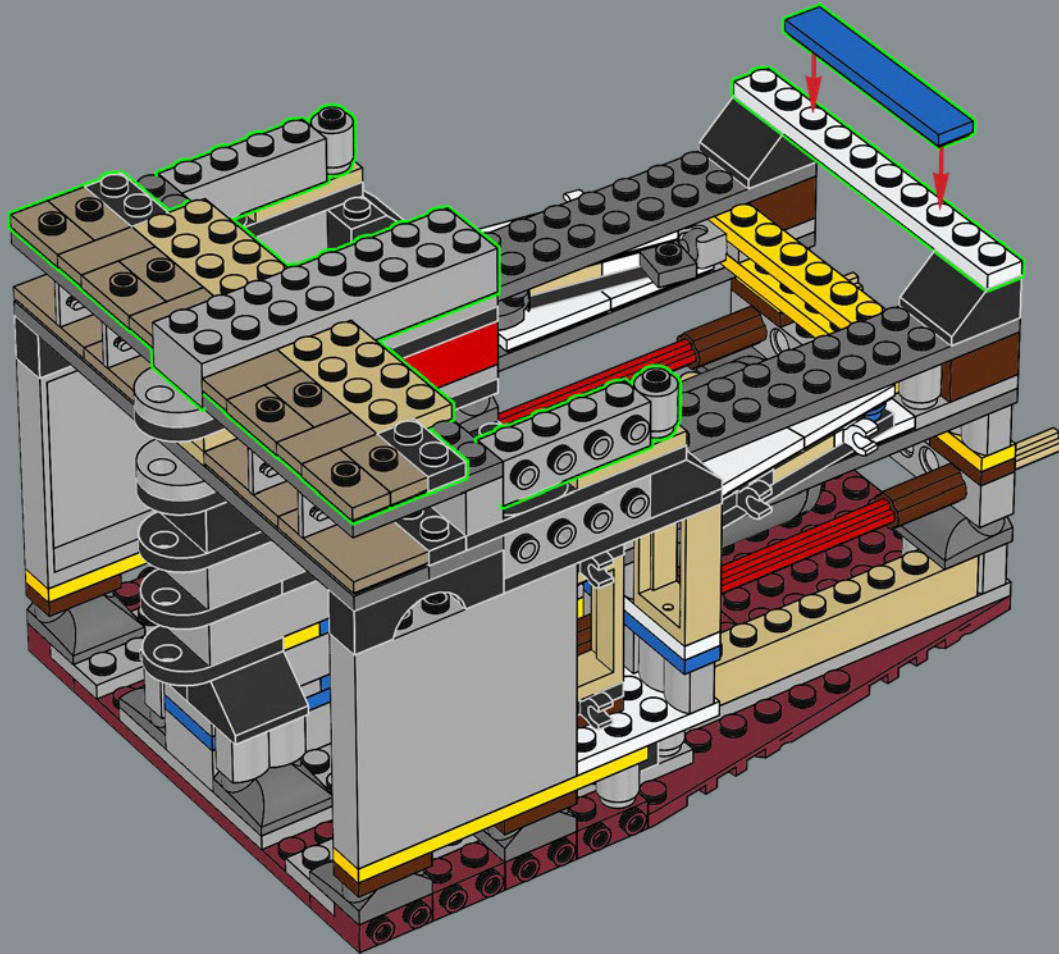

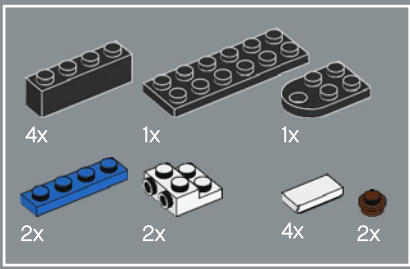

30

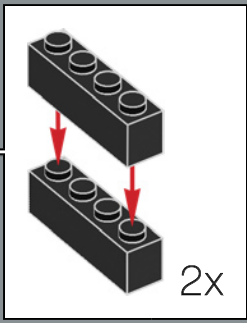
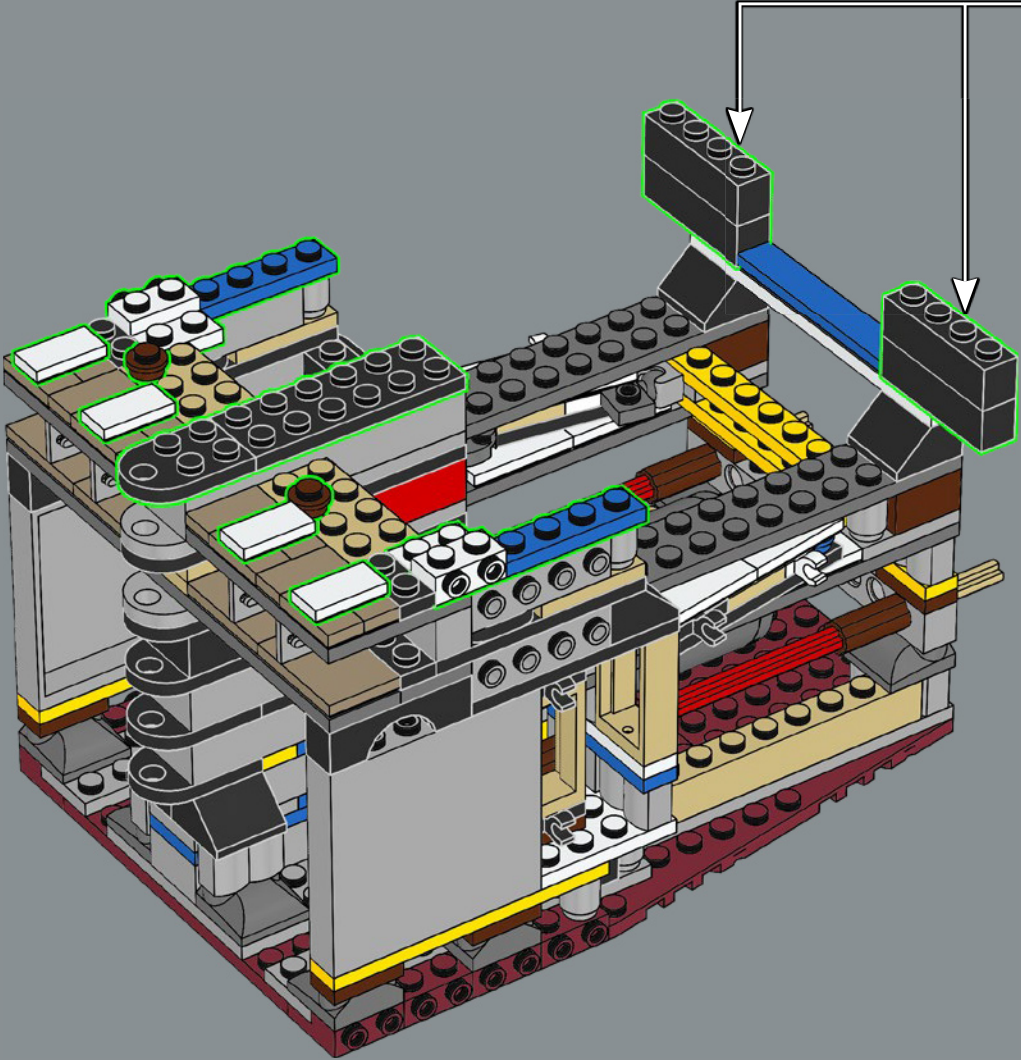

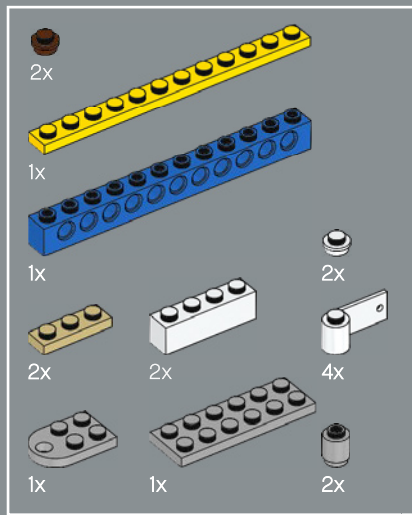

31

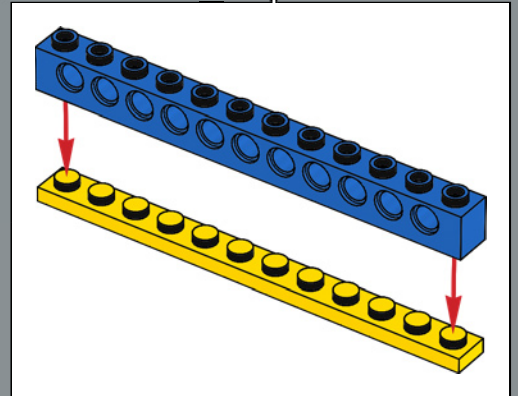
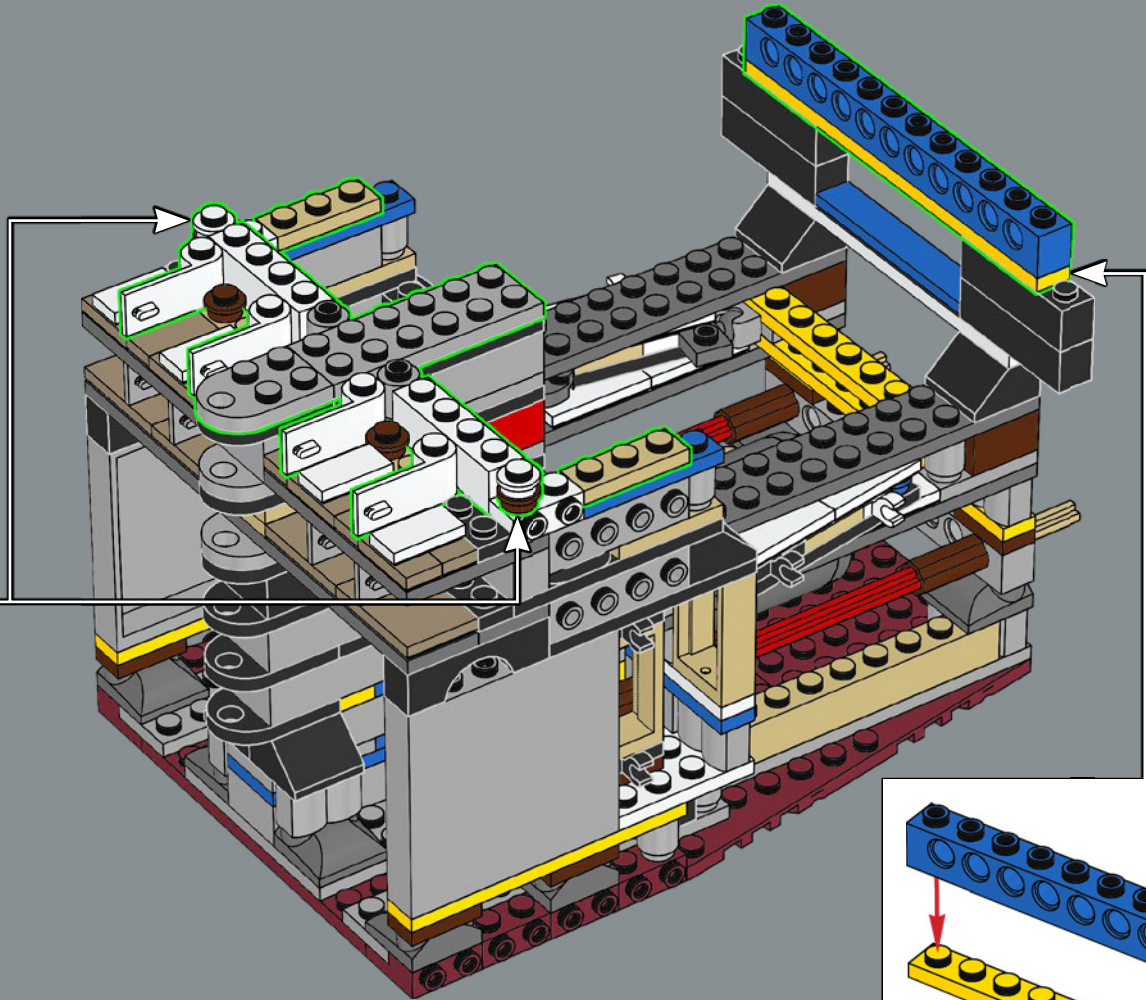
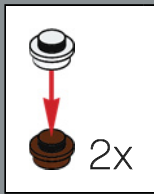

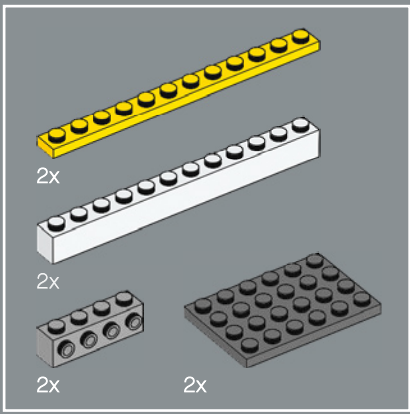

32

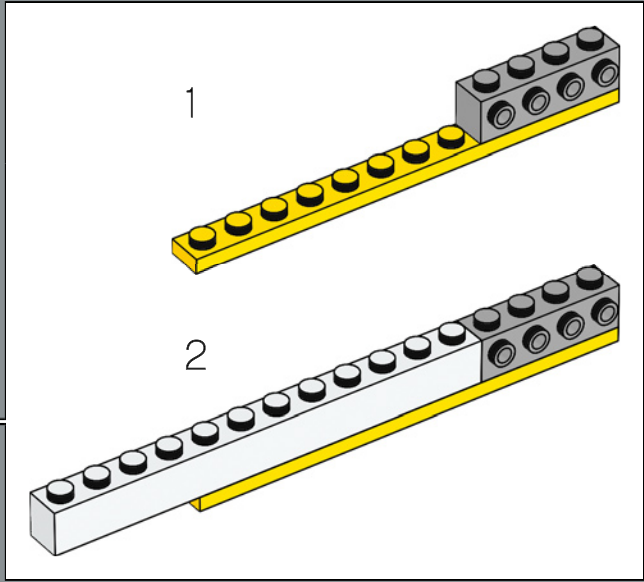
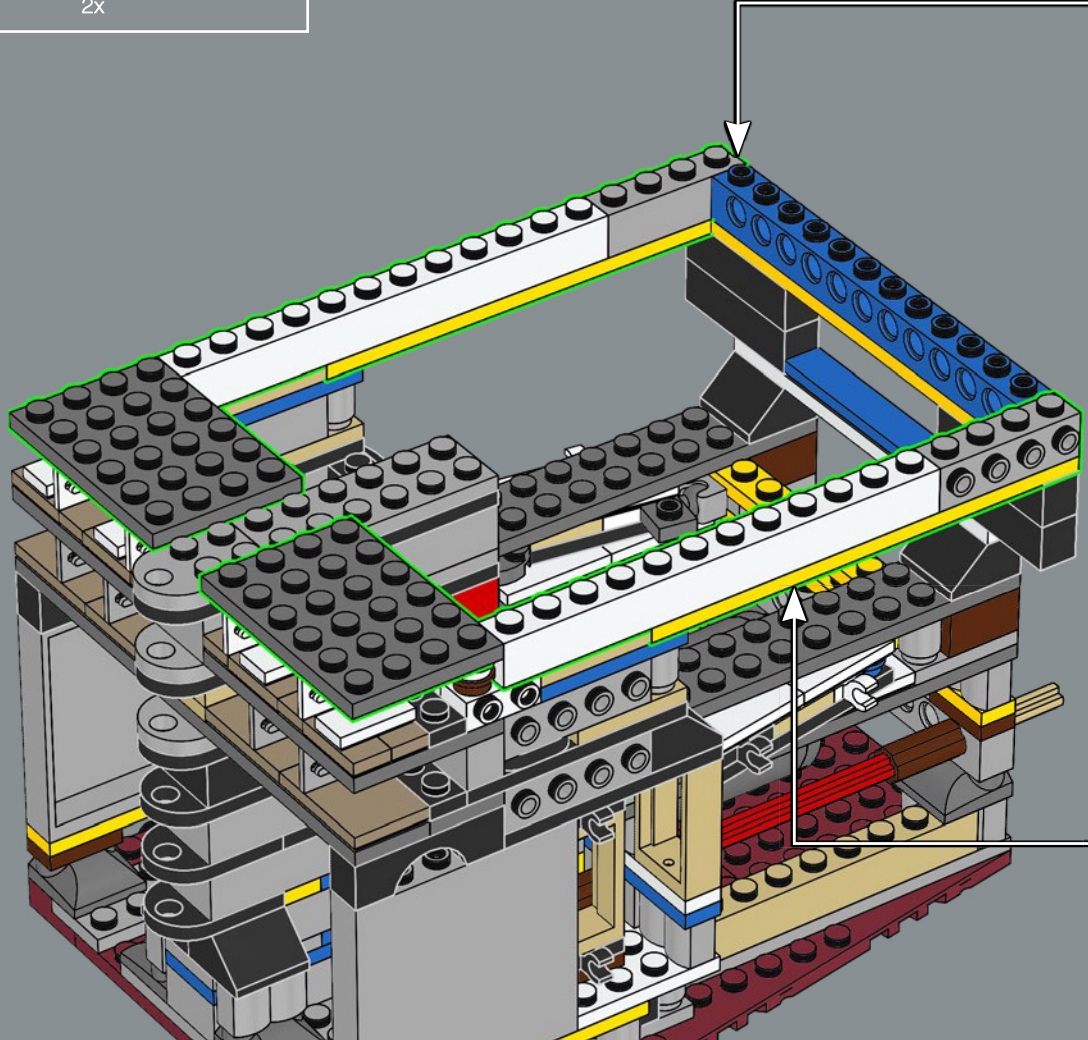
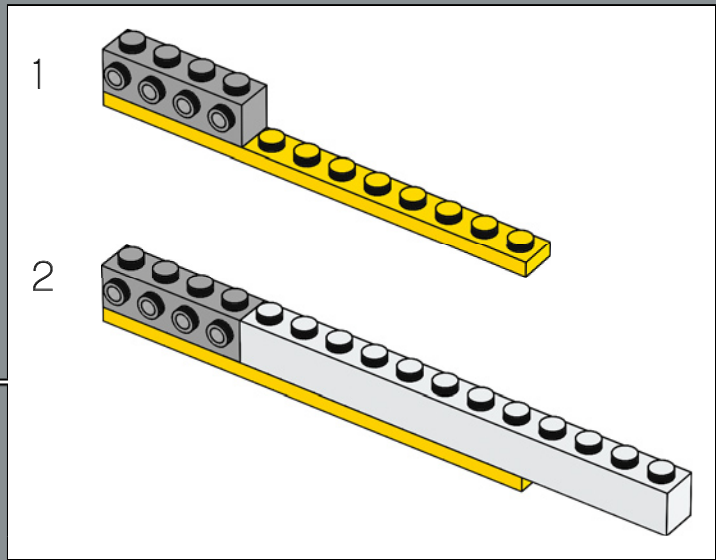

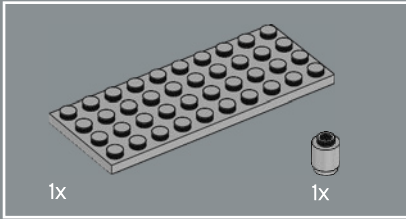
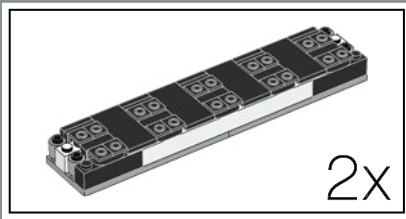

33

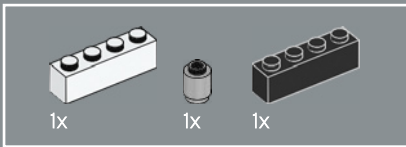
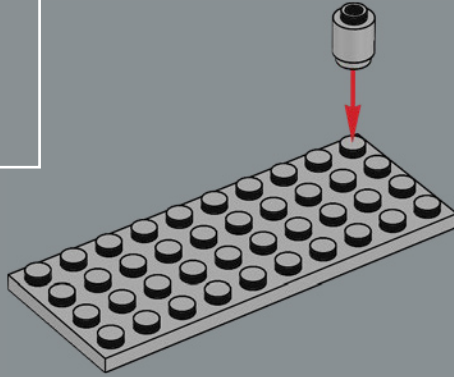

34

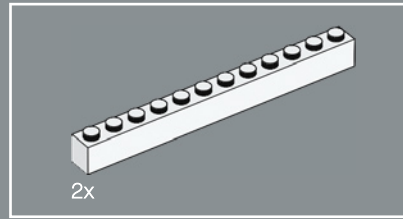
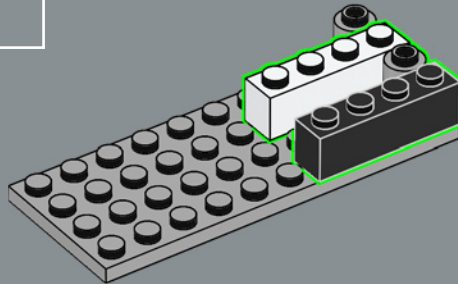

35

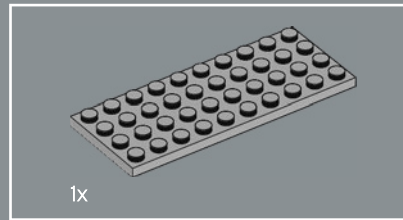
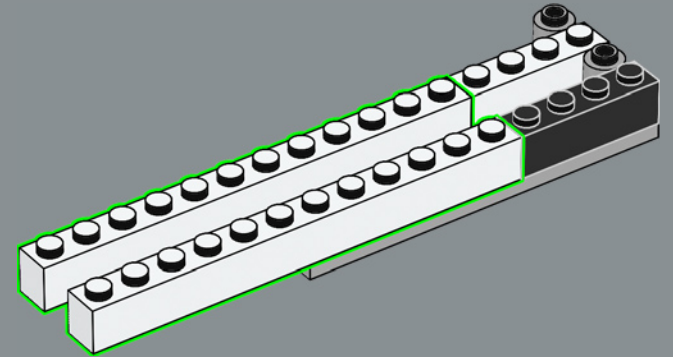

36

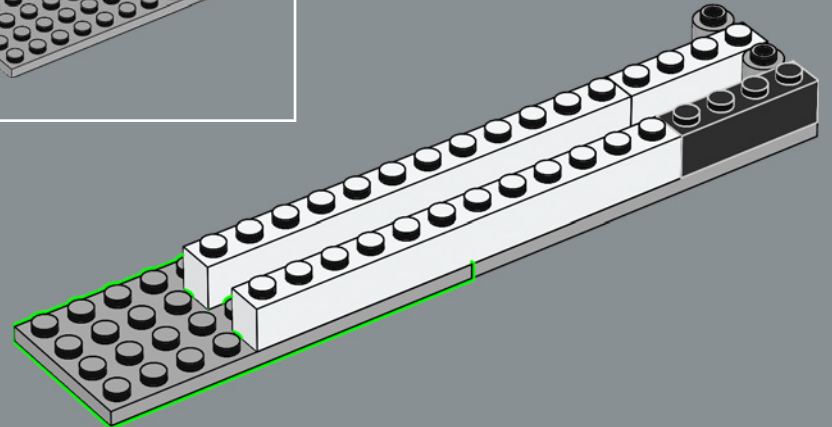

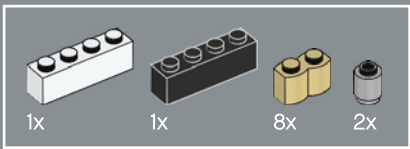

37

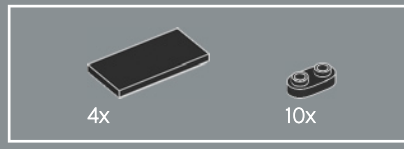
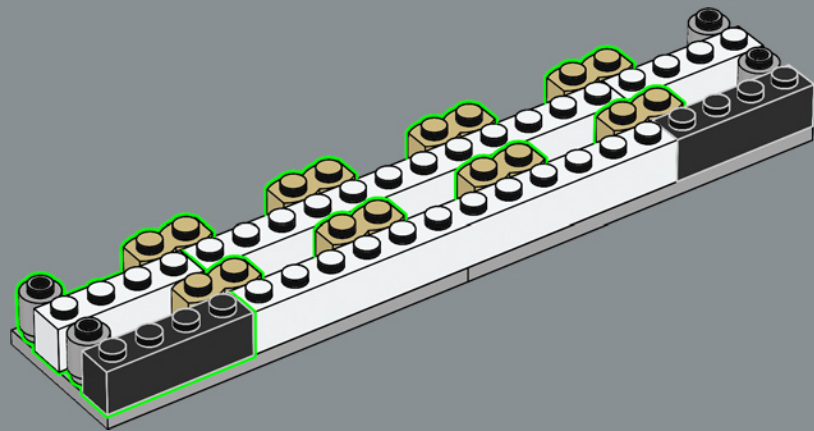

38

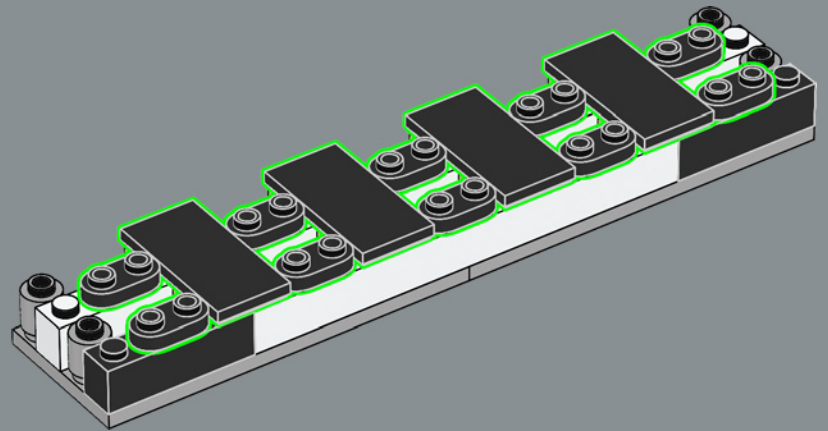





39

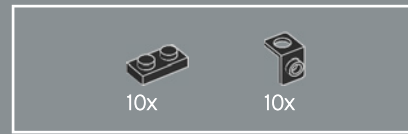
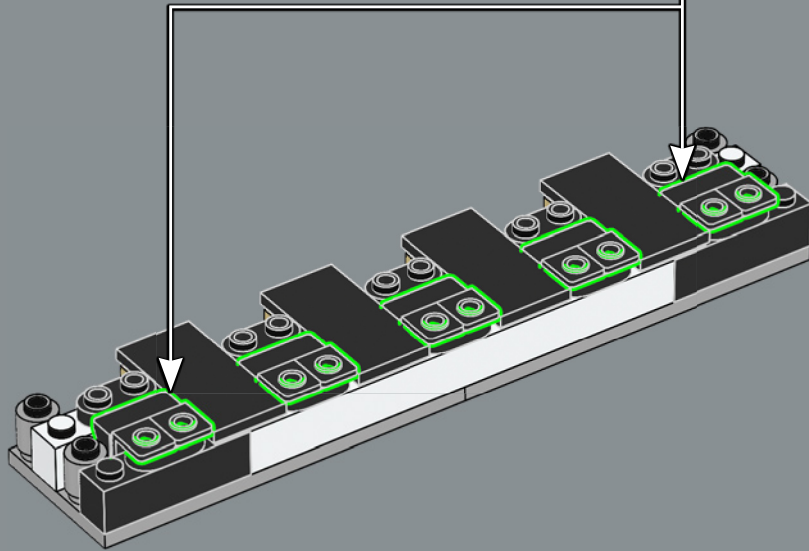
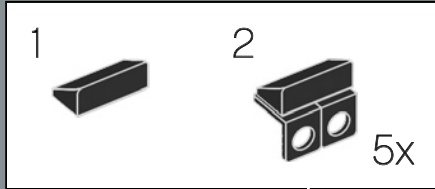

40

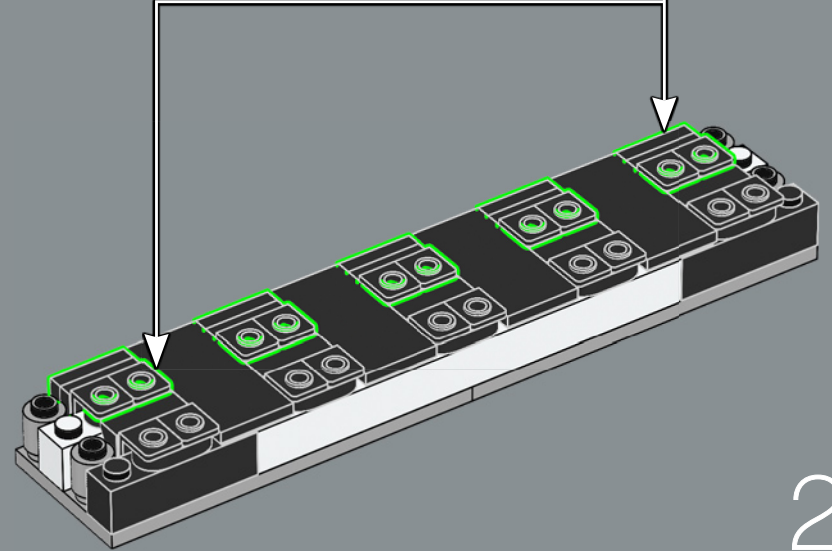
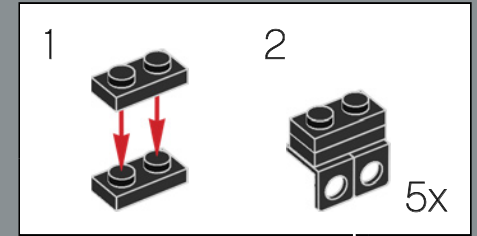

2x

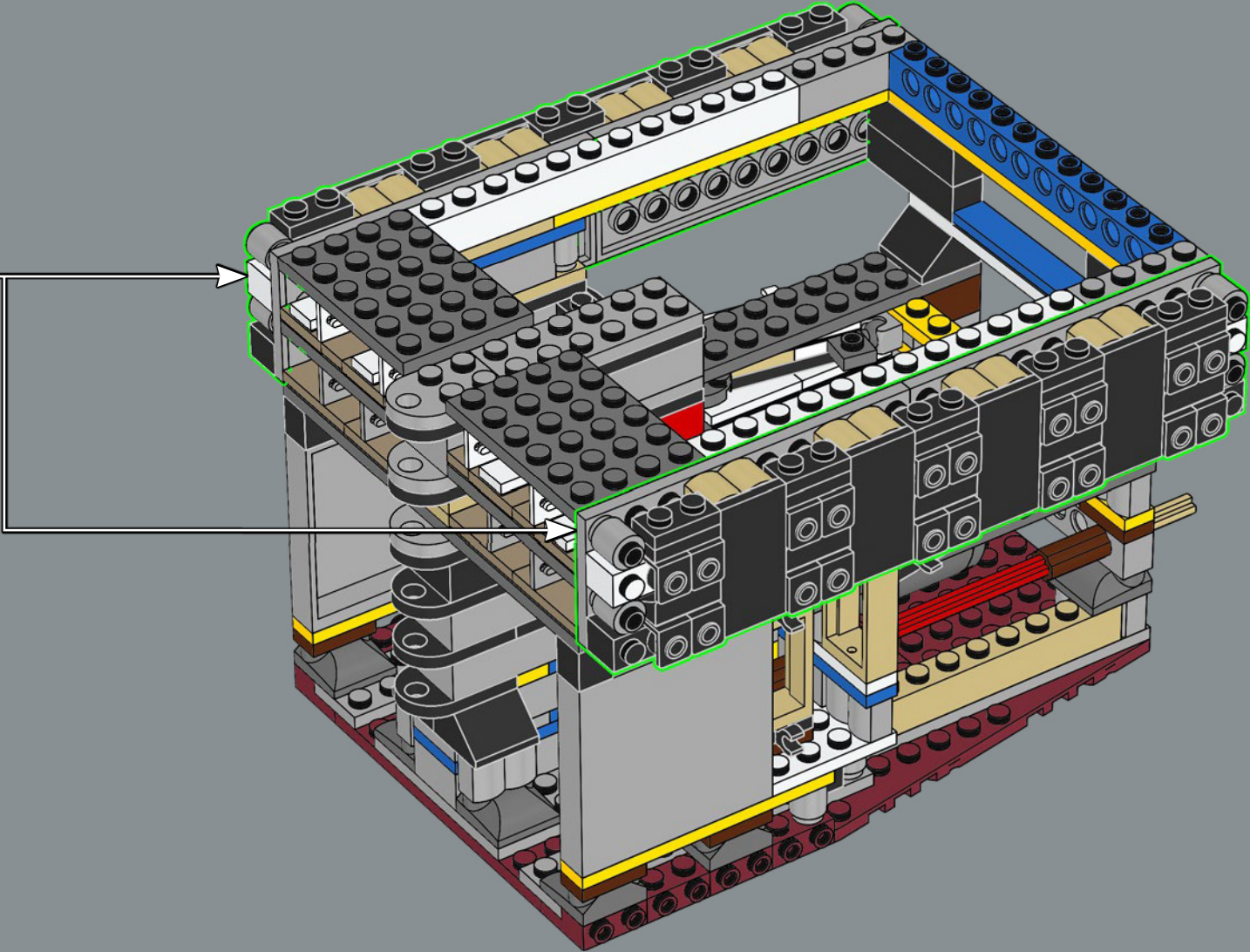

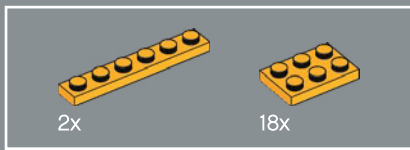

42

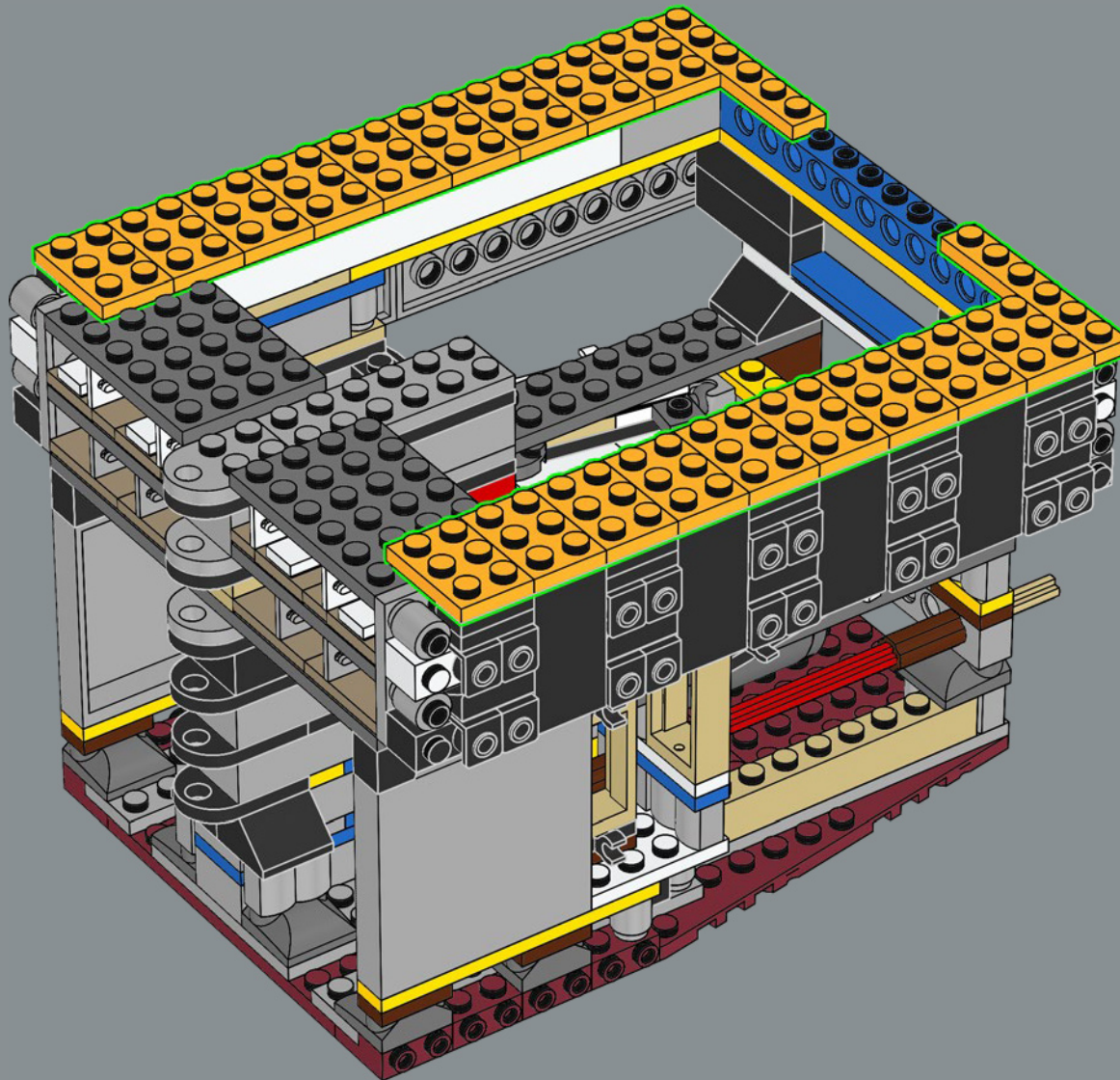

31

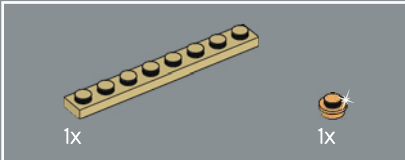
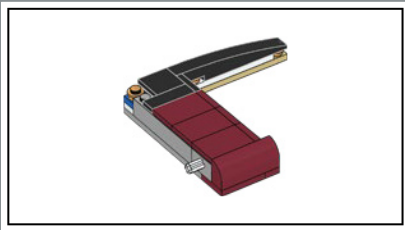
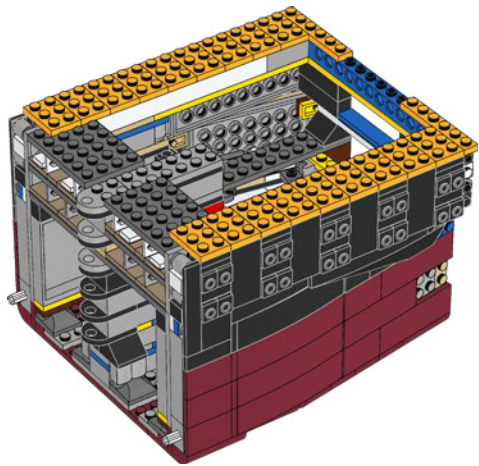
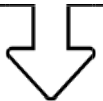

43

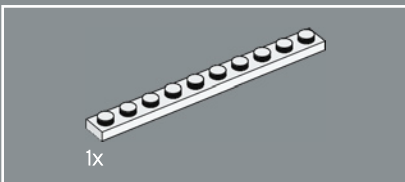
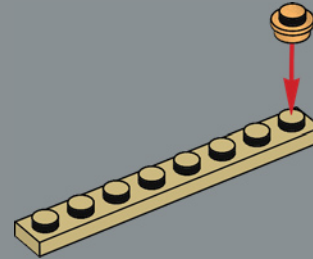

44

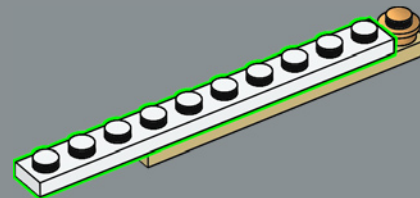

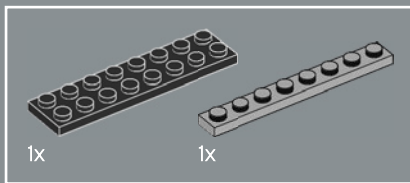

45

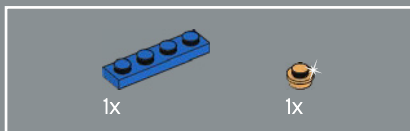
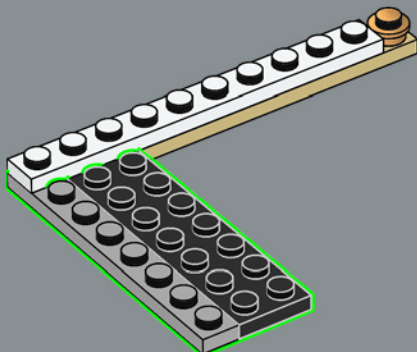

46

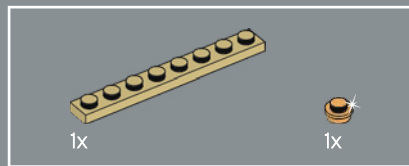
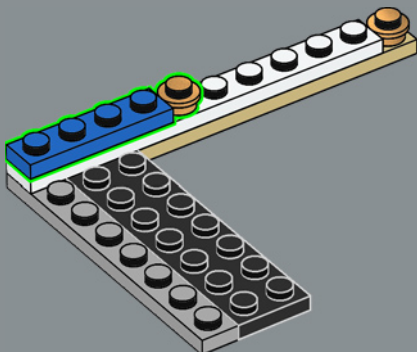

47

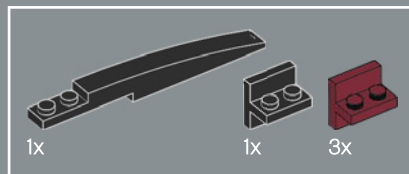
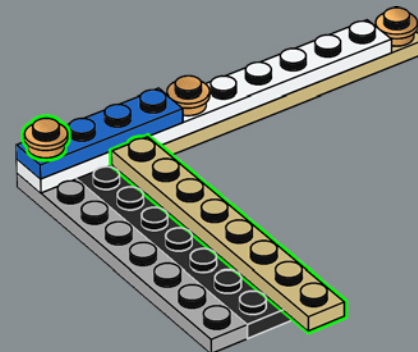

48

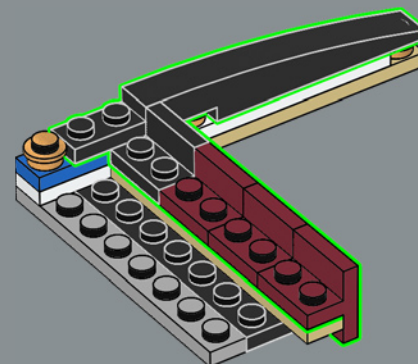

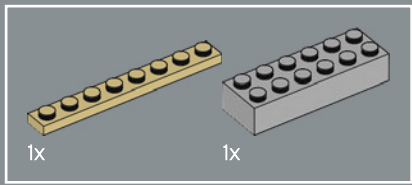

49

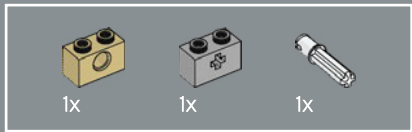
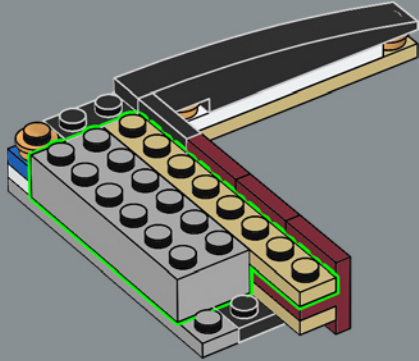

50

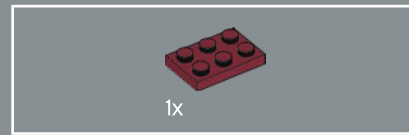
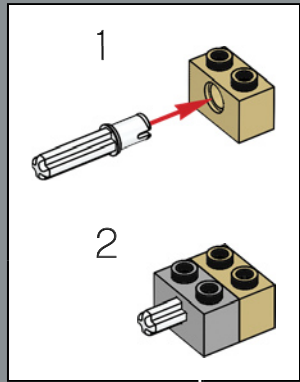
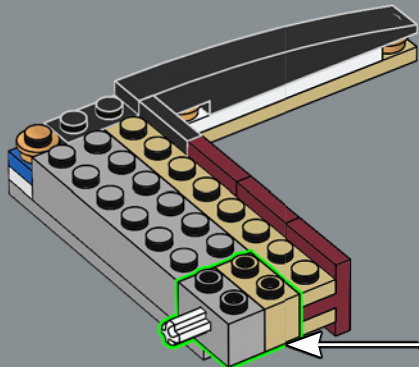

51

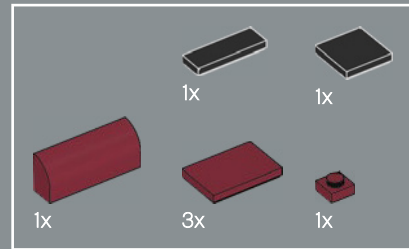
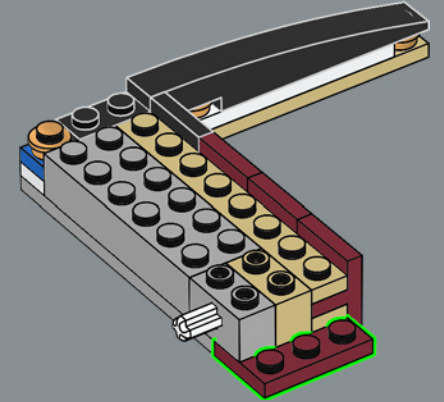

52

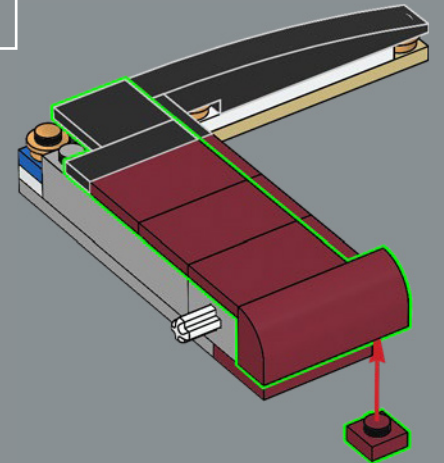

53

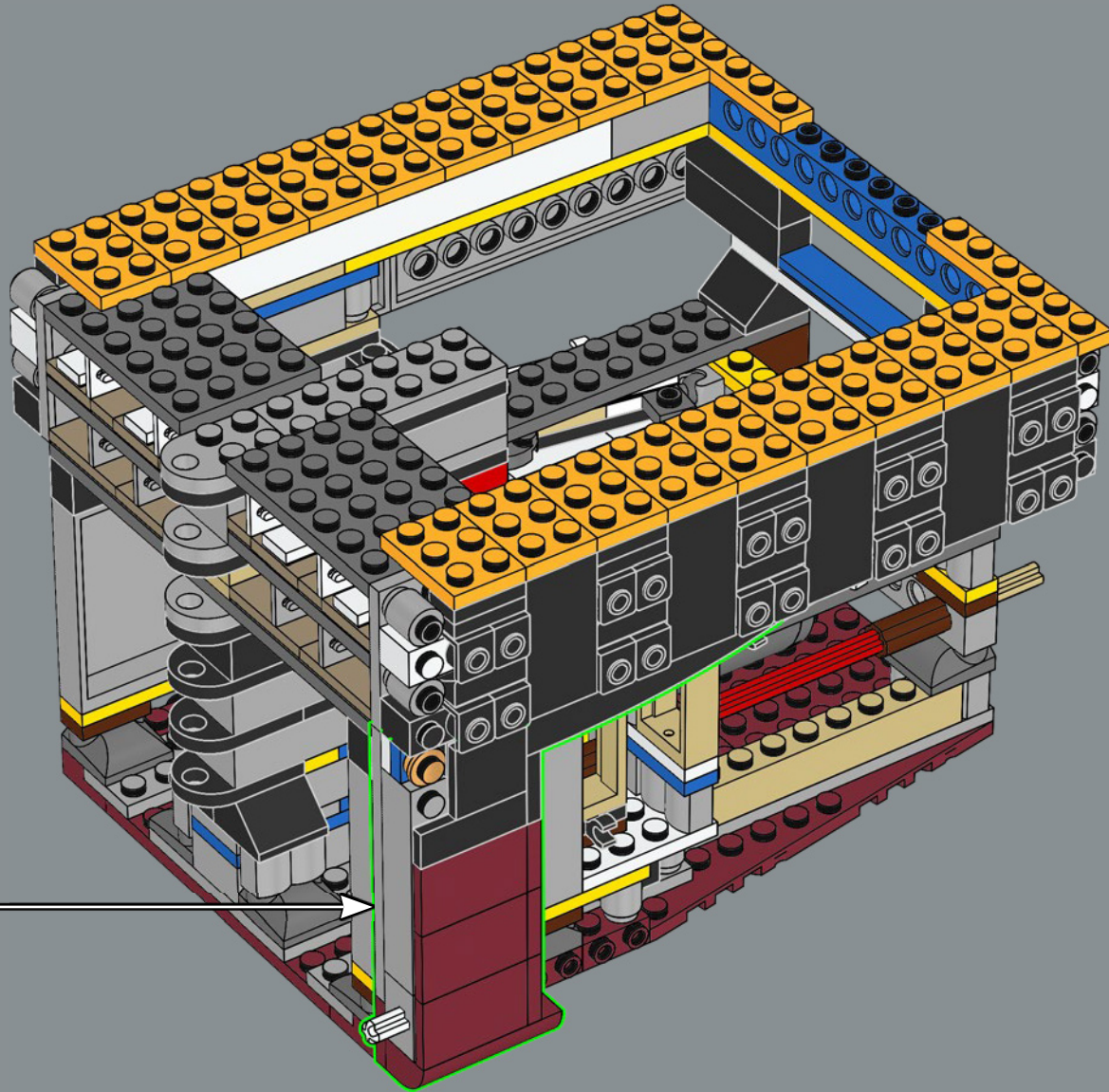

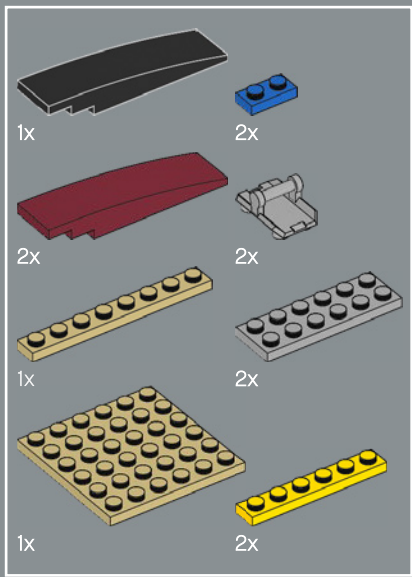

54

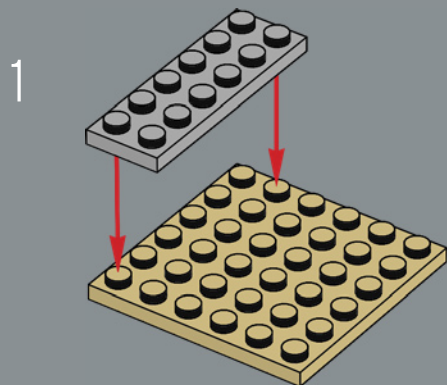

2

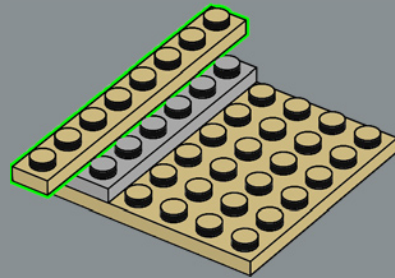

3

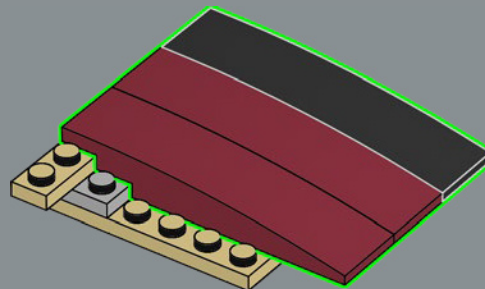

4

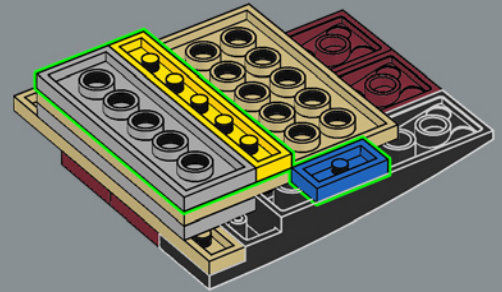

5

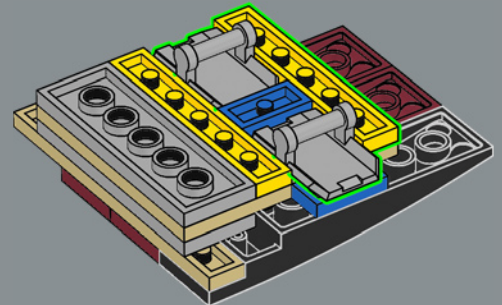



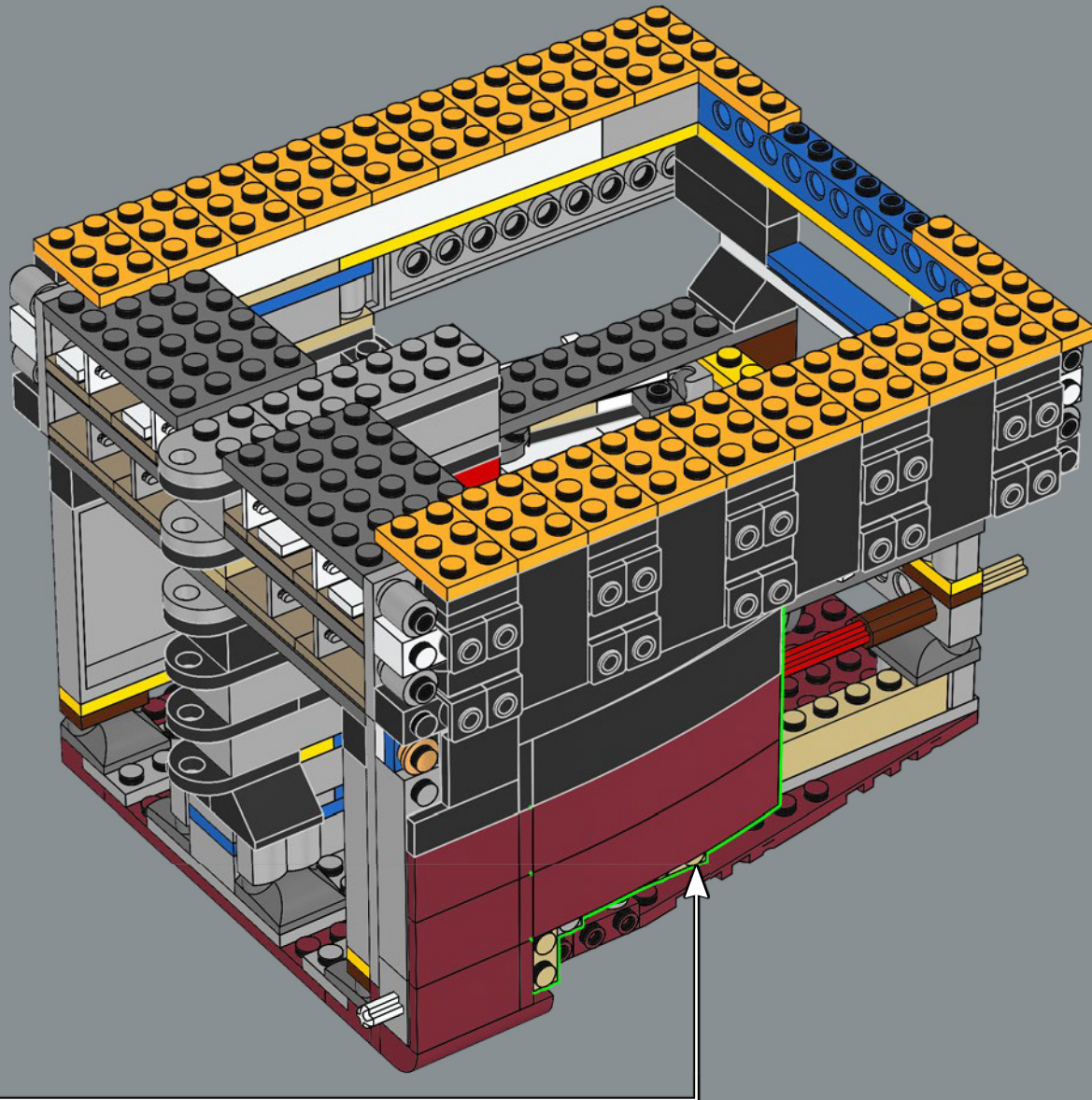



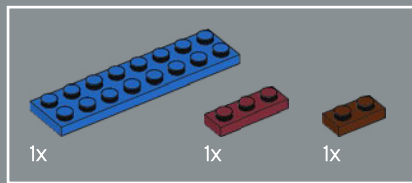

59

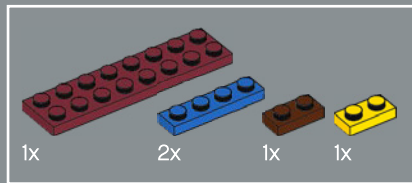
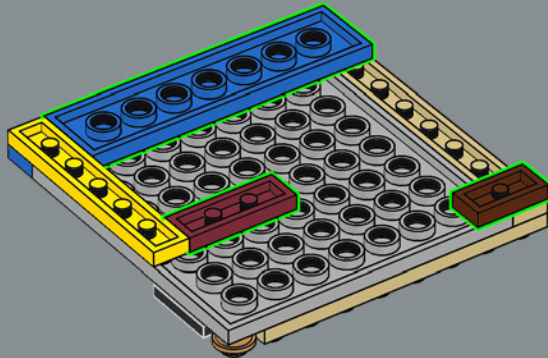

60

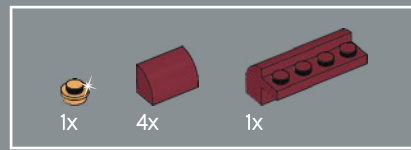
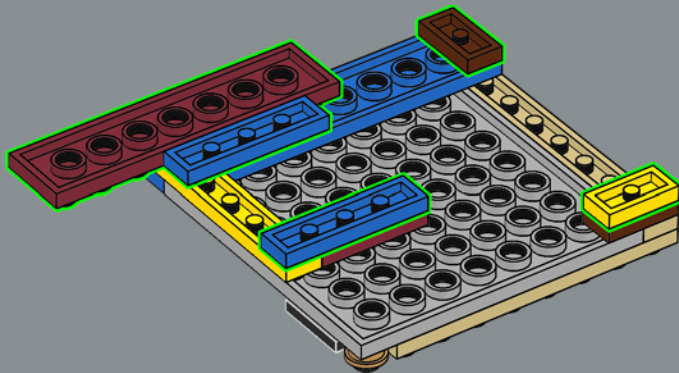

61

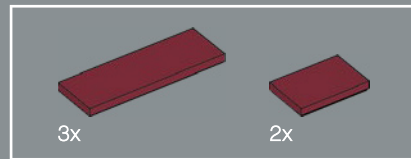
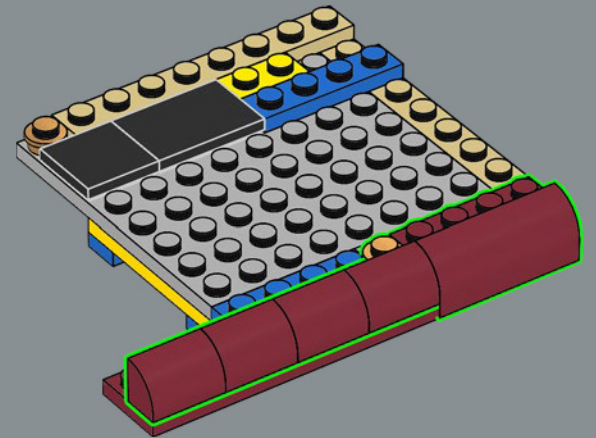

62

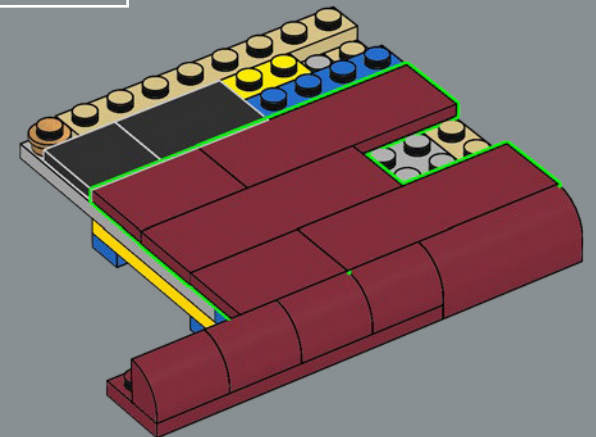

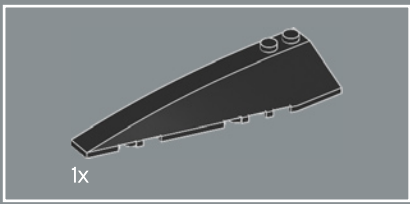

63

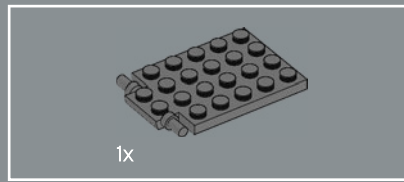
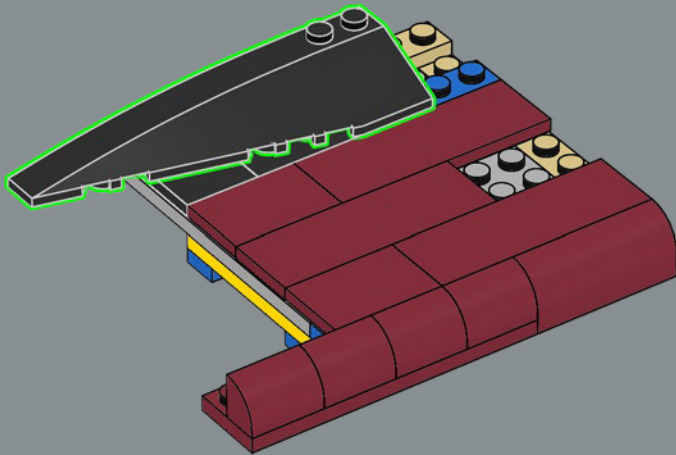

64

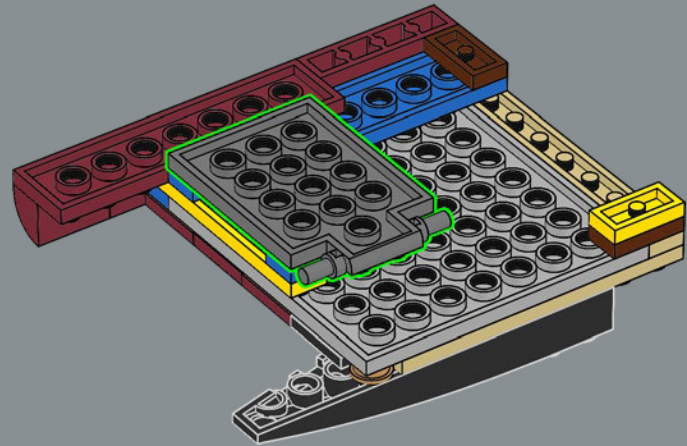

65

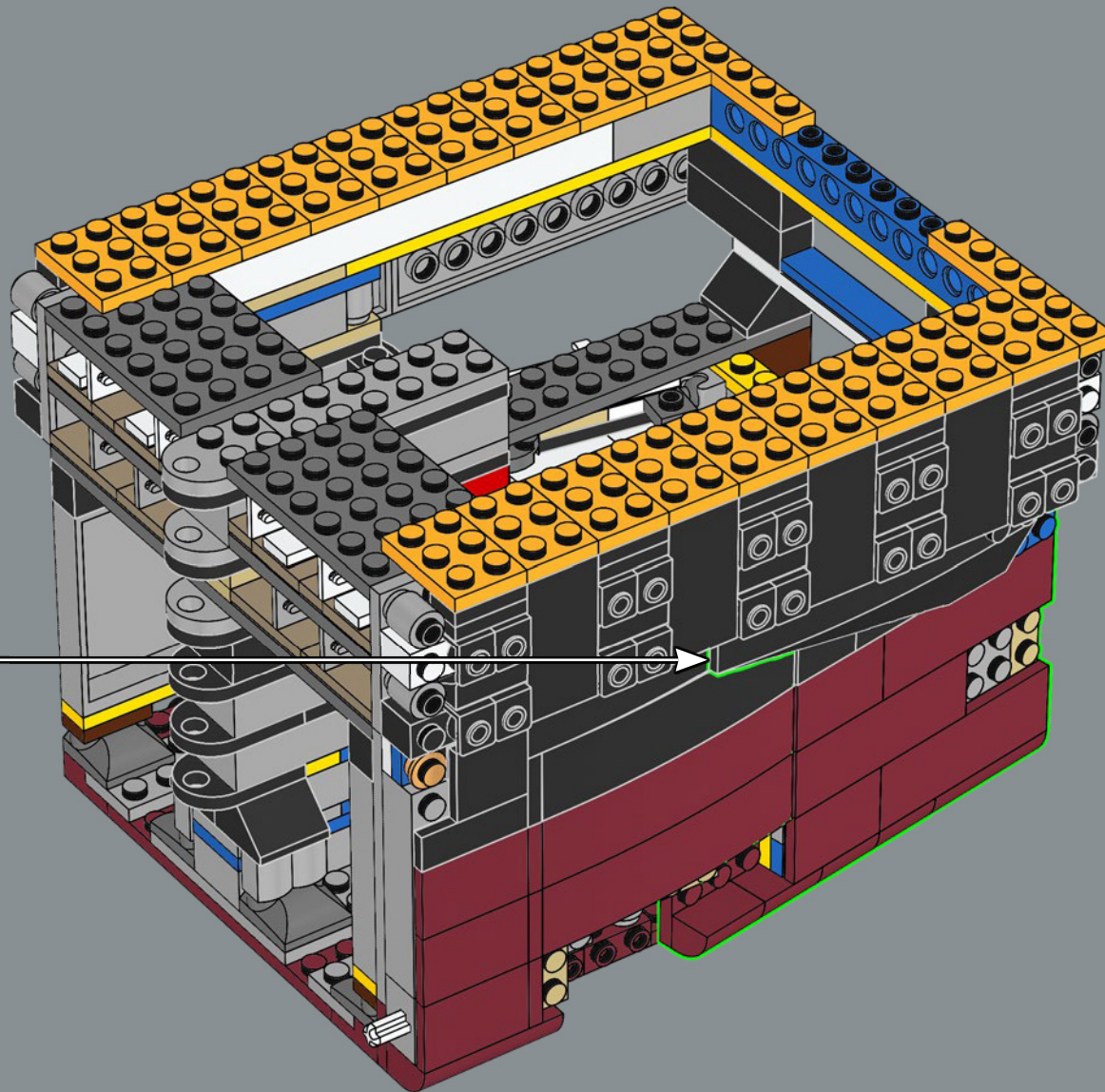

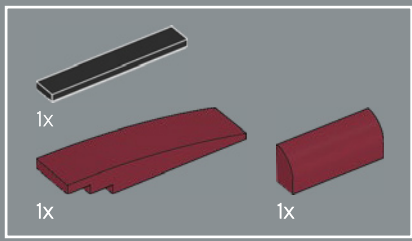

66

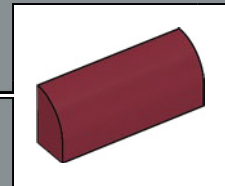
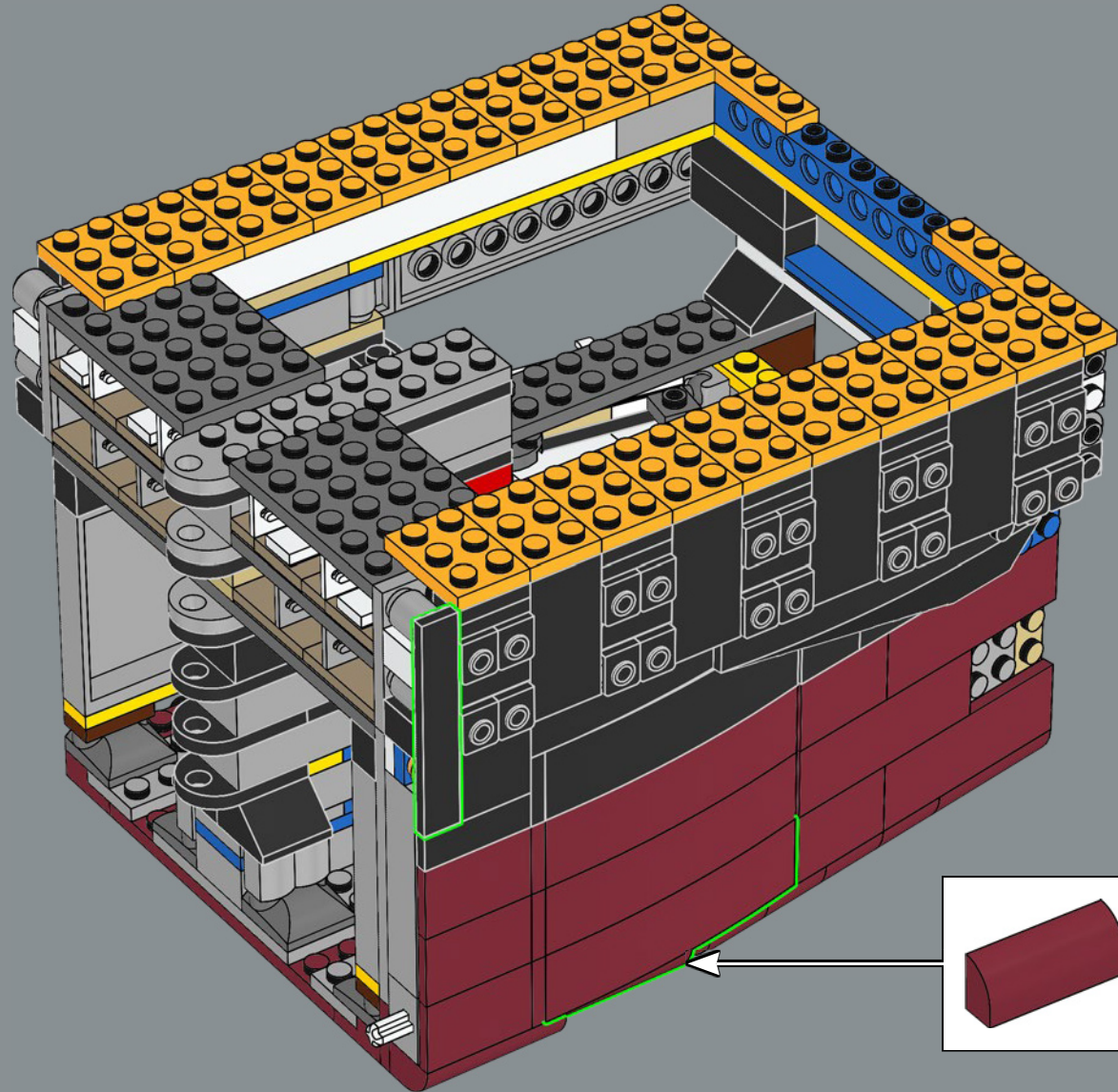

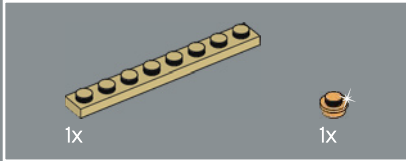
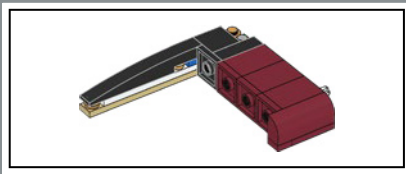

67

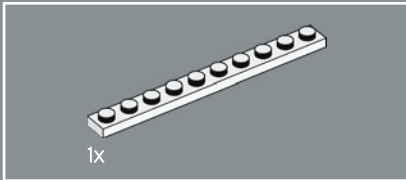
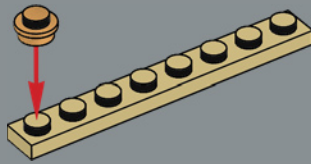

68

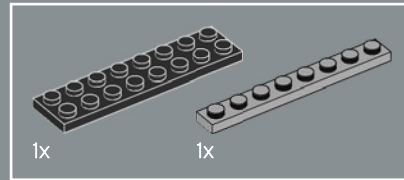
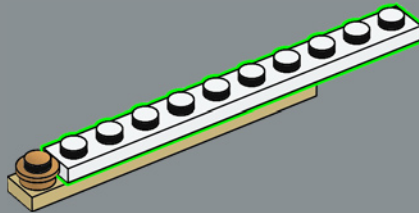

69

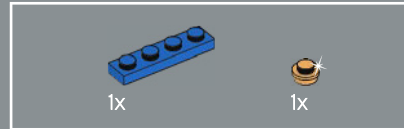
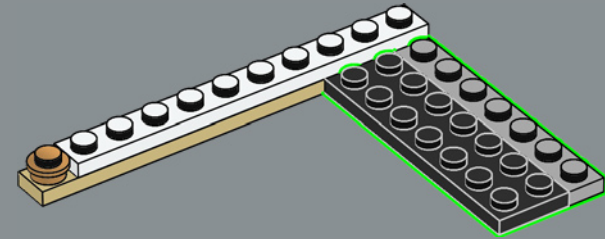

70

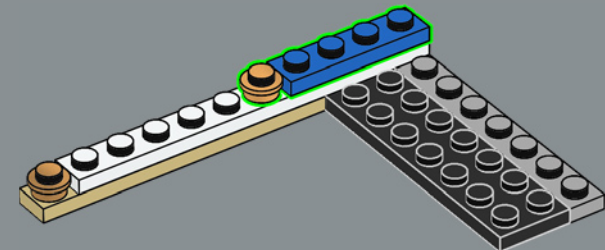

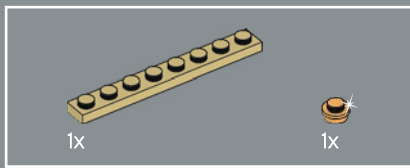

71

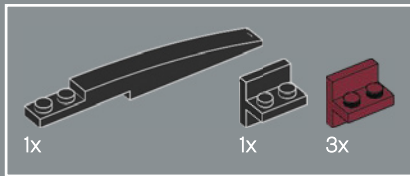
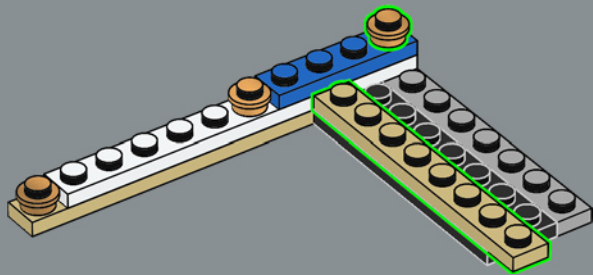

72

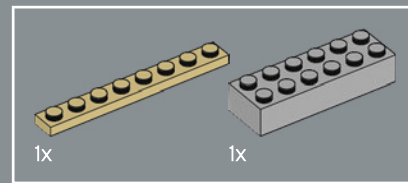
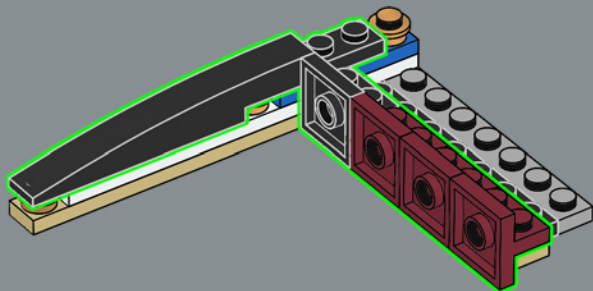

73

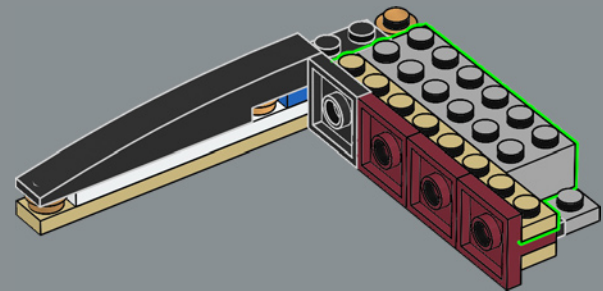



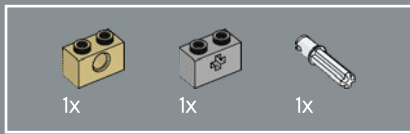

74

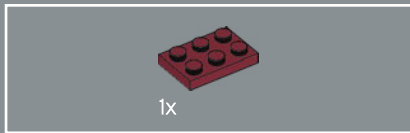
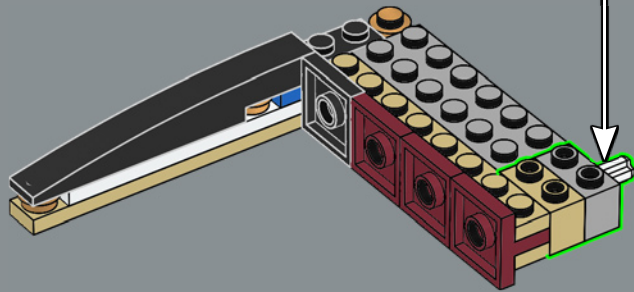
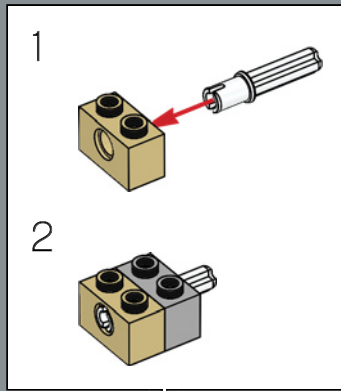

75

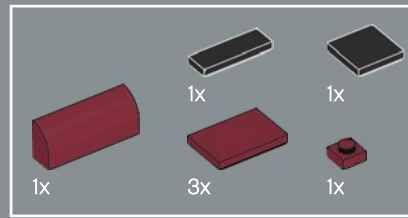
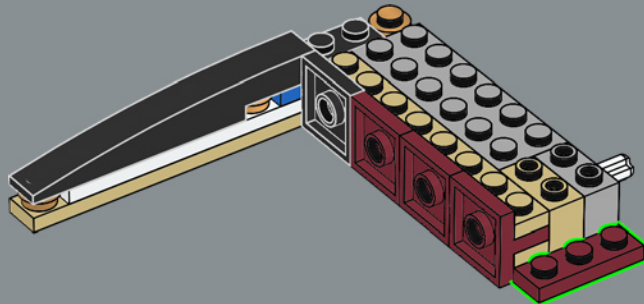

76

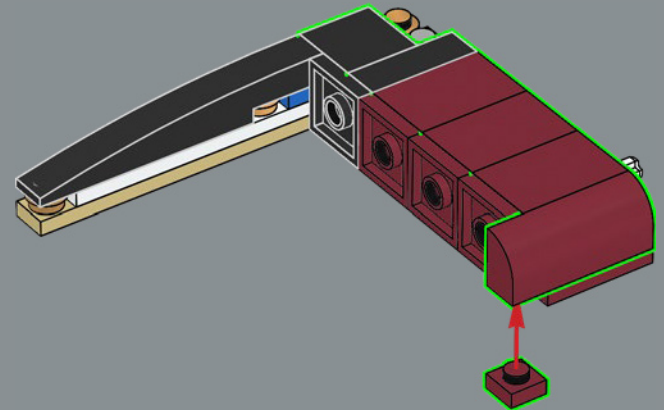

77

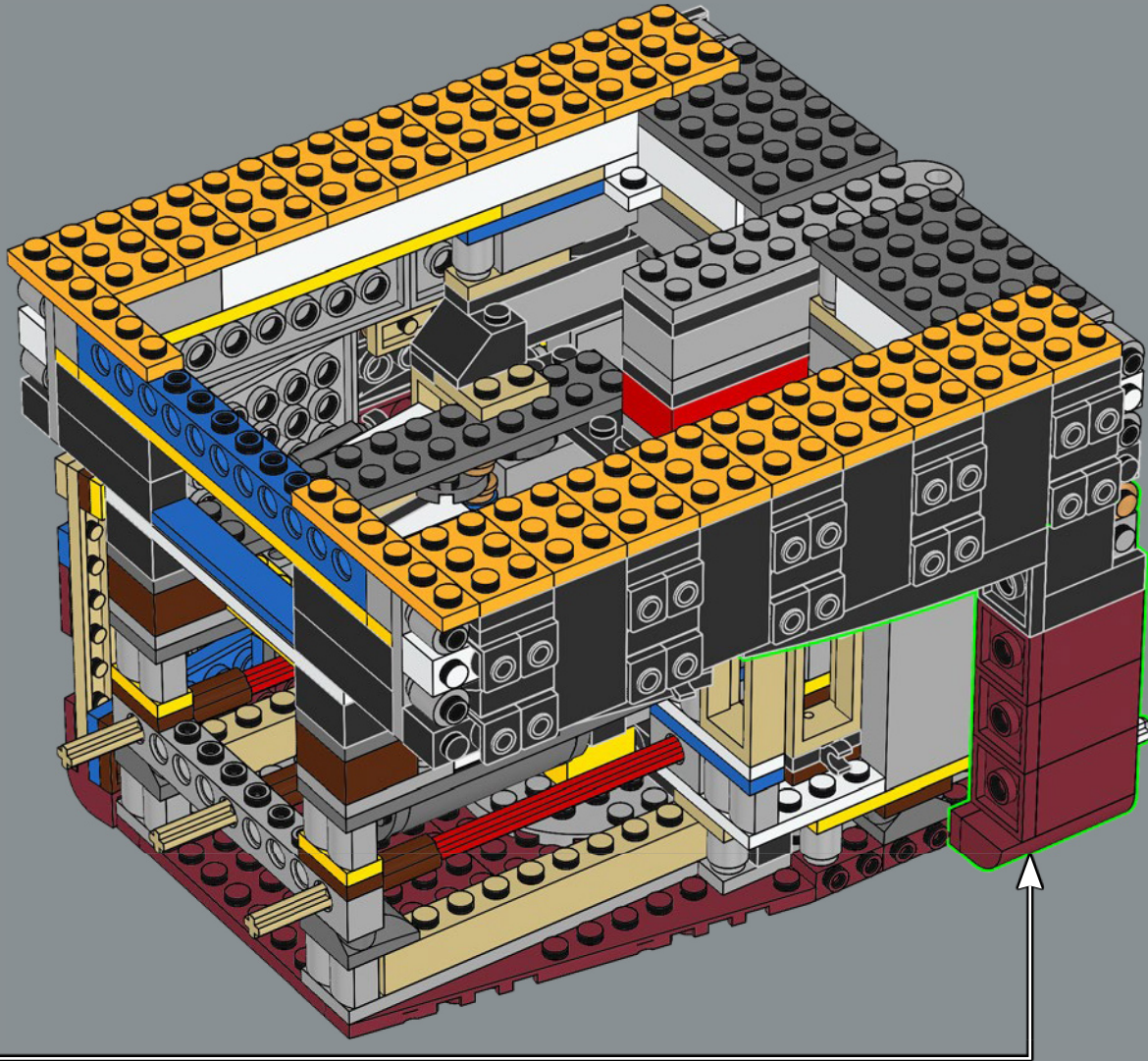

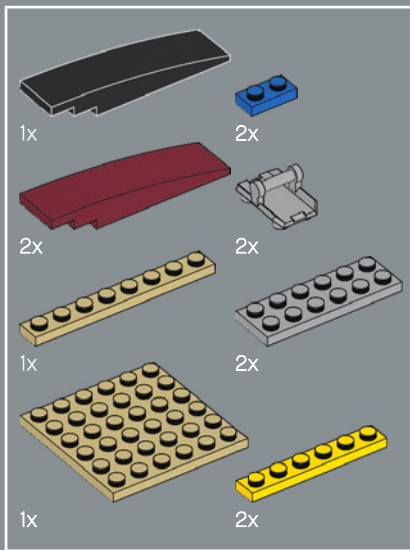

78

1

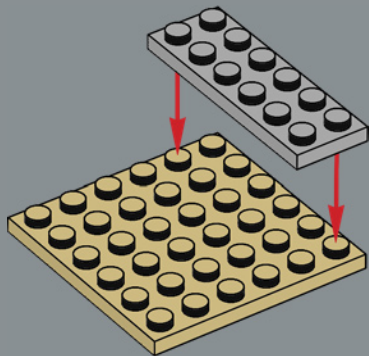

2

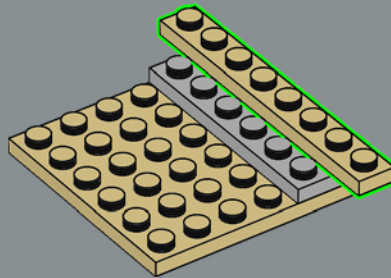

3

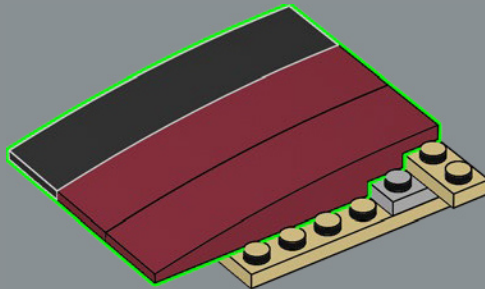

4

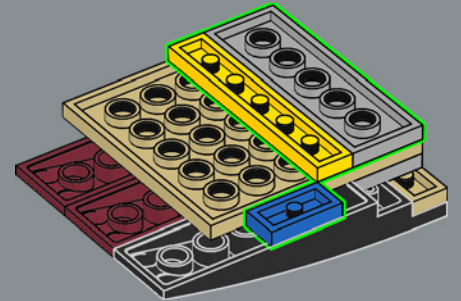

5

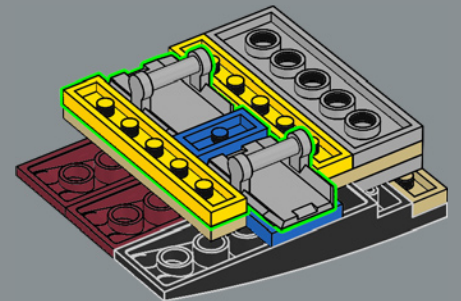

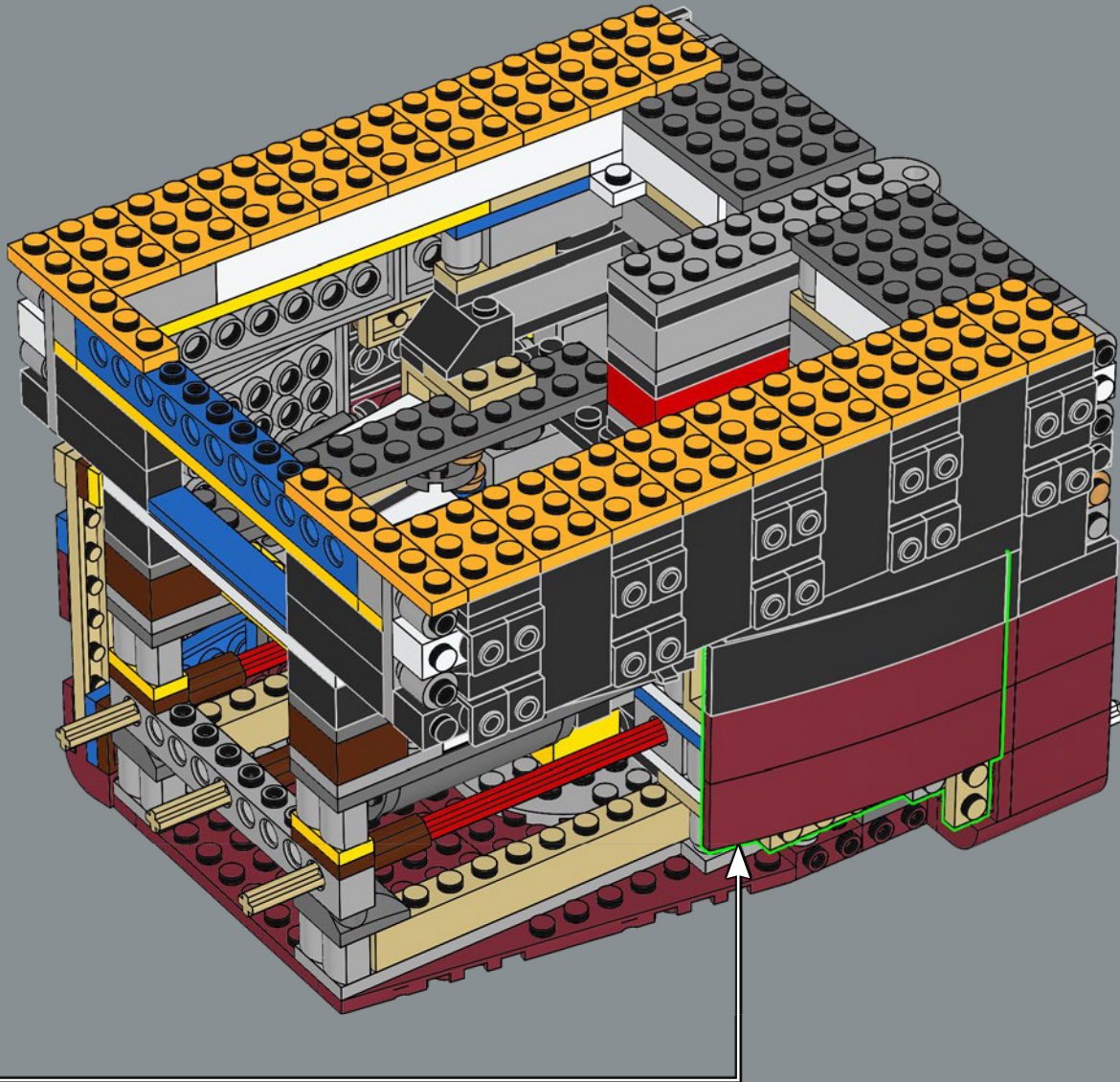

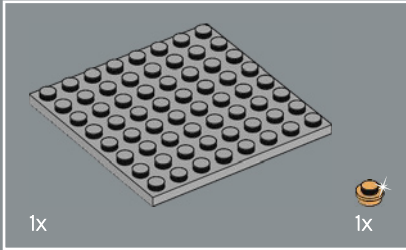
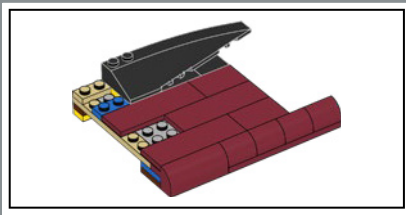

79

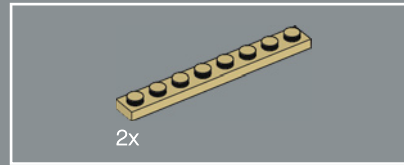
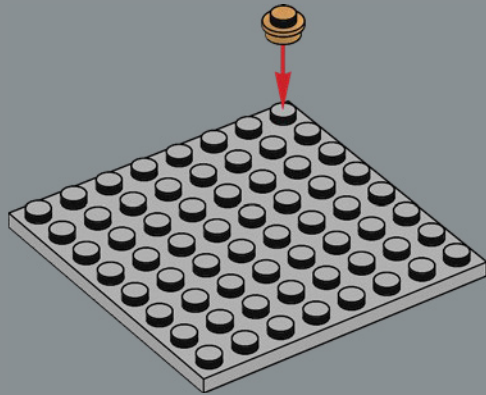

80

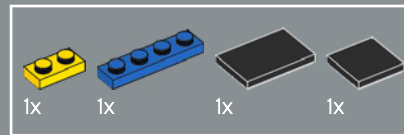
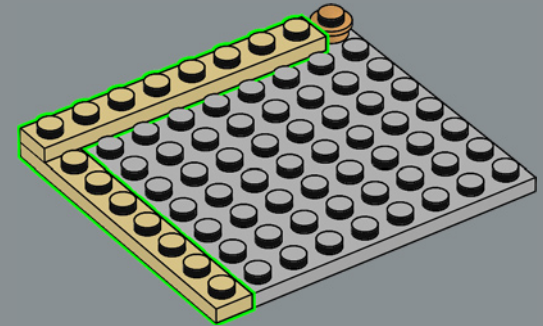

81

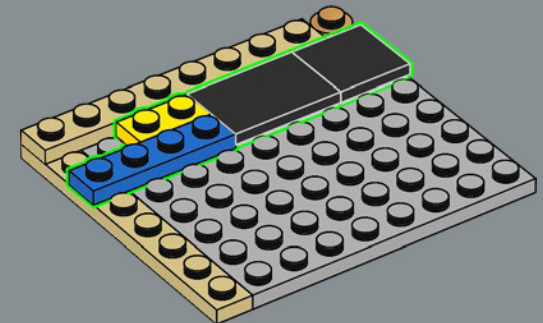

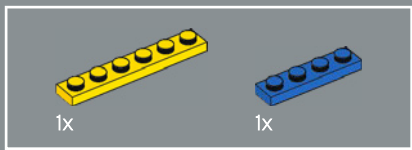

82

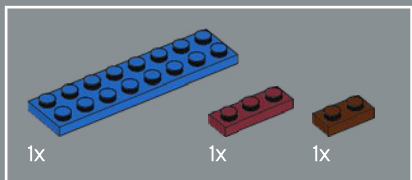
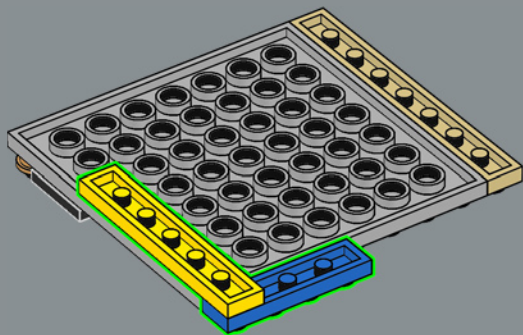

83

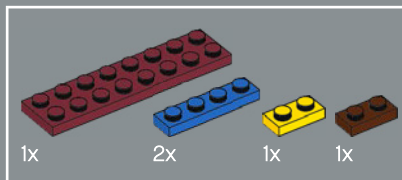
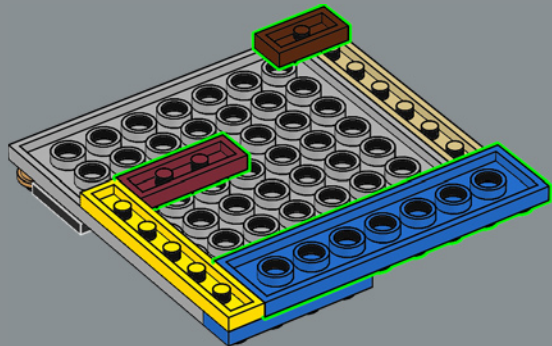

84

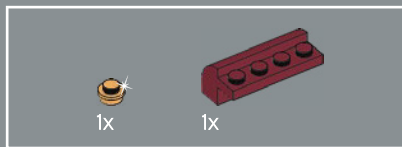
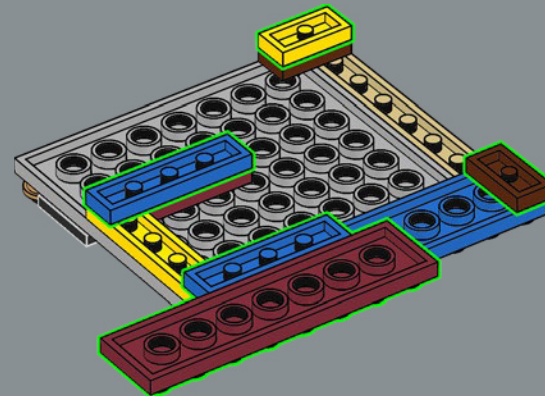

85

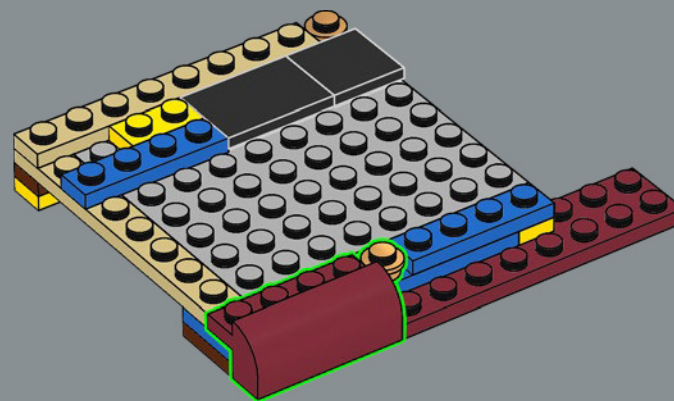

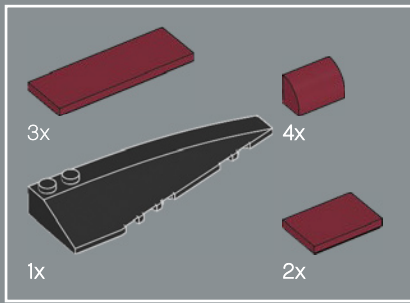

86

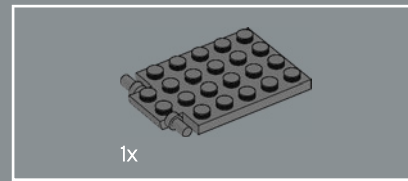
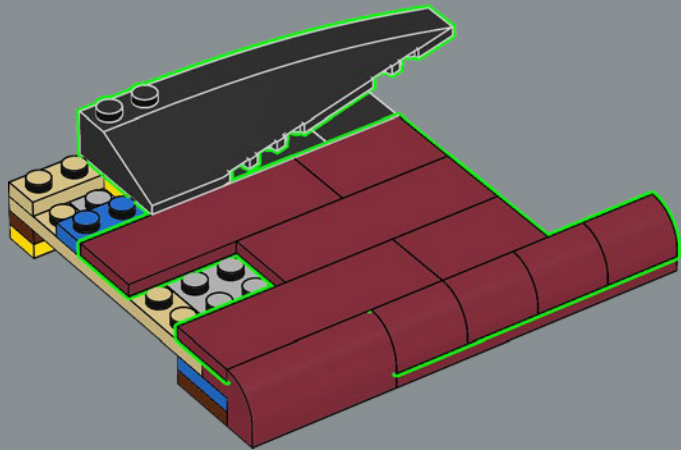

87

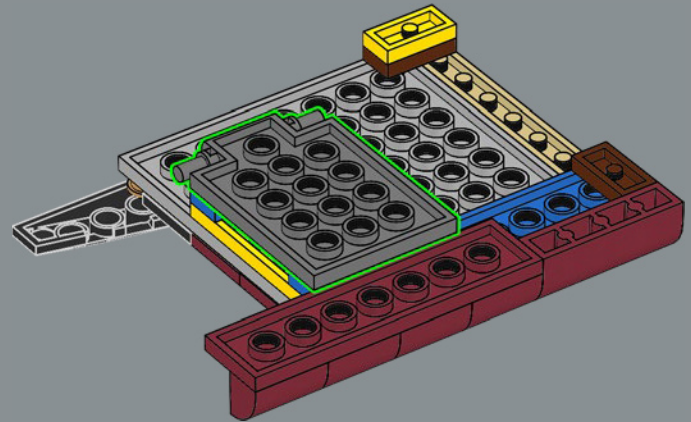

Le Titanic se trouve à 640 km de la terre  
ferme lorsqu'il heurte l'iceberg.

88

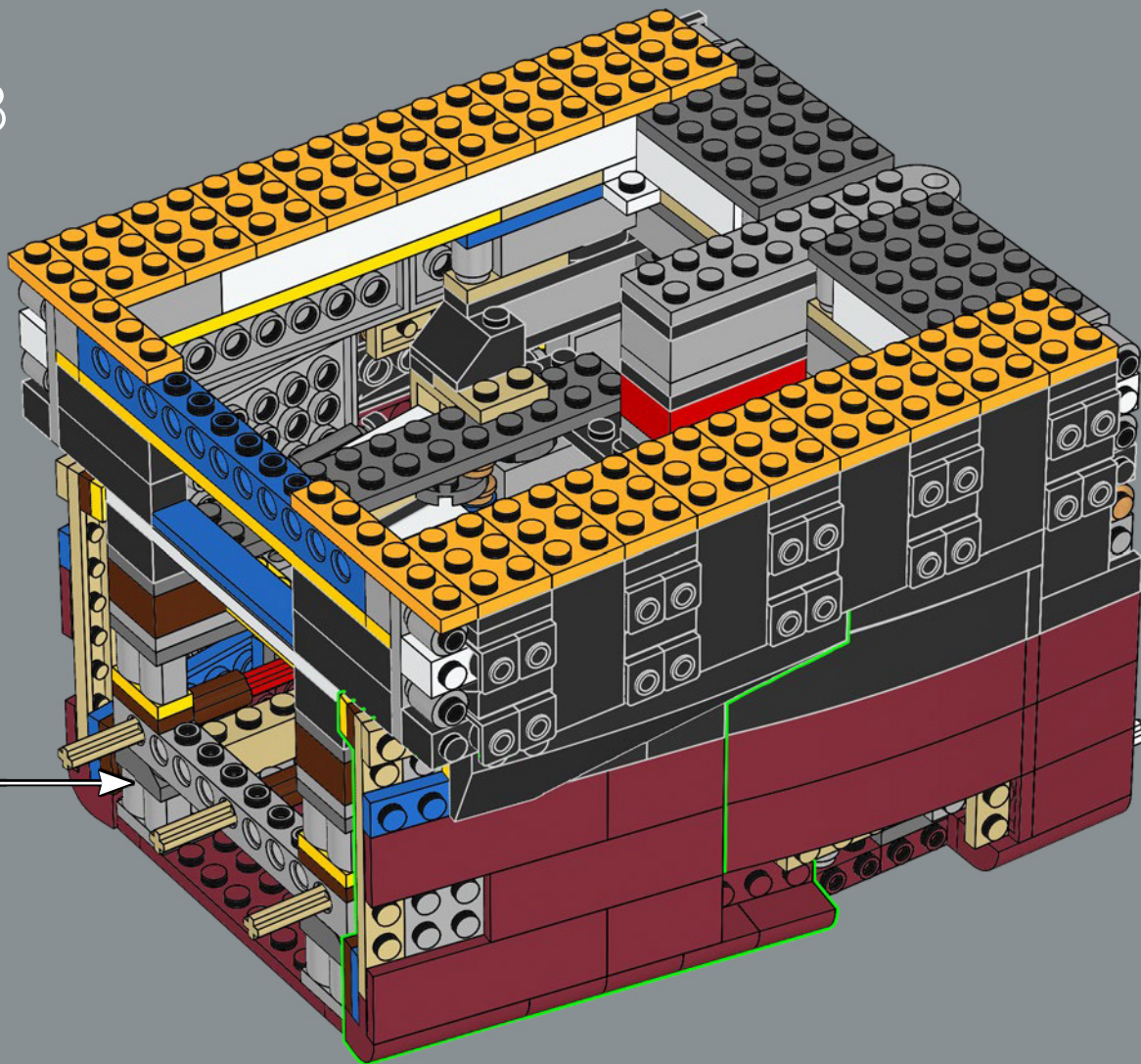



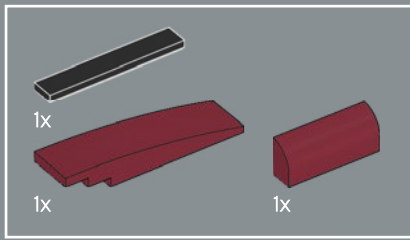

89

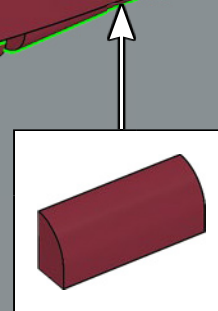
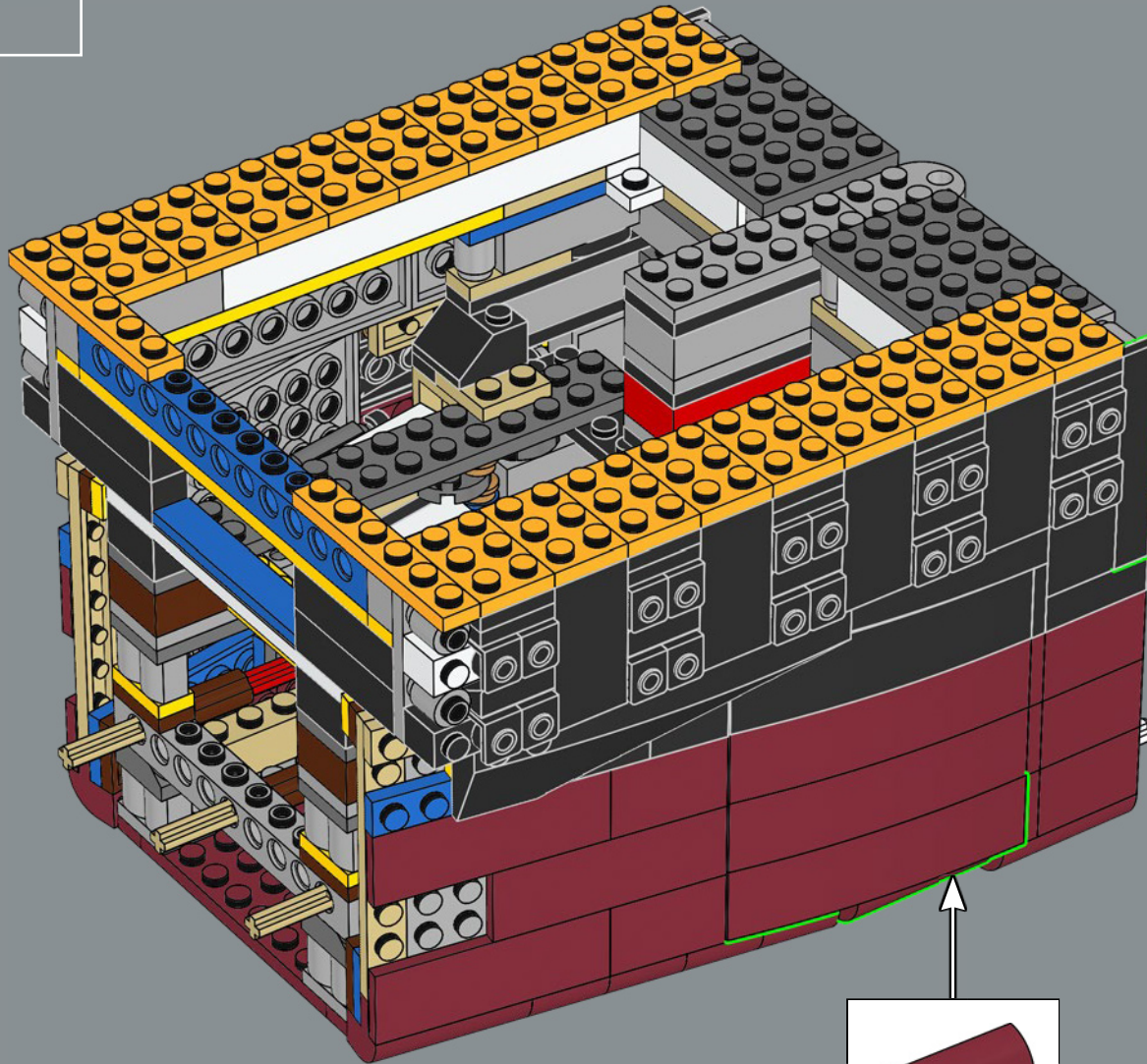

32

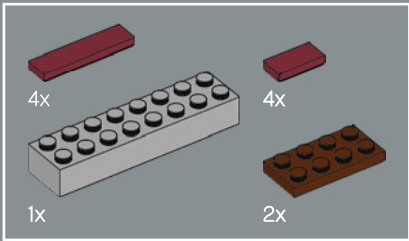

90

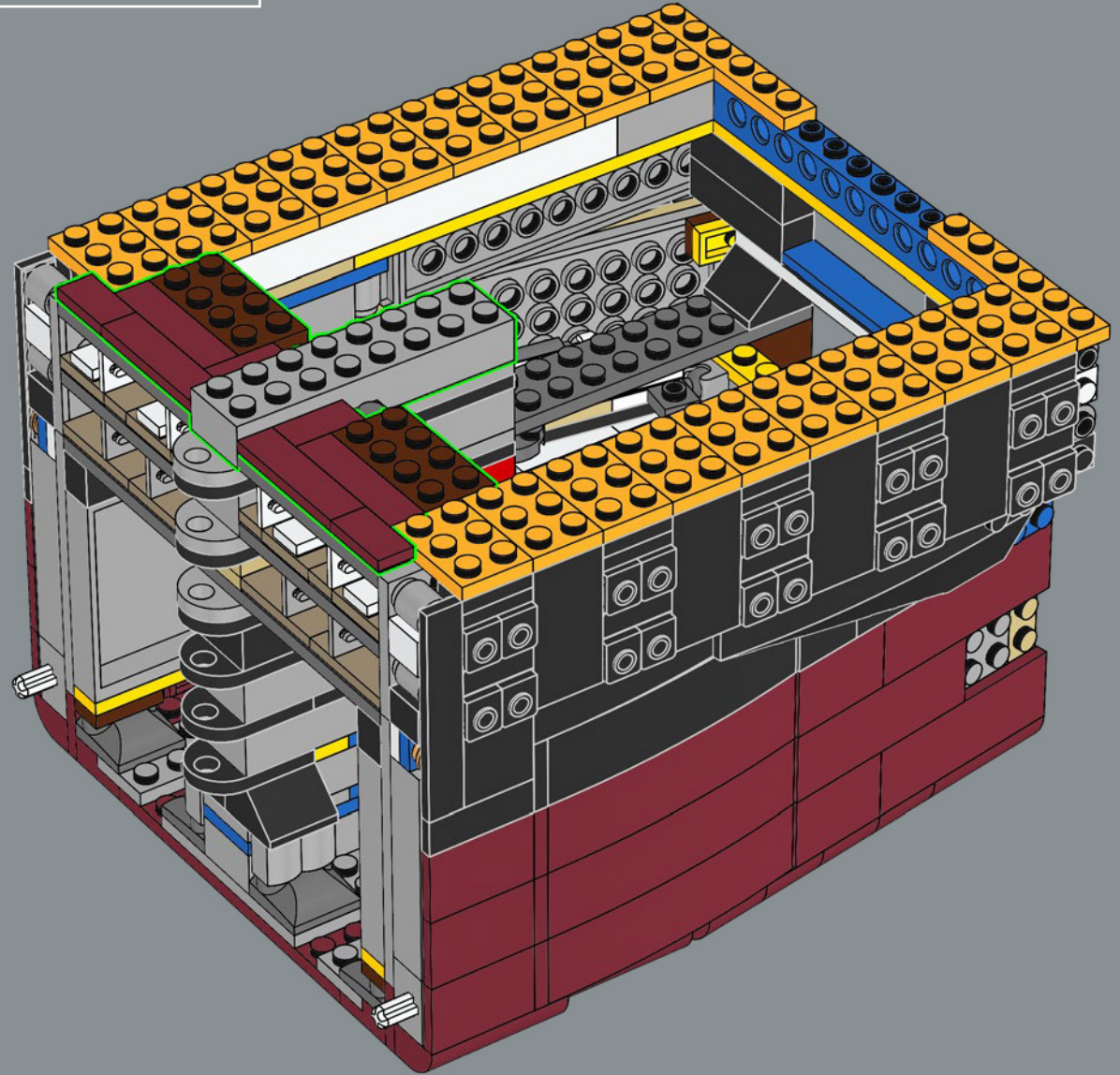

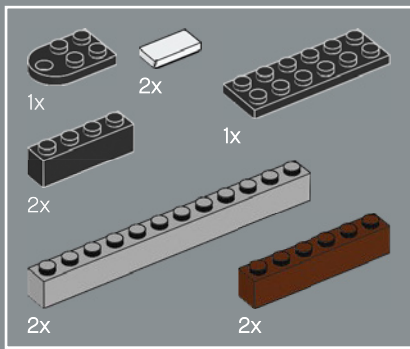

91

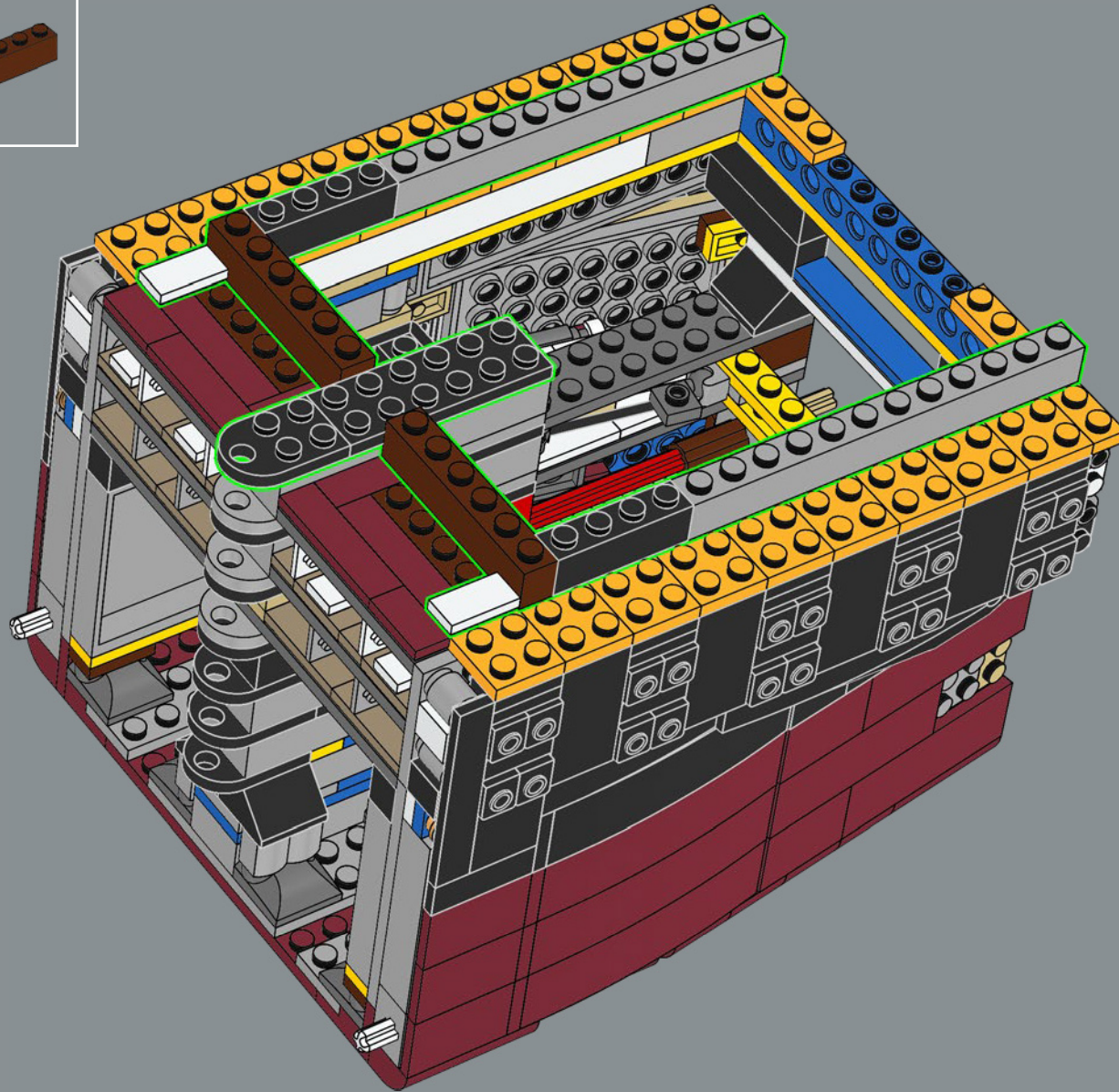

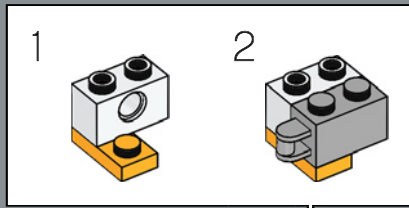
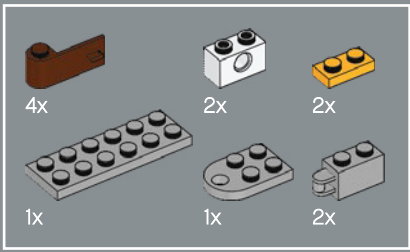

92

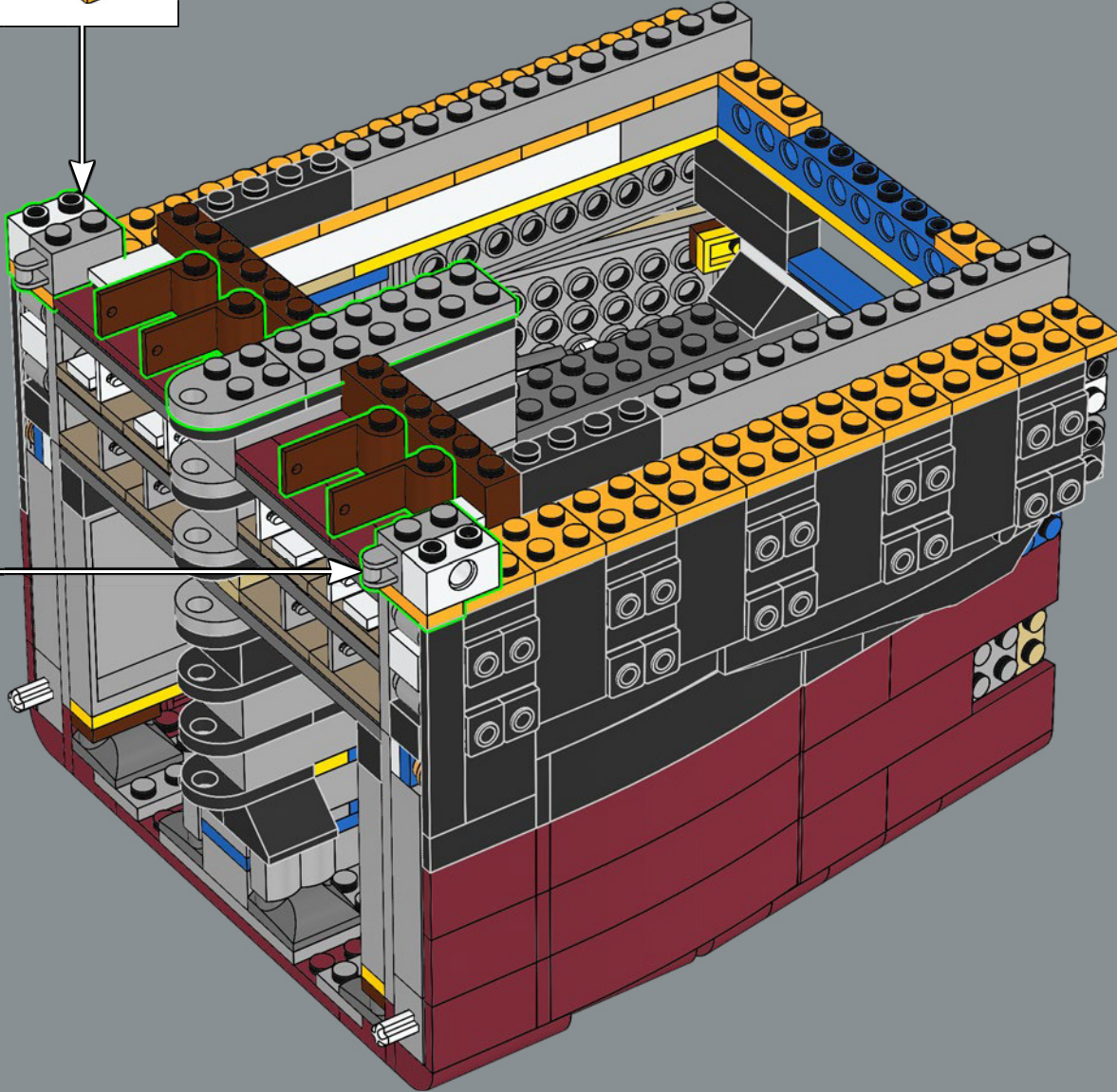
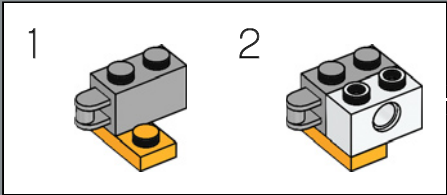



18x

93

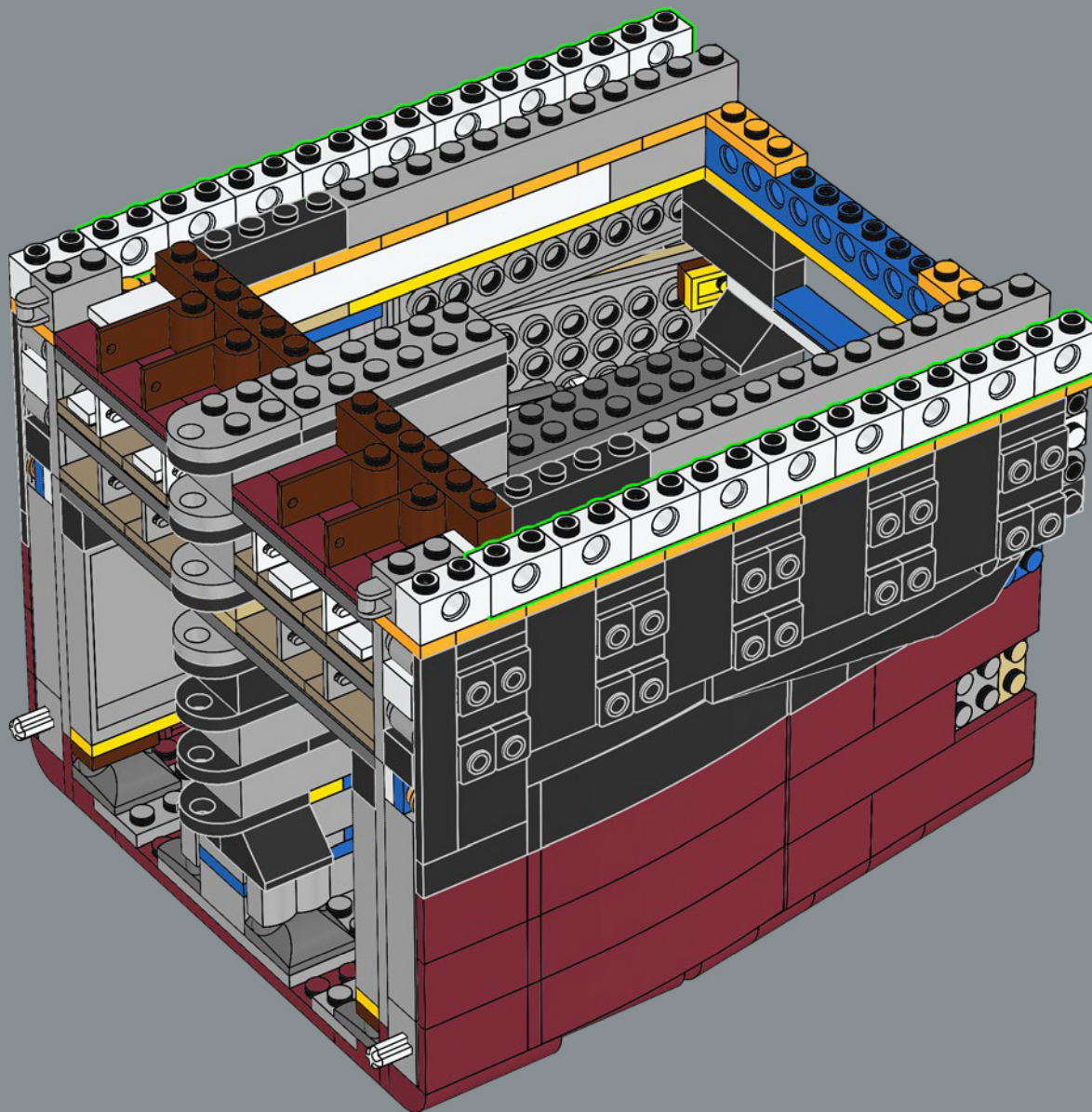

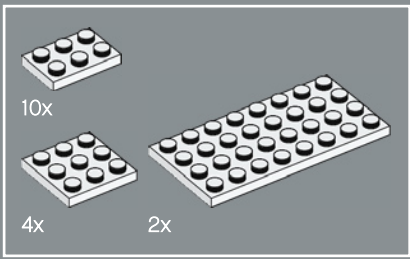

94

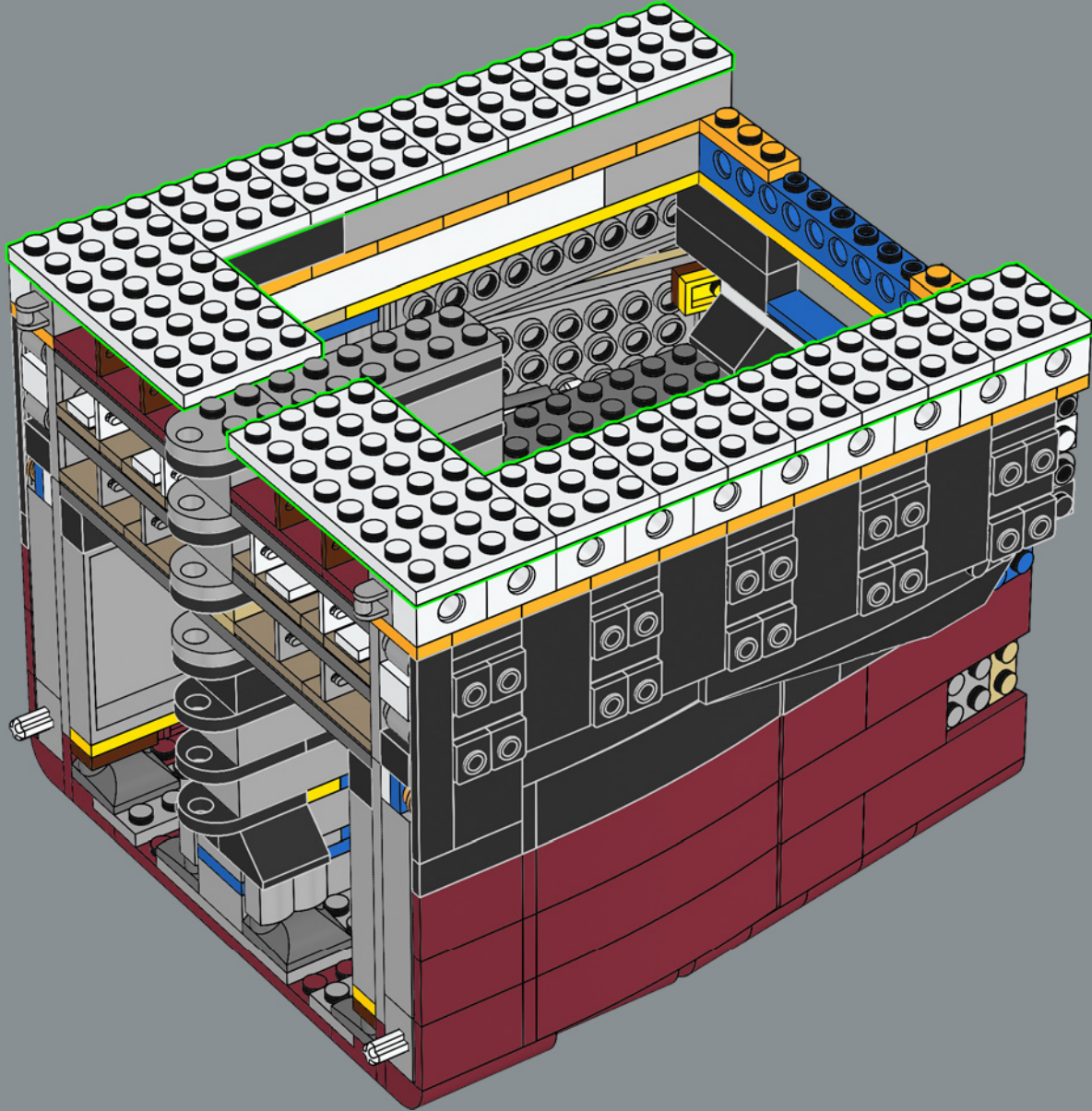

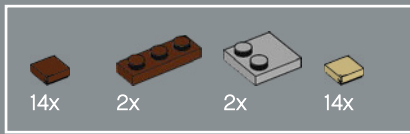

95

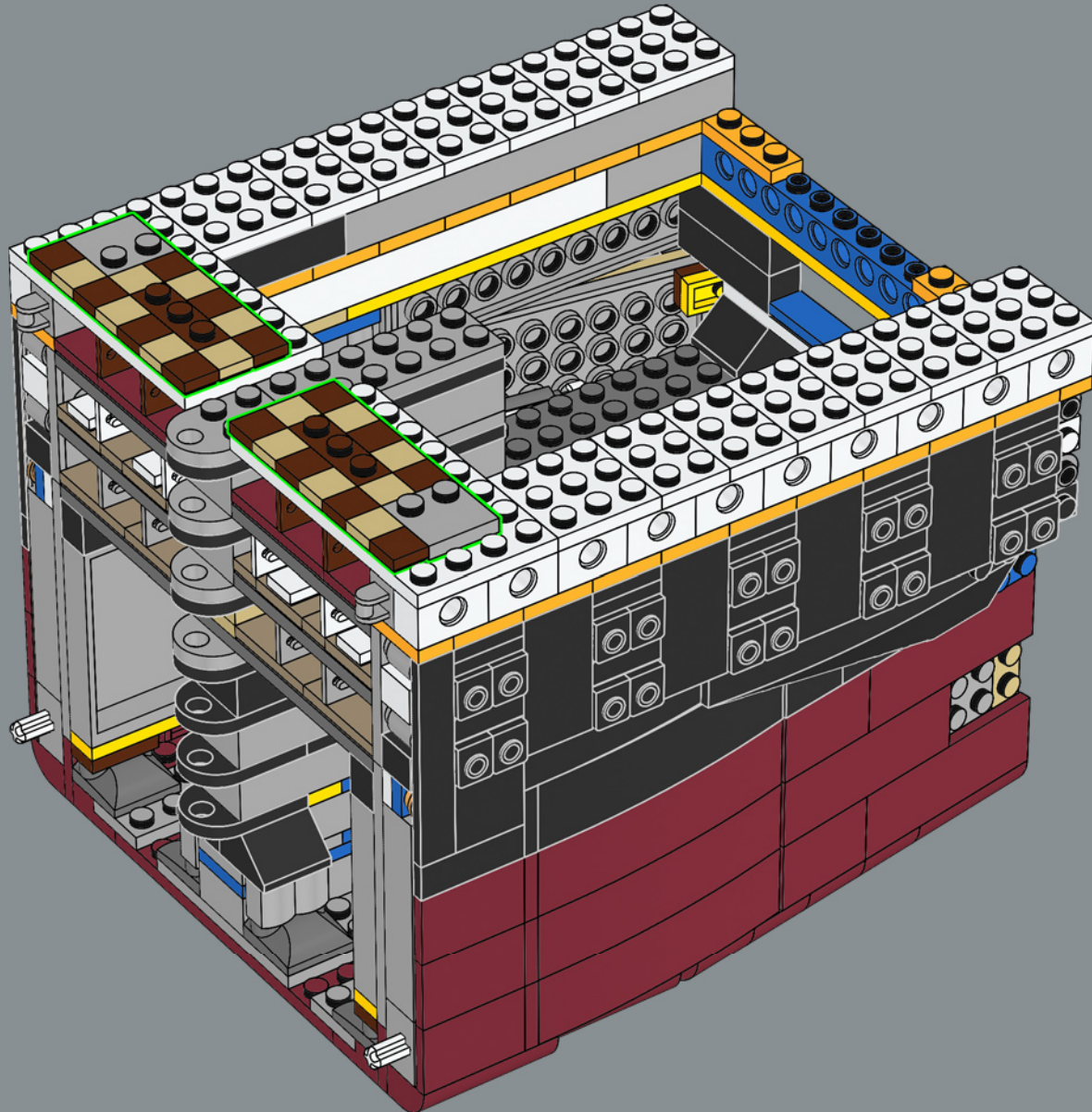

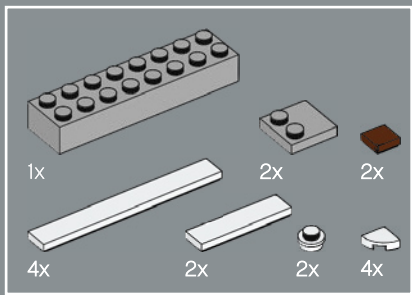

96

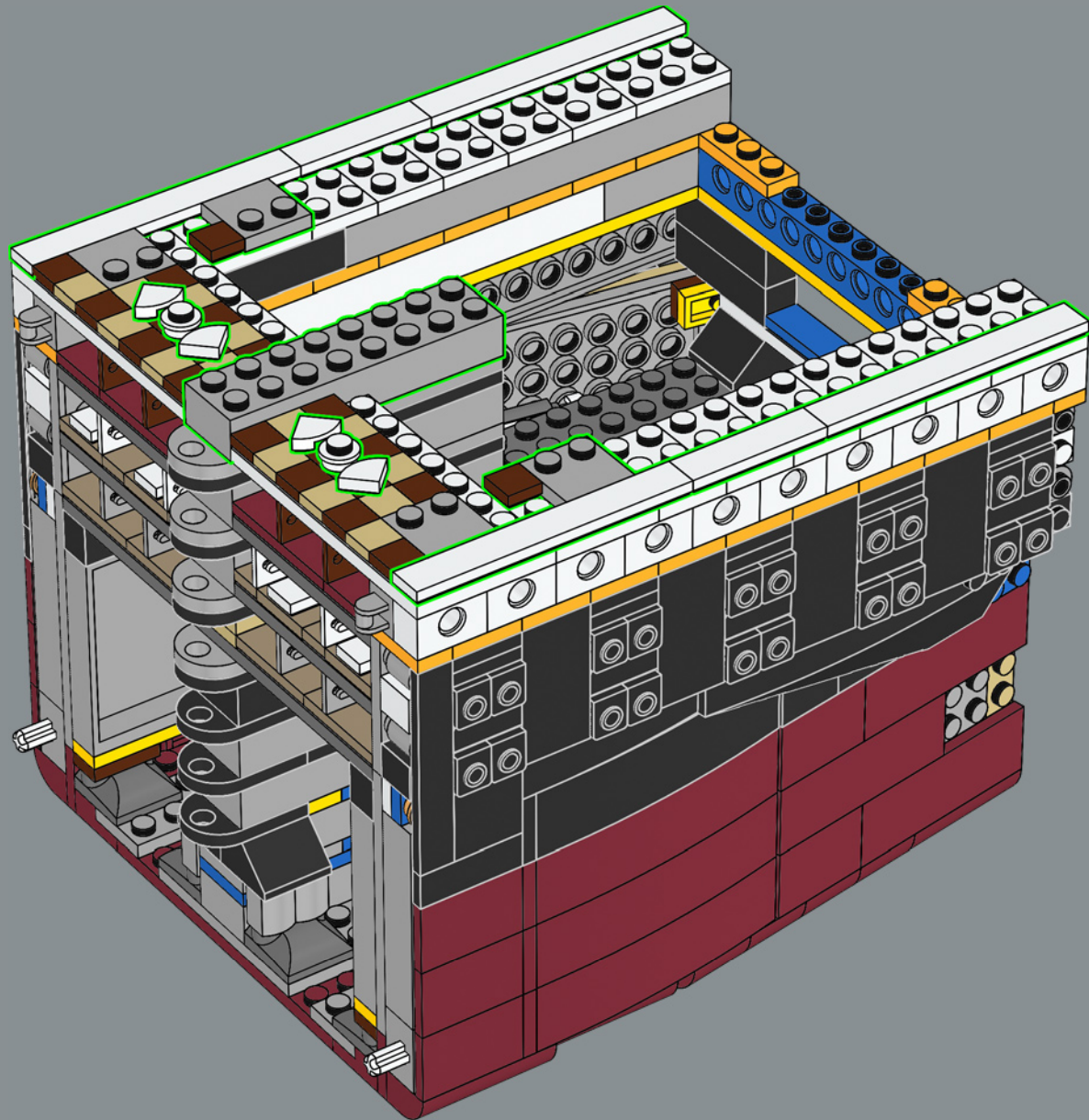



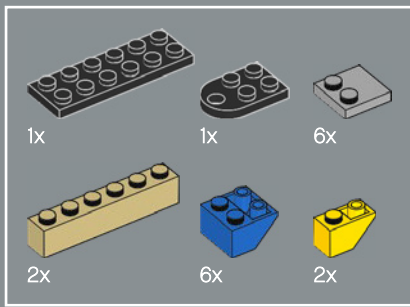

97

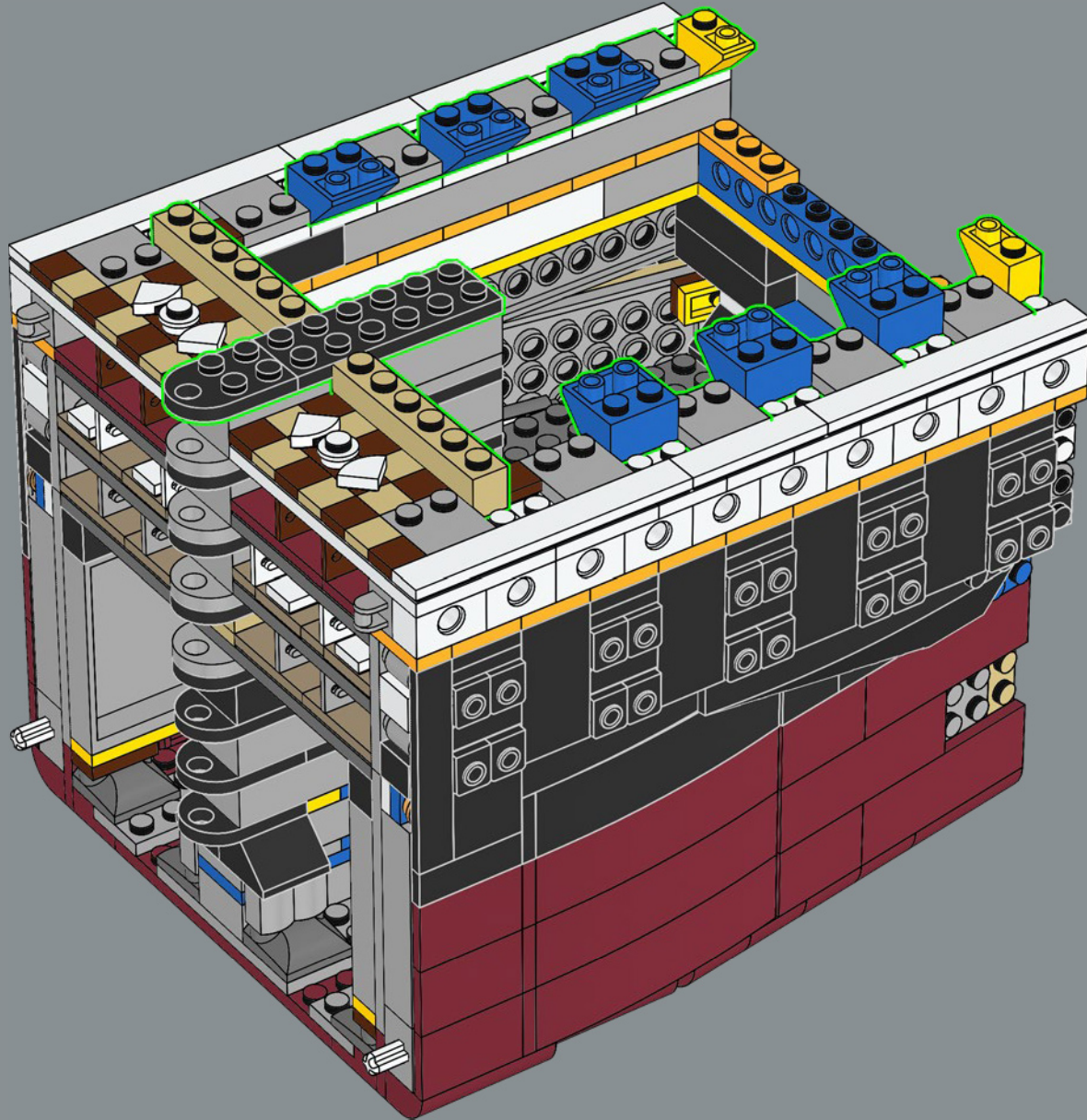

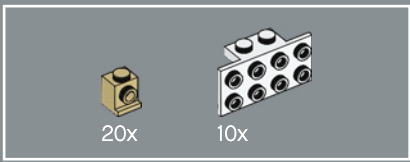

98

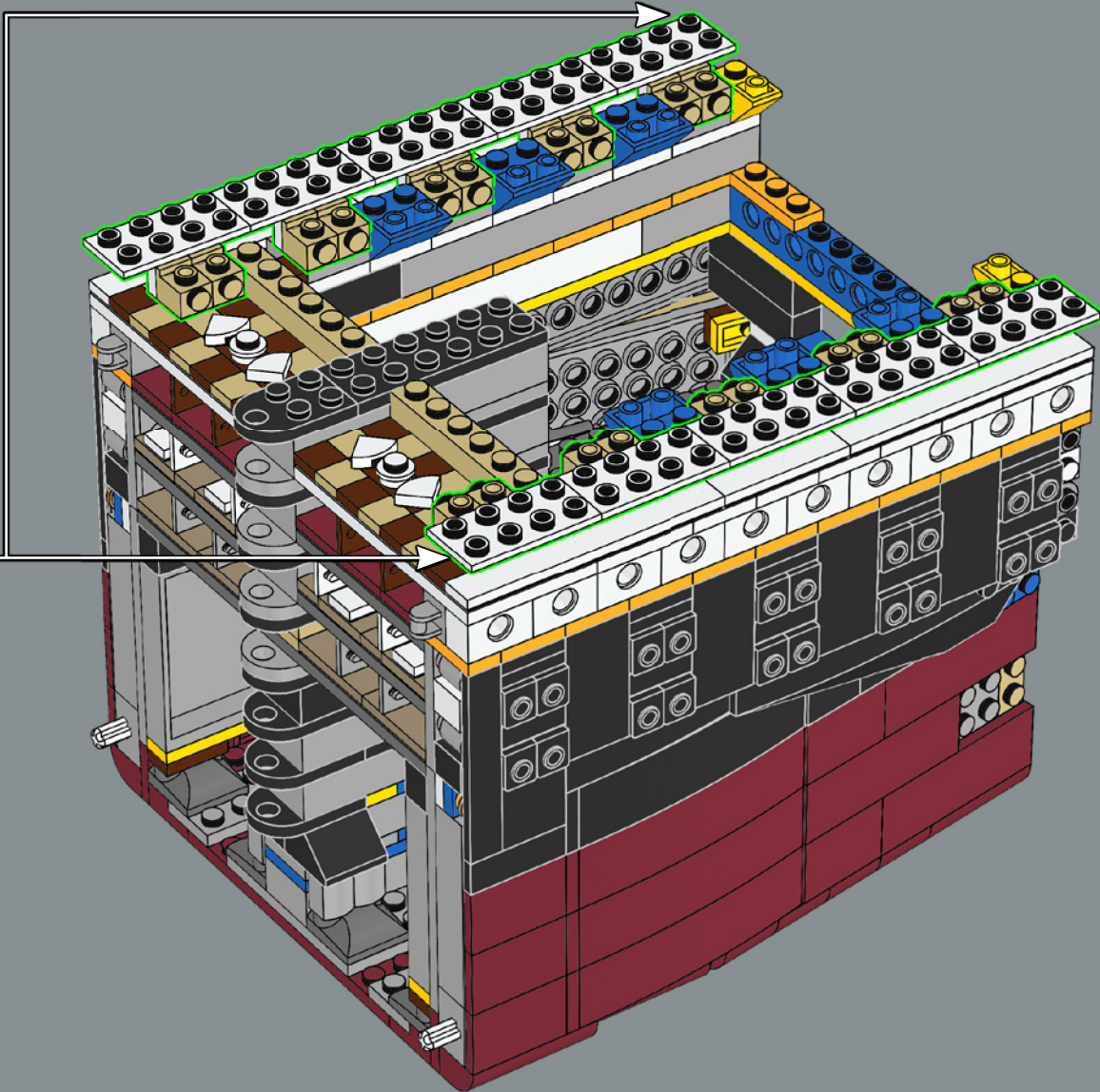
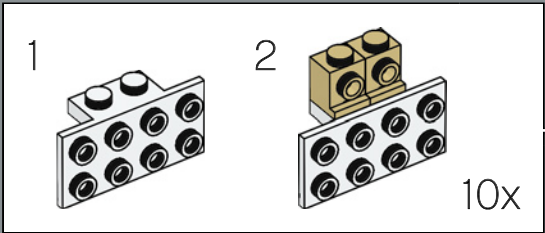

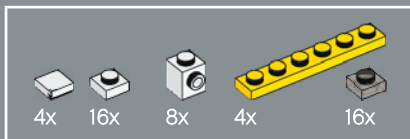

99

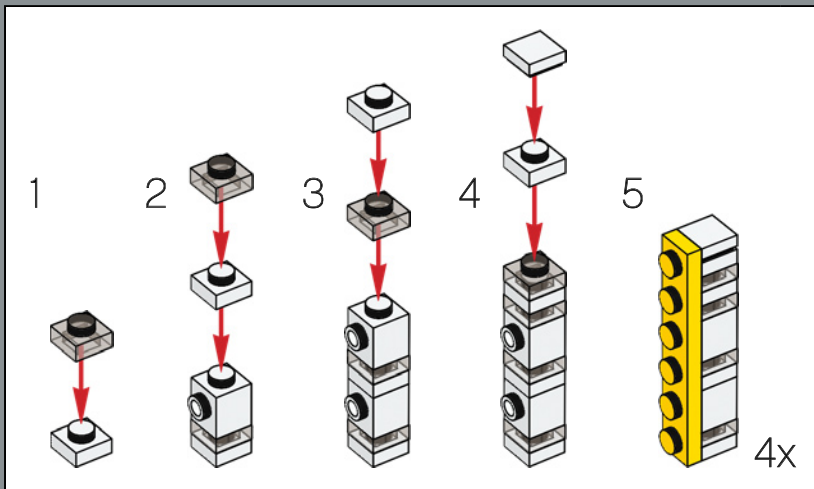
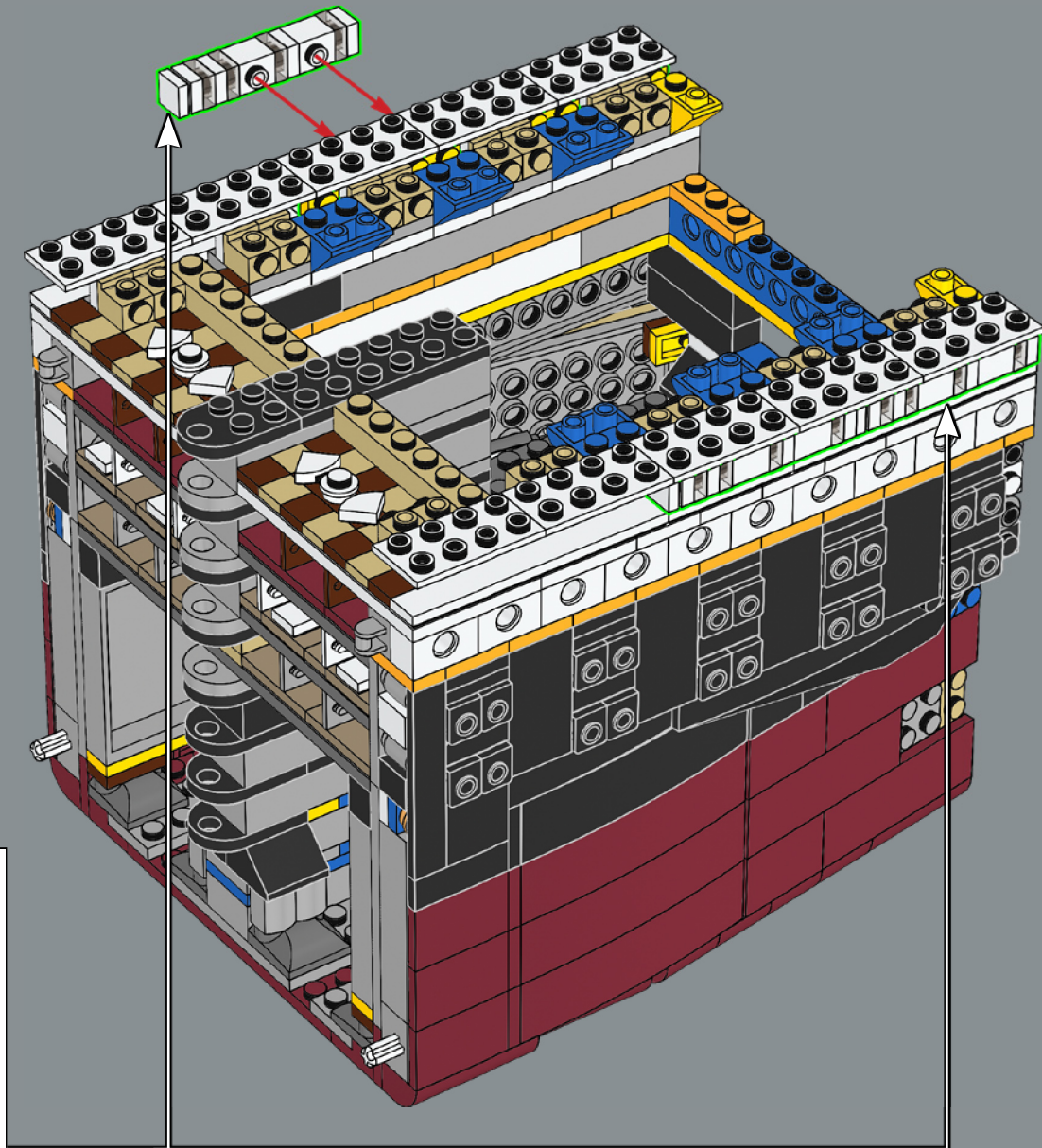

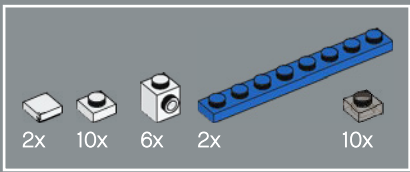

100

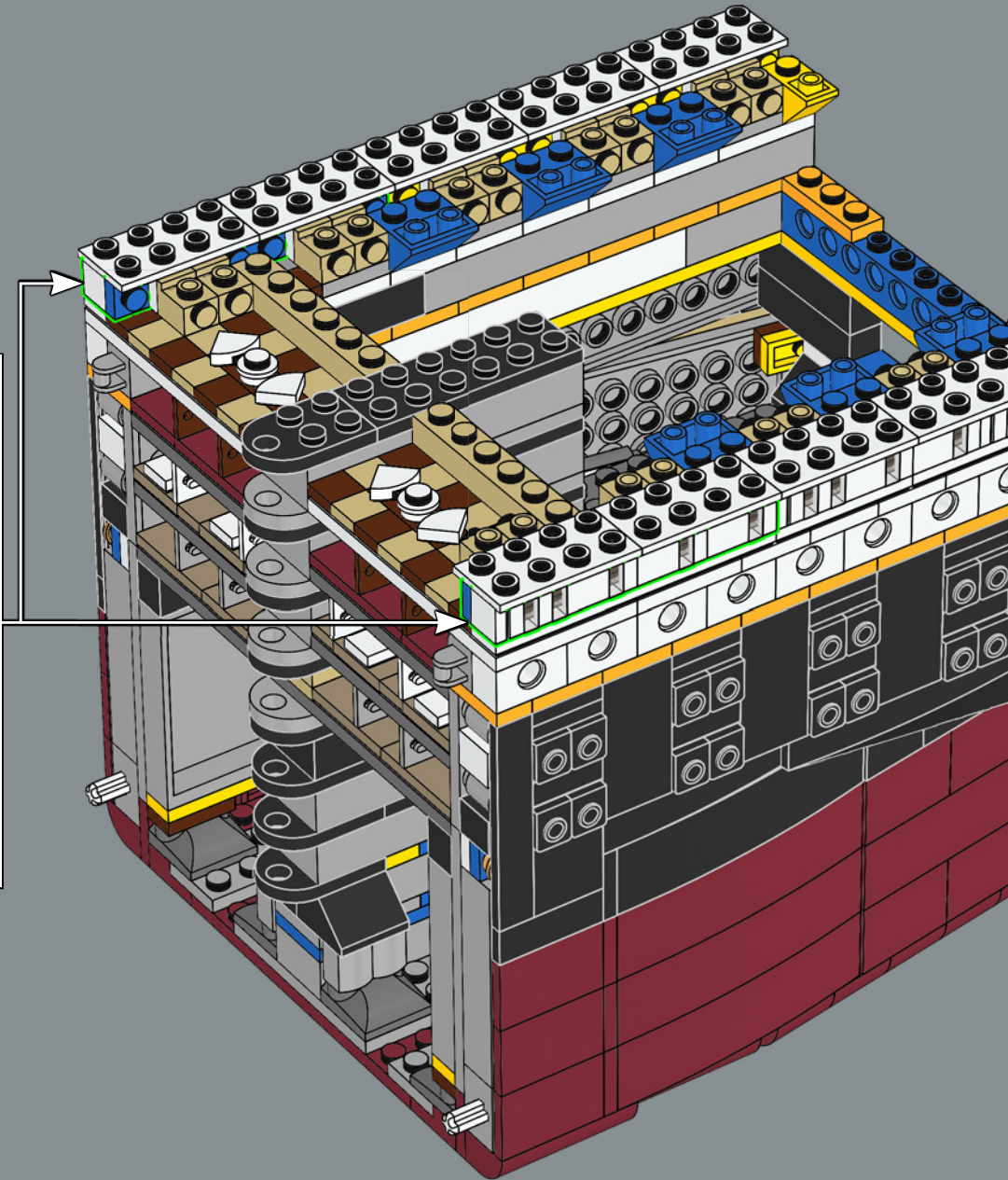
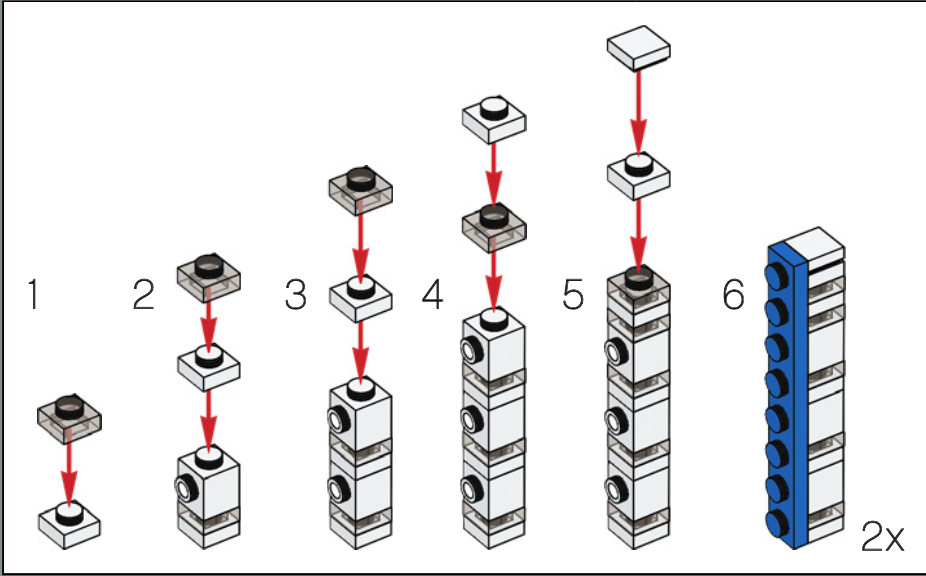

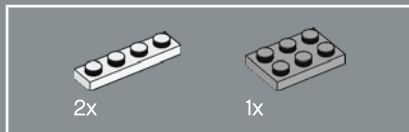
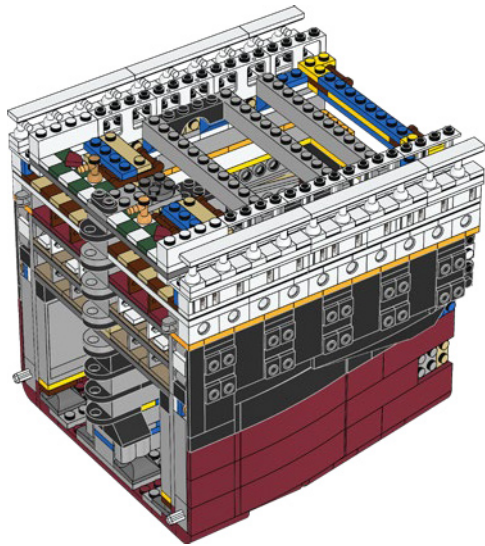
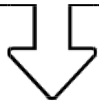

101

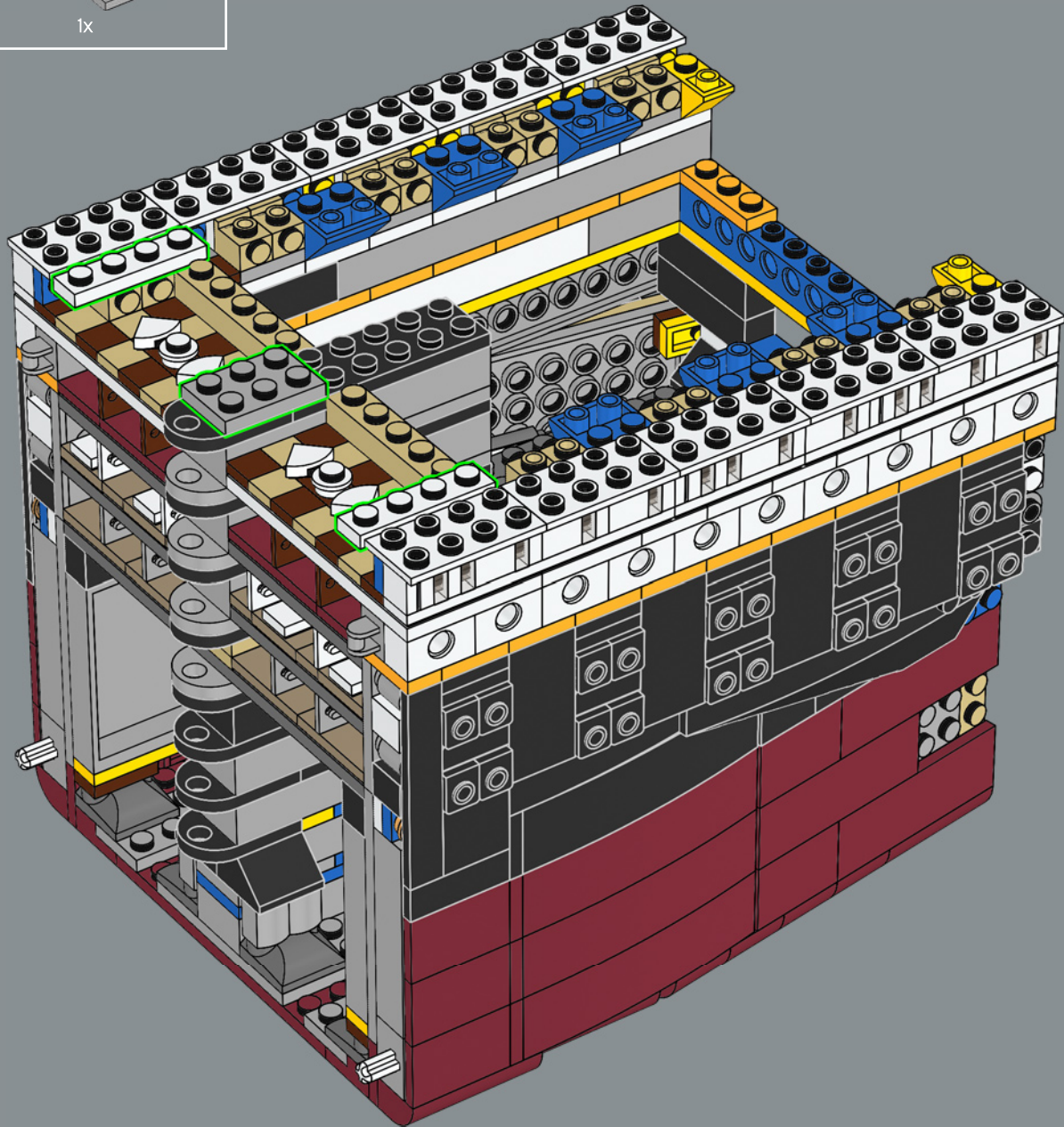

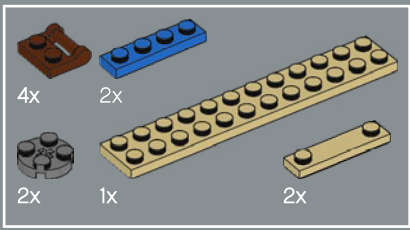

102

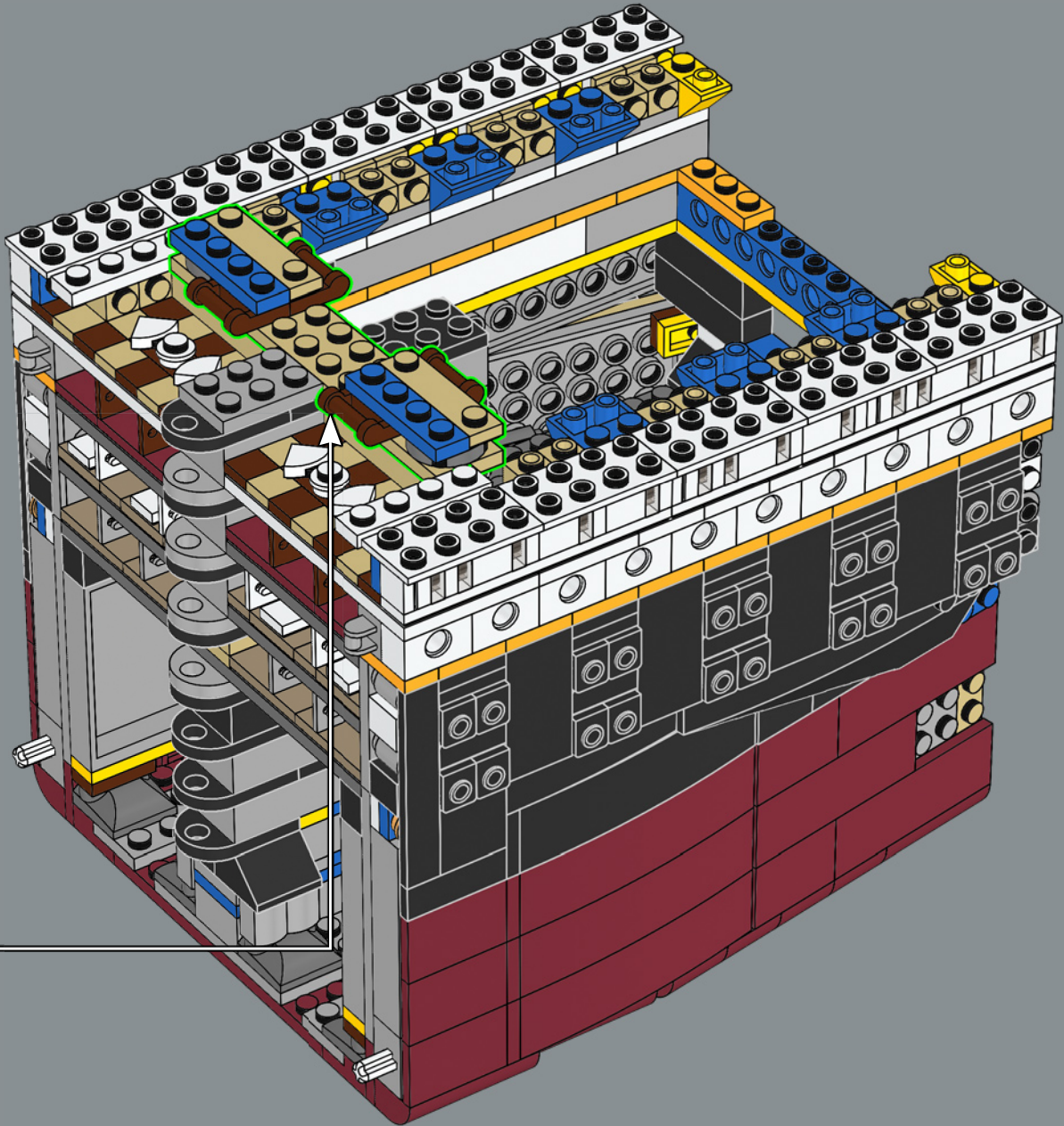
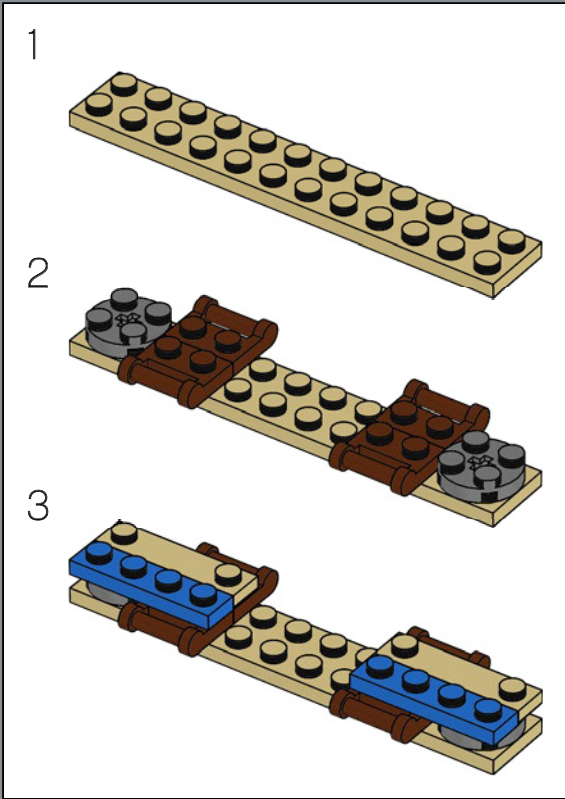

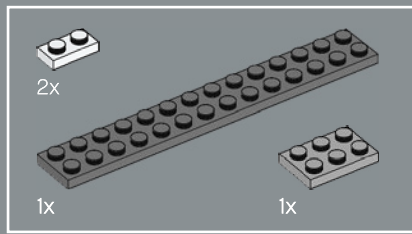

103

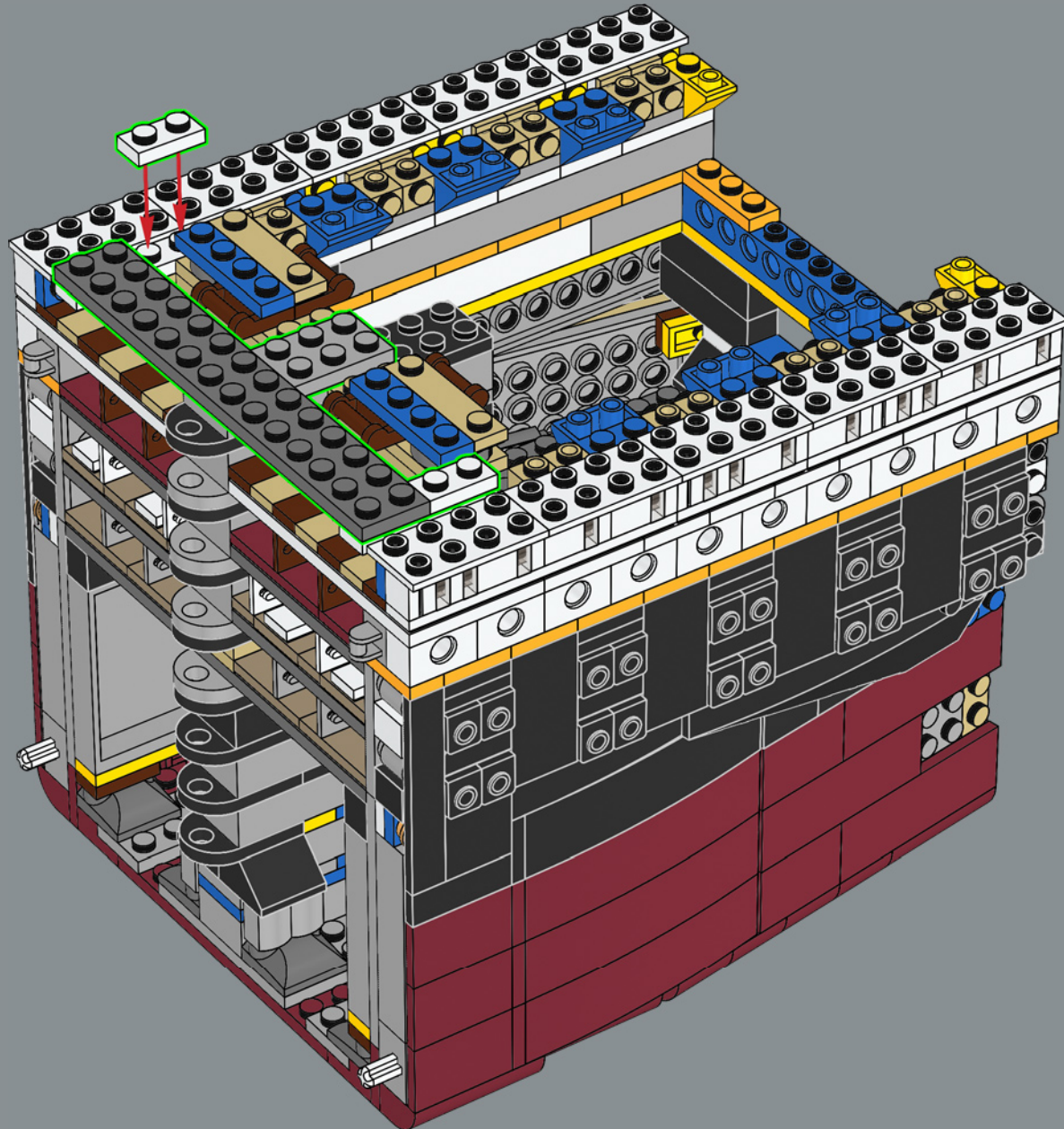

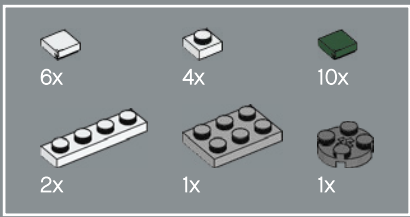

104

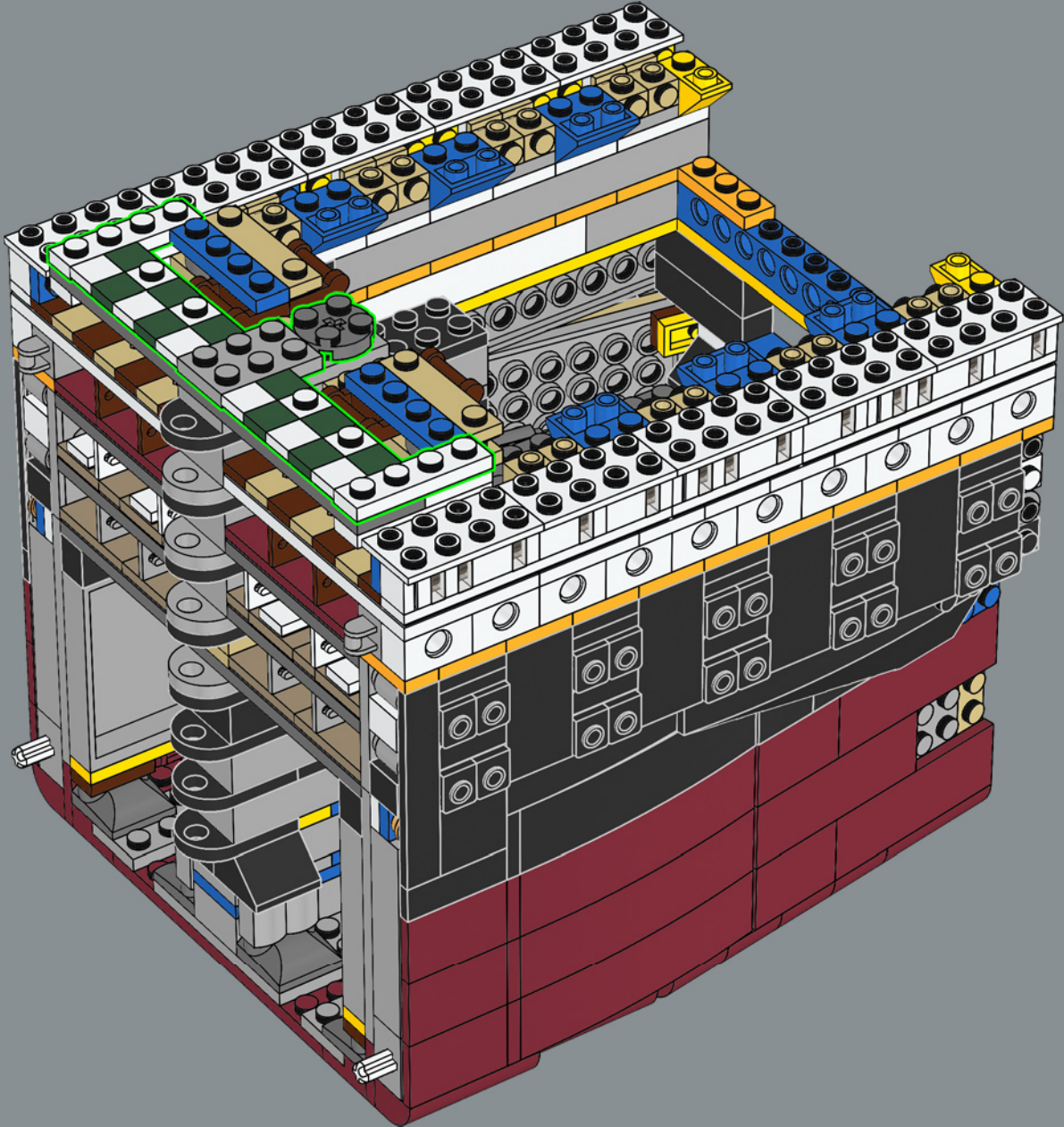



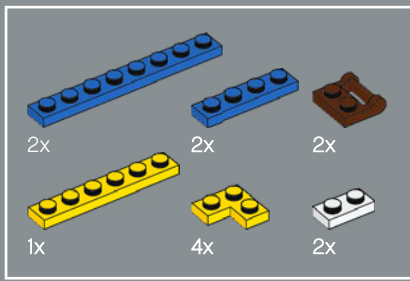

105

1

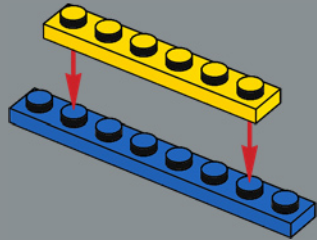

2

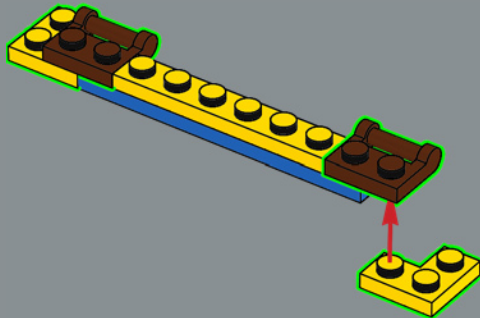

3

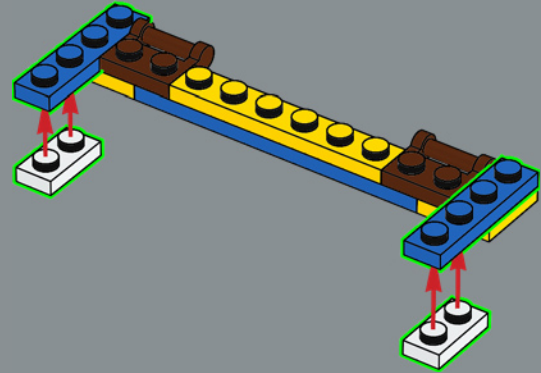

4

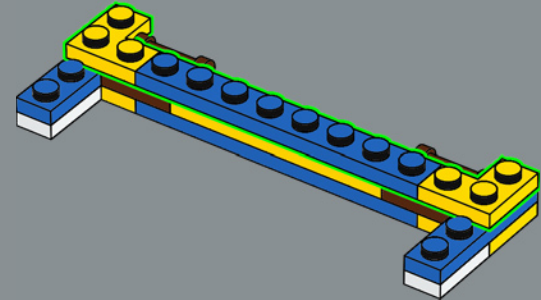

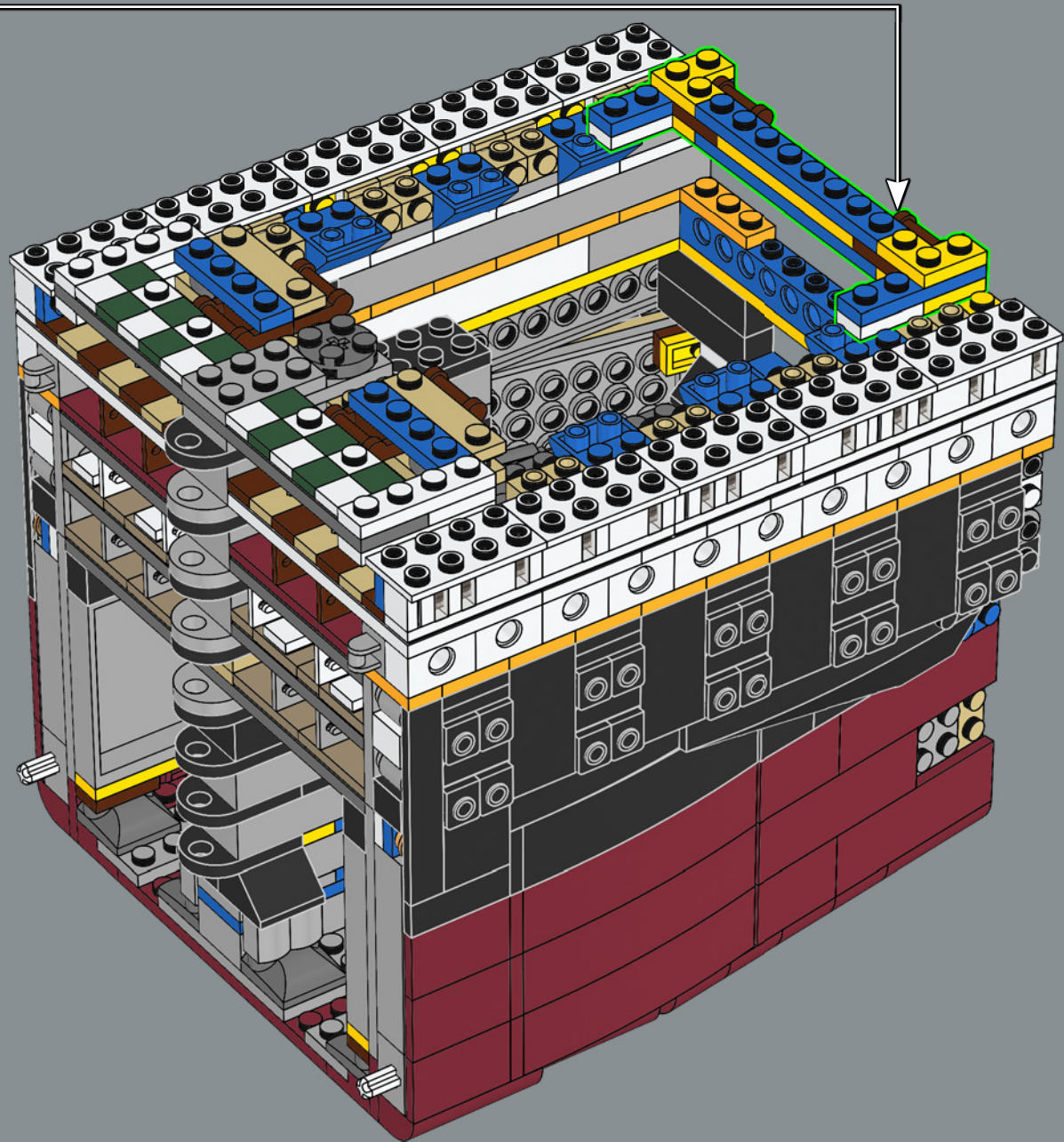

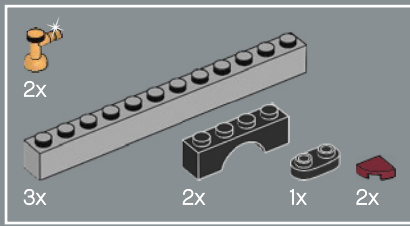

106

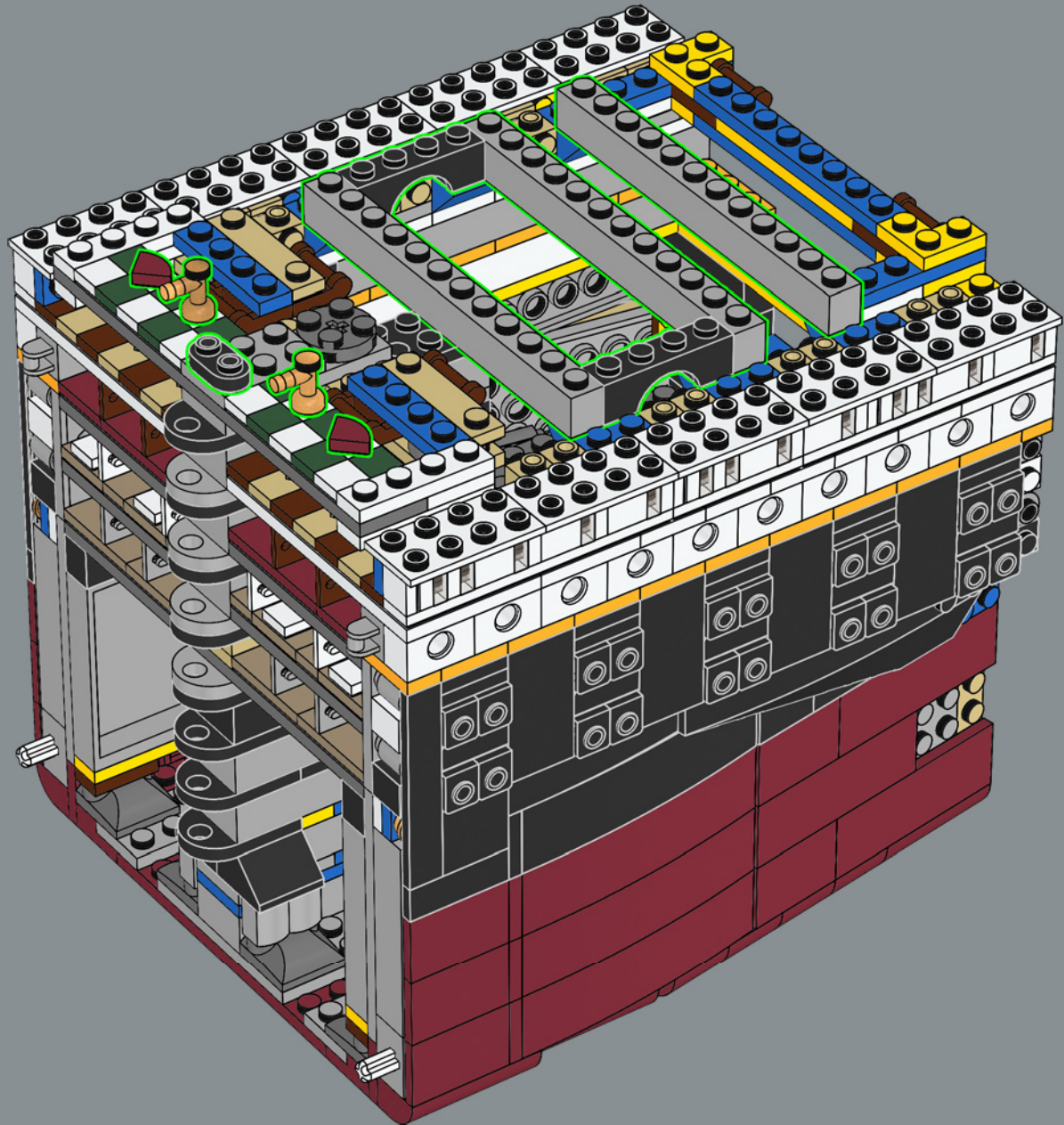

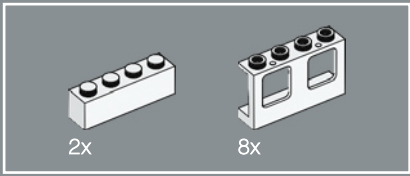

107

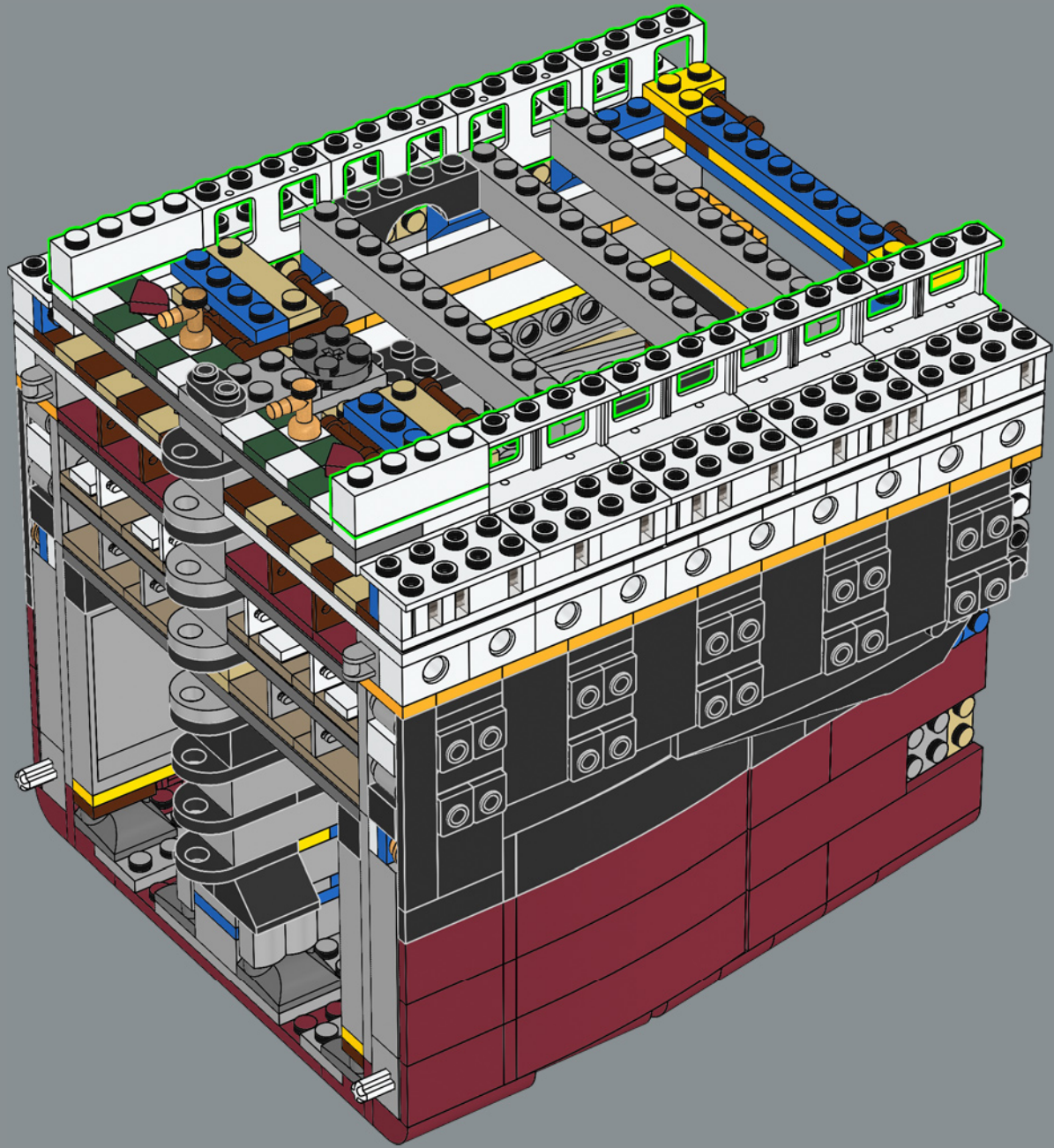

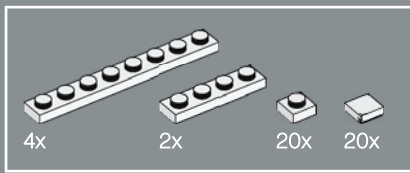

108

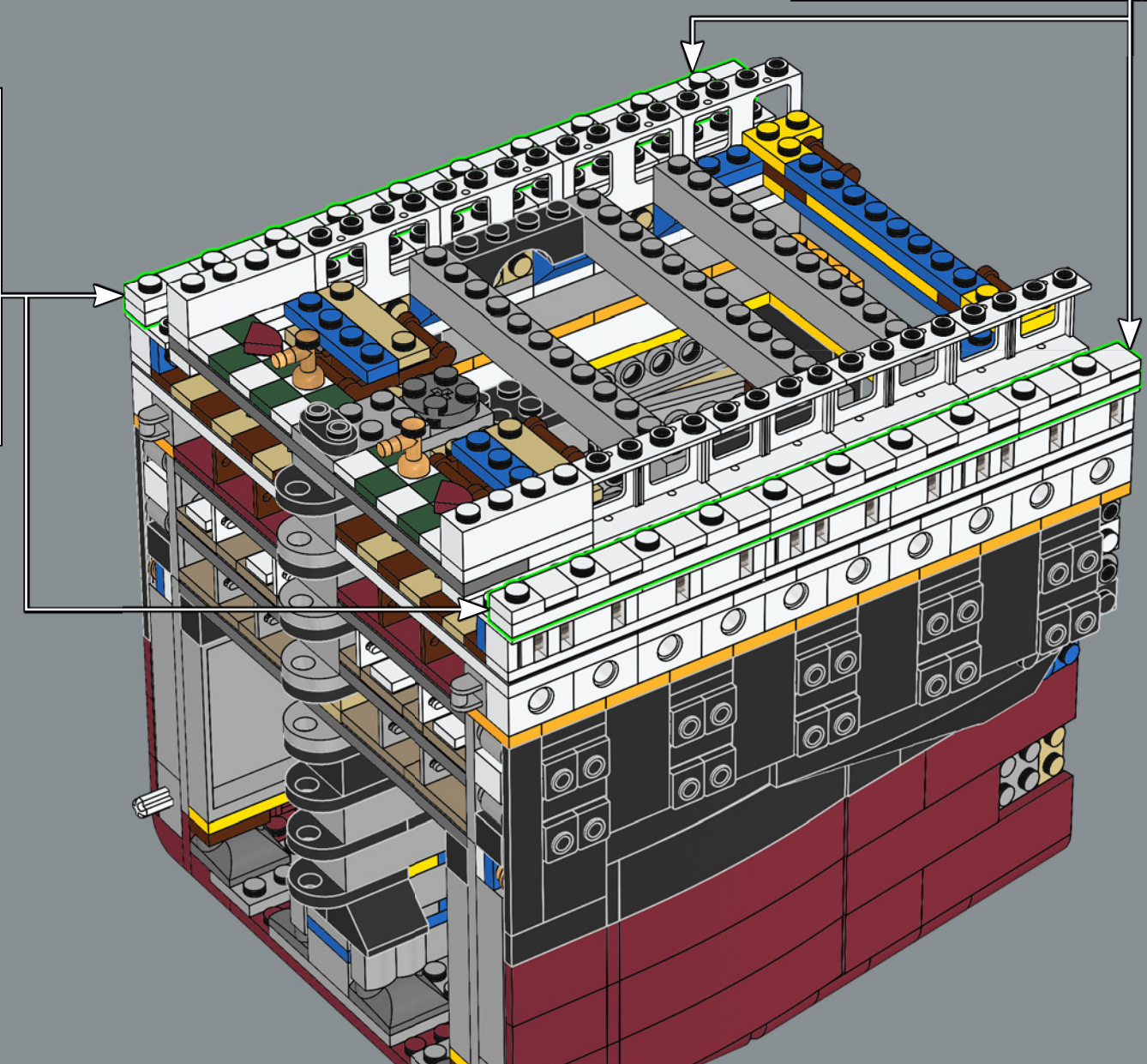
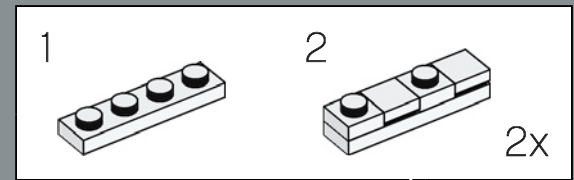
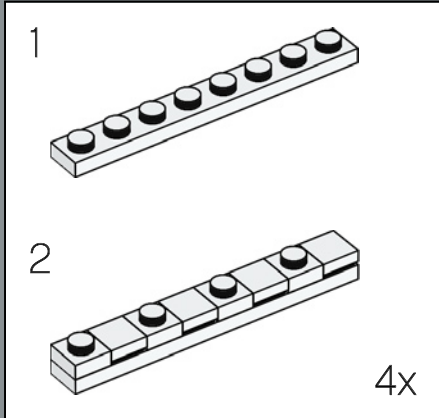



20x

109

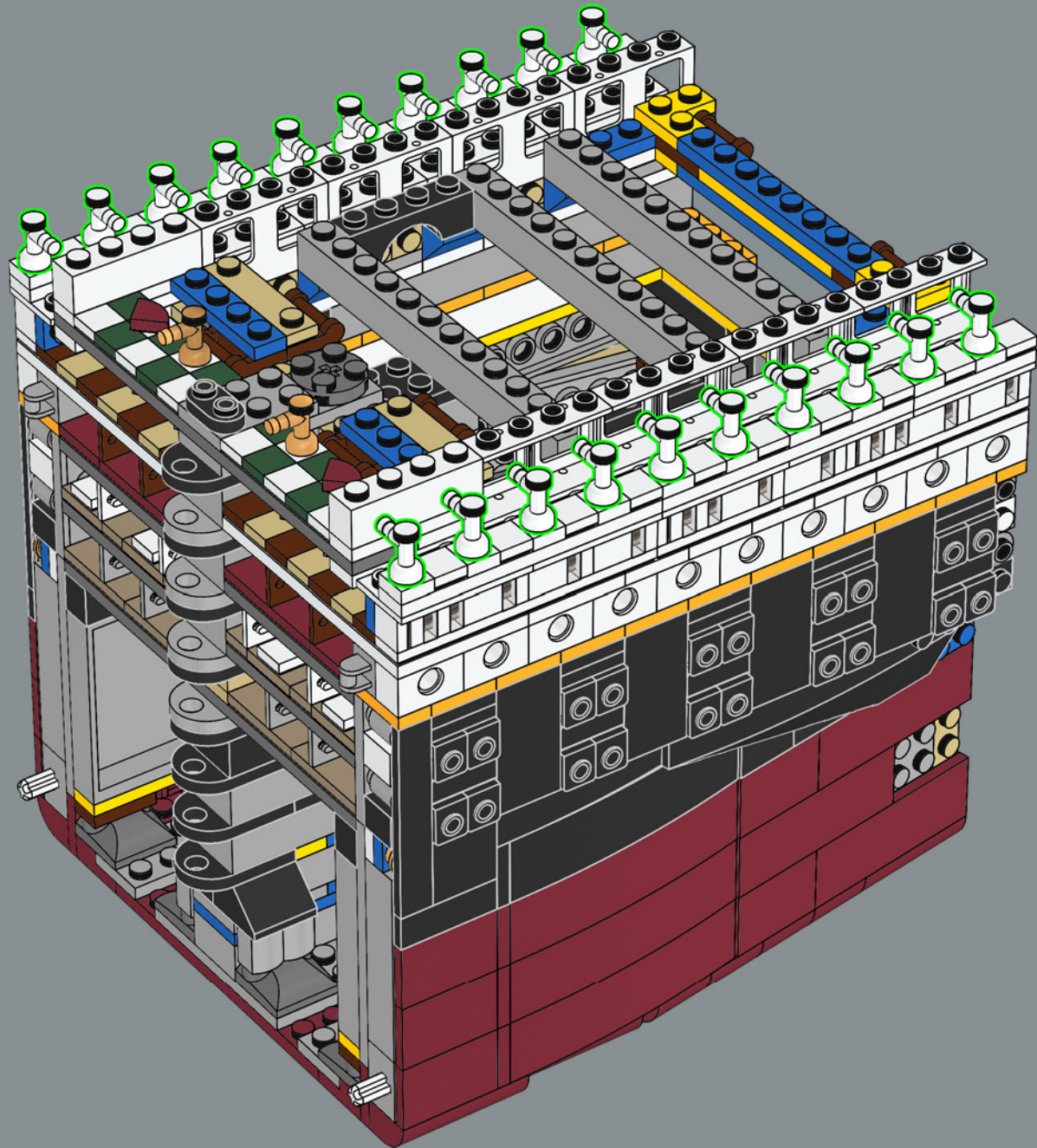

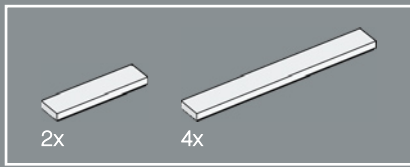

110

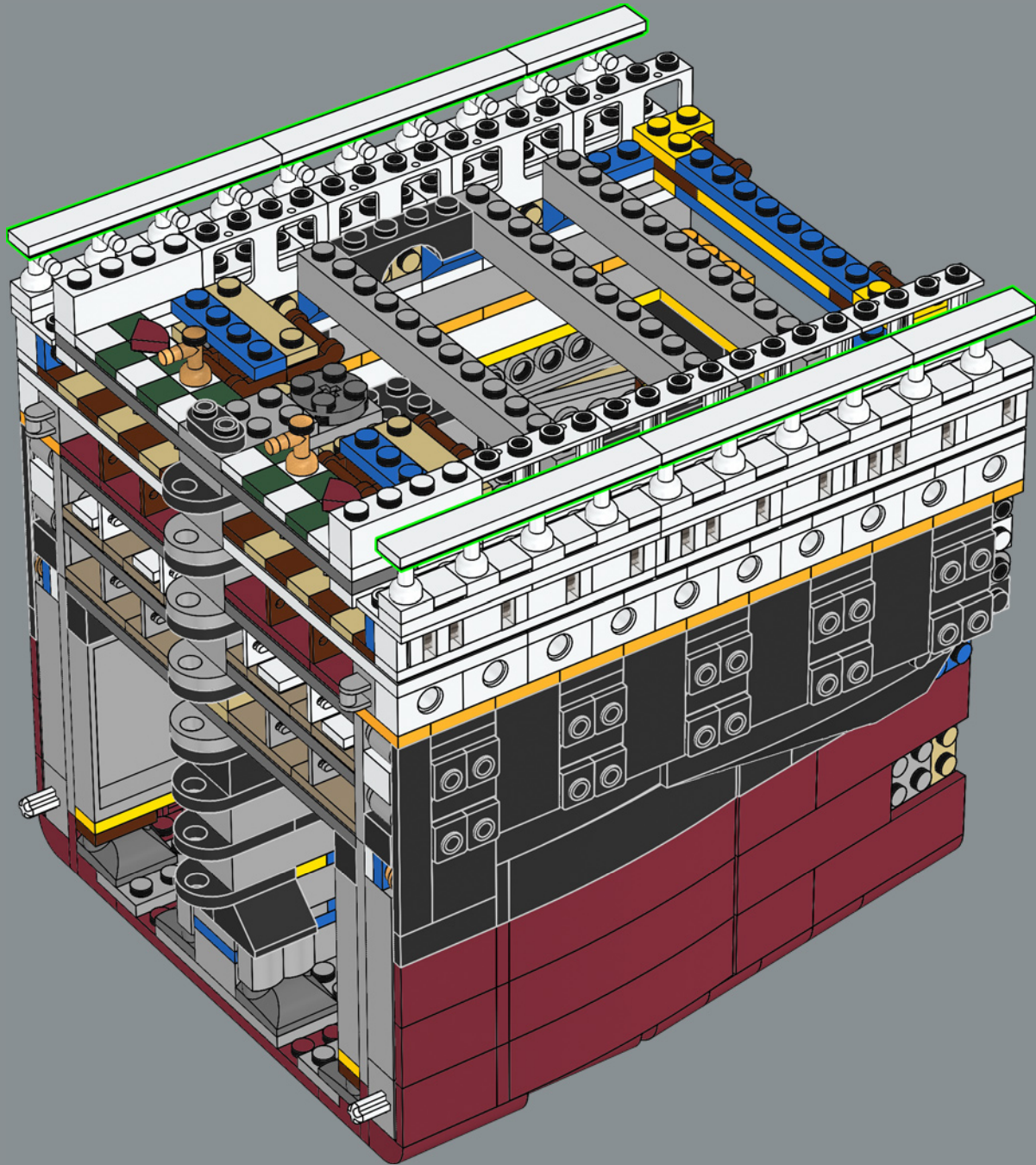

34

2x

4x

2x

111

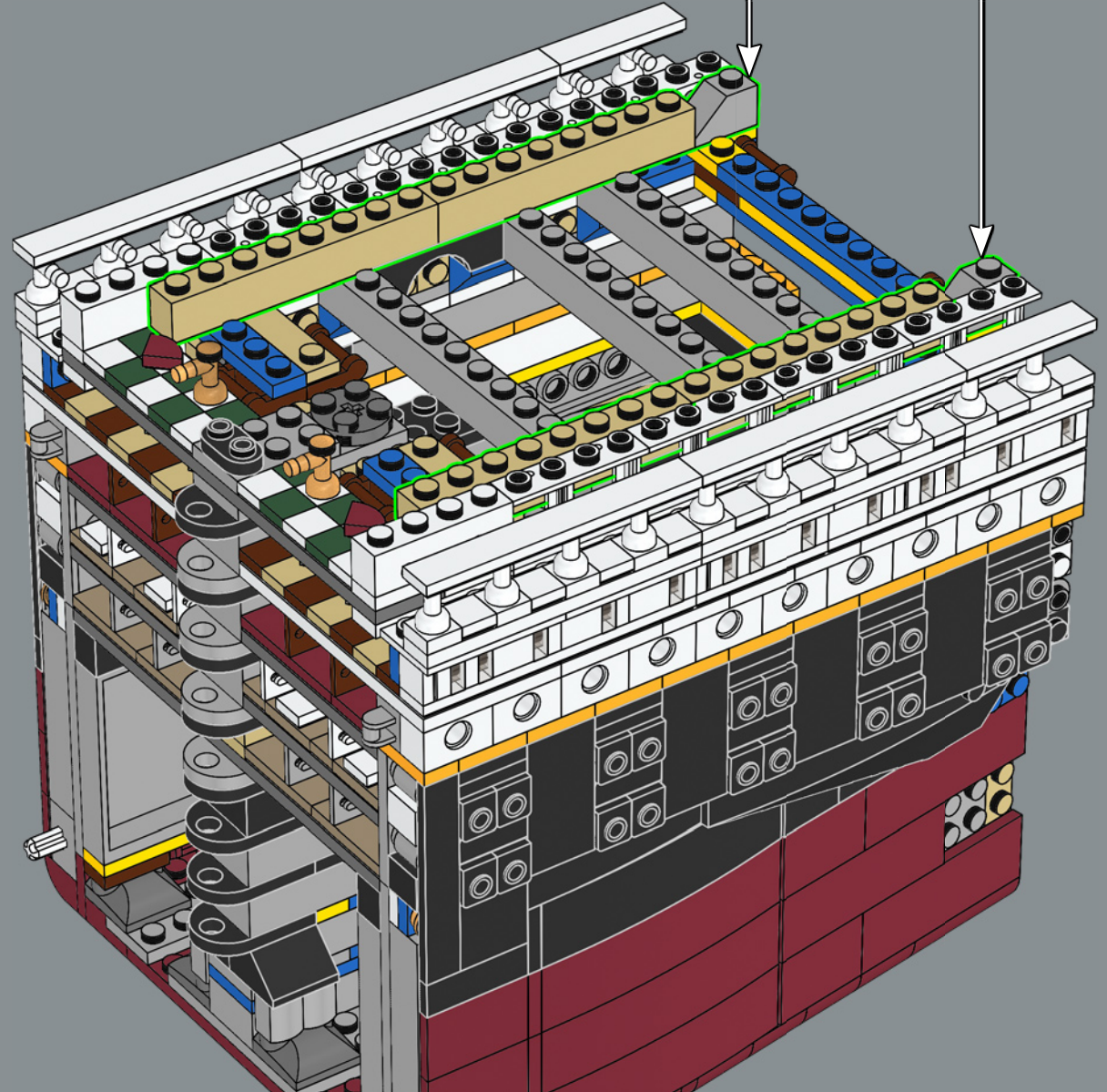



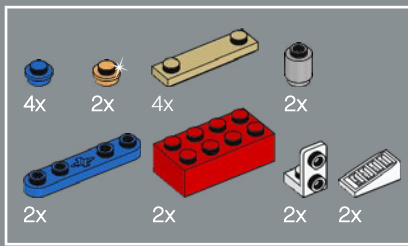

112

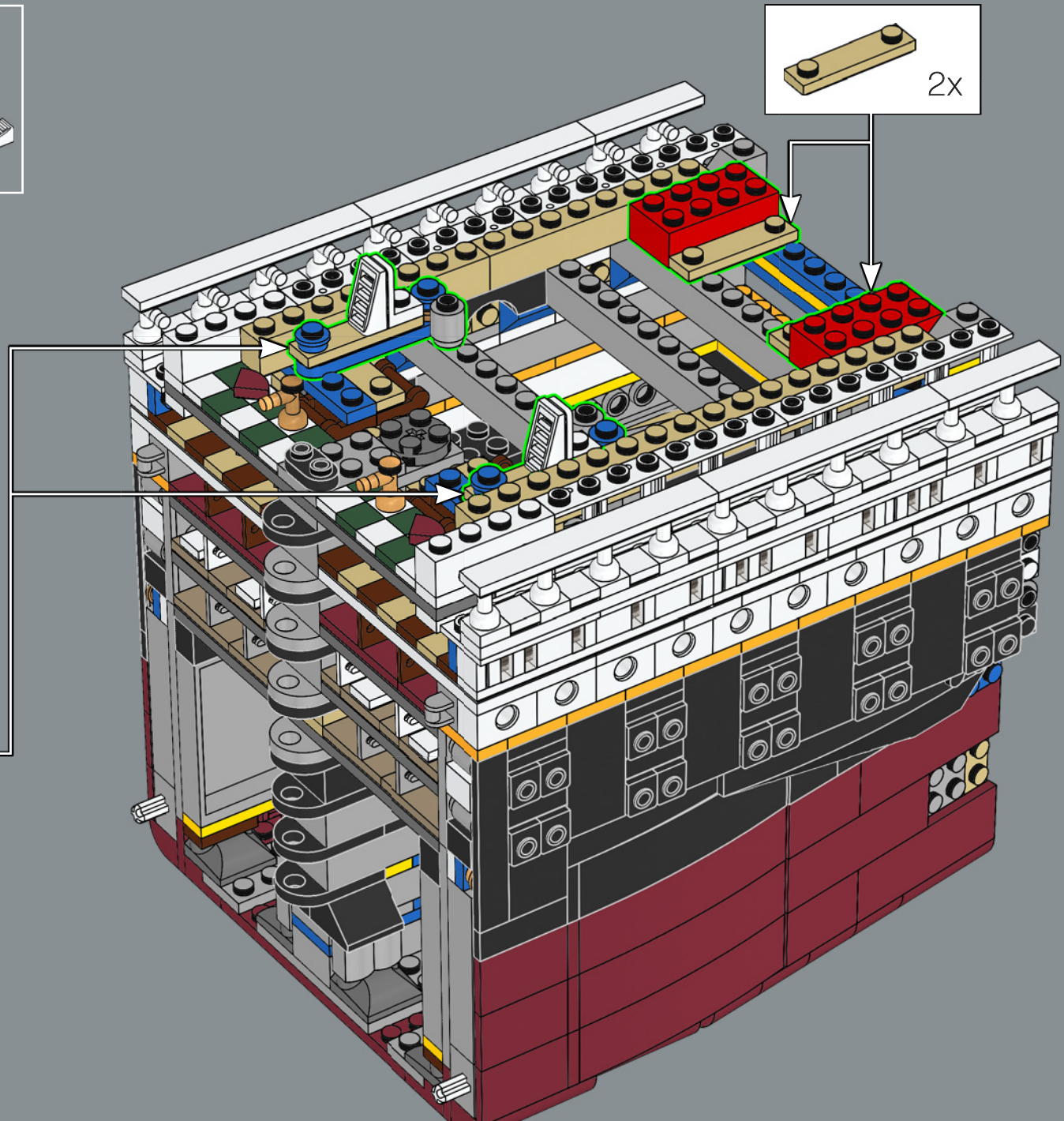
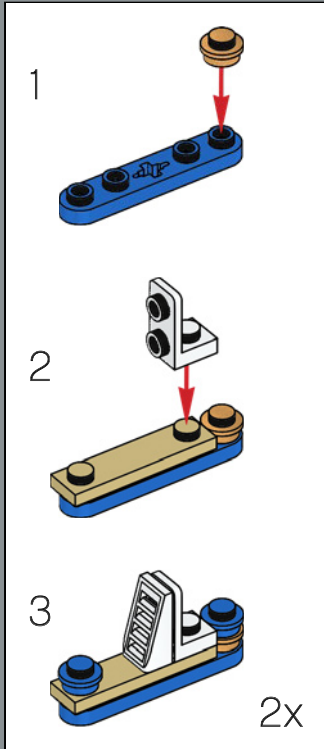

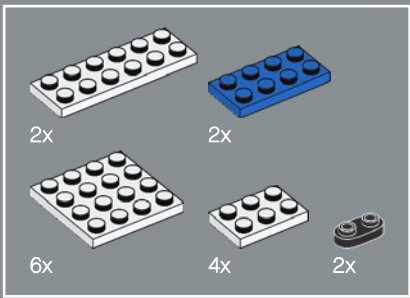

113

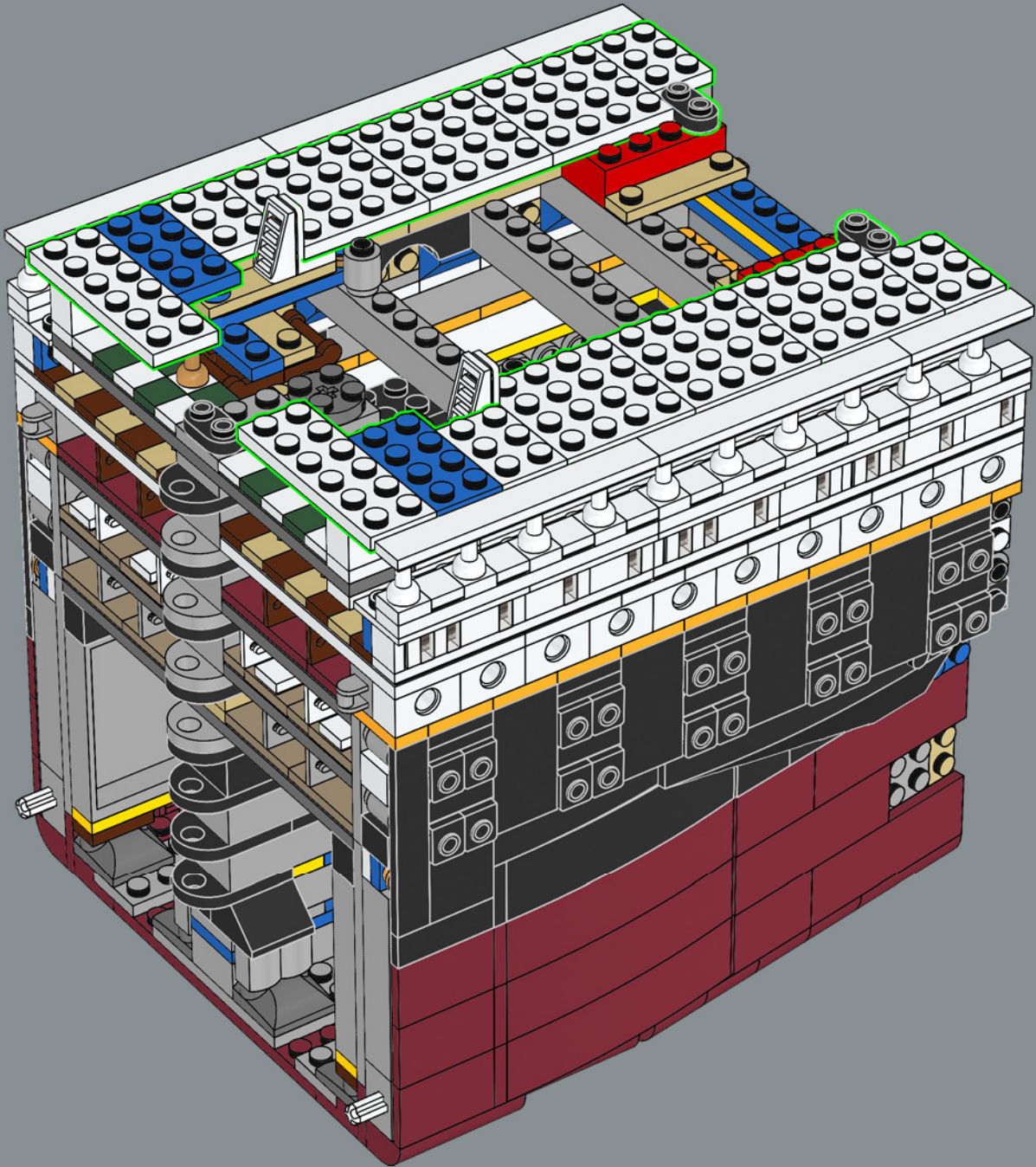

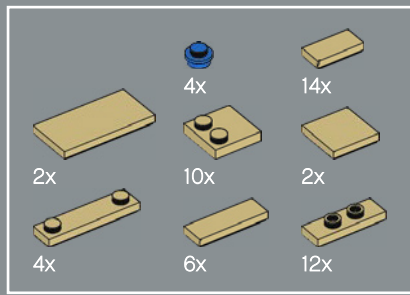

114

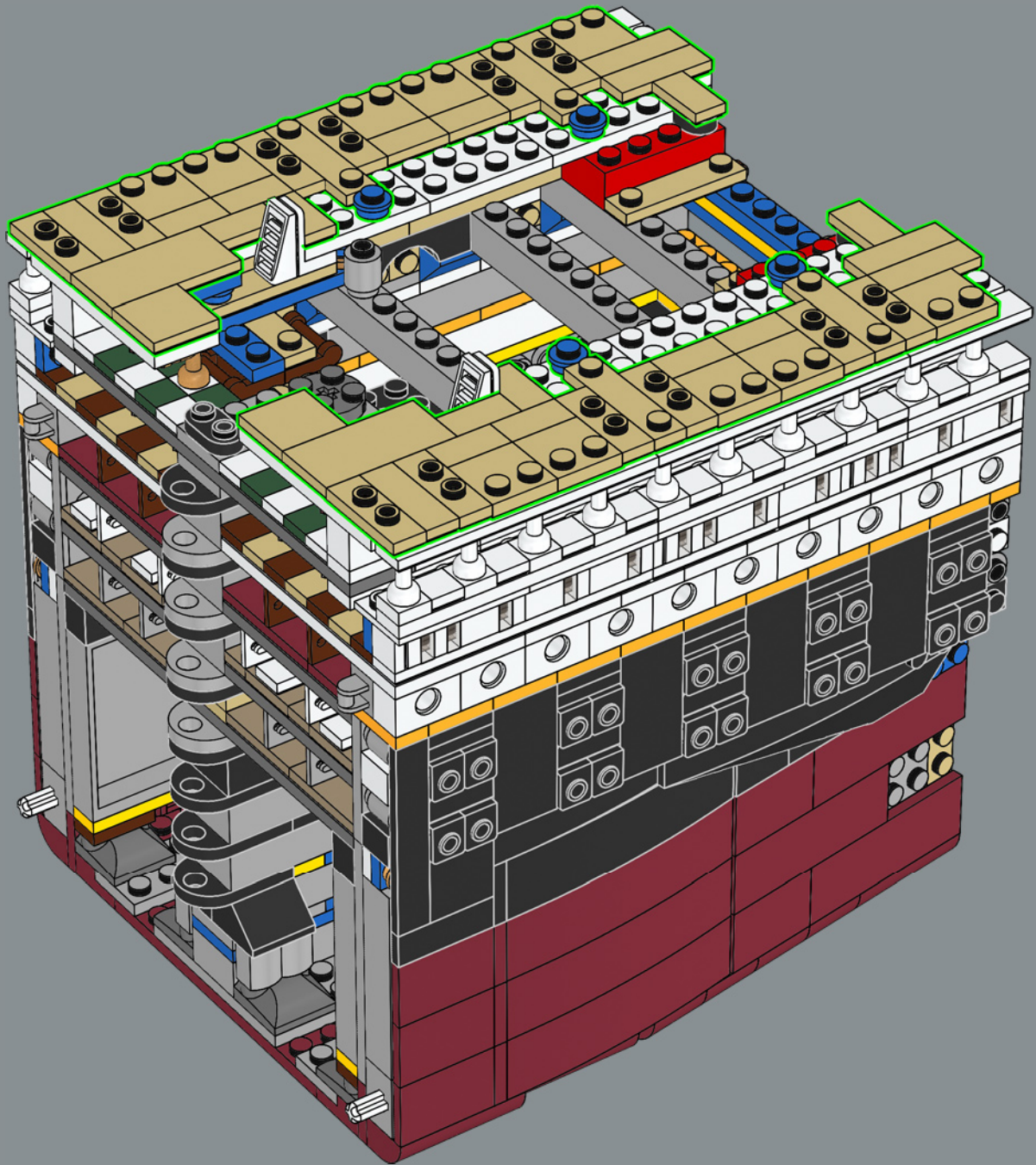

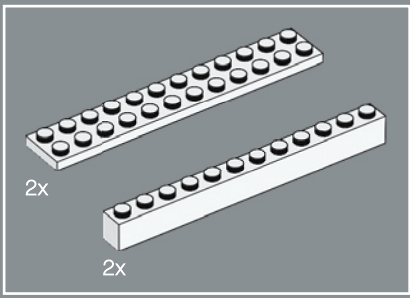

115

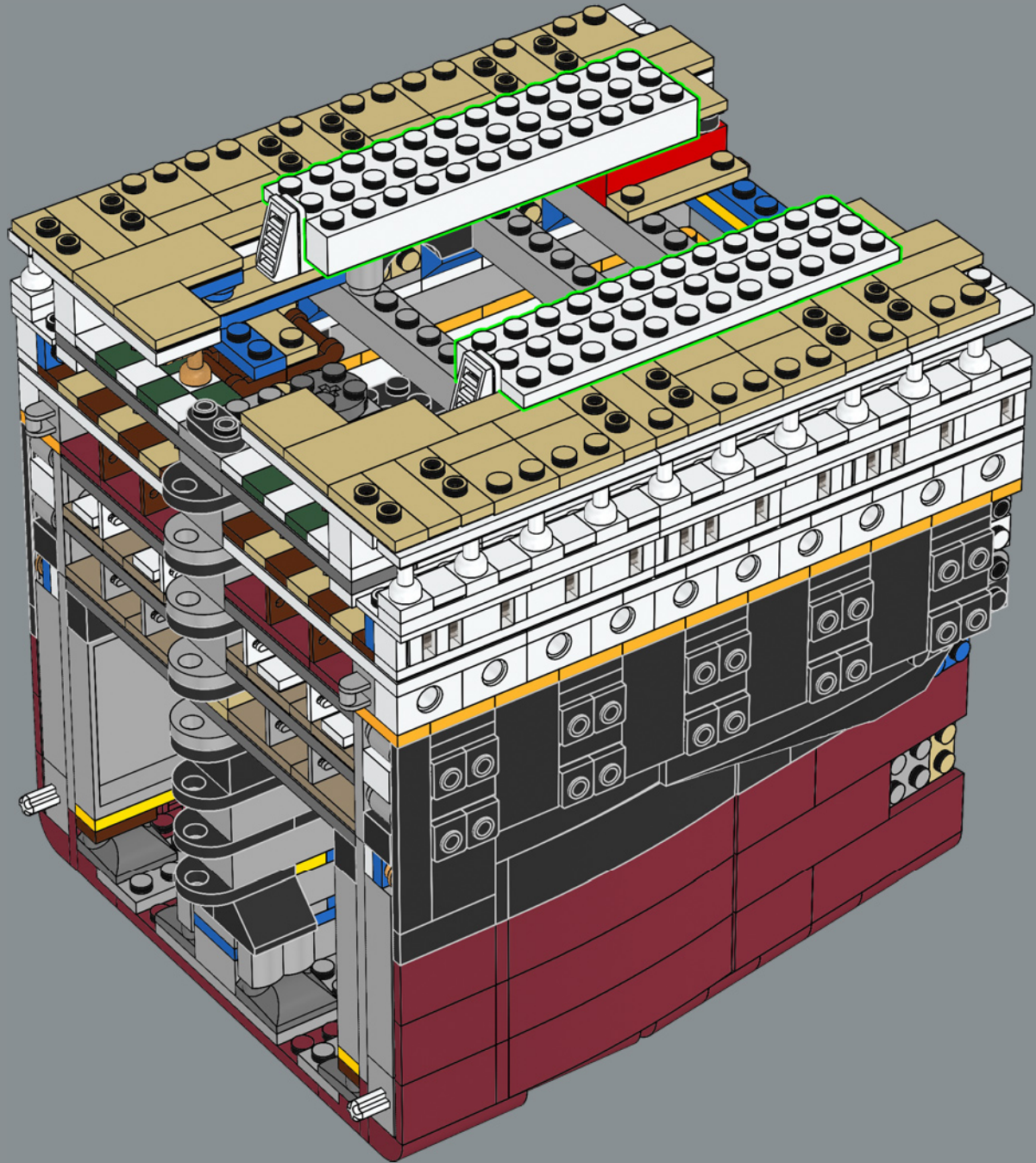

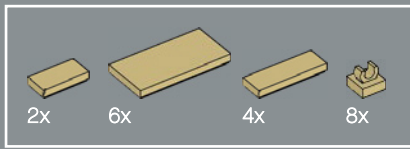

116

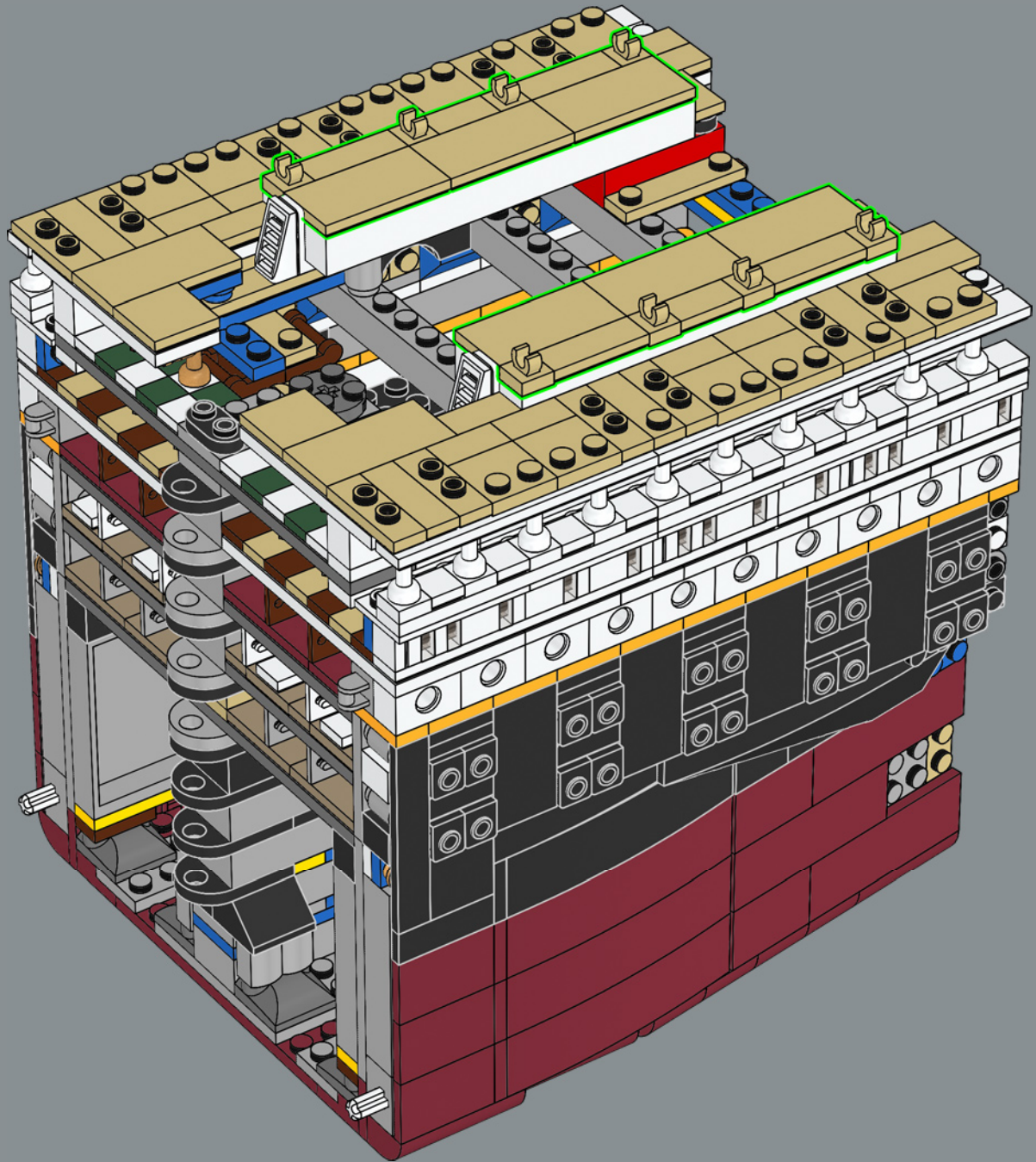

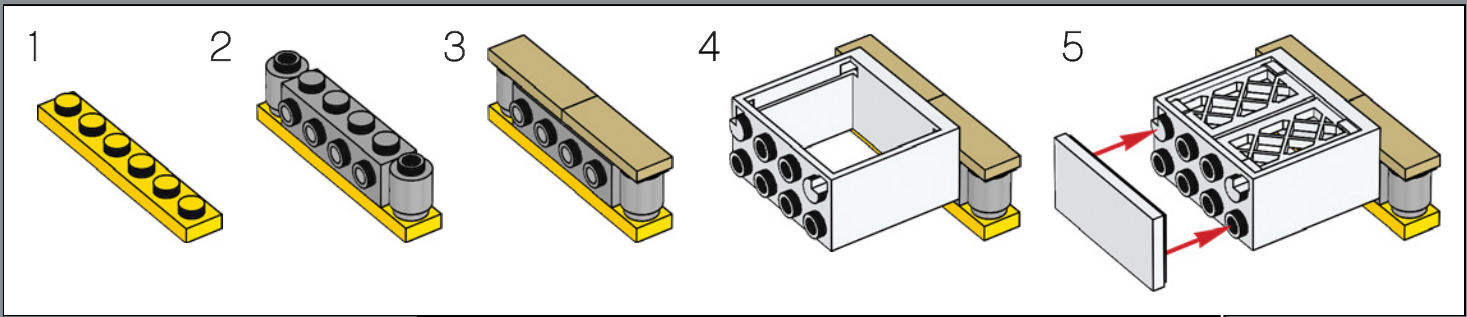
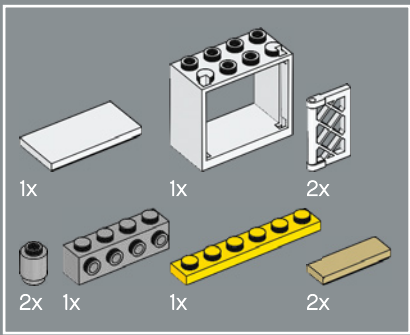

117

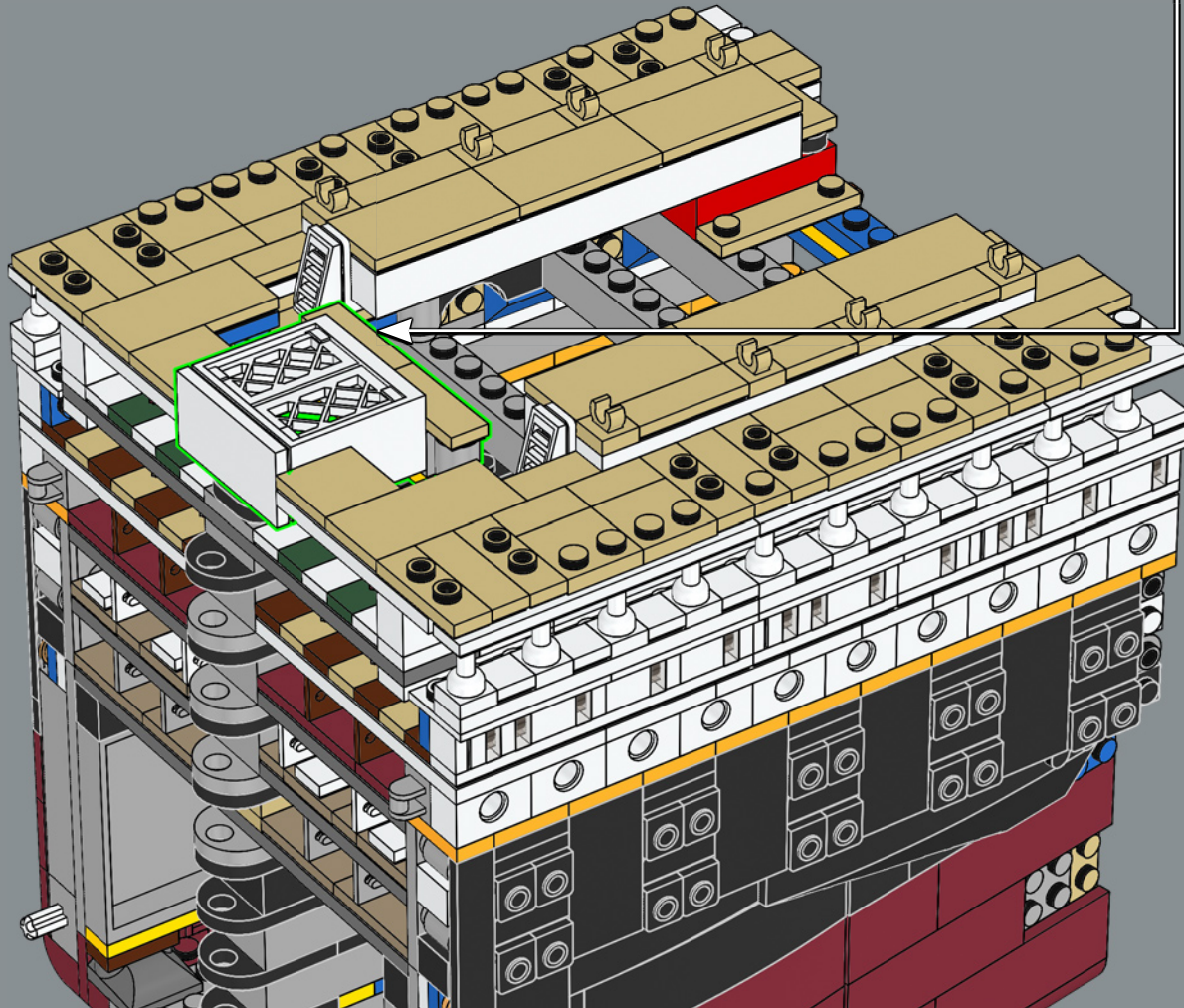

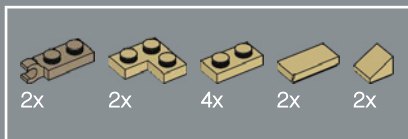

118

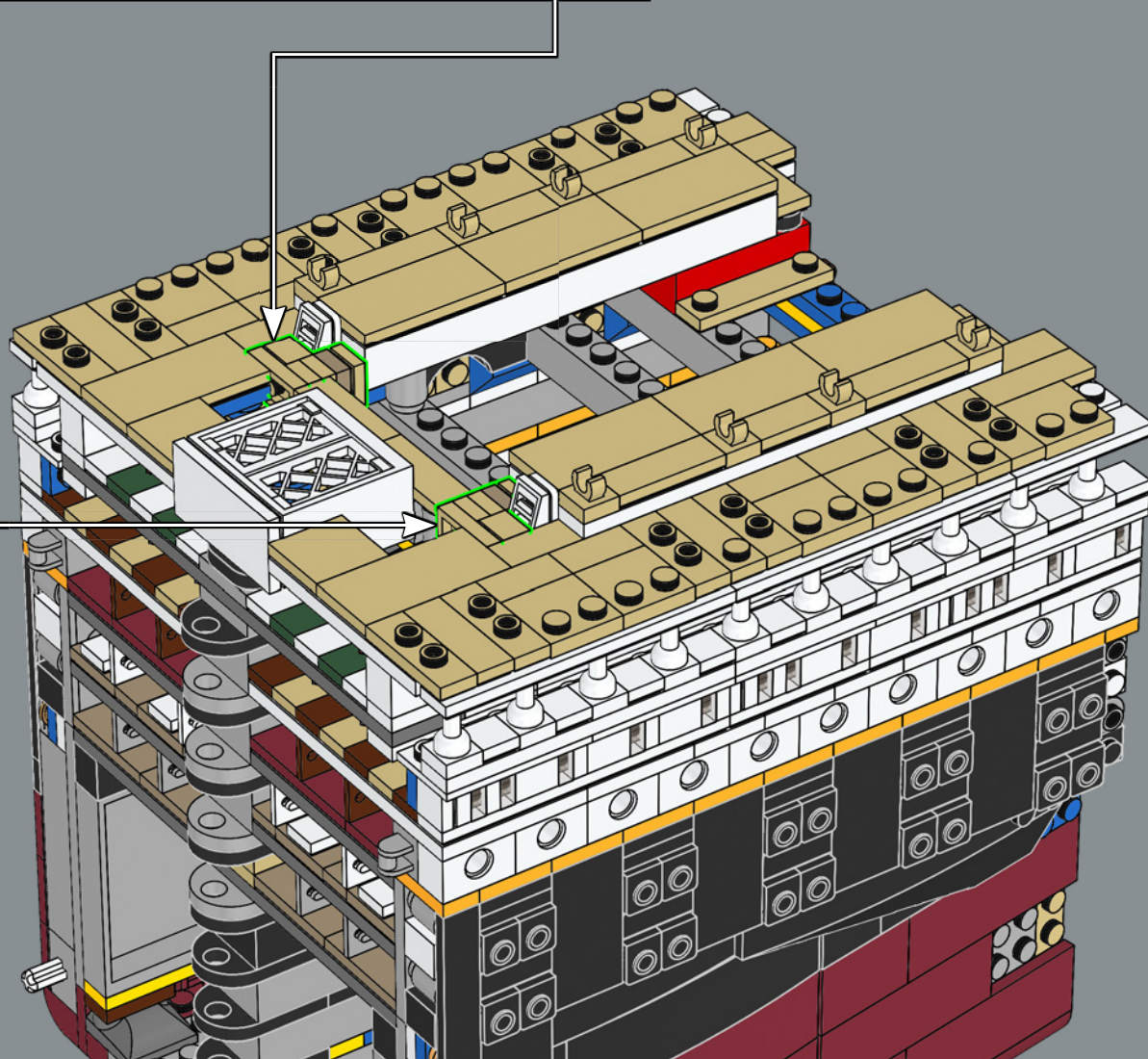
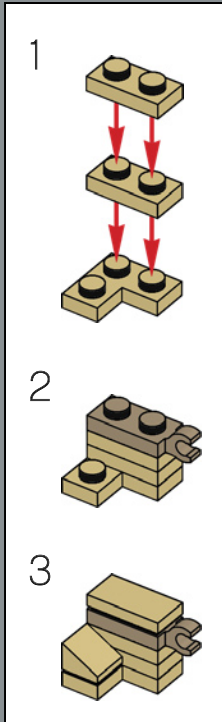
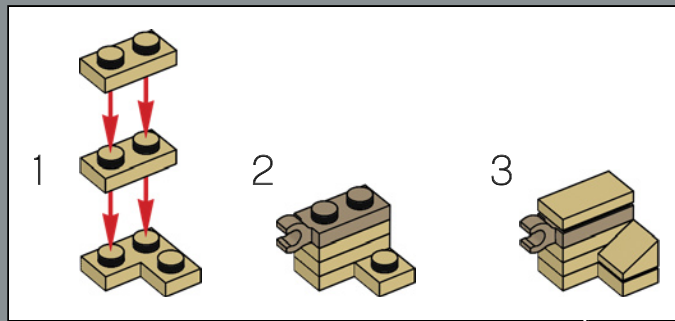

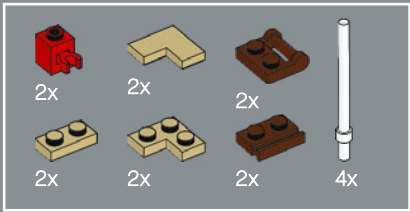

119

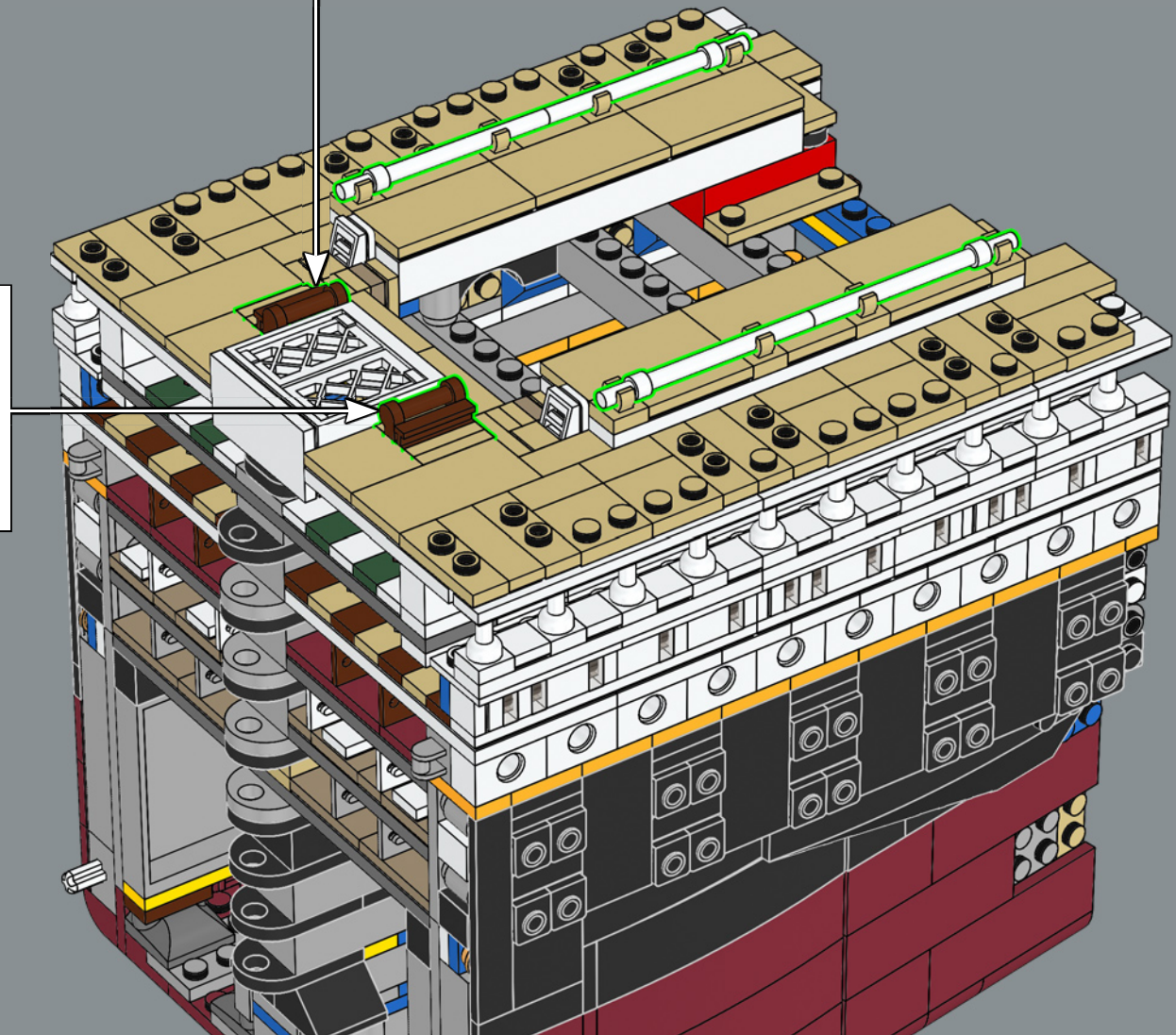
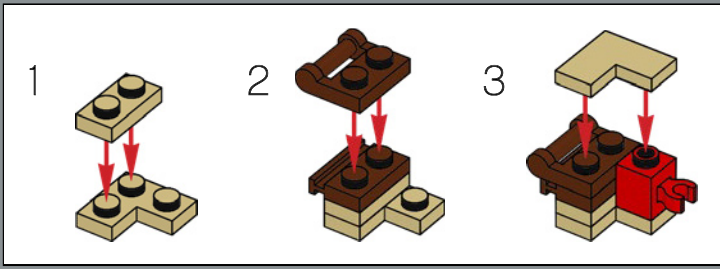
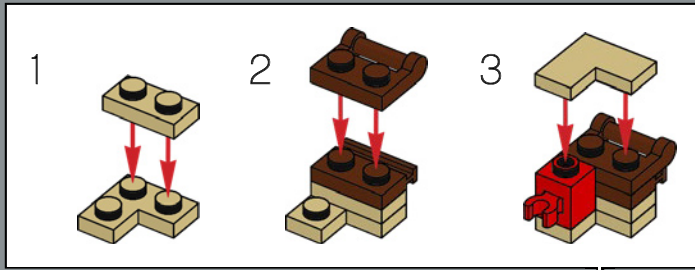



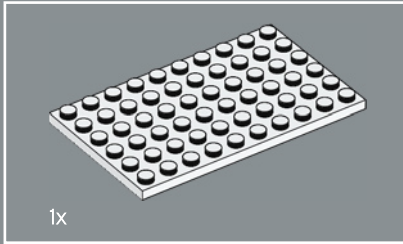
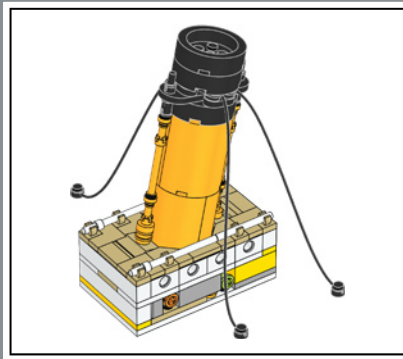
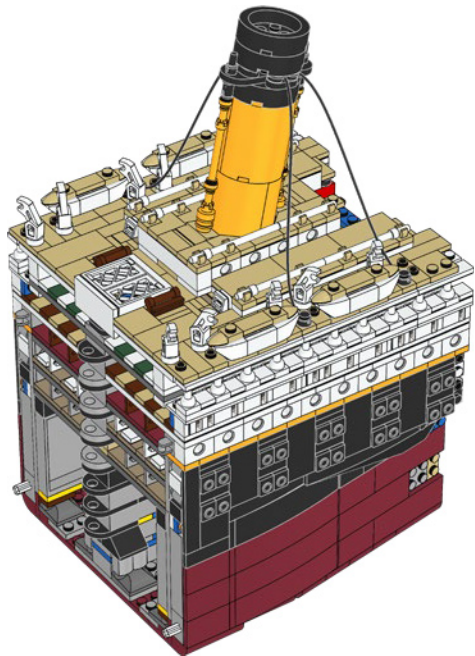
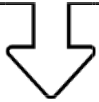

120

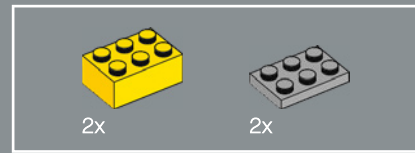
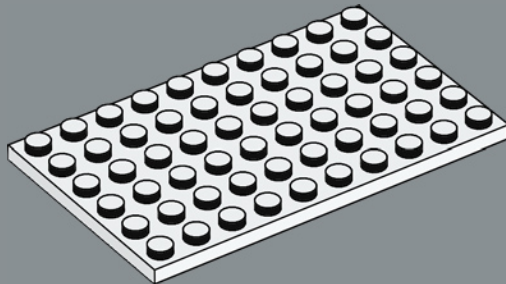

121

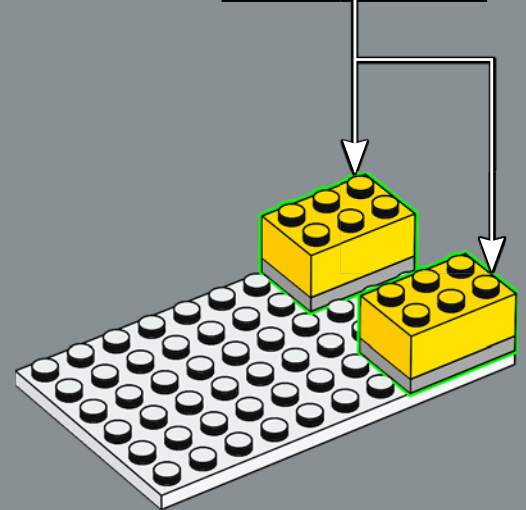
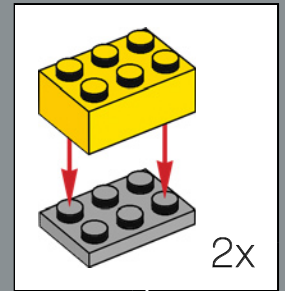

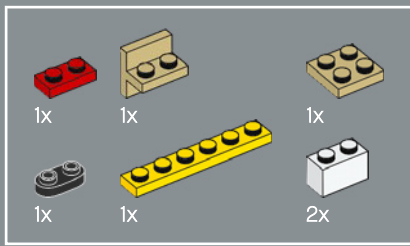

122

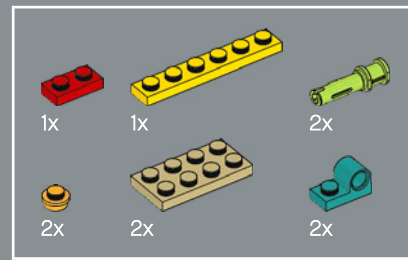
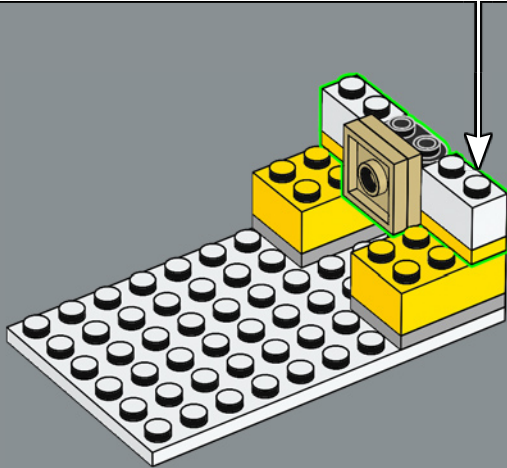
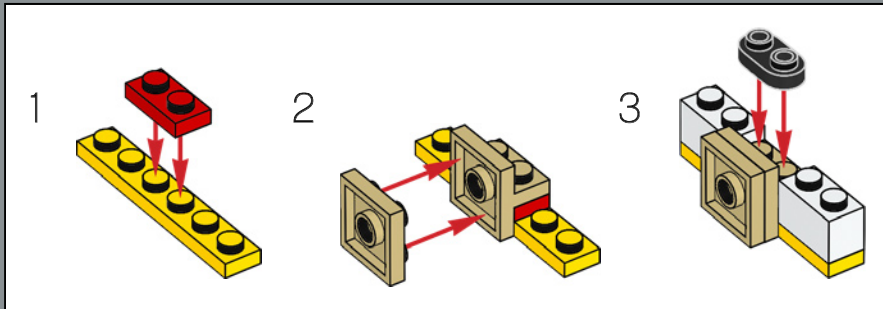

123

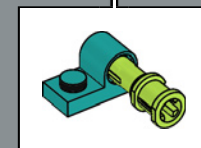
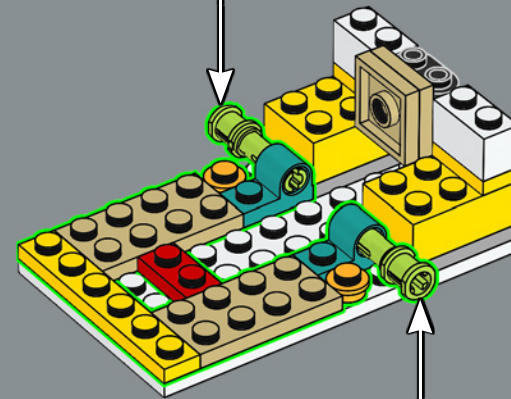
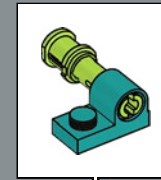

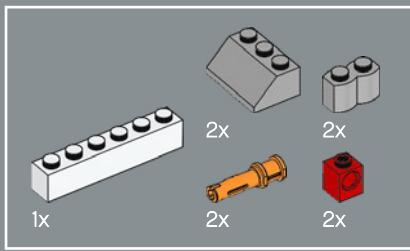

124

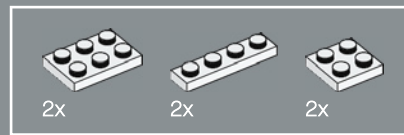
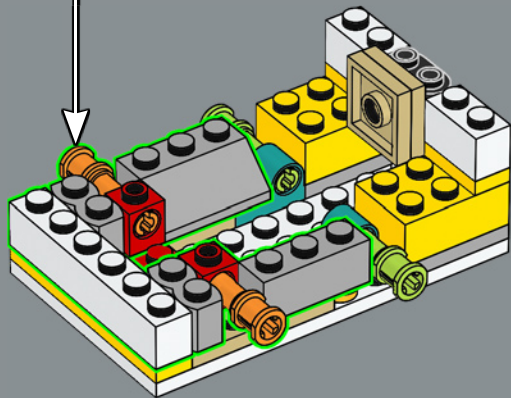
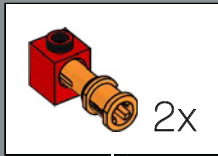

125

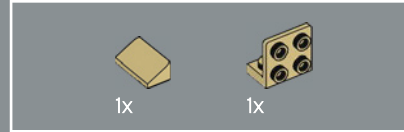
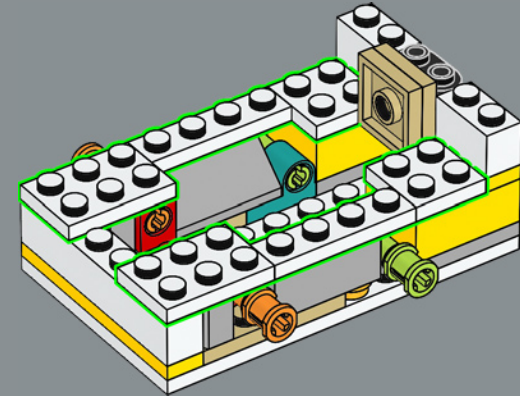

126

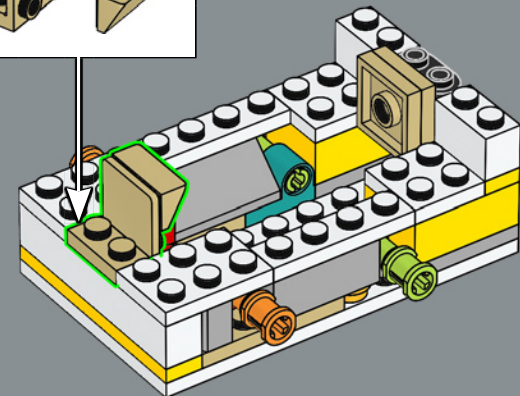
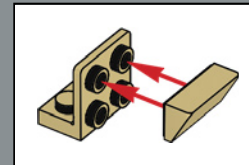

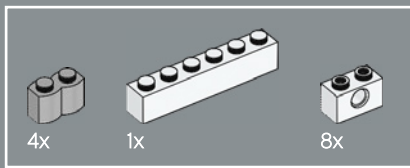

127

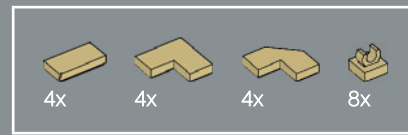
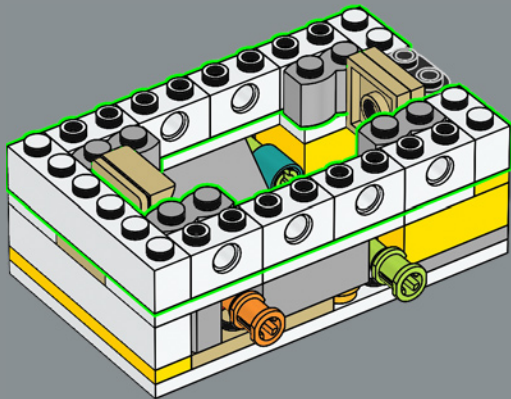

128

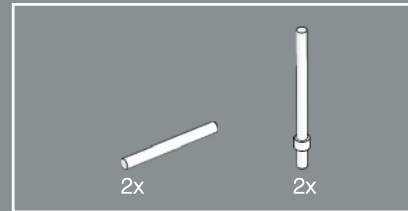
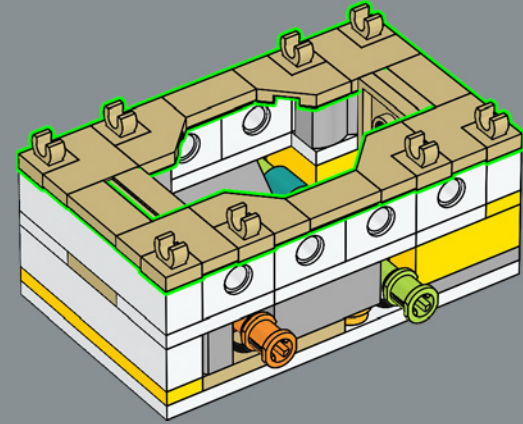

129

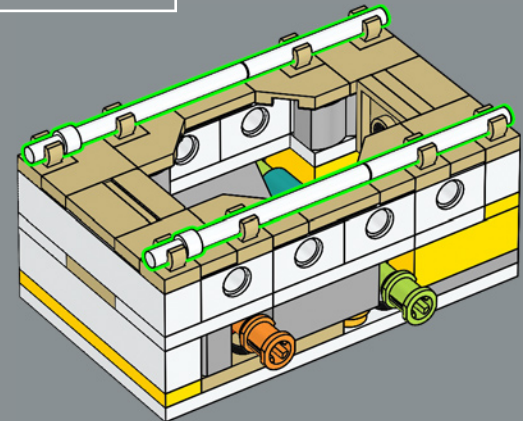

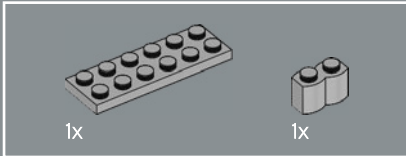
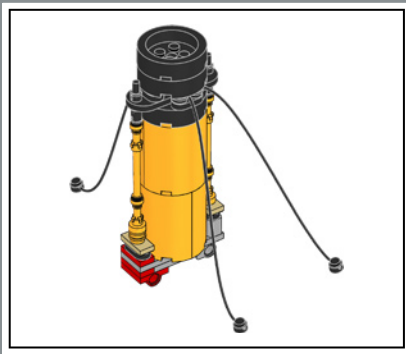

130

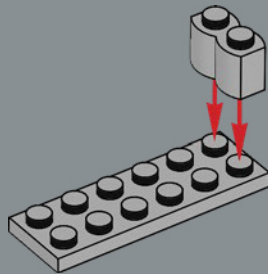

131

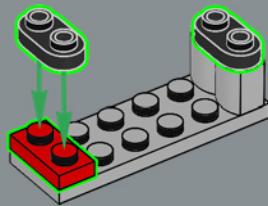

132

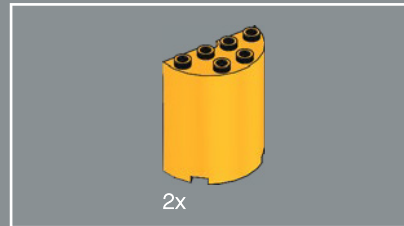
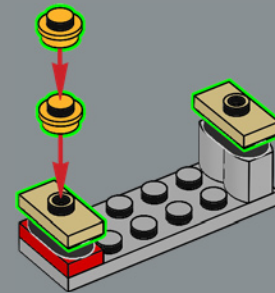

133

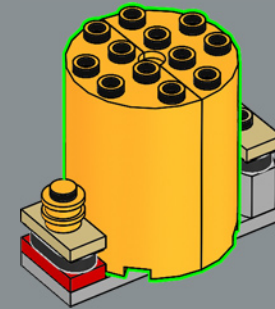

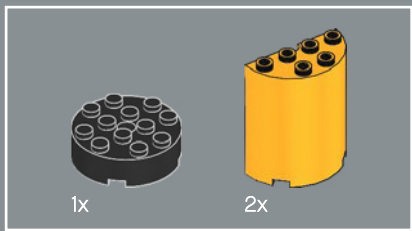

134

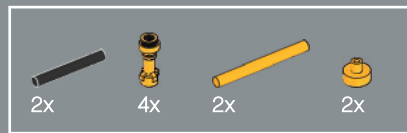
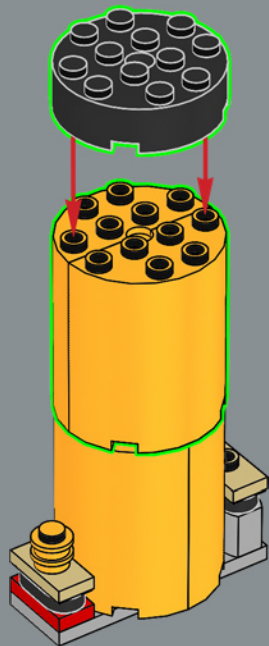

135

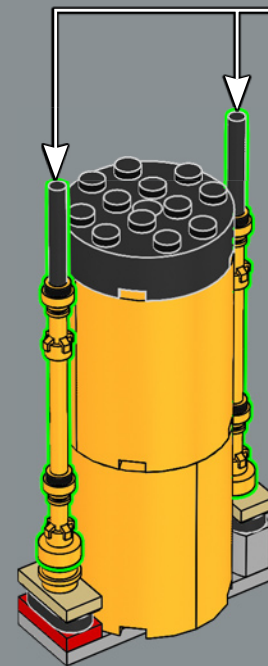
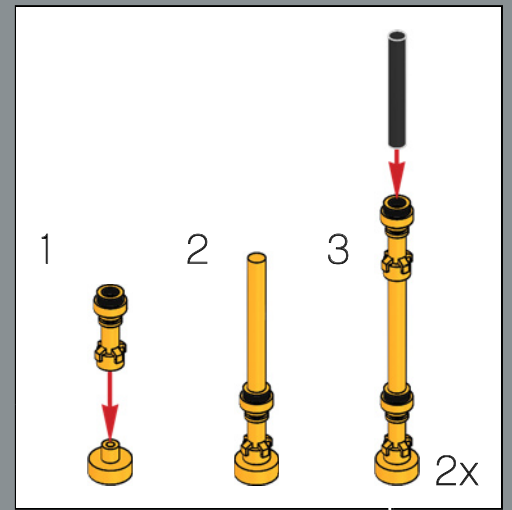

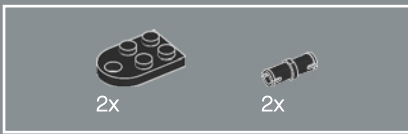

136

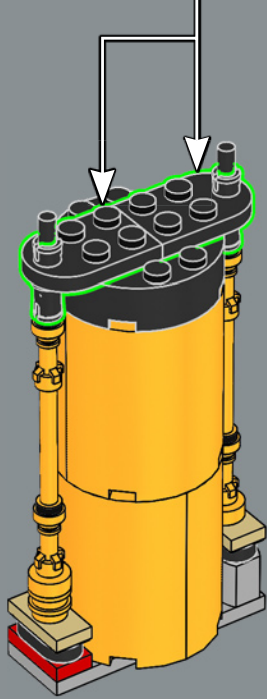
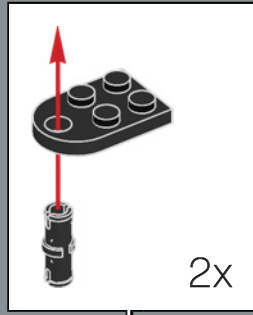

137

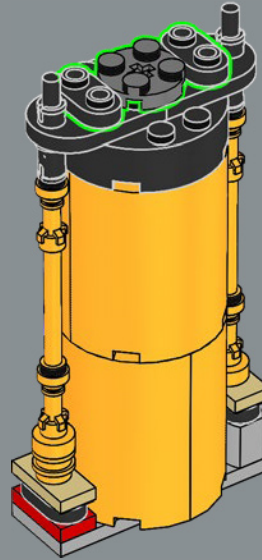

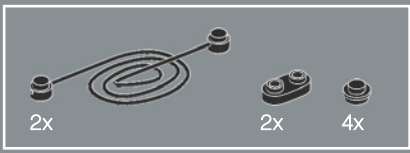

138

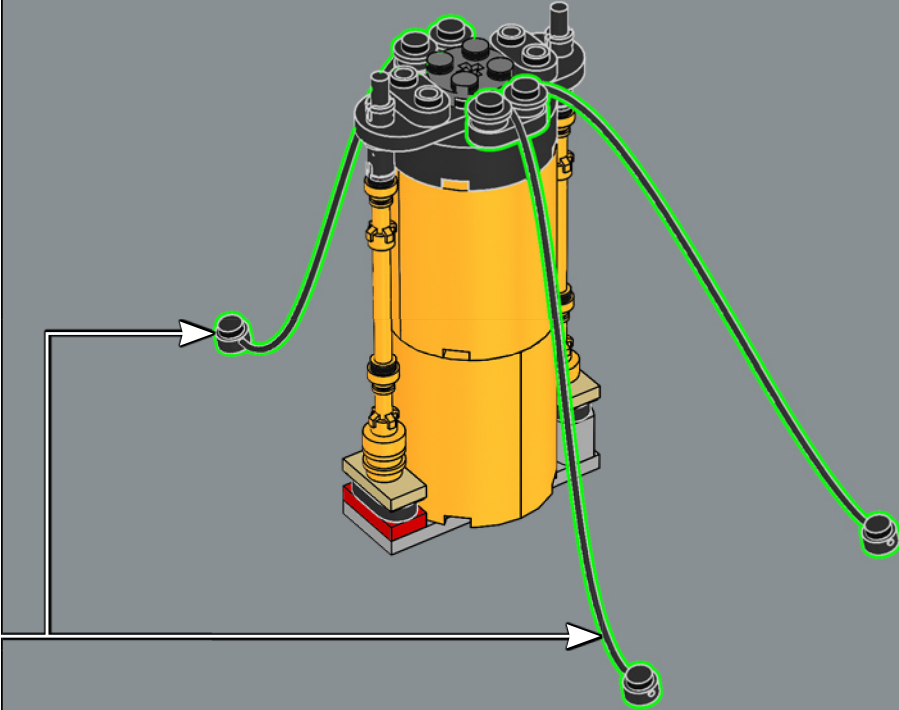
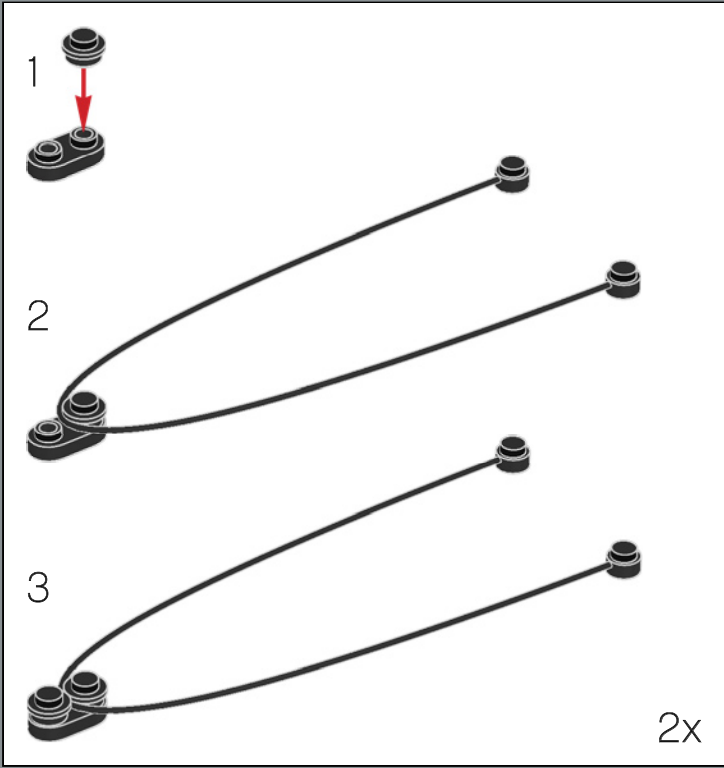



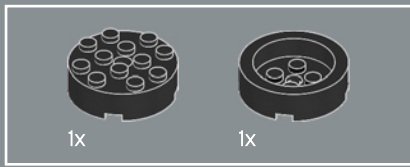

139

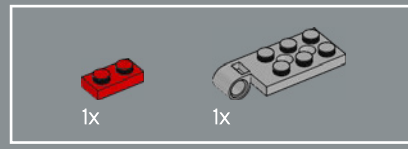
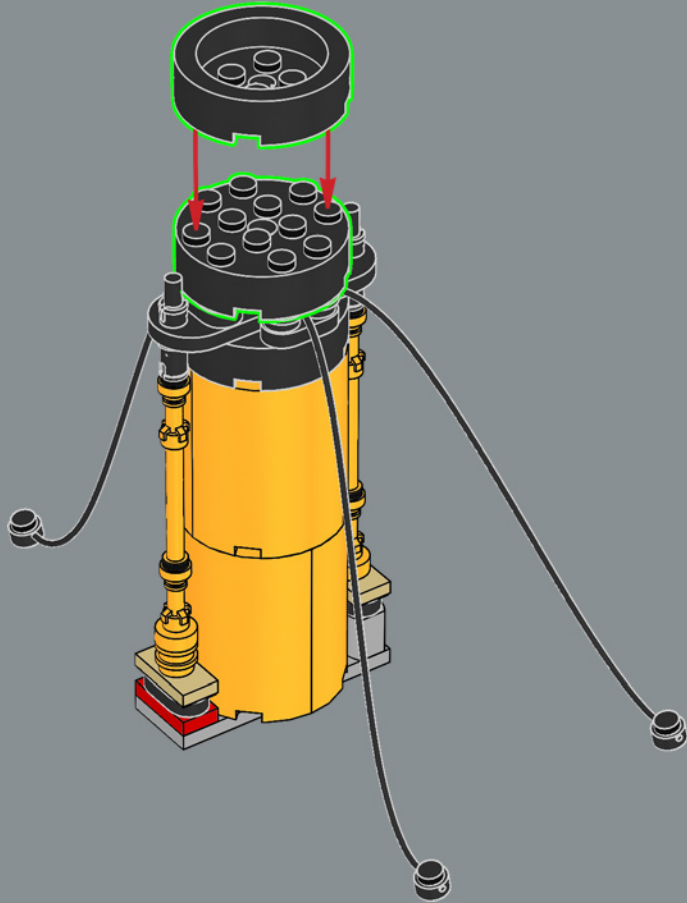

140

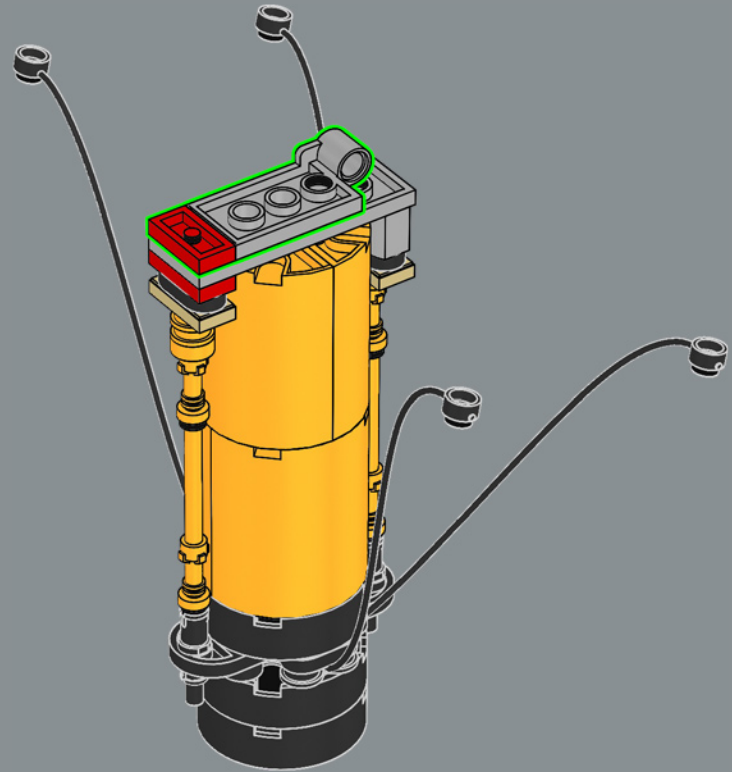

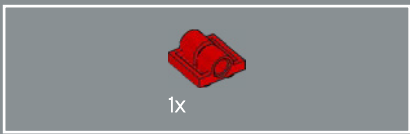

141

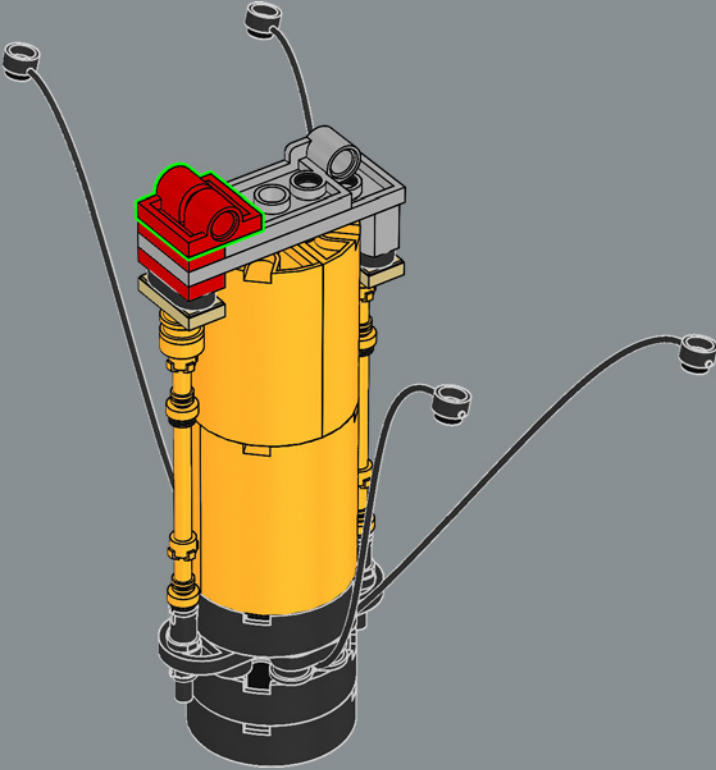

142

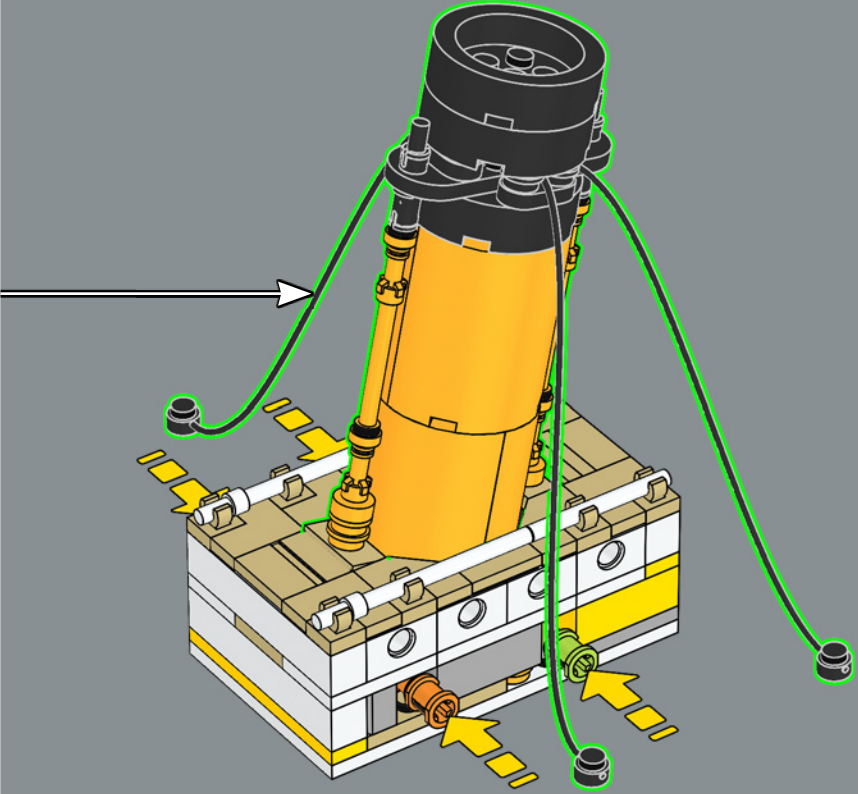

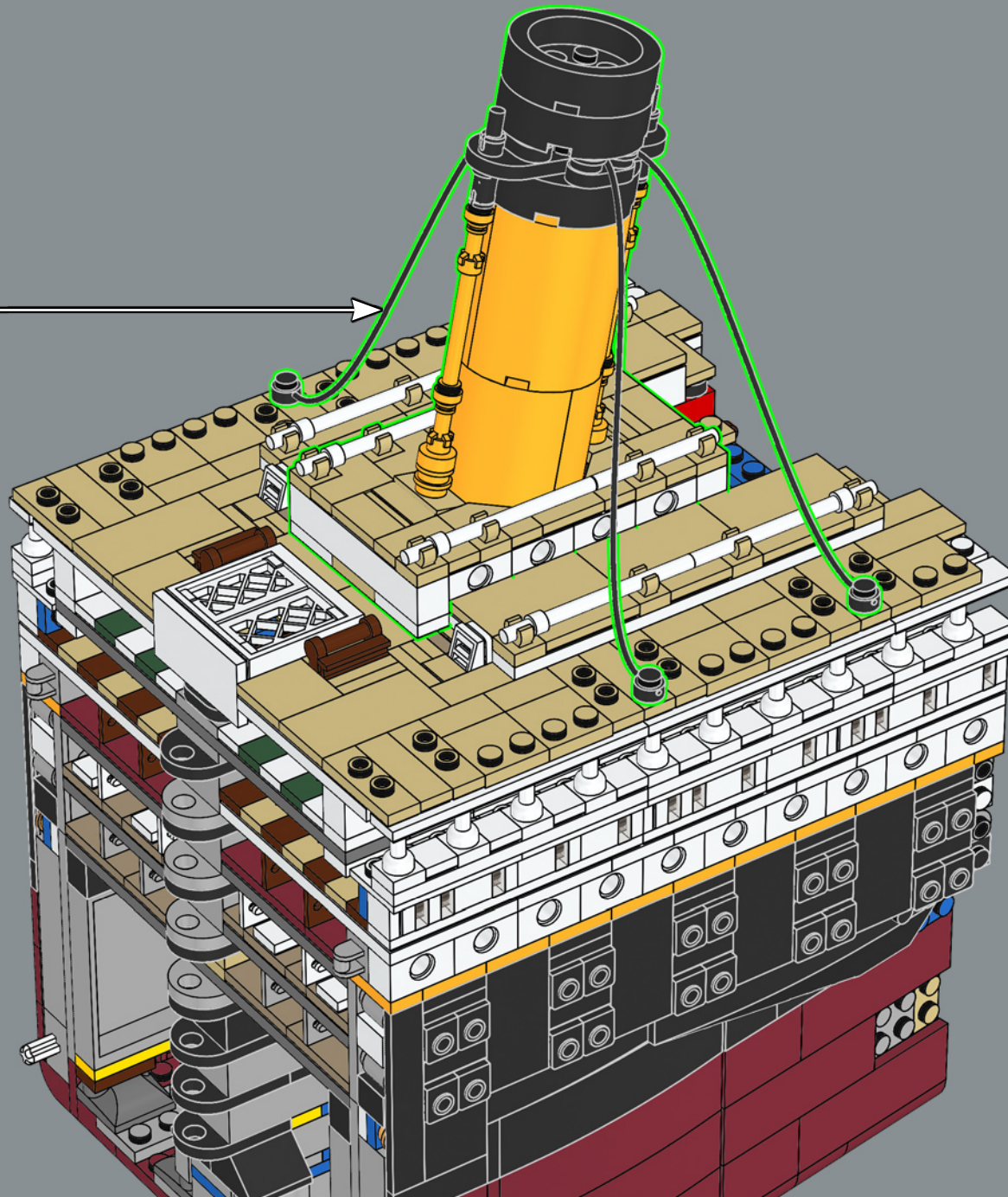

Le Titanic possède quatre cheminées, mais trois seulement sont opérationnelles. La dernière est factice et n'a été posée qu'à des fins esthétiques.

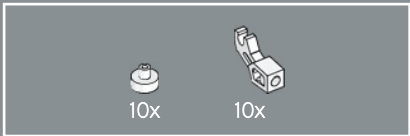

144

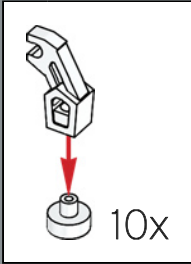
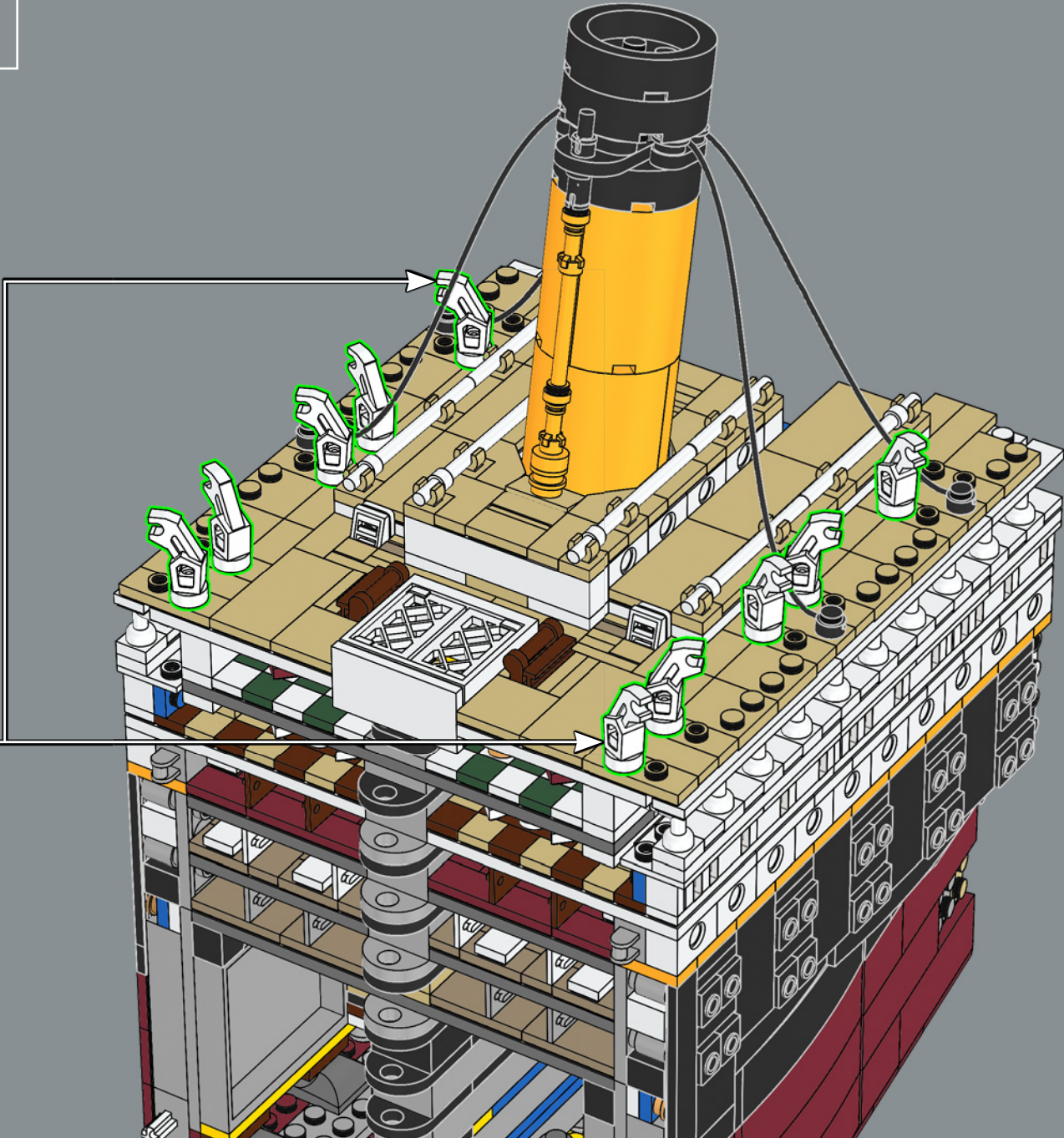

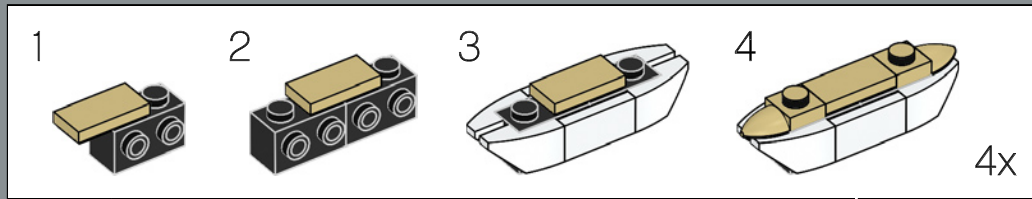
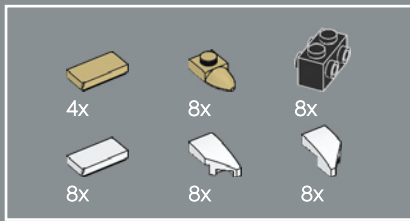

145

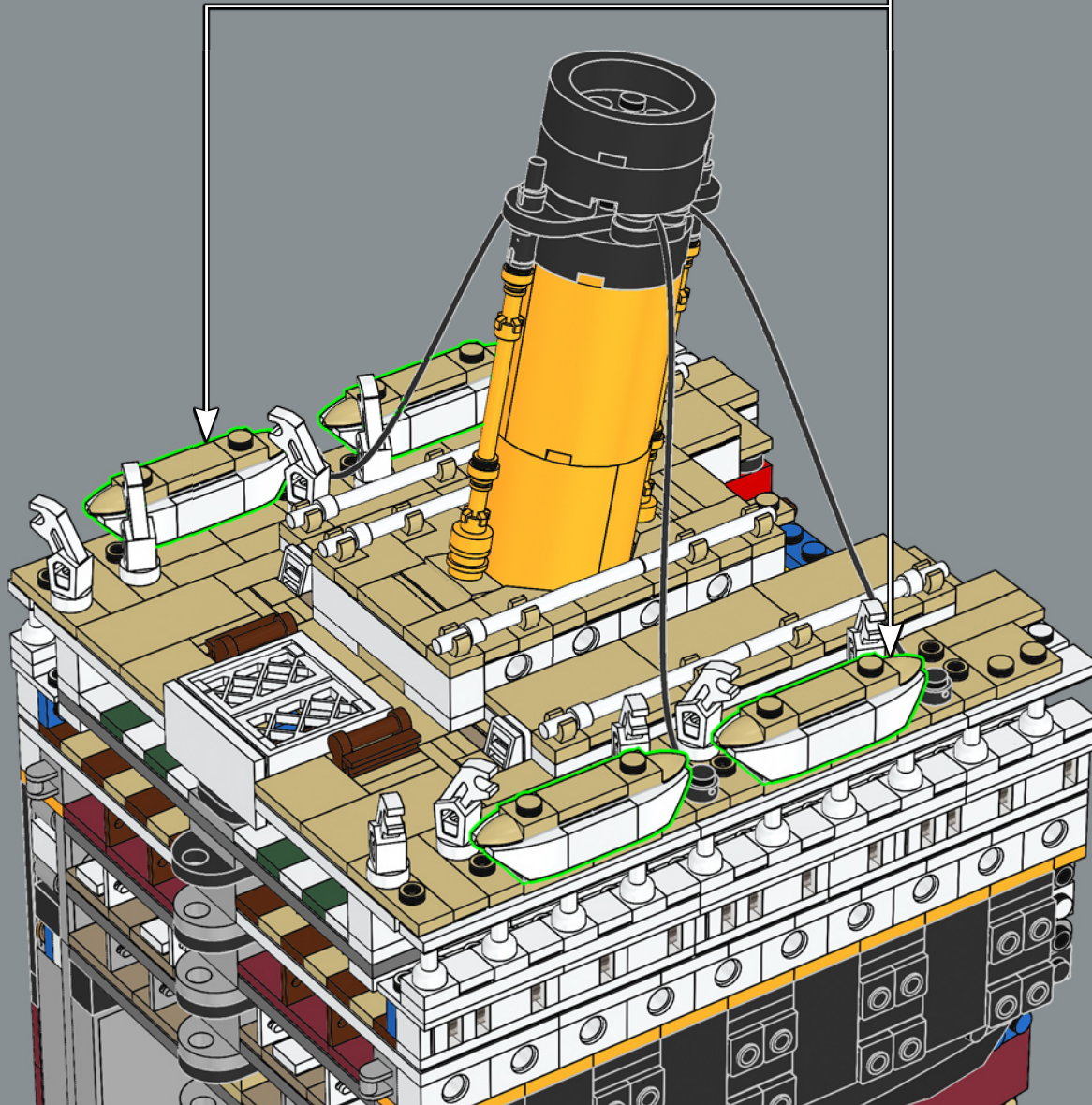

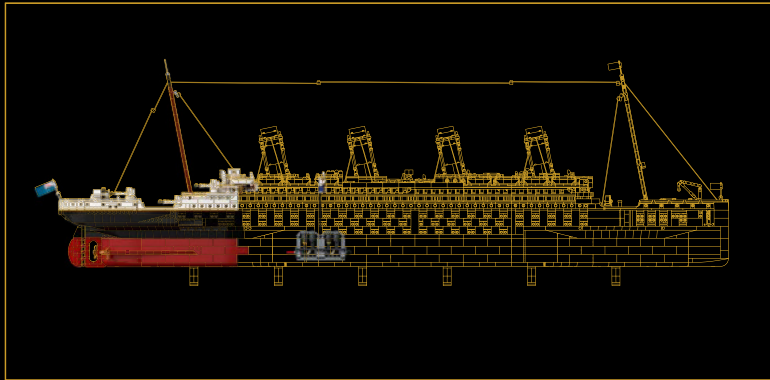

## SECTION 6 :

# POUPE ET COFFRE

Cette dernière section représente la partie la plus complexe de la coque et comprend le gouvernail et les trois principaux arbres de transmission qui relient les hélices aux moteurs. Vous construirez les deux principaux moteurs à pistons qui sont reliés directement aux vis à bâbord et à tribord. En tournant les vis, vous pouvez faire bouger les vilebrequins et les pistons à l'intérieur du modèle.

↘ Les détails extérieurs de cette section comprennent la poupe et les bancs pour les passagers de la 3<sup>e</sup> classe.



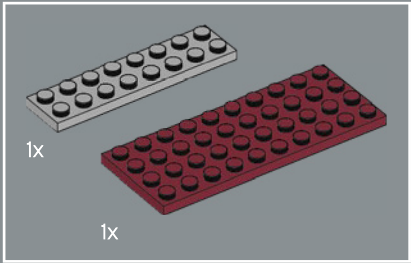
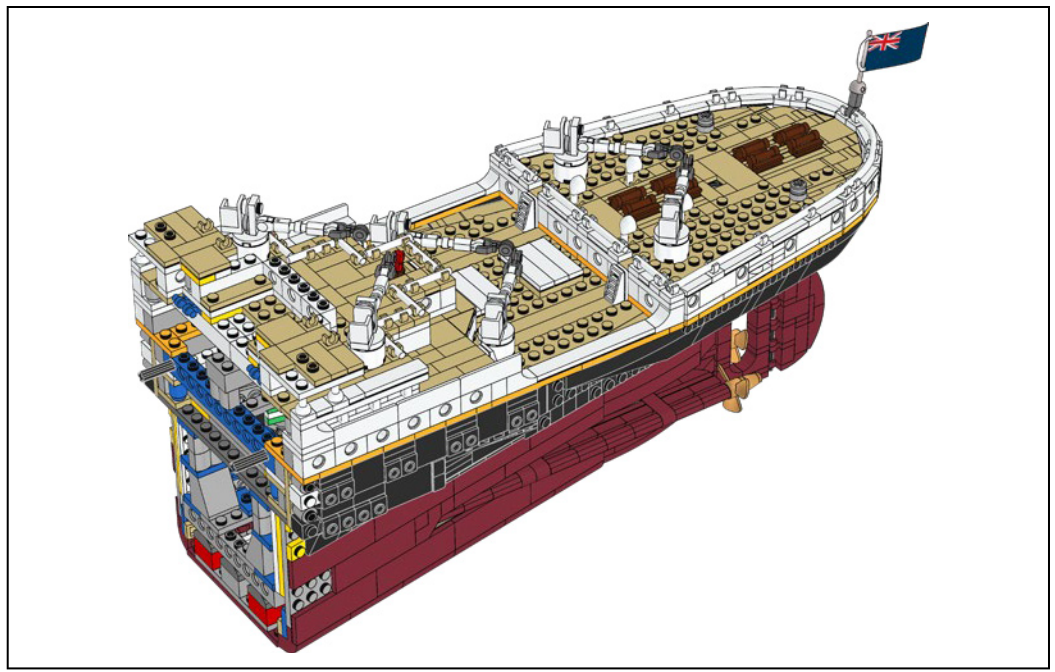
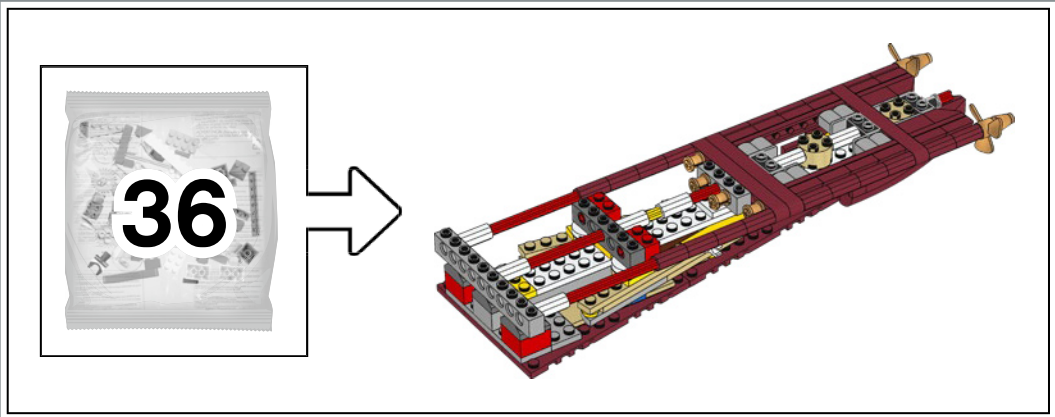

146

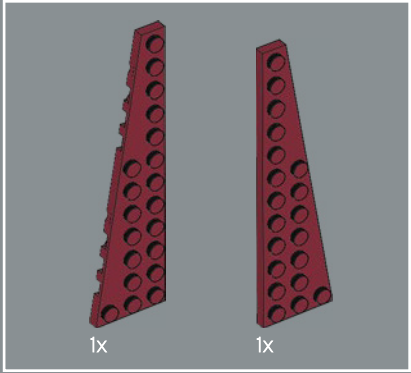
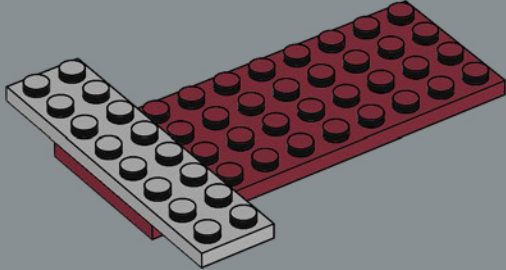

147

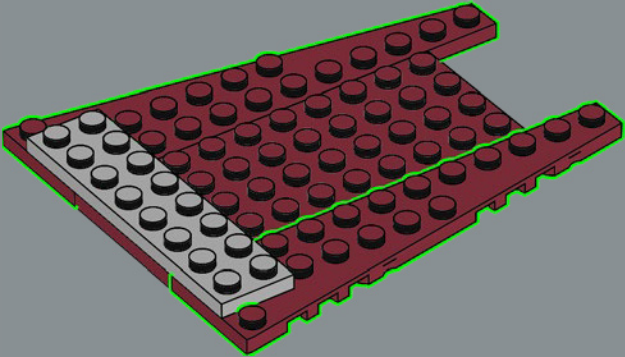

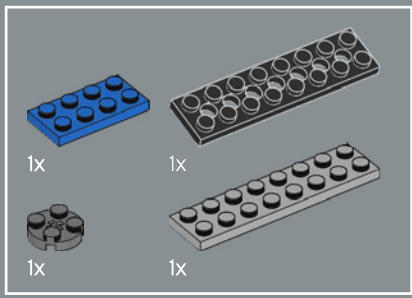

148

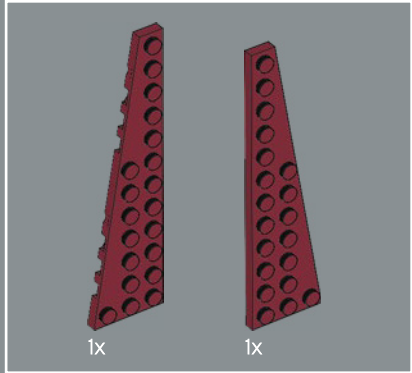
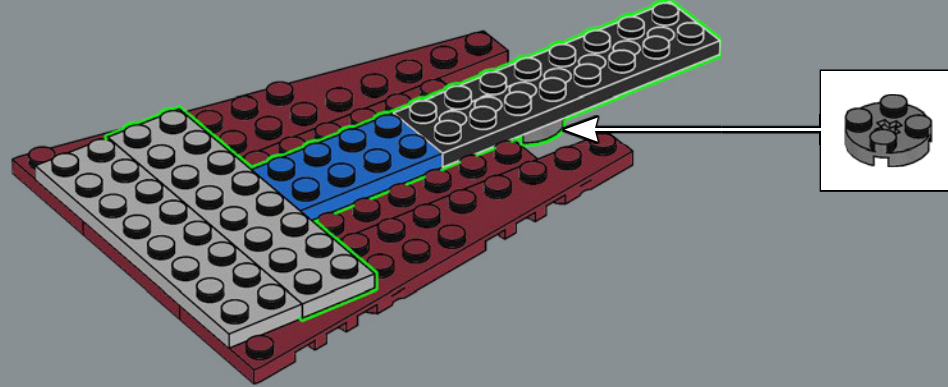

149

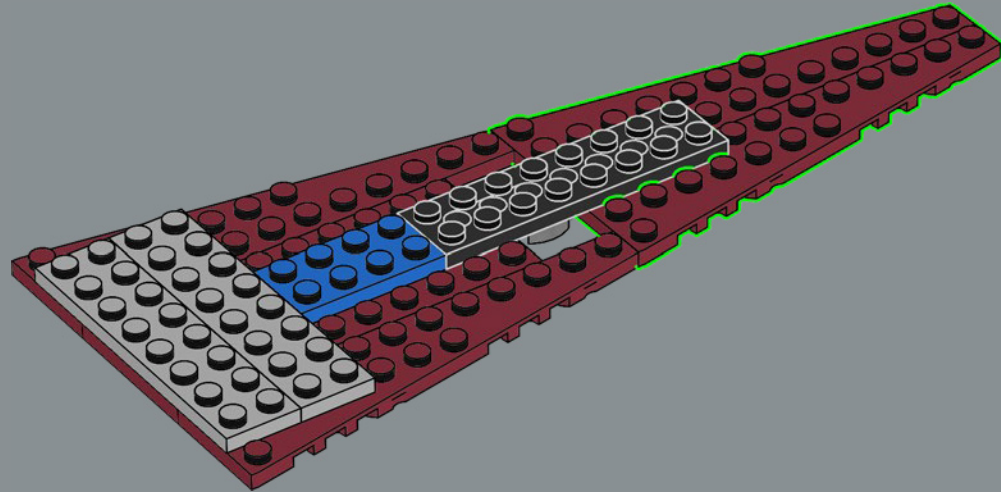



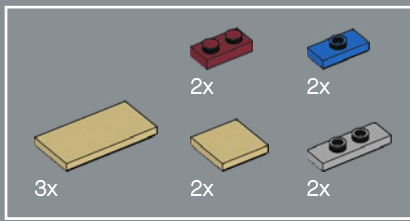

150

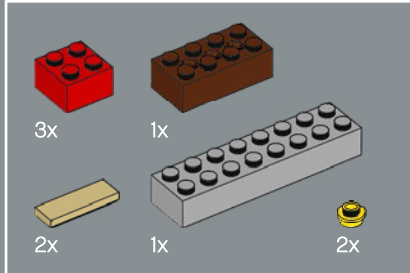
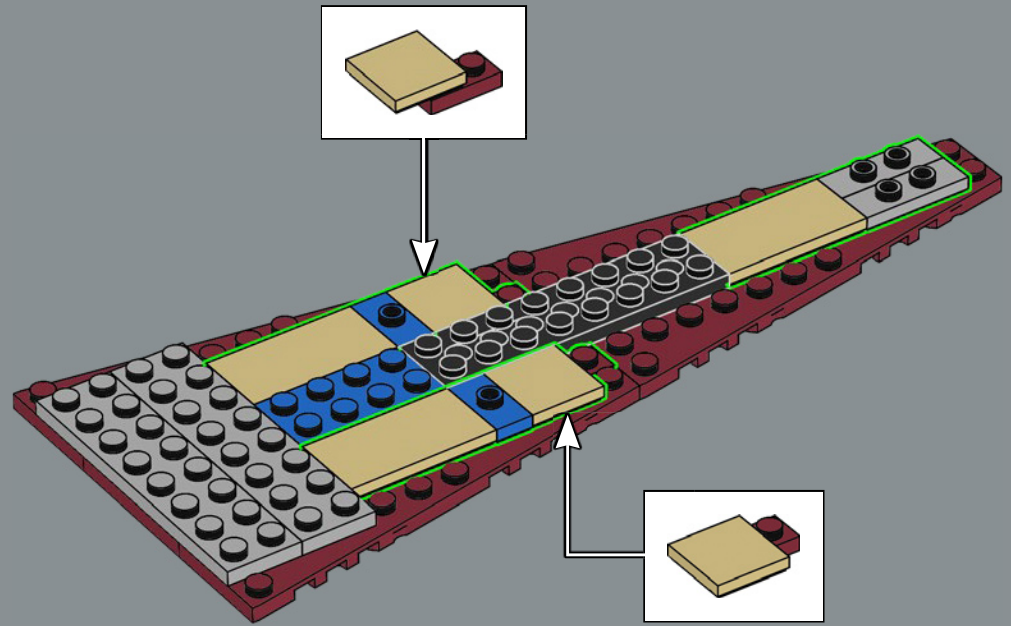

151

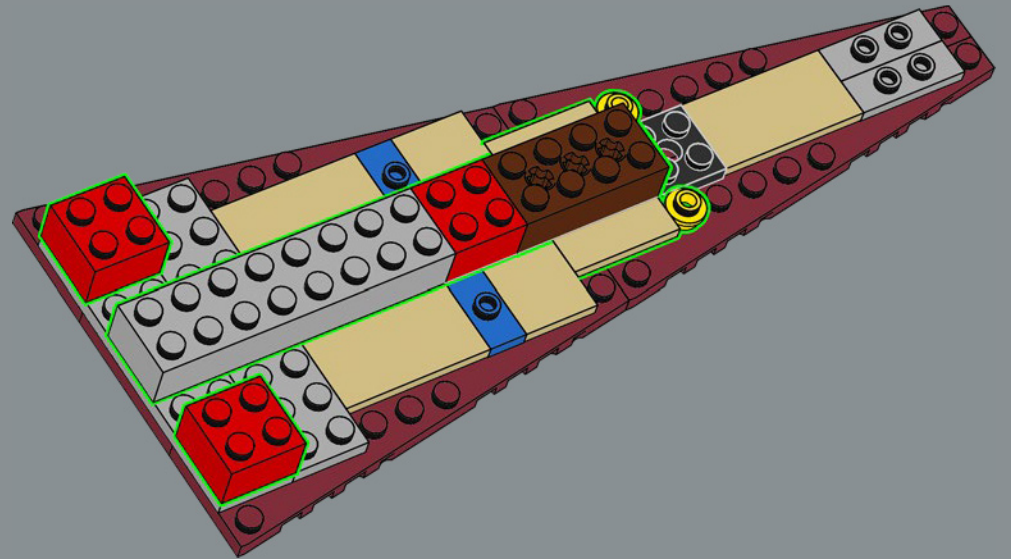

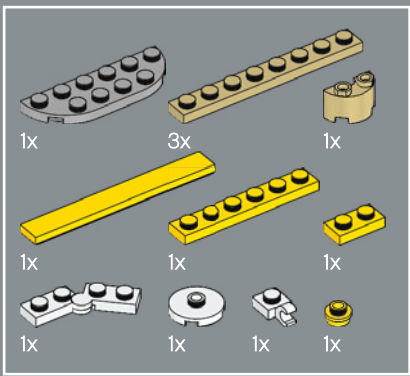

152

1

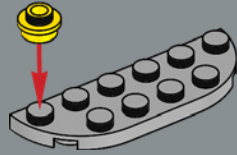

2

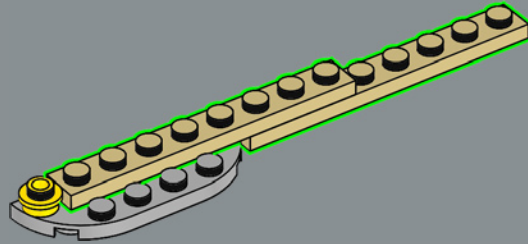

3

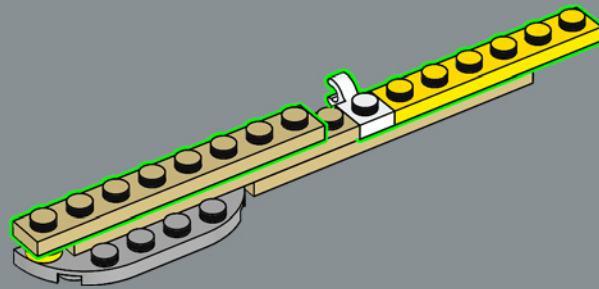

4

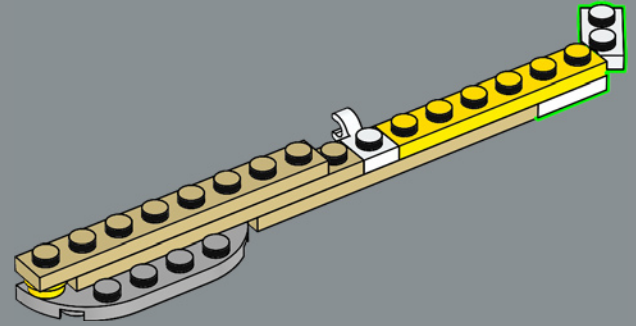

5

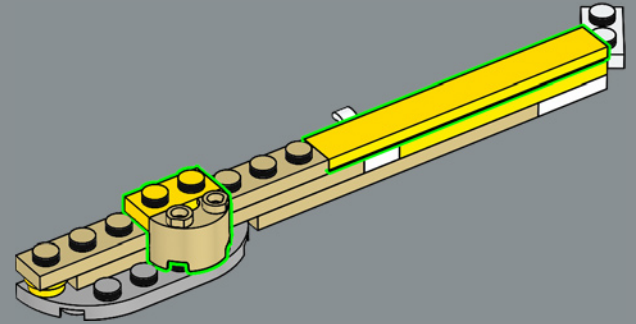

6

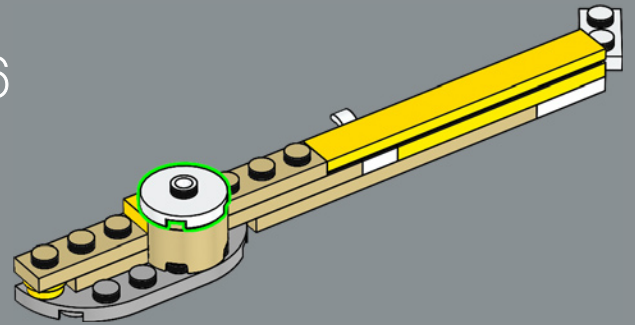

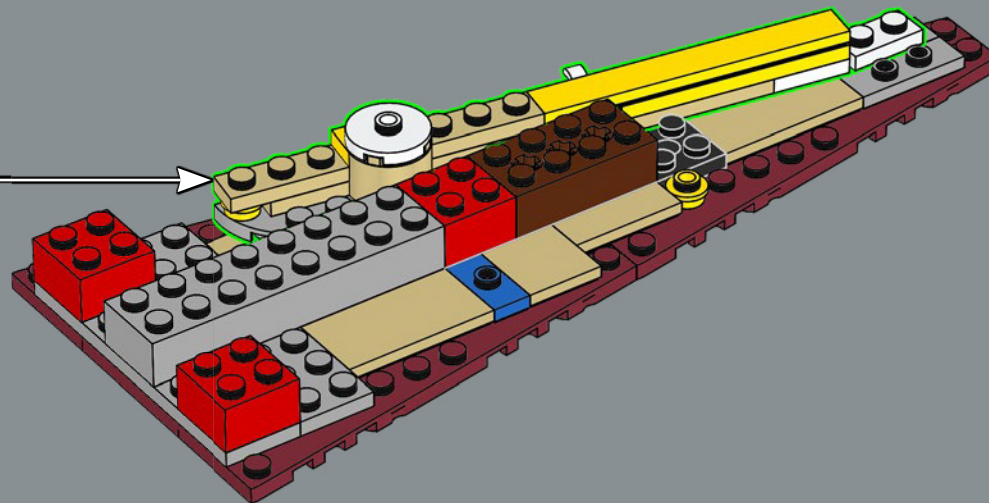



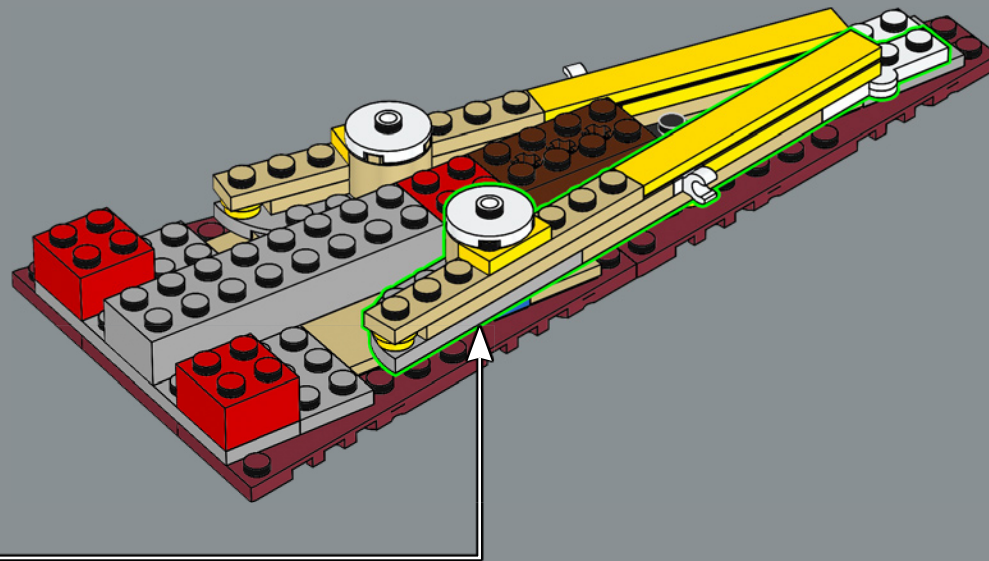

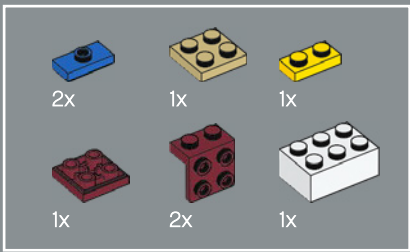

154

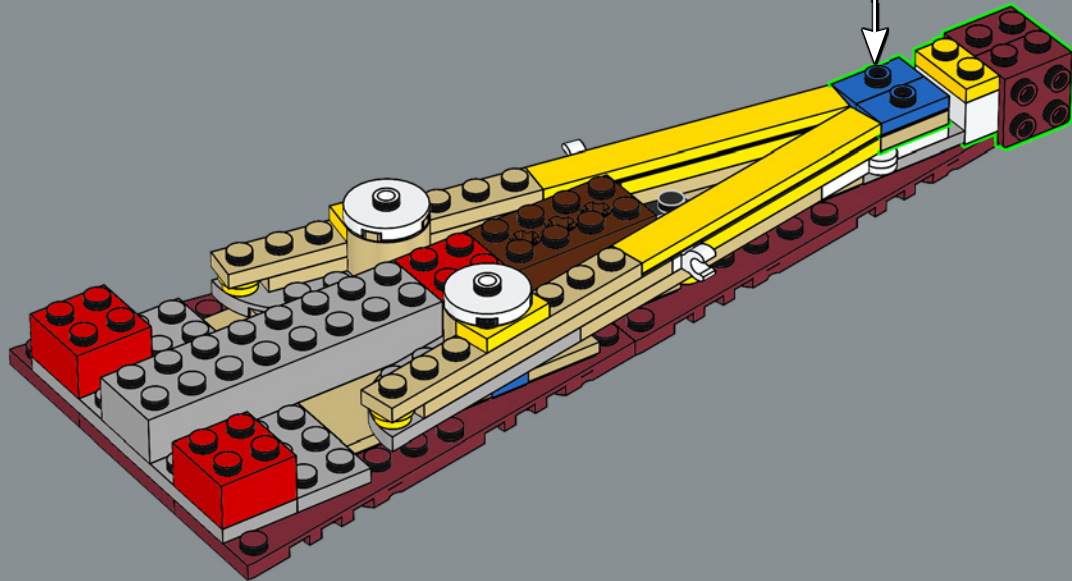
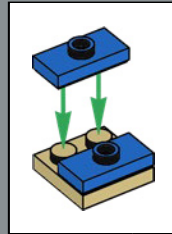
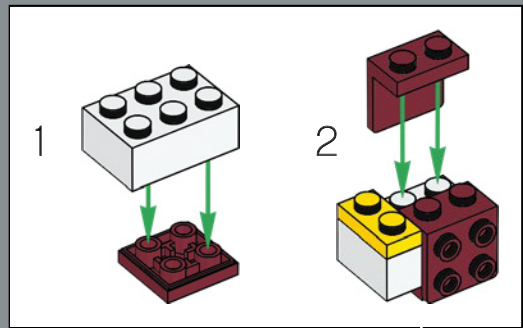

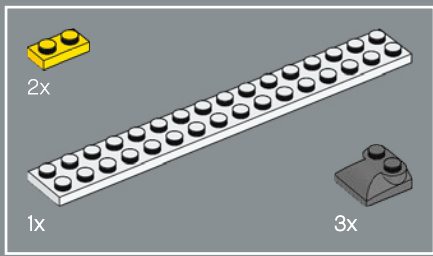

155

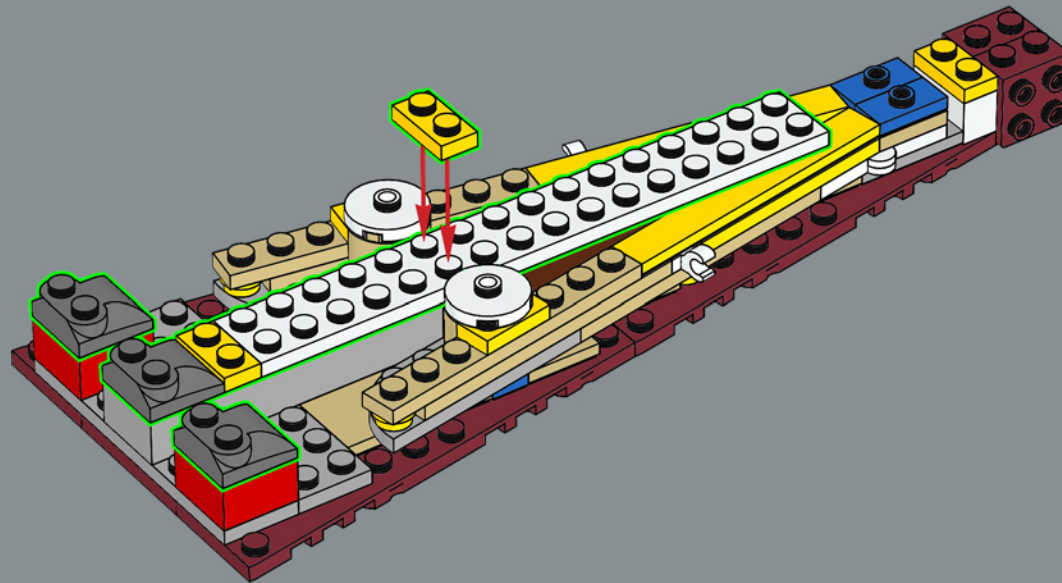

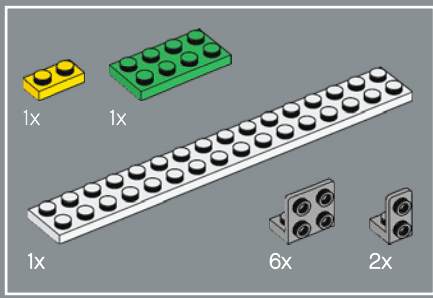

156

1

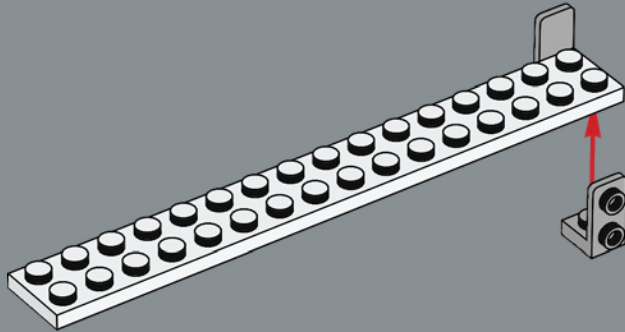

2

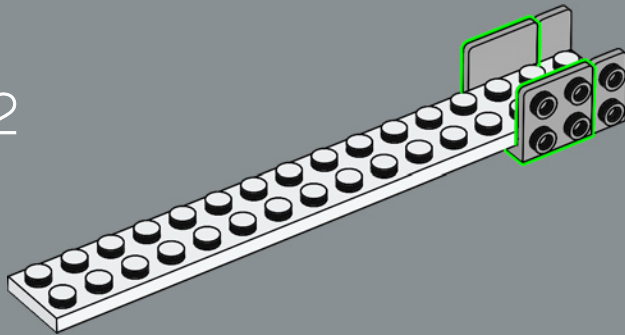

3

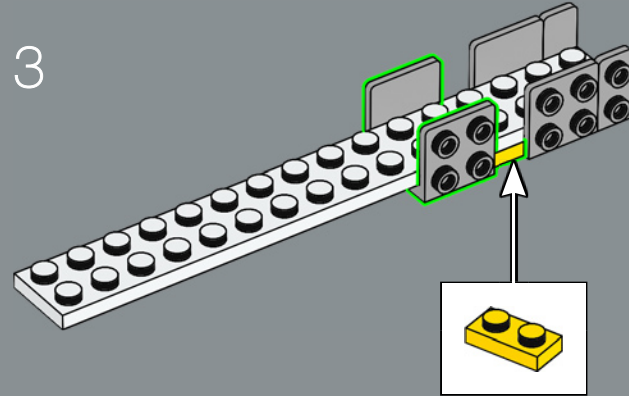

4

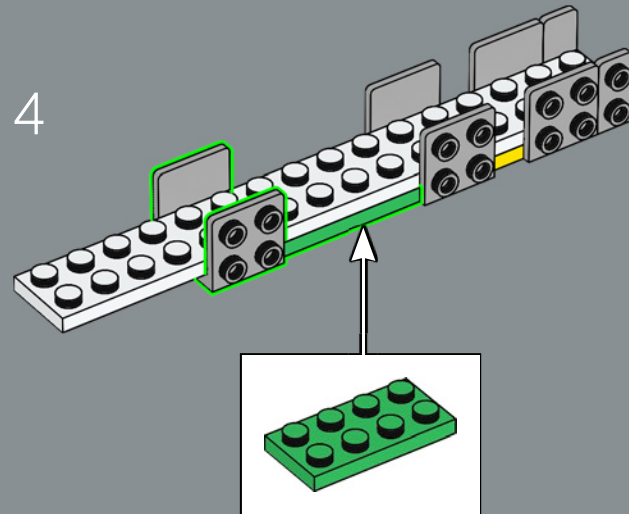



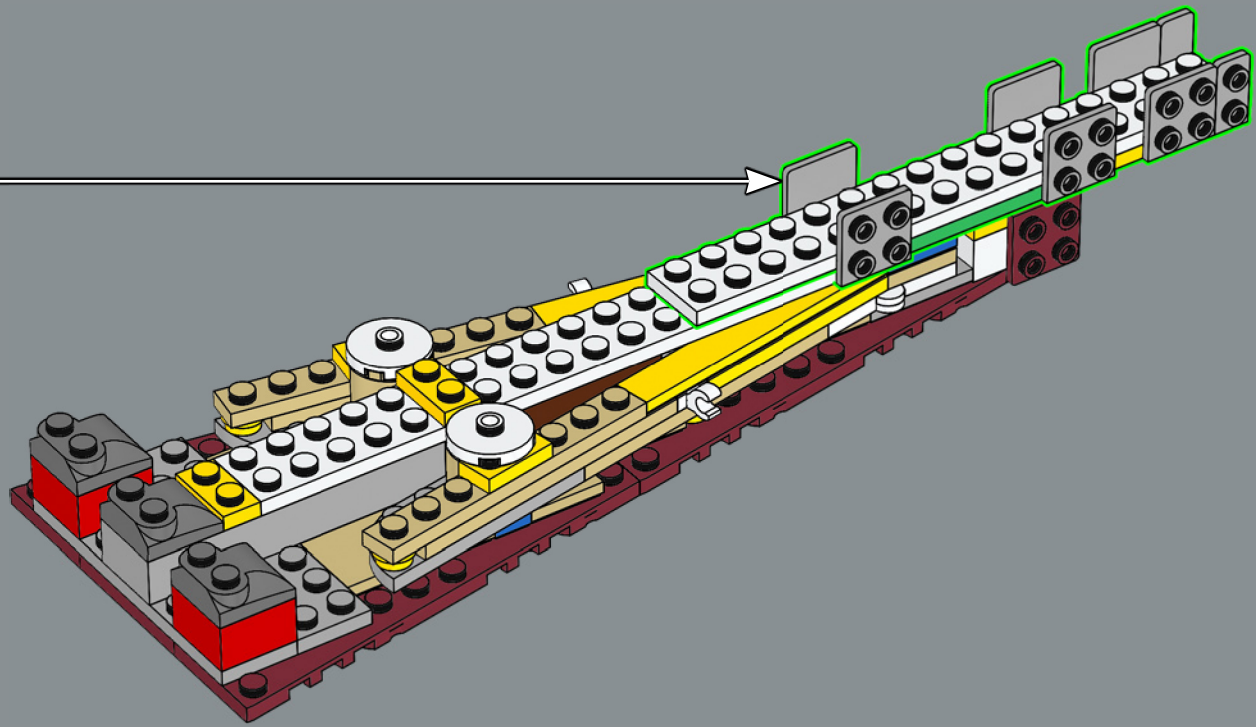

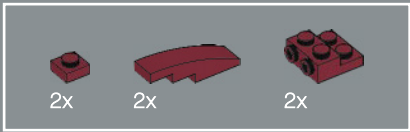

157

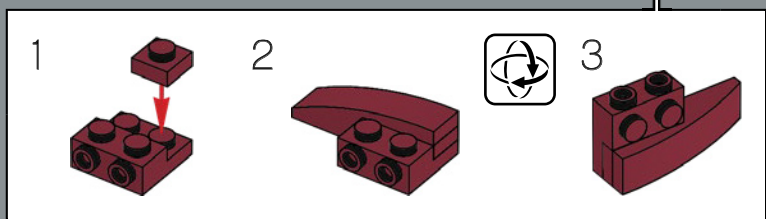
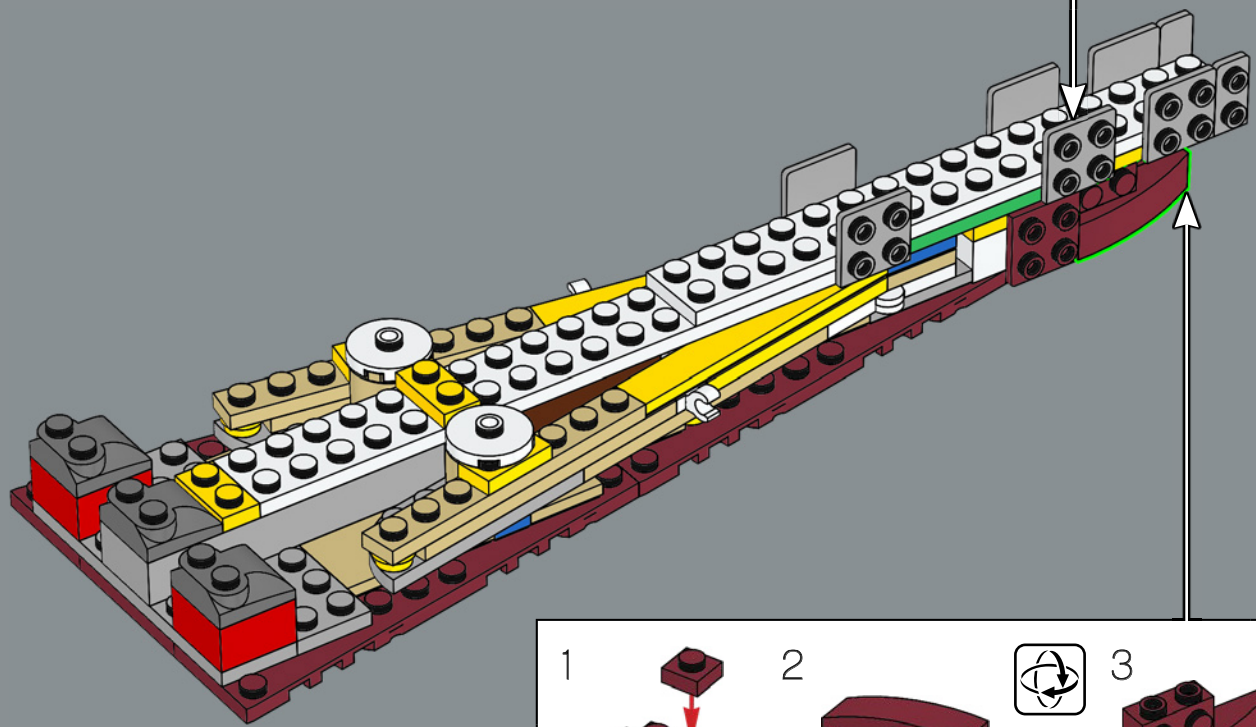
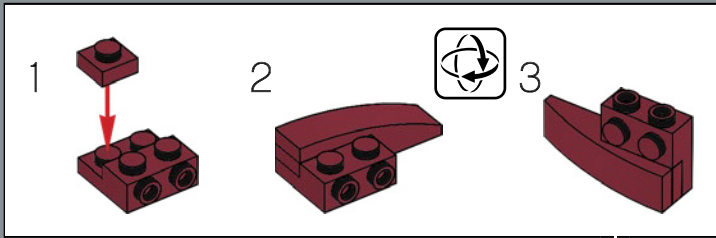

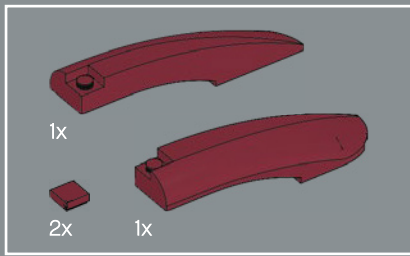

158

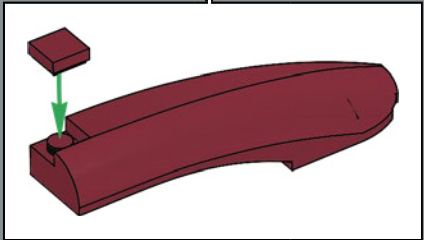
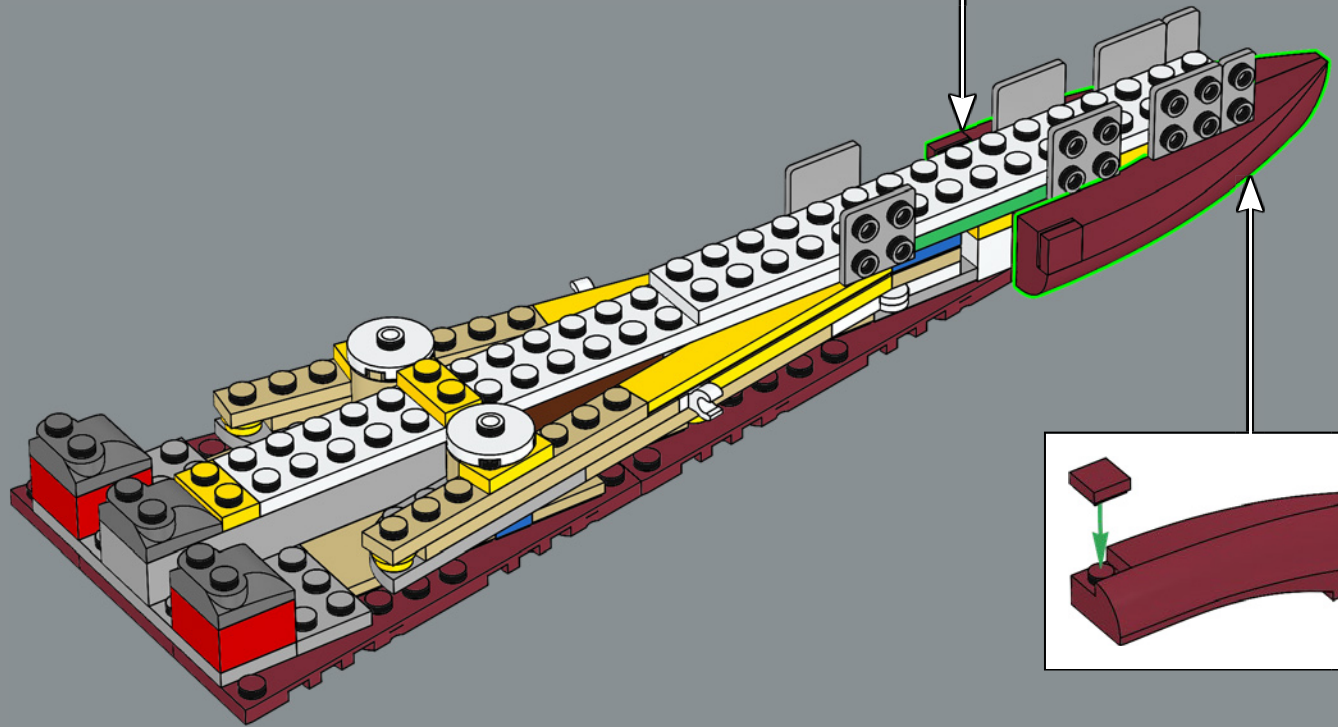
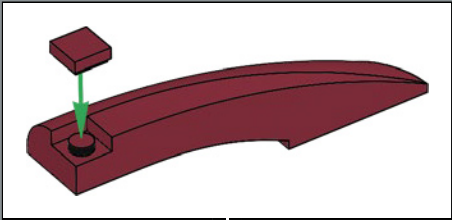

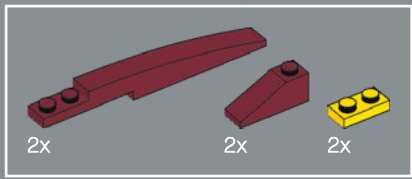

159

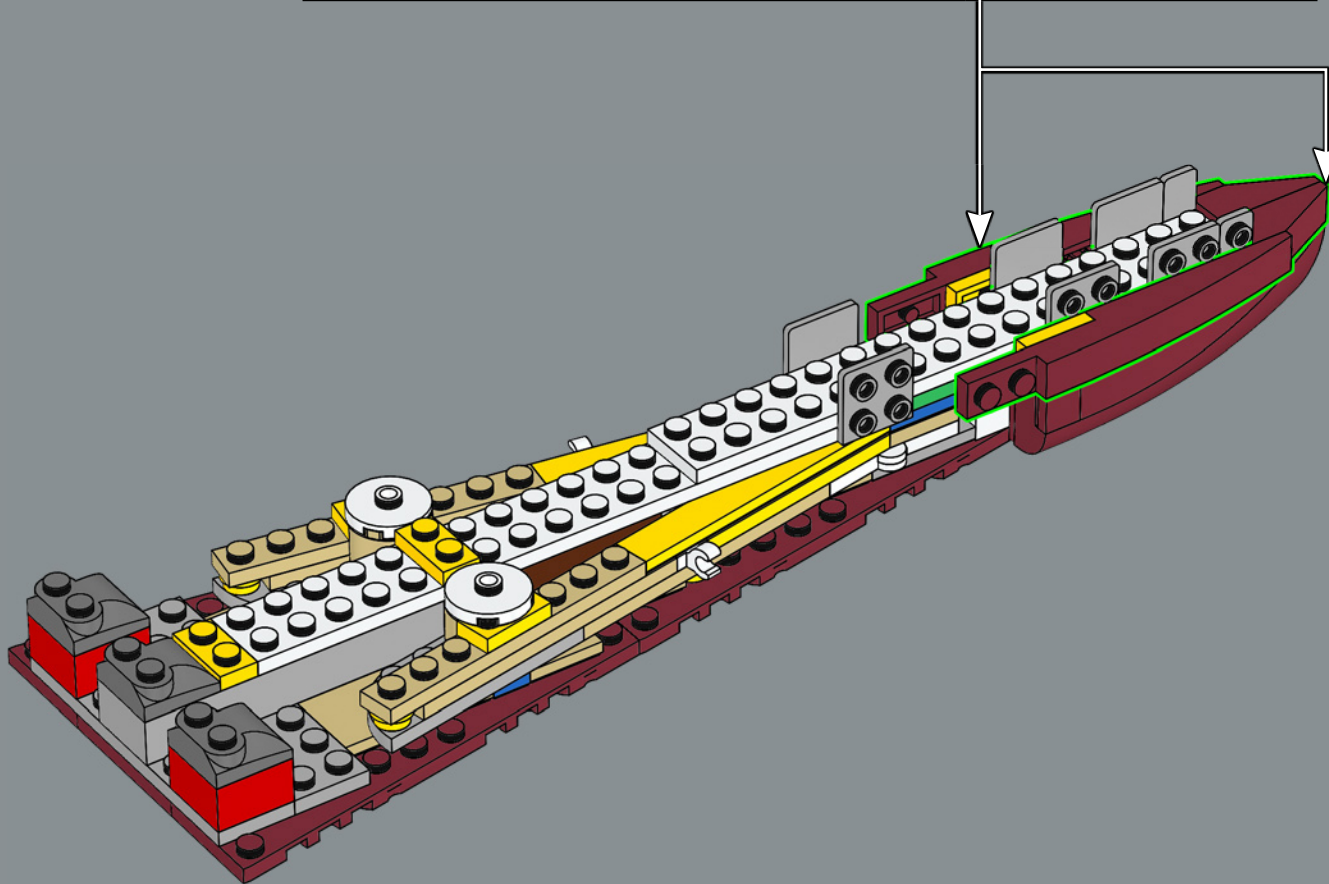
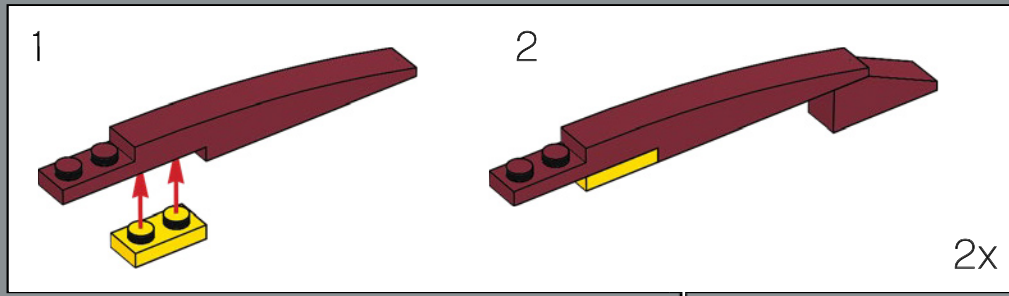

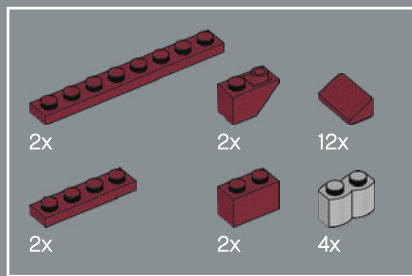

160

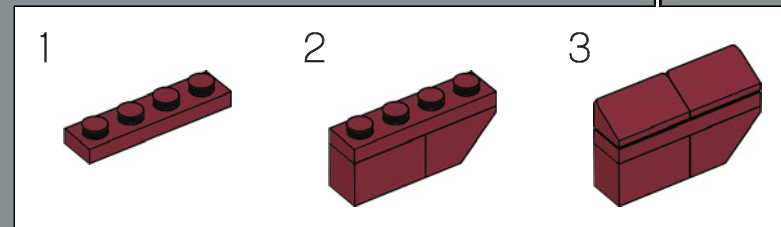
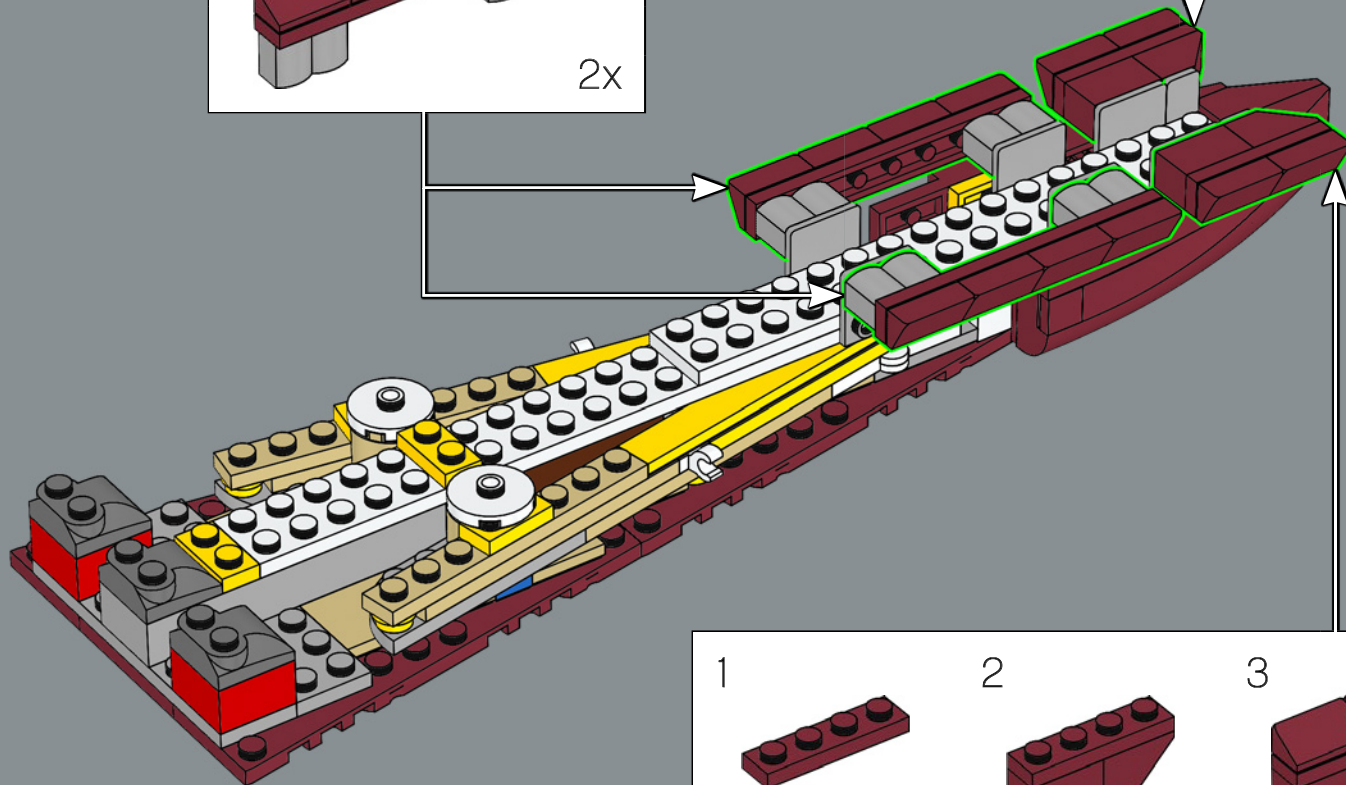
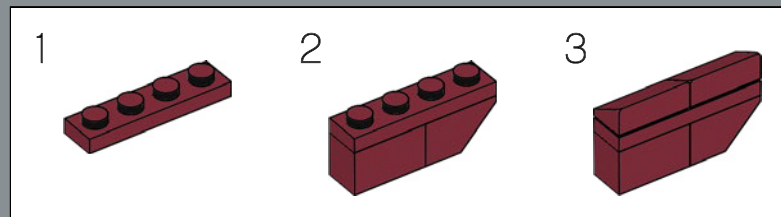
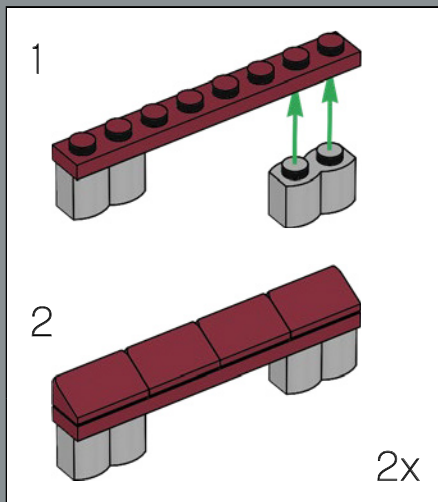

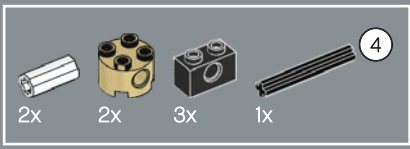

161

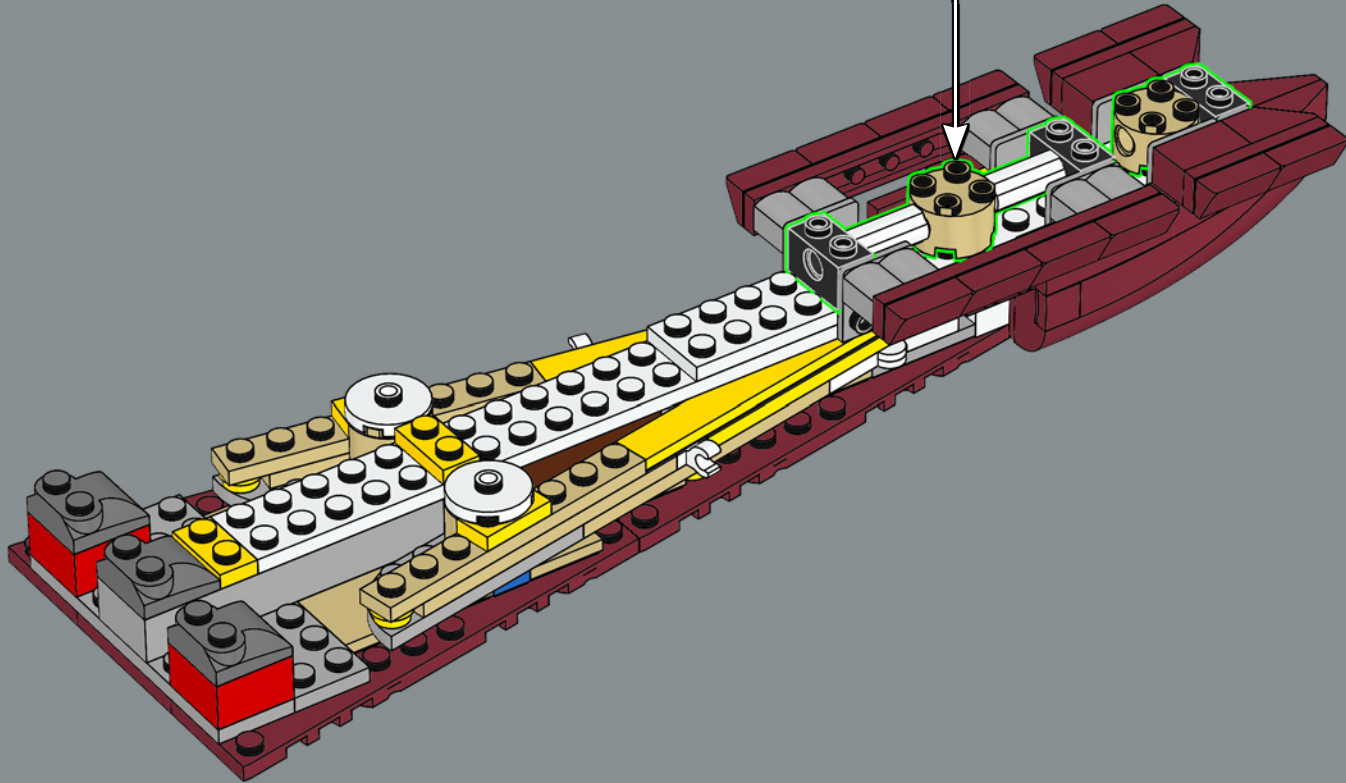
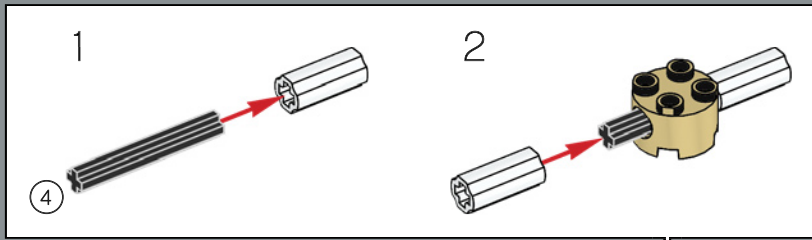

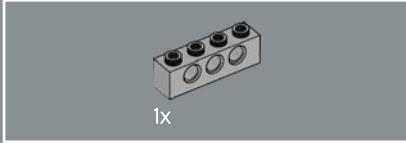
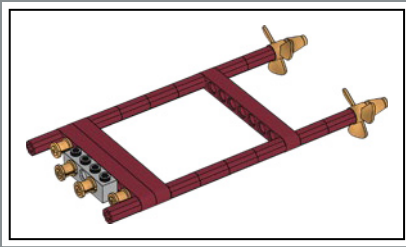

162

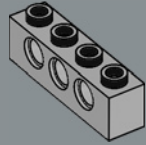

163

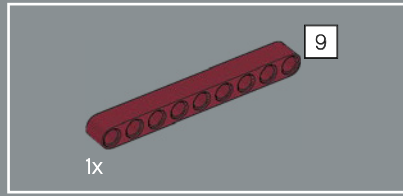
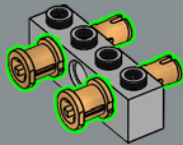

164

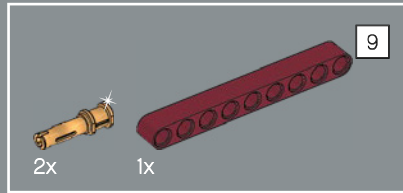
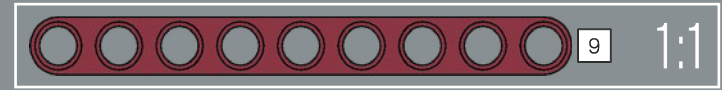

165

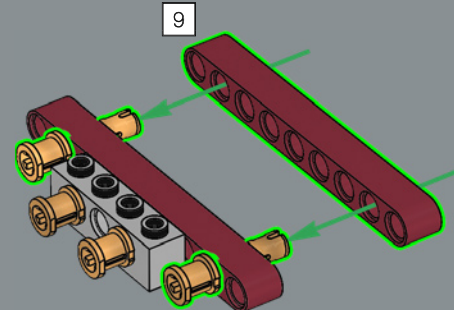
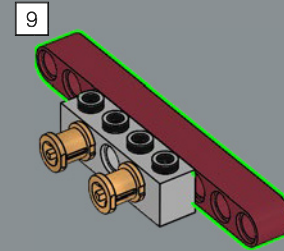

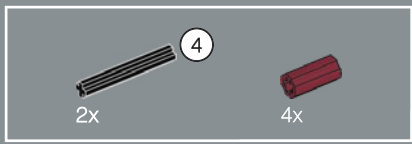

166

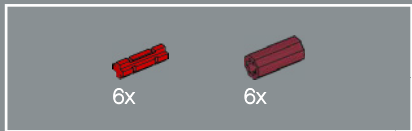
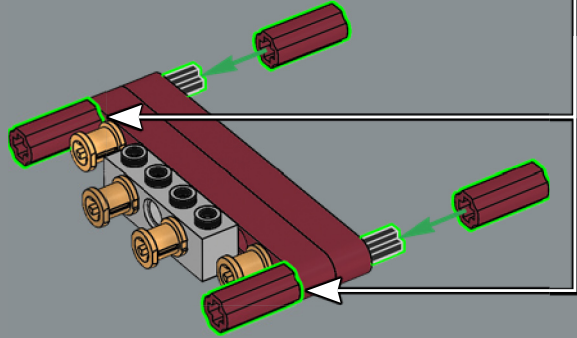
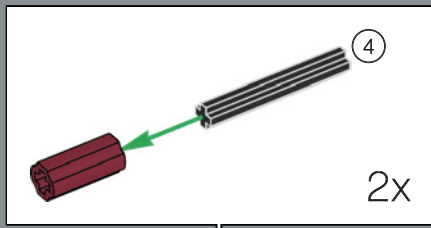

167

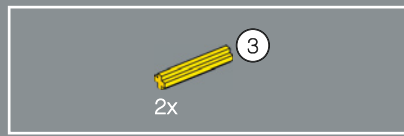
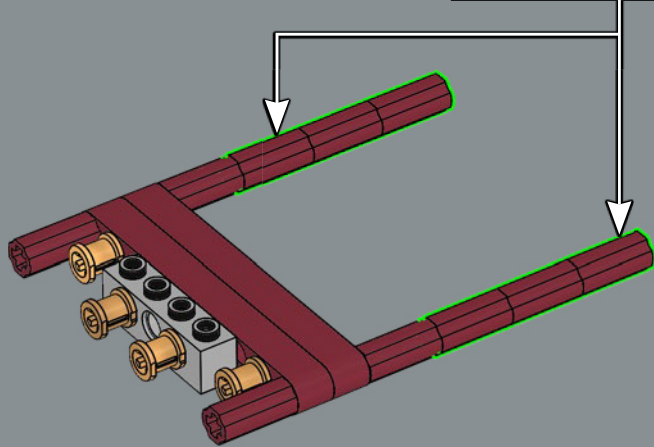
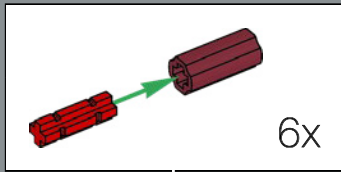

168

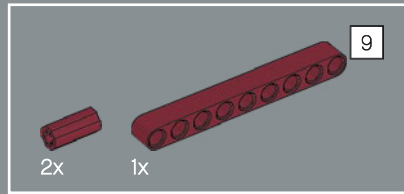
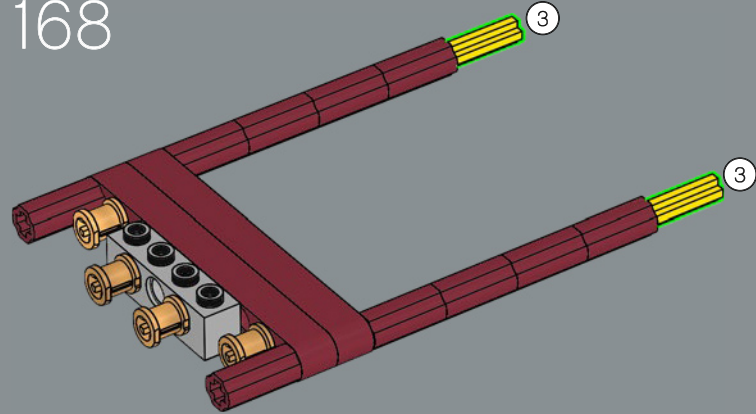

169

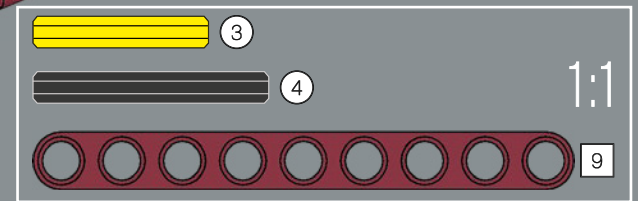
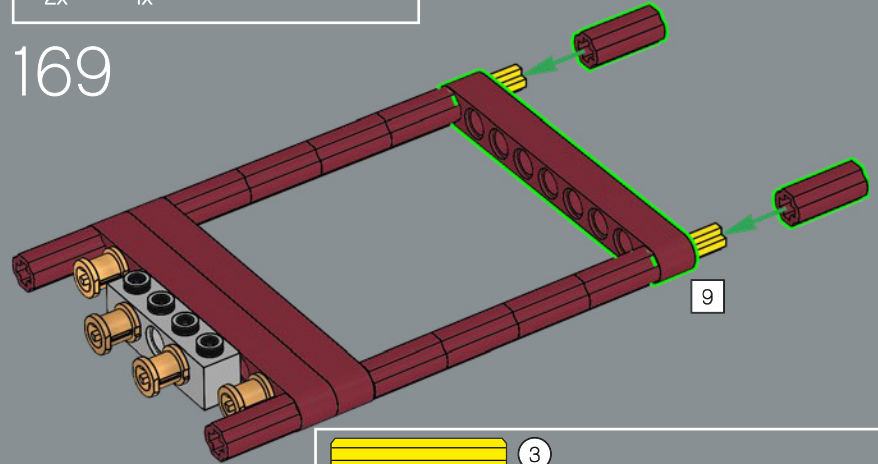

1:1



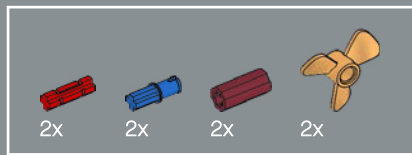

170

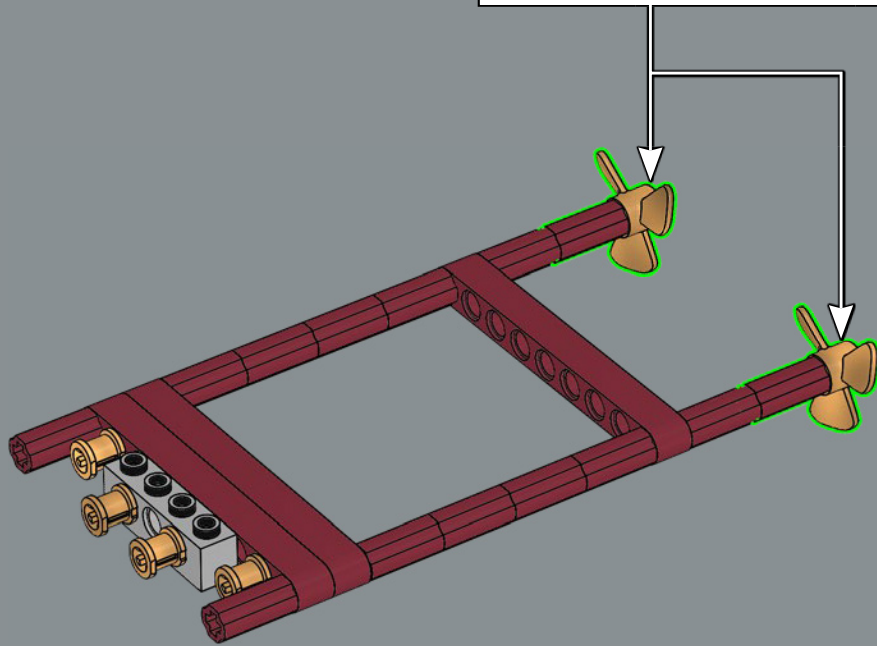
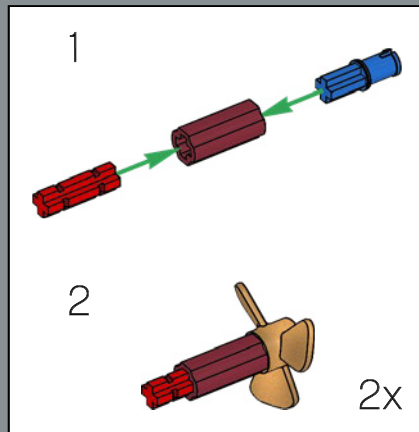

171

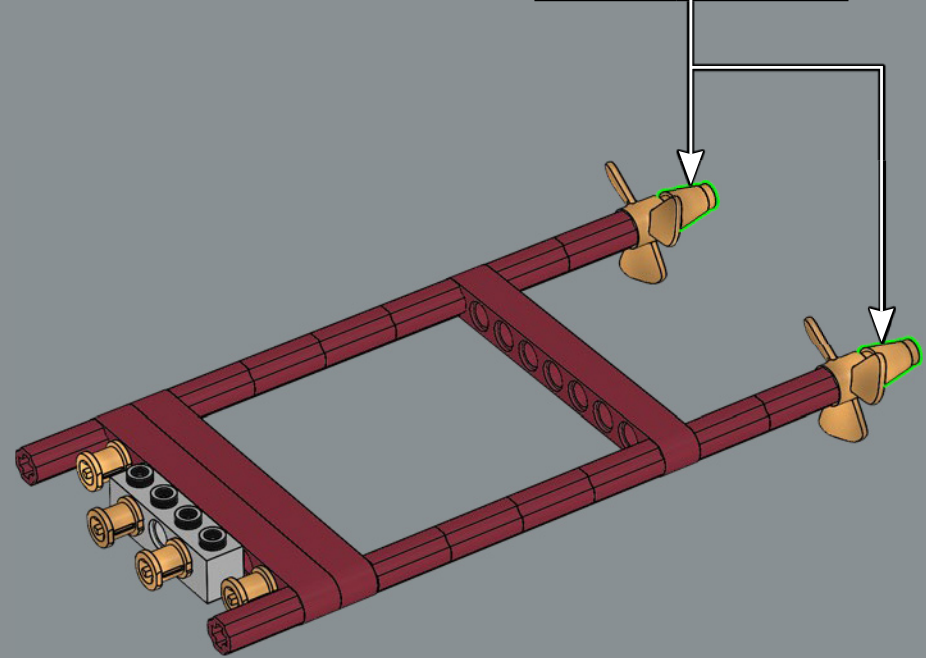
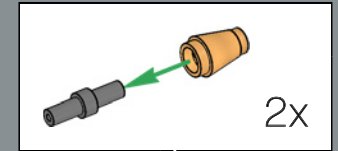

172

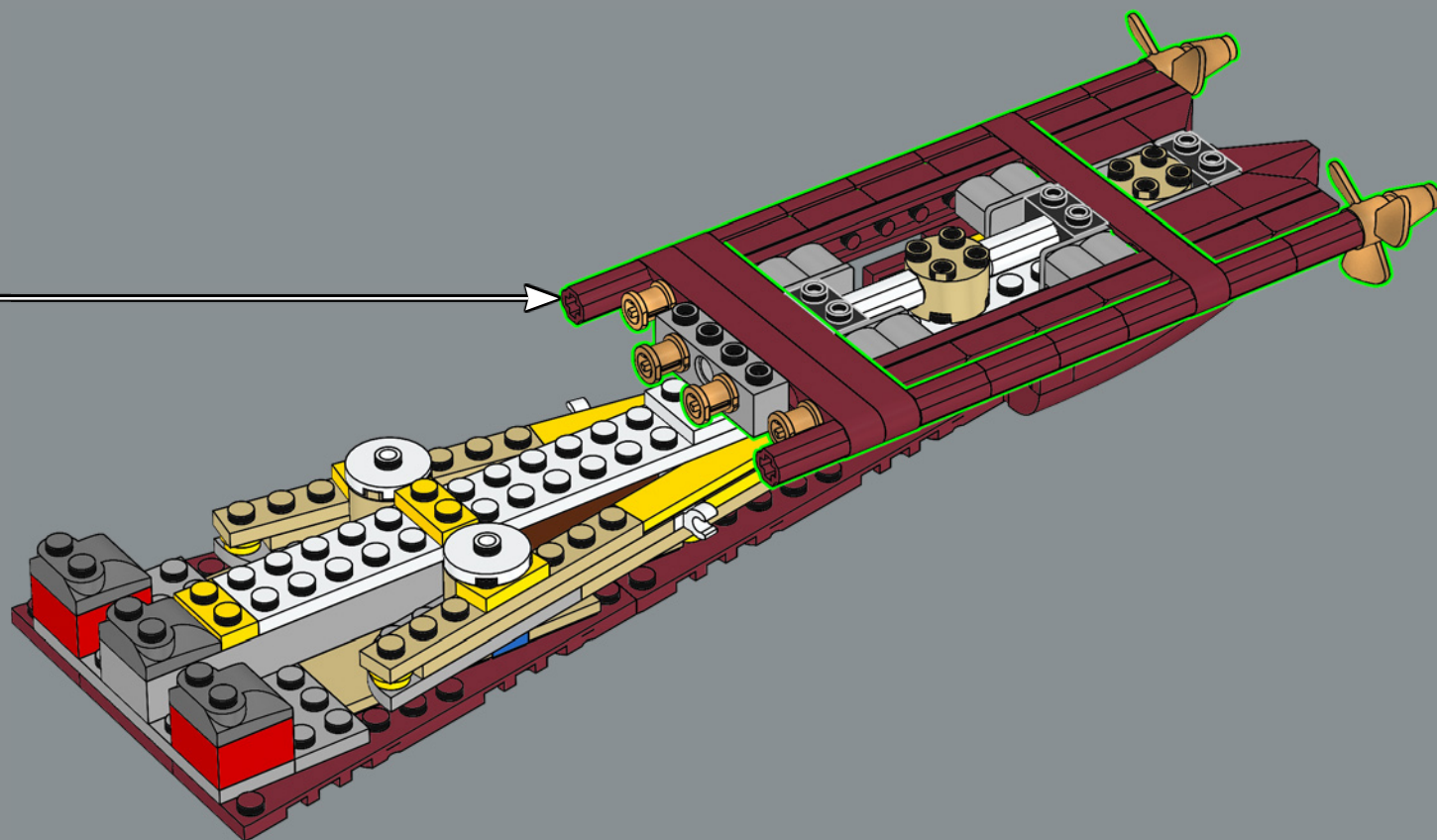

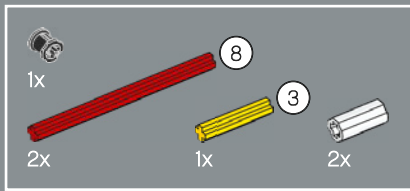

173

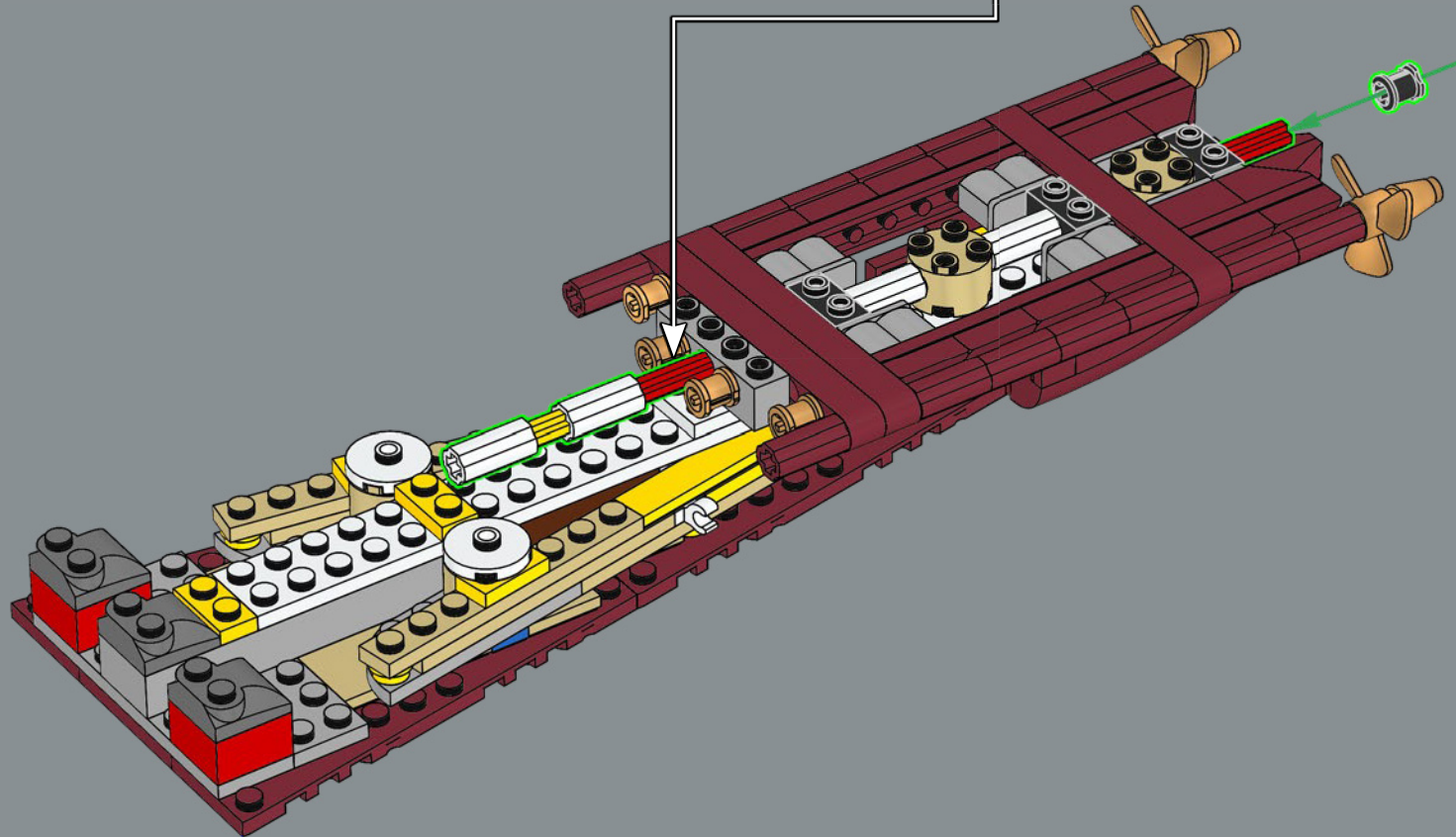
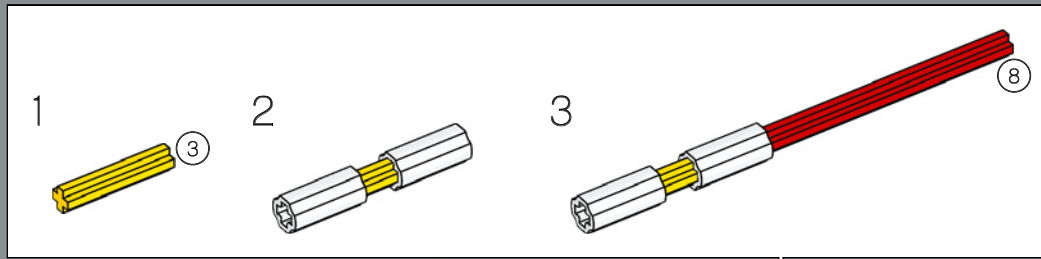

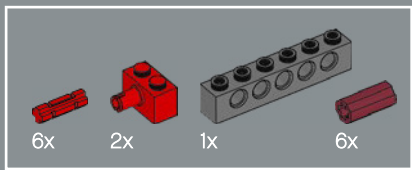

174

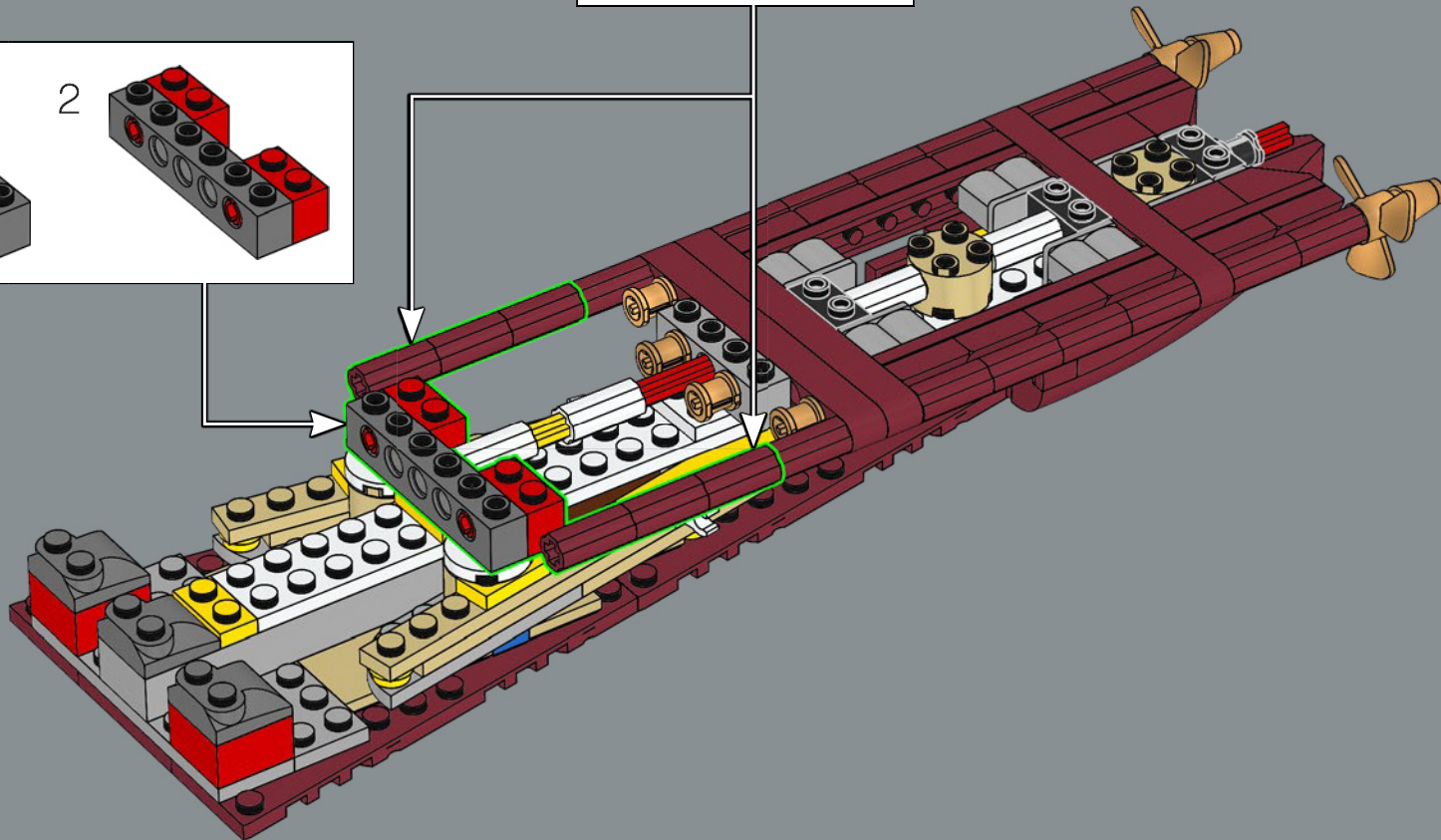
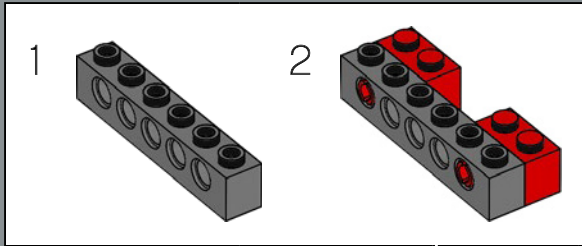
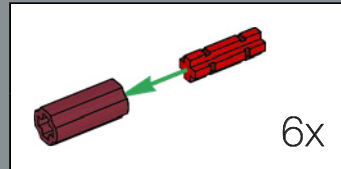

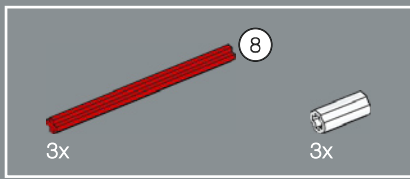

175

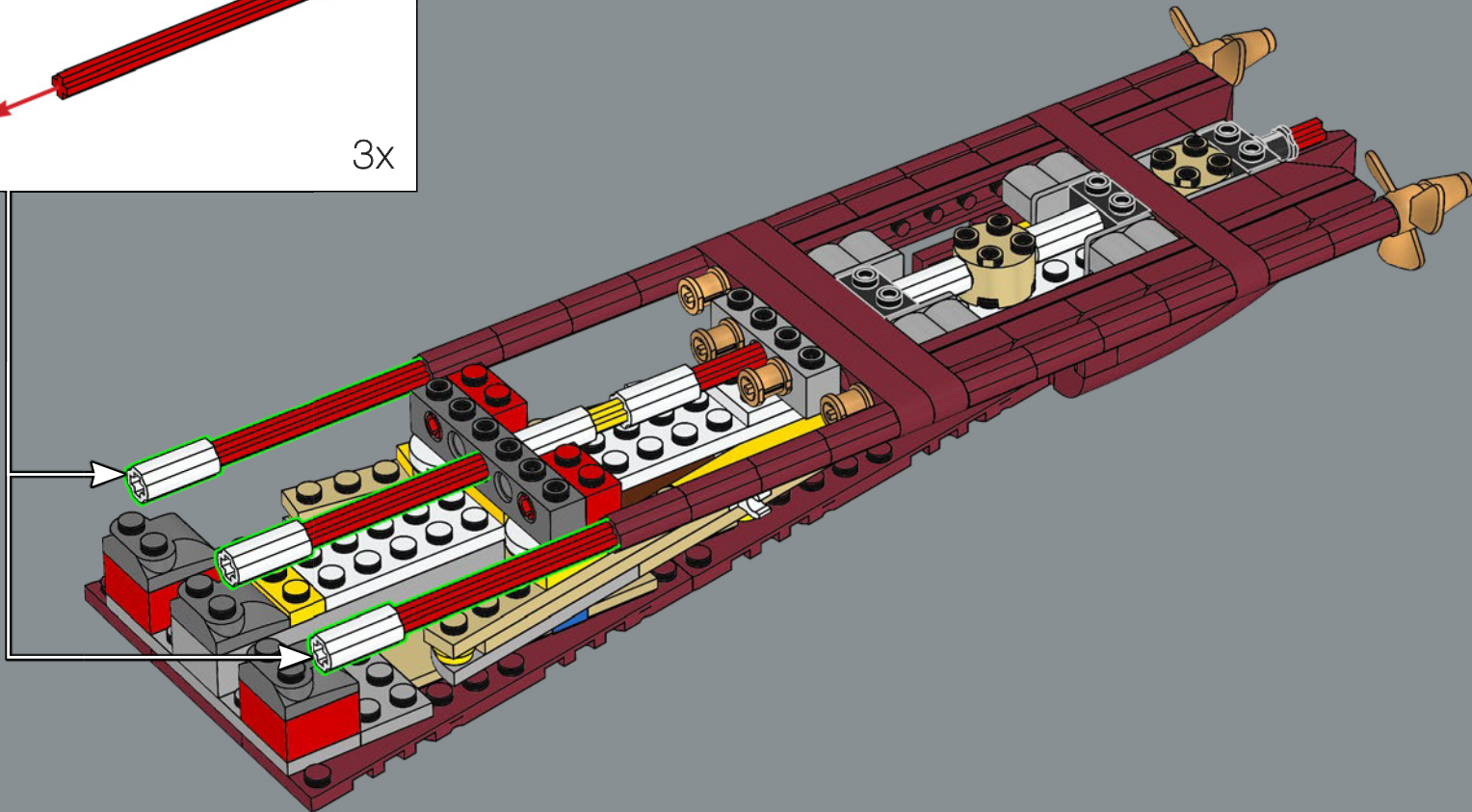
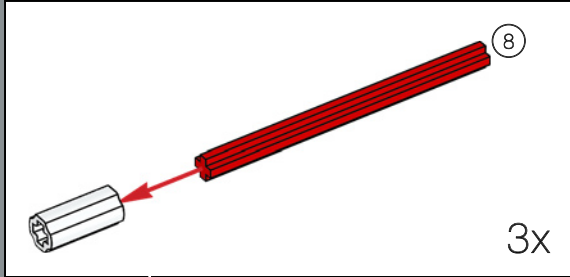

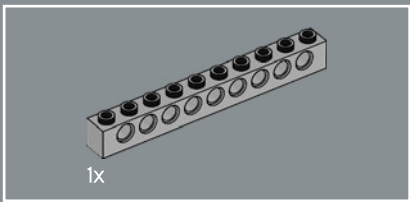

176

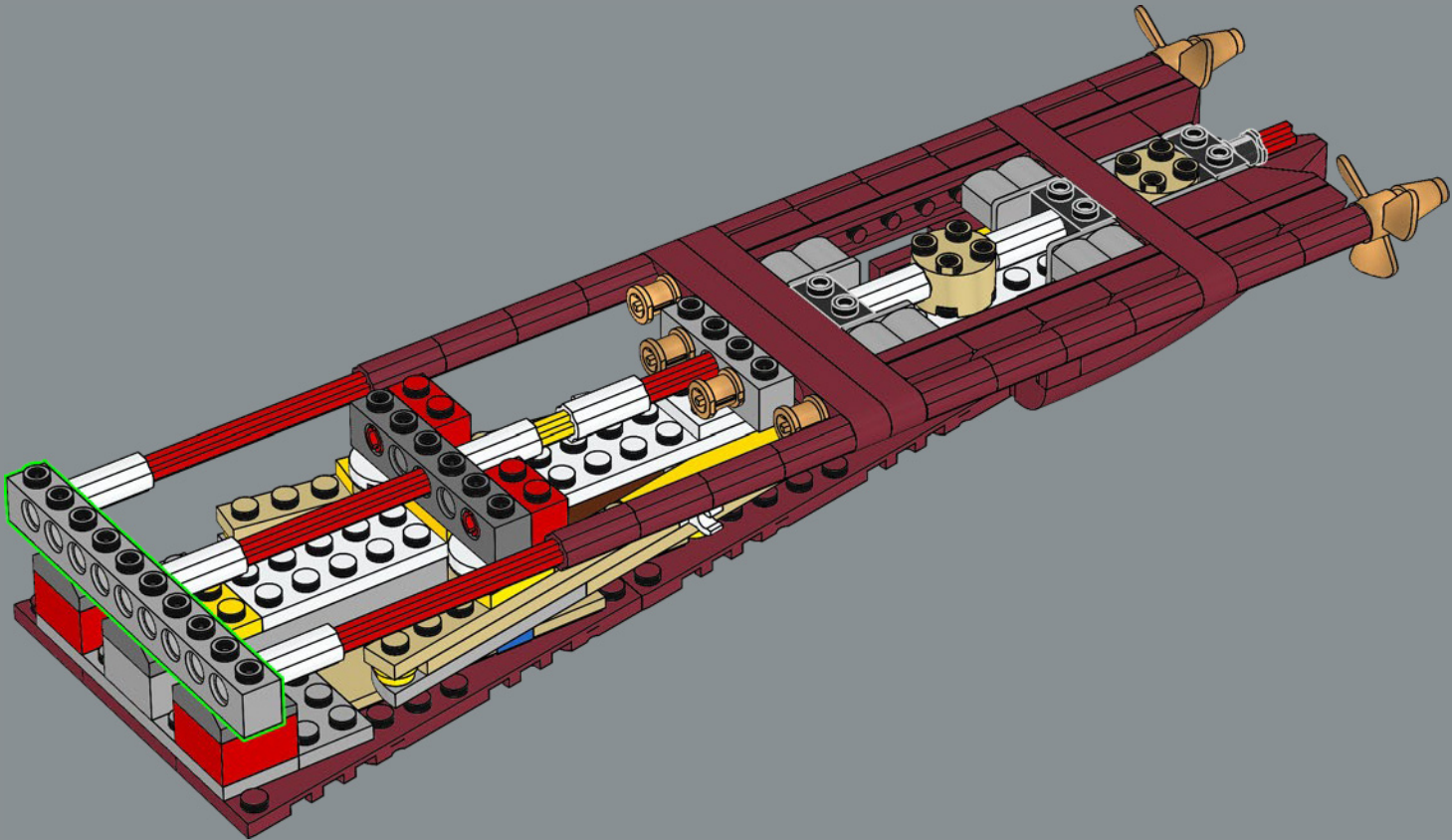

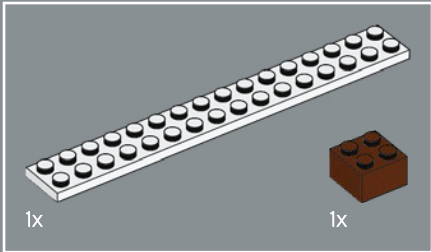
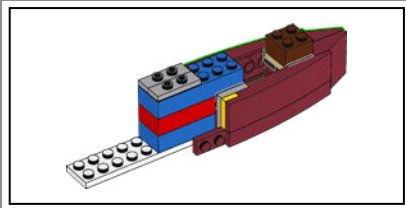
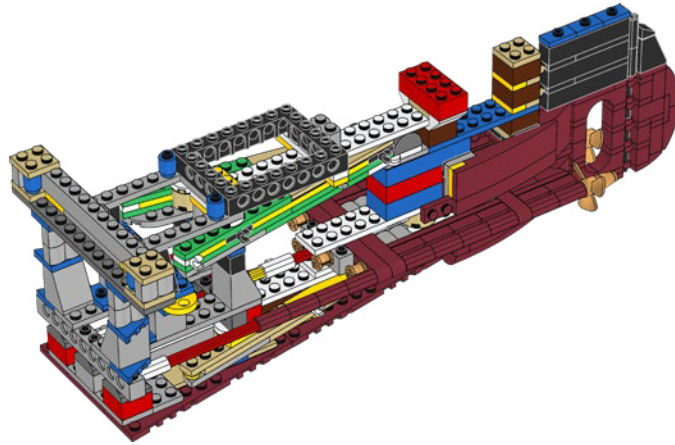
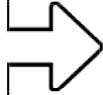

177

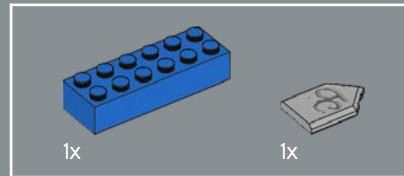
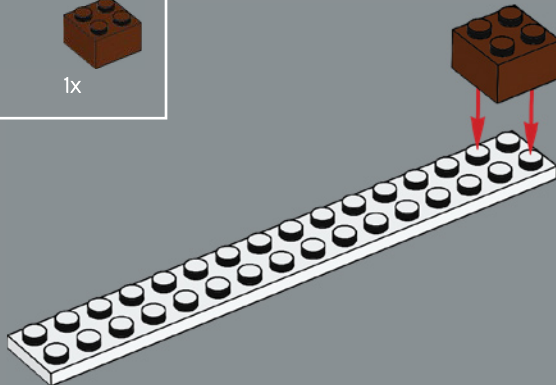

178

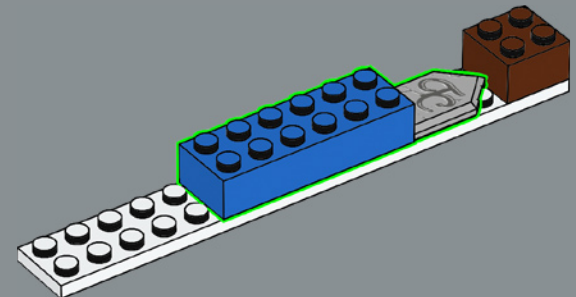



4x

179

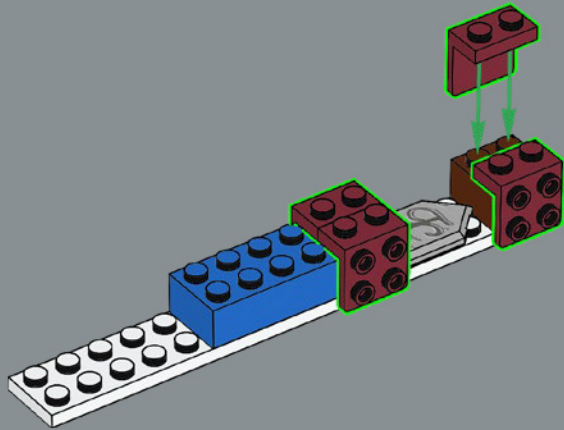

4x

180

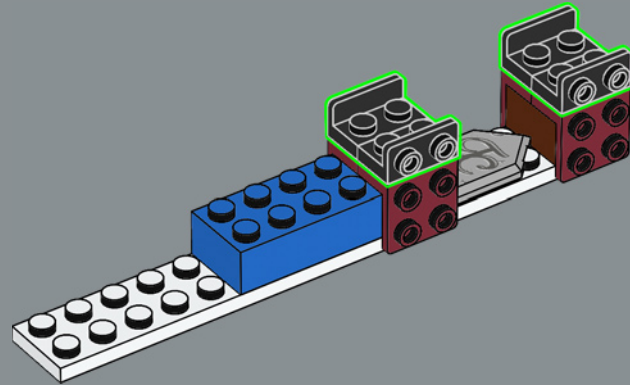



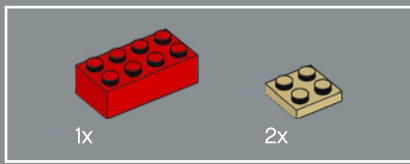

181

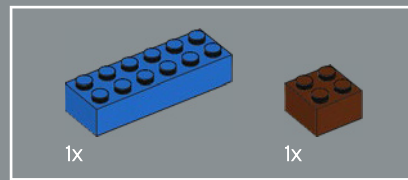
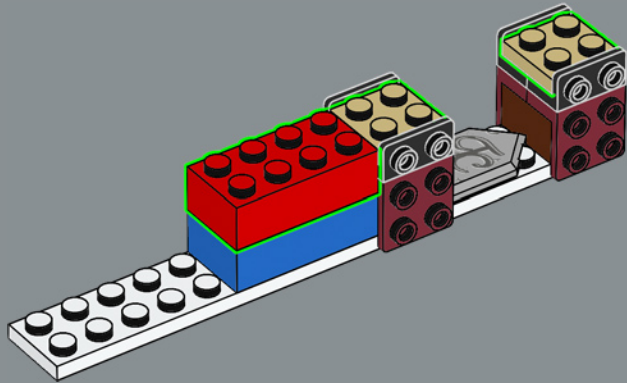

182

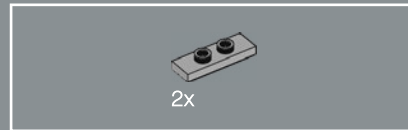
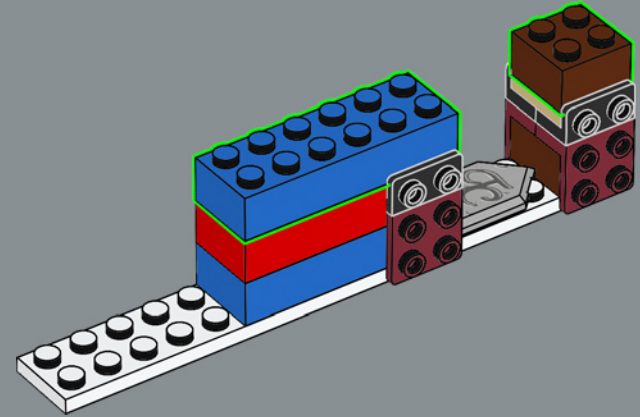

183

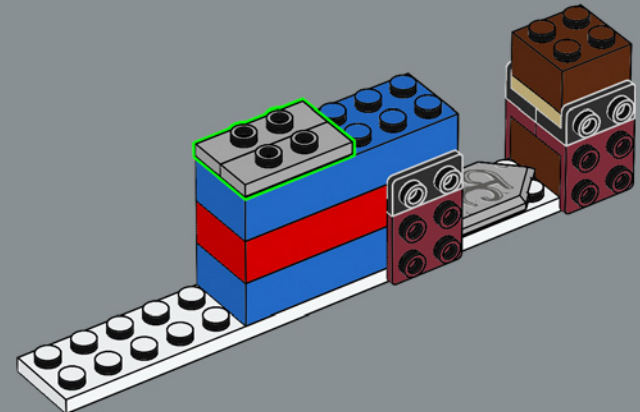

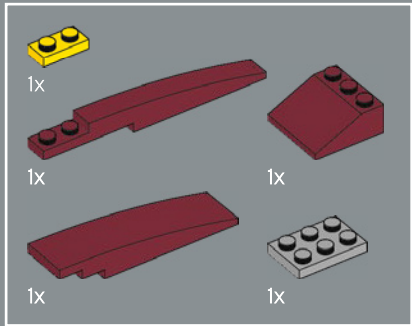

184

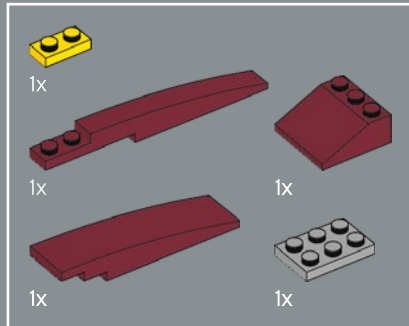
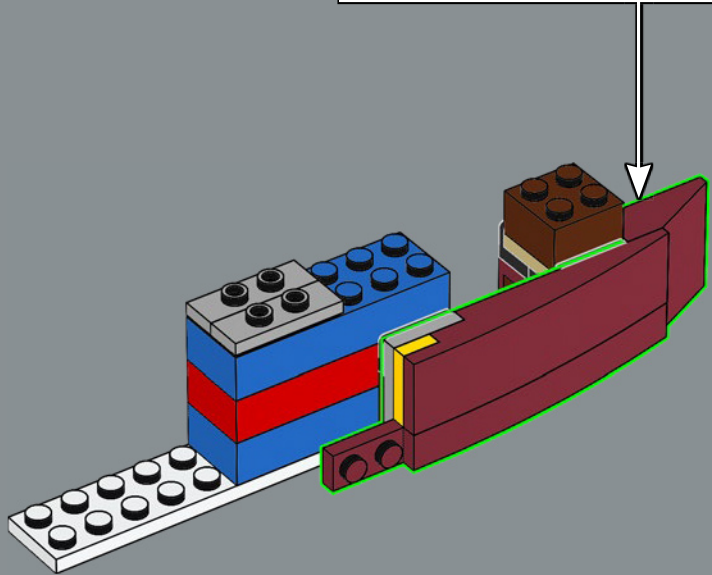
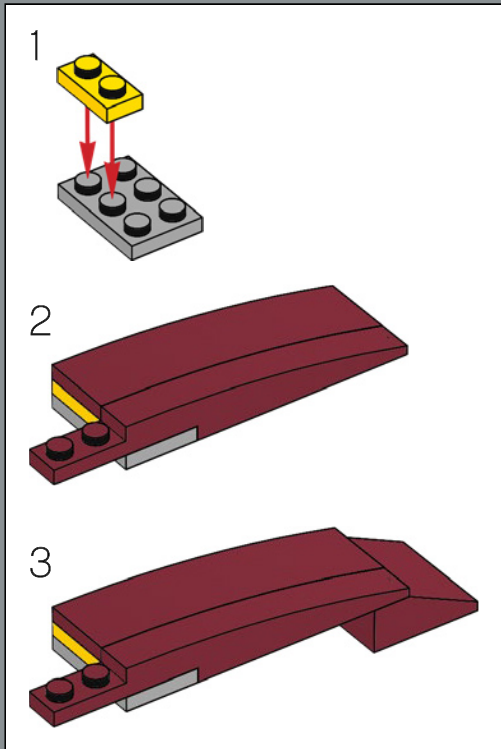

185

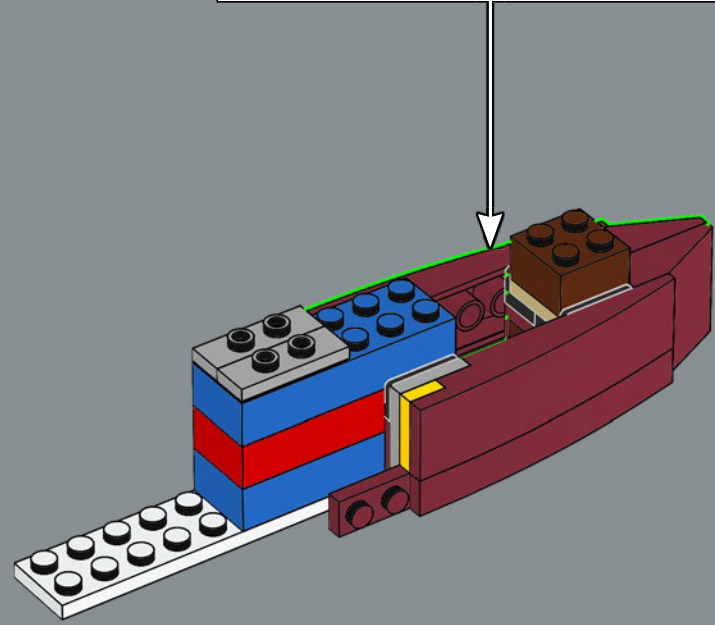
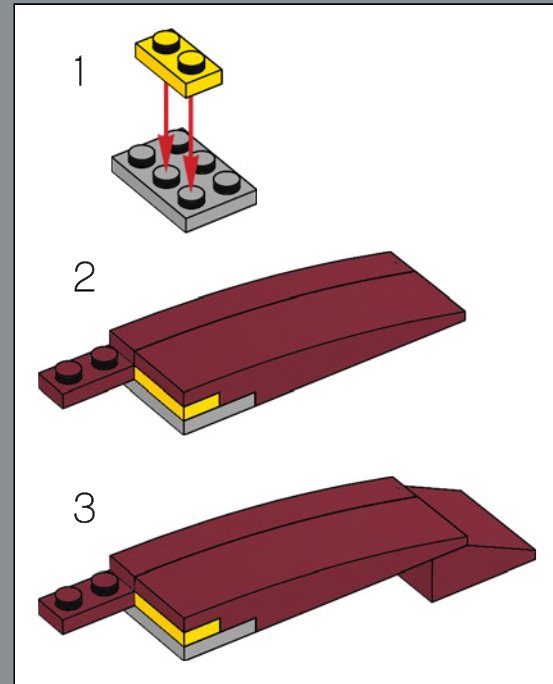



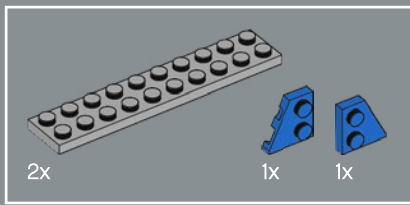

187

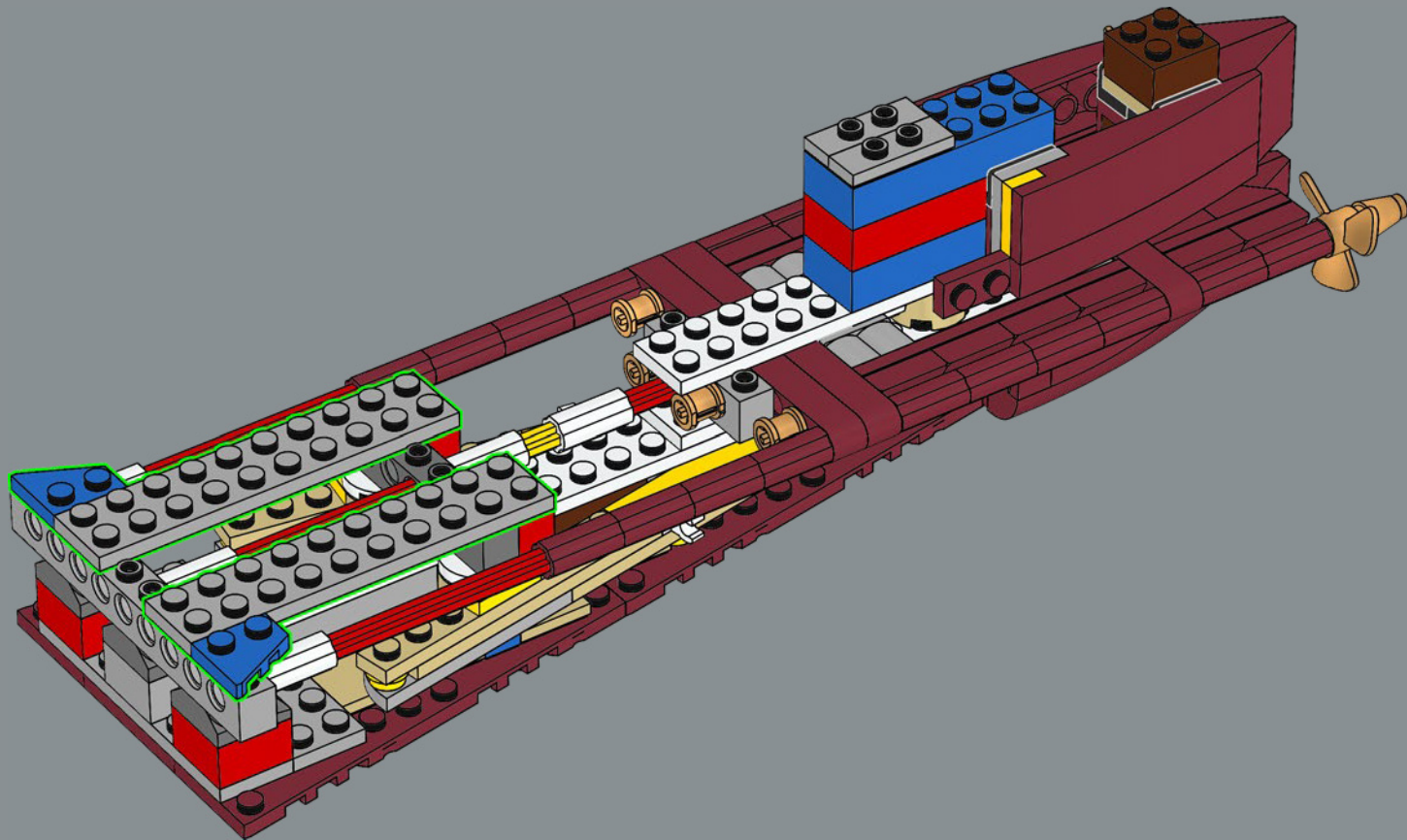

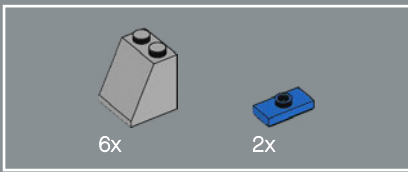

188

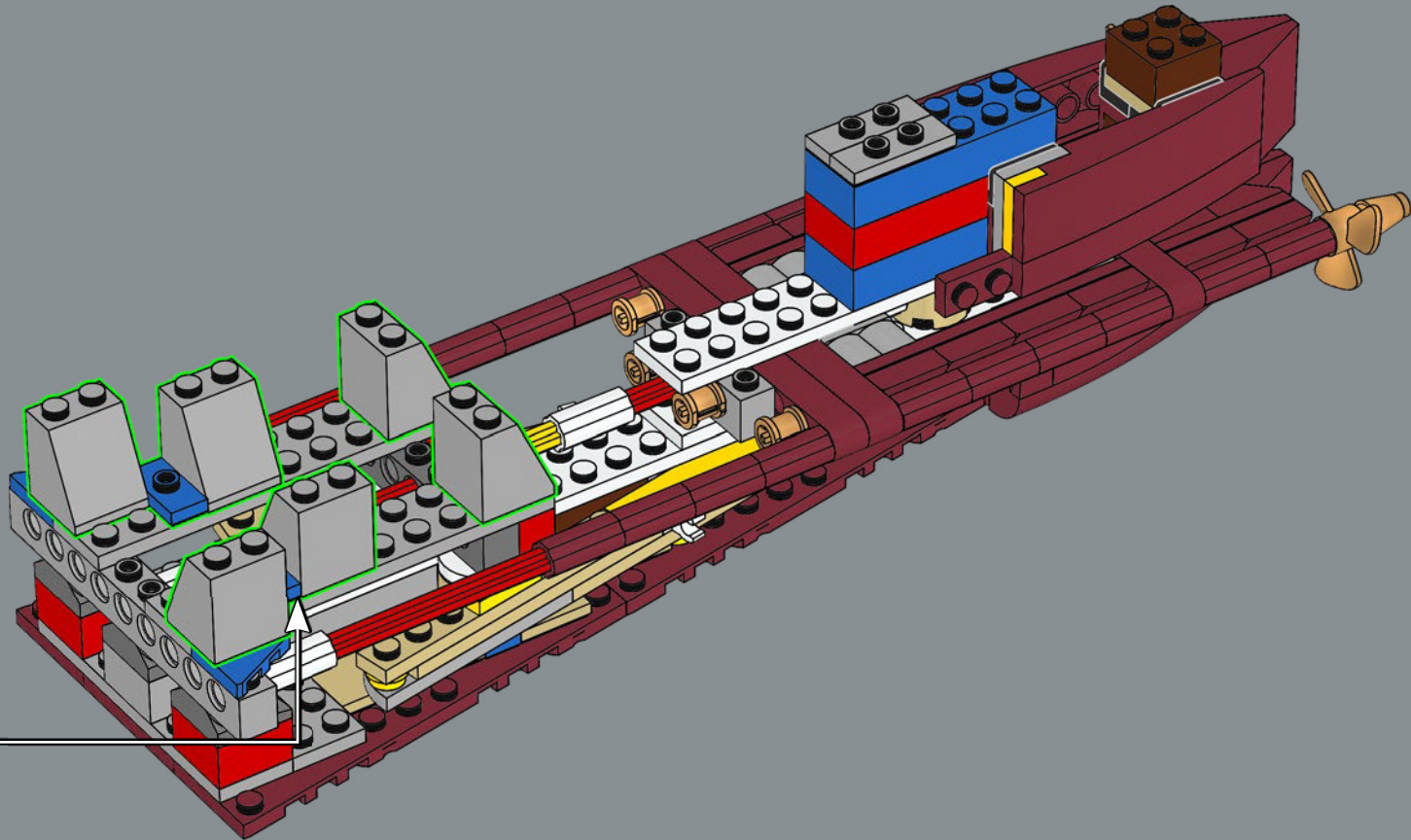

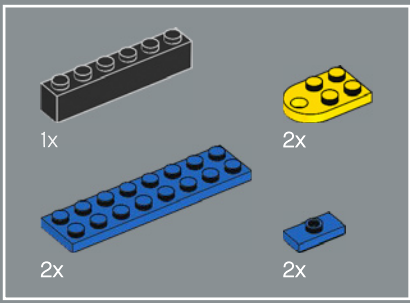

189

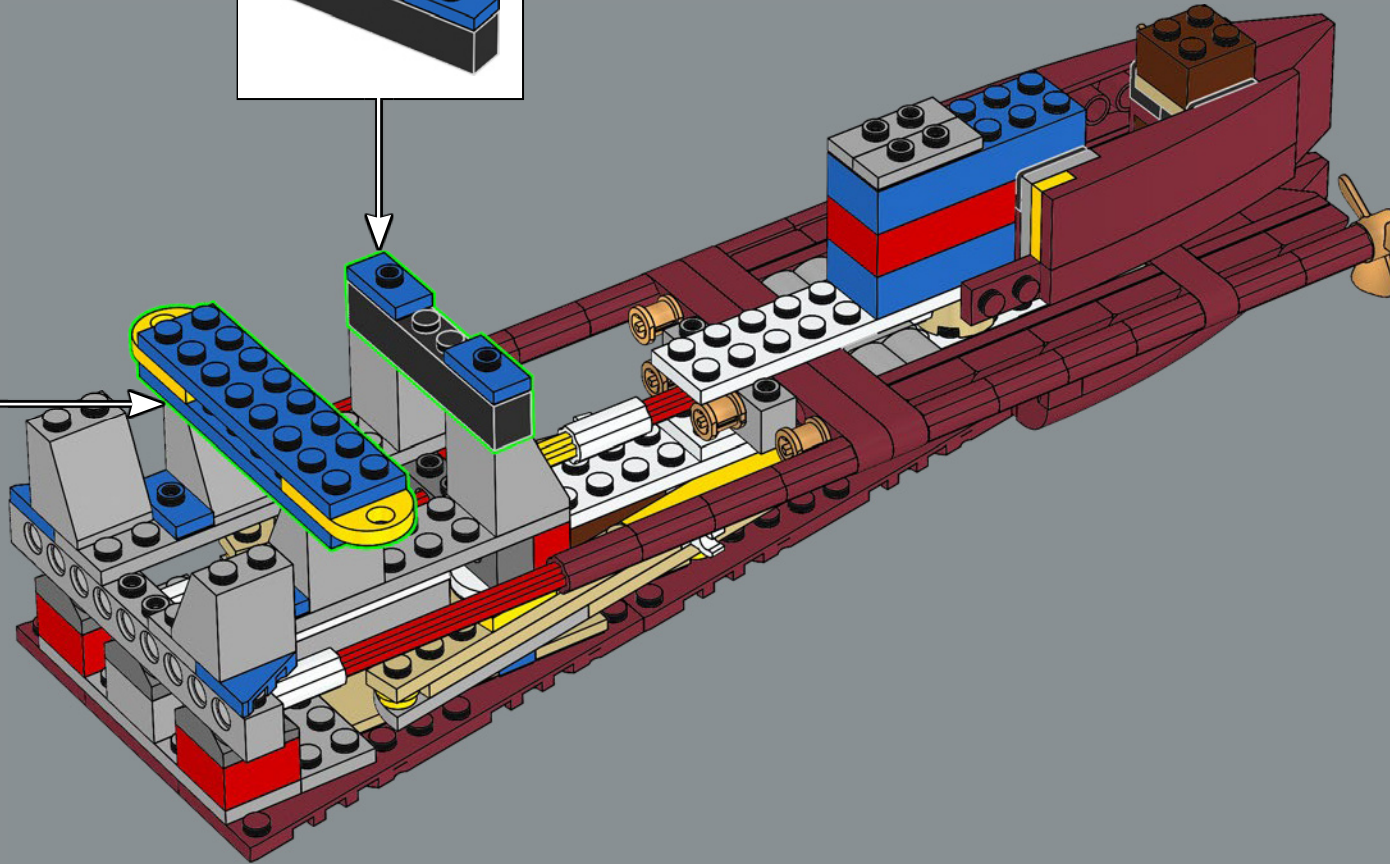
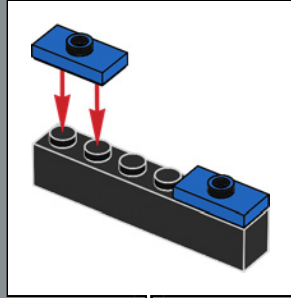
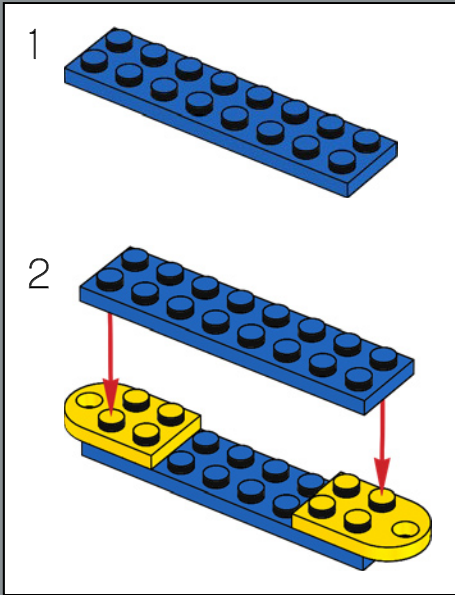

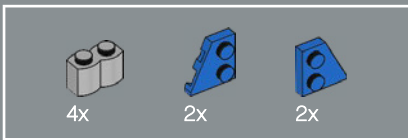

190

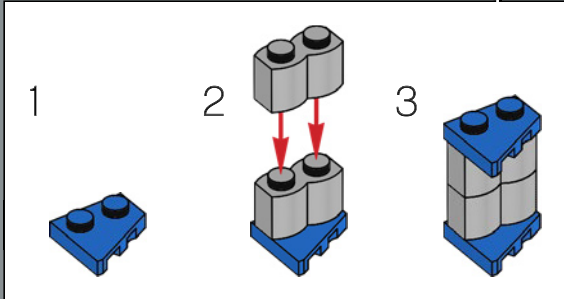
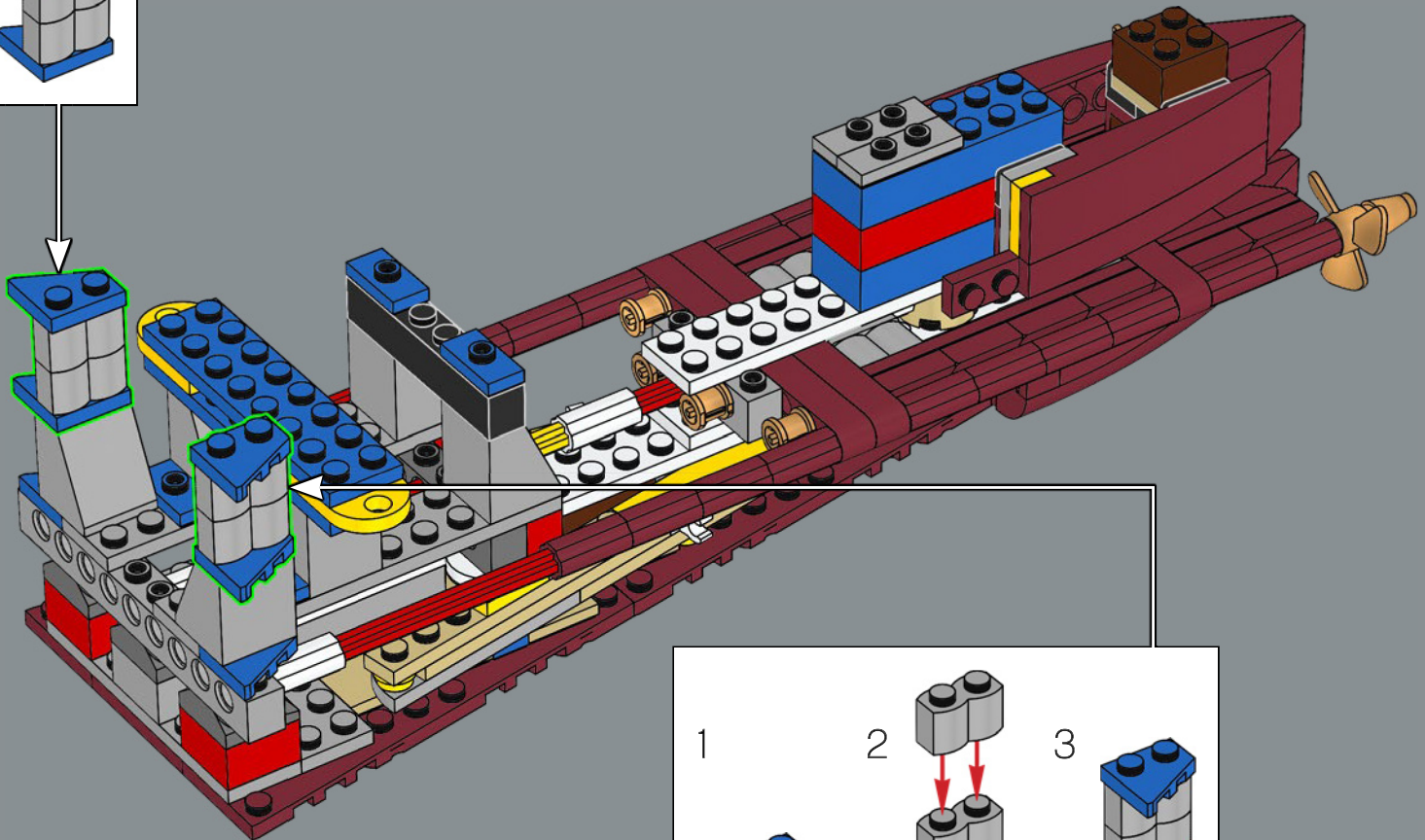
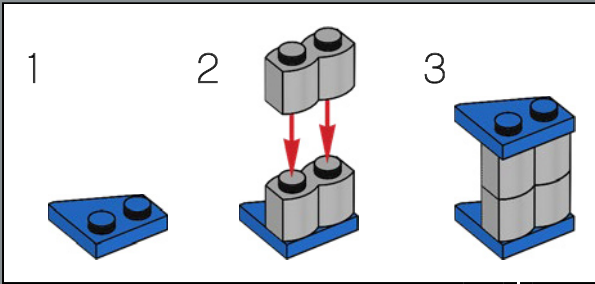

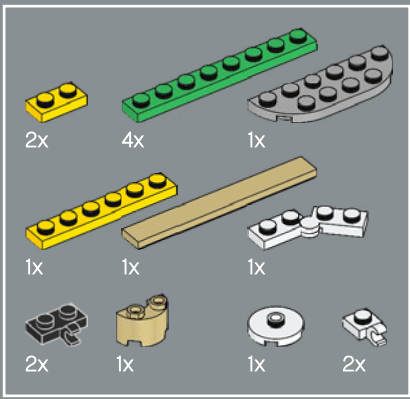

191

1



2

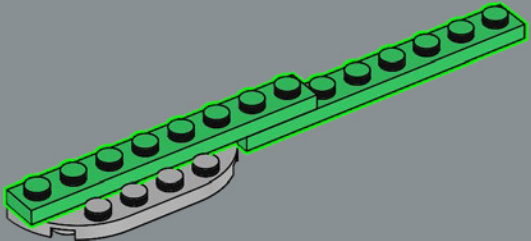

3

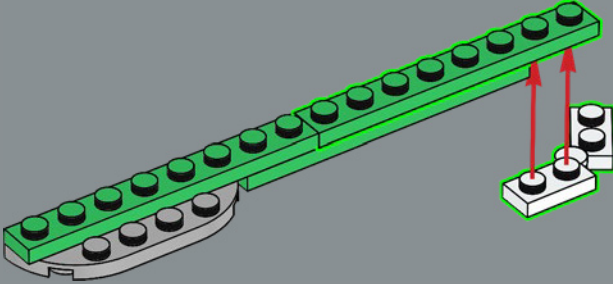

4

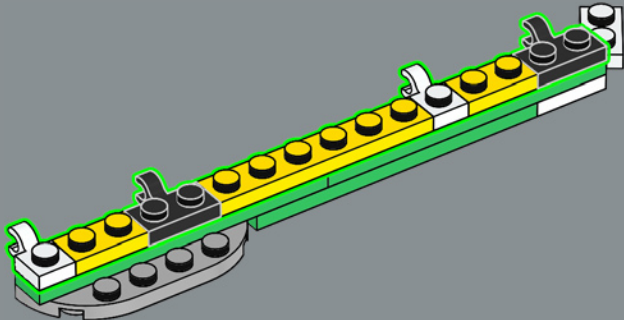

5

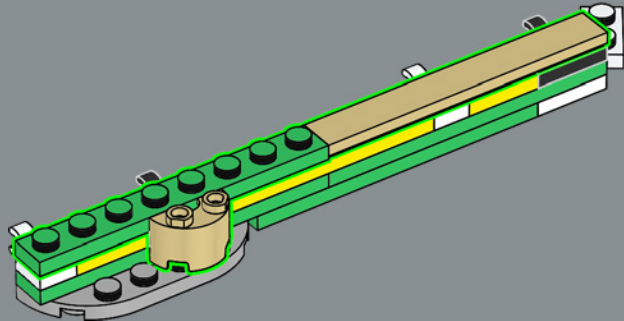

6

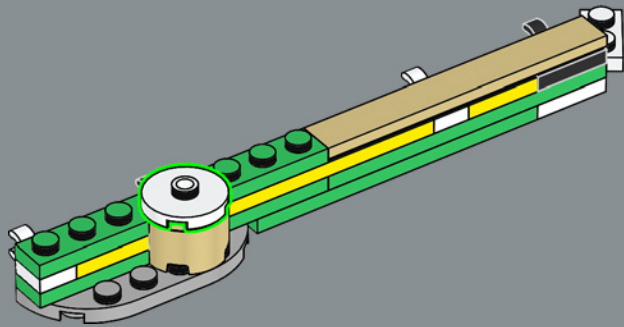



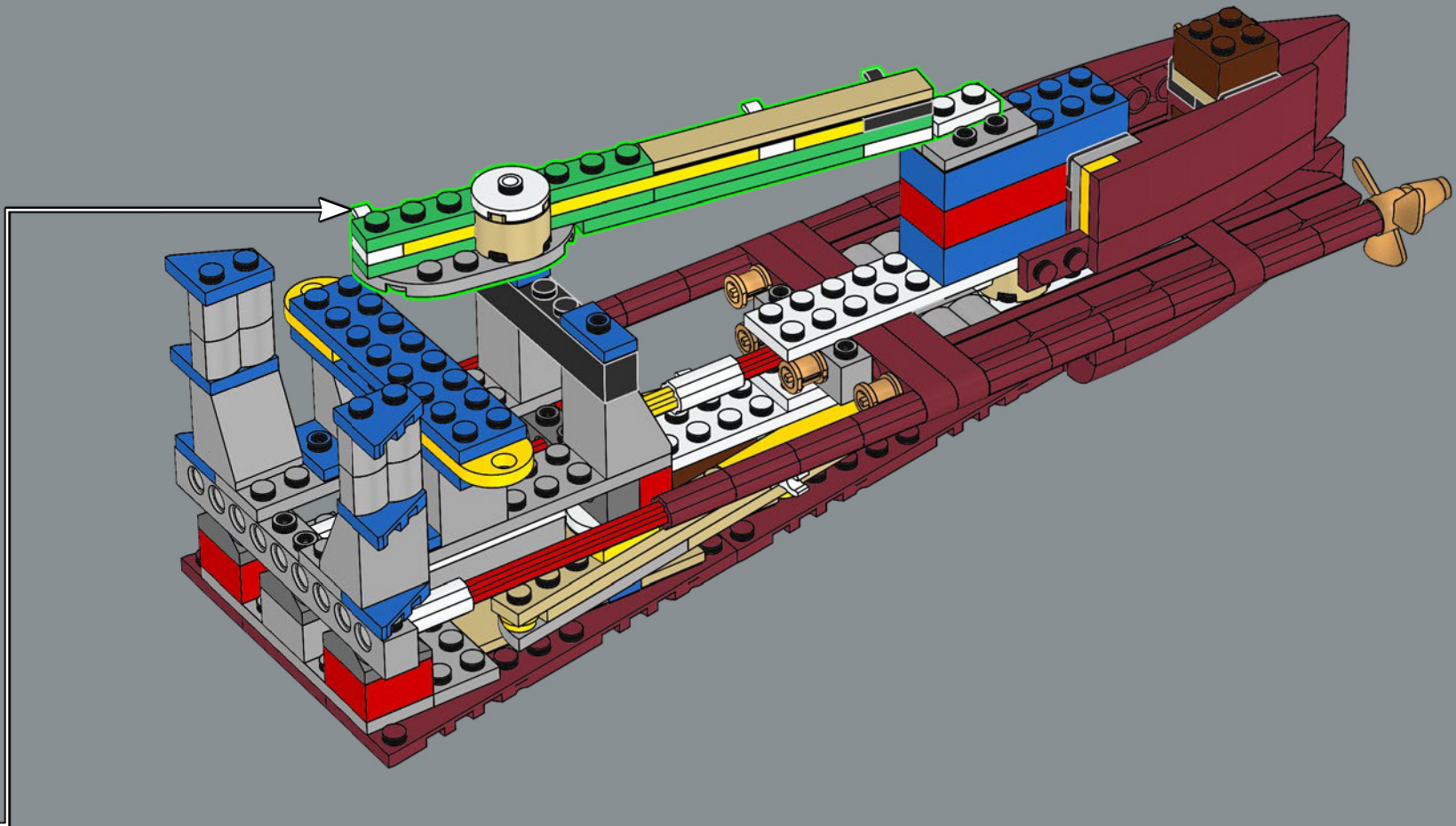

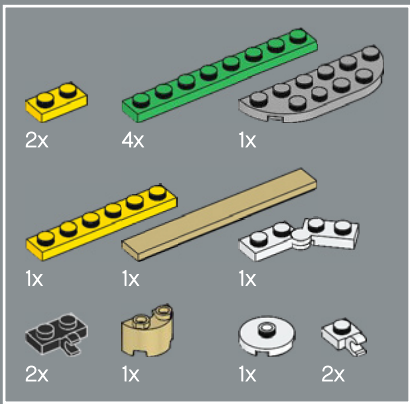

192

1

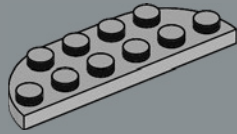

2

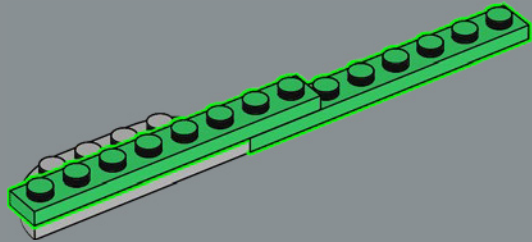

3

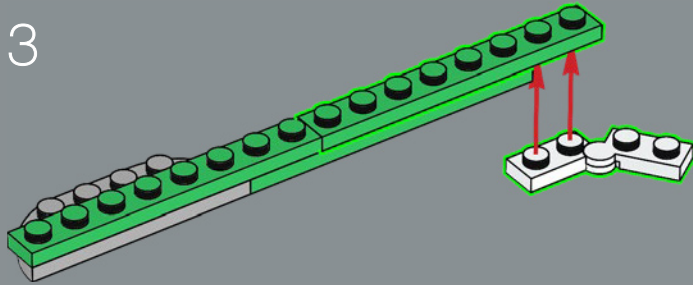

4

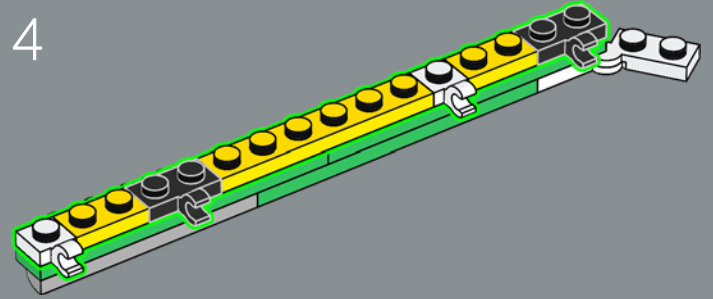

5

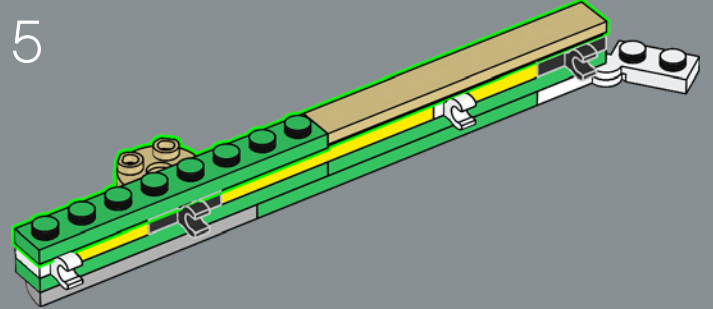

6

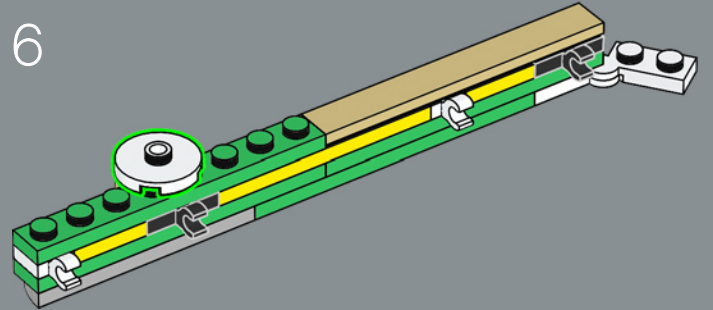

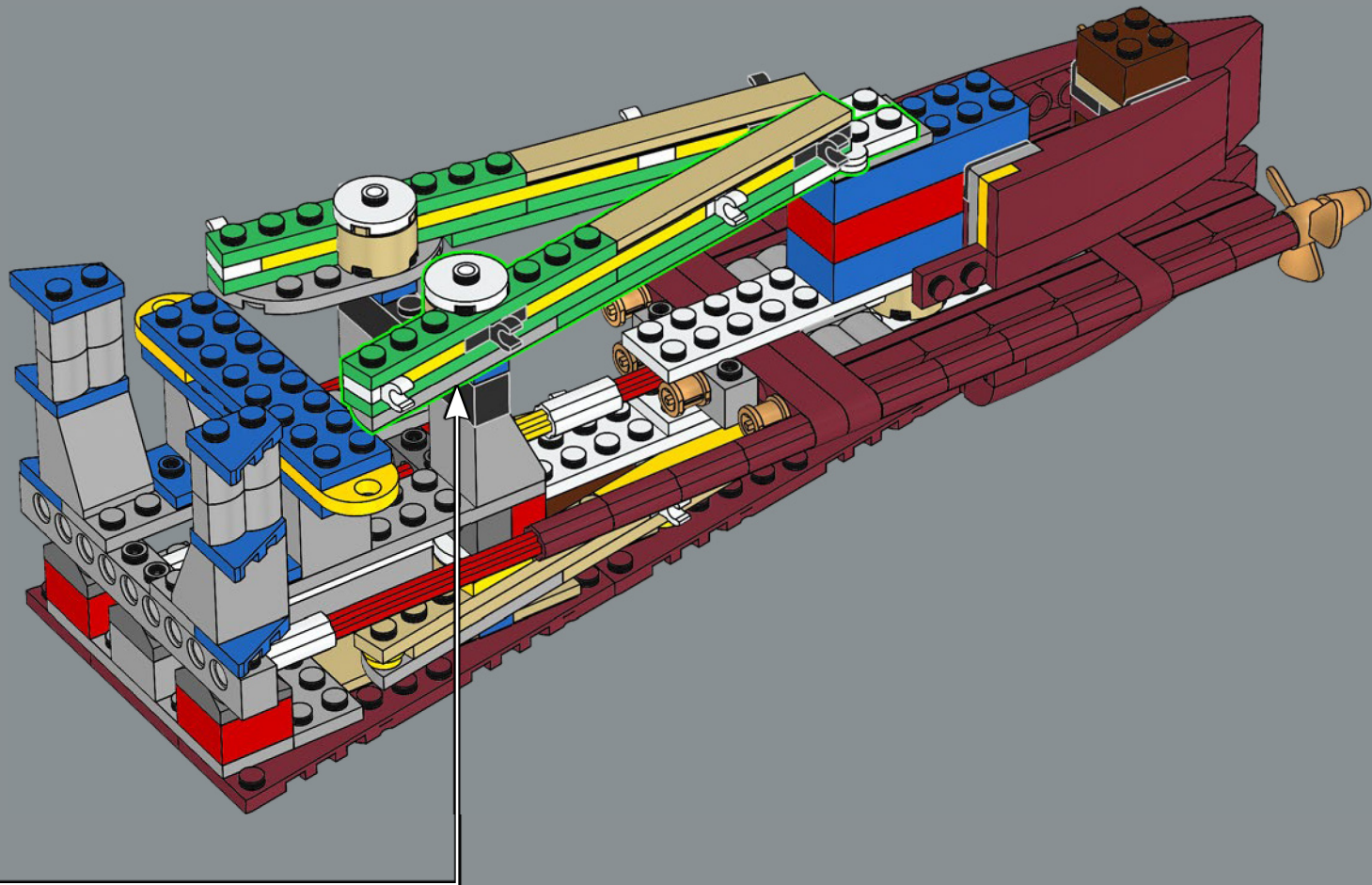

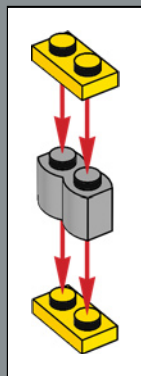
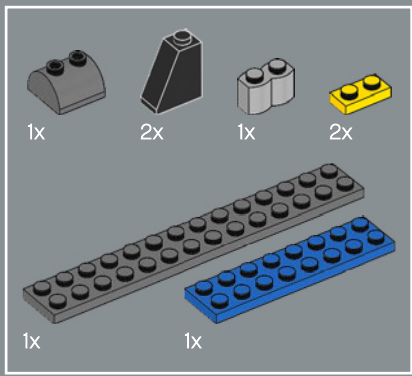

193

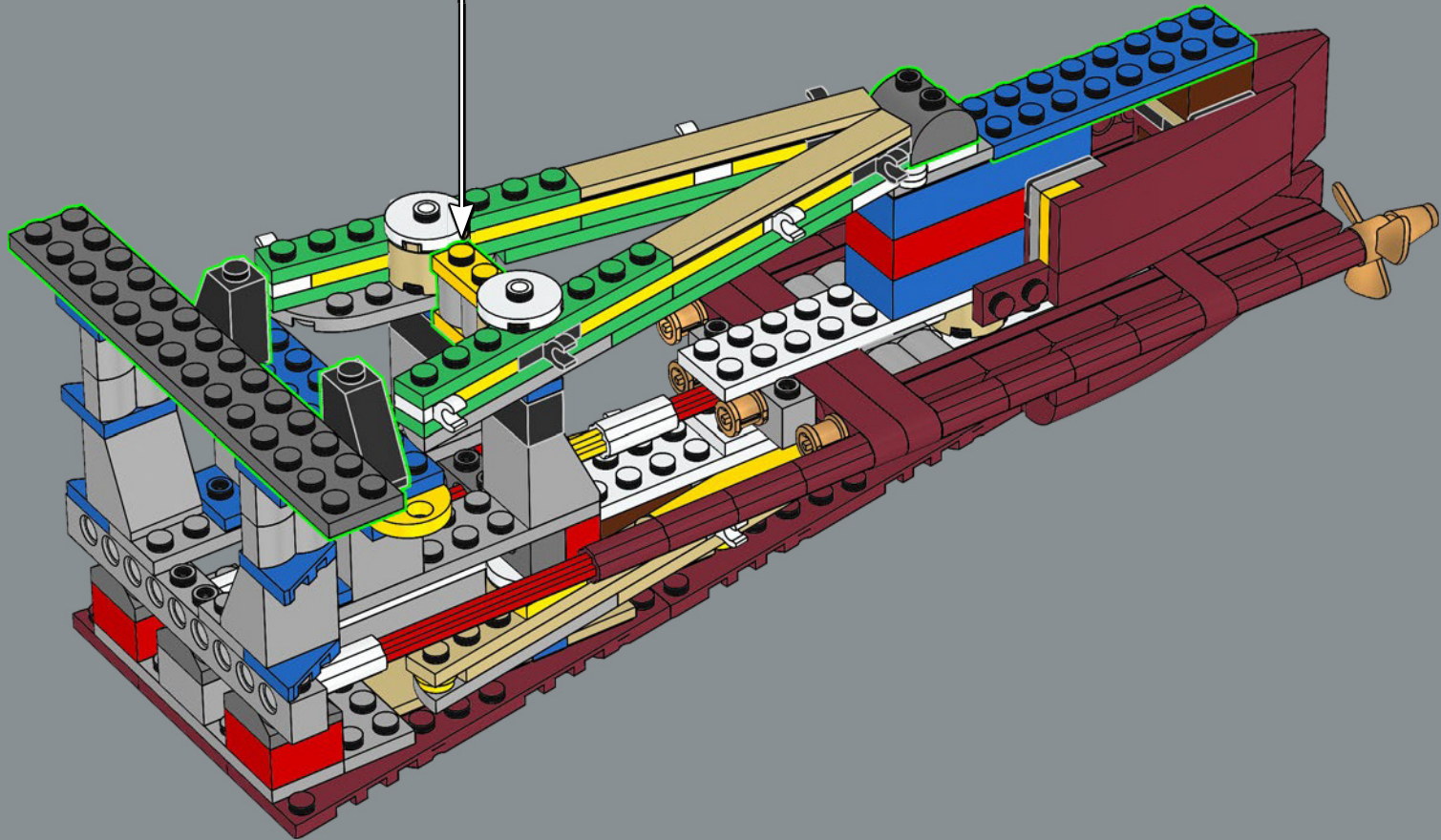

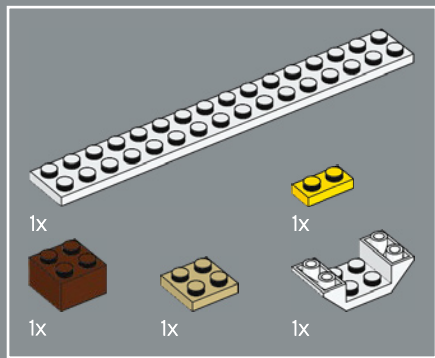

194

1

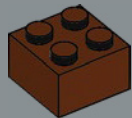

2

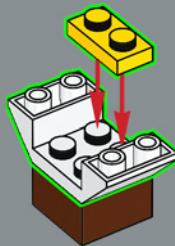

3

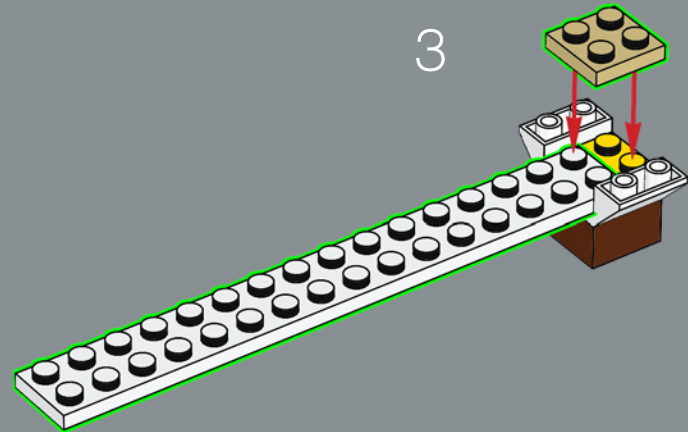

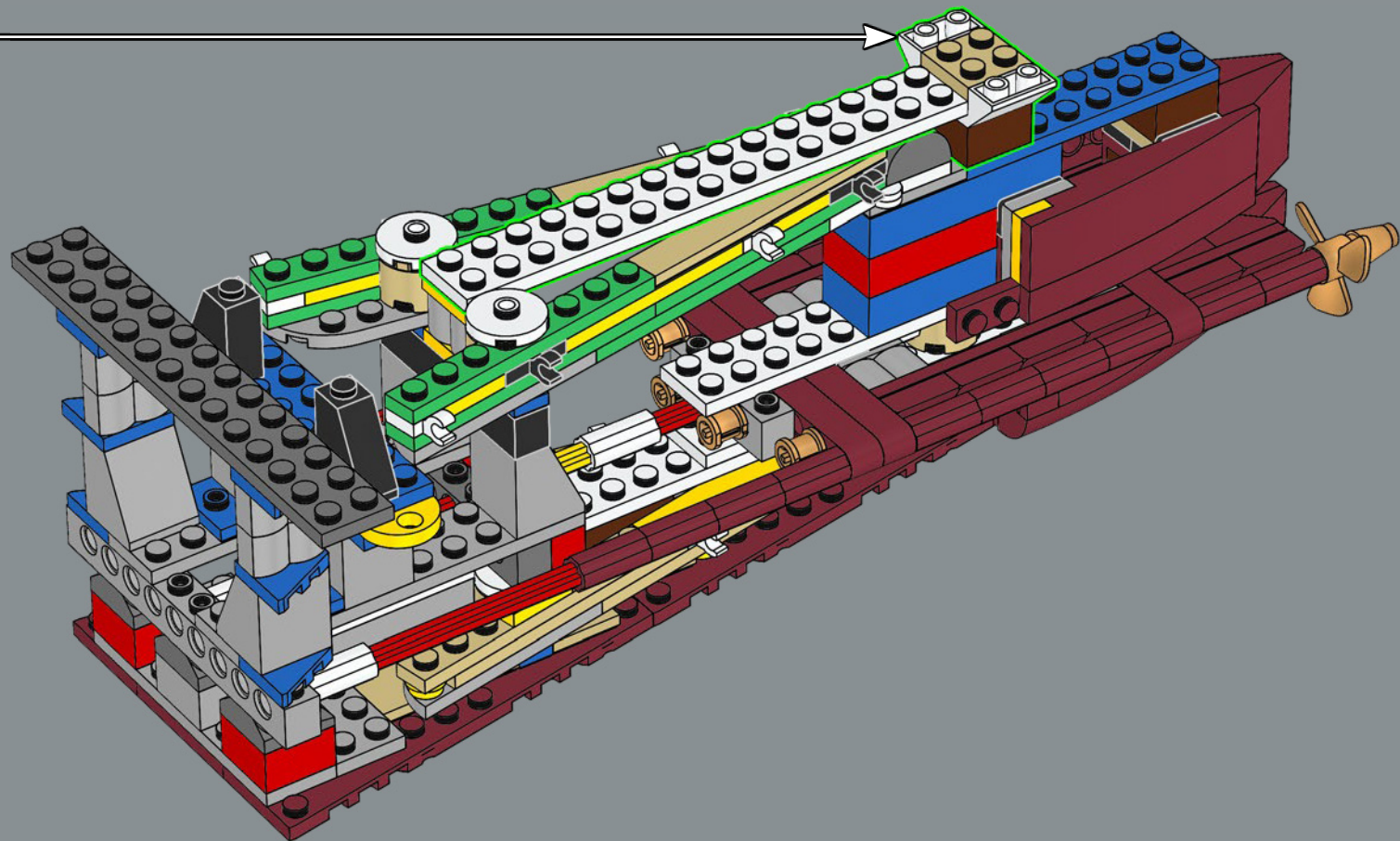

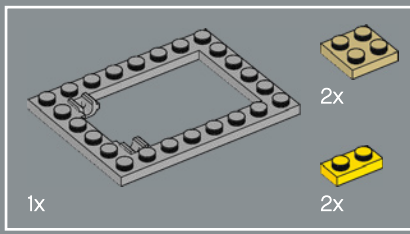

195

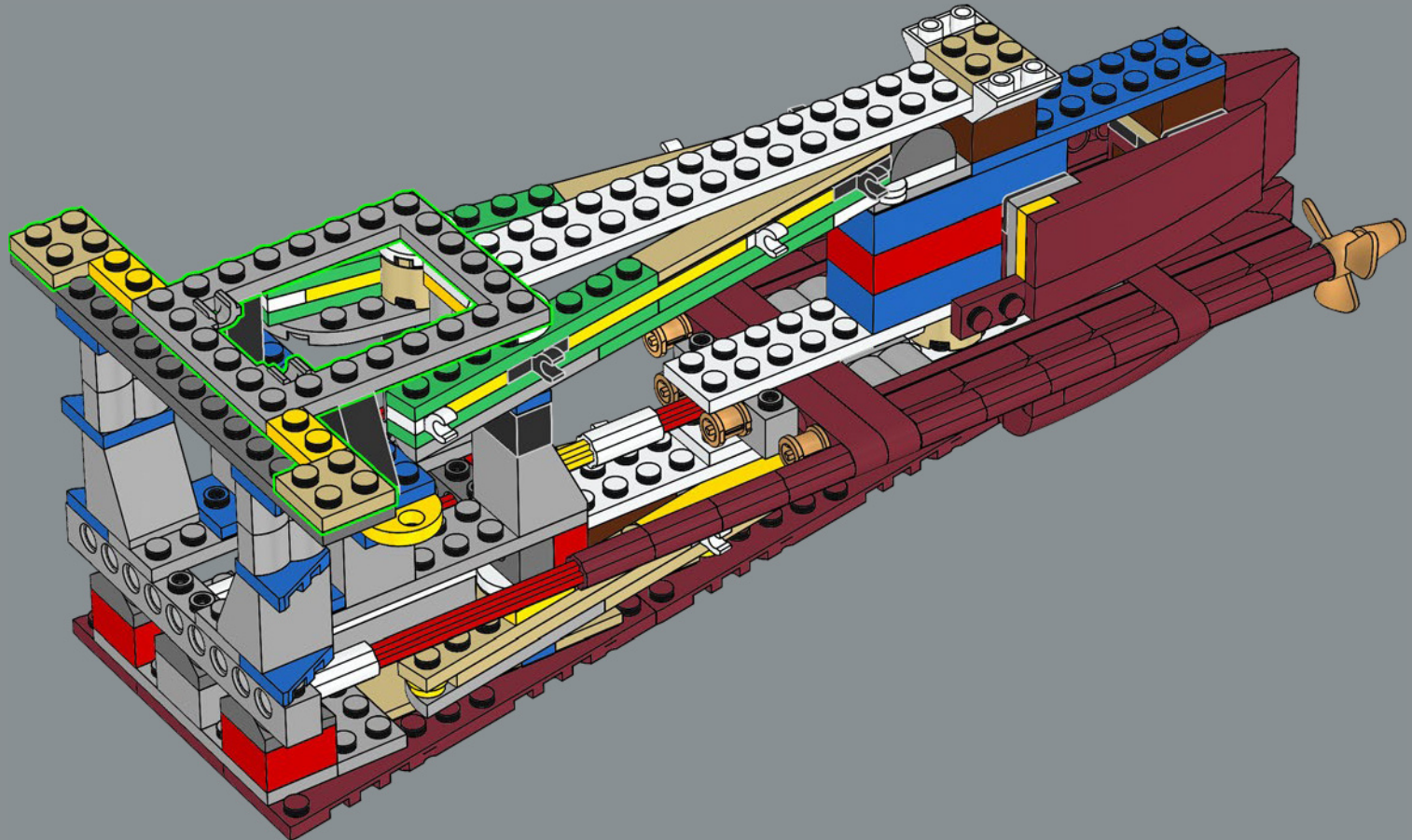





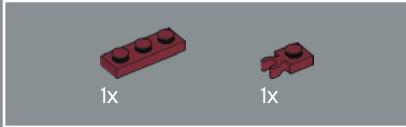
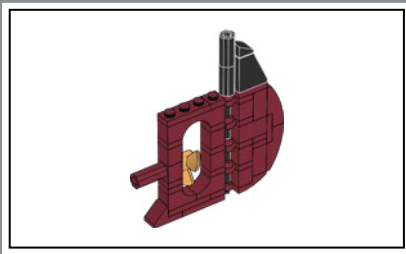

197

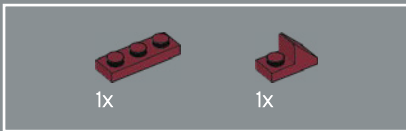
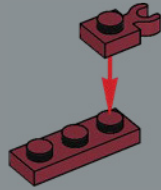

198

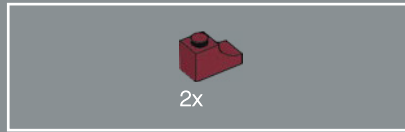
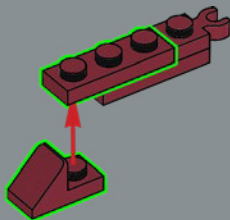

199

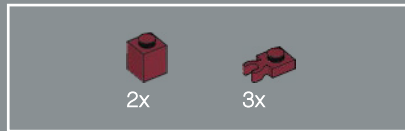
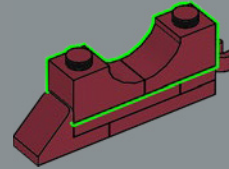

200

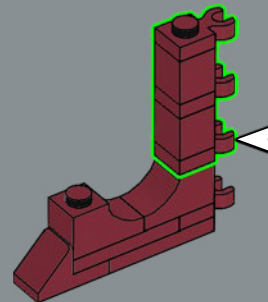
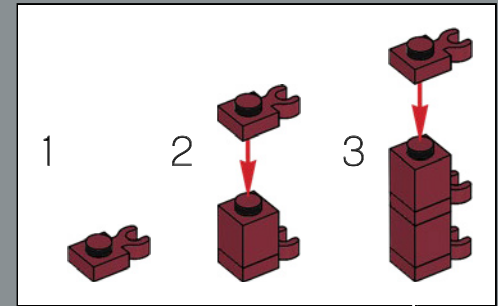

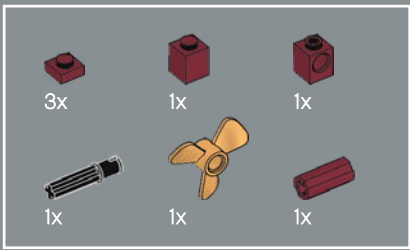

201

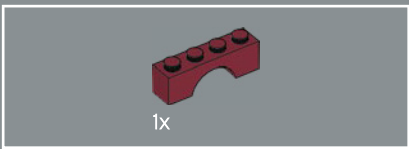
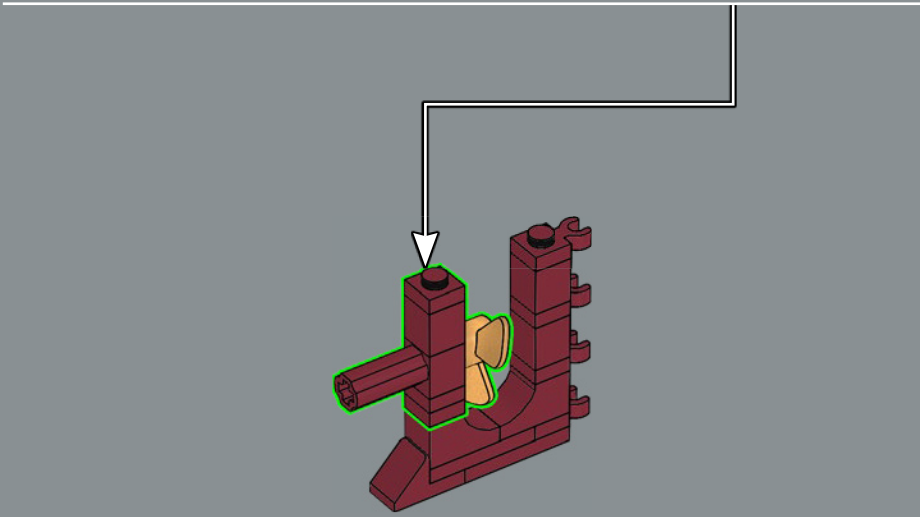
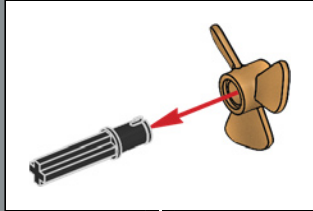
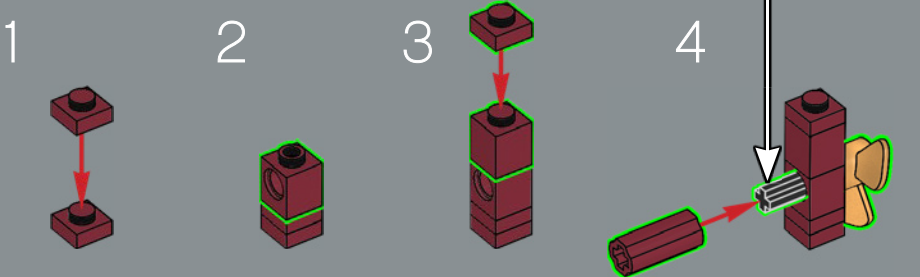

202

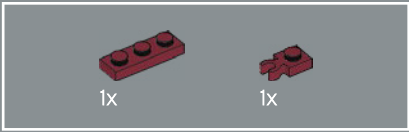
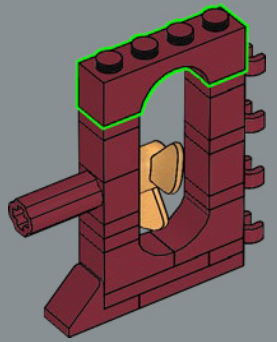

203

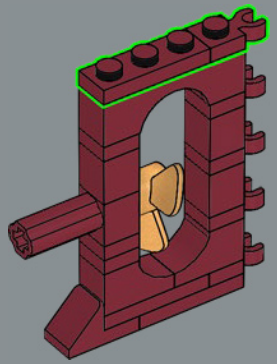

204

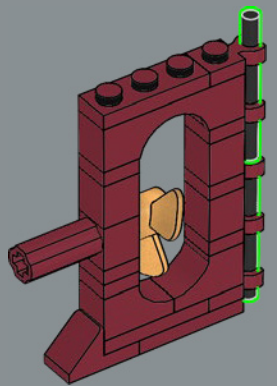

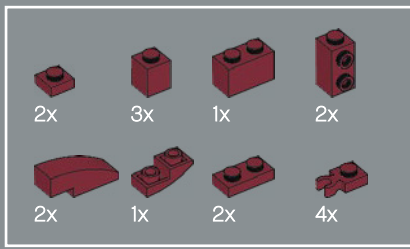

205

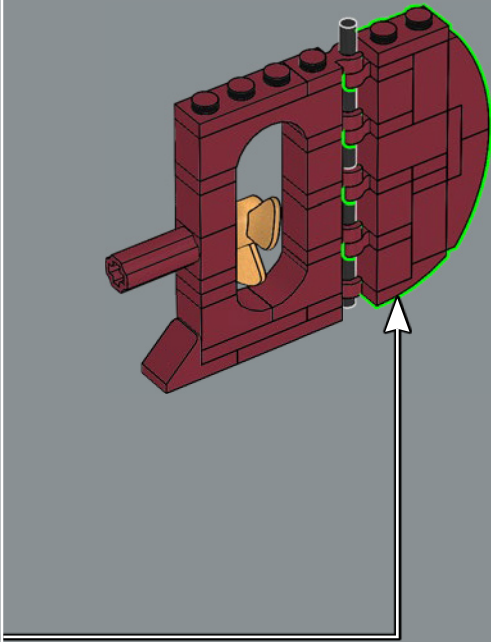
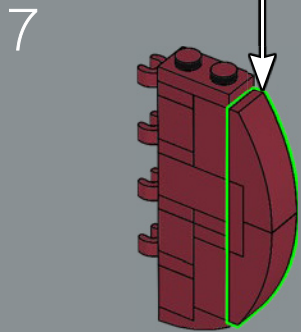
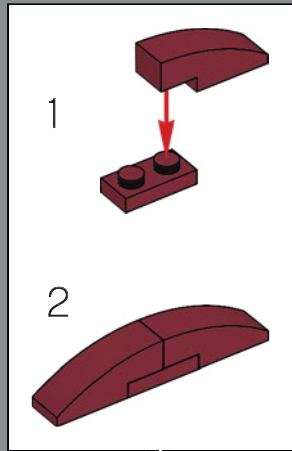
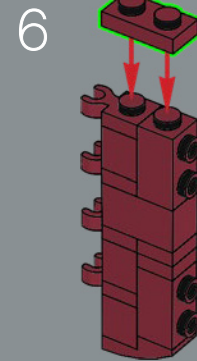
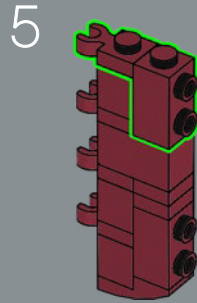
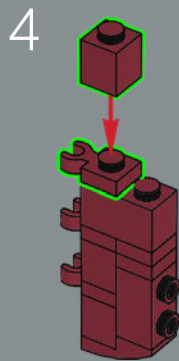
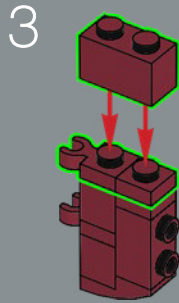
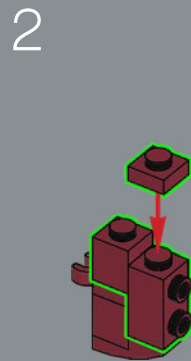
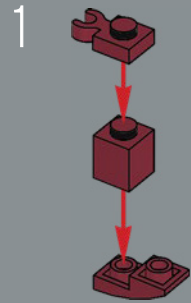

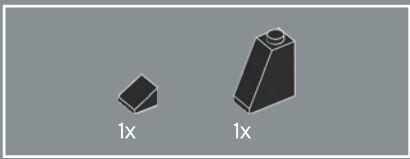

206

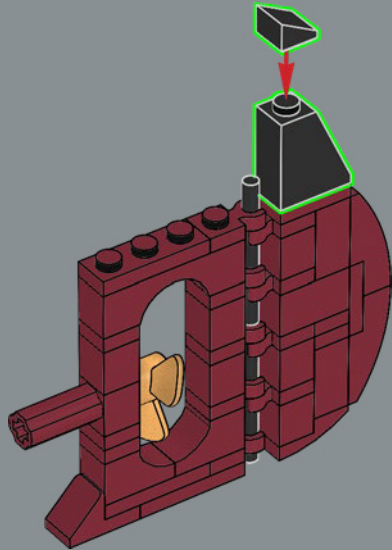

207

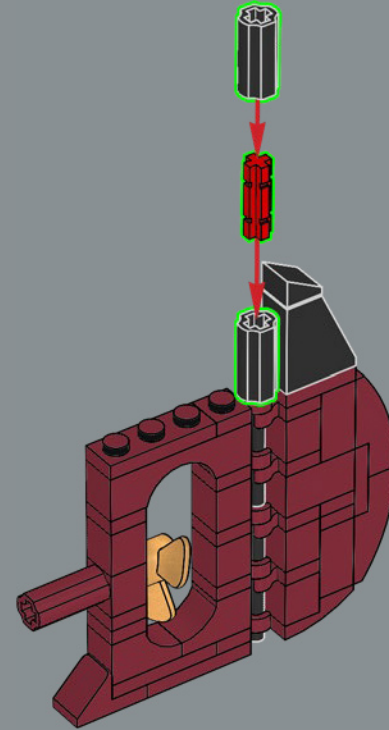

Vu ses dimensions imposantes, soit 24 m de haut et 4,65 m de large, ainsi que son poids de plus de 100 tonnes, le gouvernail doit être dirigé à l'aide de moteurs de direction.

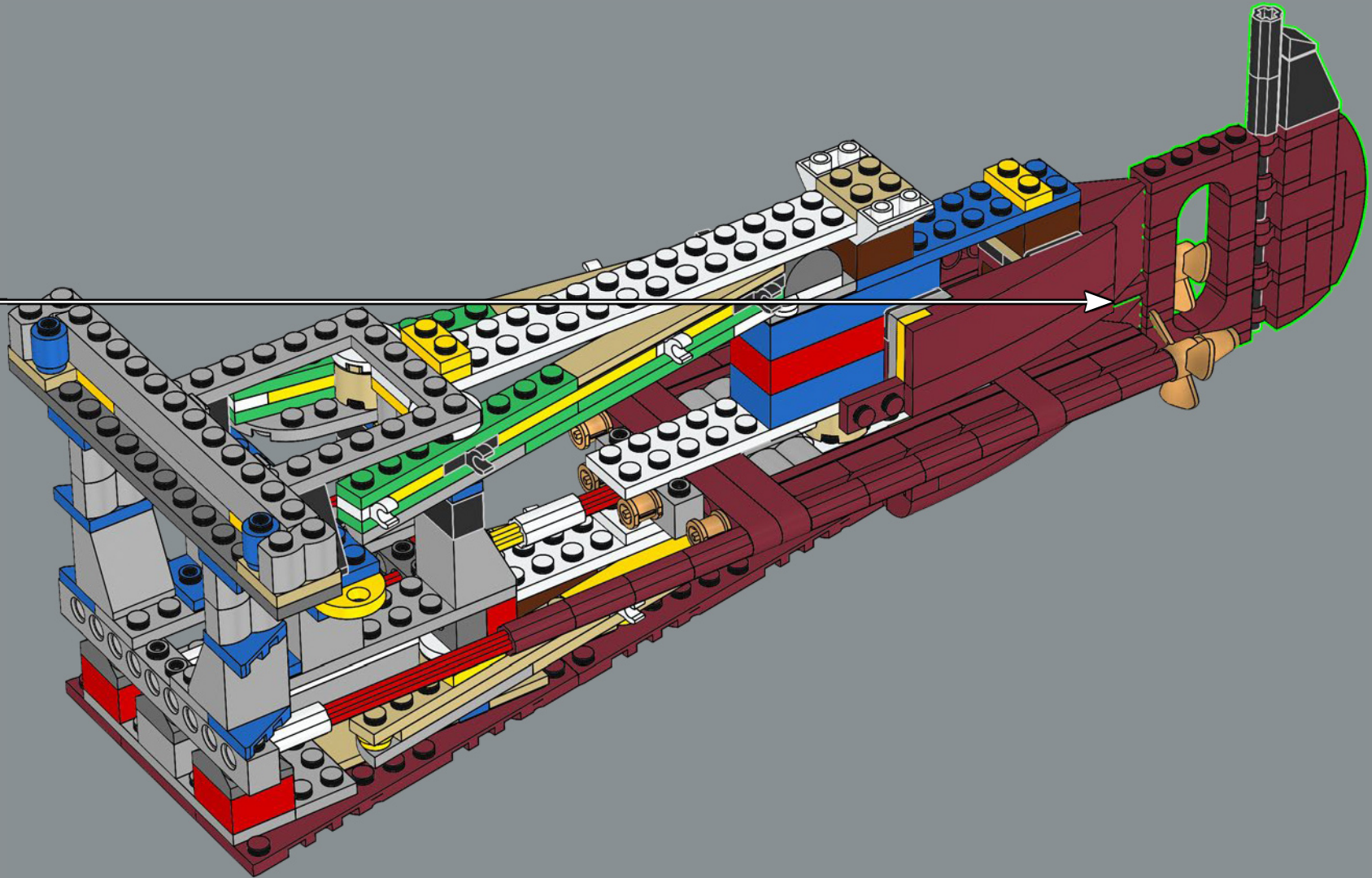

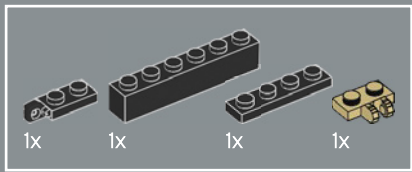

209

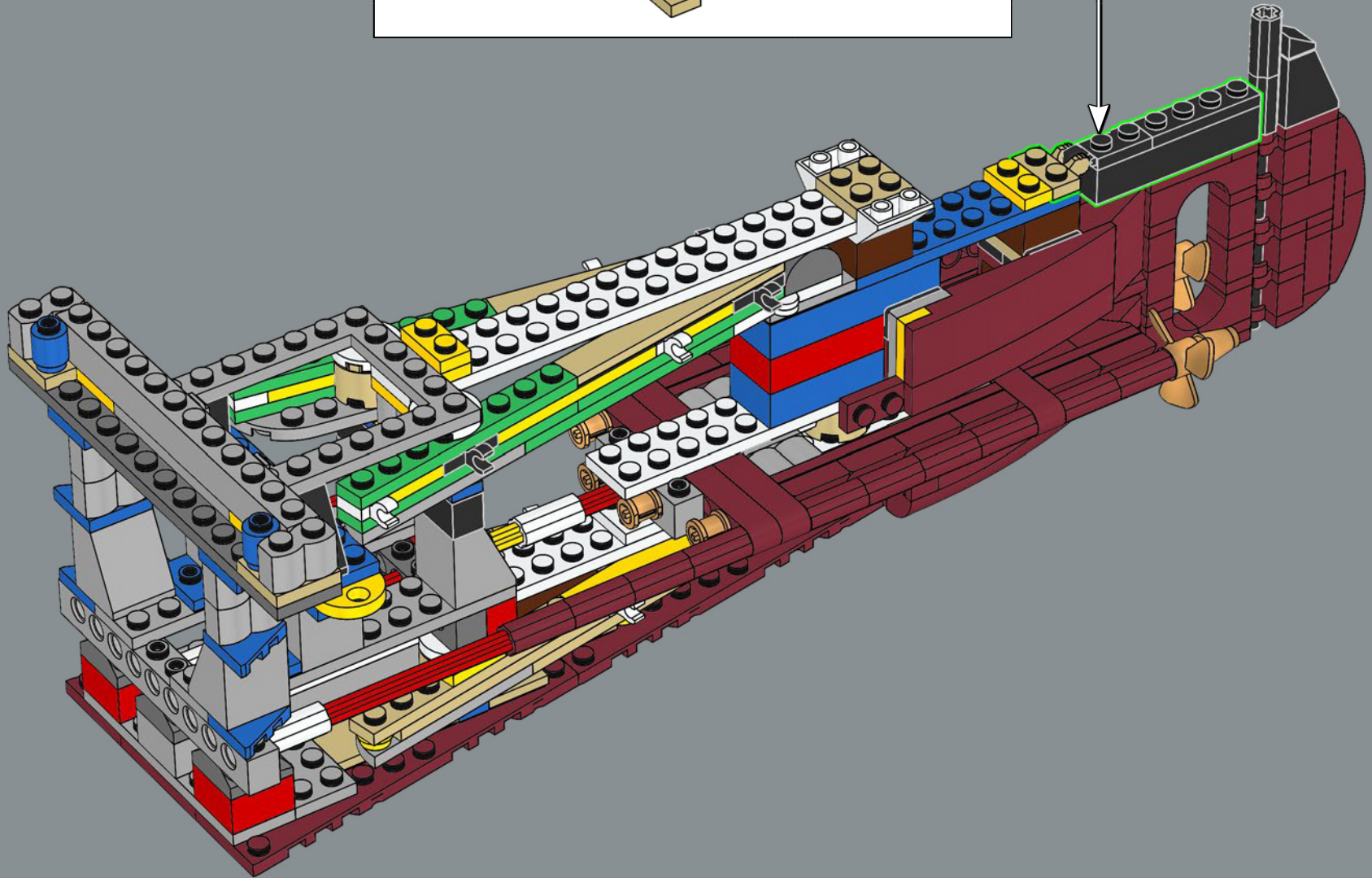
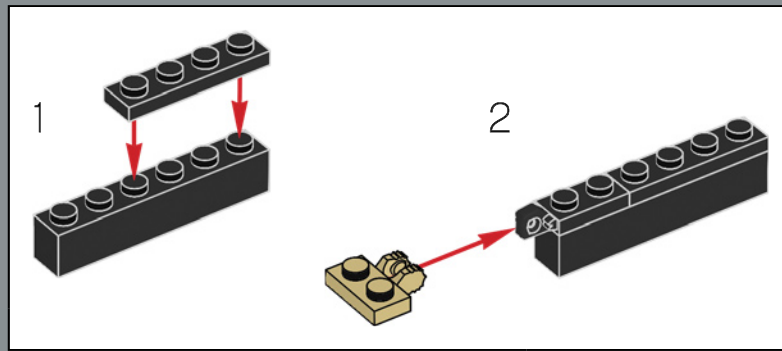

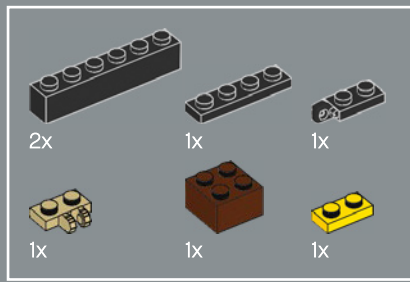

210

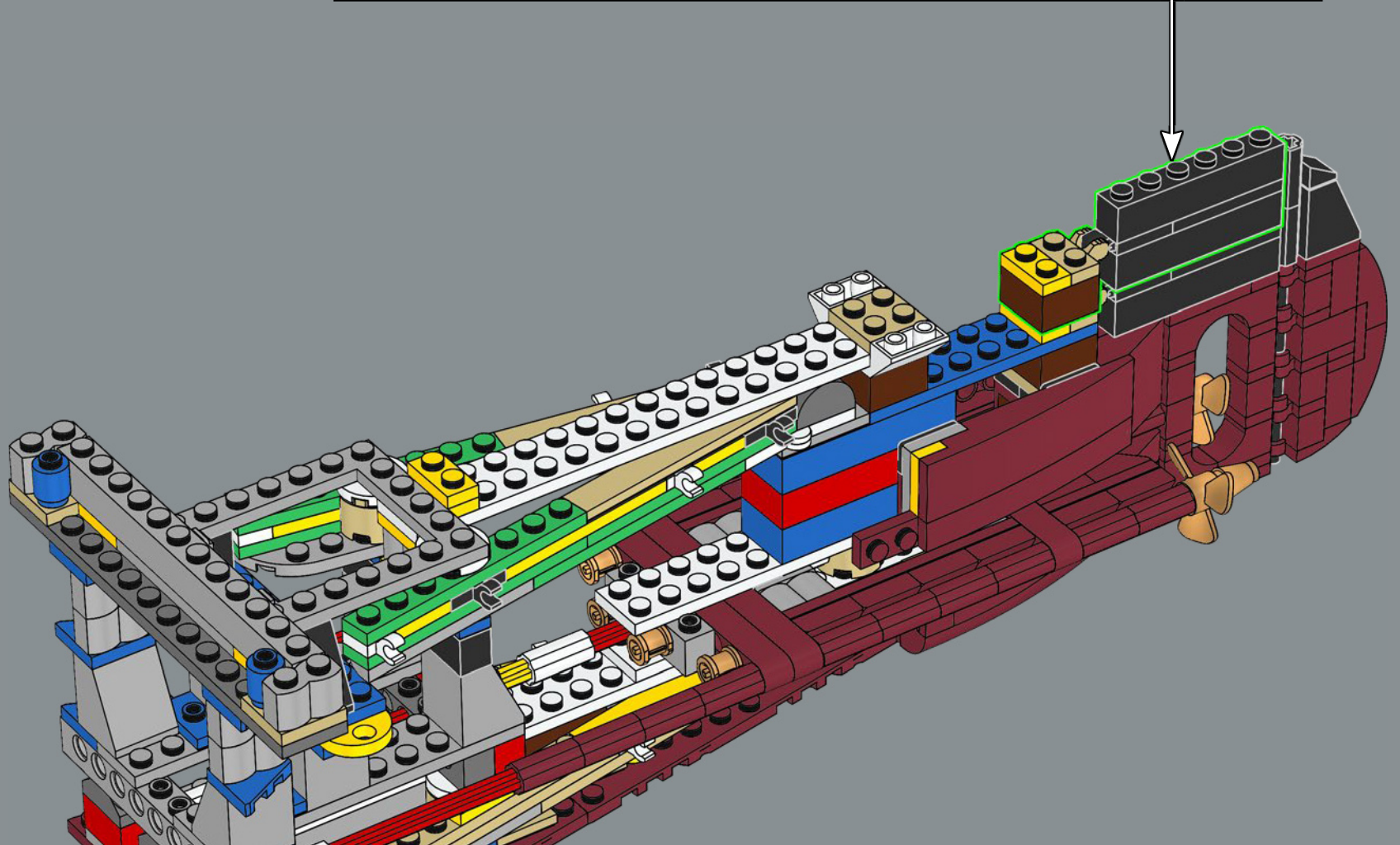
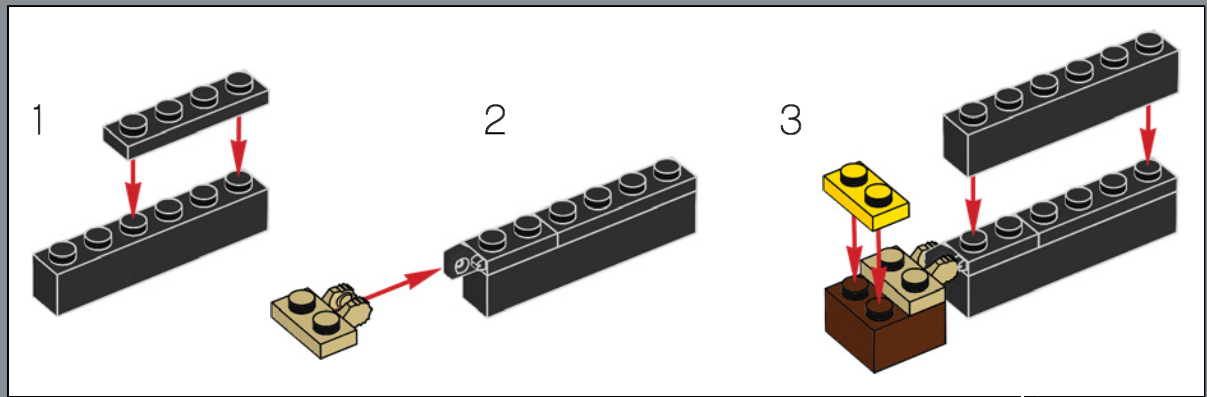





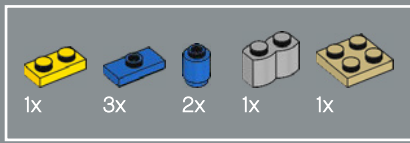

212

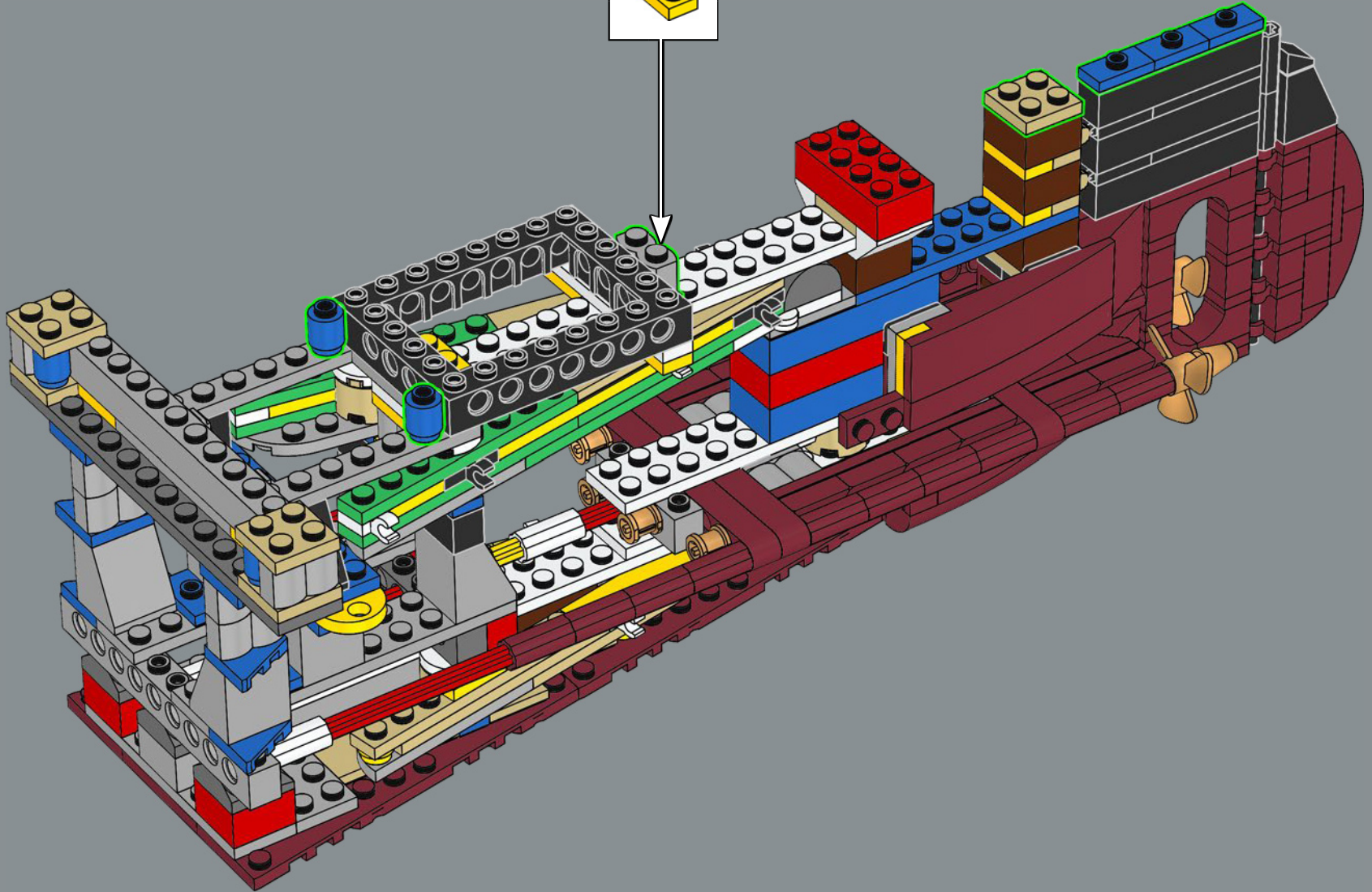
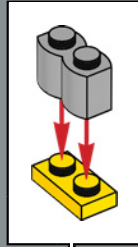

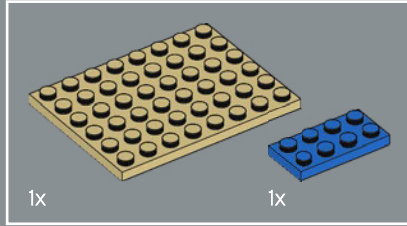
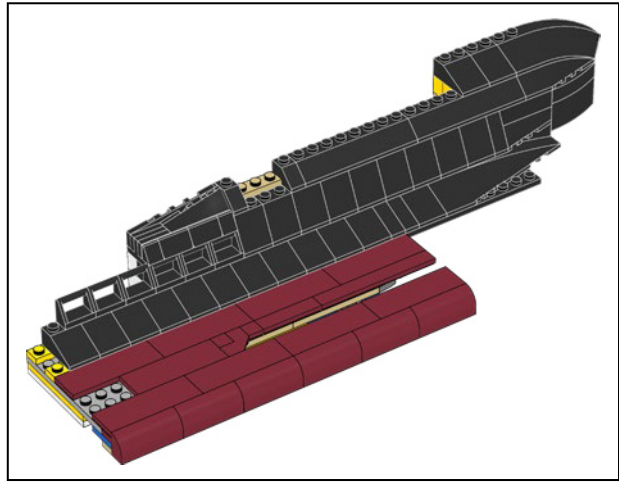
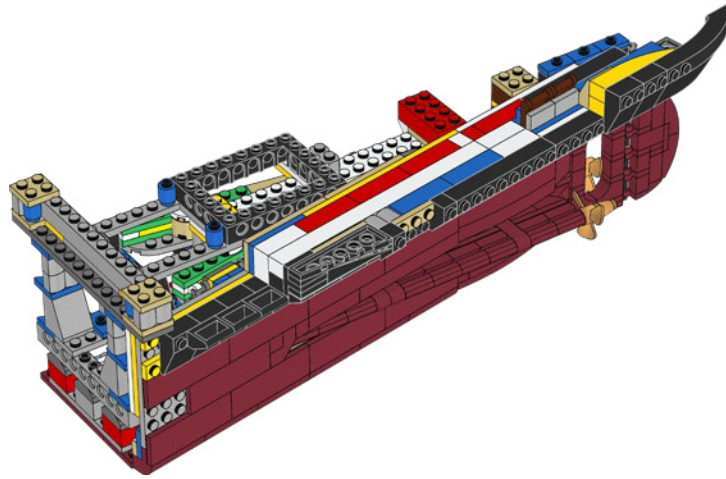
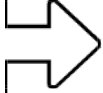

213

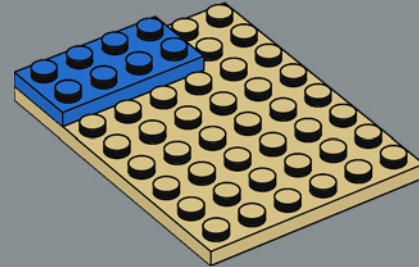

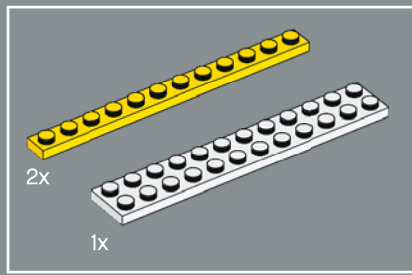

214

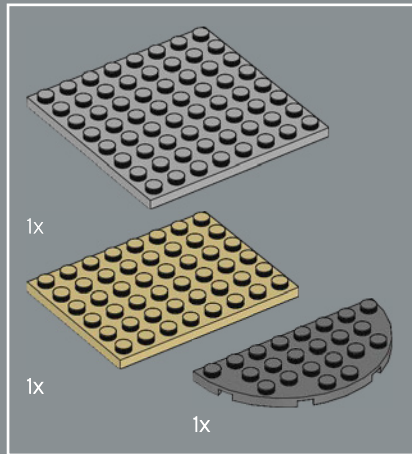
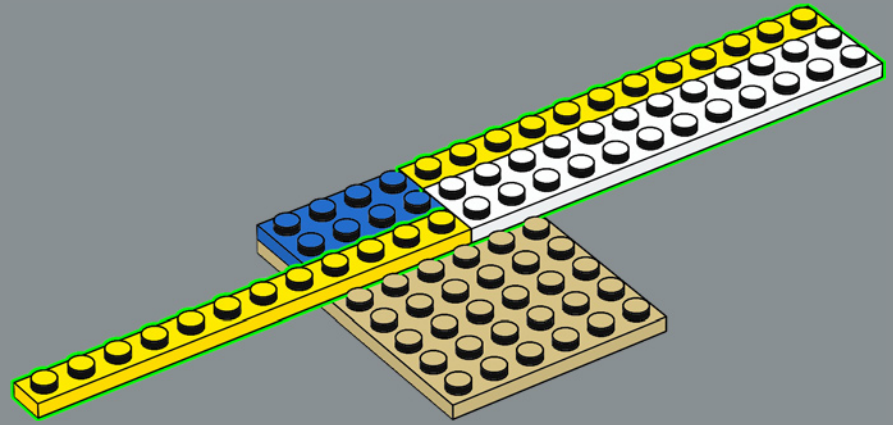

215

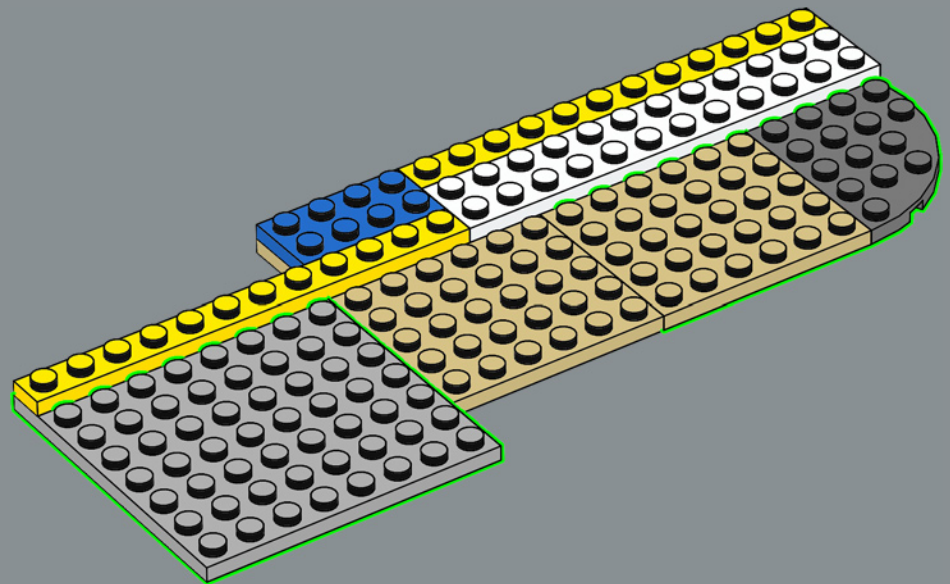

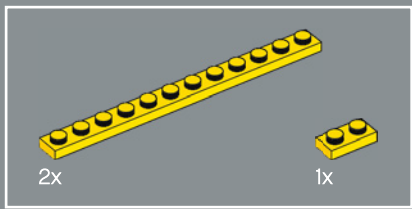

216

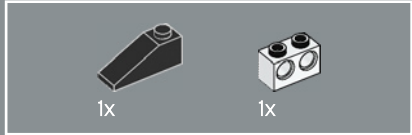
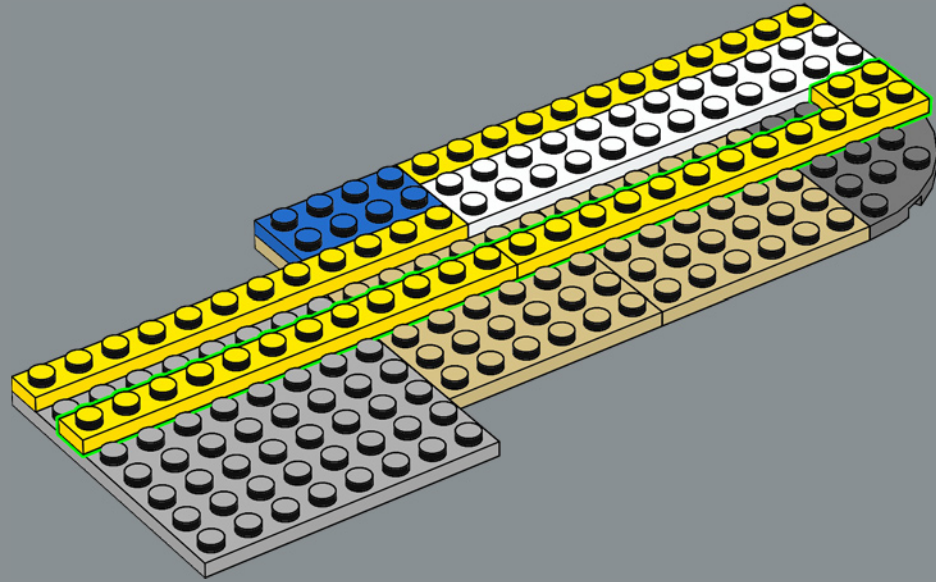

217

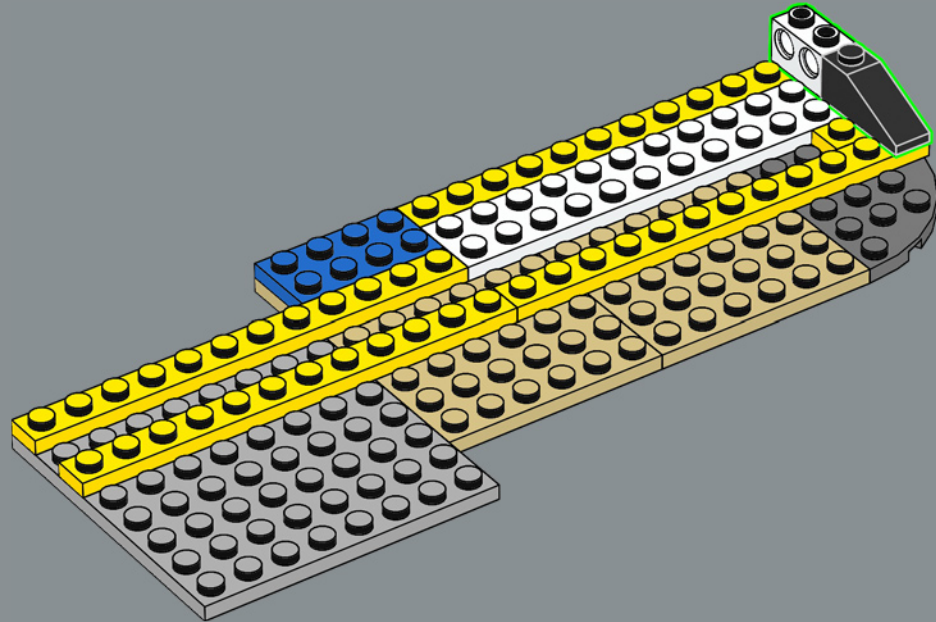

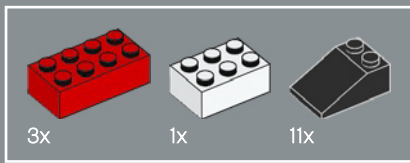

218

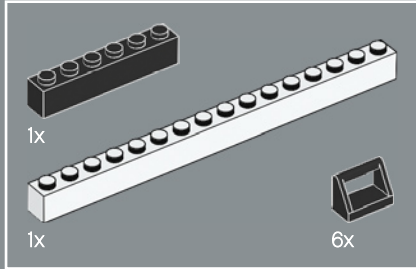
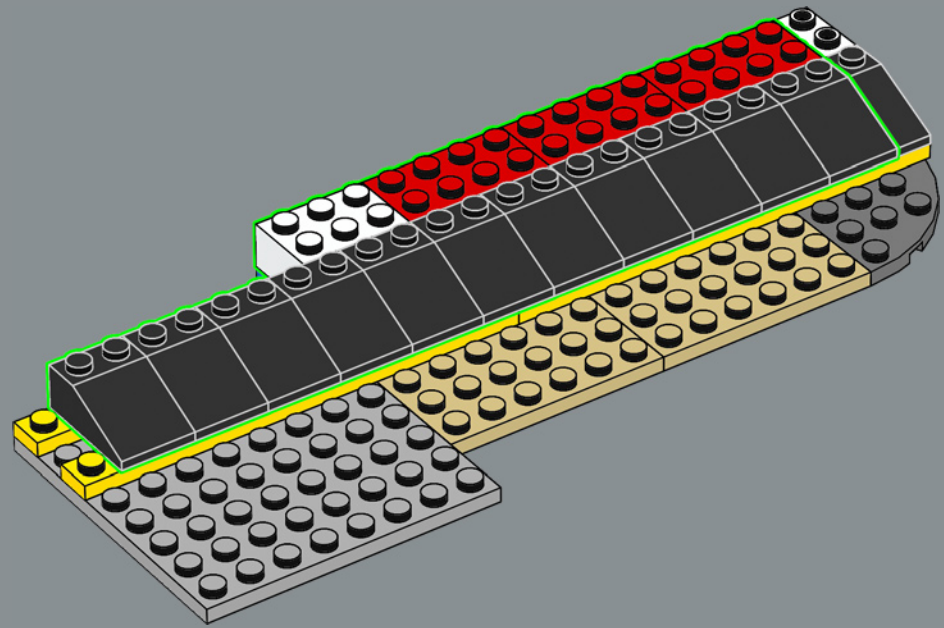

219

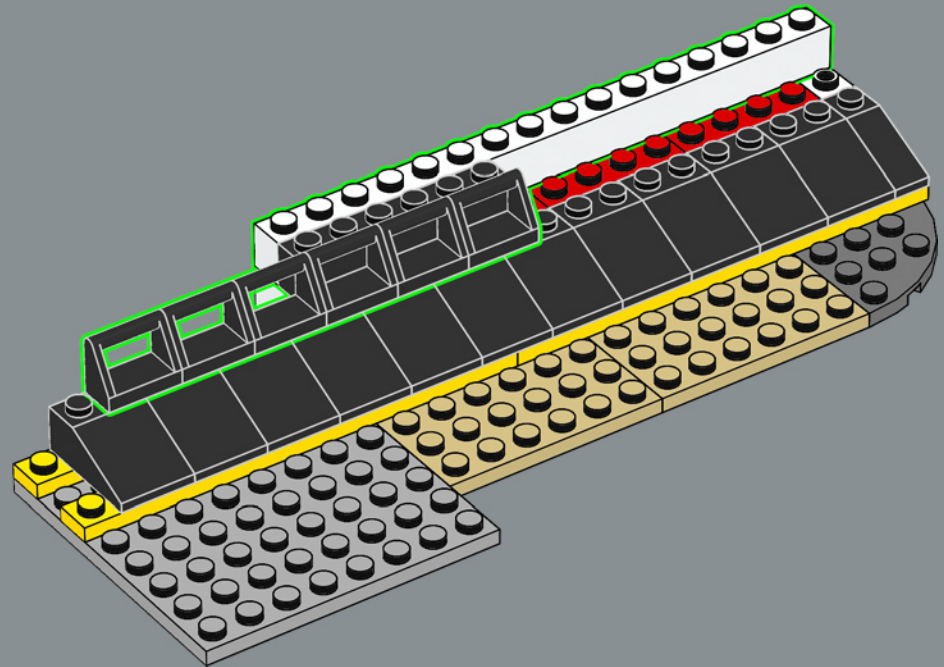

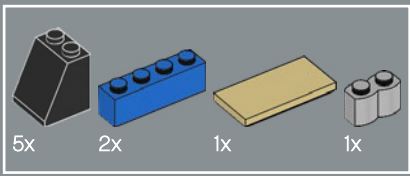

220

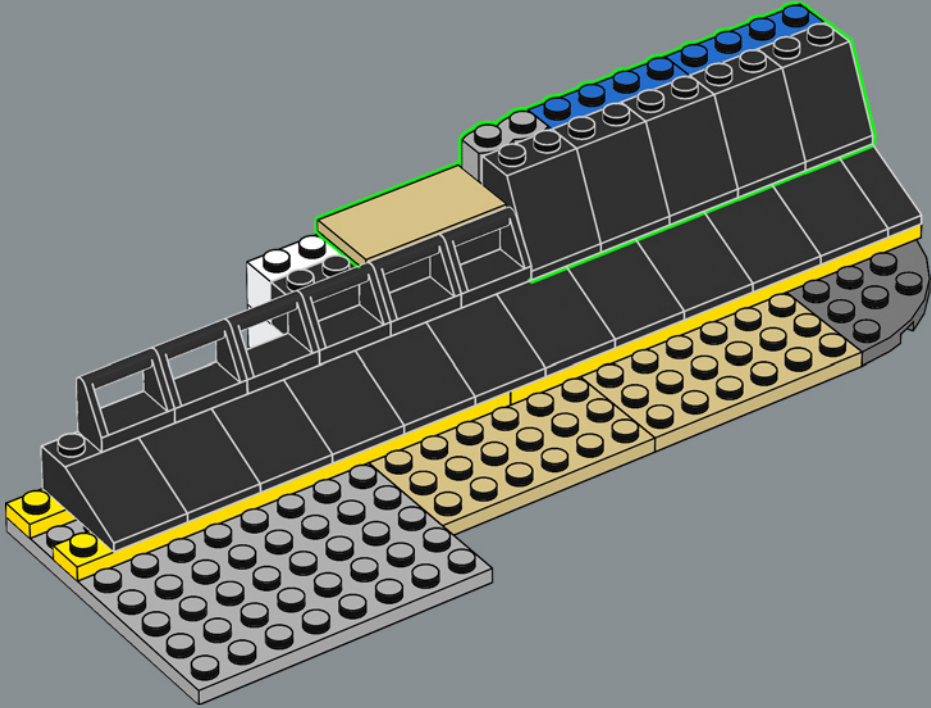

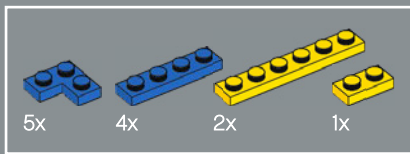

221

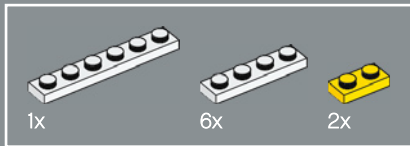
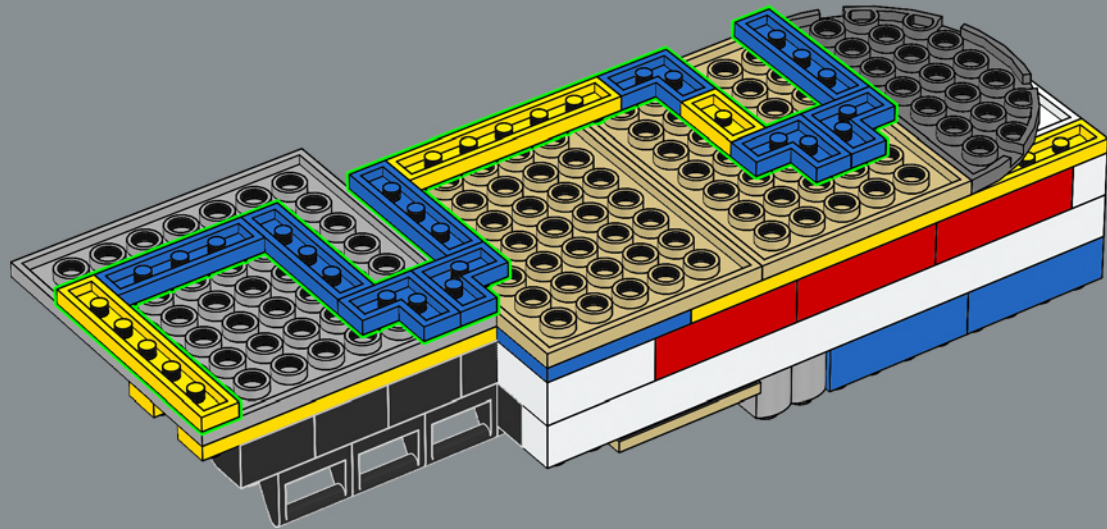

222

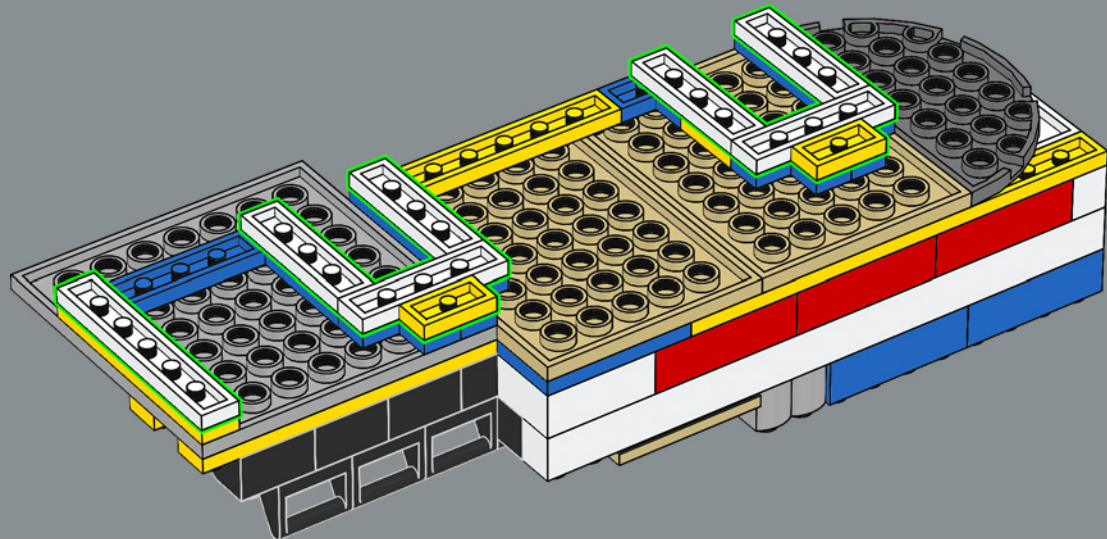

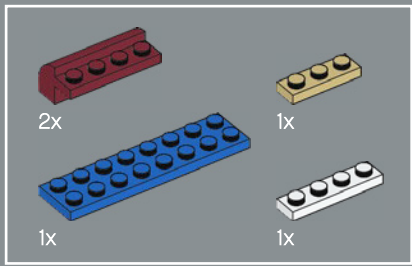

223

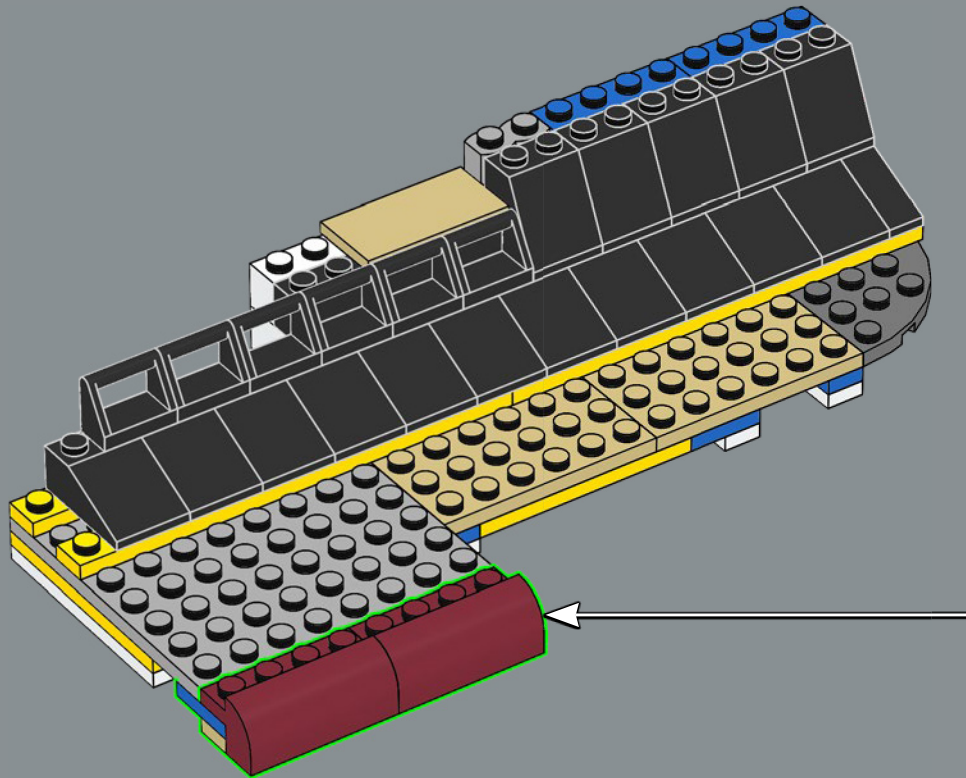
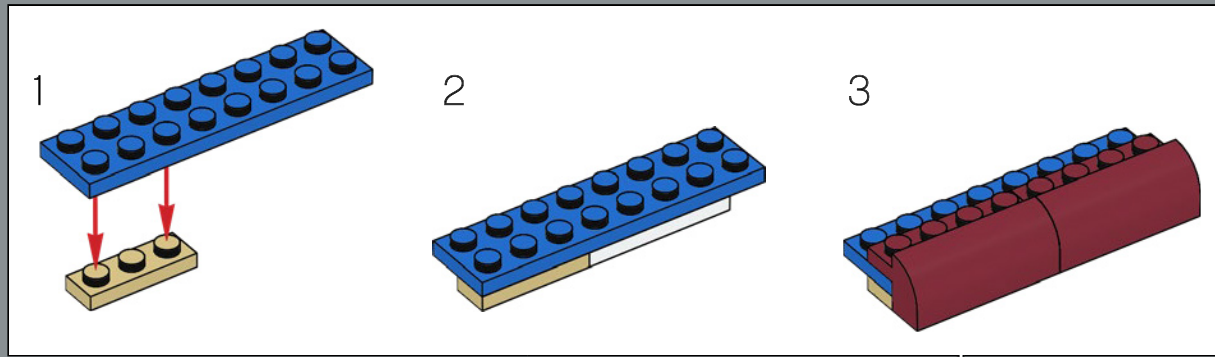



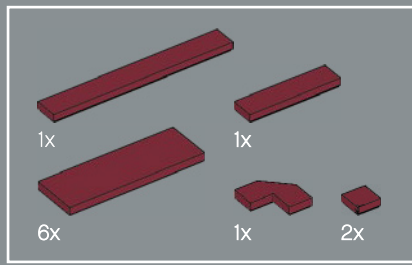

224

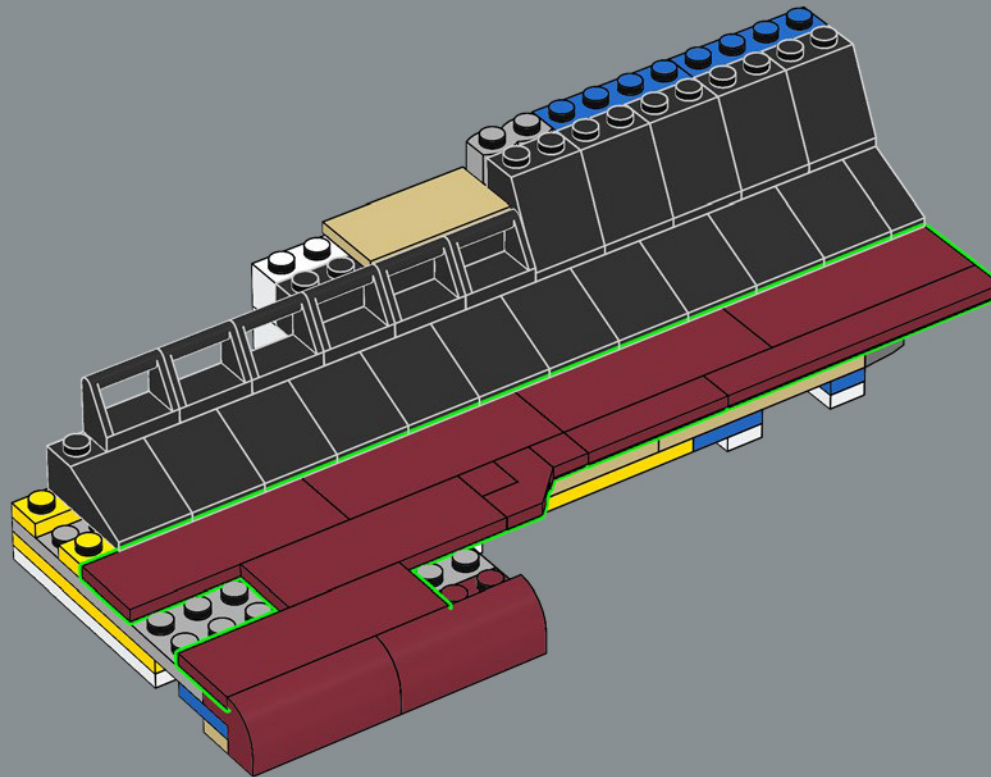

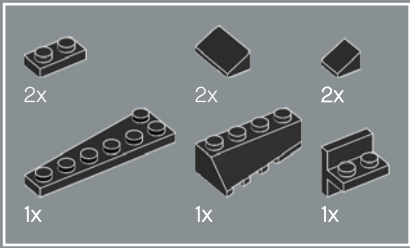

225

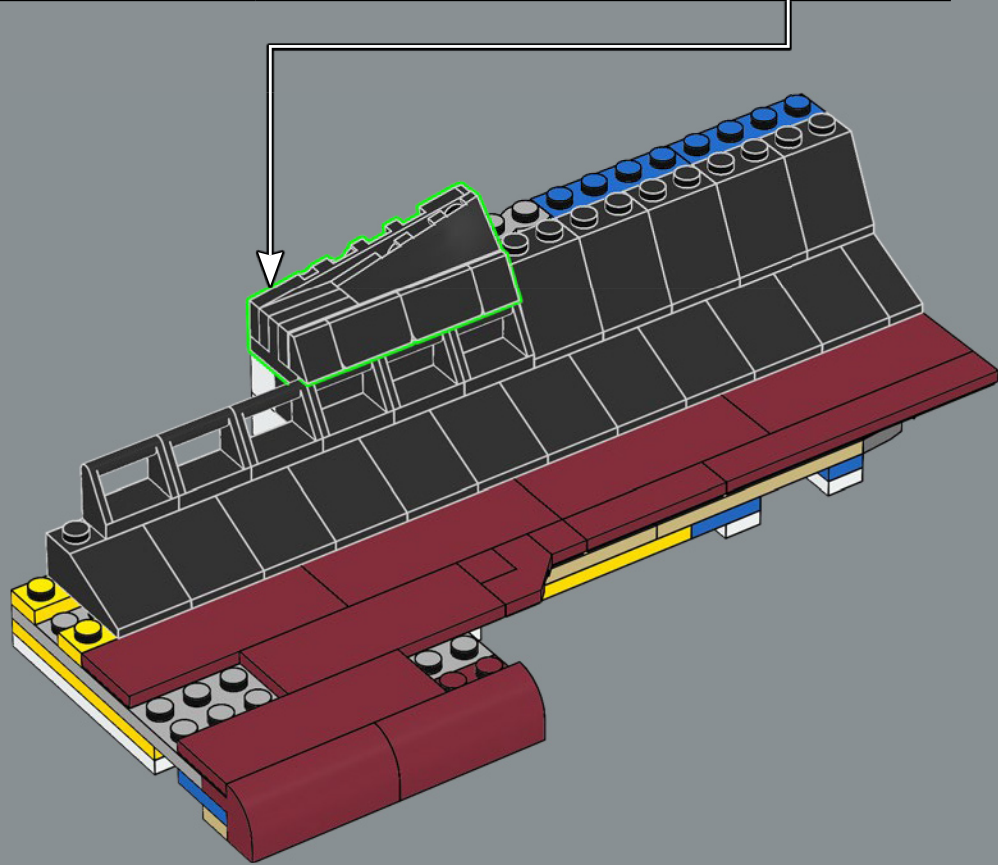
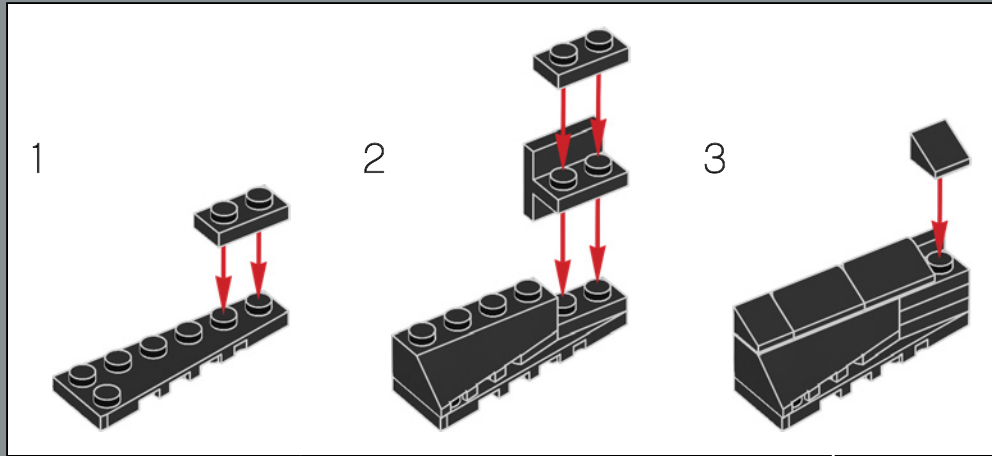

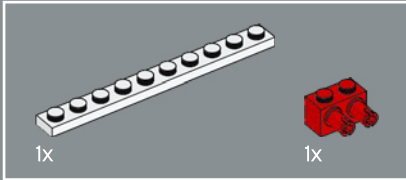
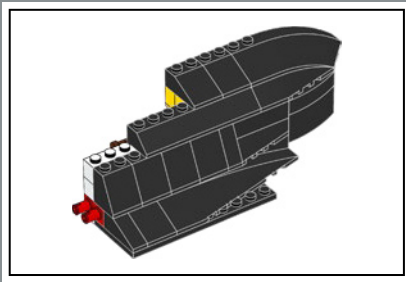

226

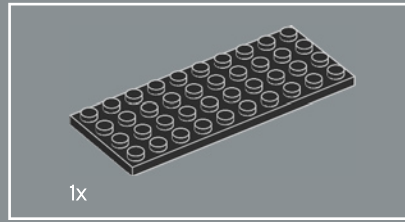
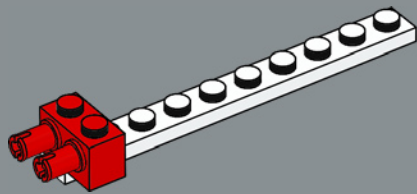

227

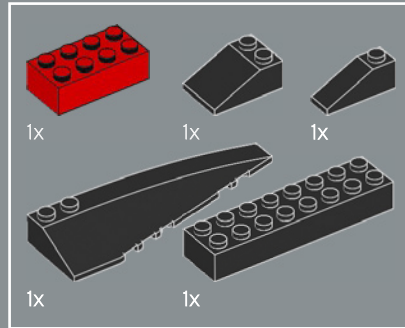
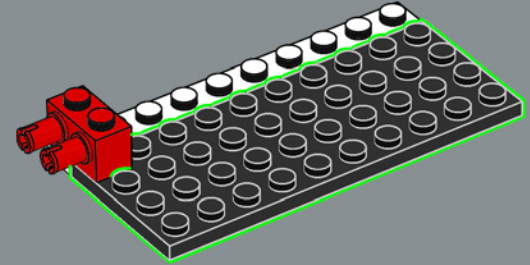

228

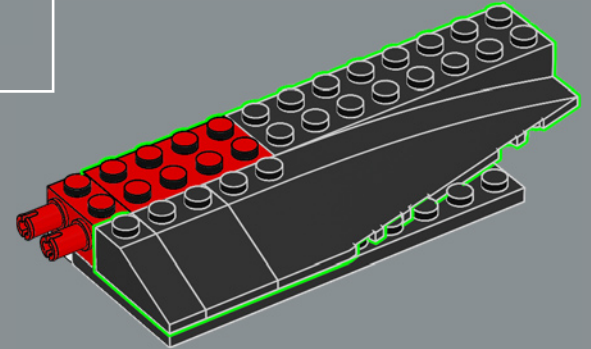

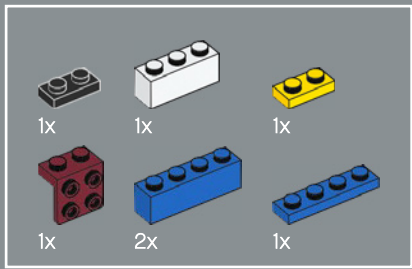

229

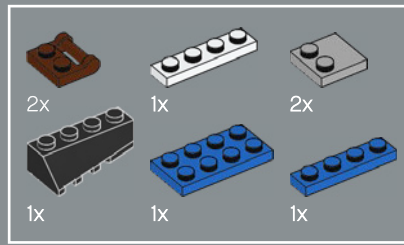
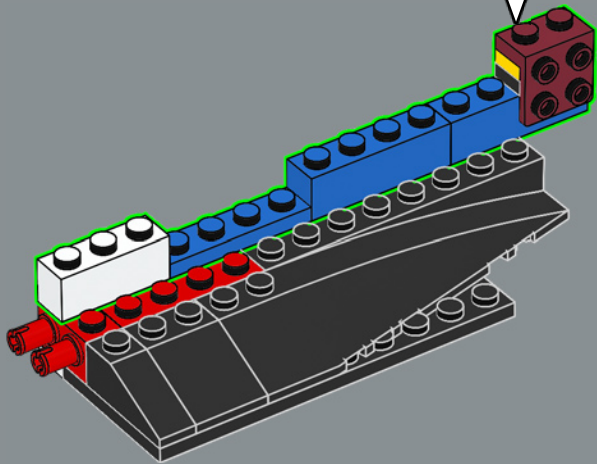
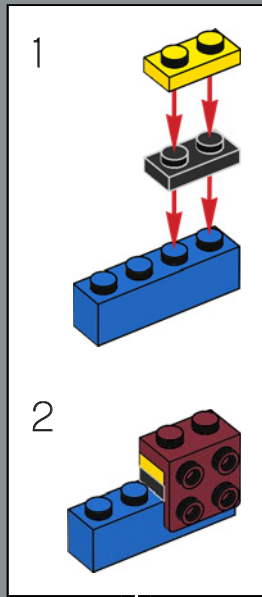

230

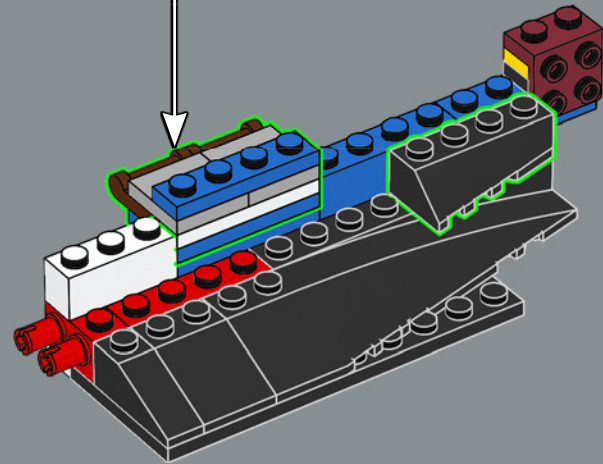
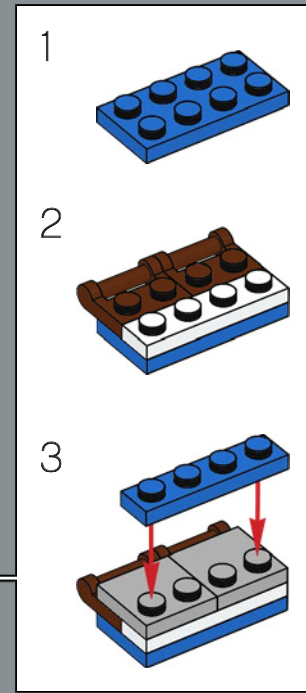

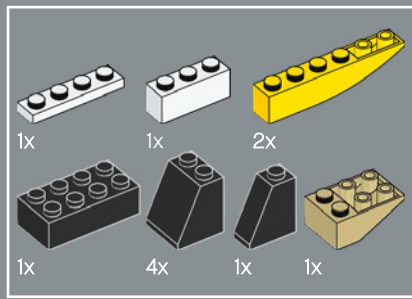

231

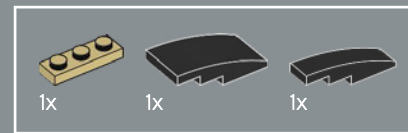
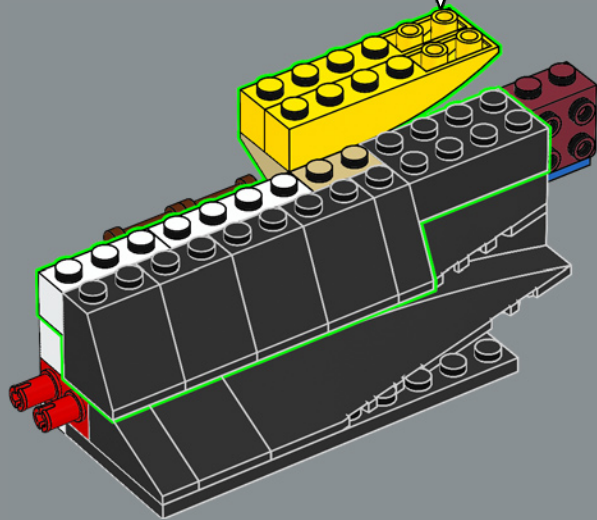
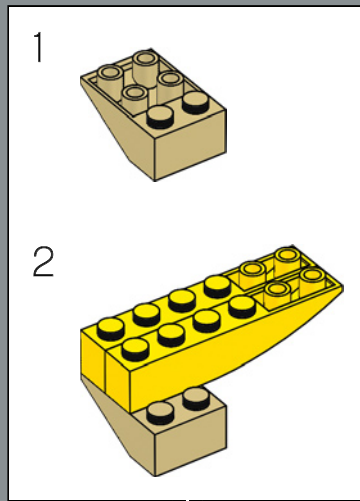

232

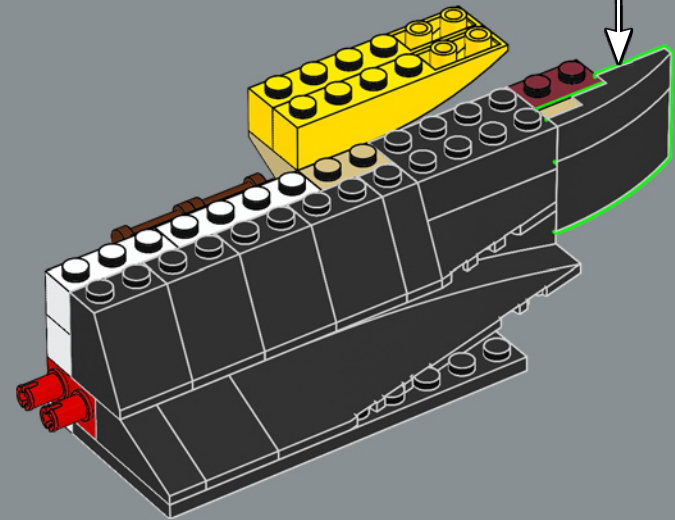
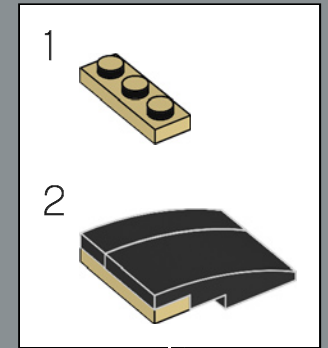

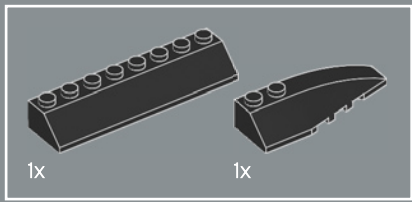

233

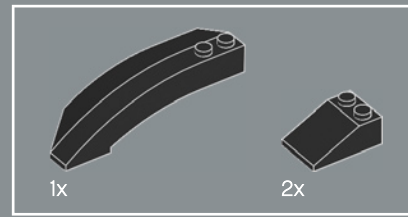
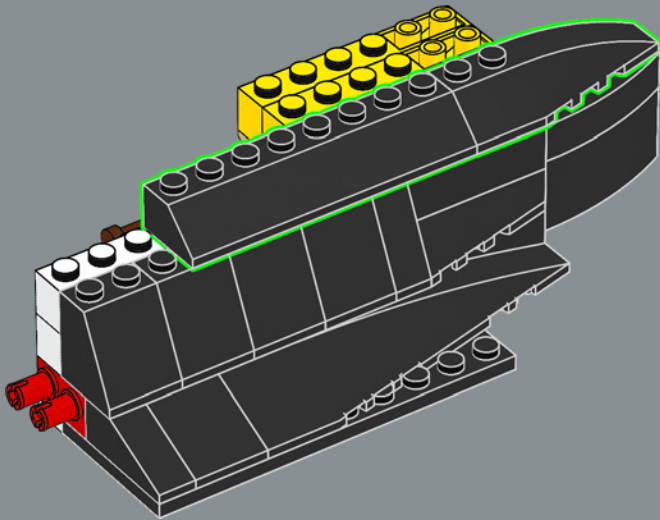

234

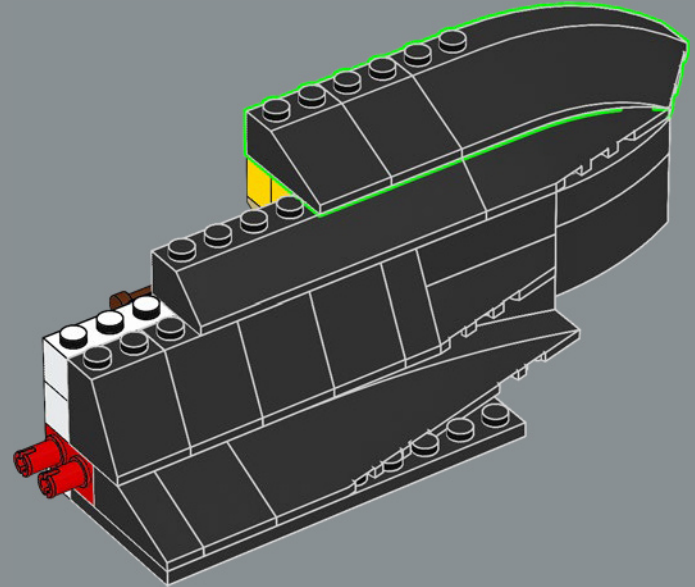

235

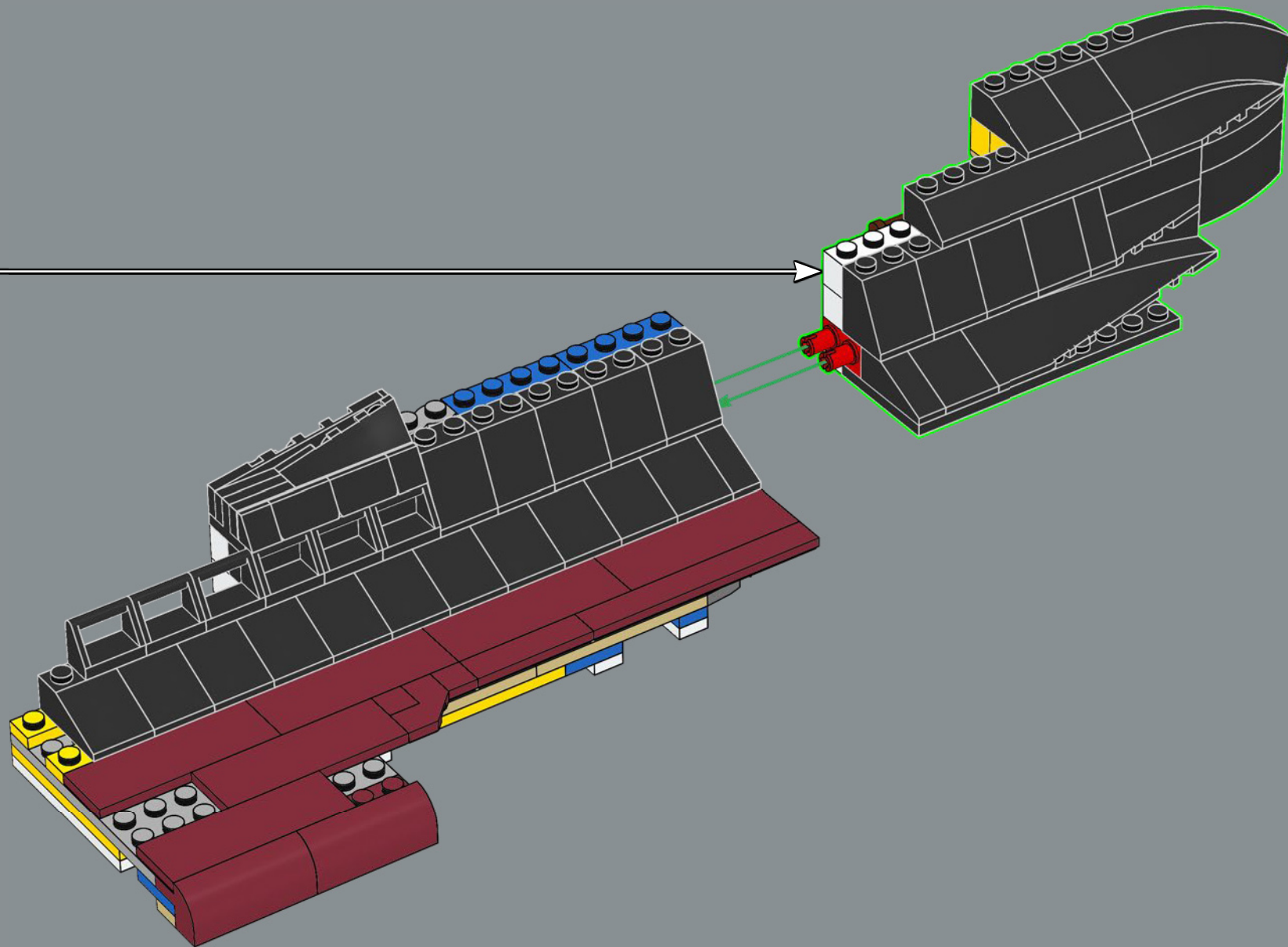

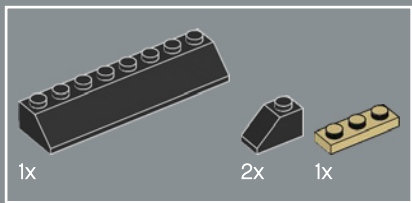

236

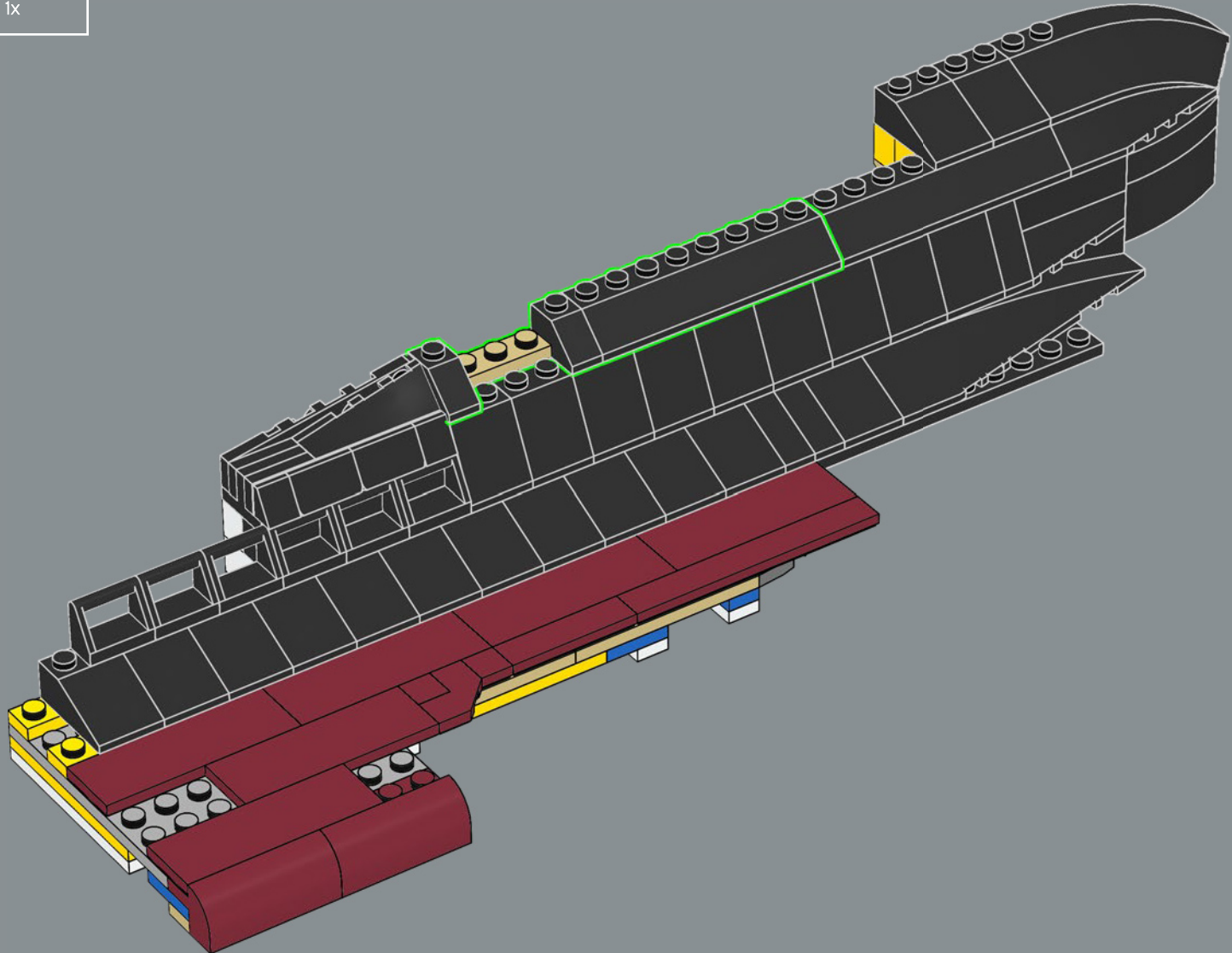



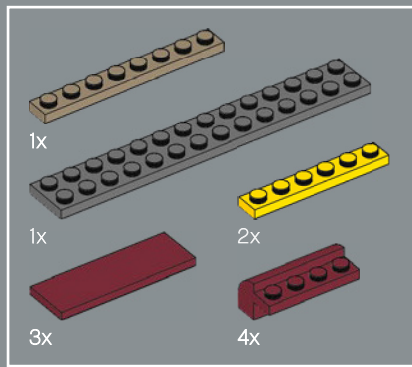

237

1

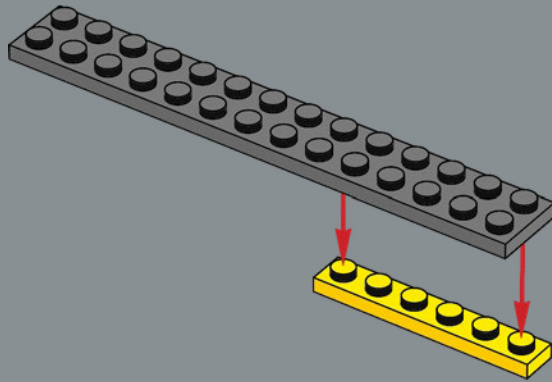

2

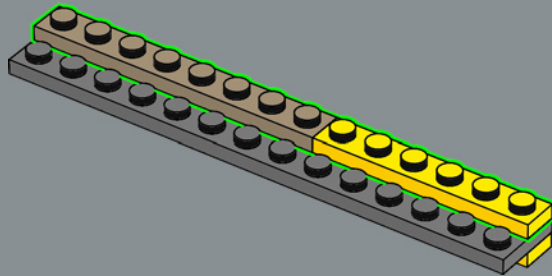

3

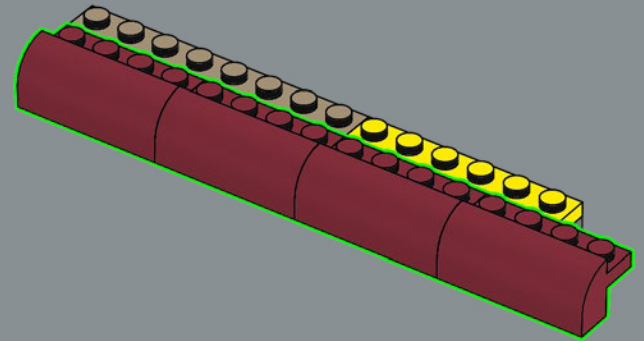

4

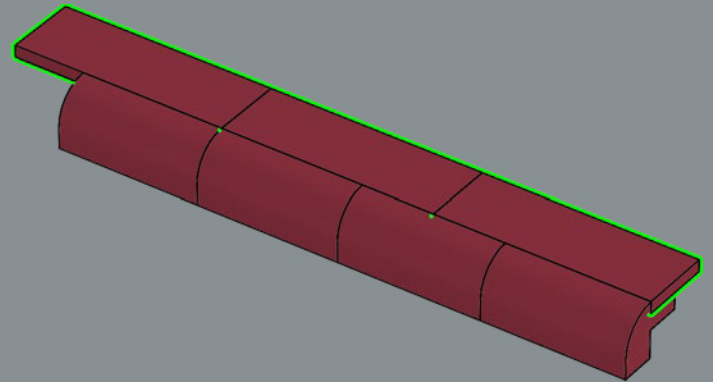

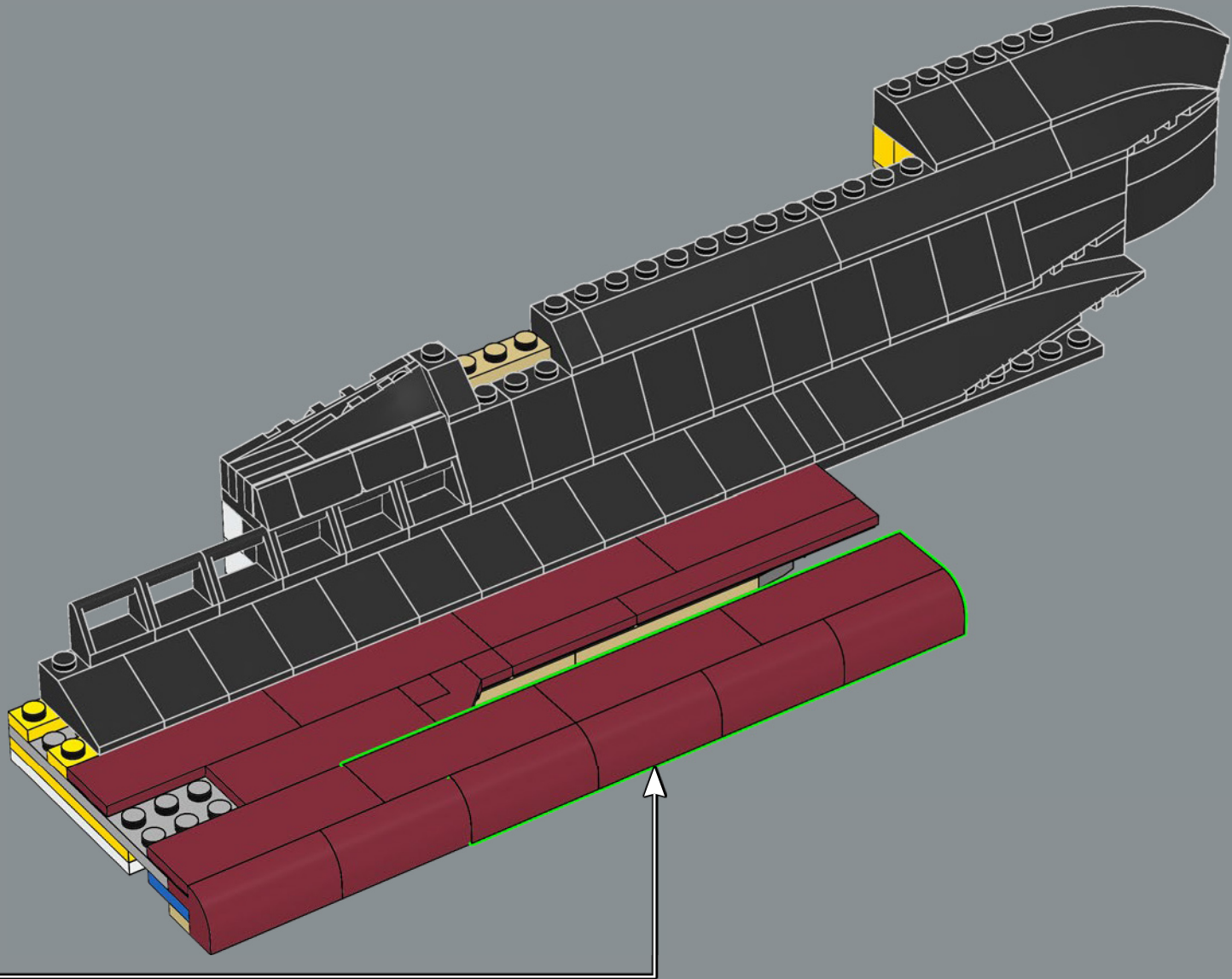

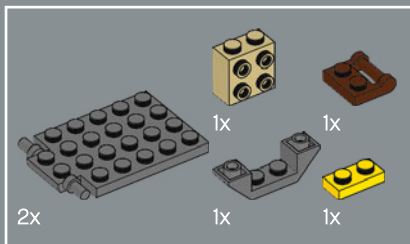

238

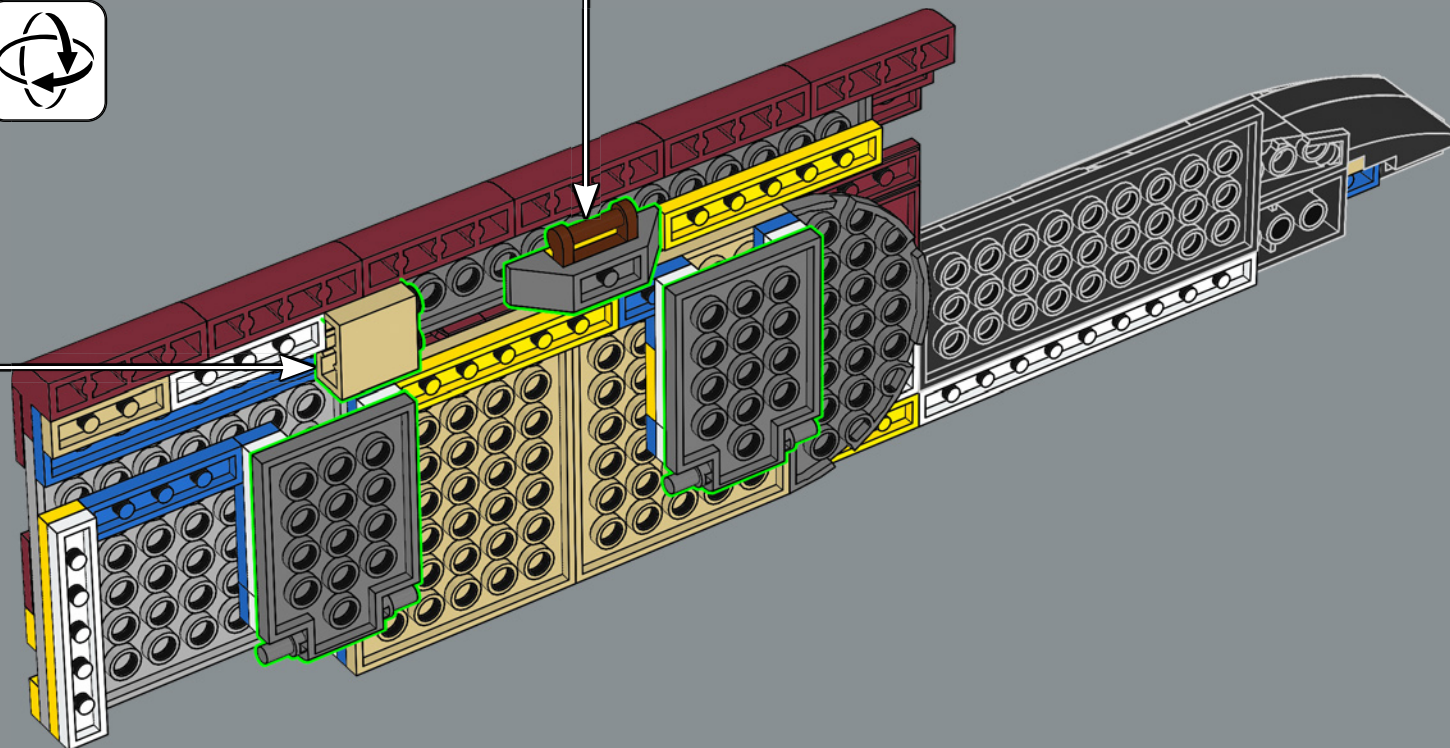
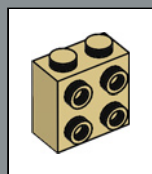
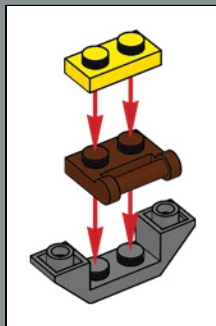

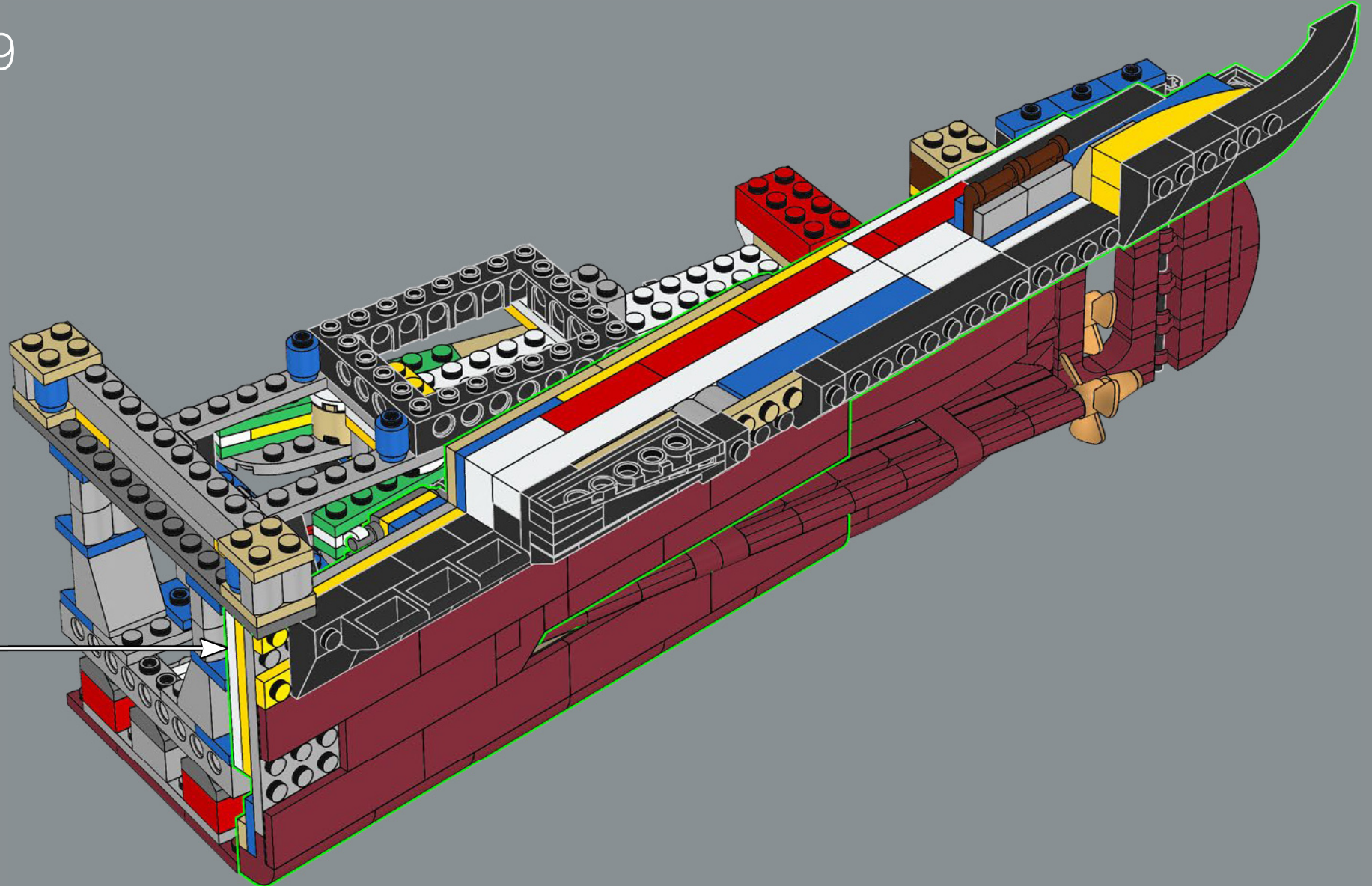

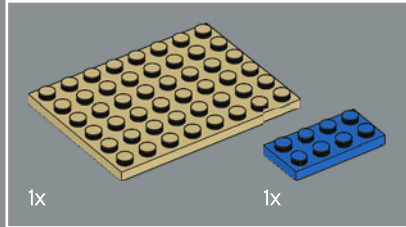
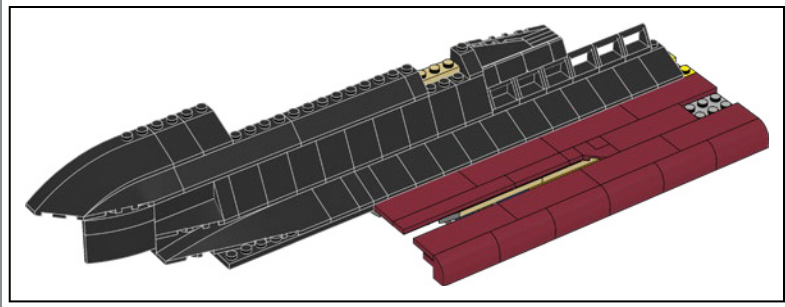
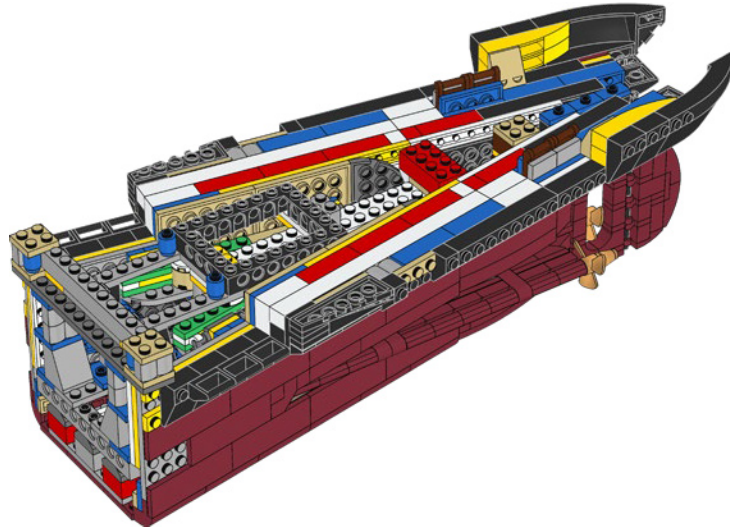
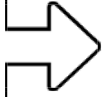

240

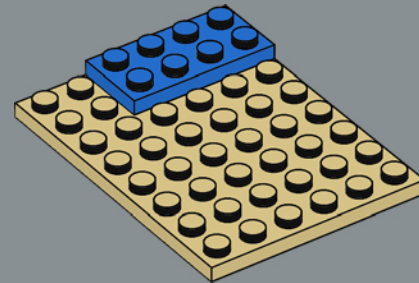

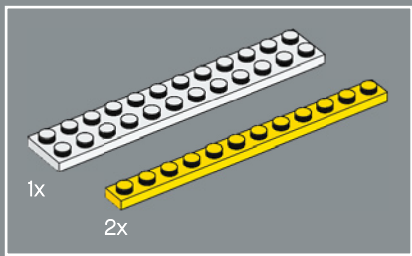

241

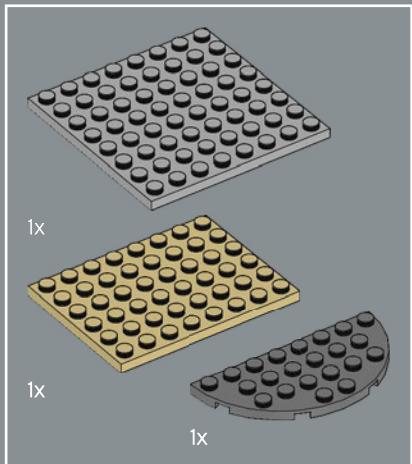
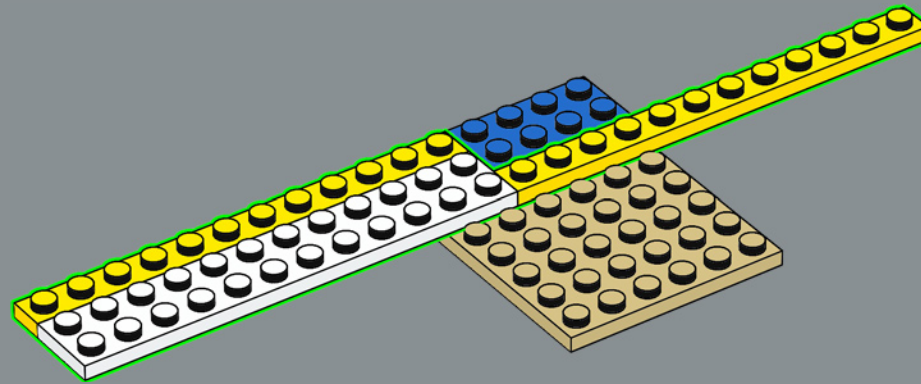

242

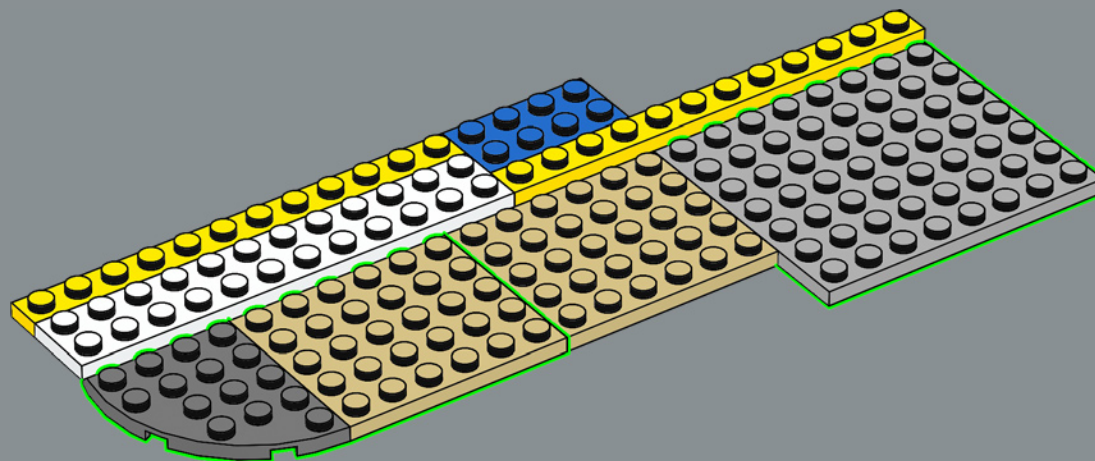

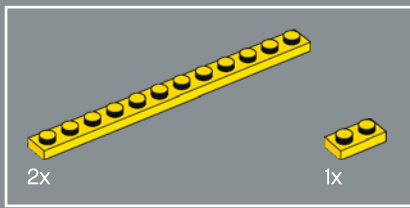

243

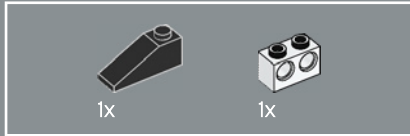
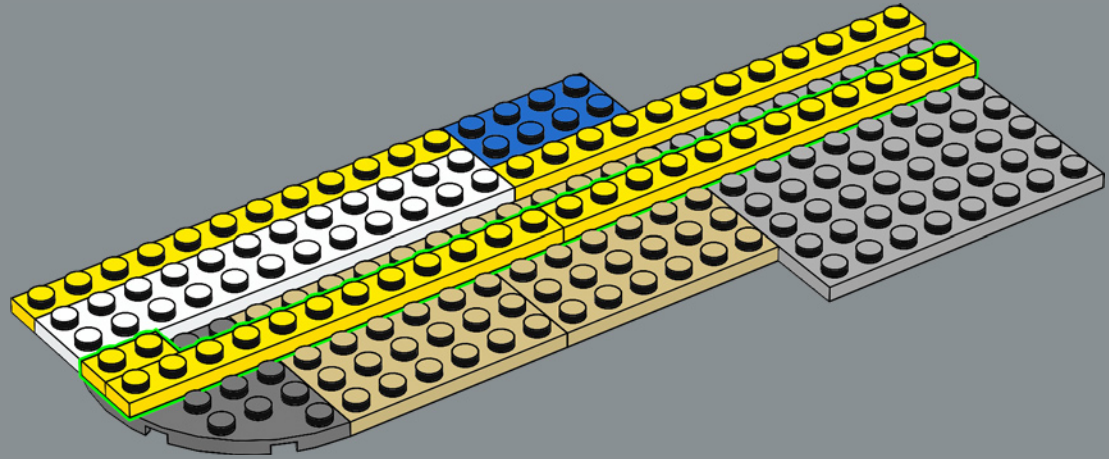

244

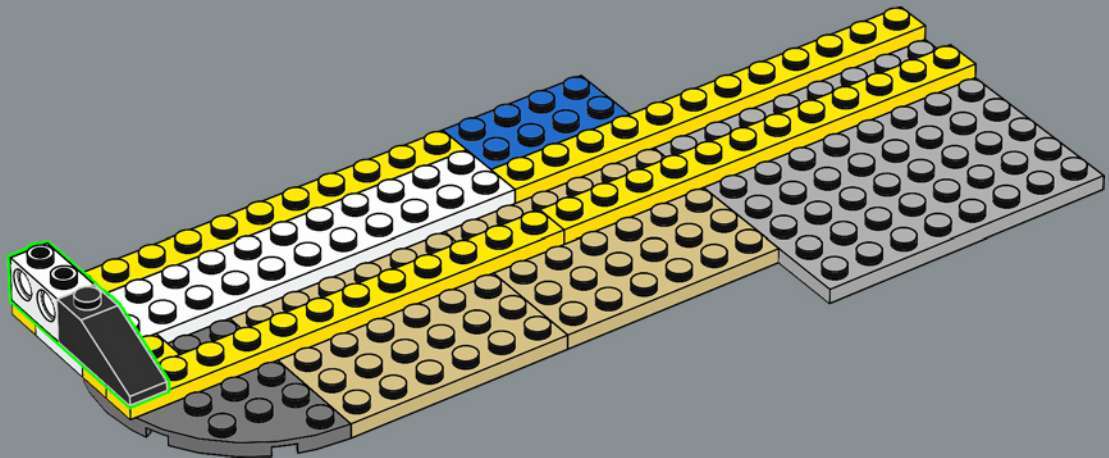

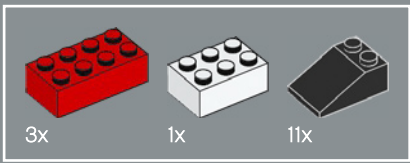

245

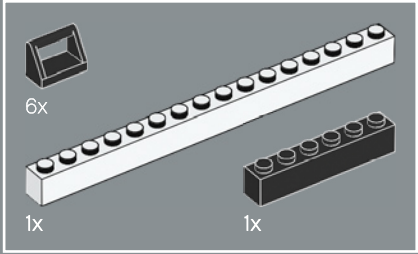
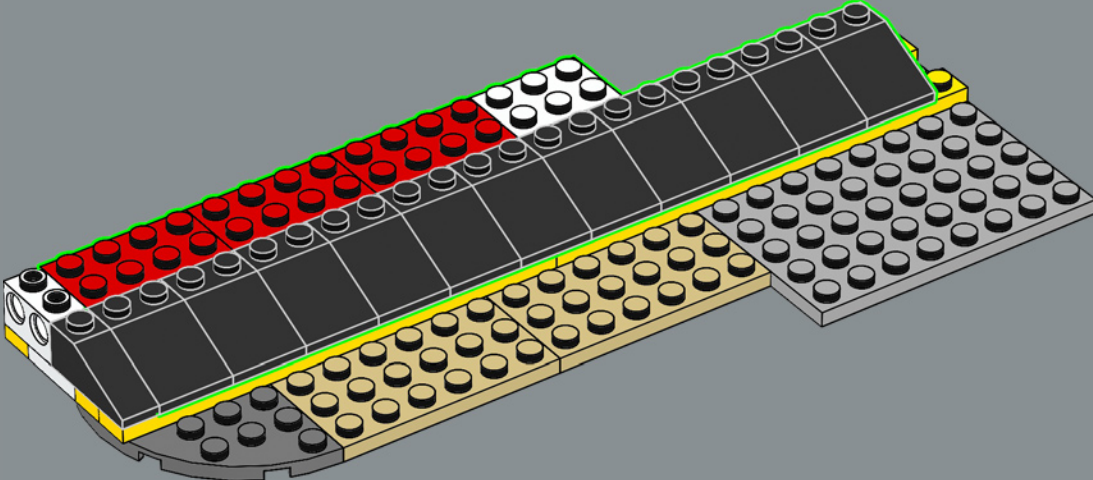

246

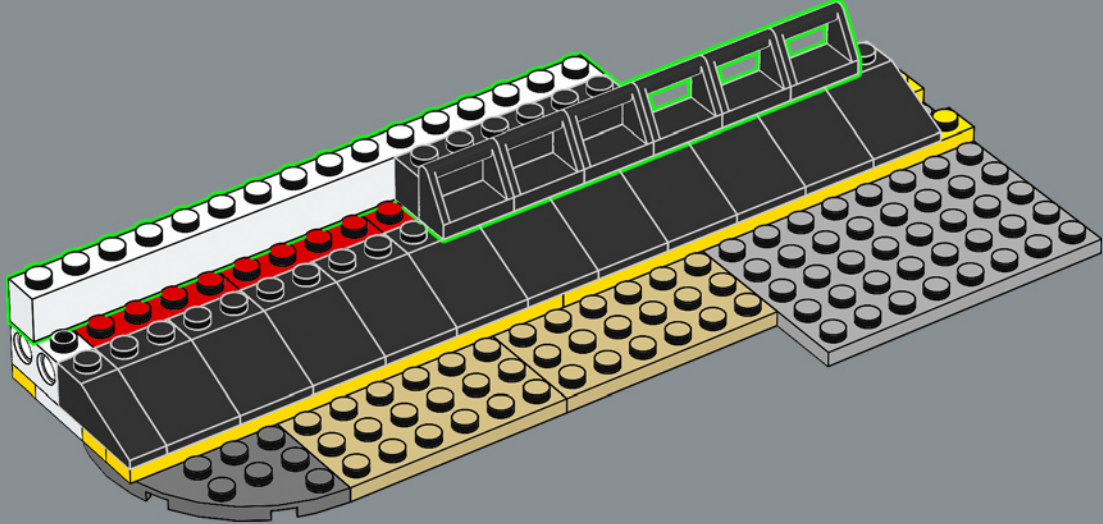



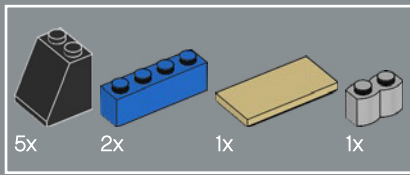

247

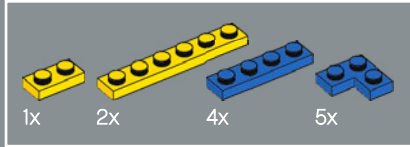
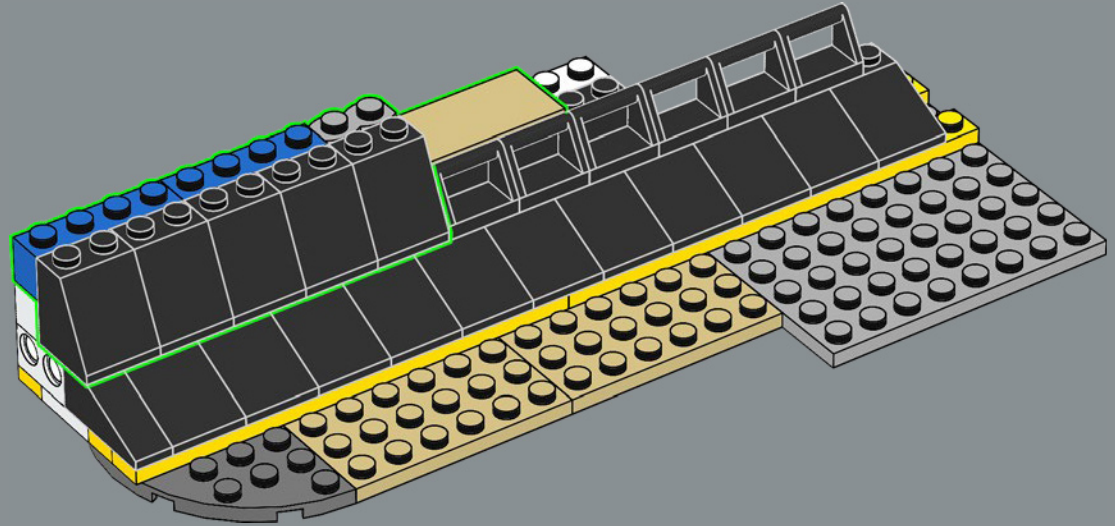

248

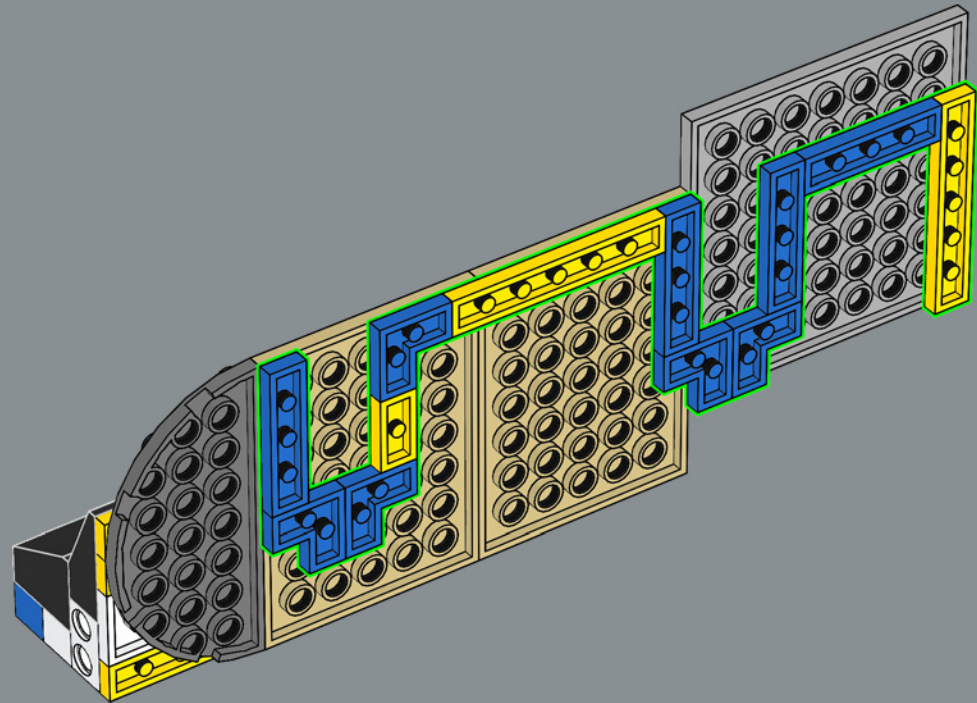

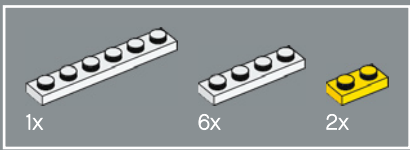

249

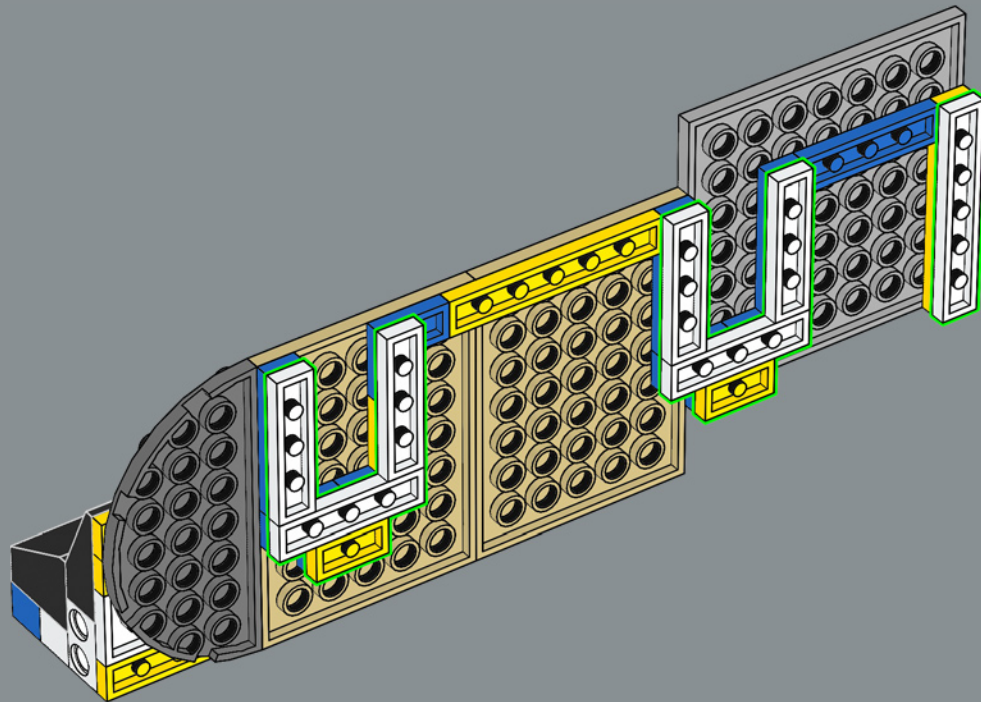

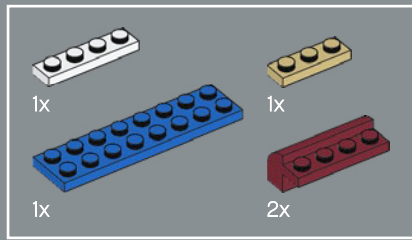

250

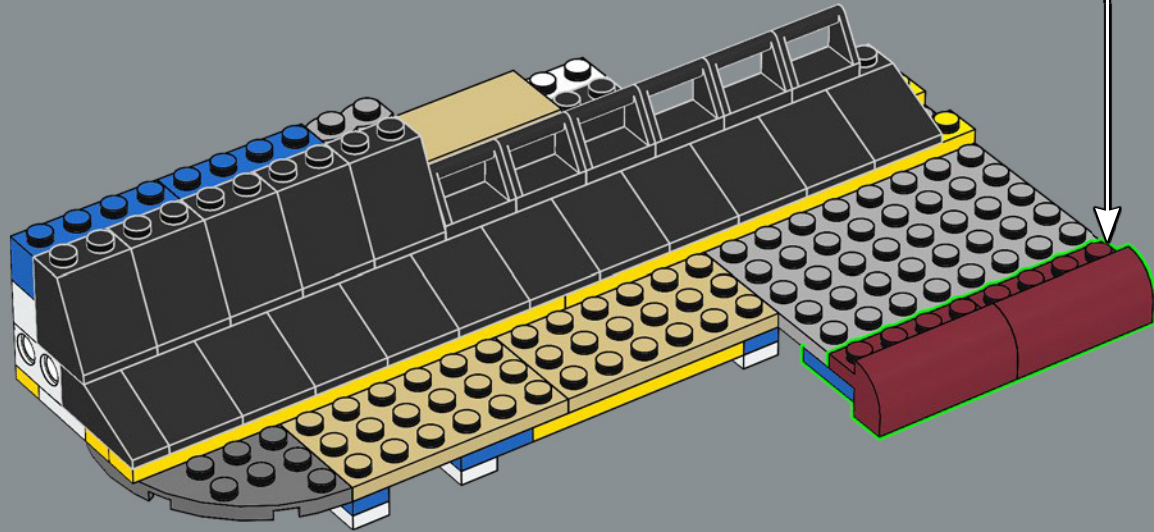
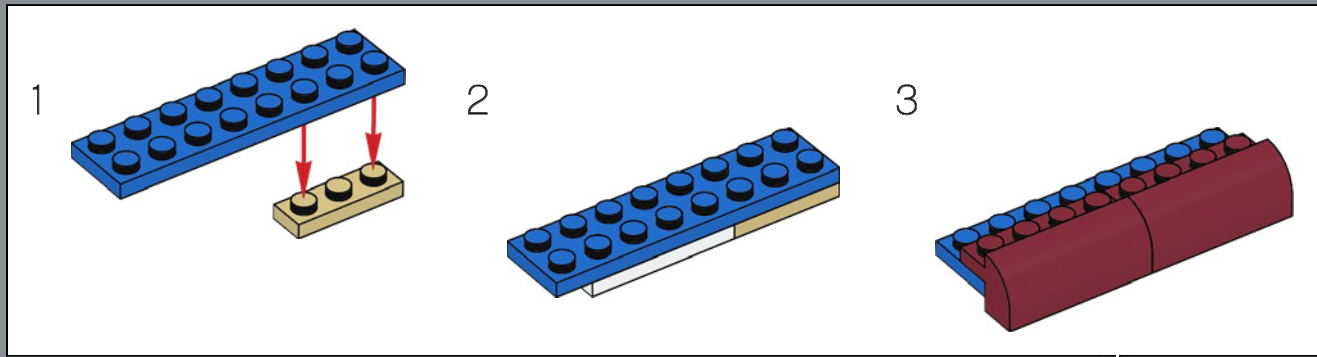

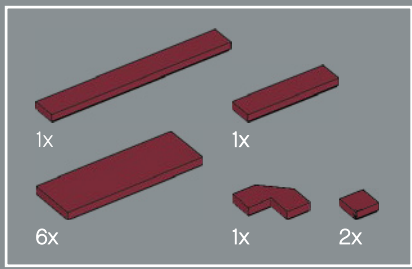

251

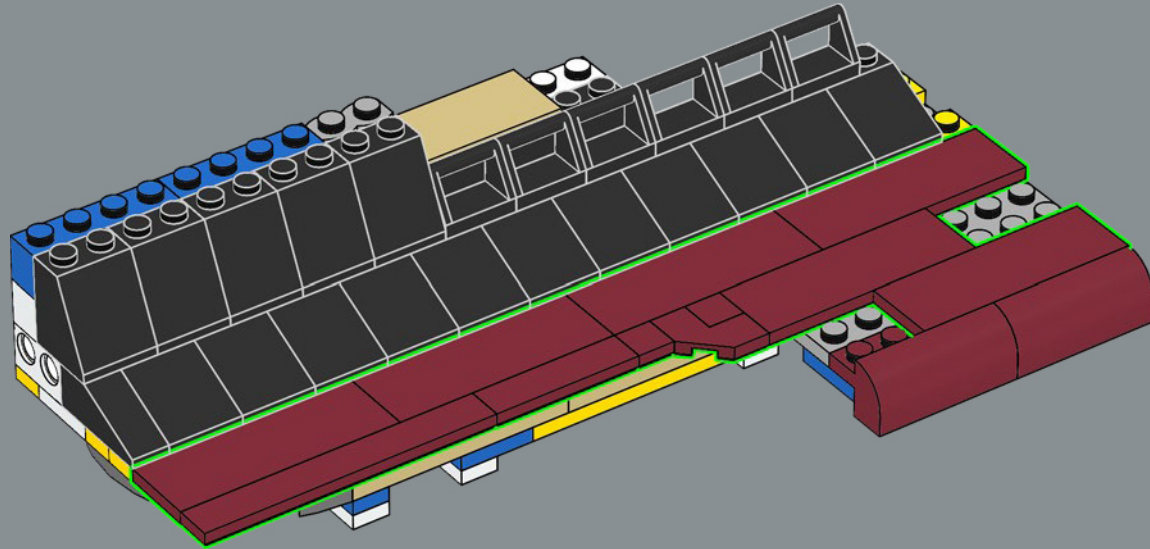

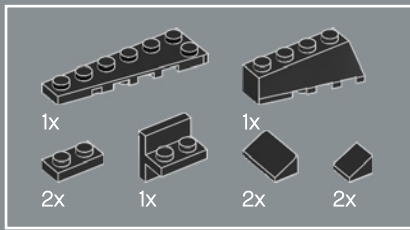

252

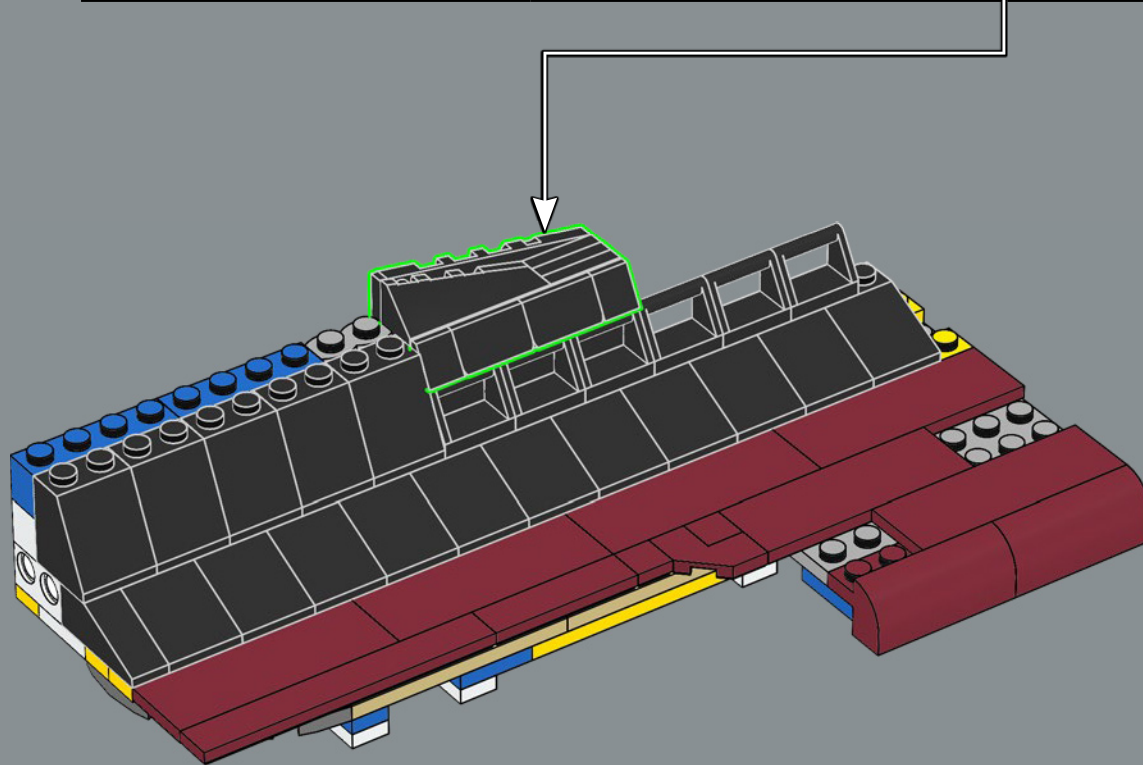
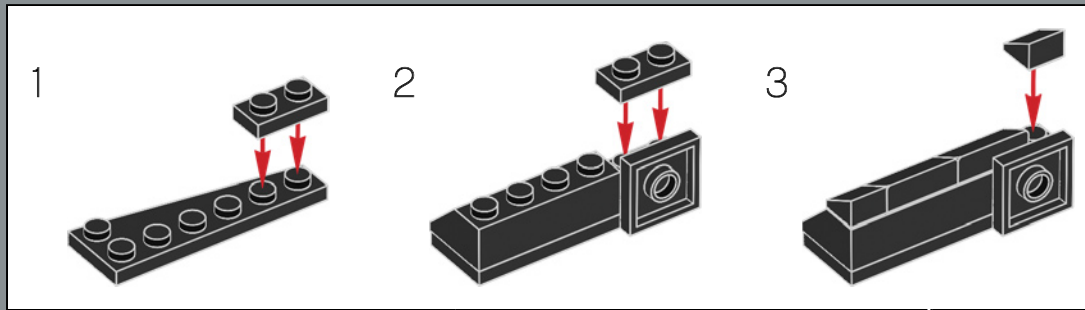

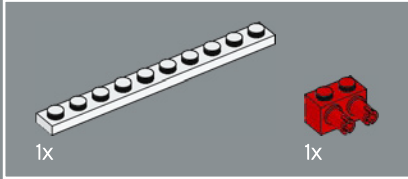
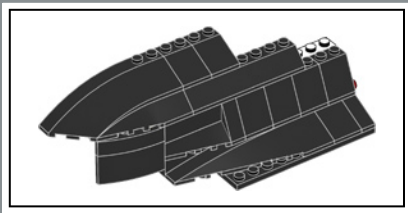

253

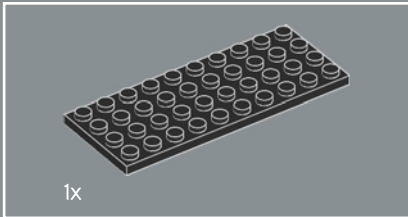
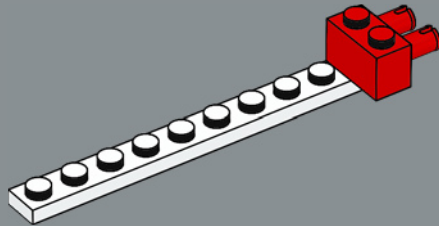

254

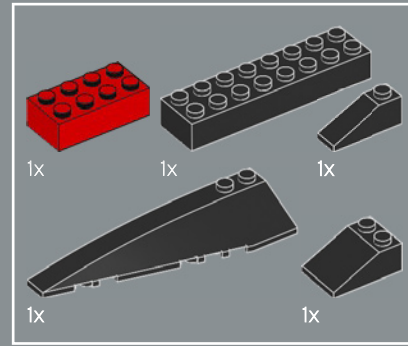
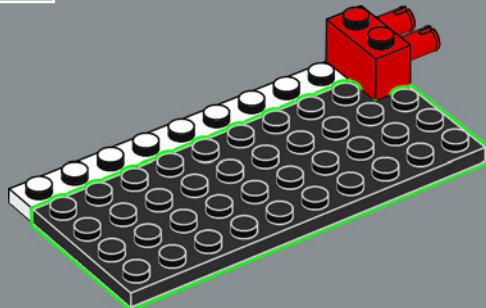

255

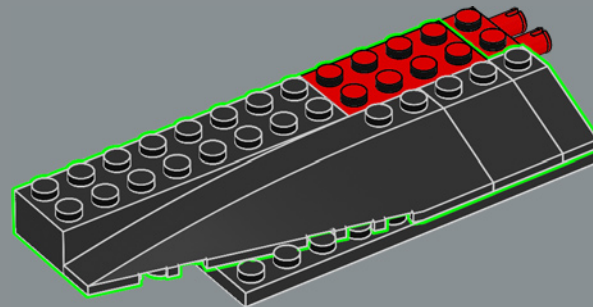

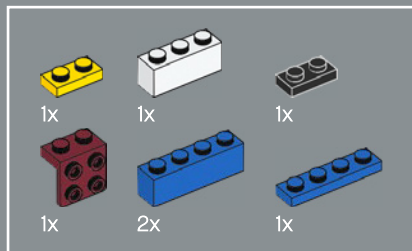

256

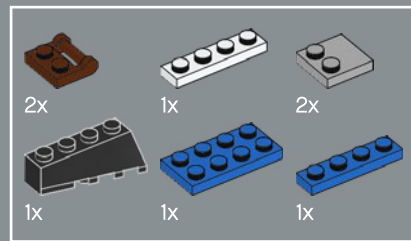
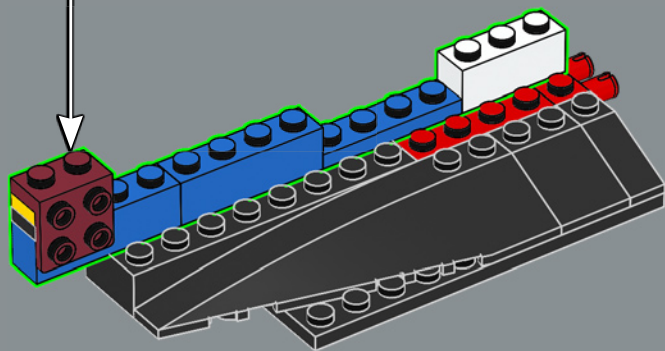
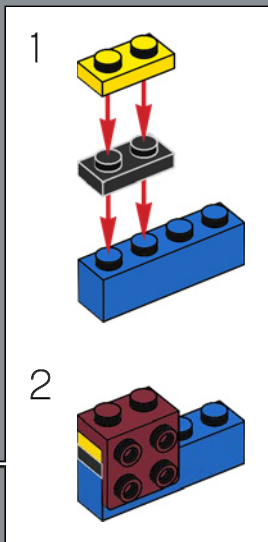

257

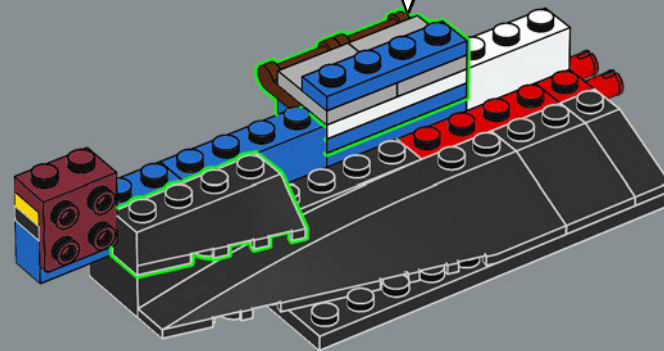
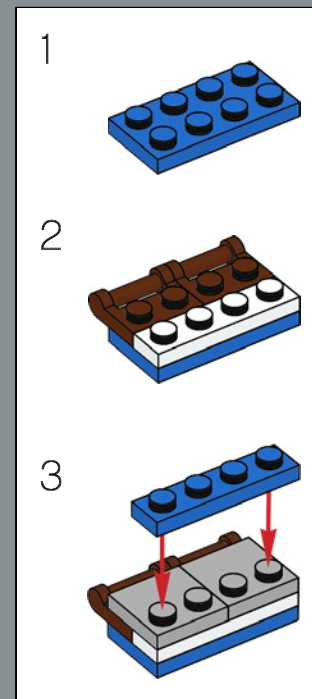

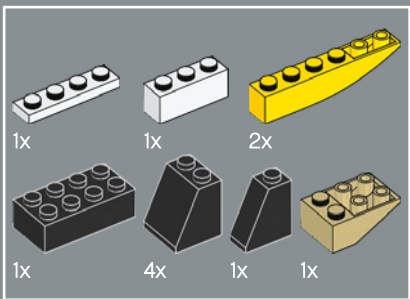

258

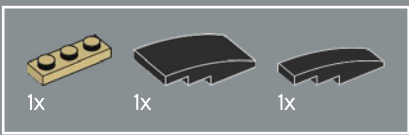
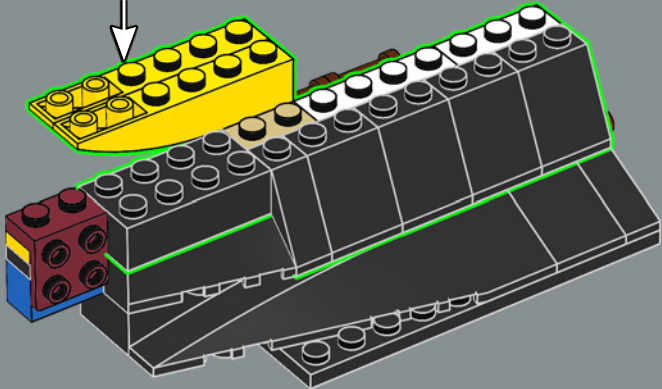
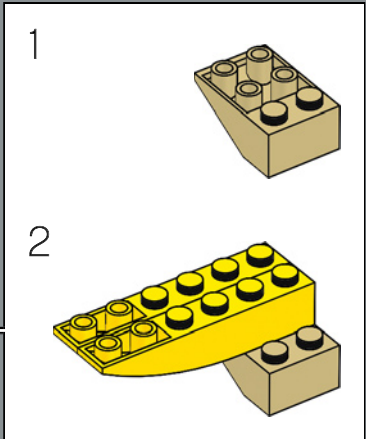

259

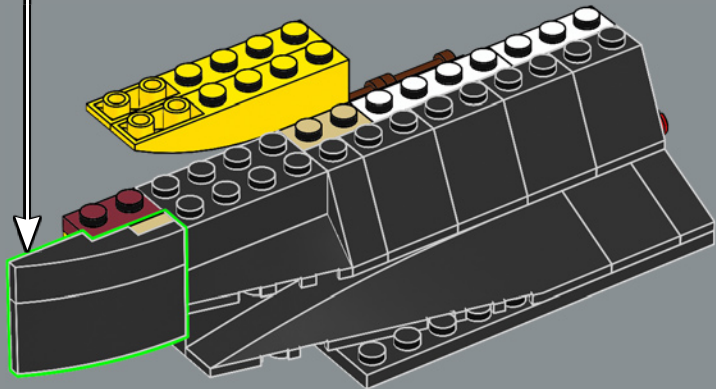
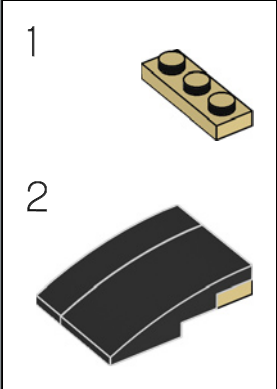



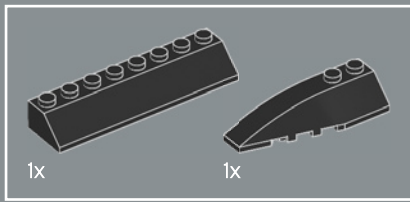

260

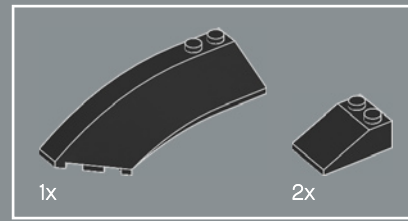
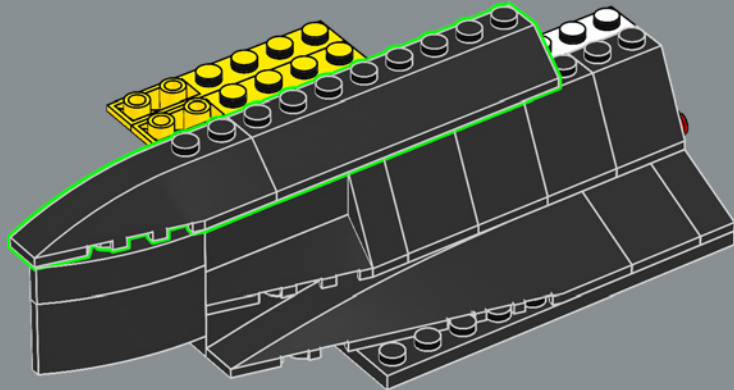

261

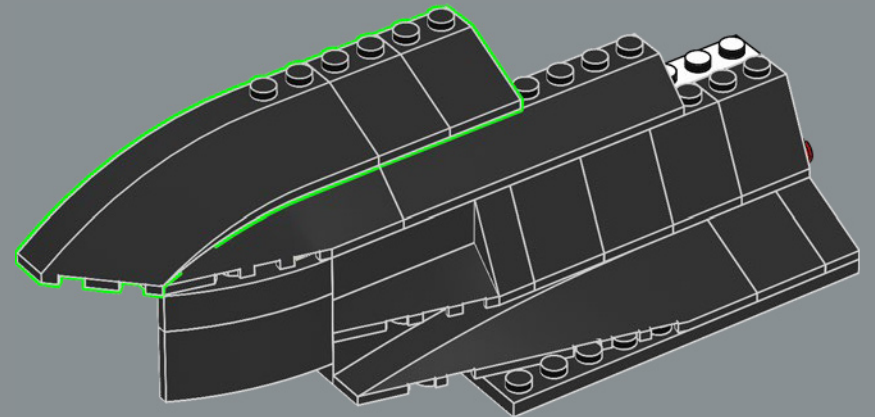

262

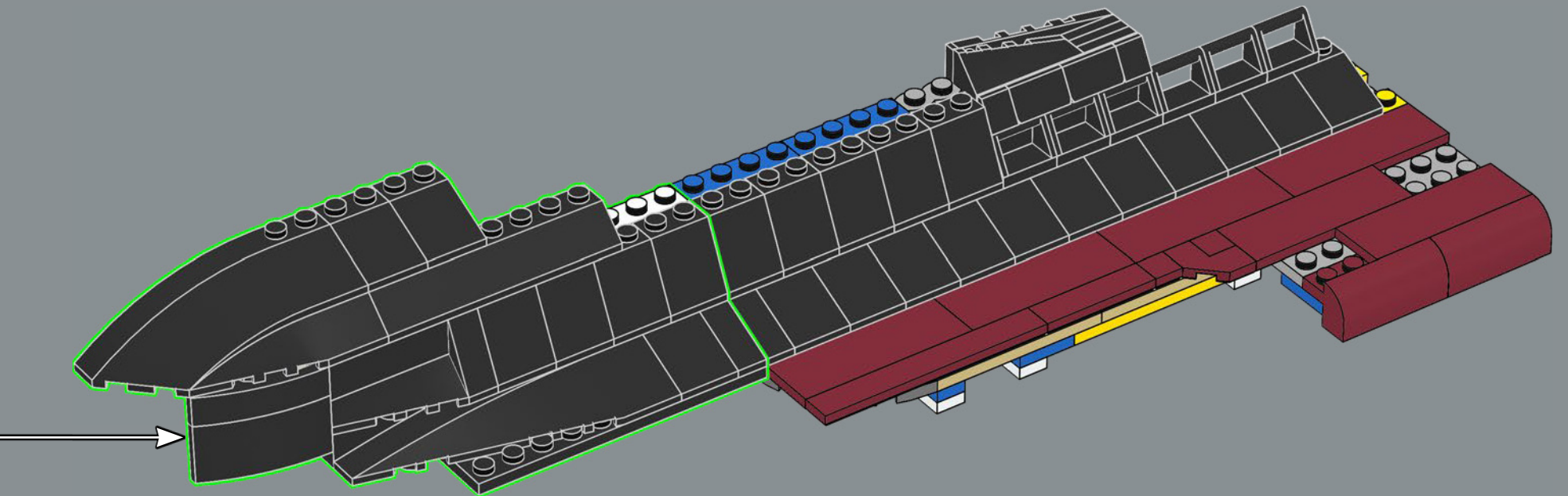

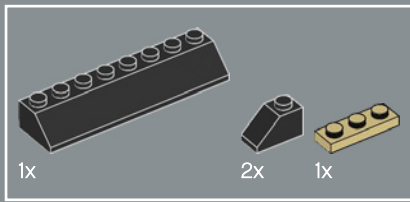

263

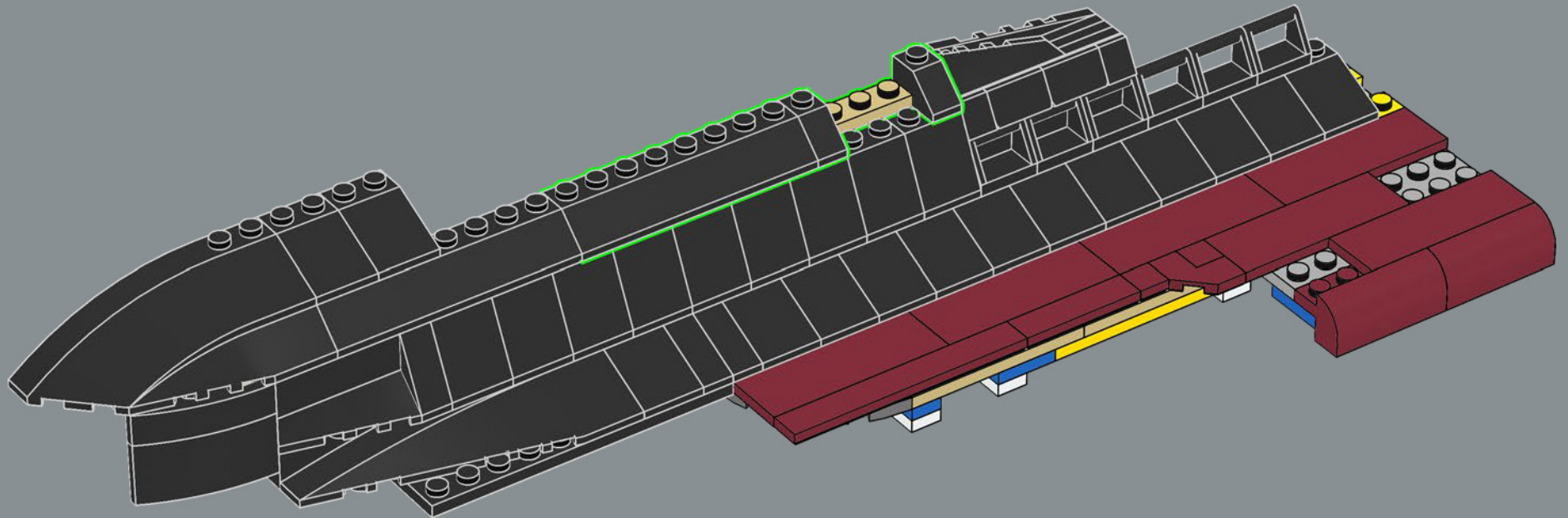

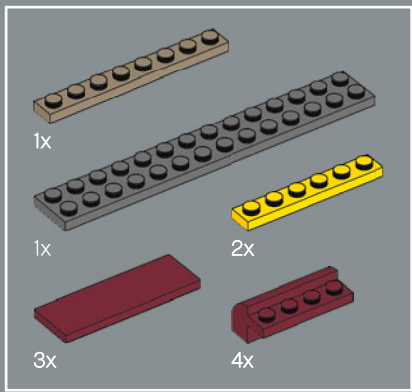

264

1

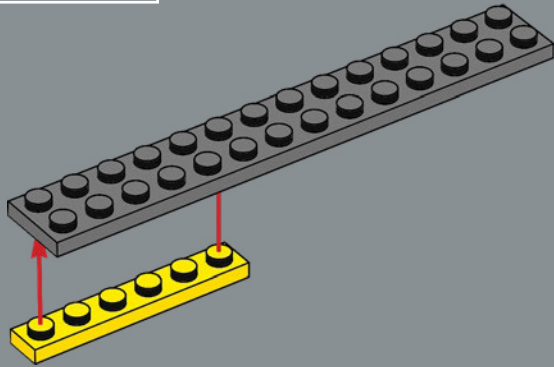

2

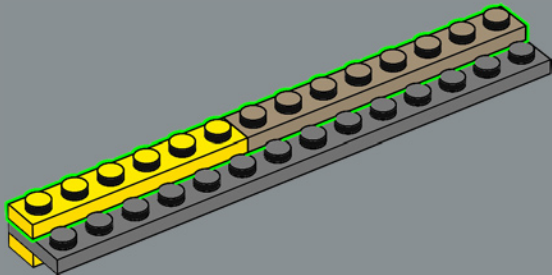

3

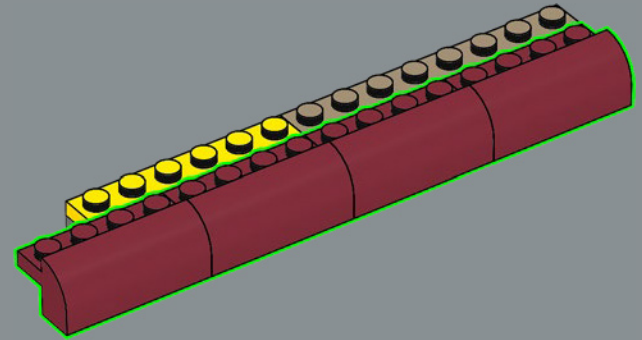

4

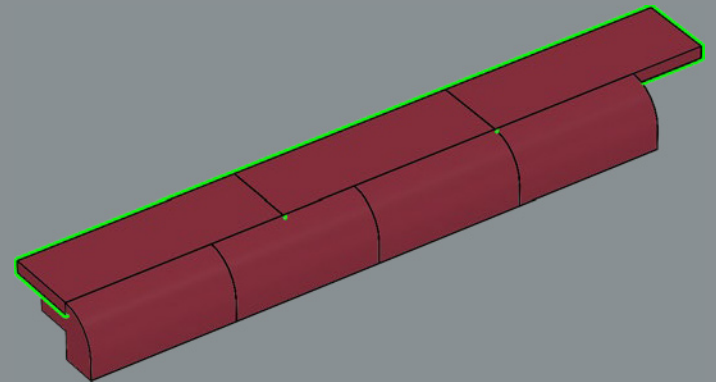

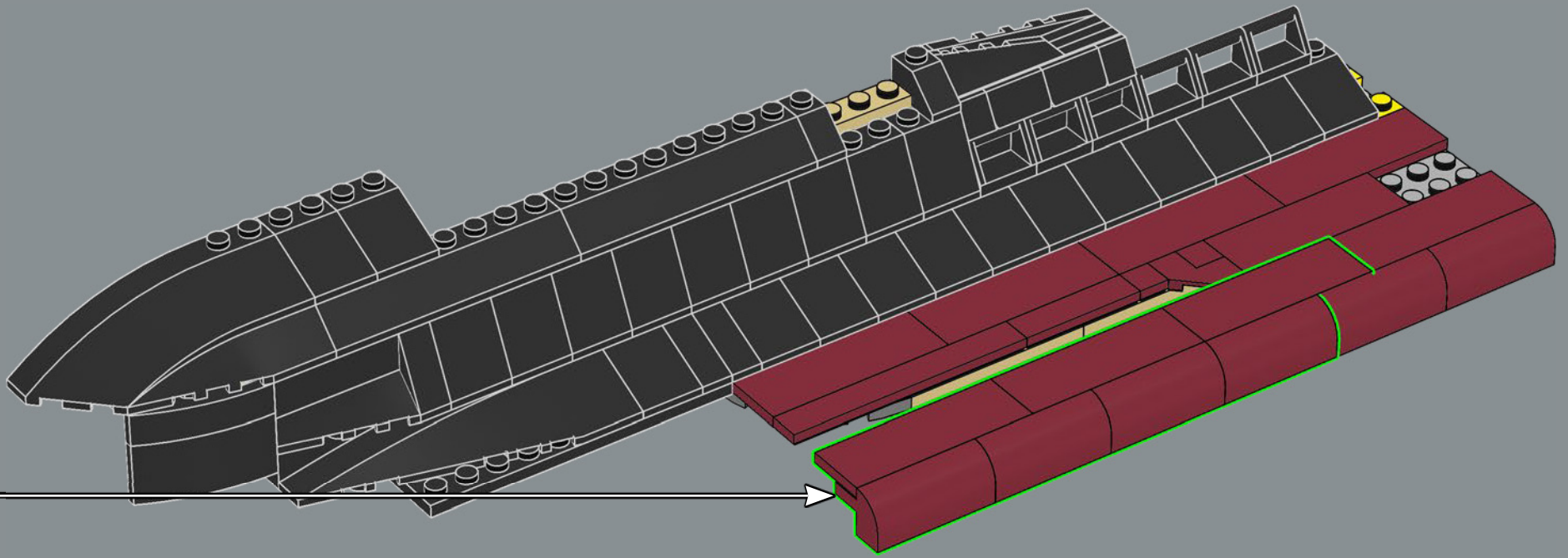

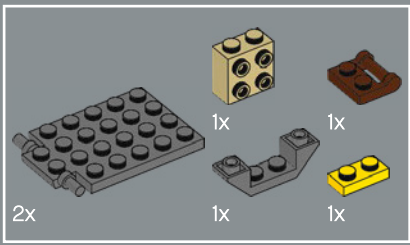

265

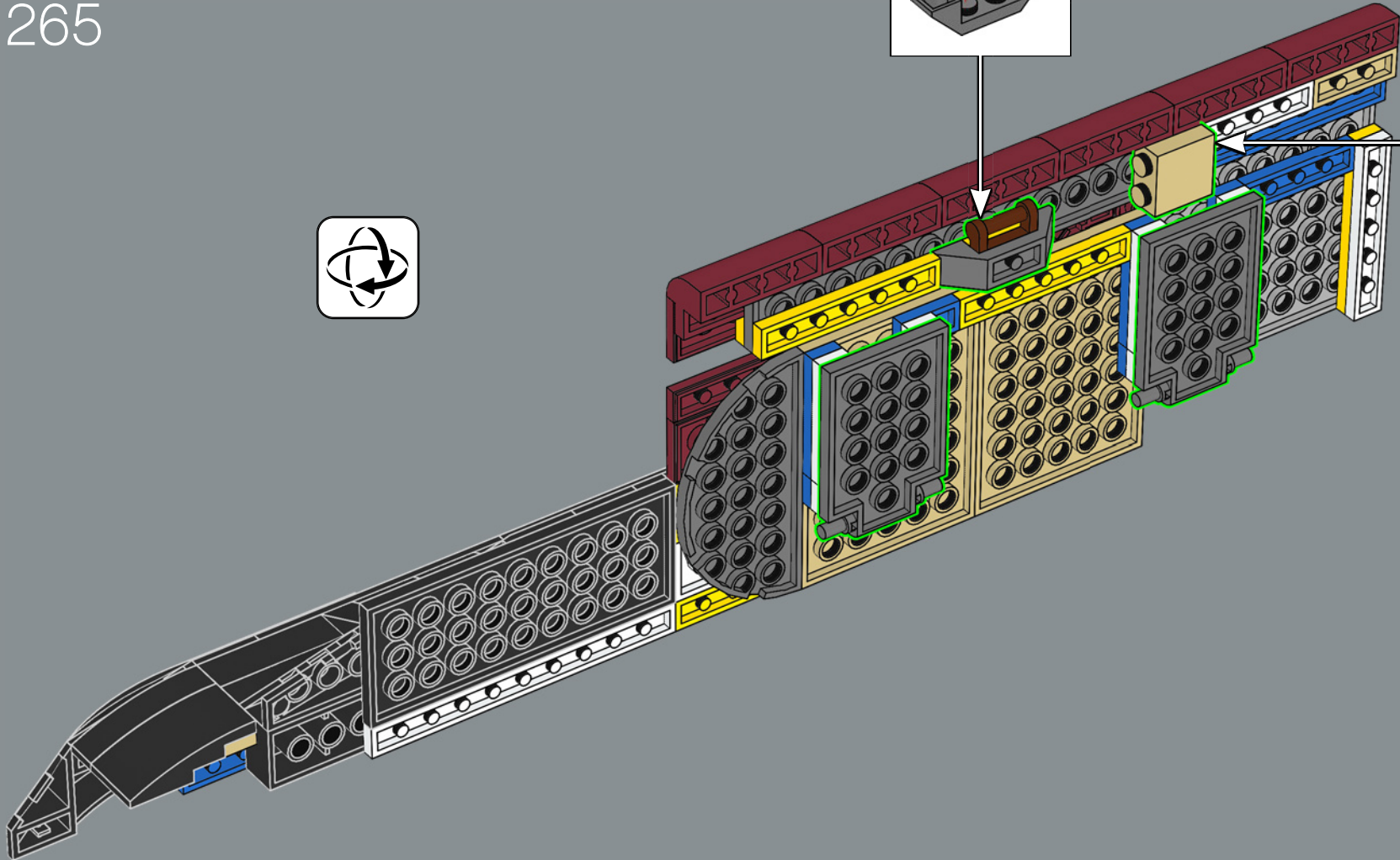
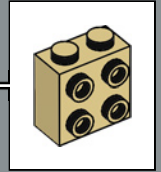
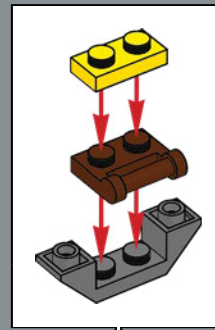

266

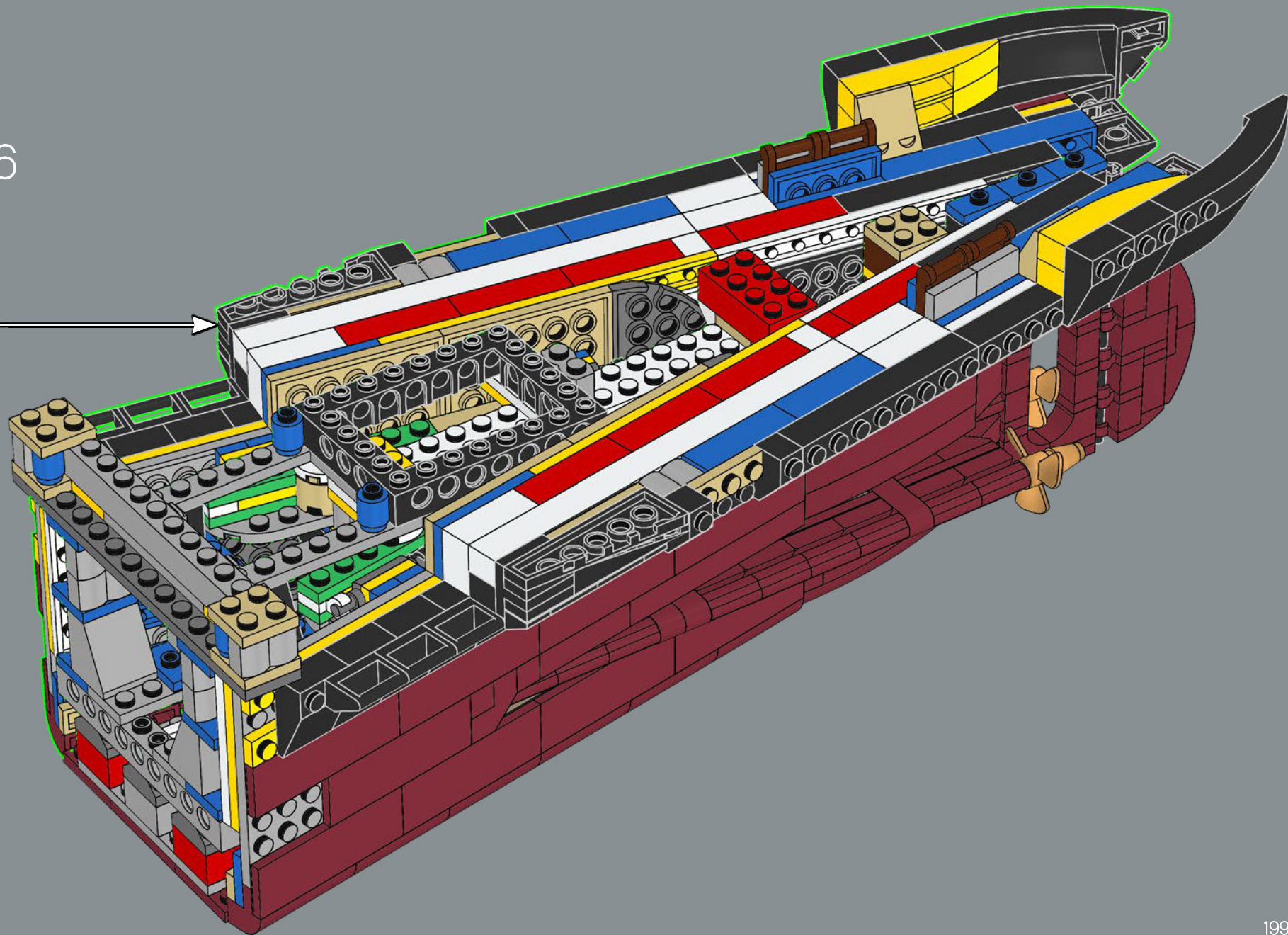

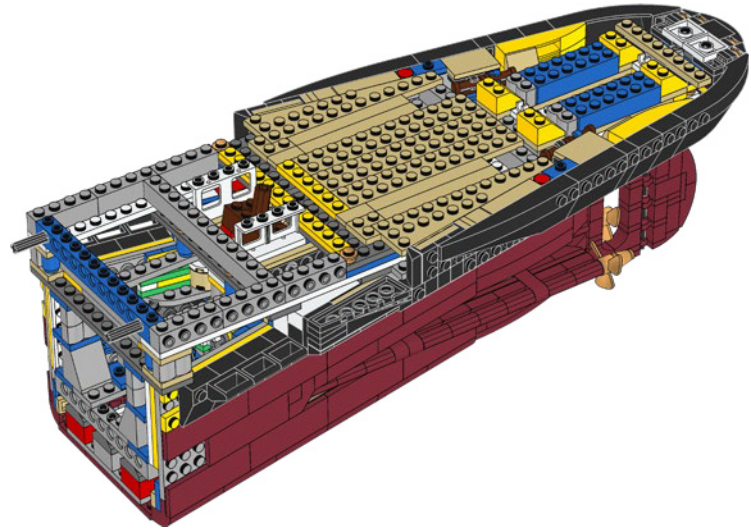
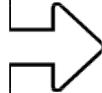



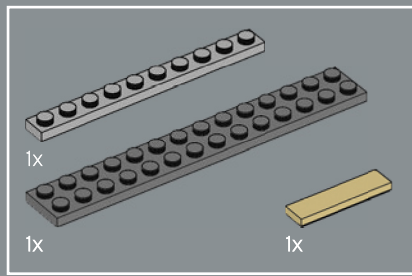

267

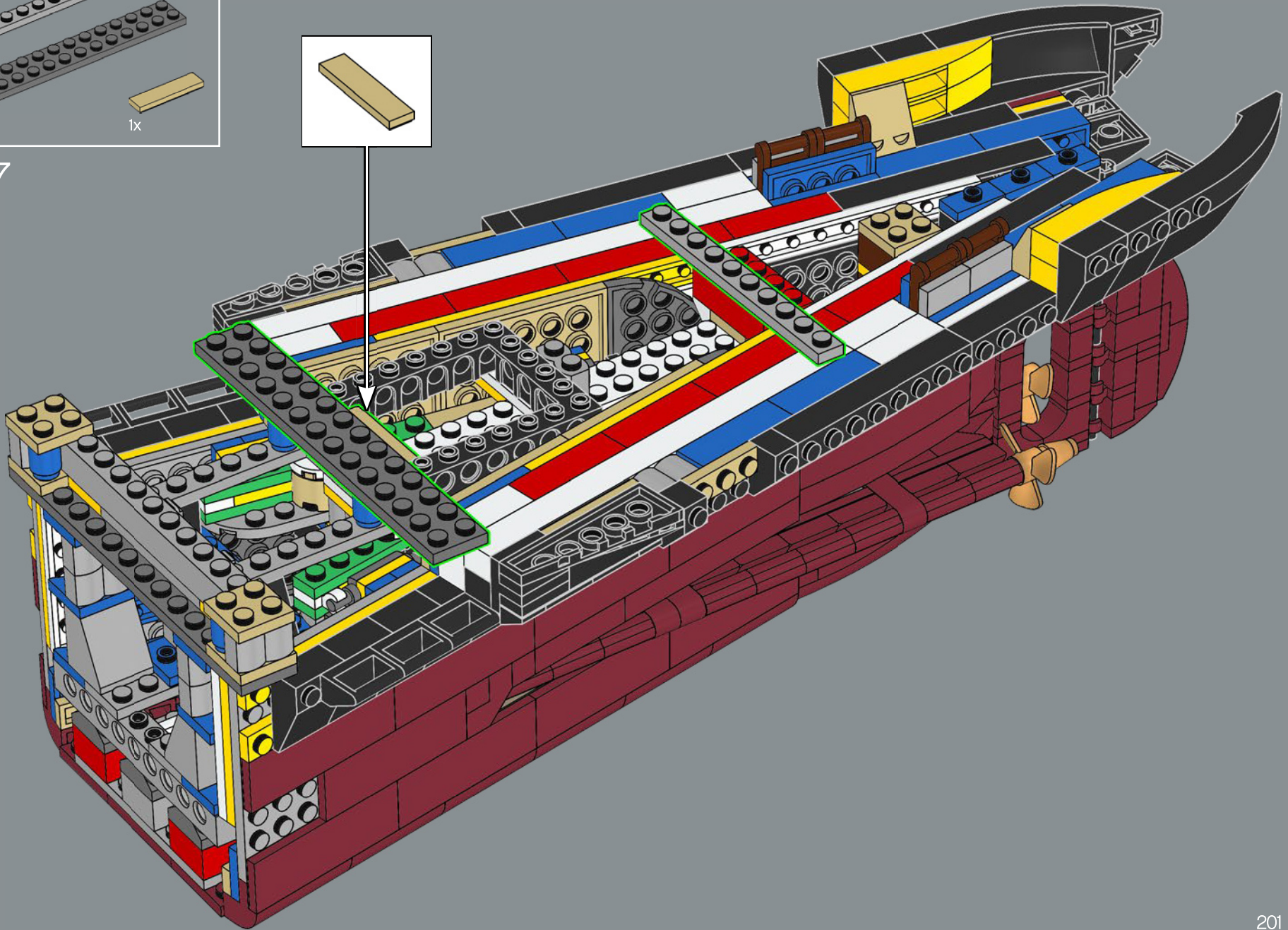
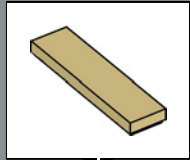

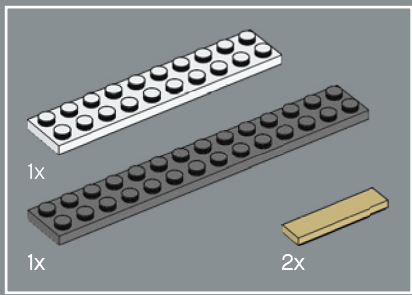

268

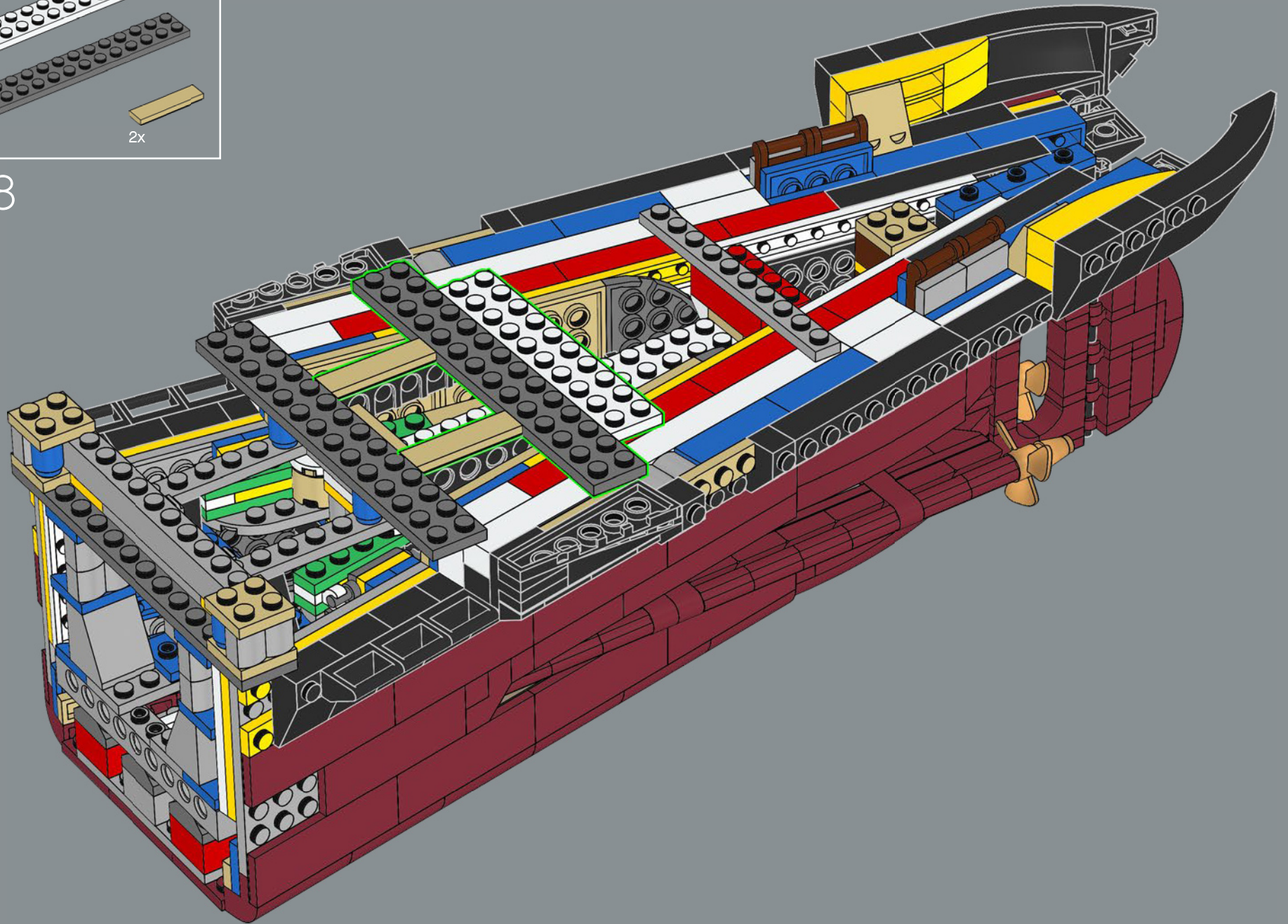

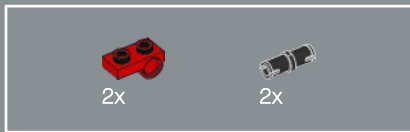

269

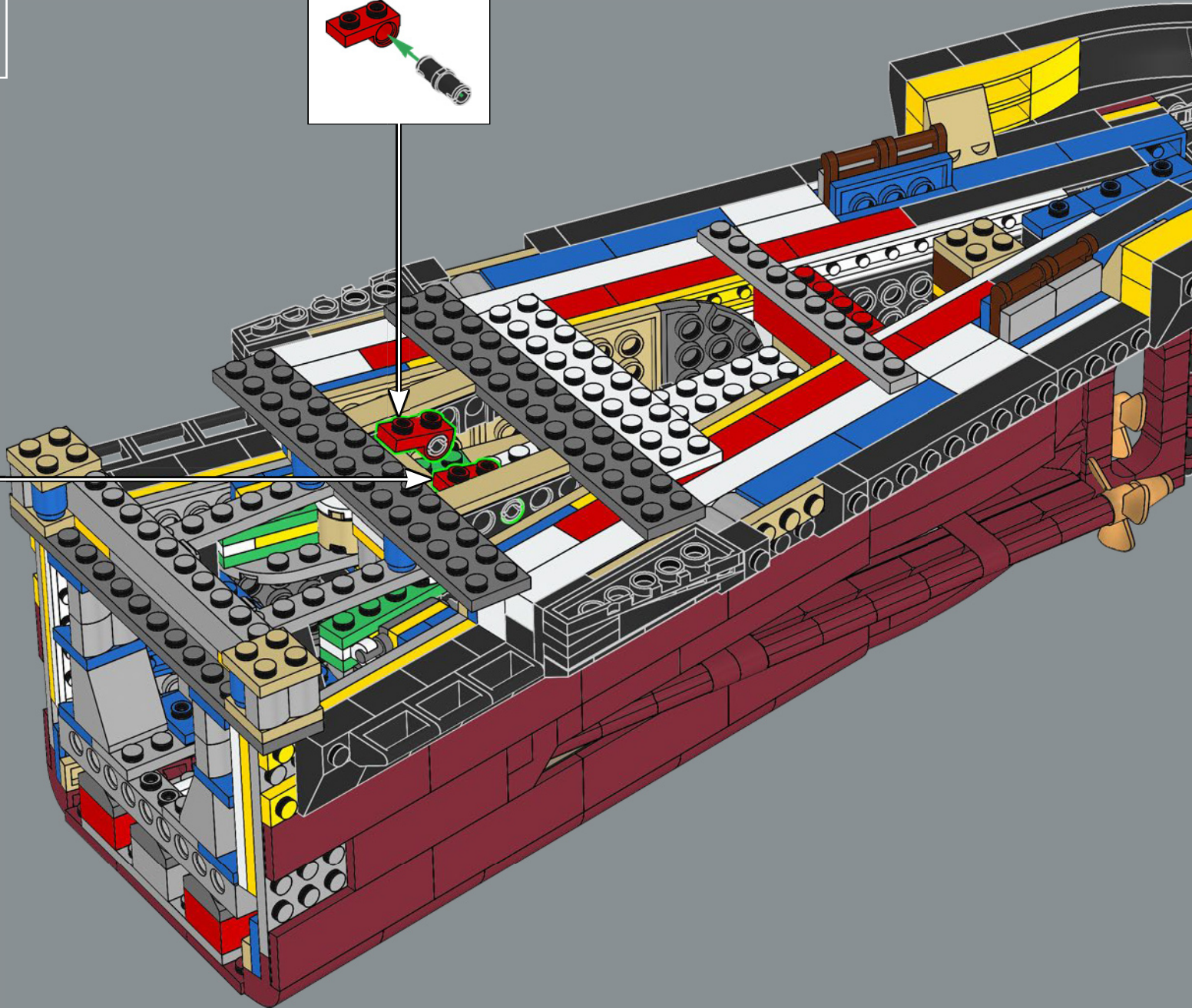
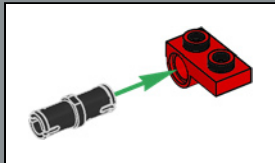
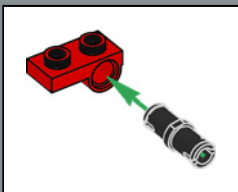

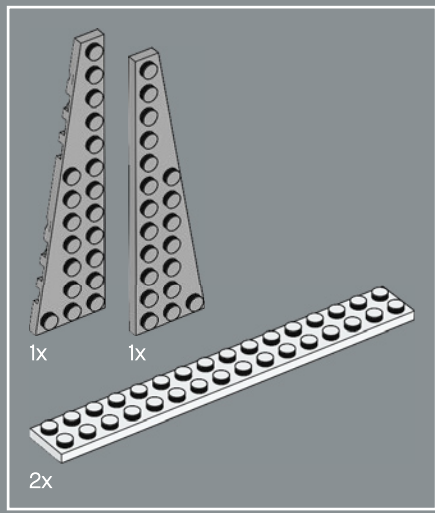

270

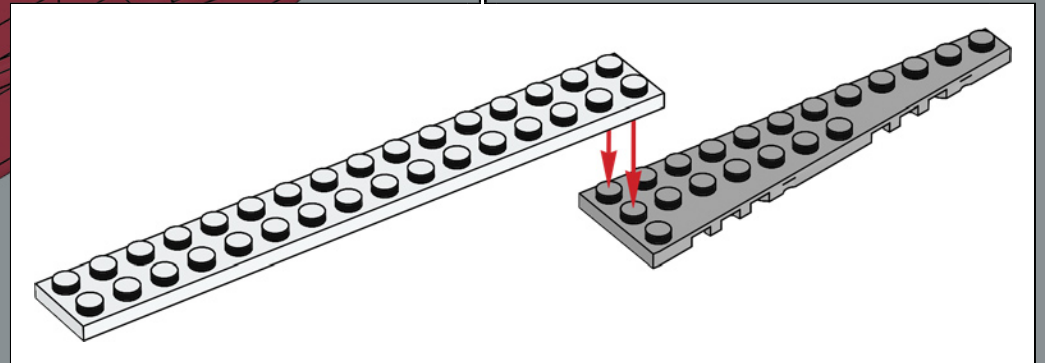
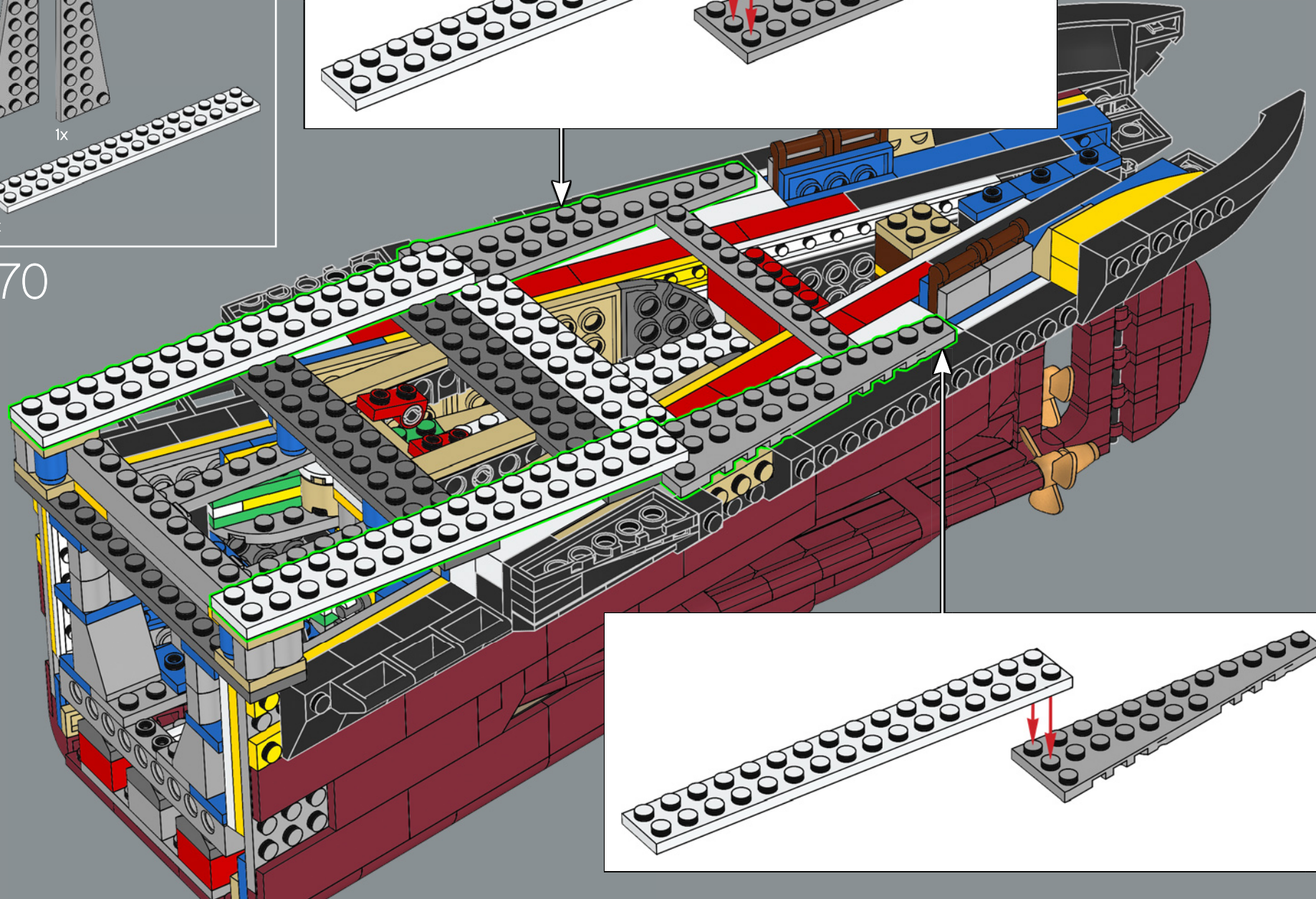
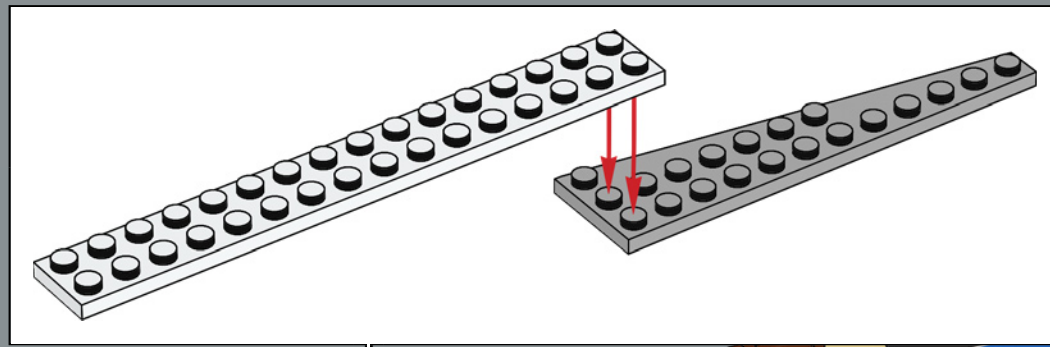

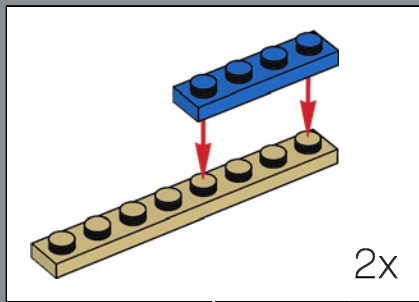
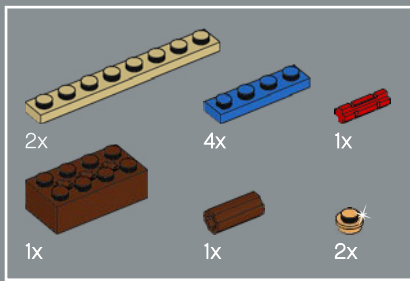

271

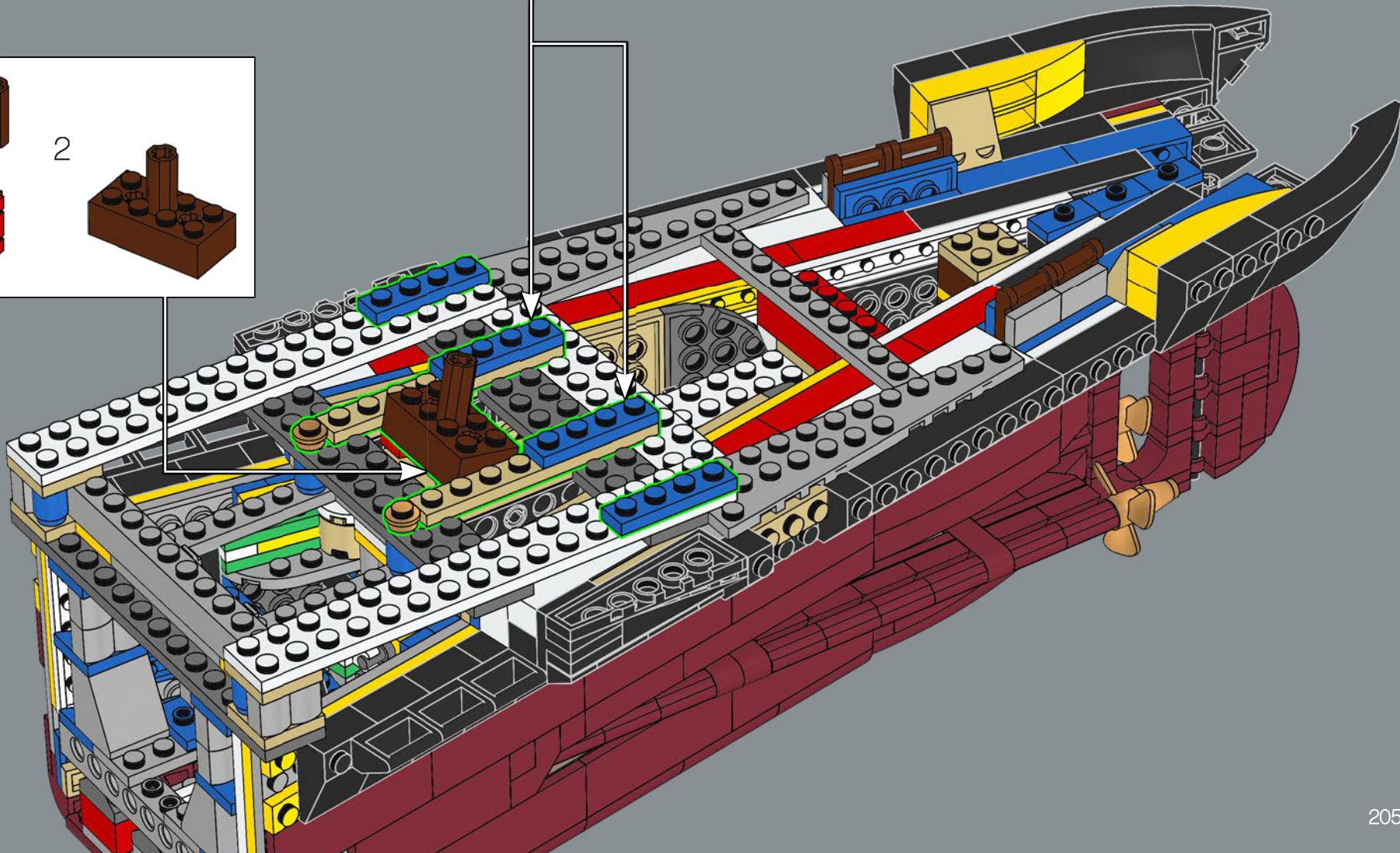
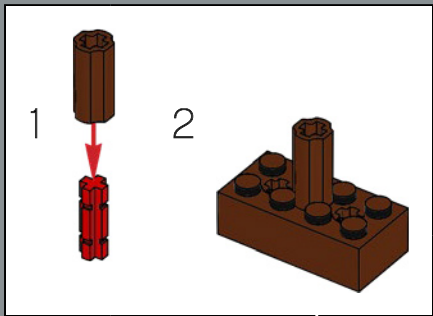

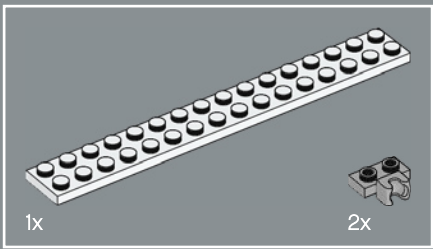

272

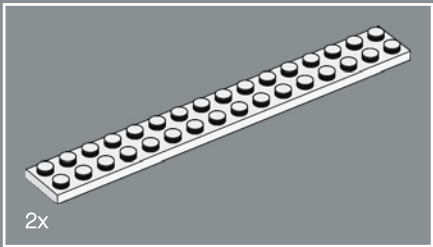
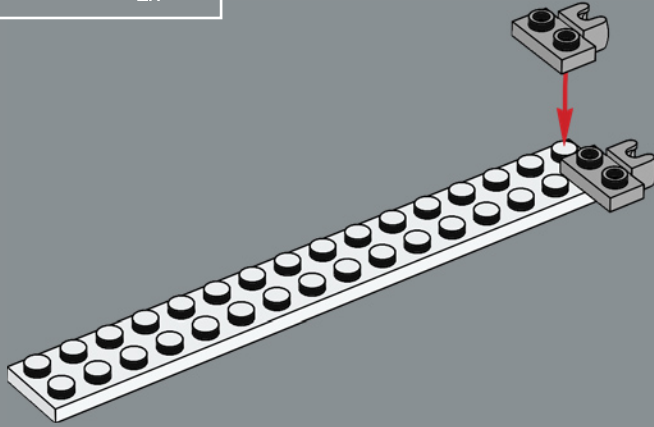

273

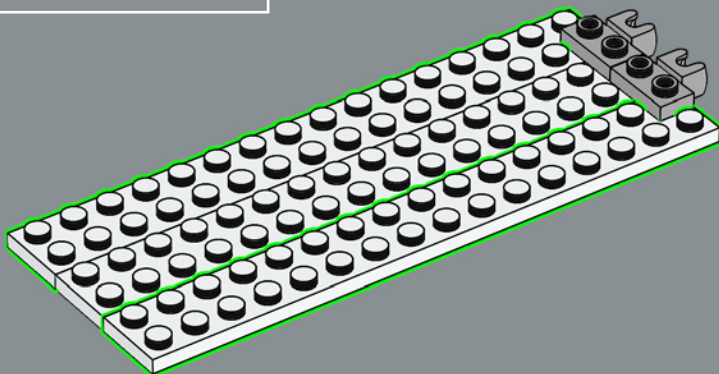

274

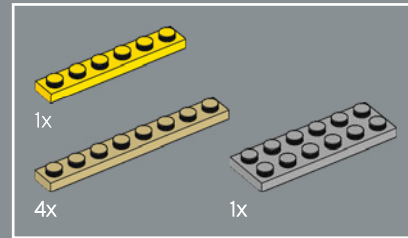
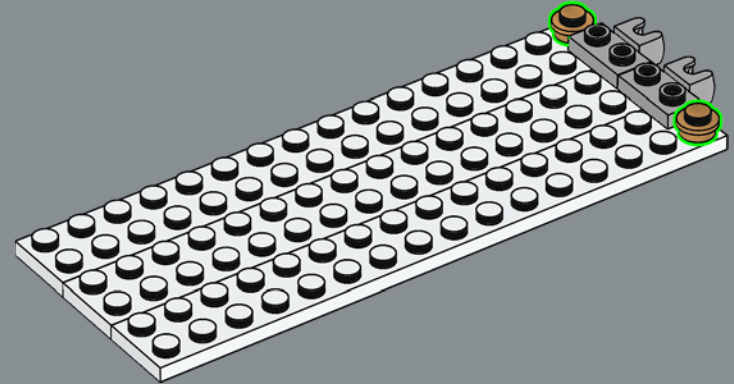

275

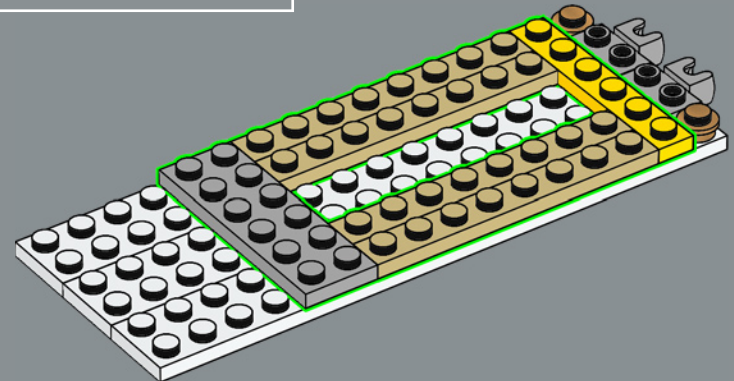

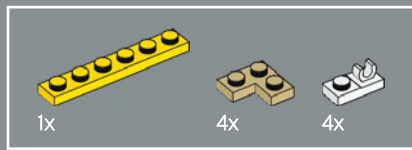

276

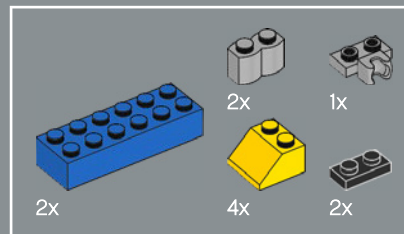
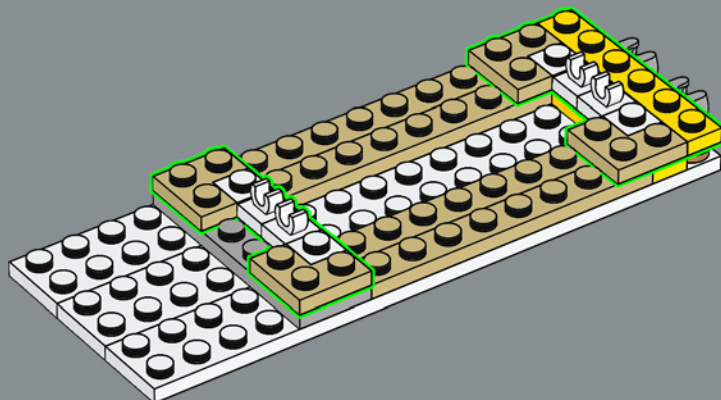

277

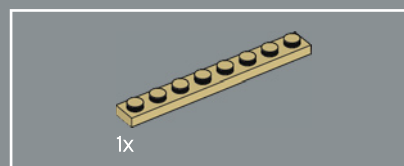
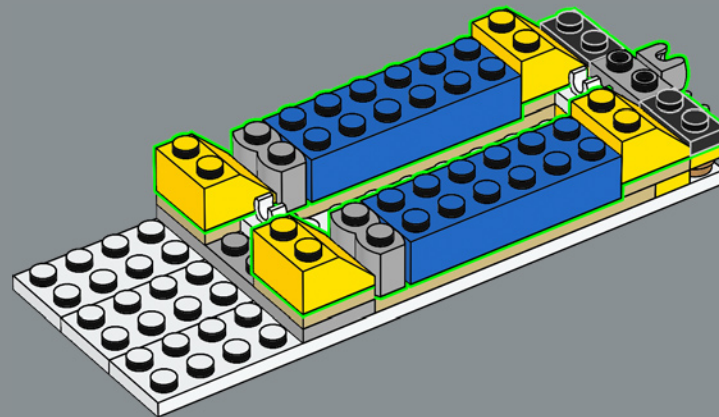

278

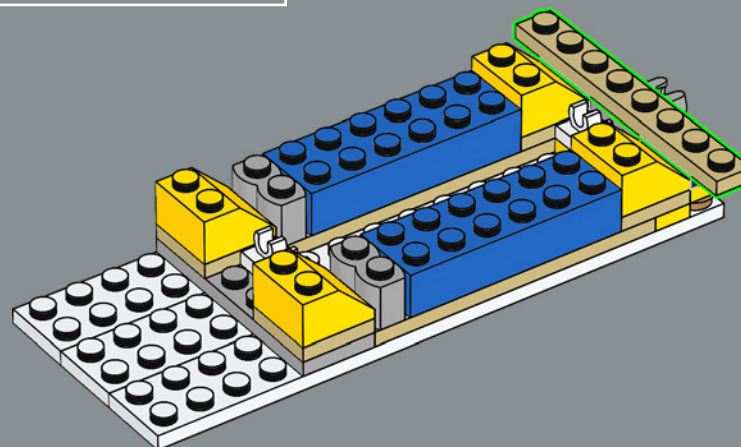

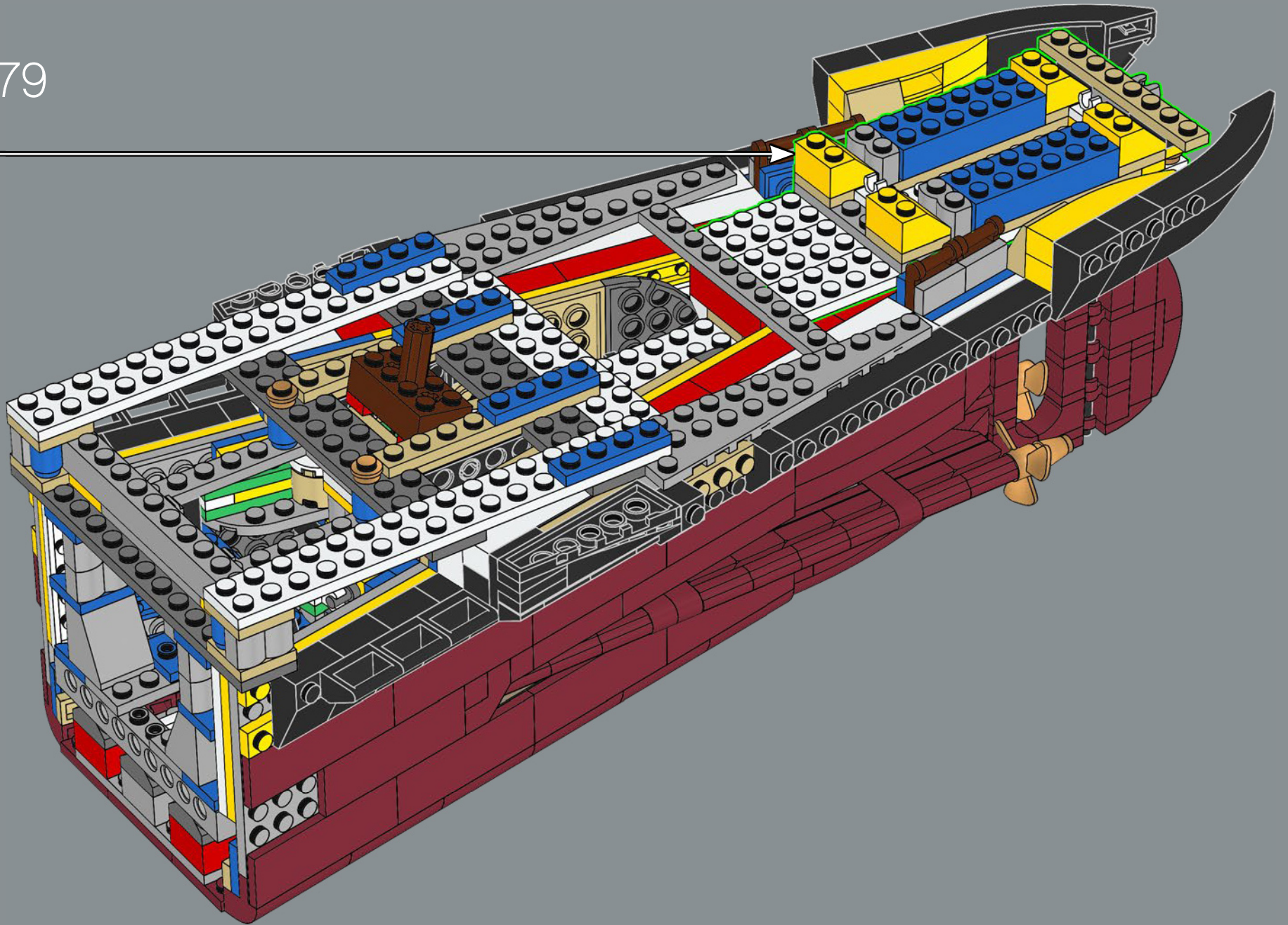





280

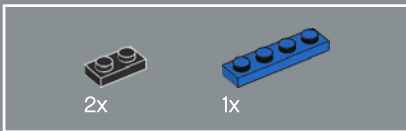
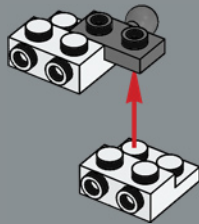

281

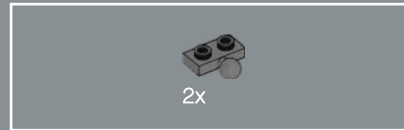
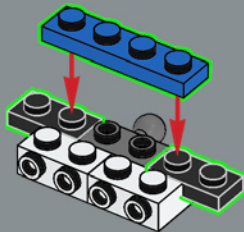

282

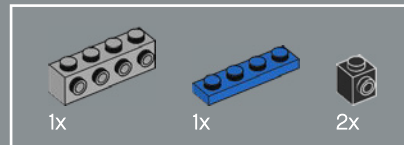
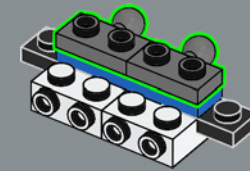

283

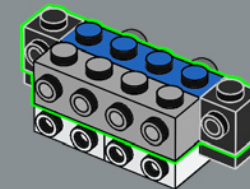

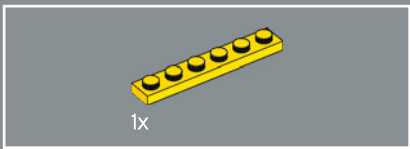

1x

284

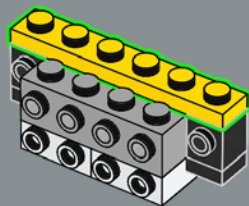

2x

285

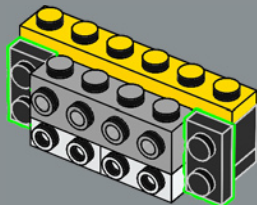

4x

286

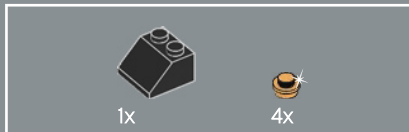
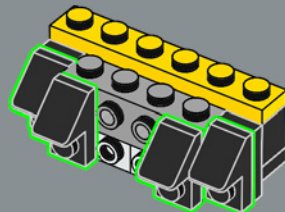

1x

4x

287

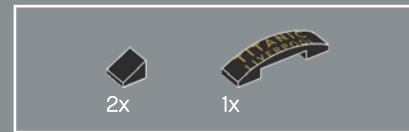
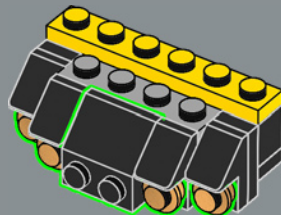

2x

1x

288

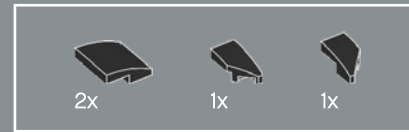
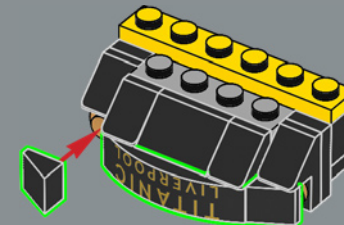

2x

1x

1x

289

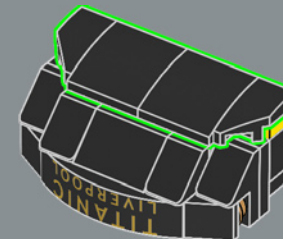

Le Titanic ne possède ni projecteur ni système de sonorisation.

290

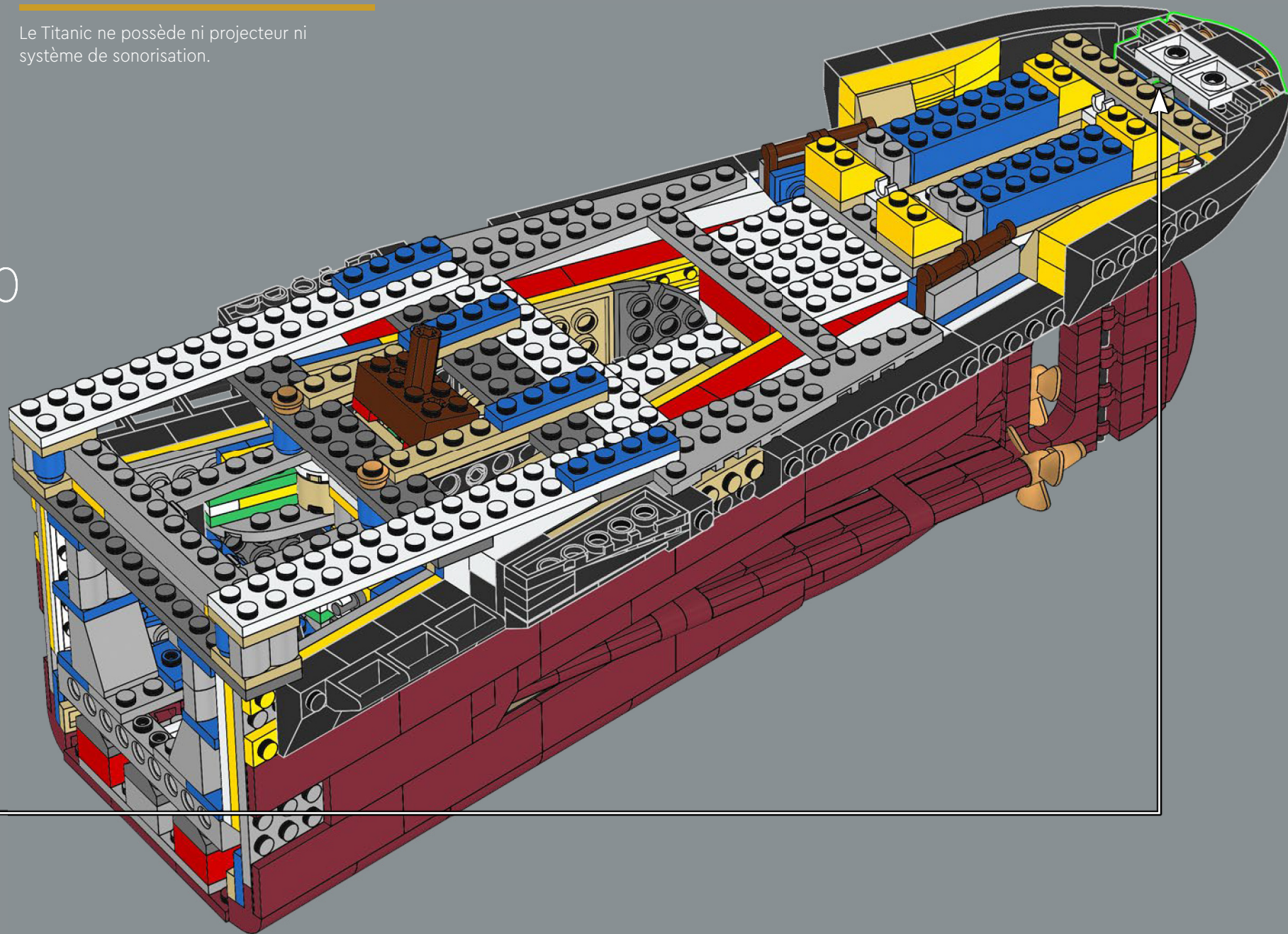

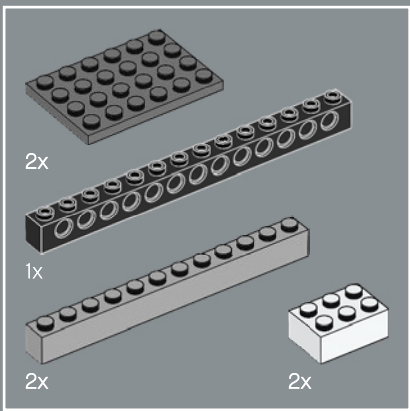

291

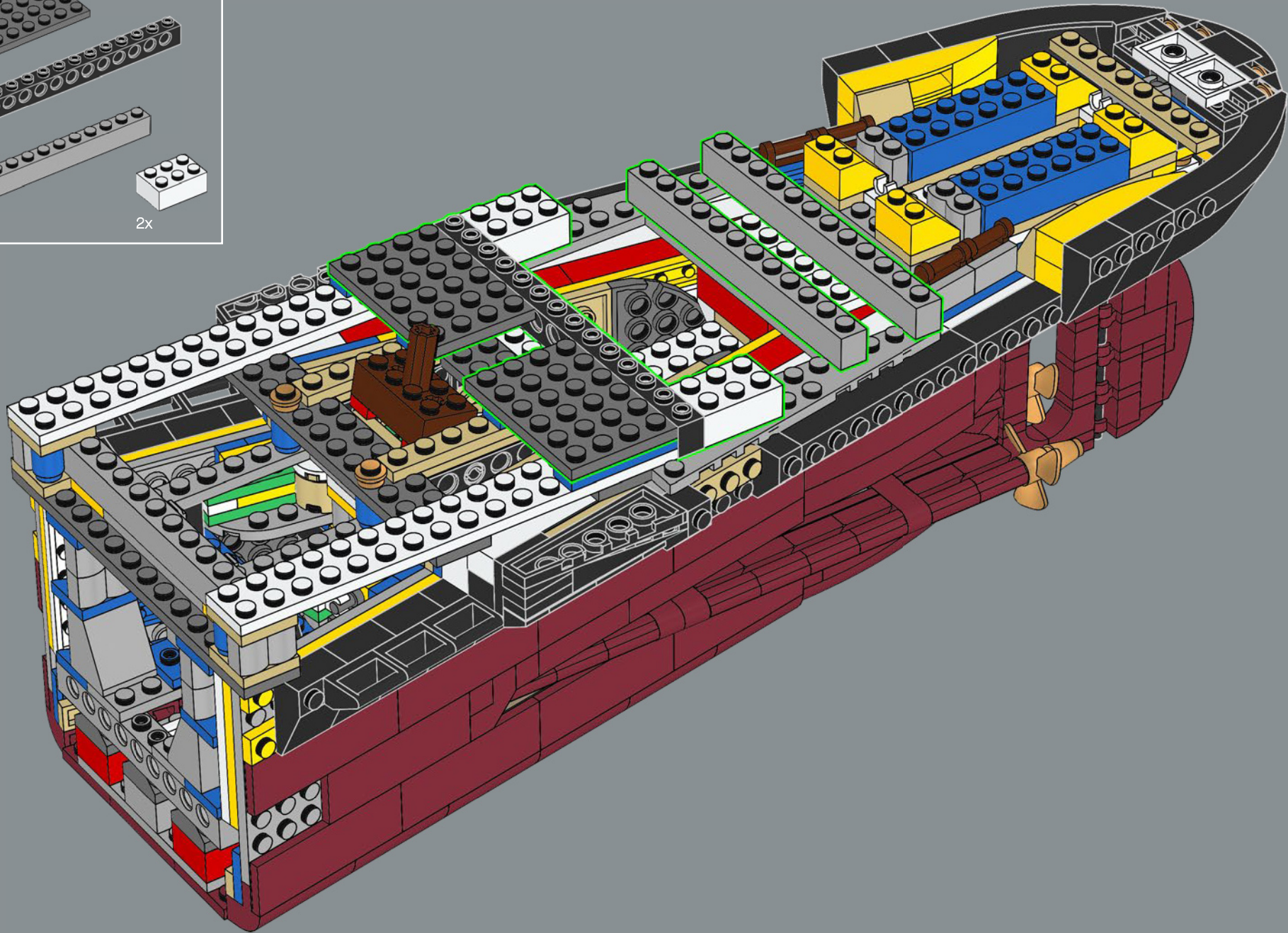

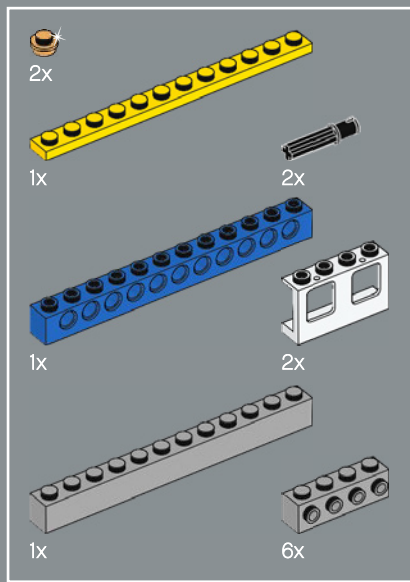

292

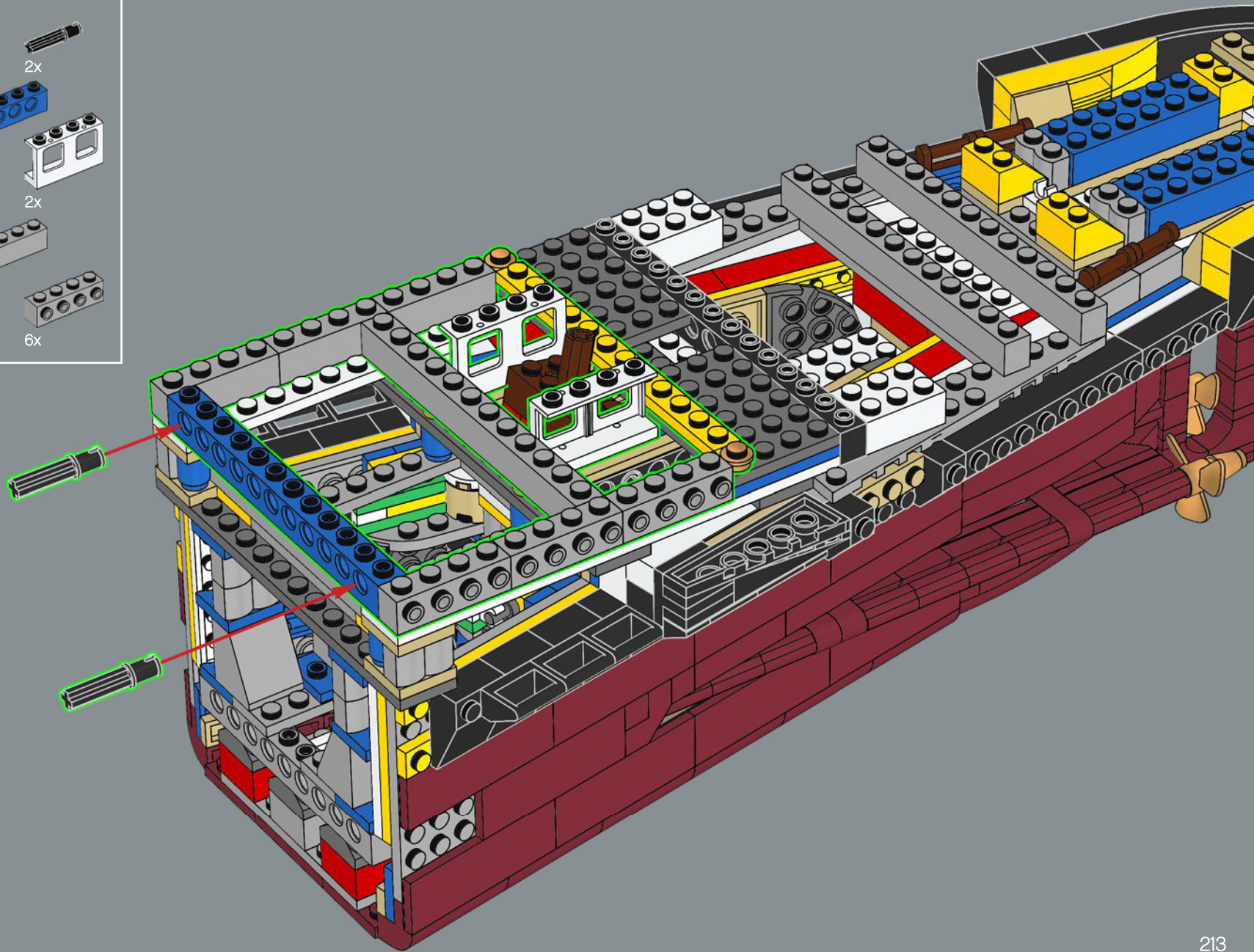

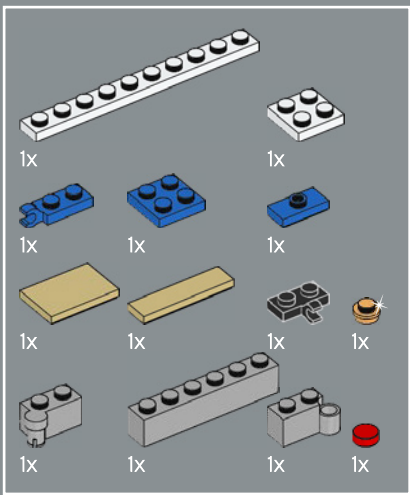

293

1

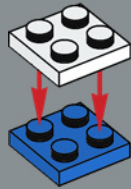

2

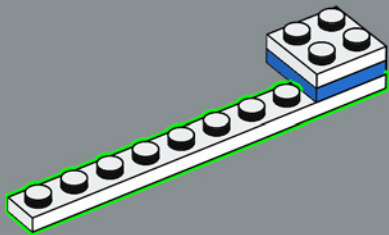

3

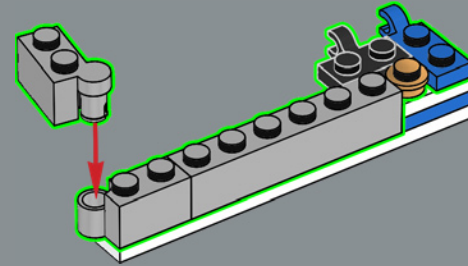

4

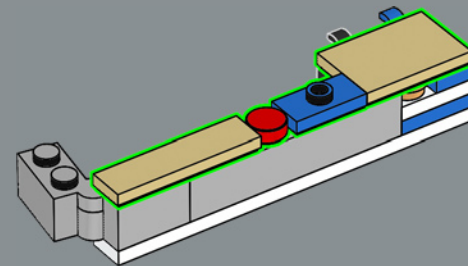

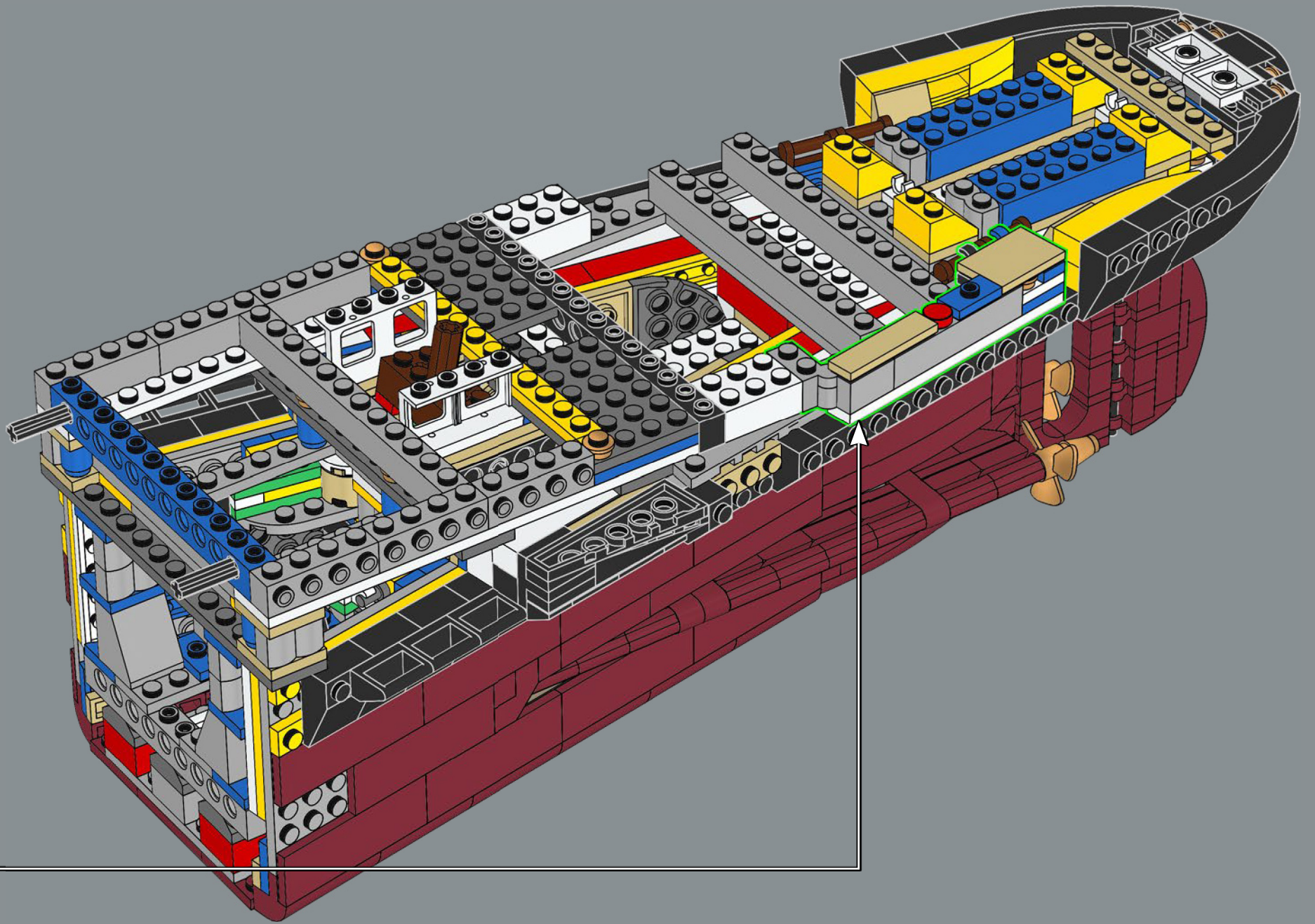

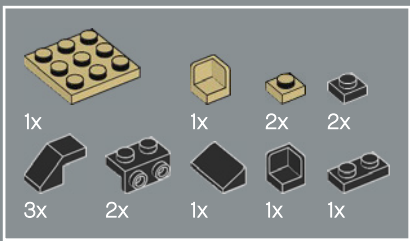

294

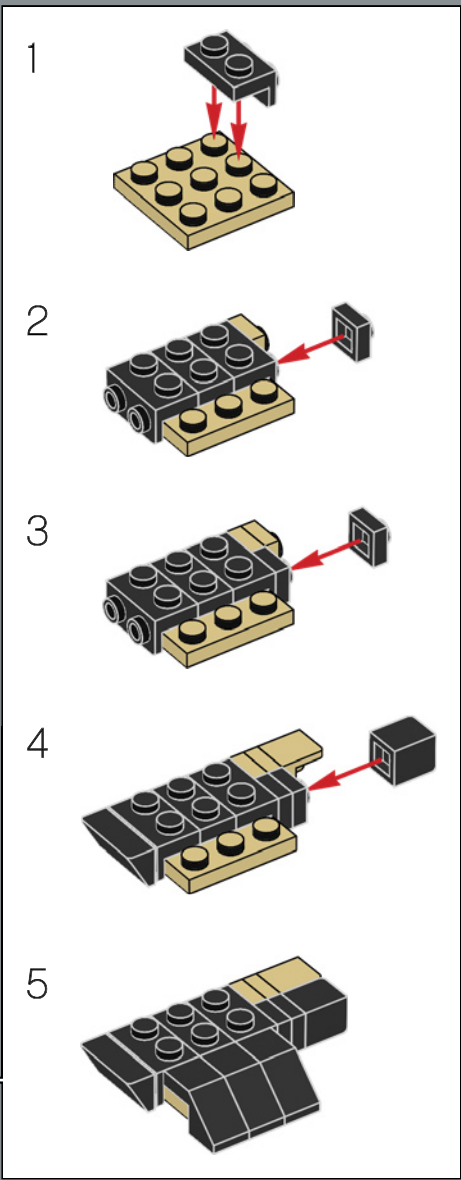
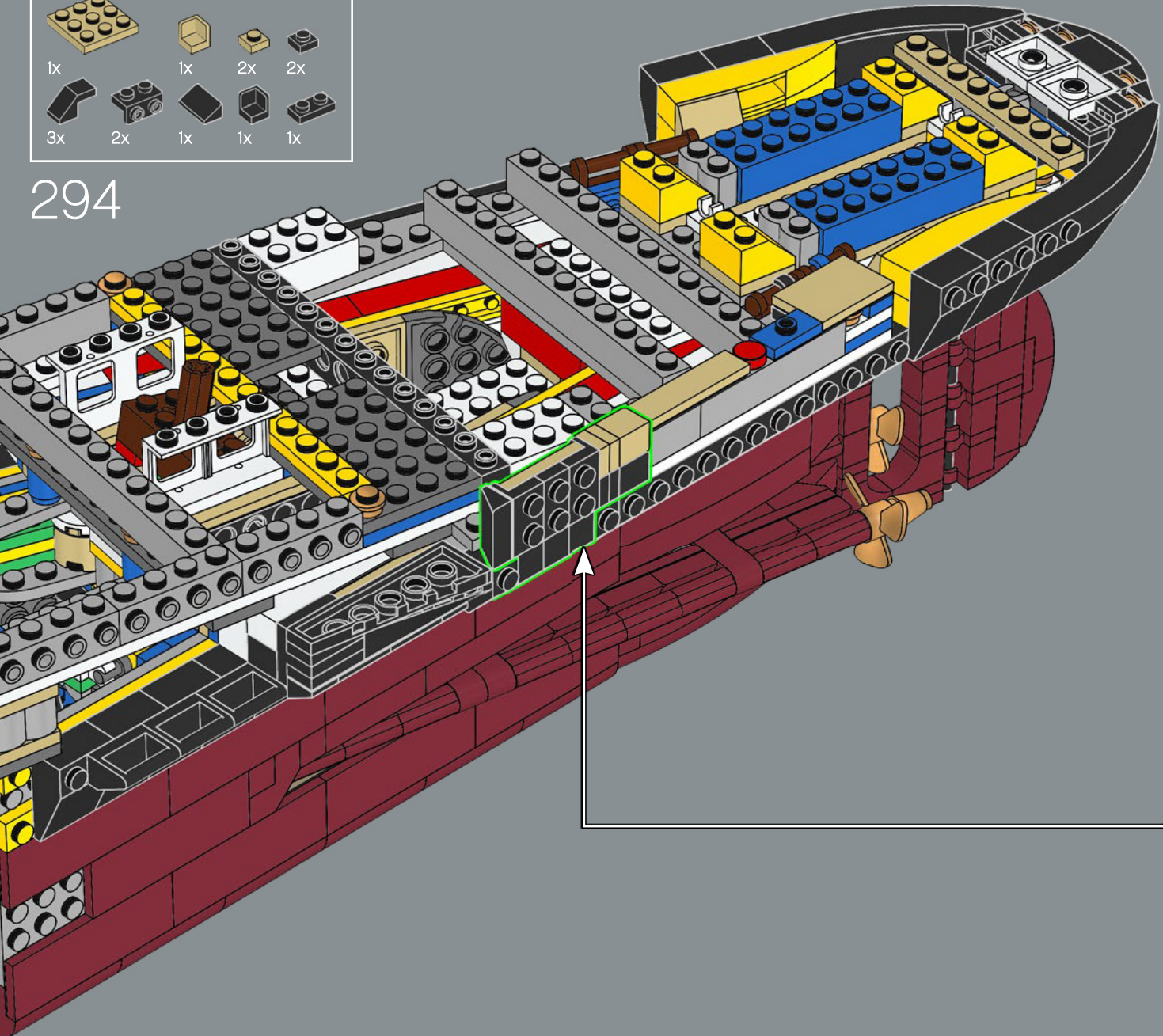



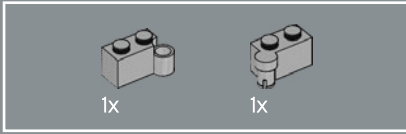
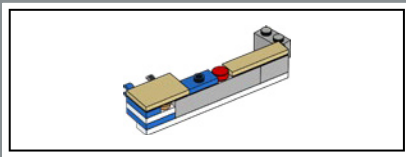

295

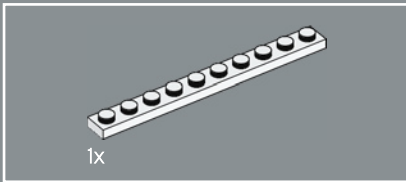
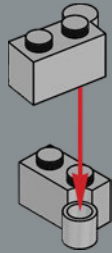

296

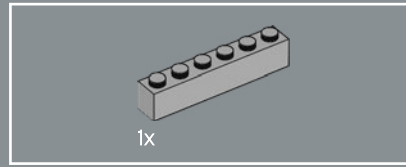
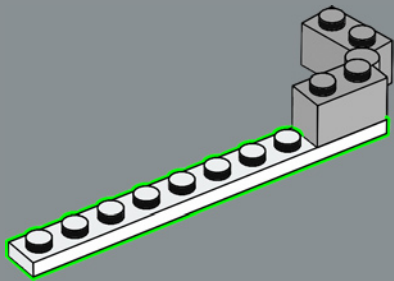

297

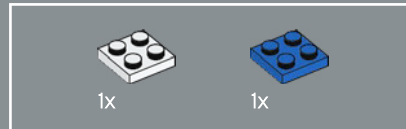
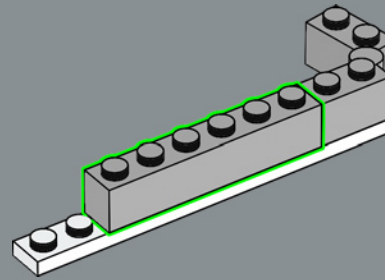

298

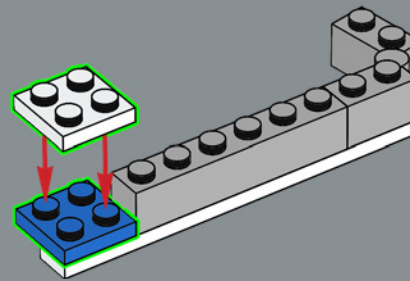

299

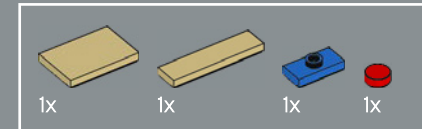
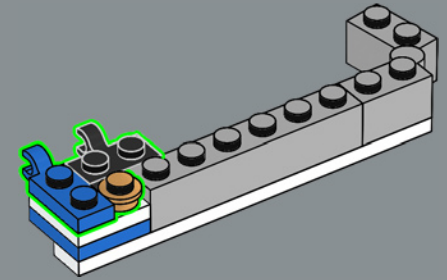

300

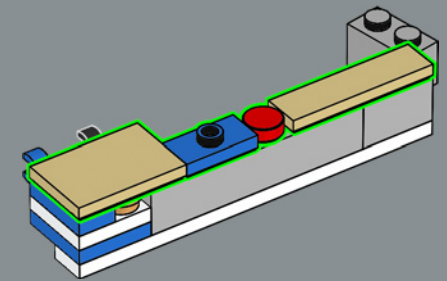

301

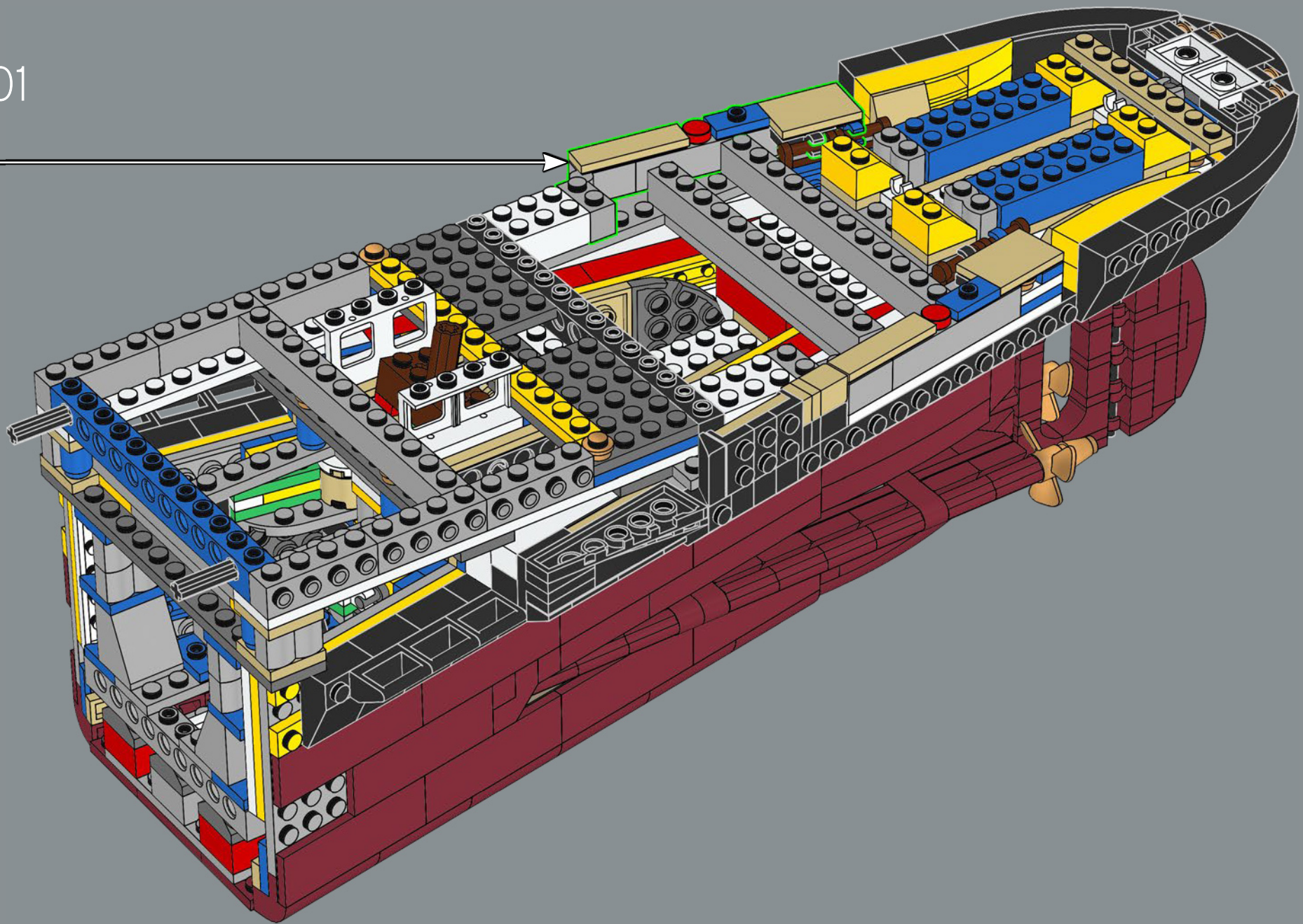

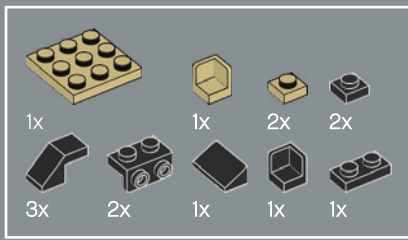

302

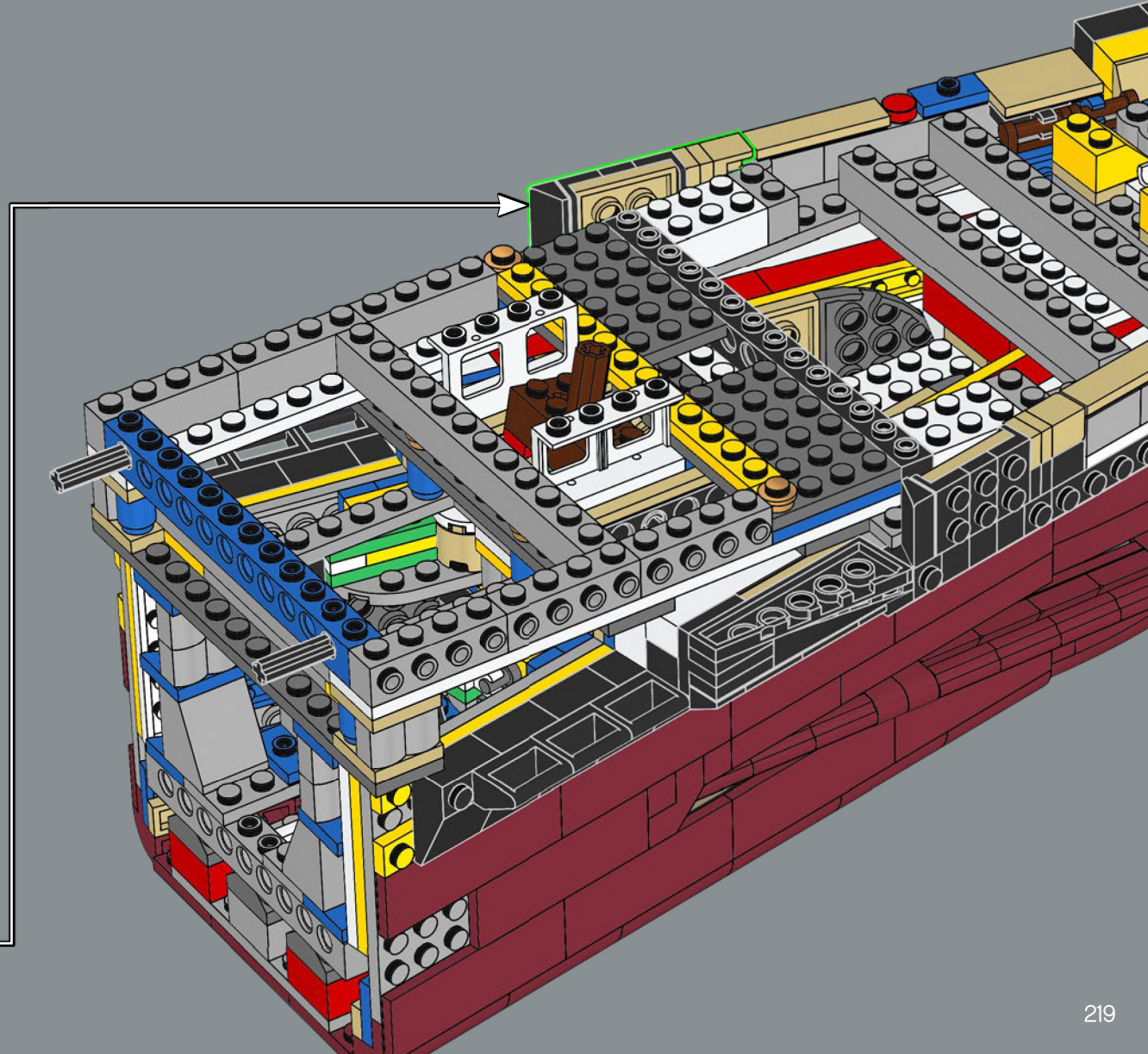
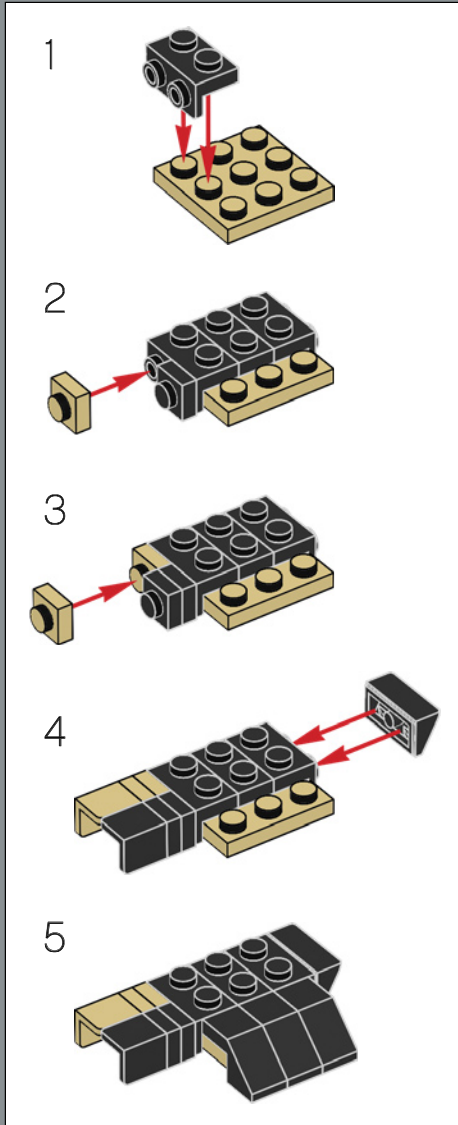

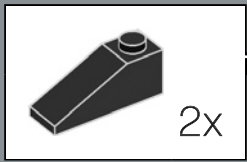
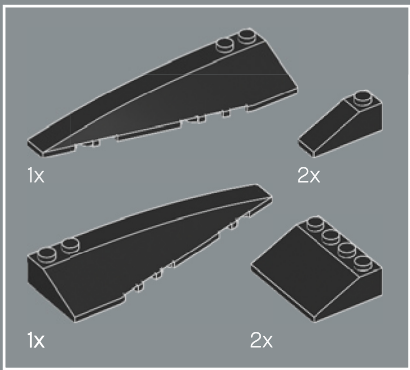

303

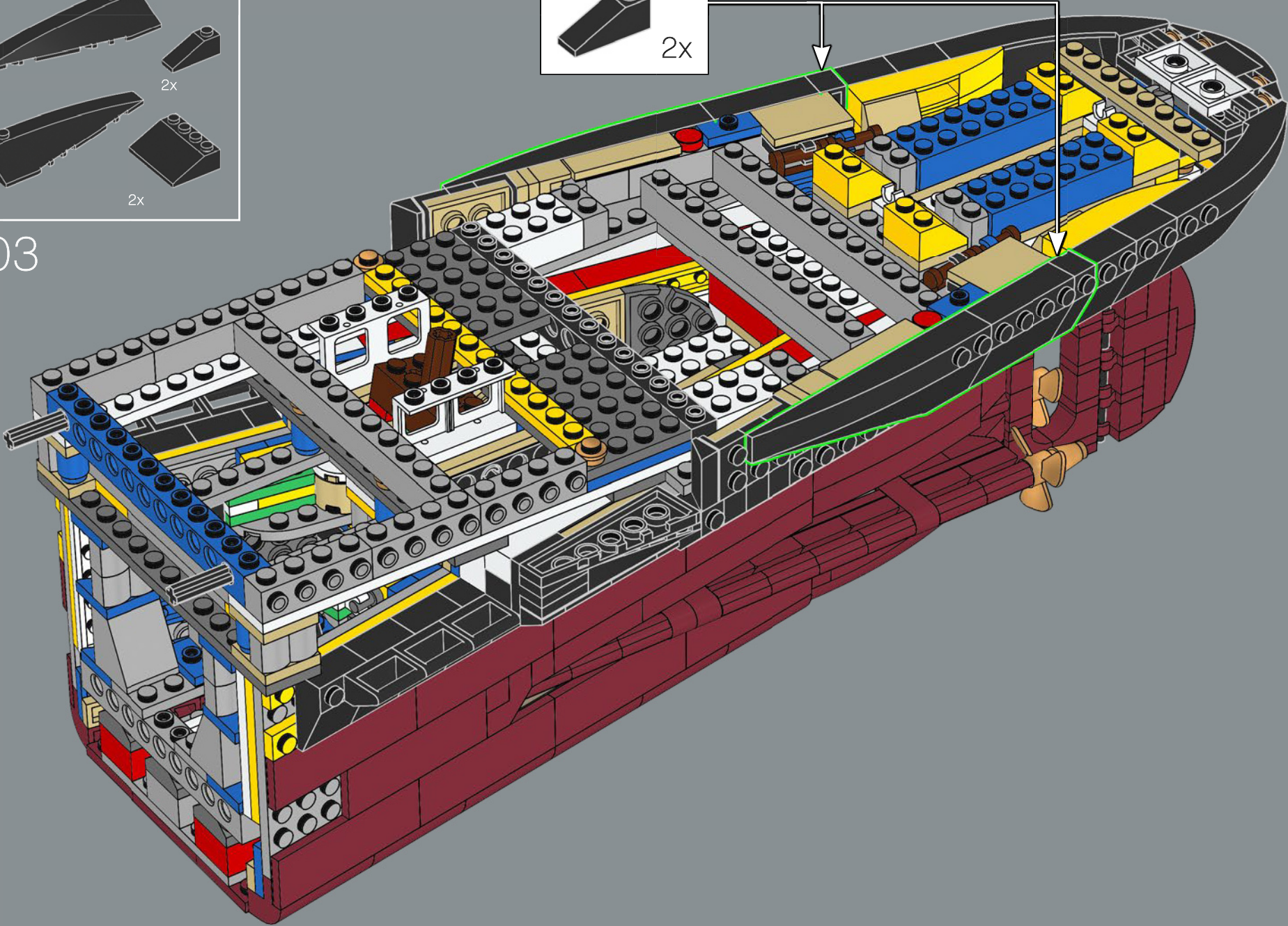

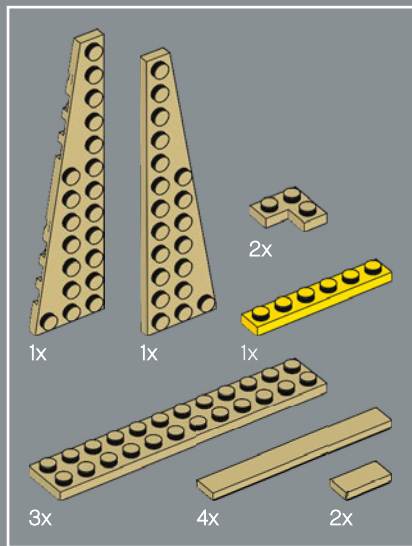

304

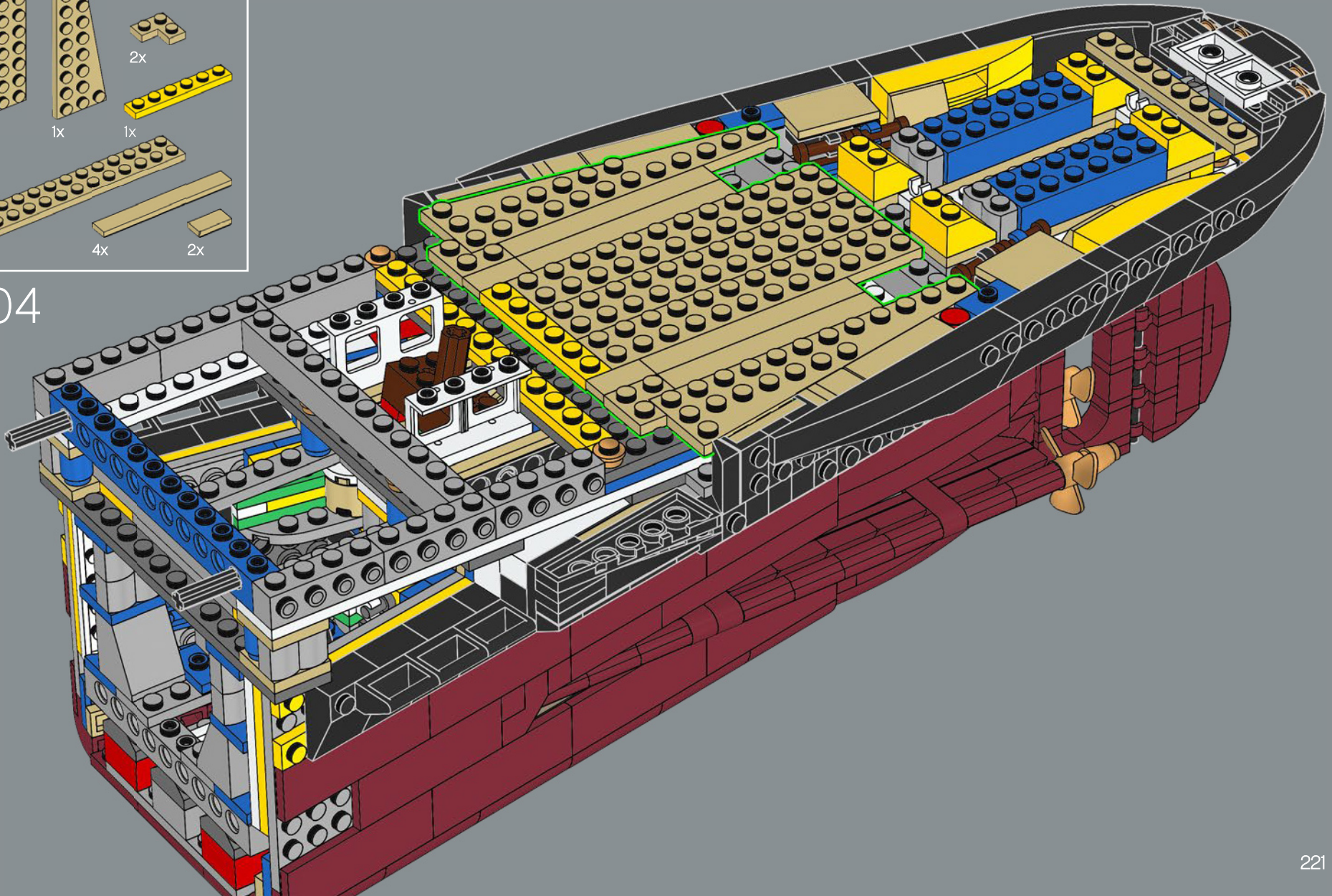

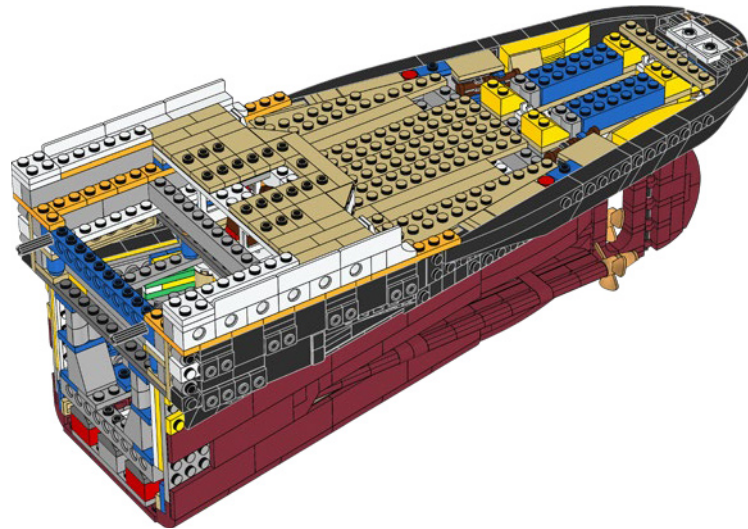
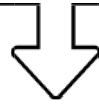

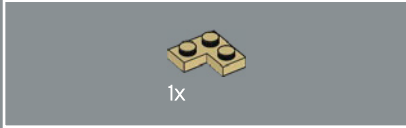
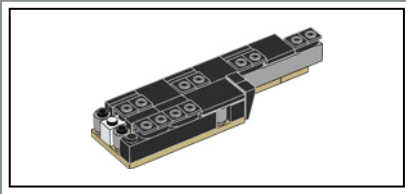

305

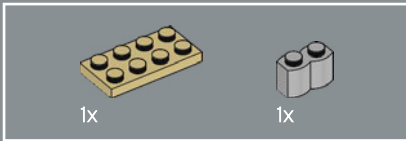
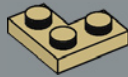

306

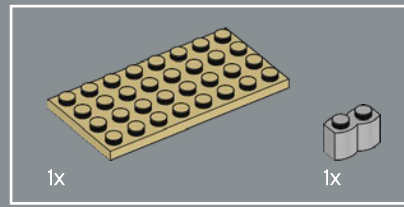
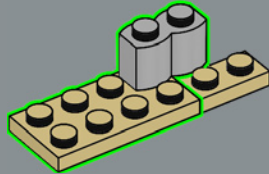

307

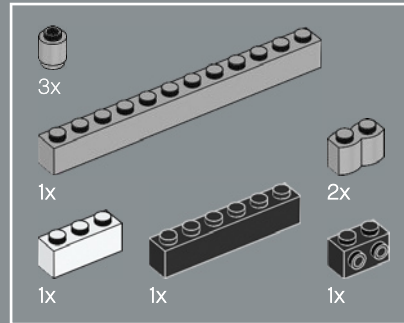
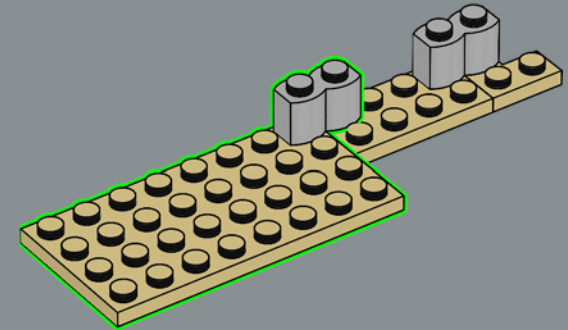

308

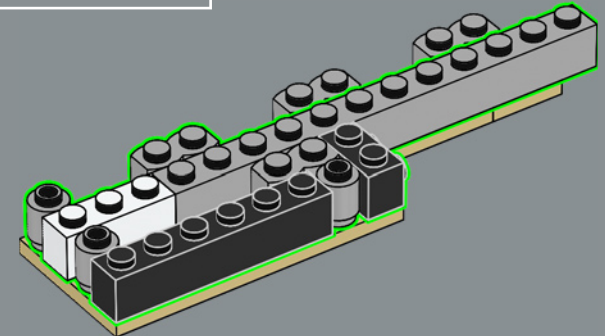

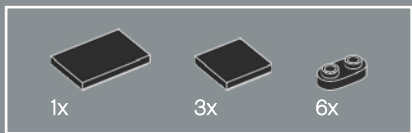

309

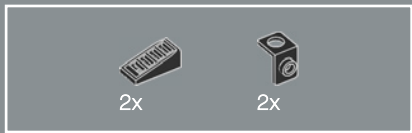
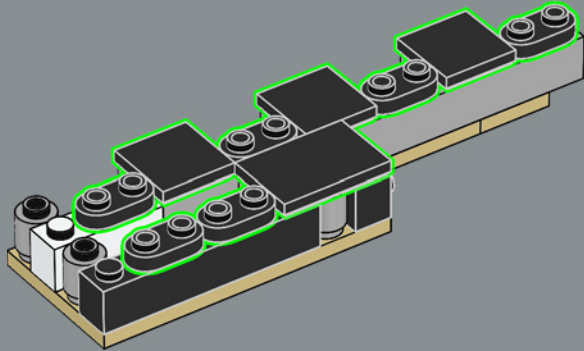

310

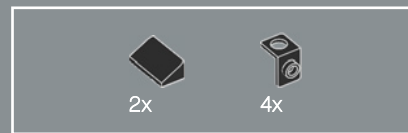
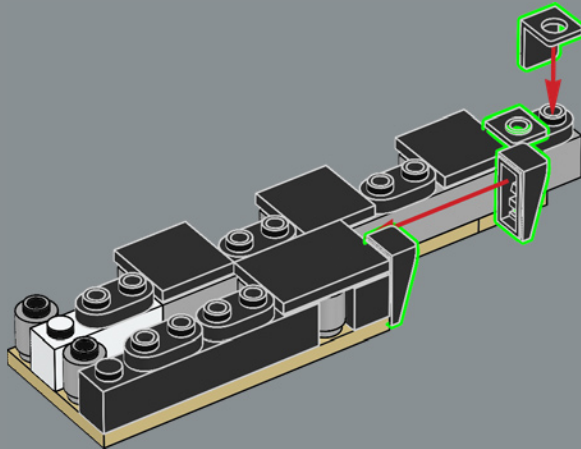

311

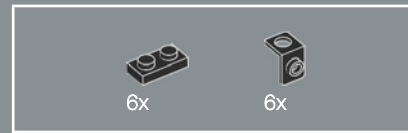
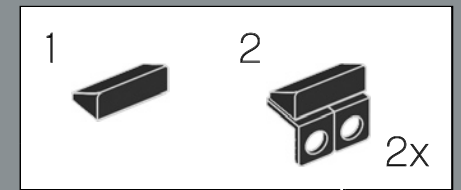
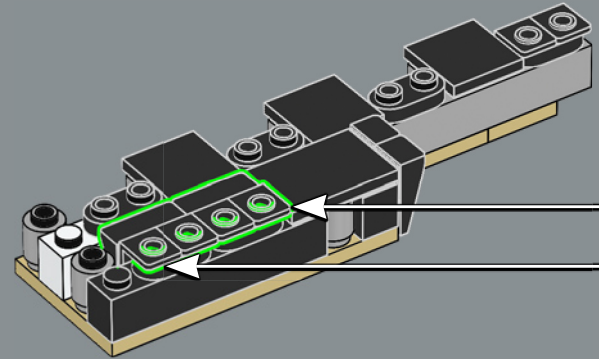

312

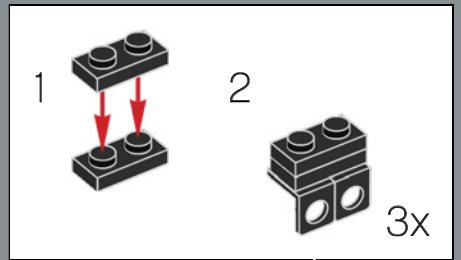
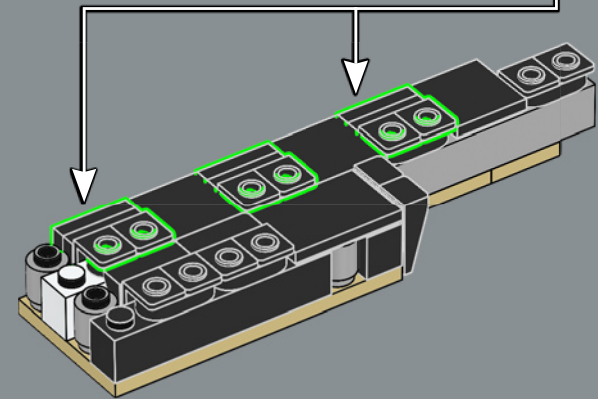



313

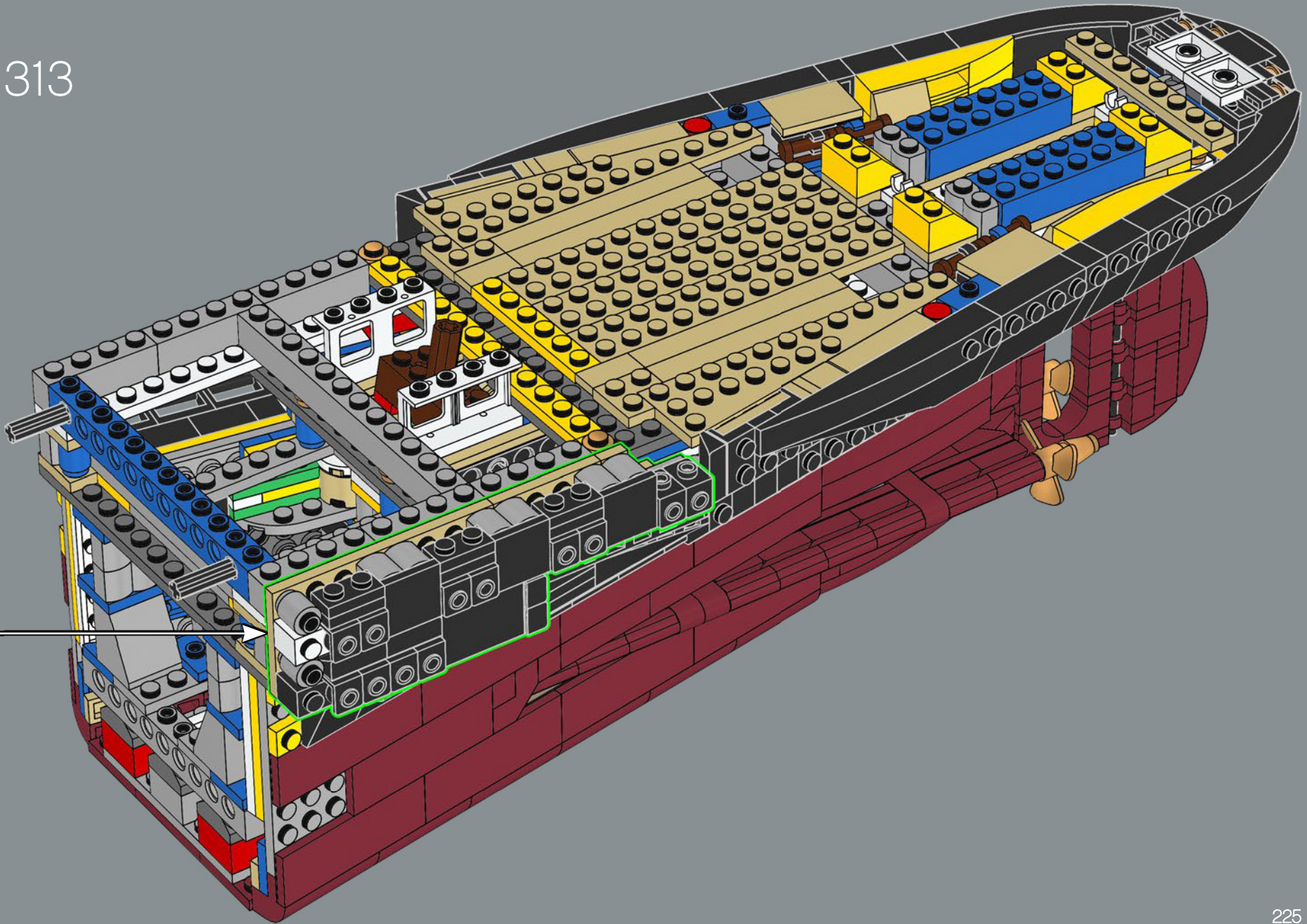

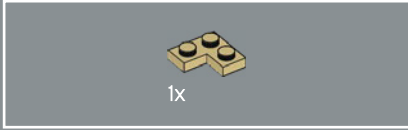
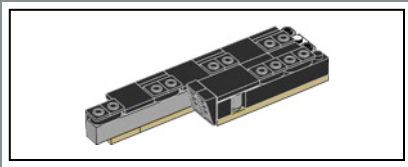

314

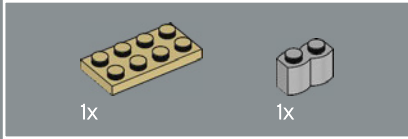

315

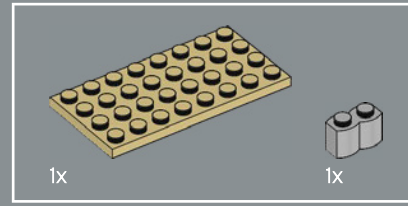
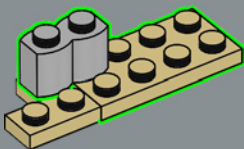

316

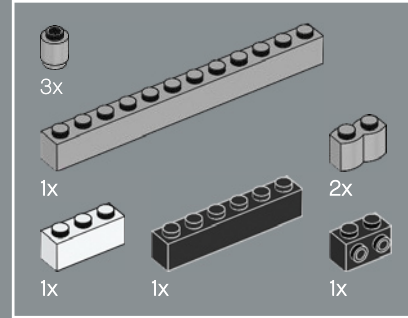
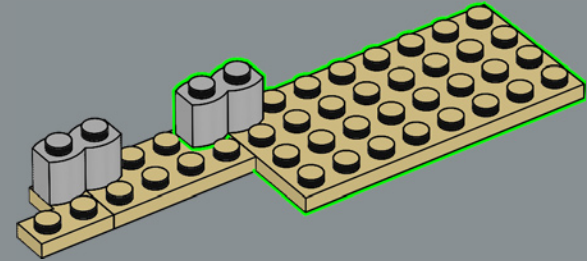

317

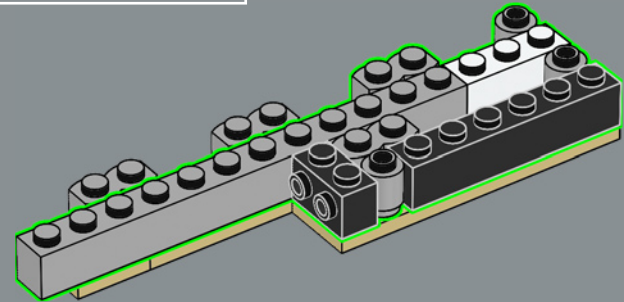

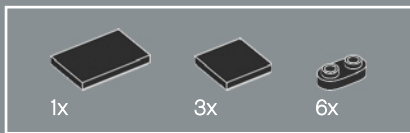

318

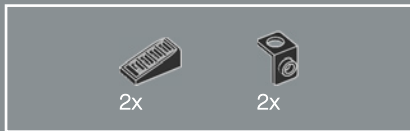
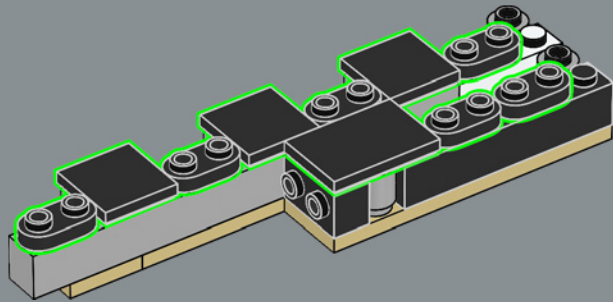

319

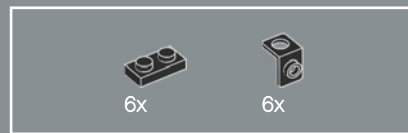
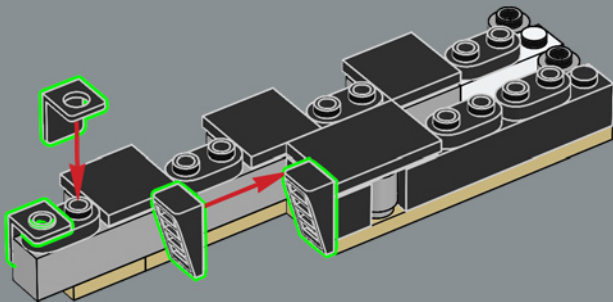

320

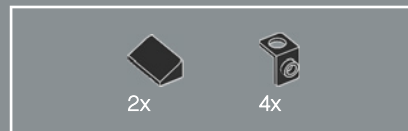
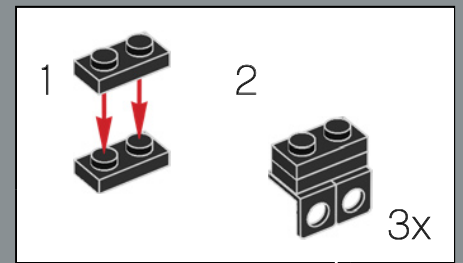
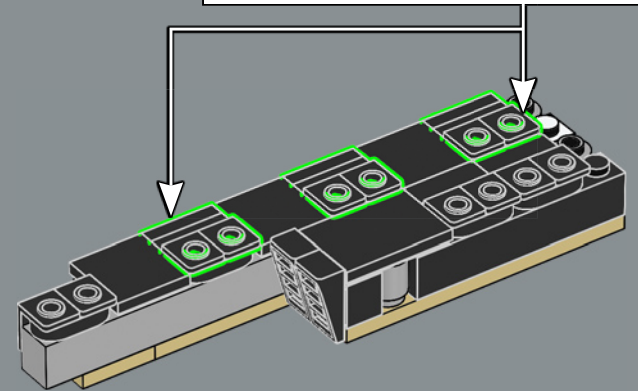

321

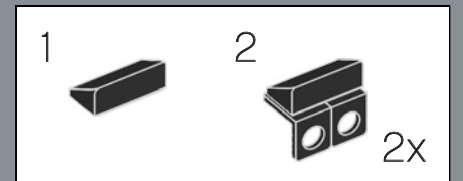
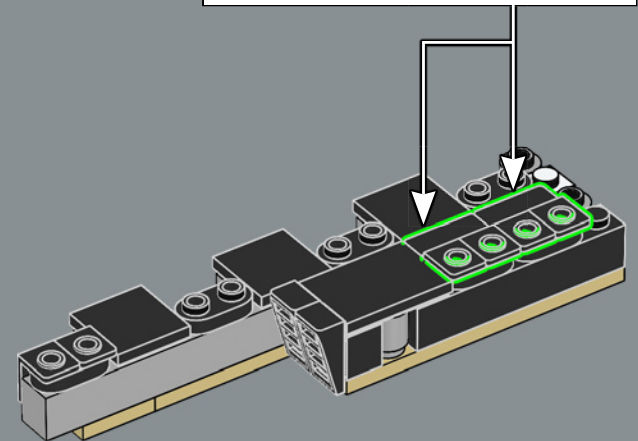

322

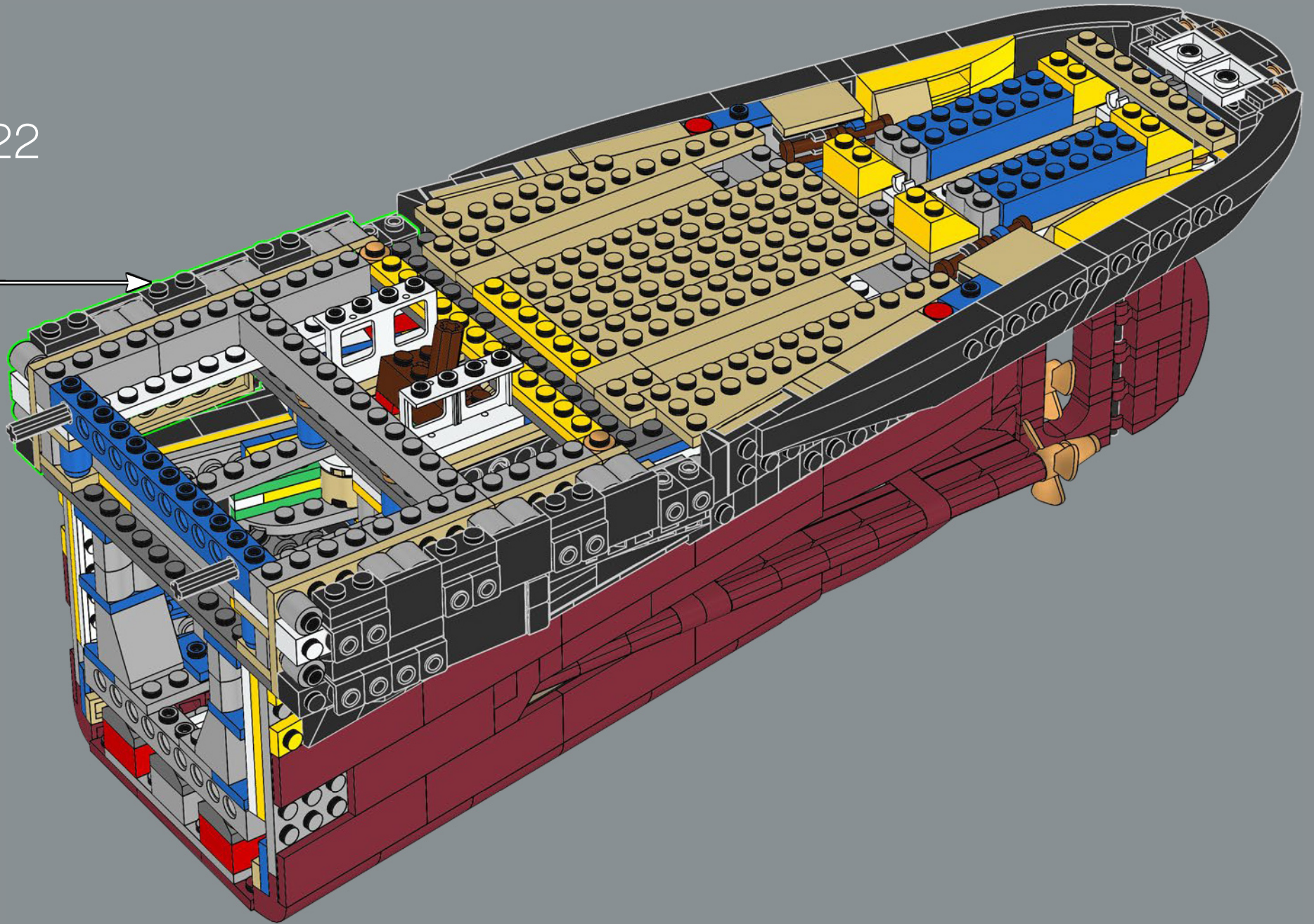

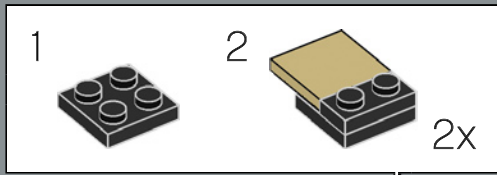
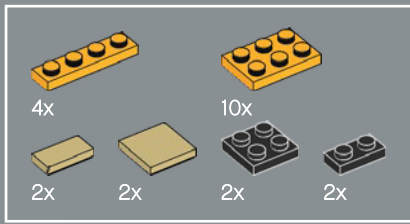

323

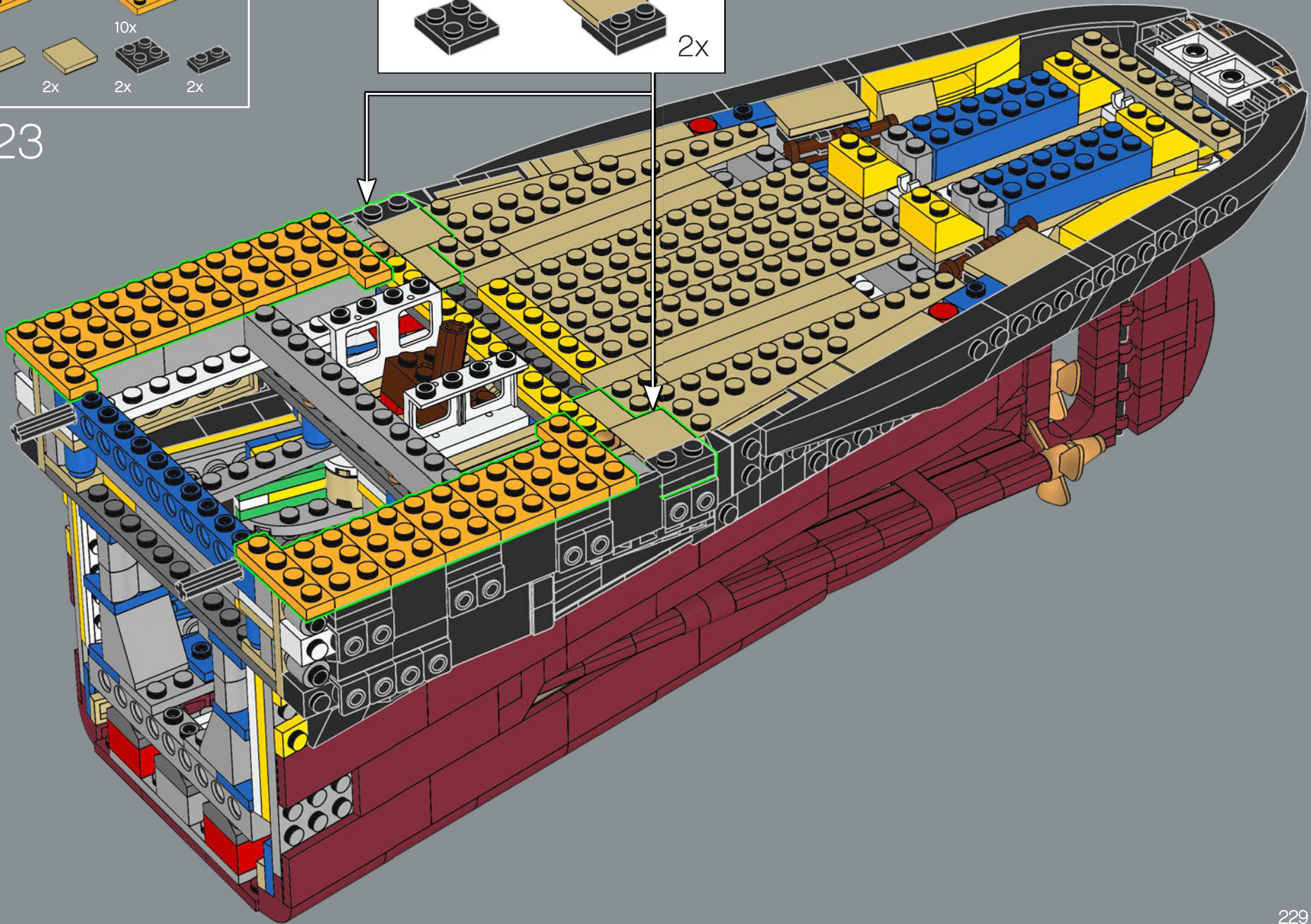

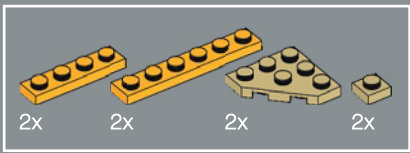

324

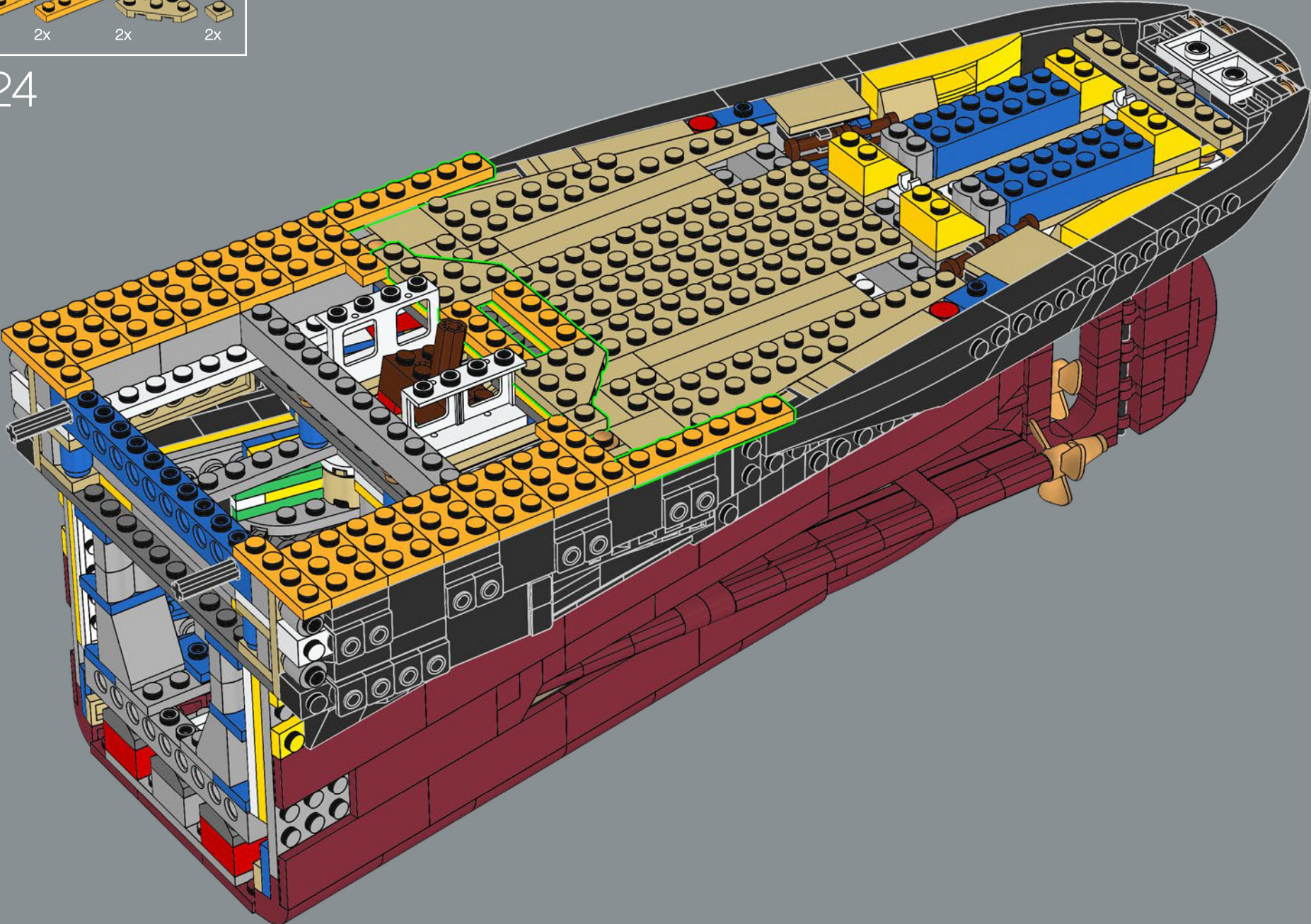

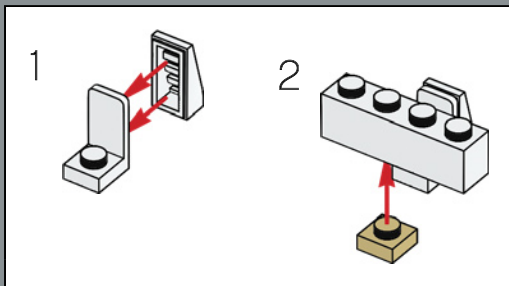
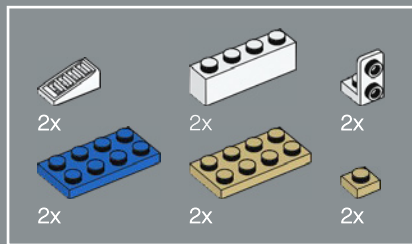

325

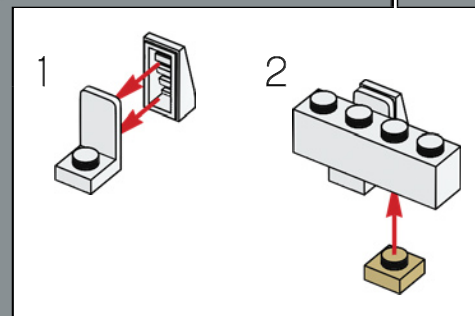
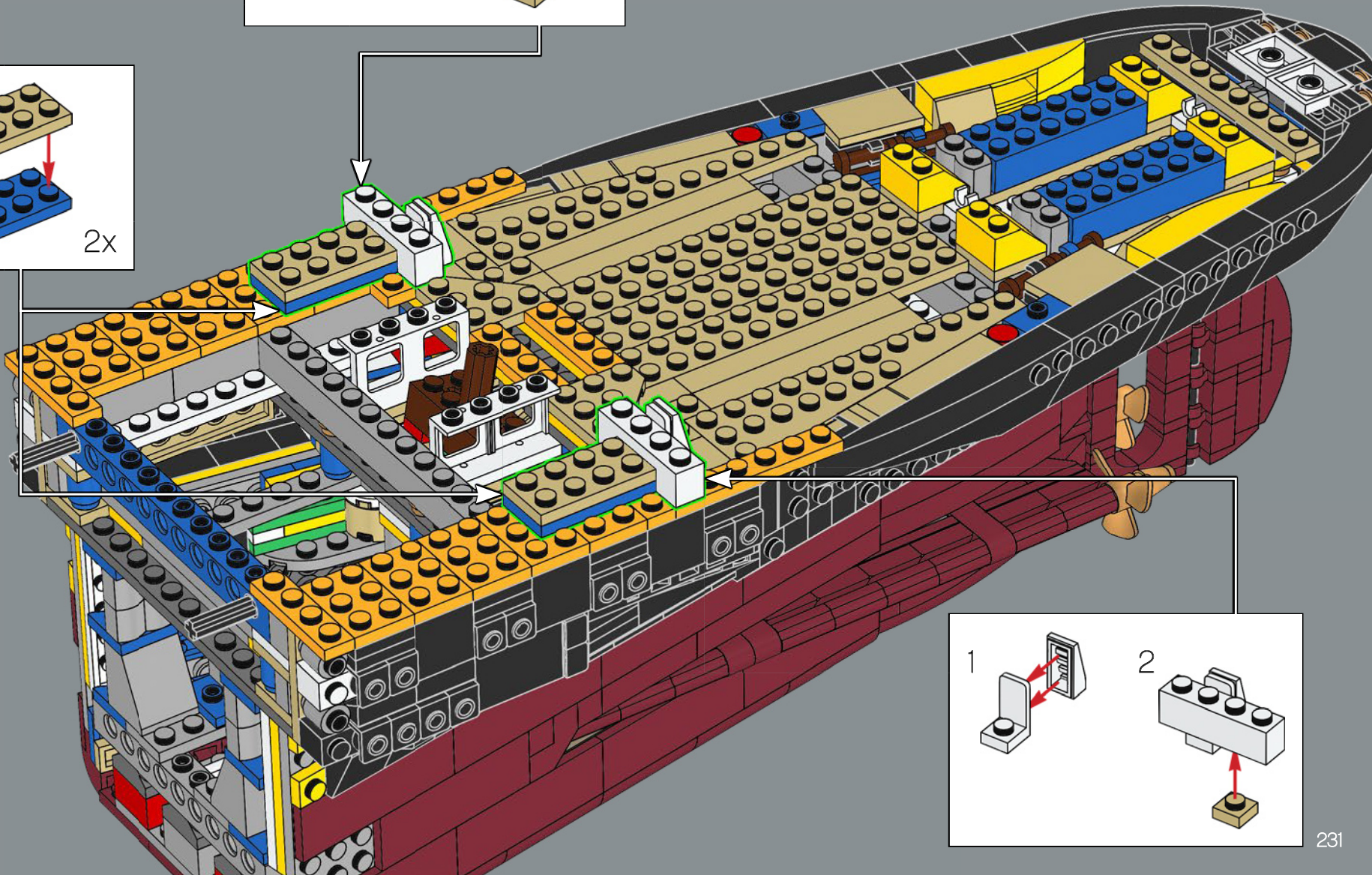
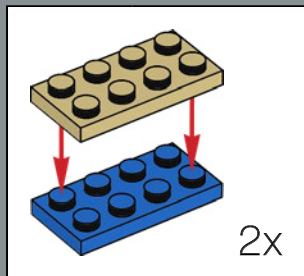

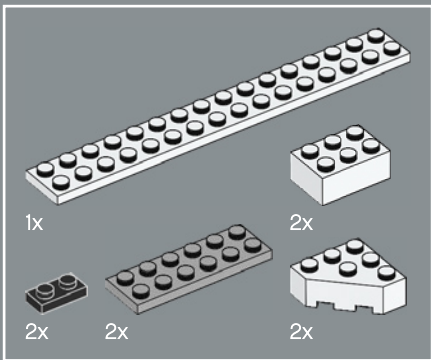

326

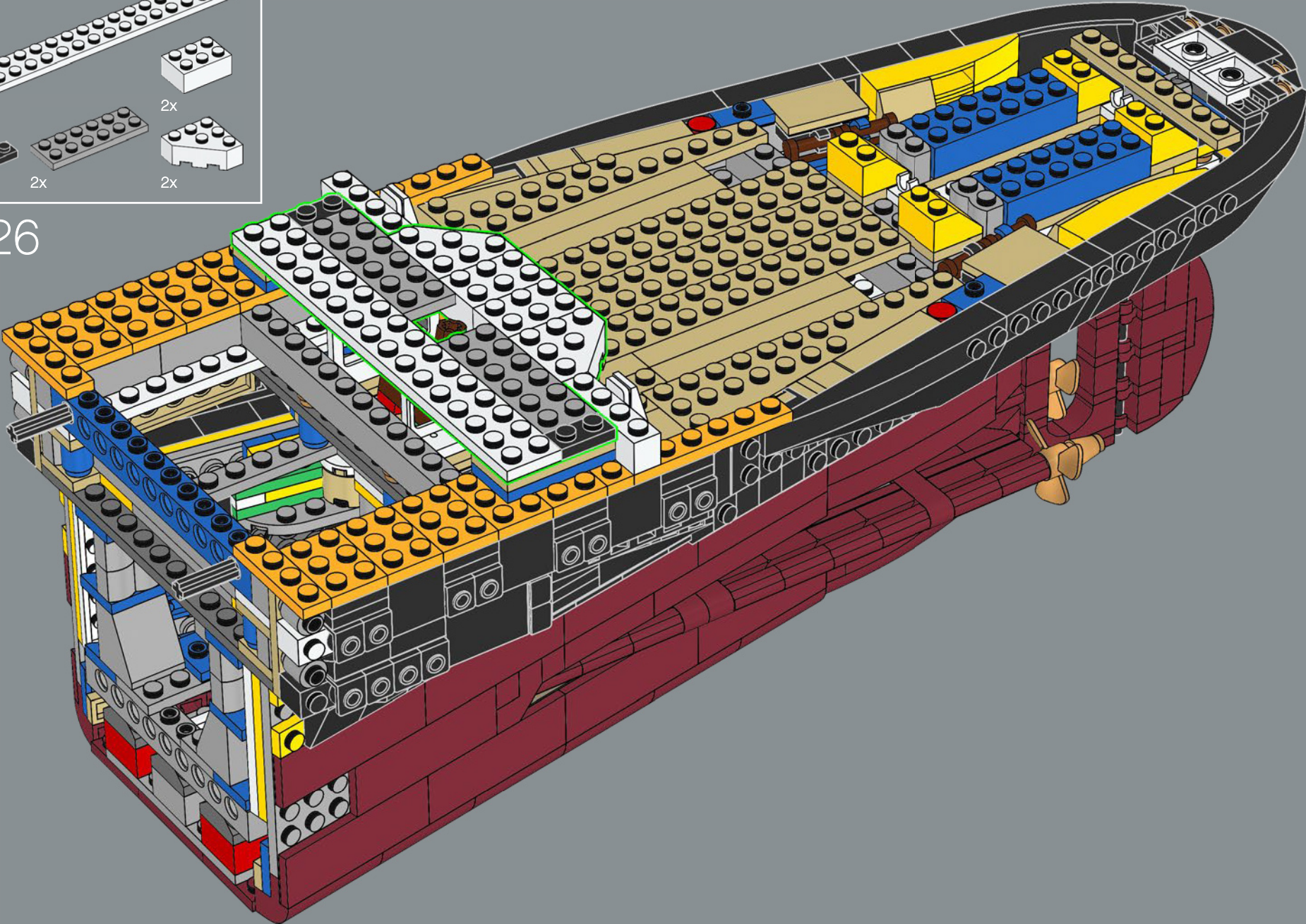



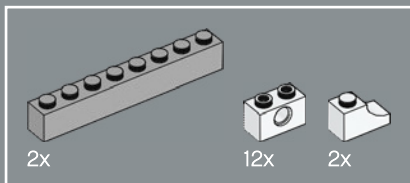

327

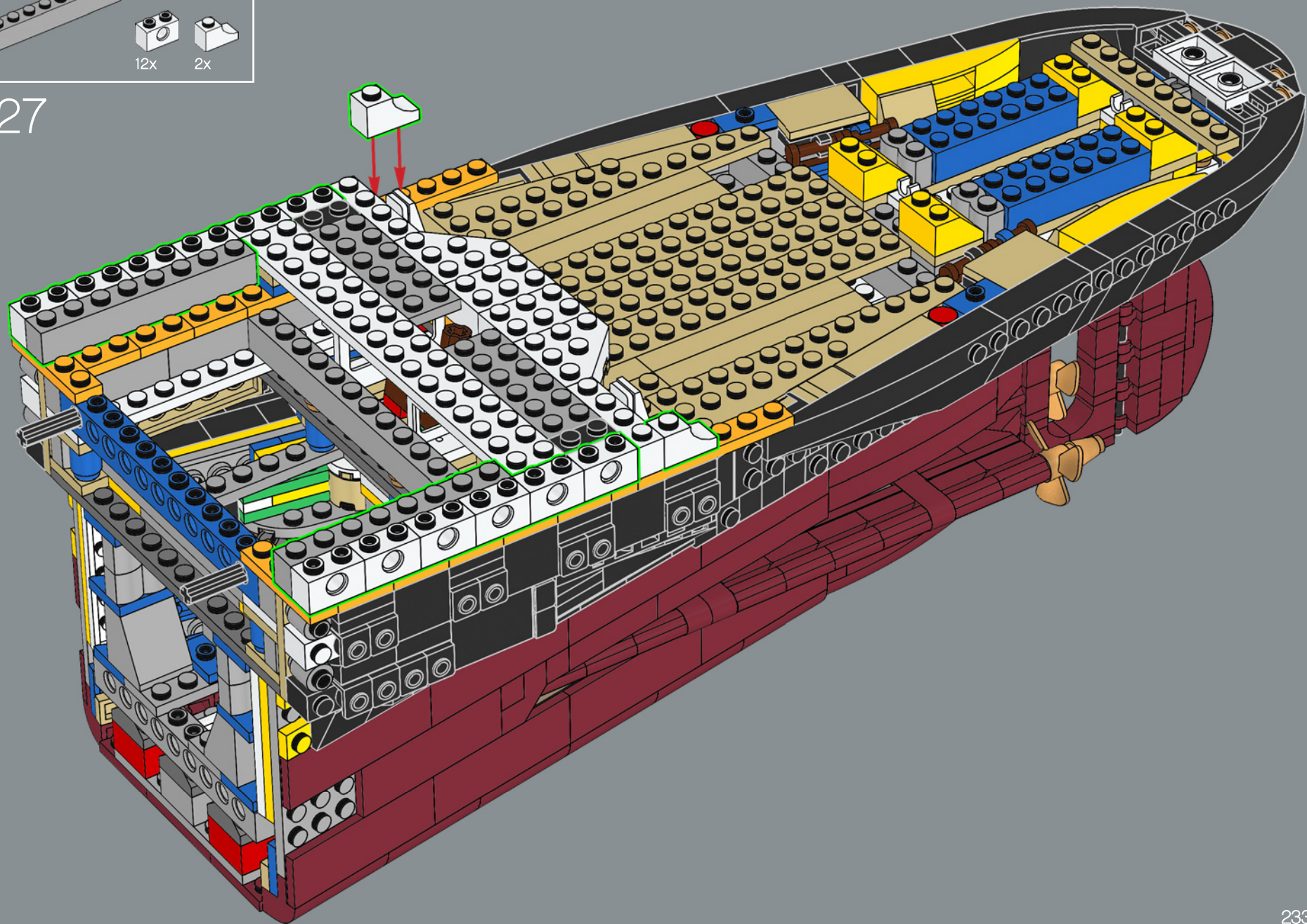

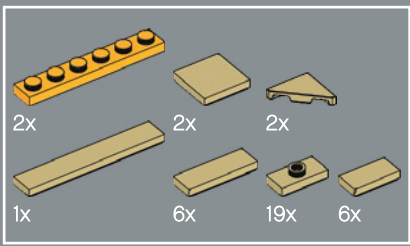

328

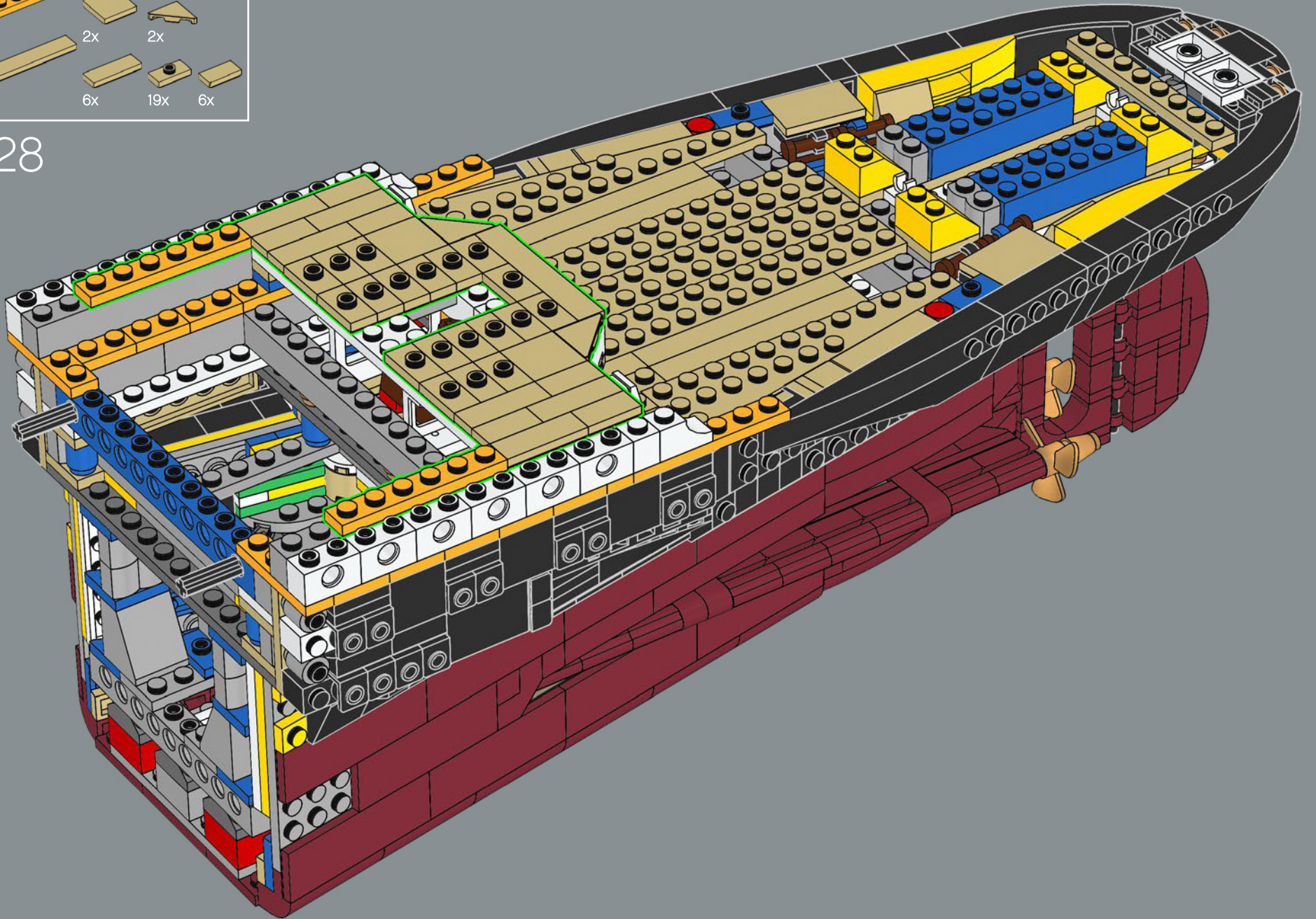

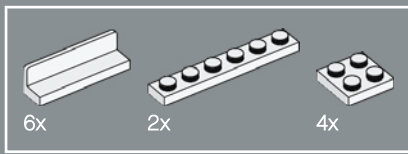

329

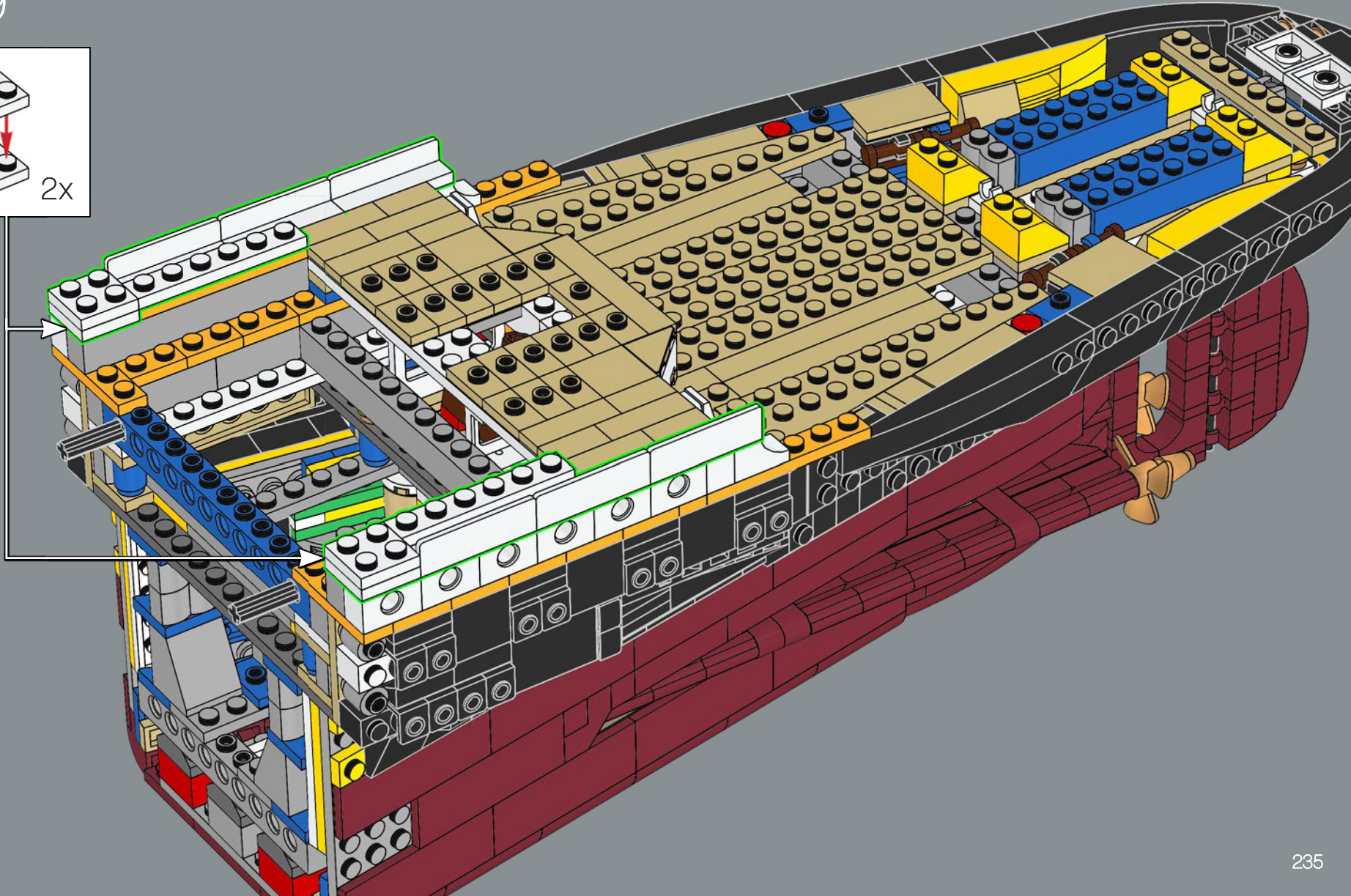
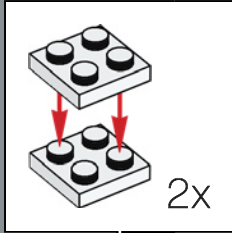

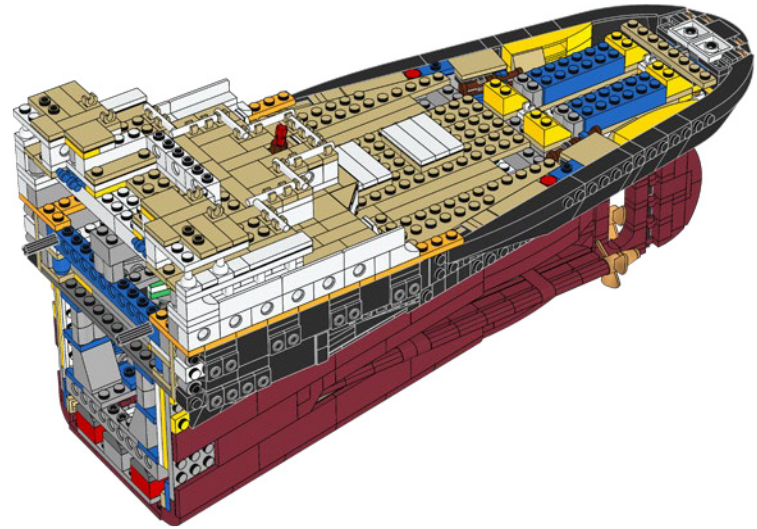
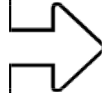

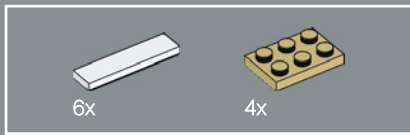

330

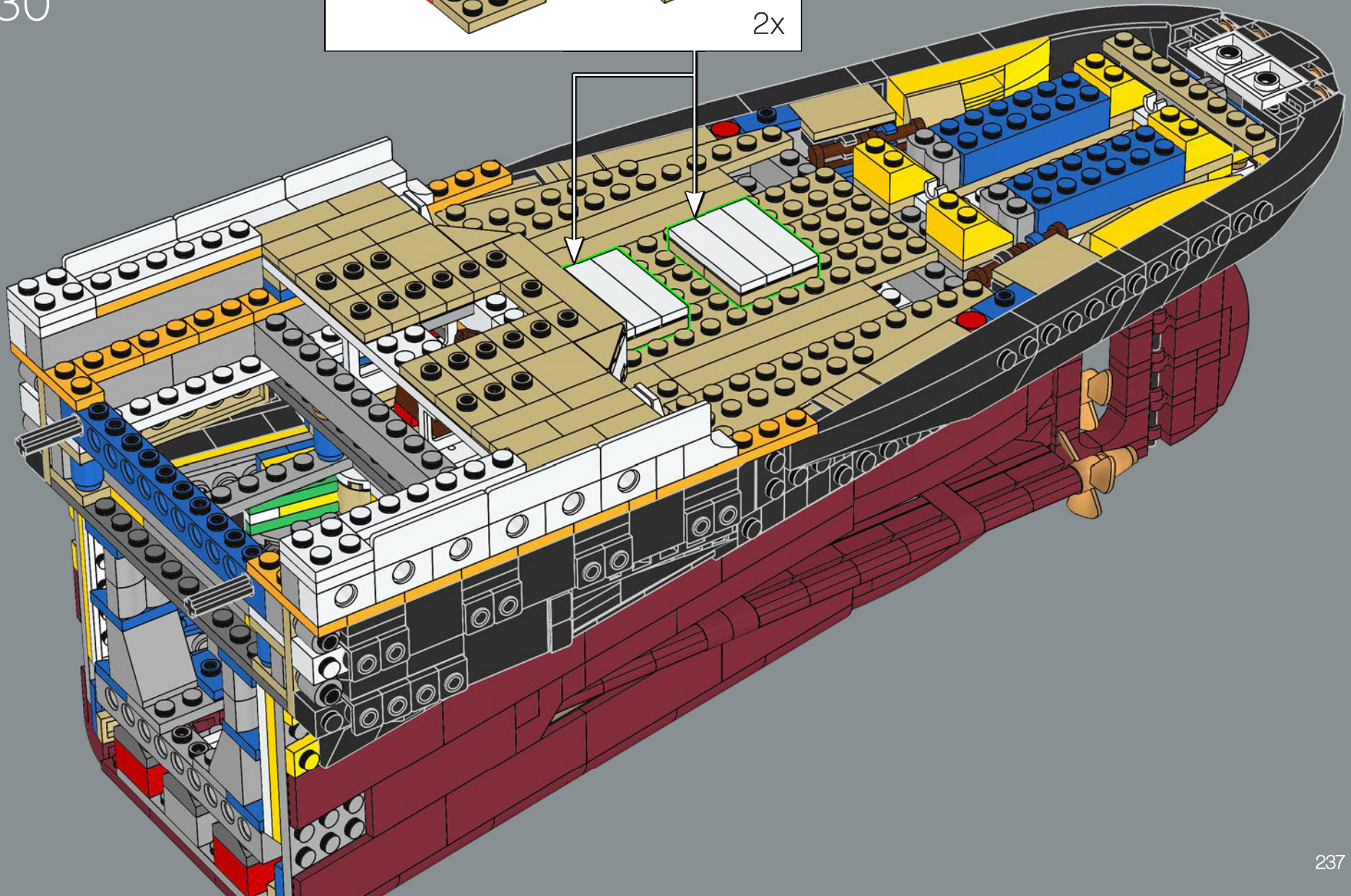
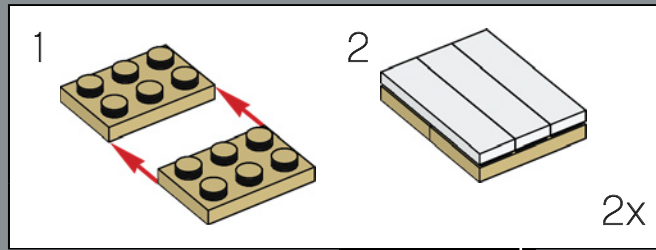

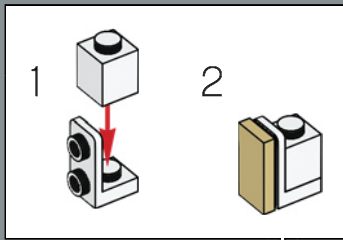
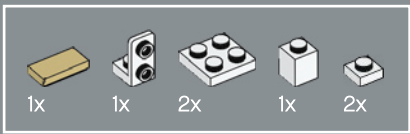

331

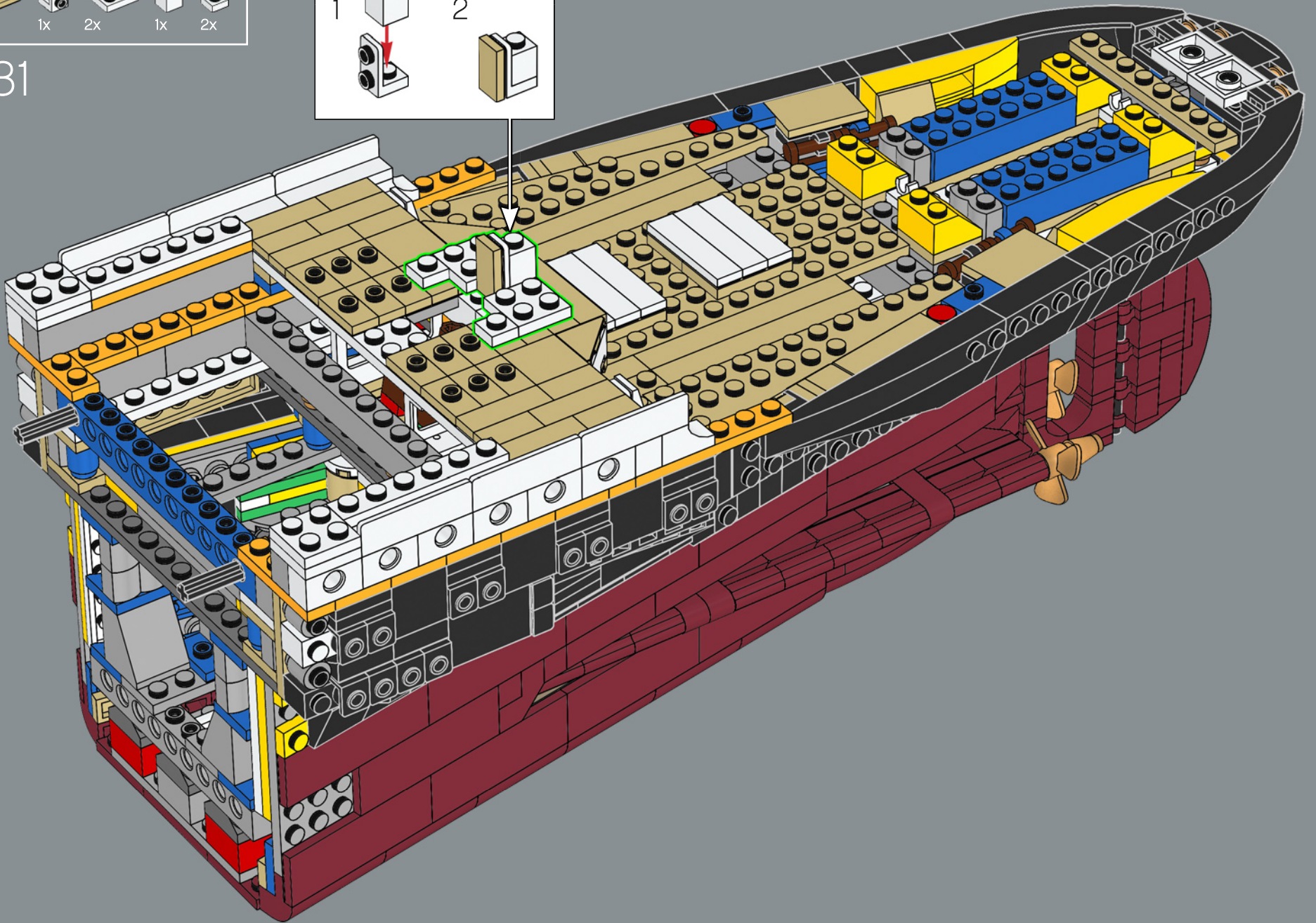

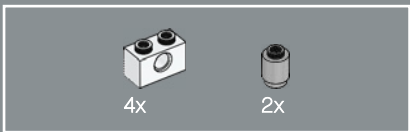

332

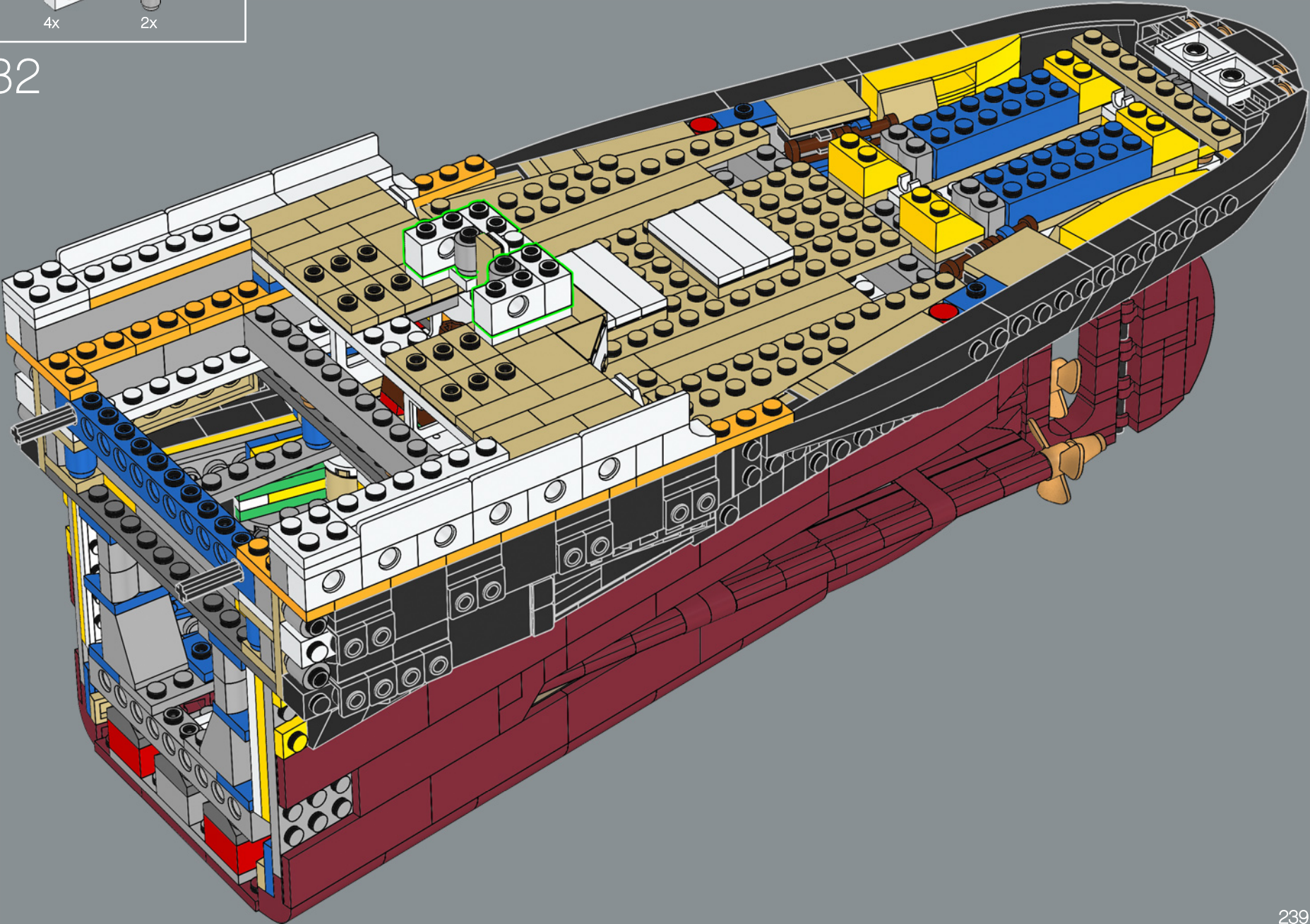

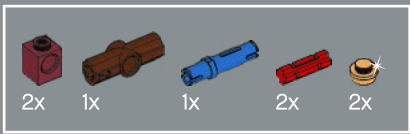

333

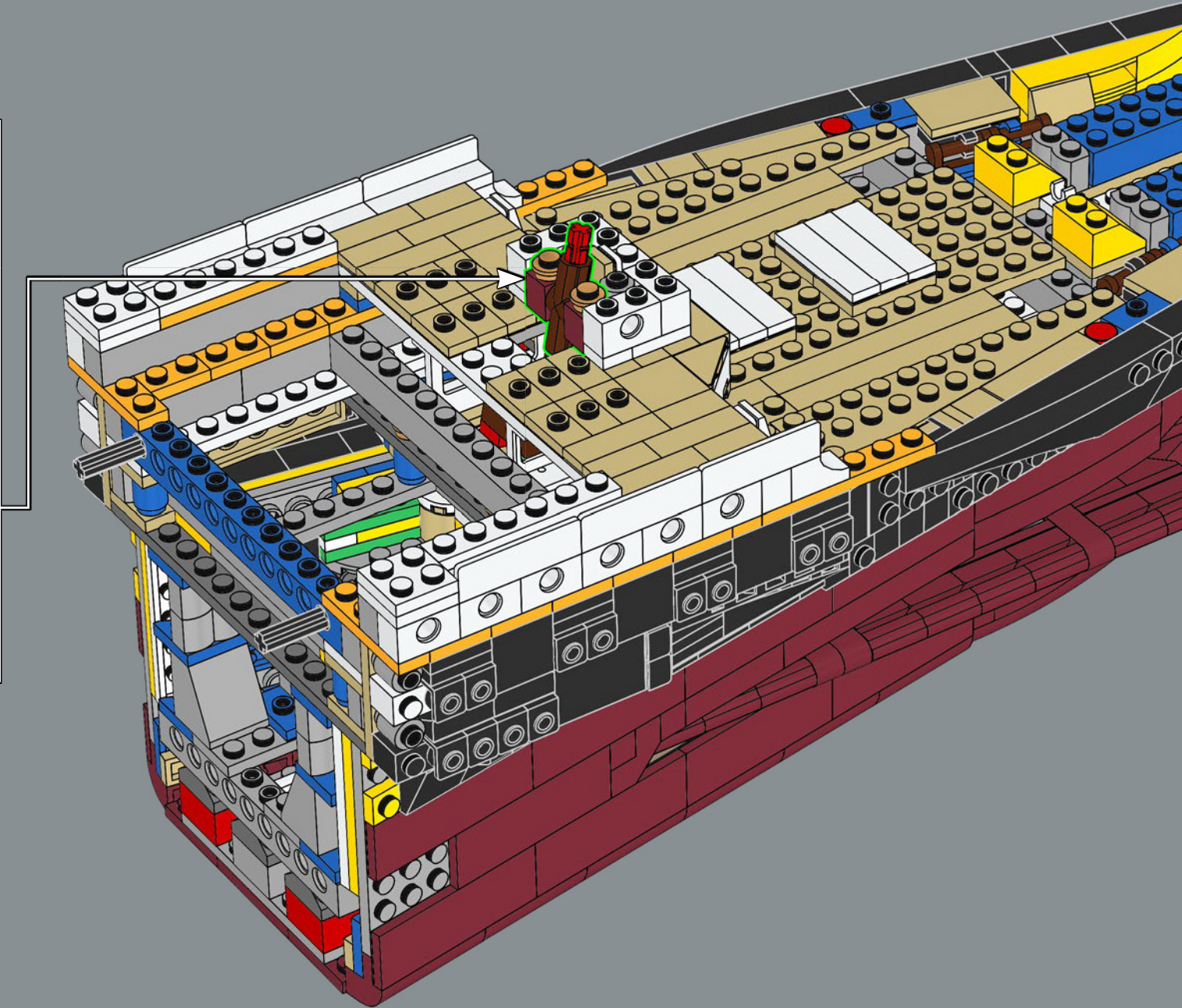
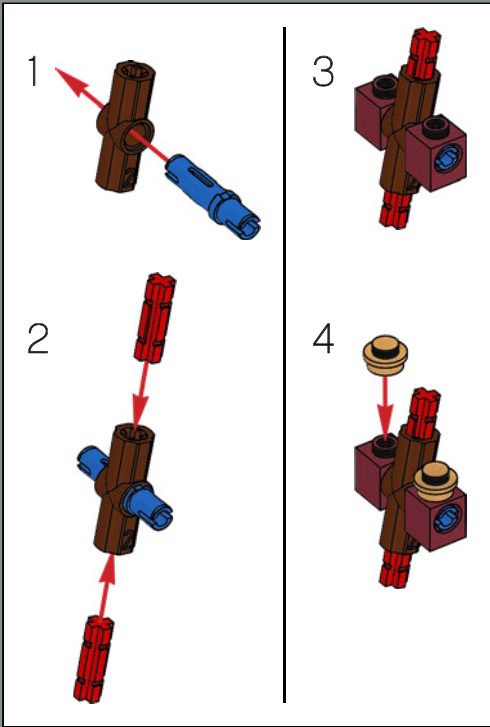



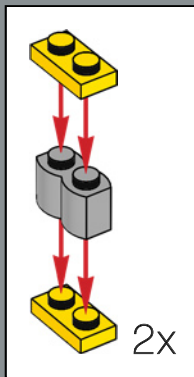
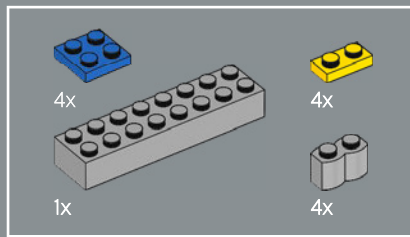

334

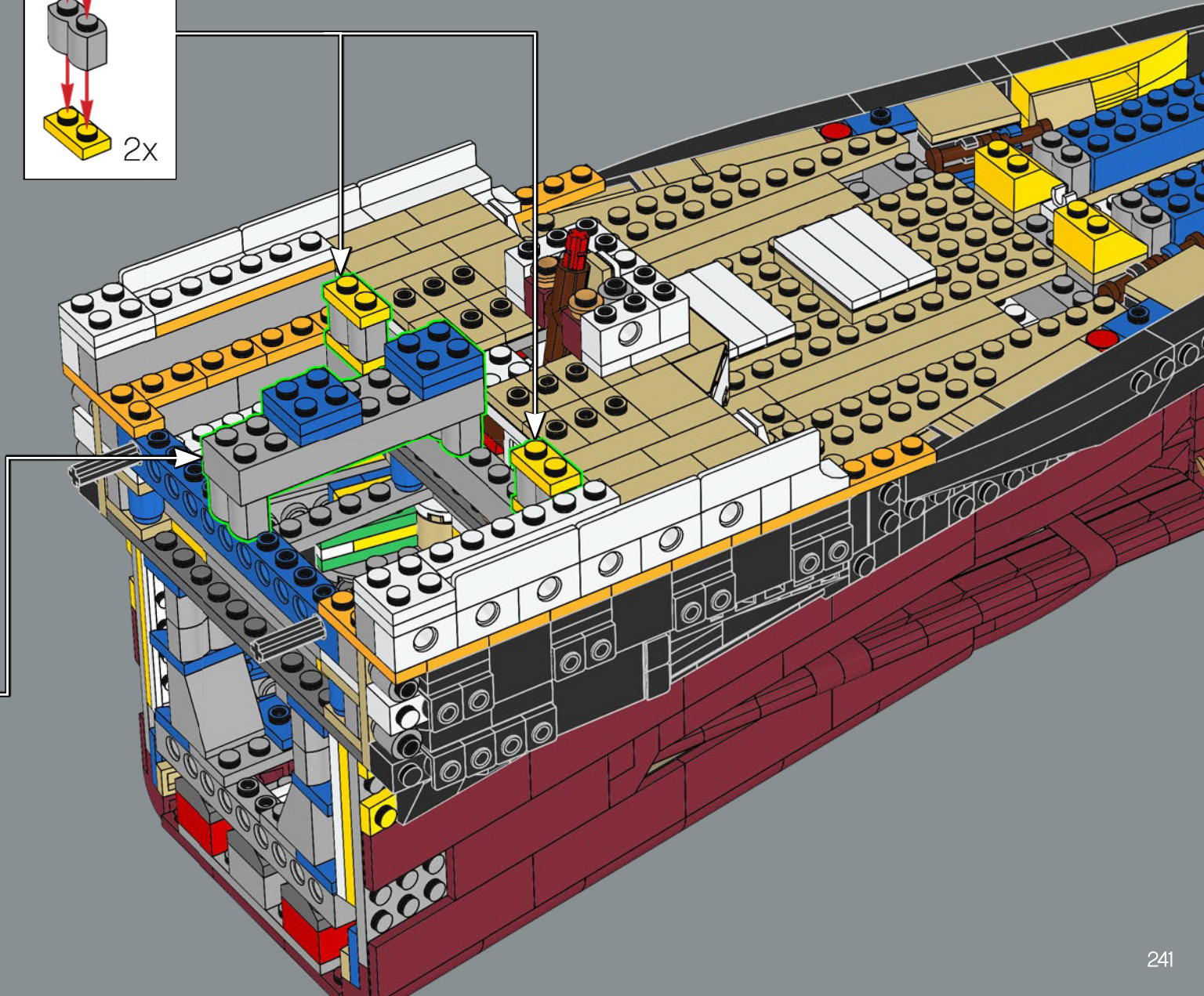
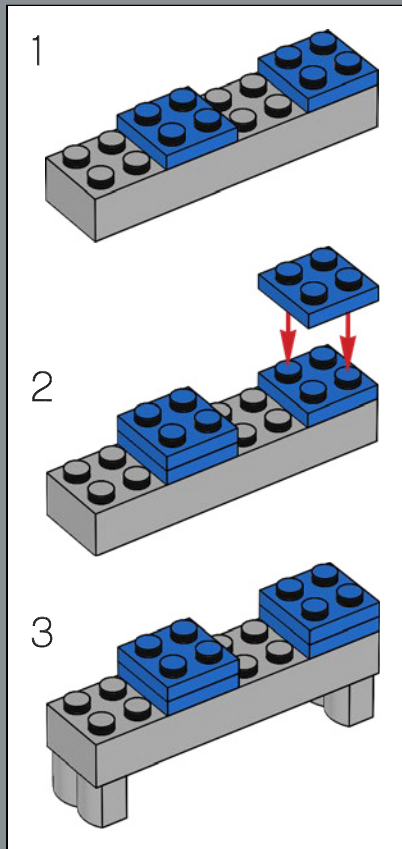

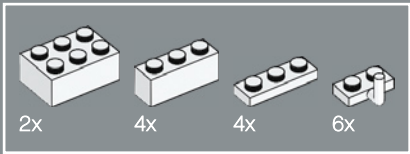

335

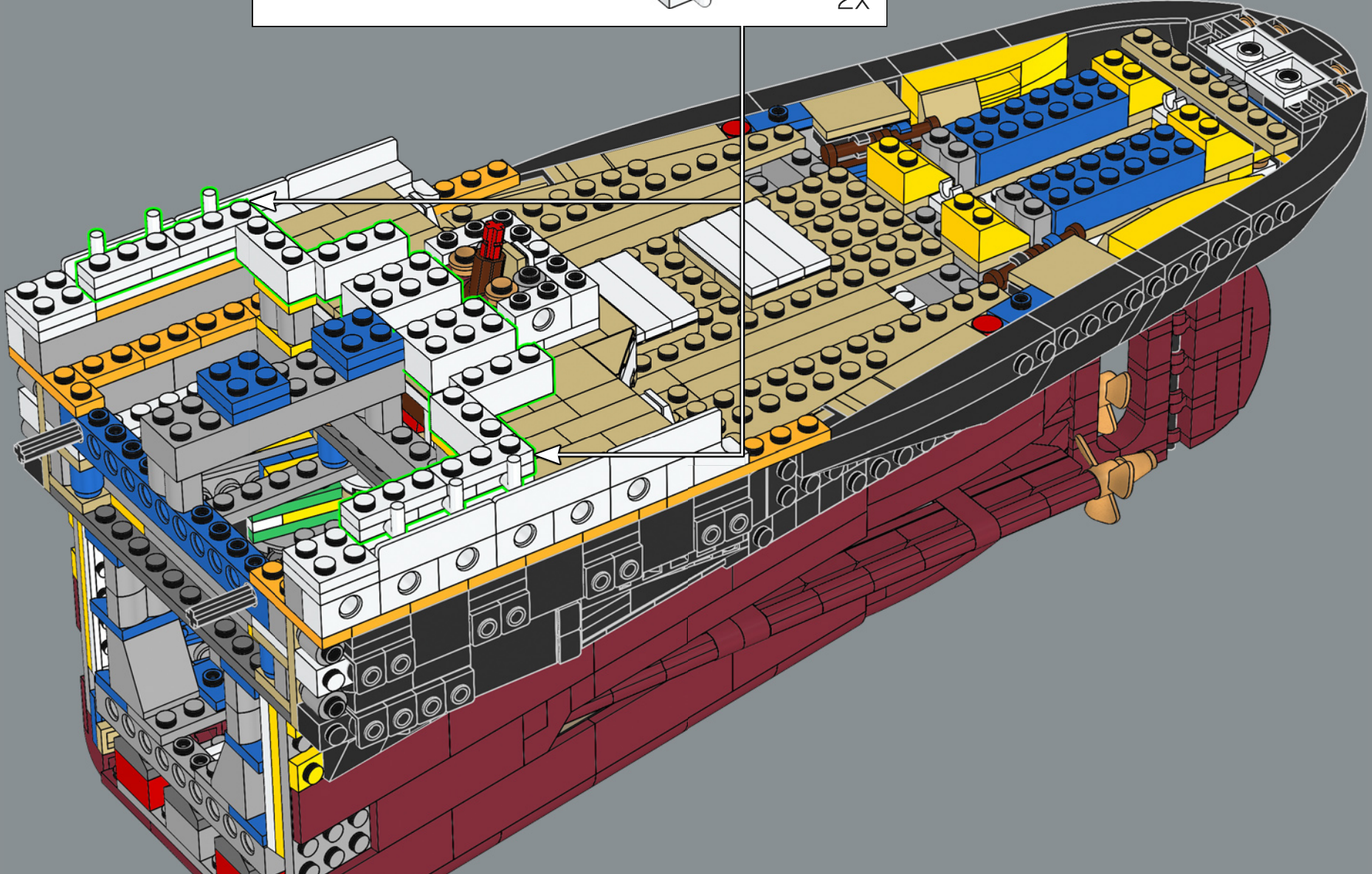
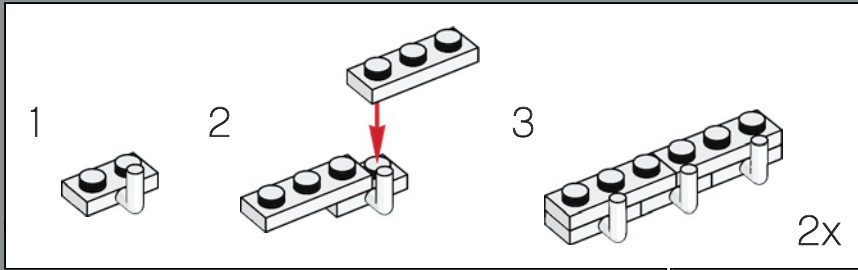

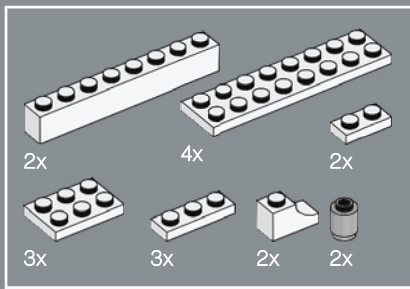

336

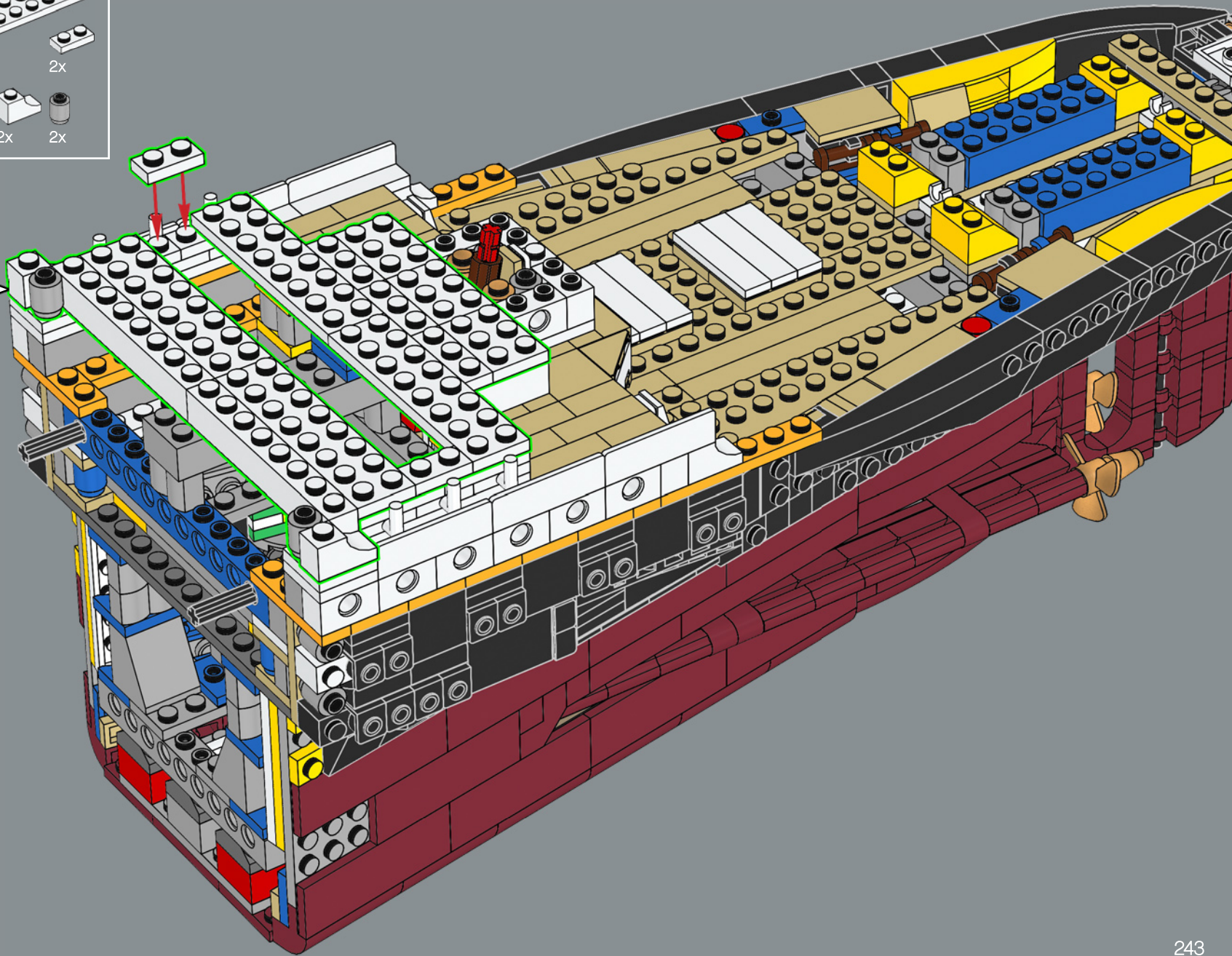
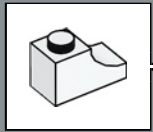

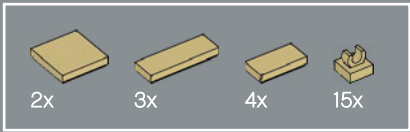

337

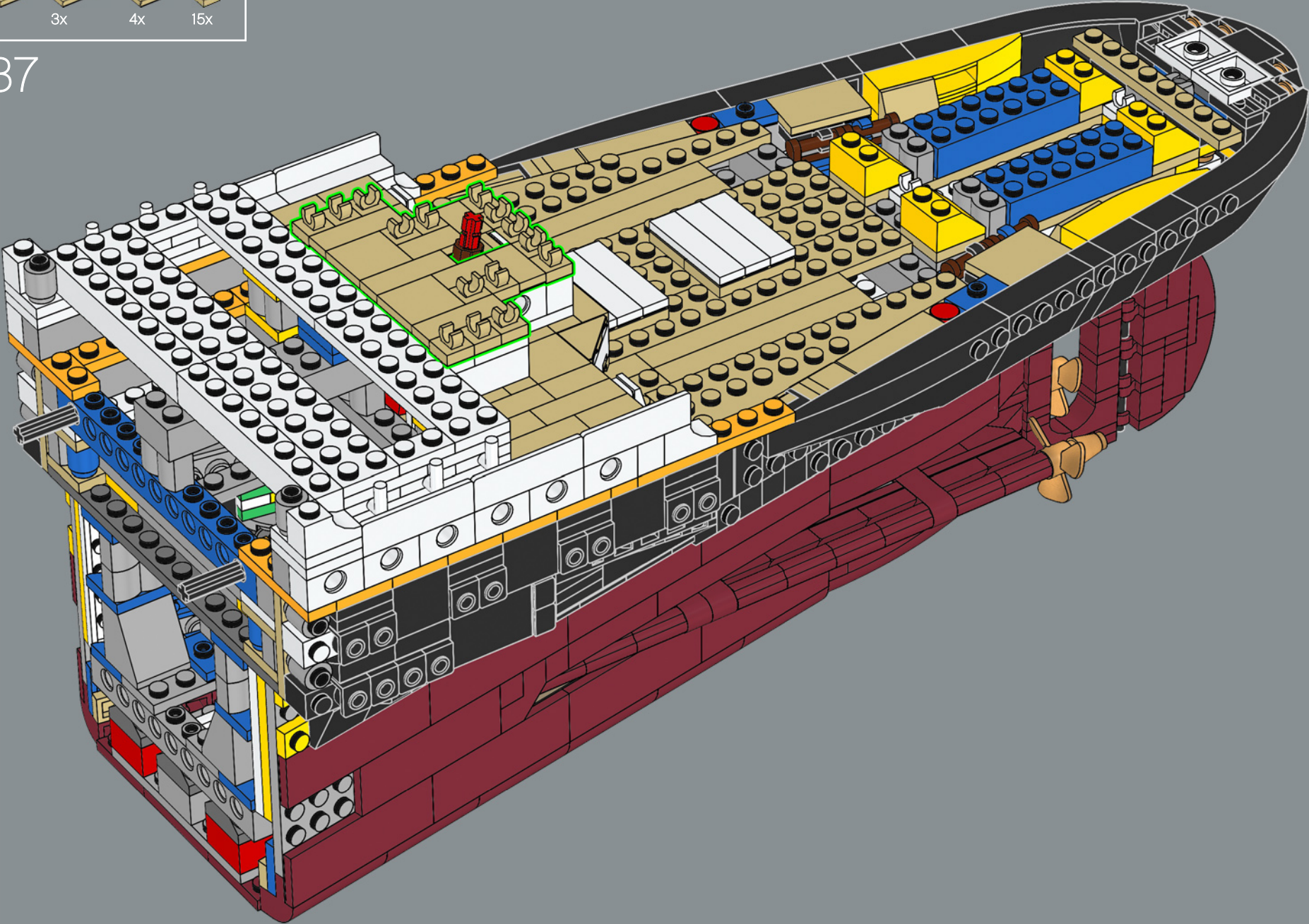



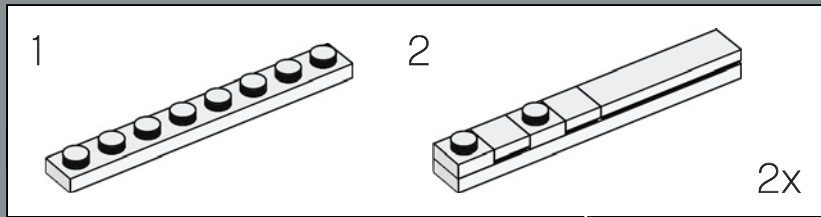
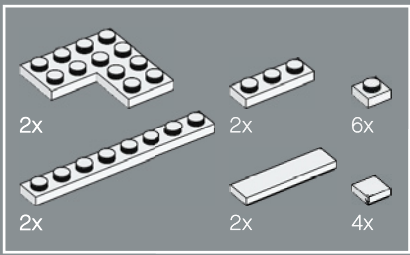

339

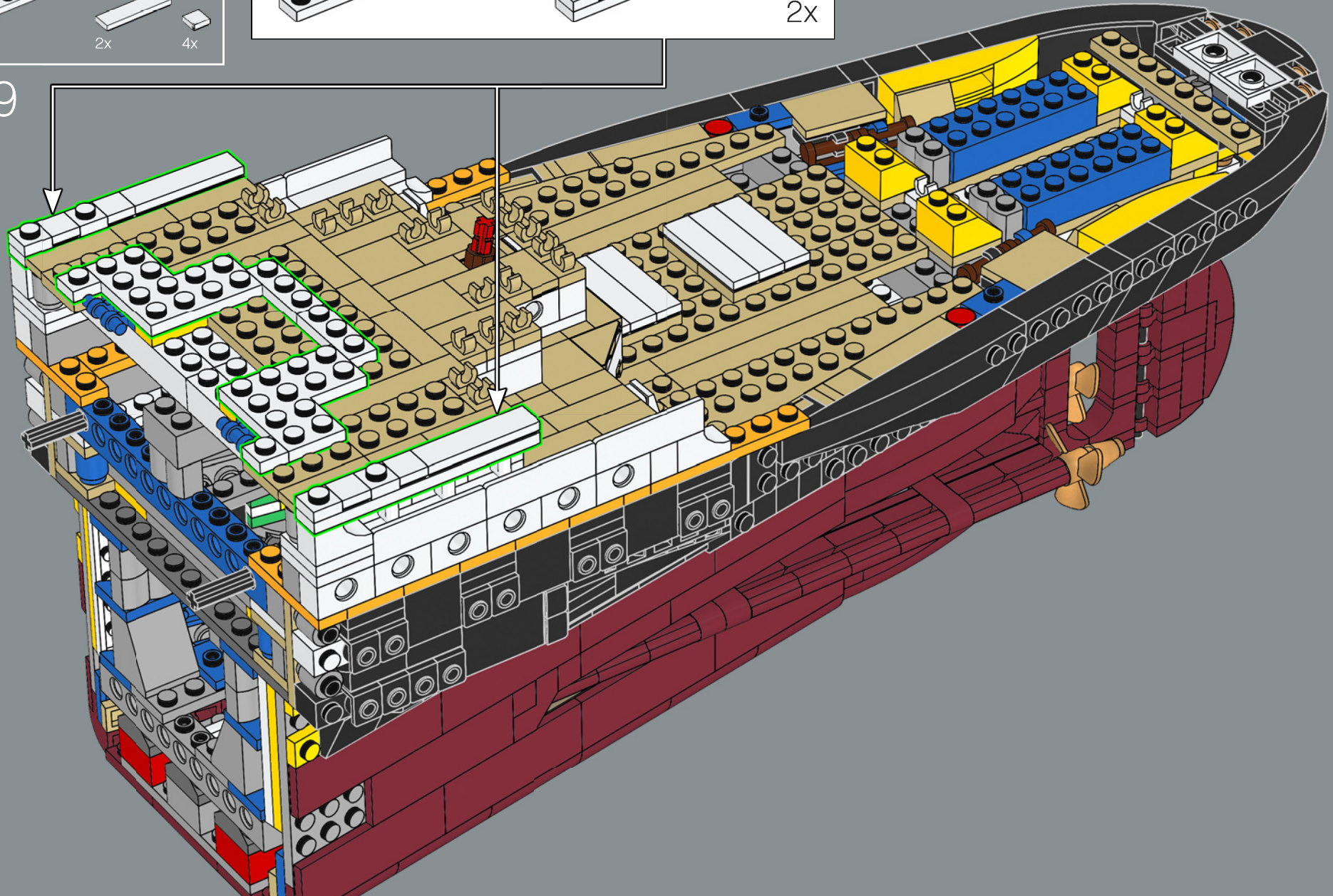

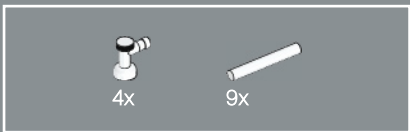

340

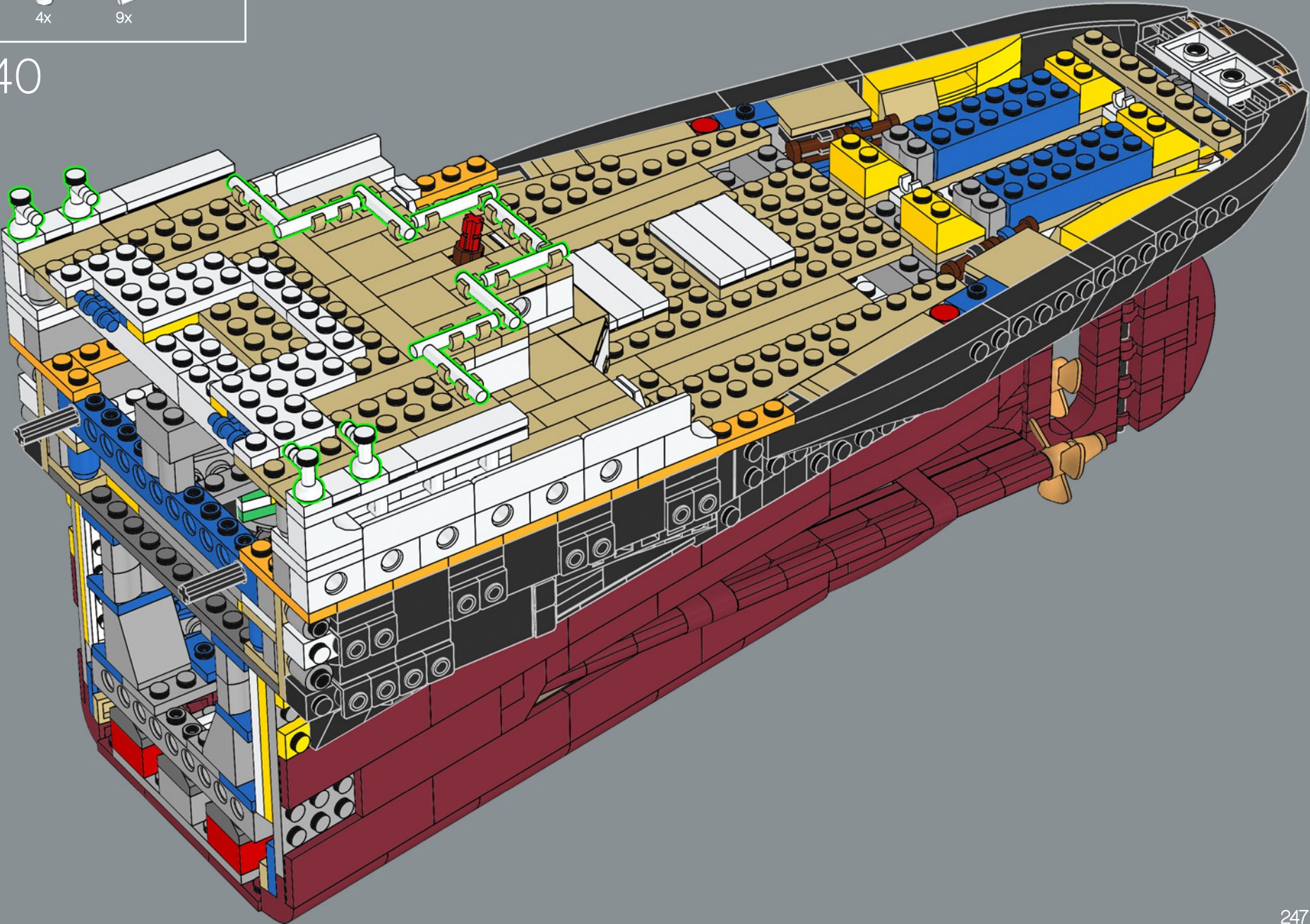

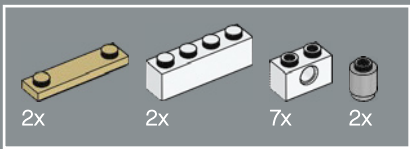

341

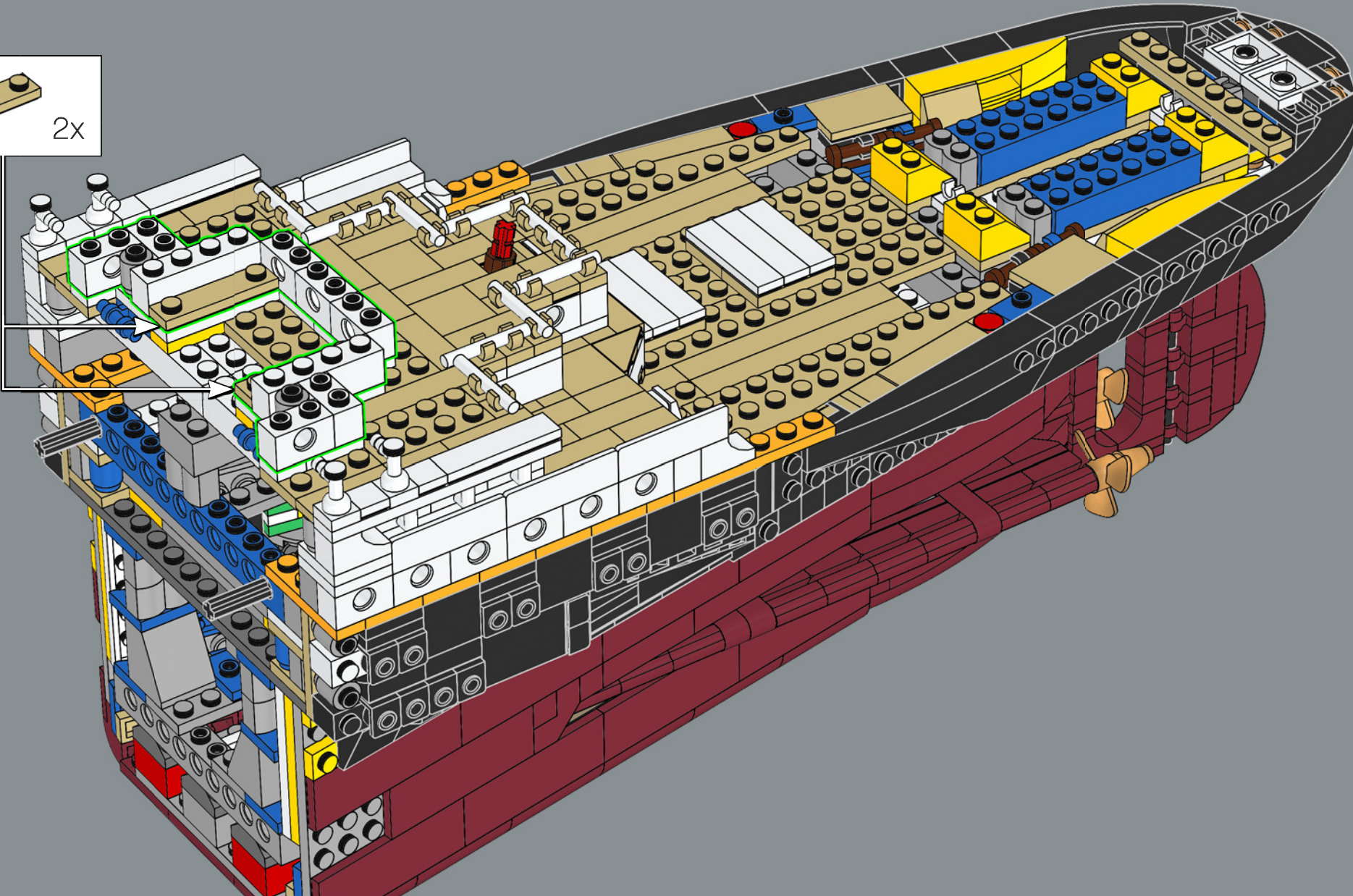
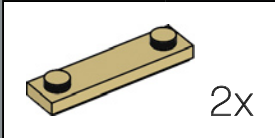



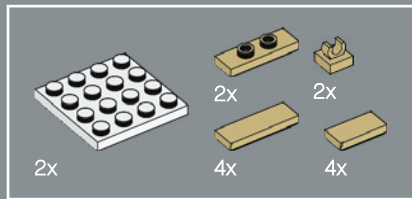

342

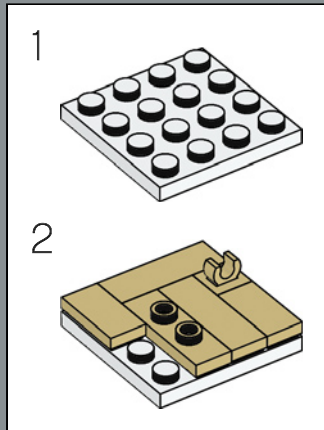
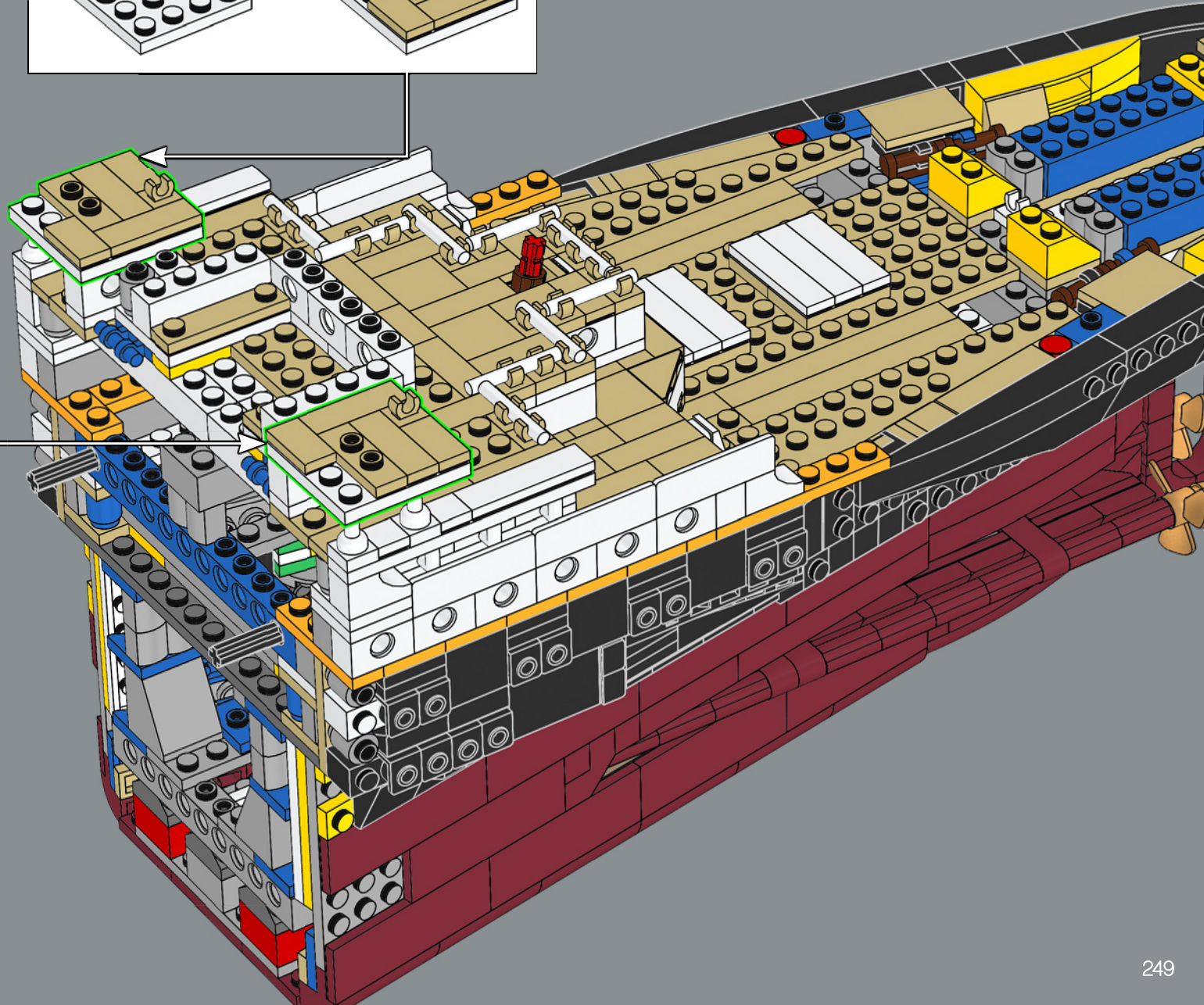
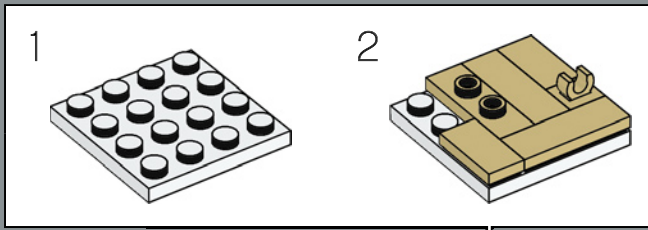

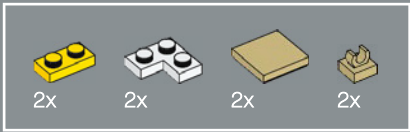

343

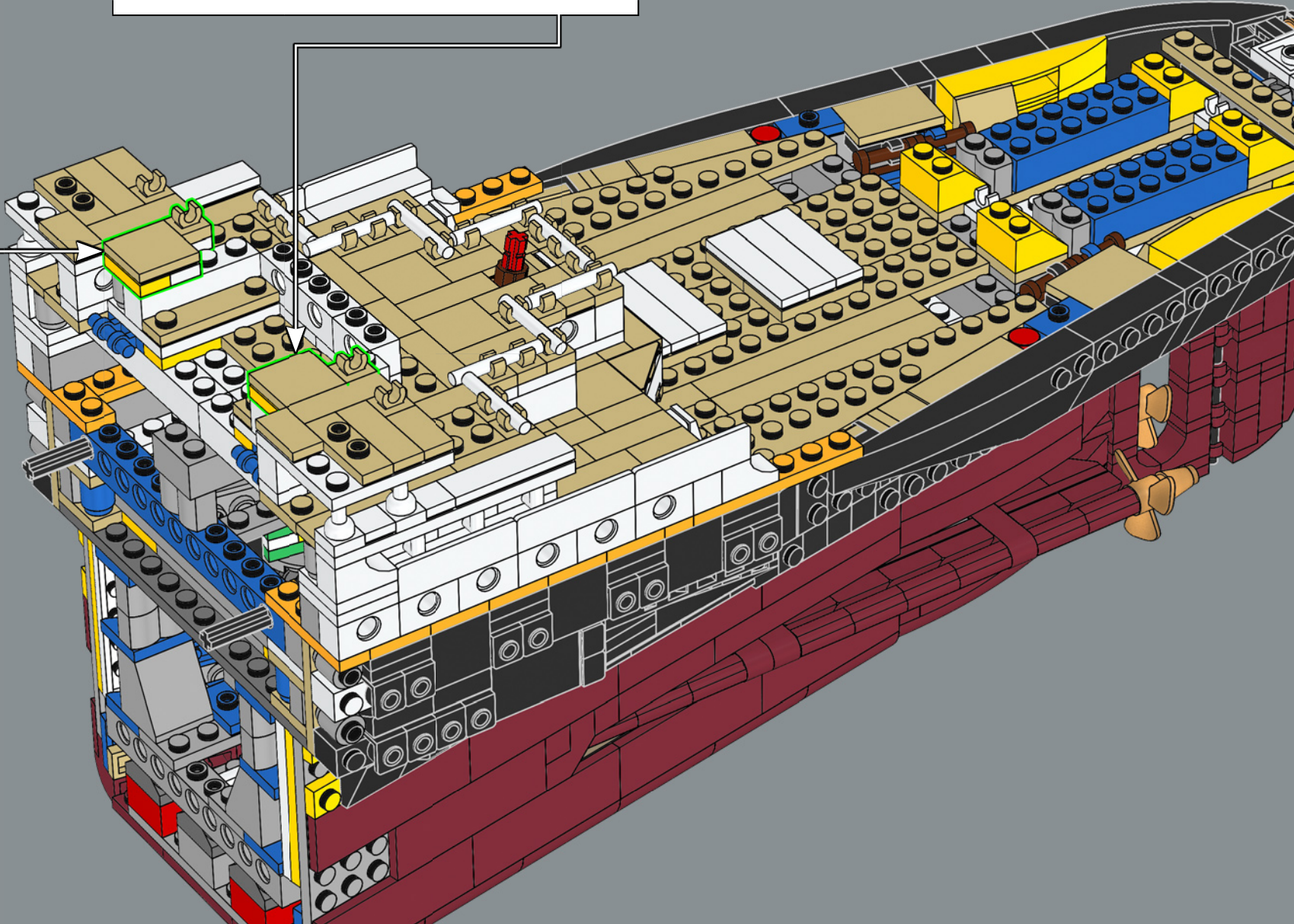
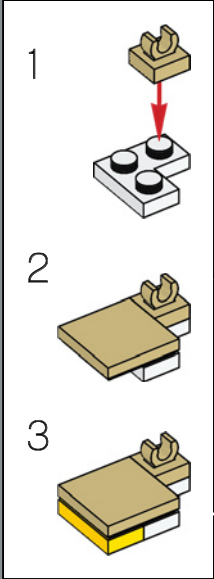
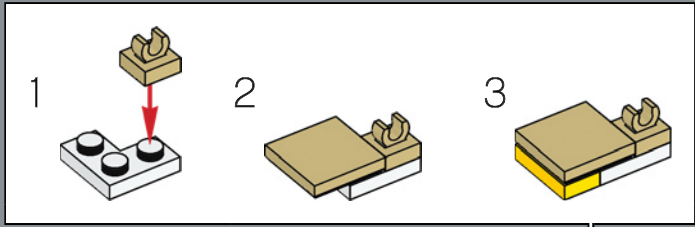

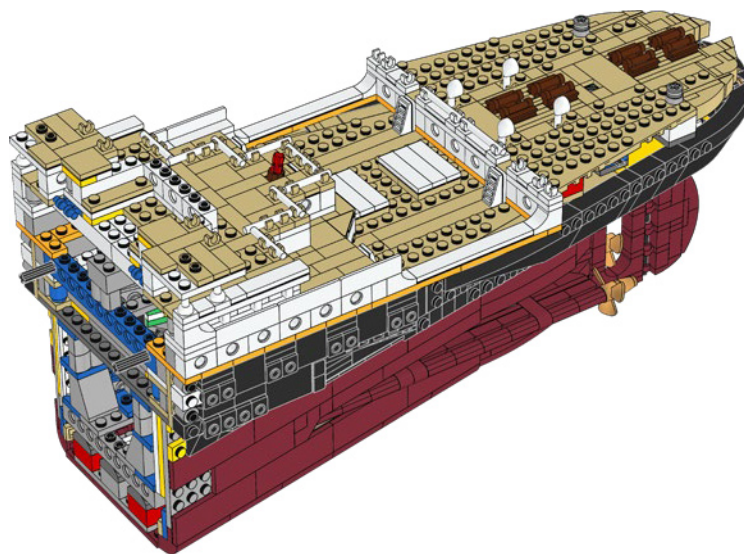

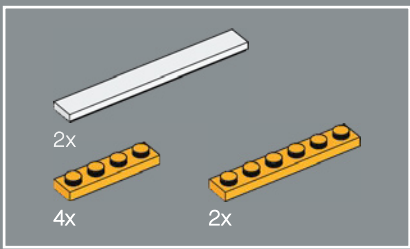

344

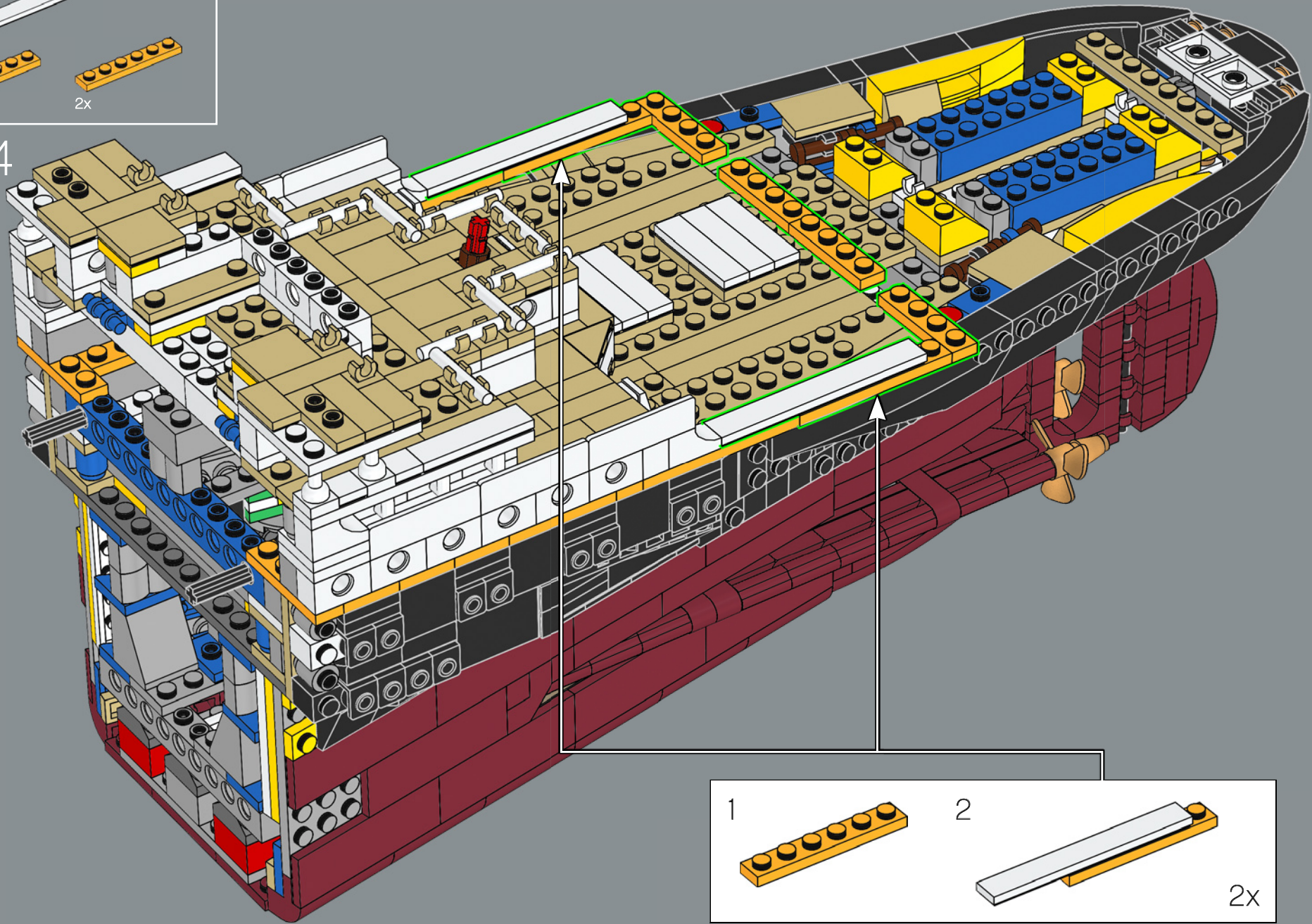

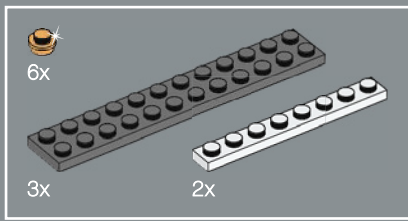

345

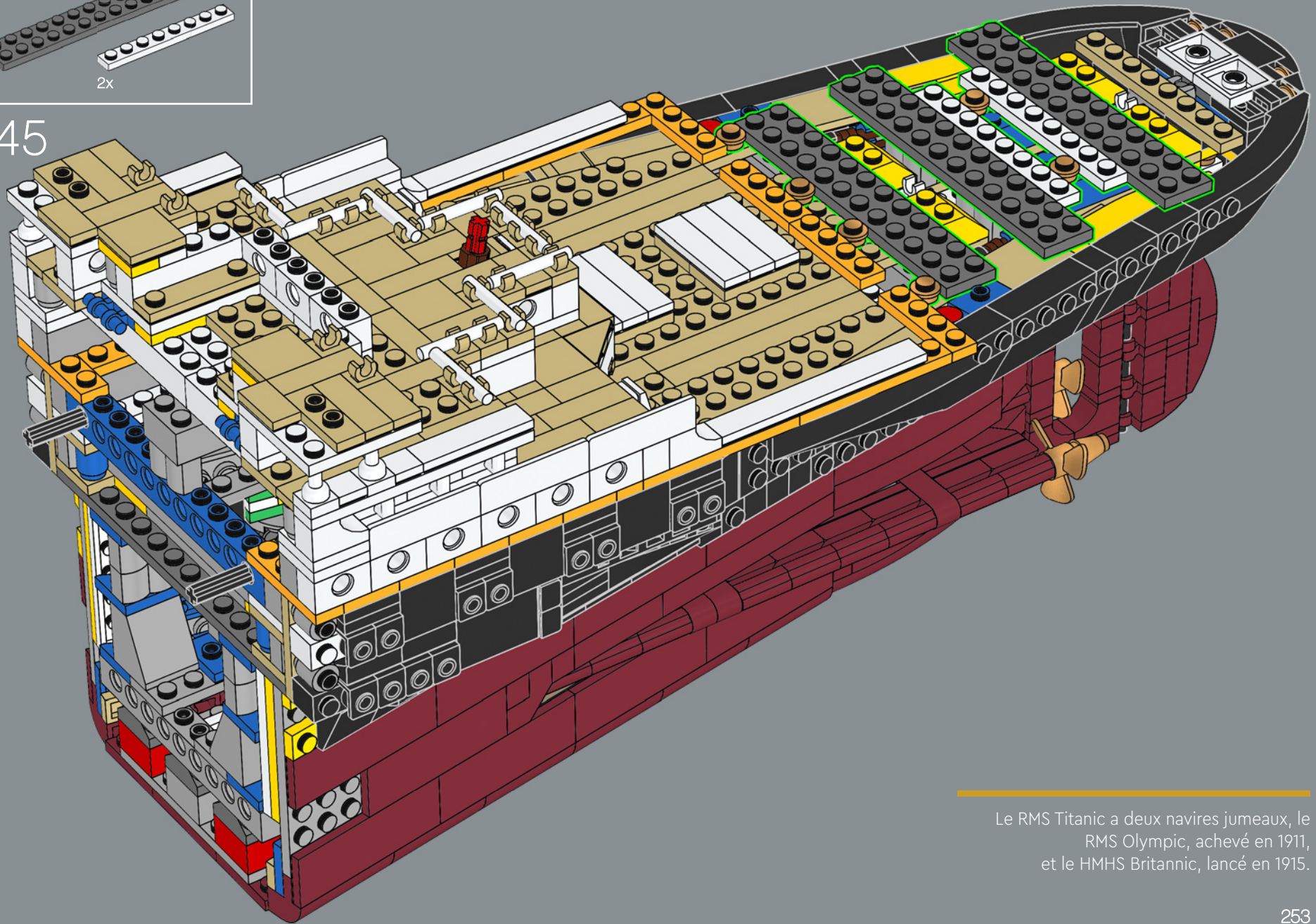

Le RMS Titanic a deux navires jumeaux, le RMS Olympic, achevé en 1911, et le HMHS Britannic, lancé en 1915.

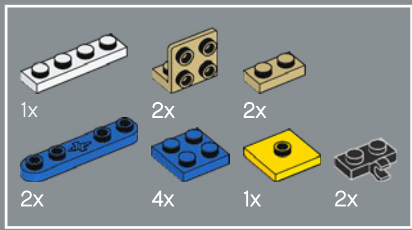

346

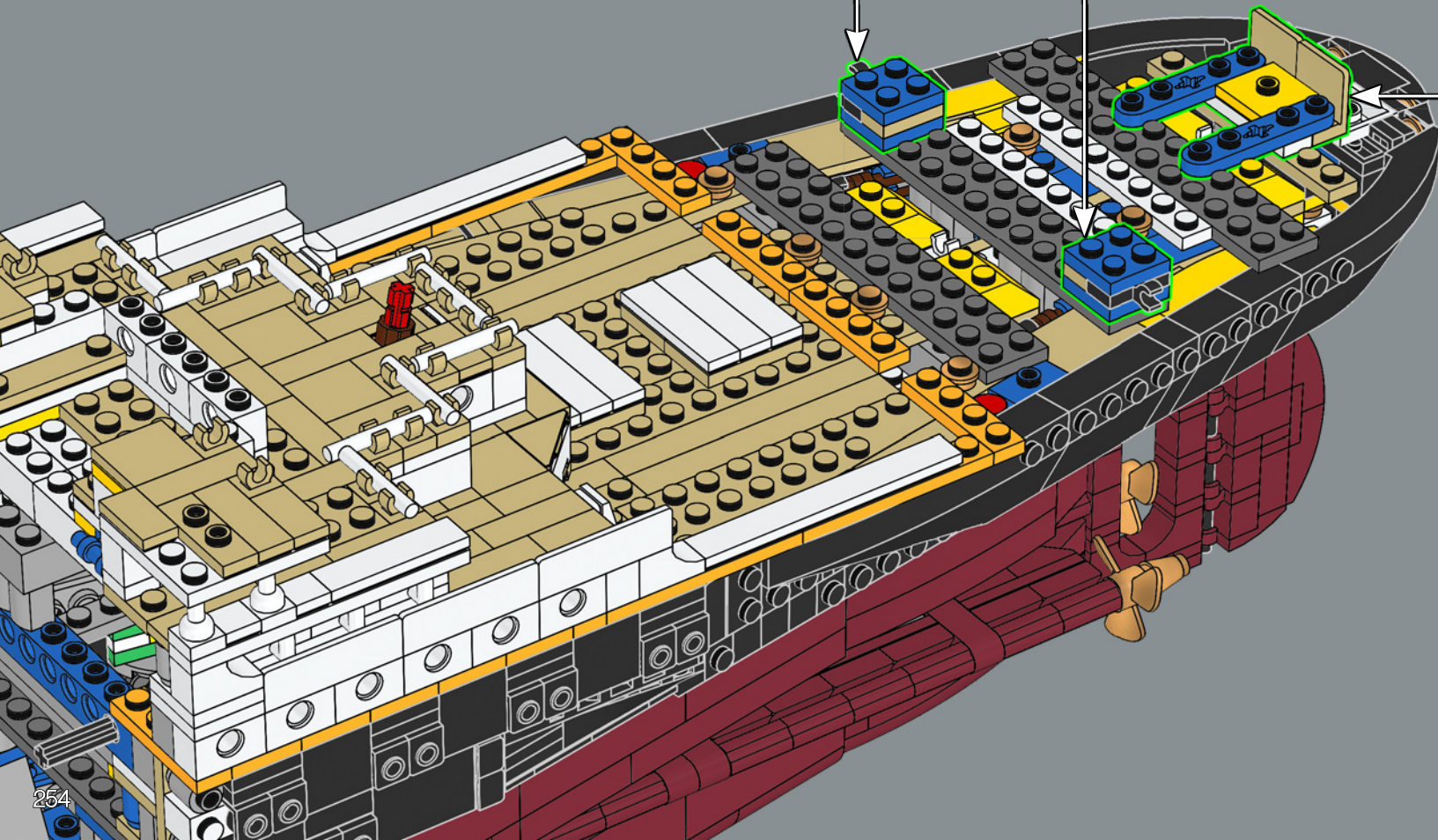
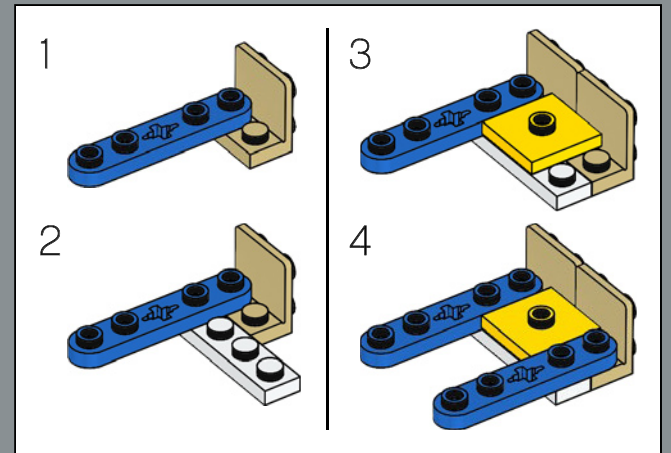
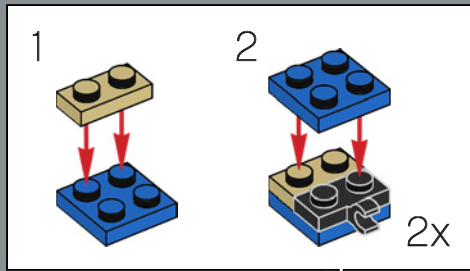

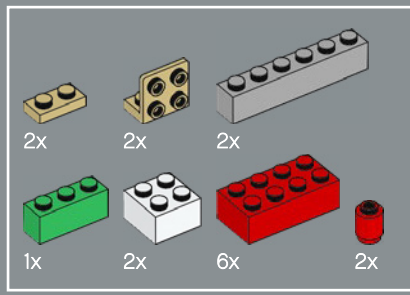

347

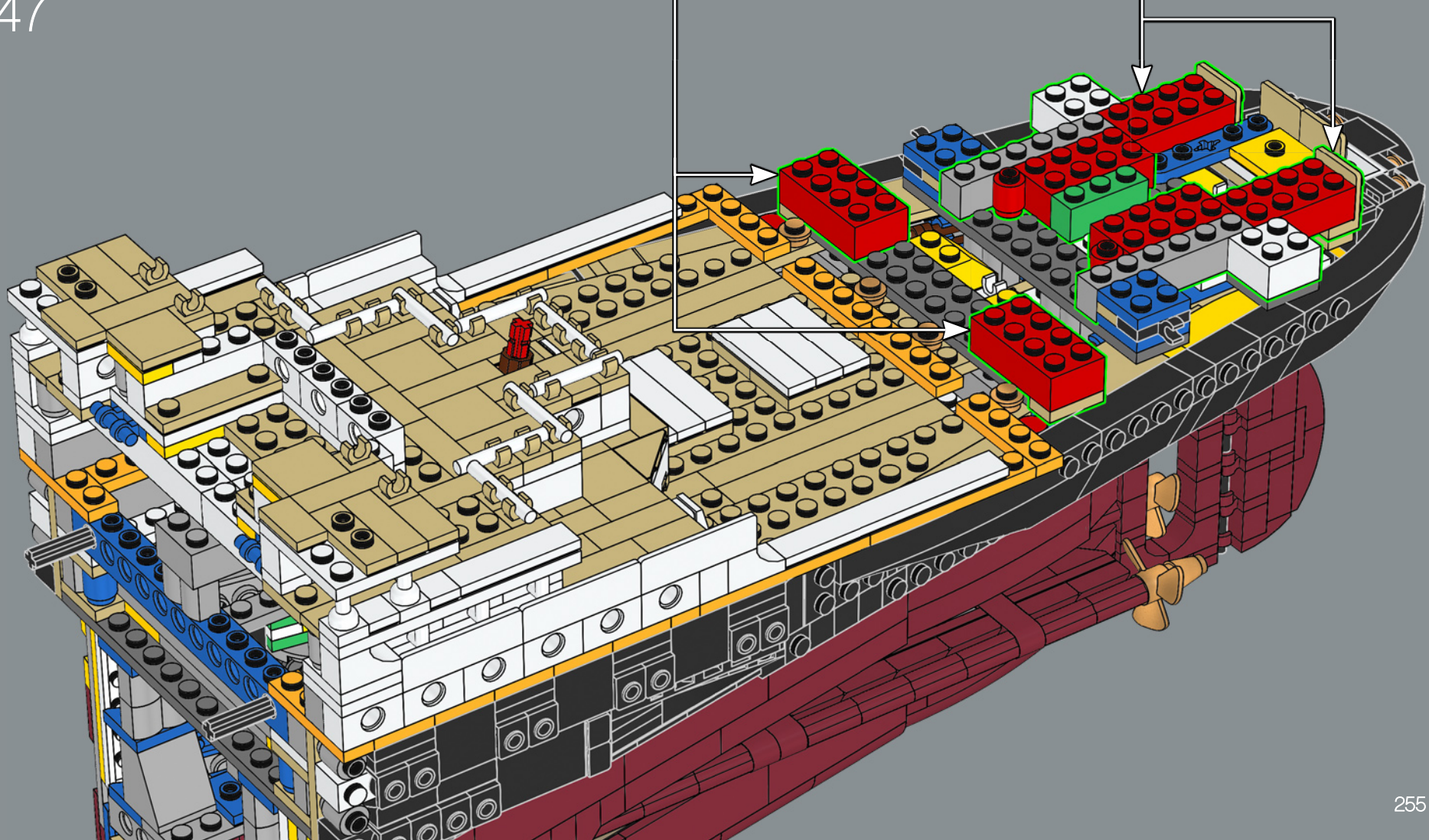
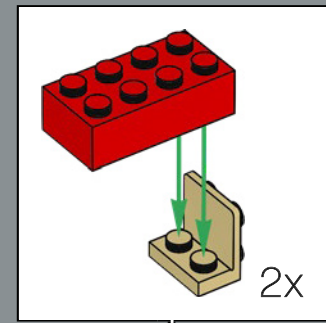
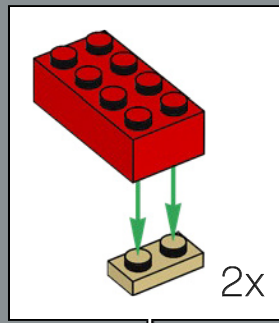

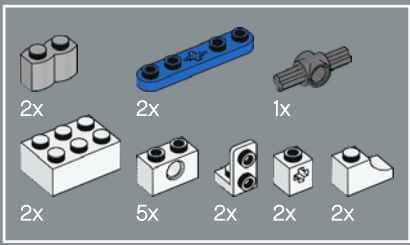

348

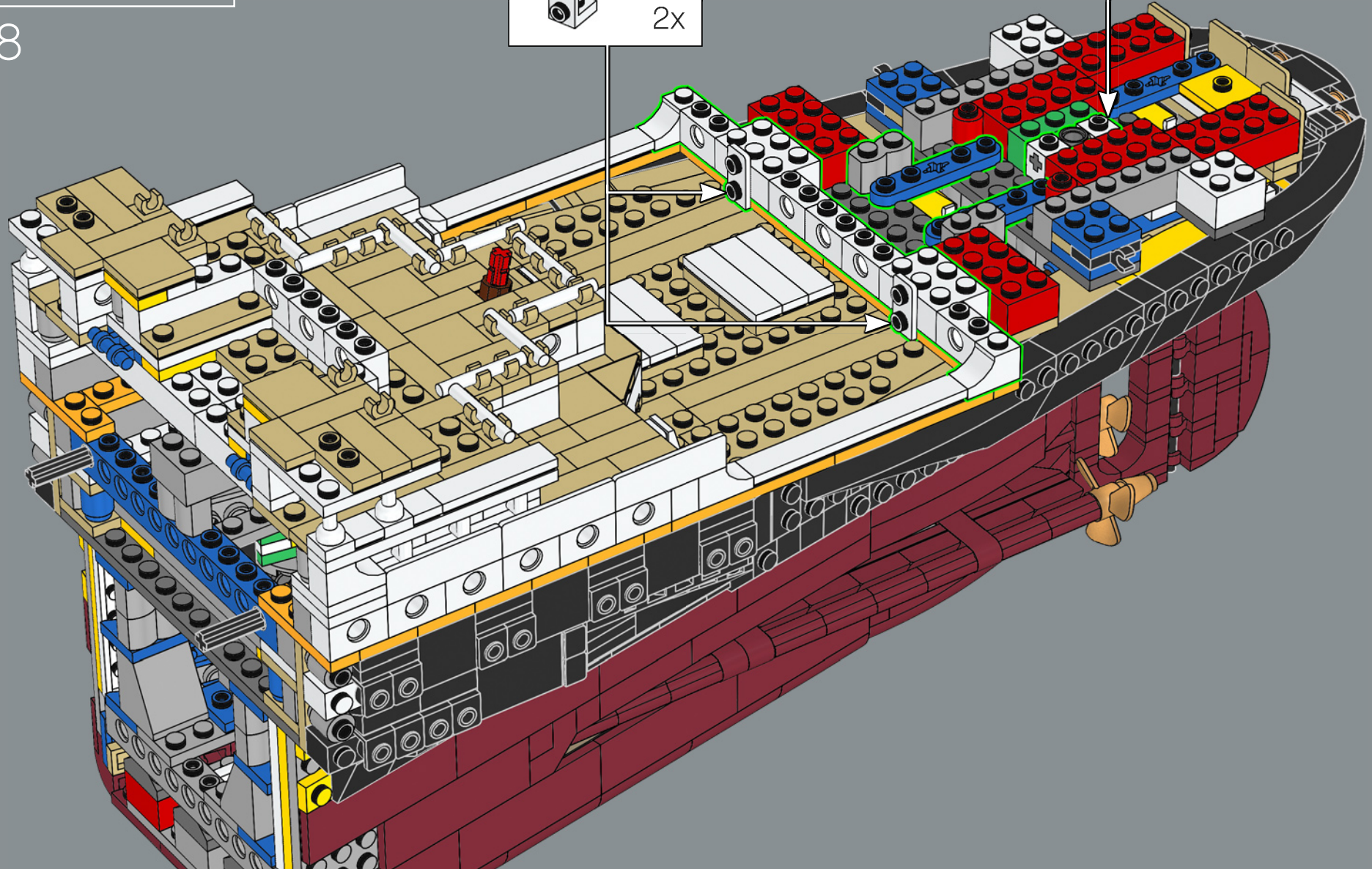
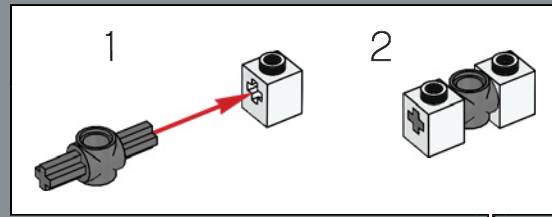
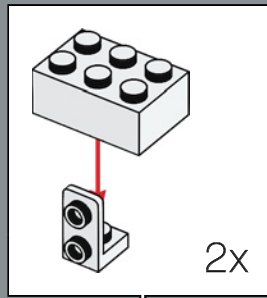



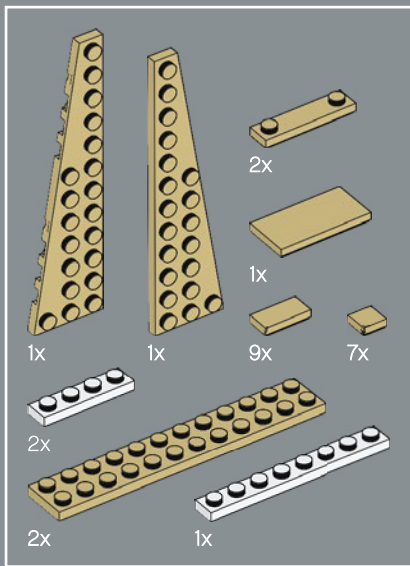

349

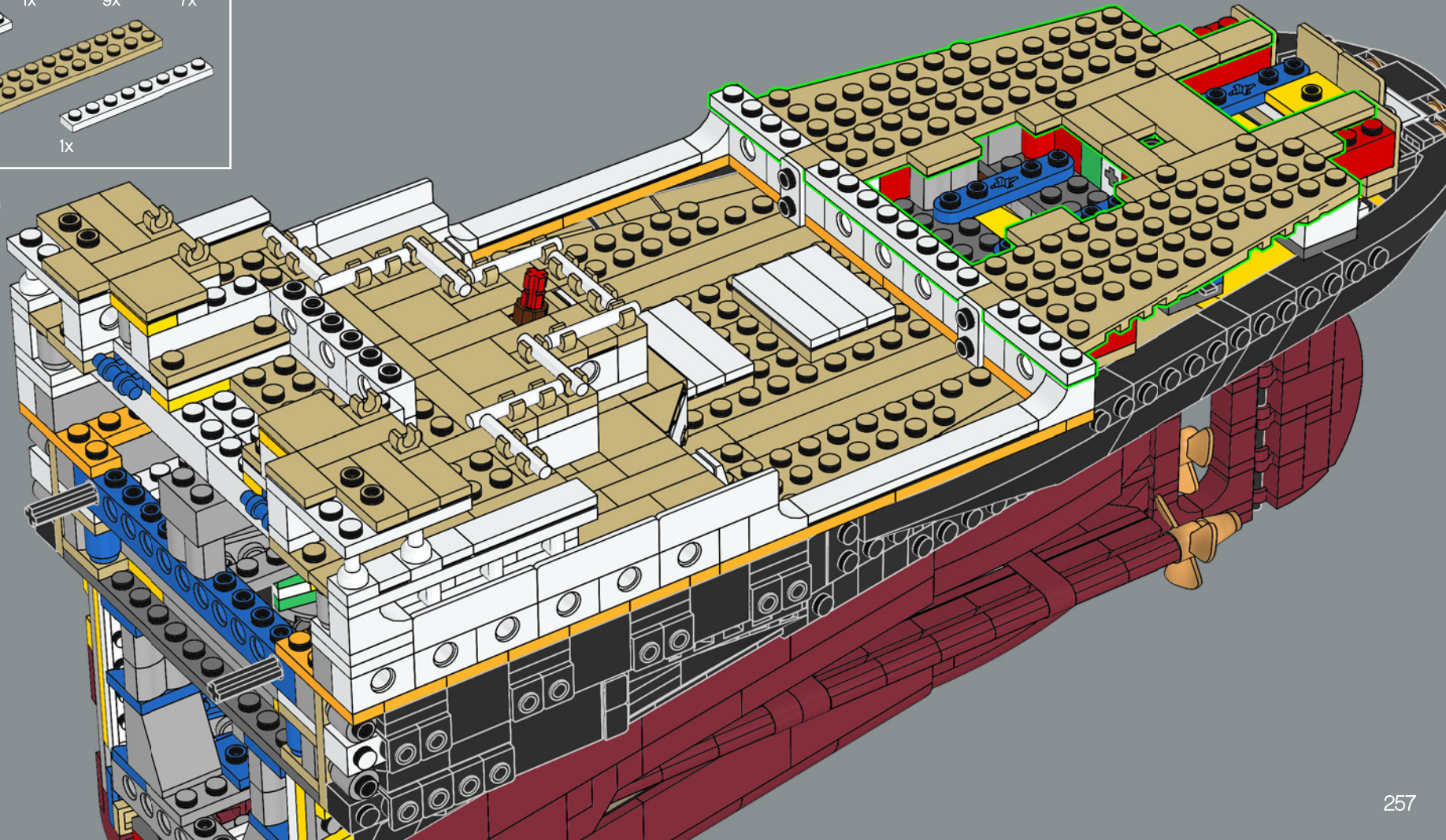

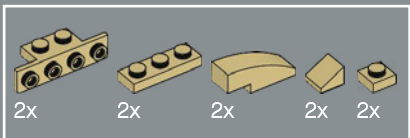

350

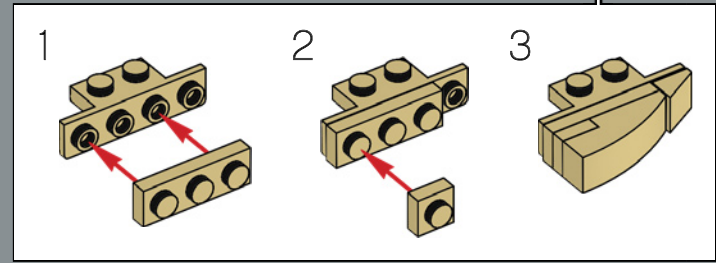
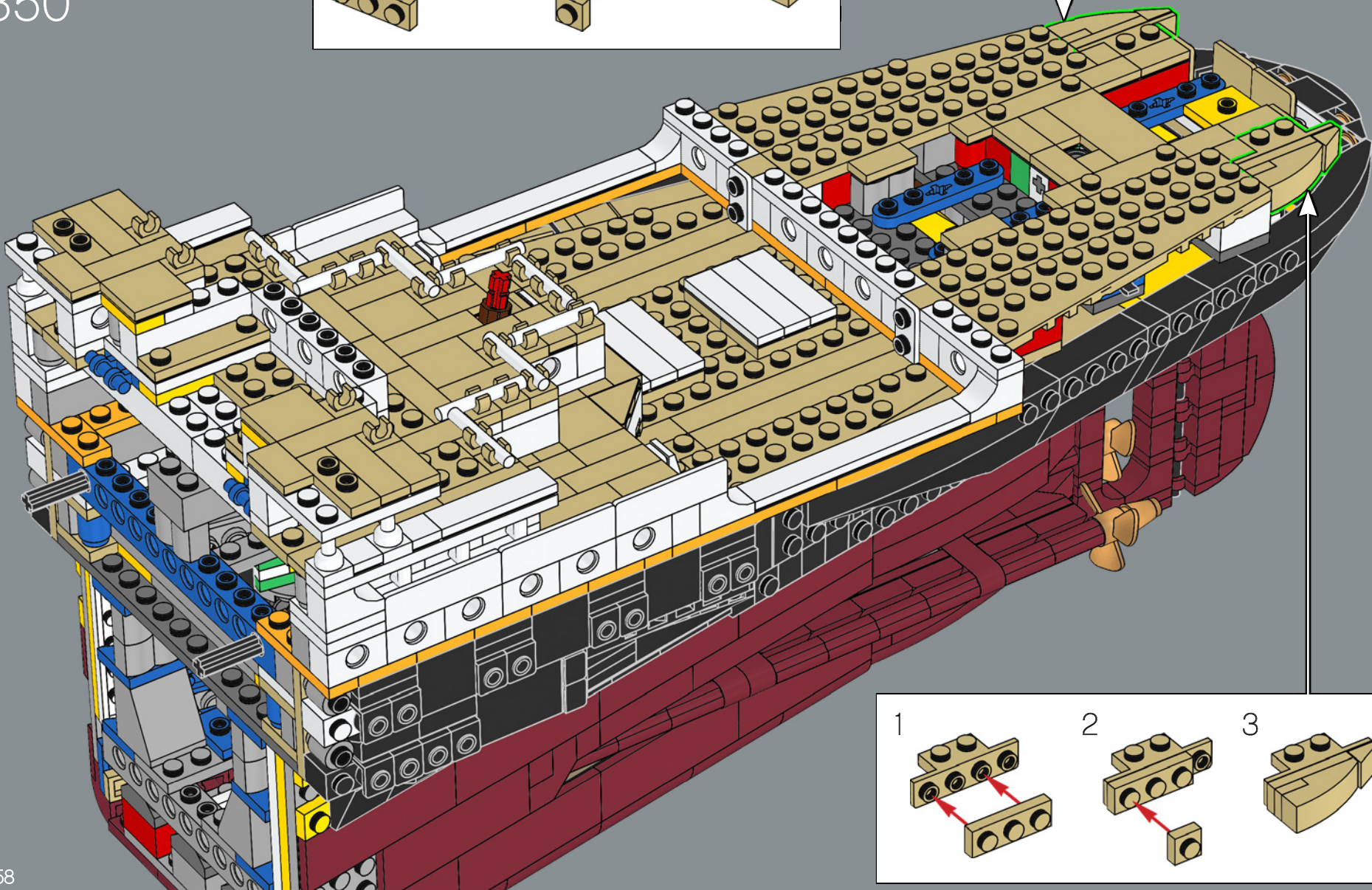
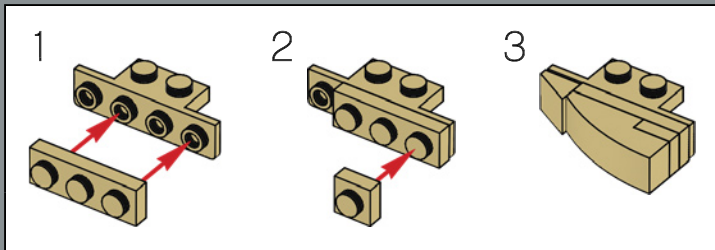

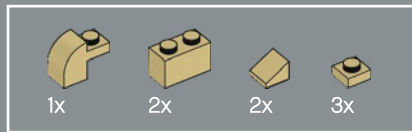

351

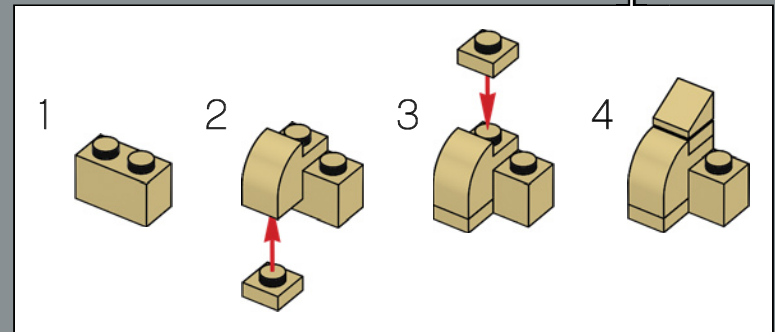
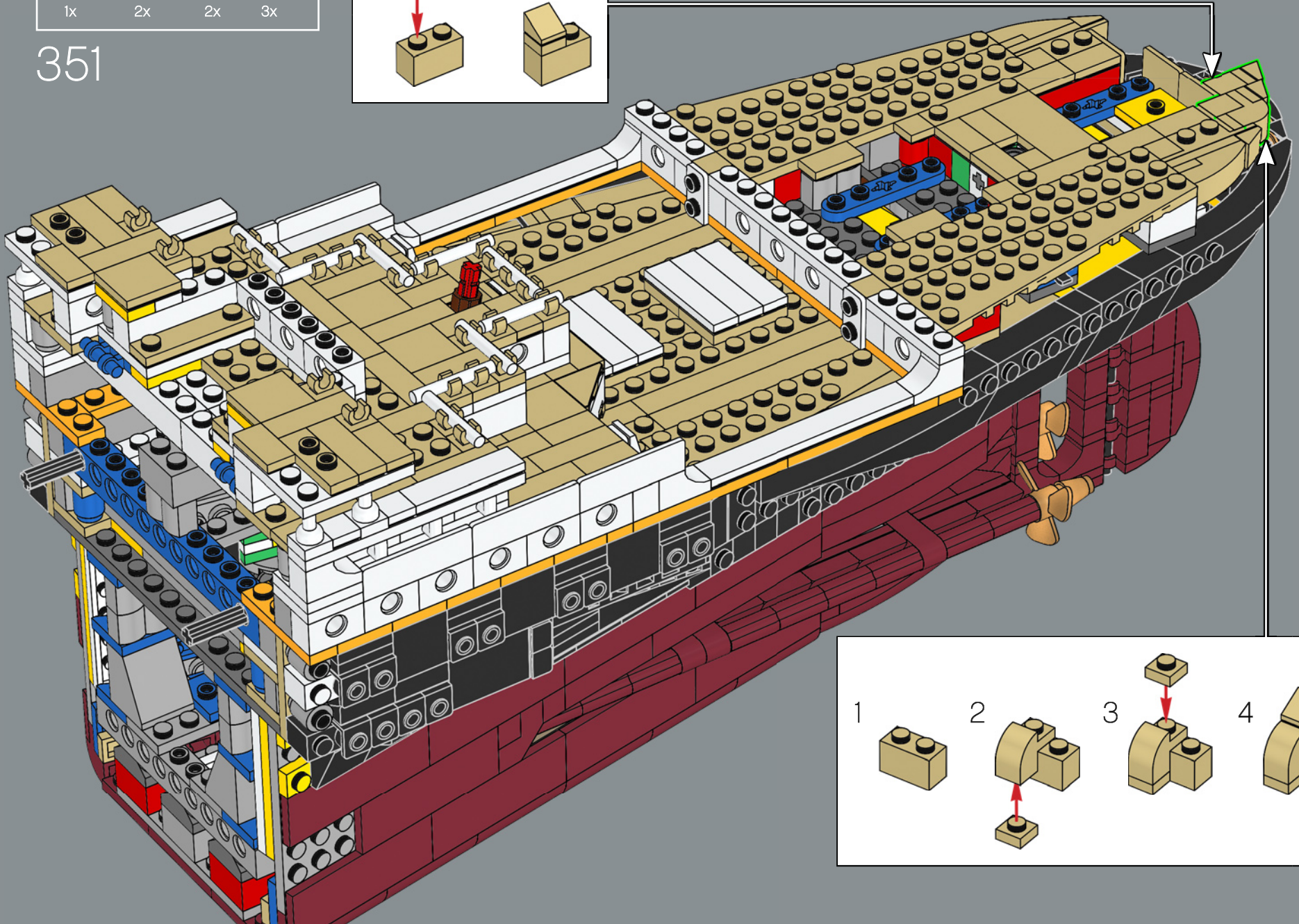
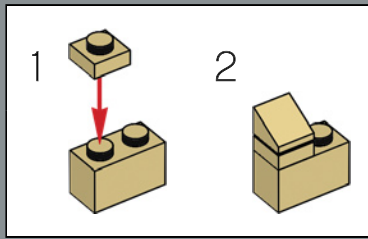

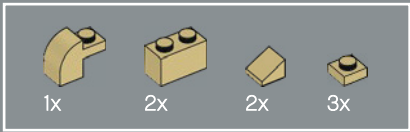

352

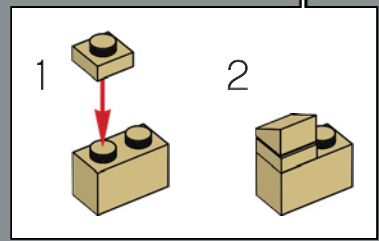
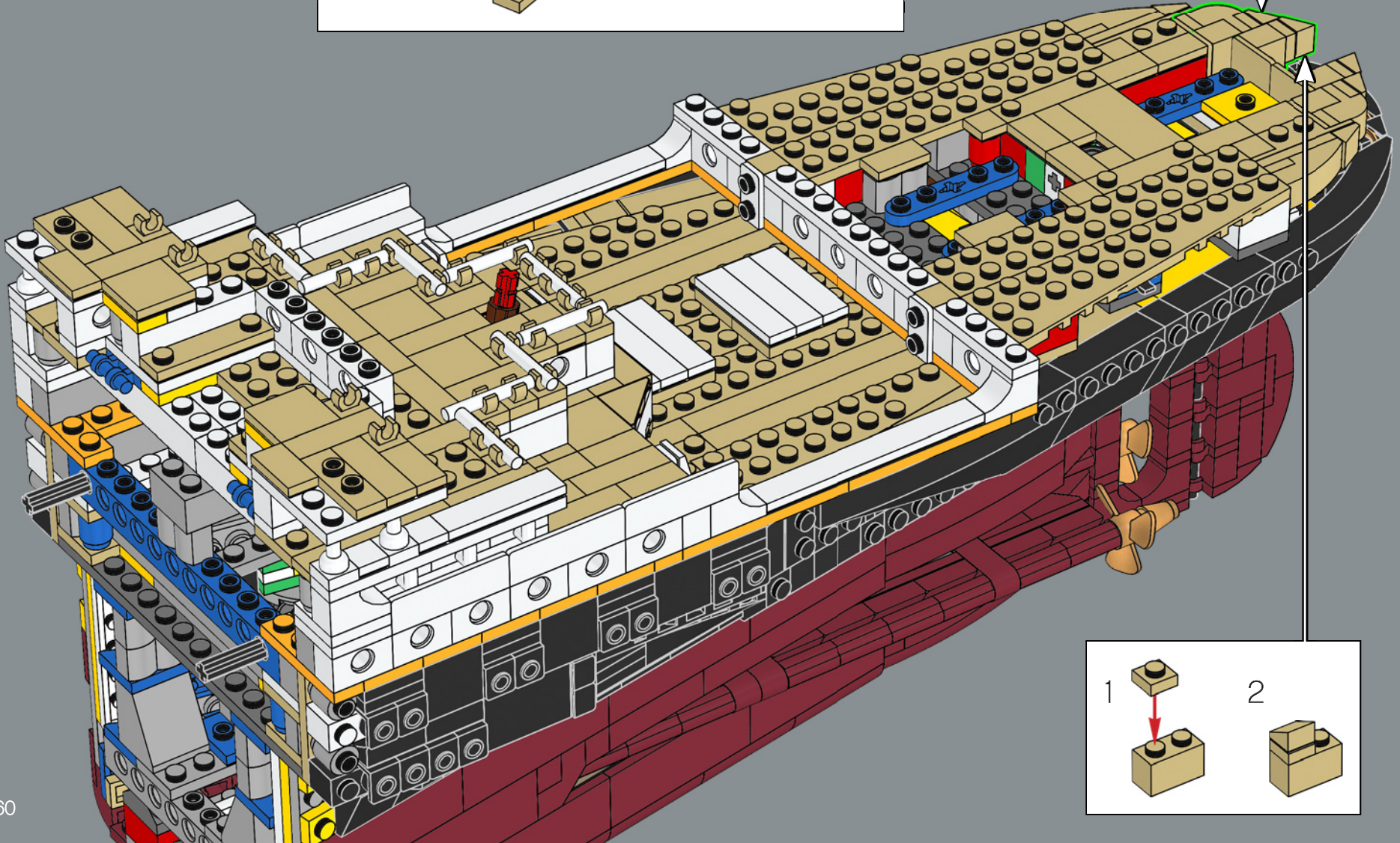
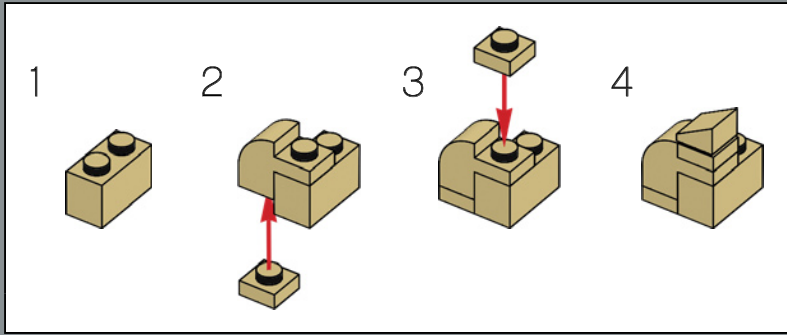

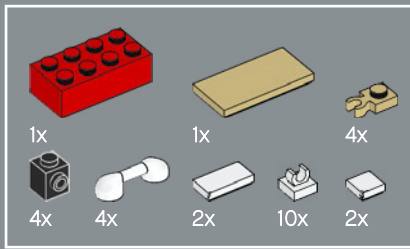

353

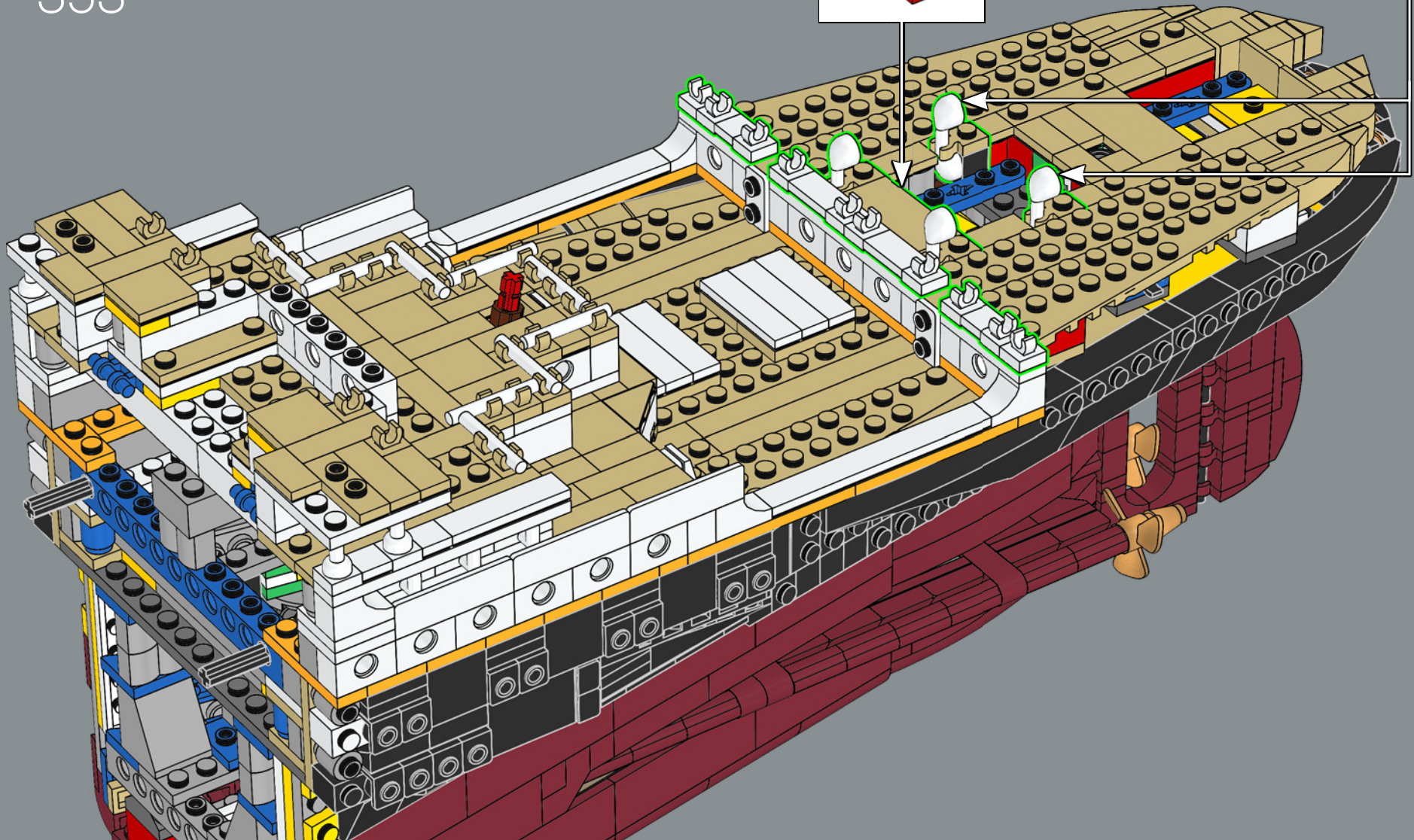
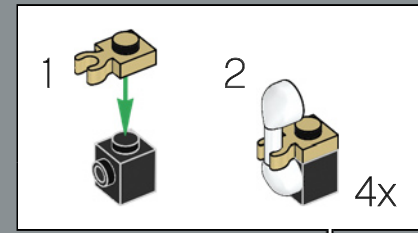
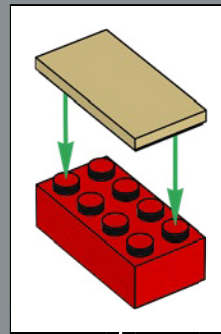



354

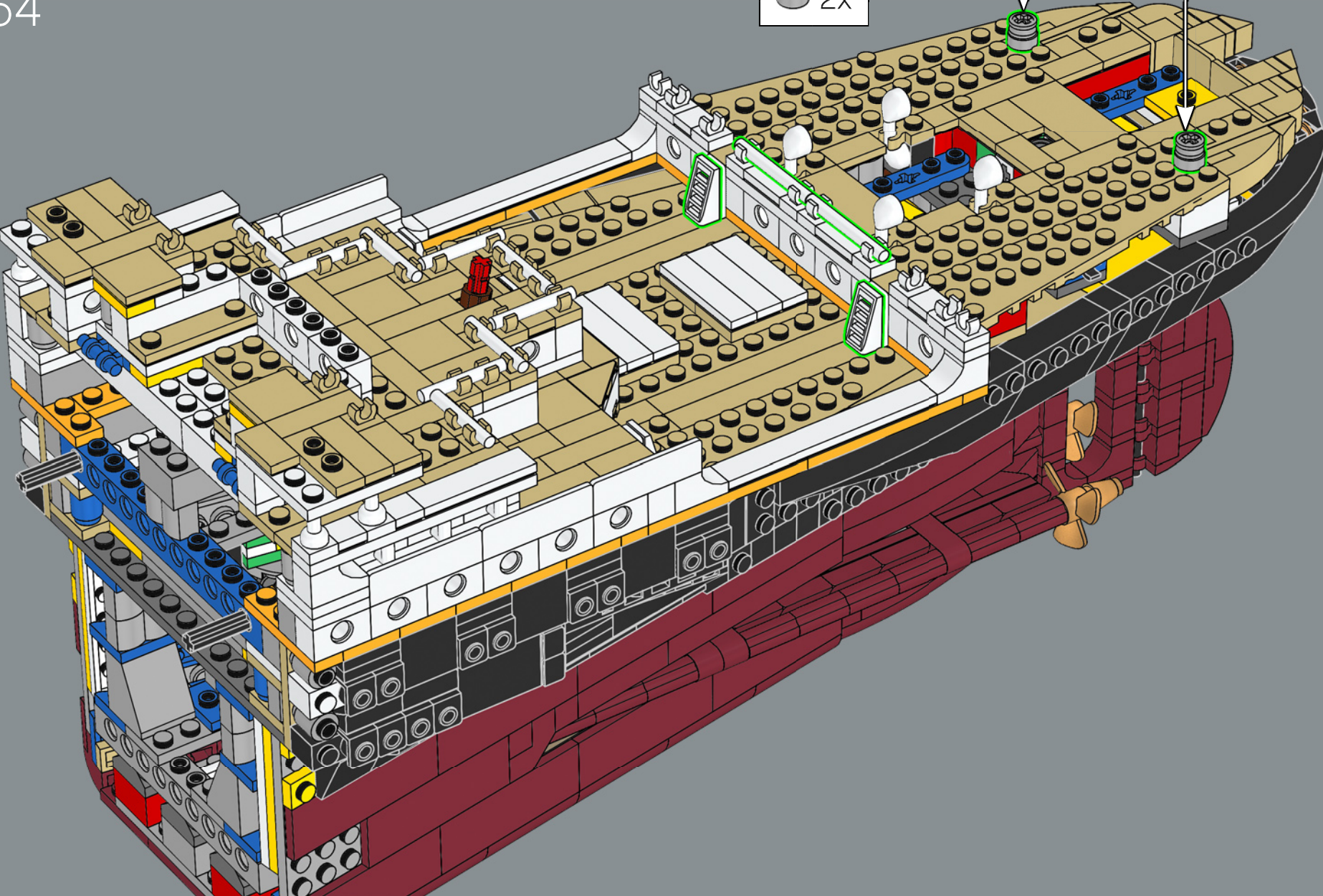
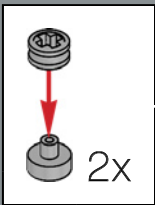

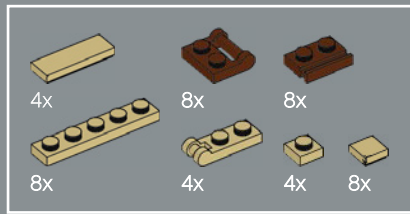

355

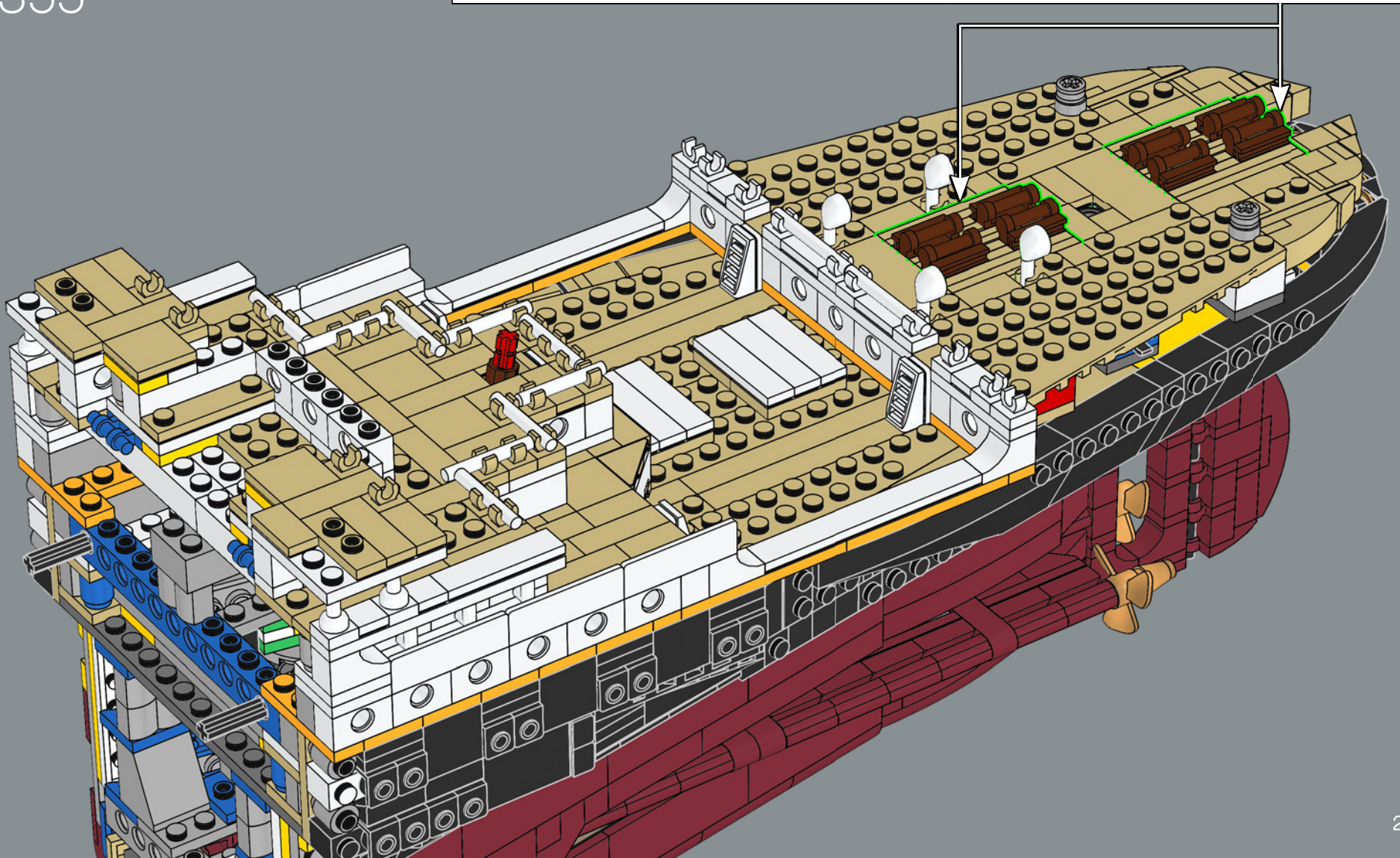
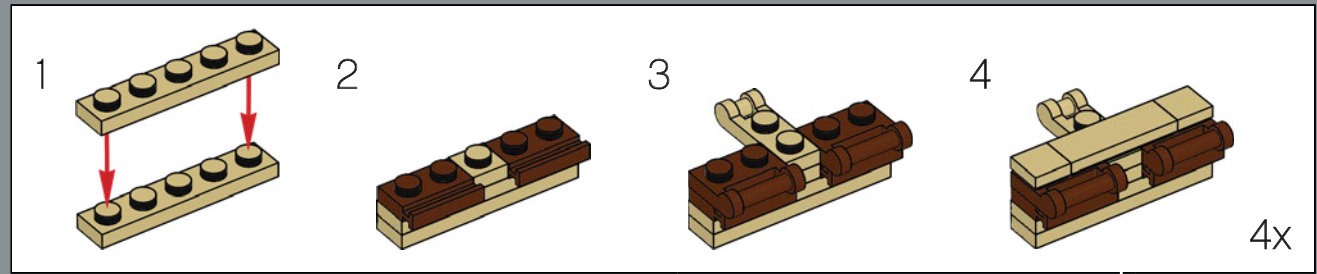

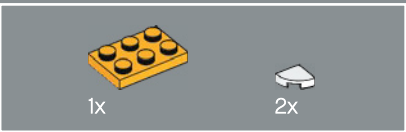
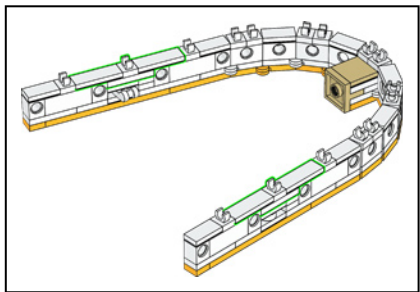
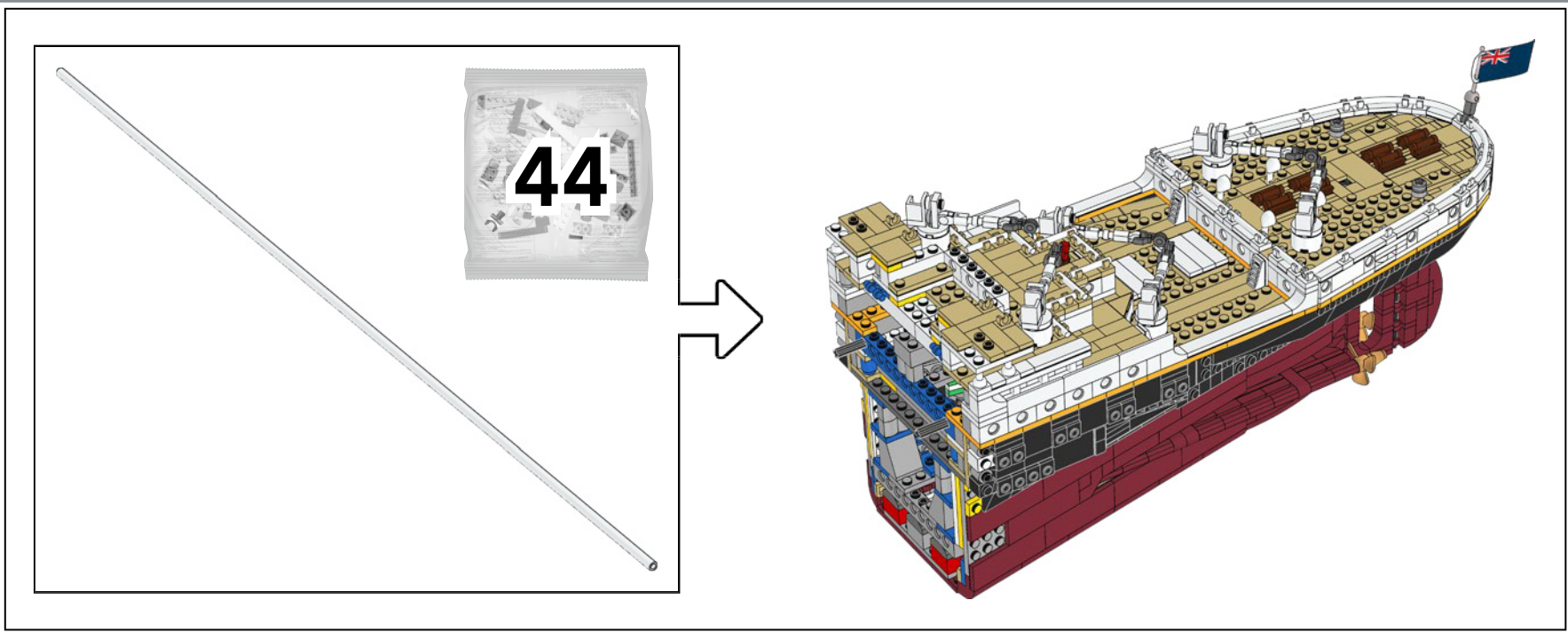

356

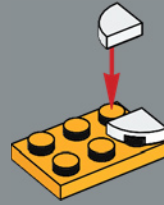

357

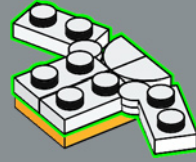



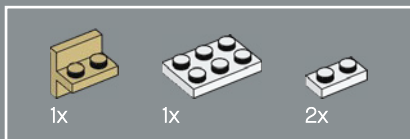

358

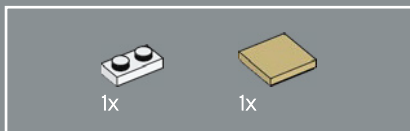
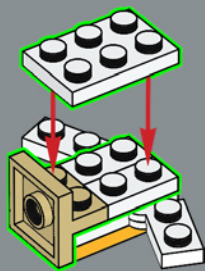

359

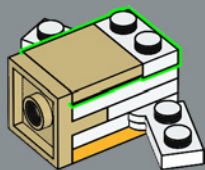

360

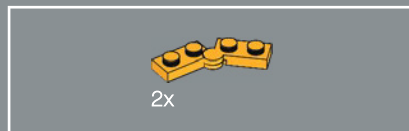
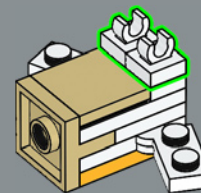

361

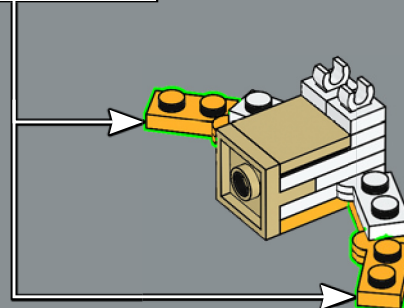
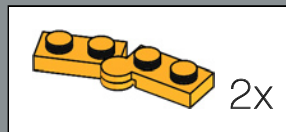



362

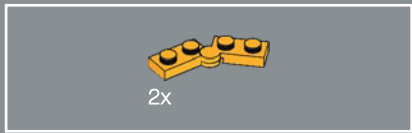
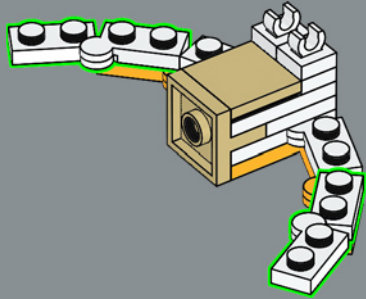

363

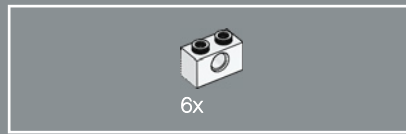
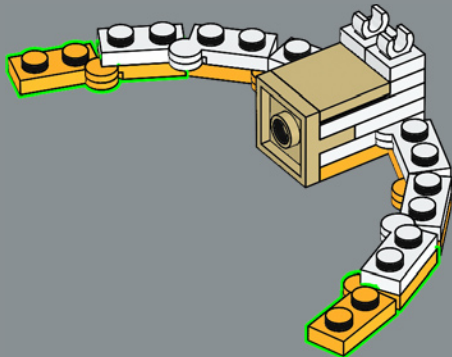

364

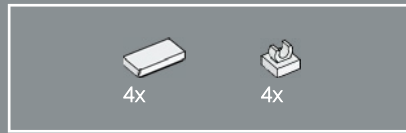
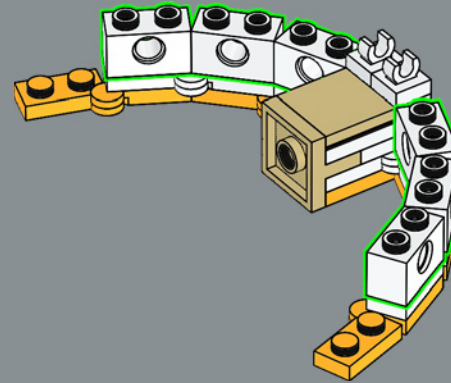

365

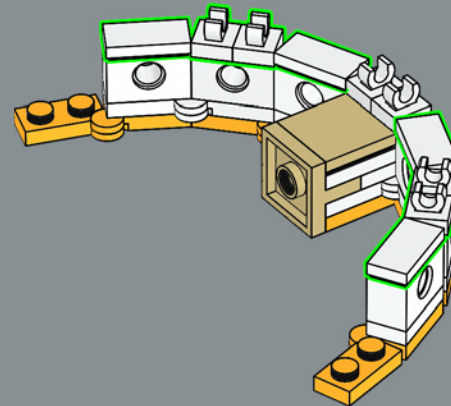



366

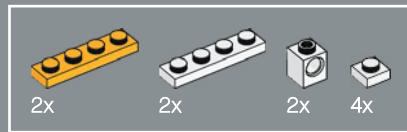
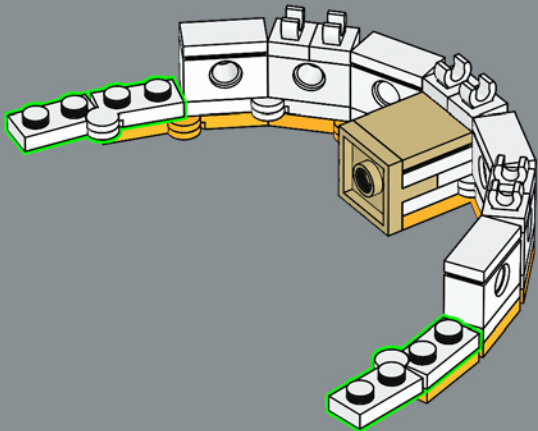

367

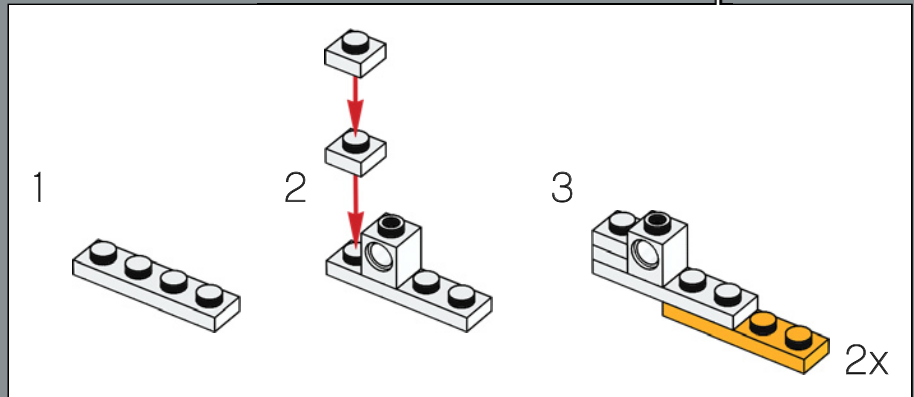
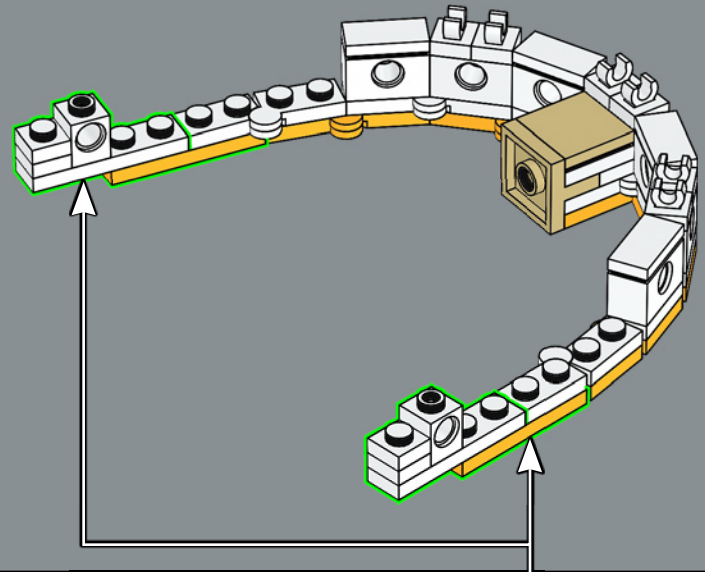

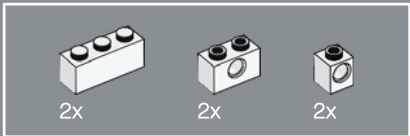

368

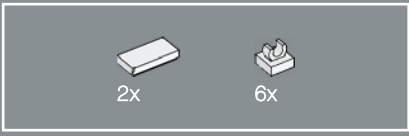
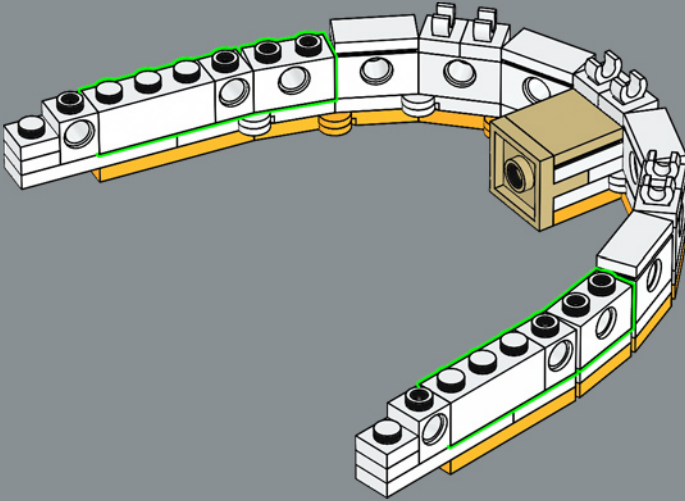

369

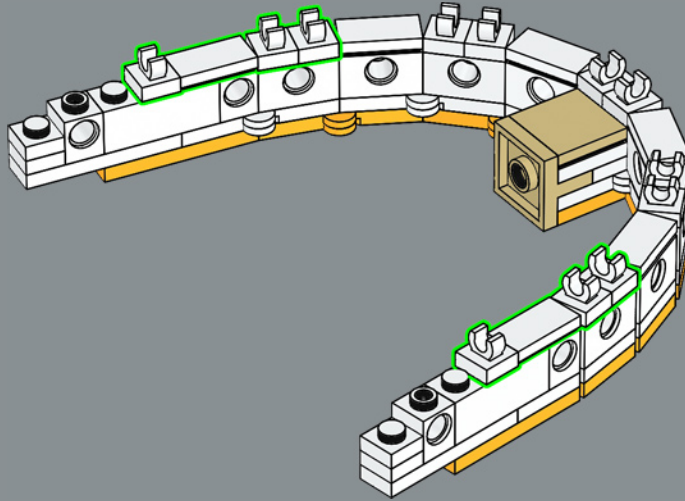

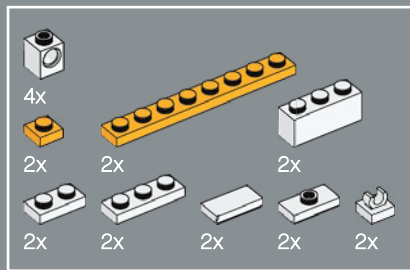

370

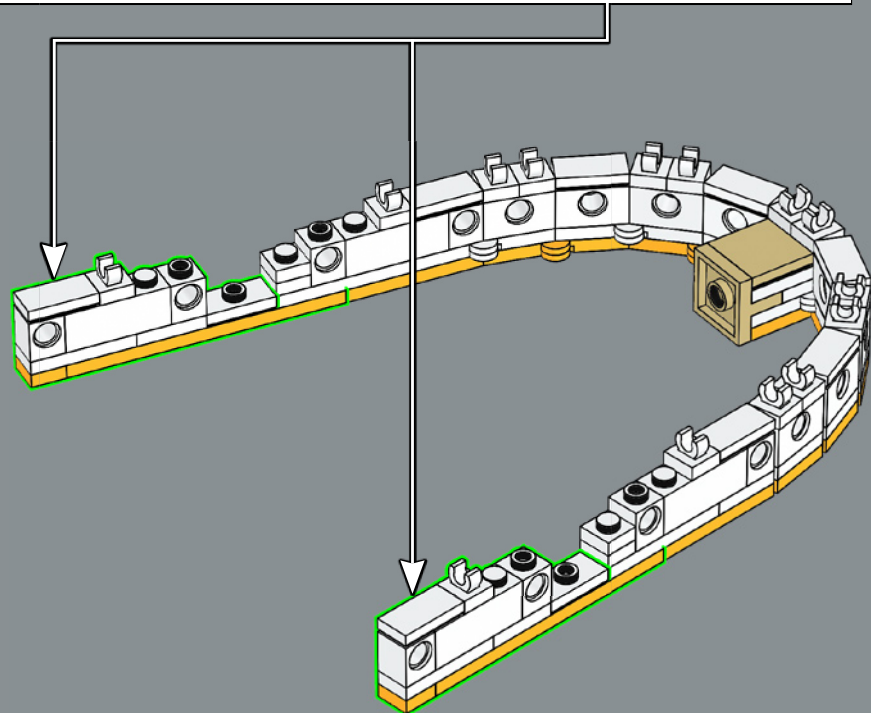
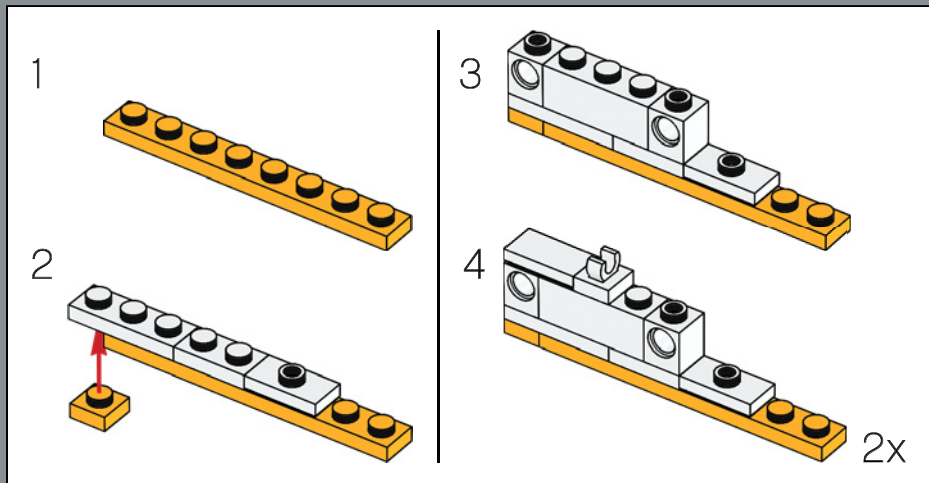



2x

371

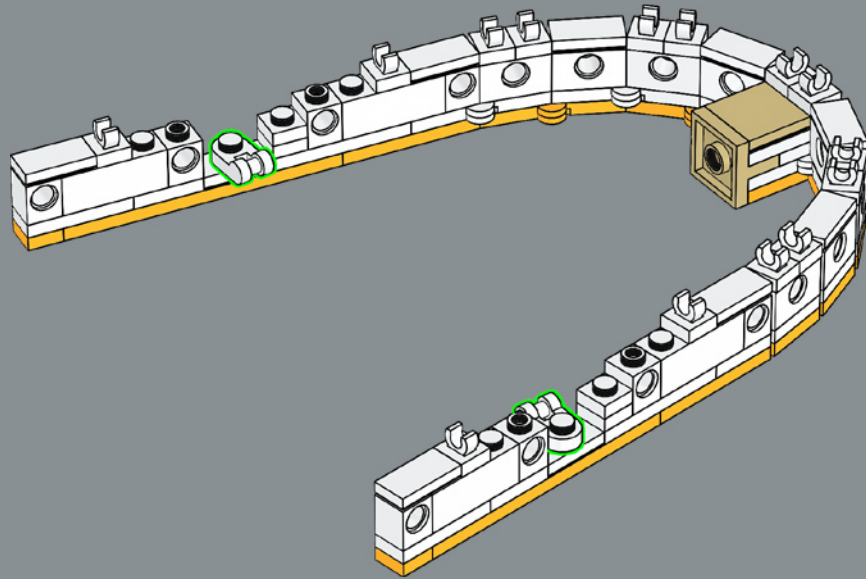

2x

372

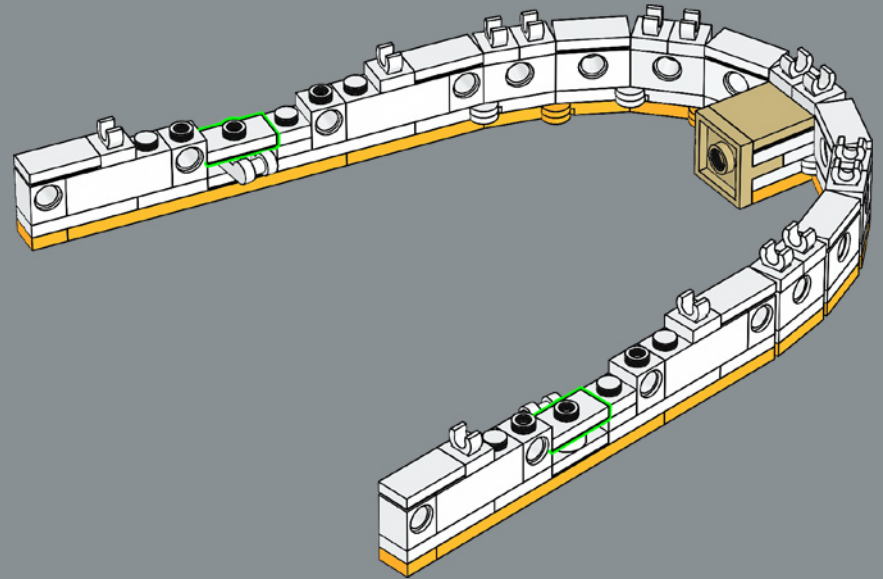

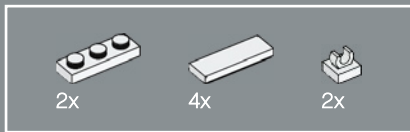

373

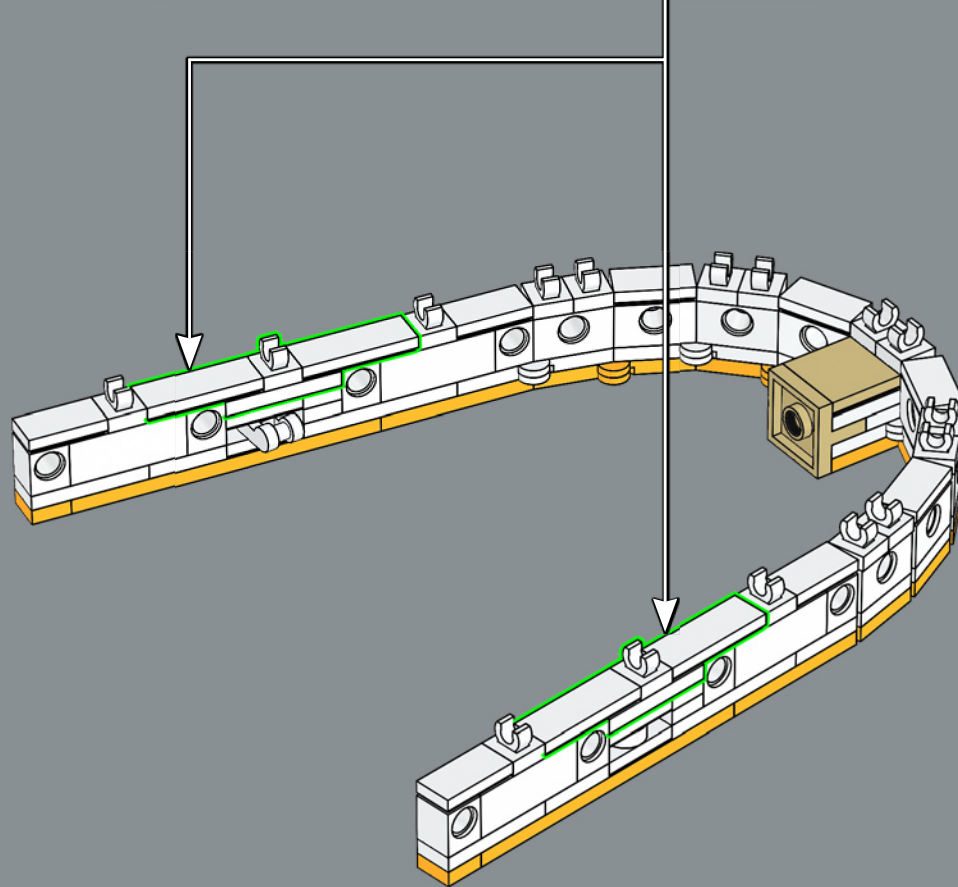
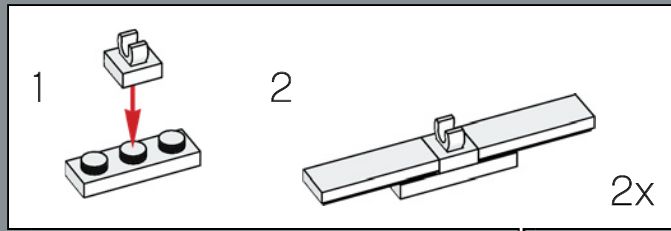

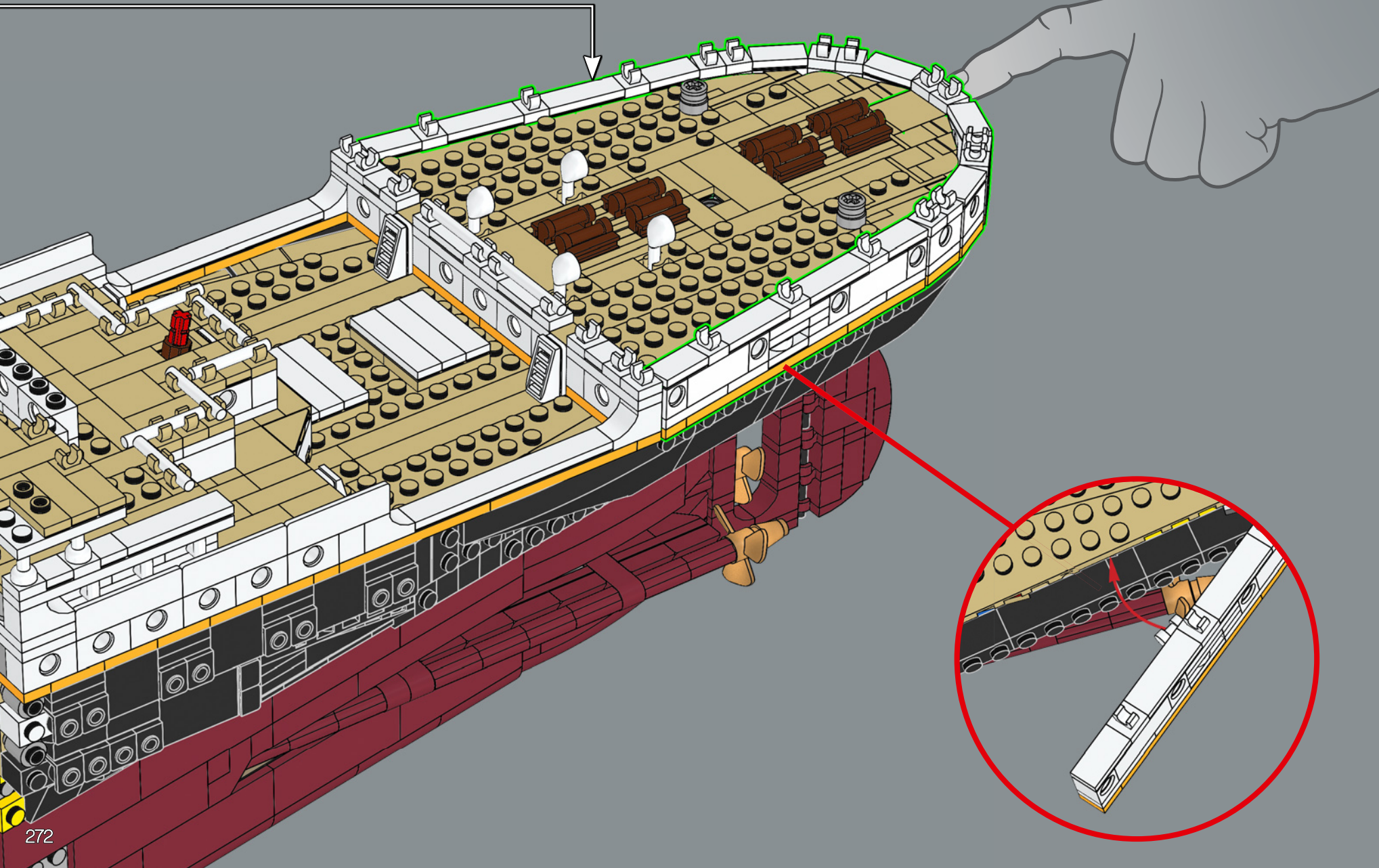



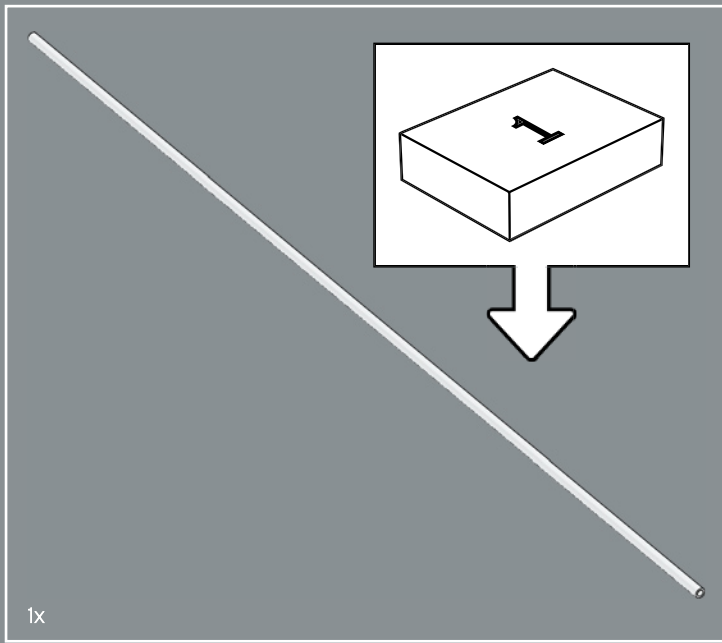

375

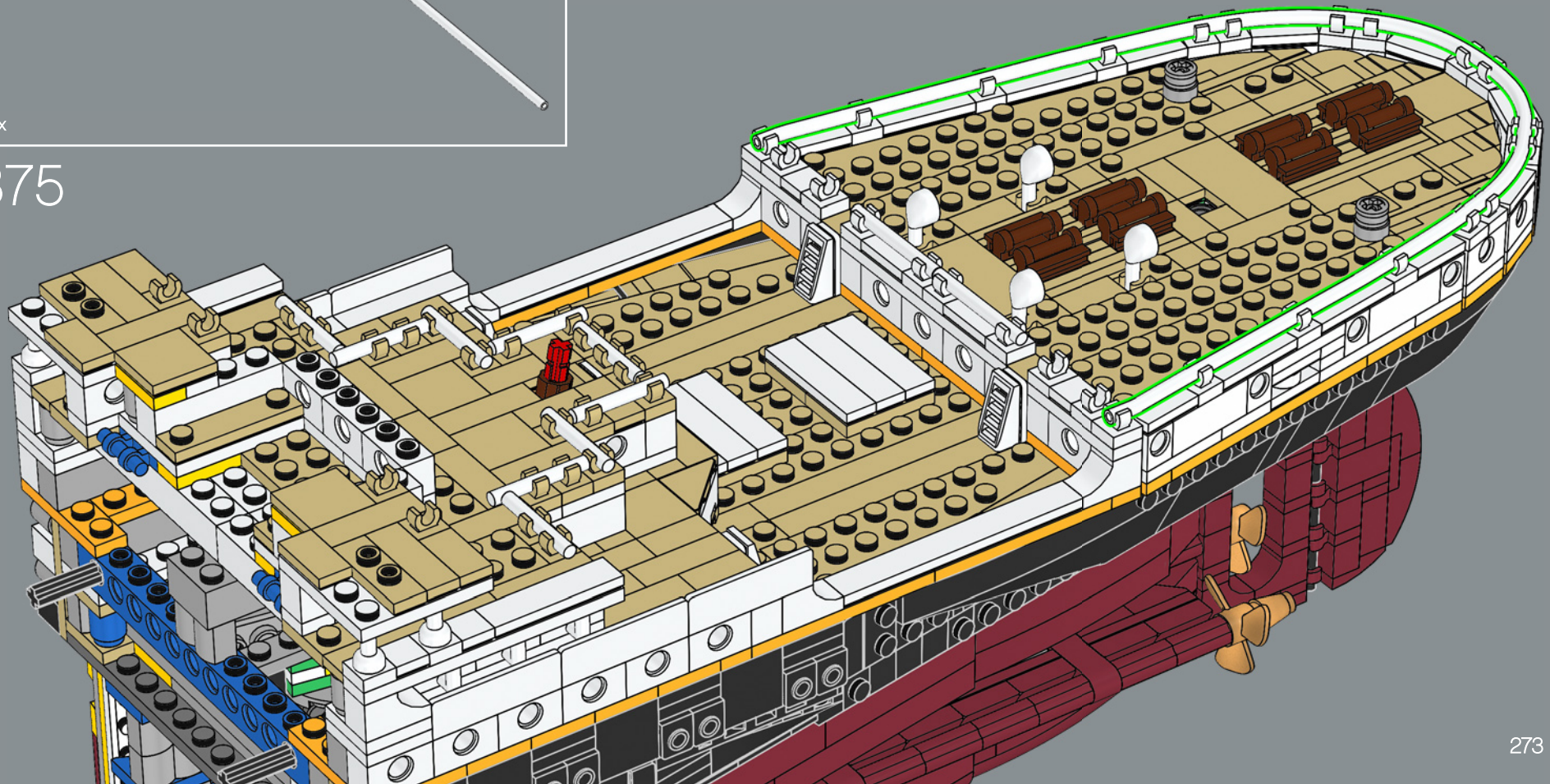



376

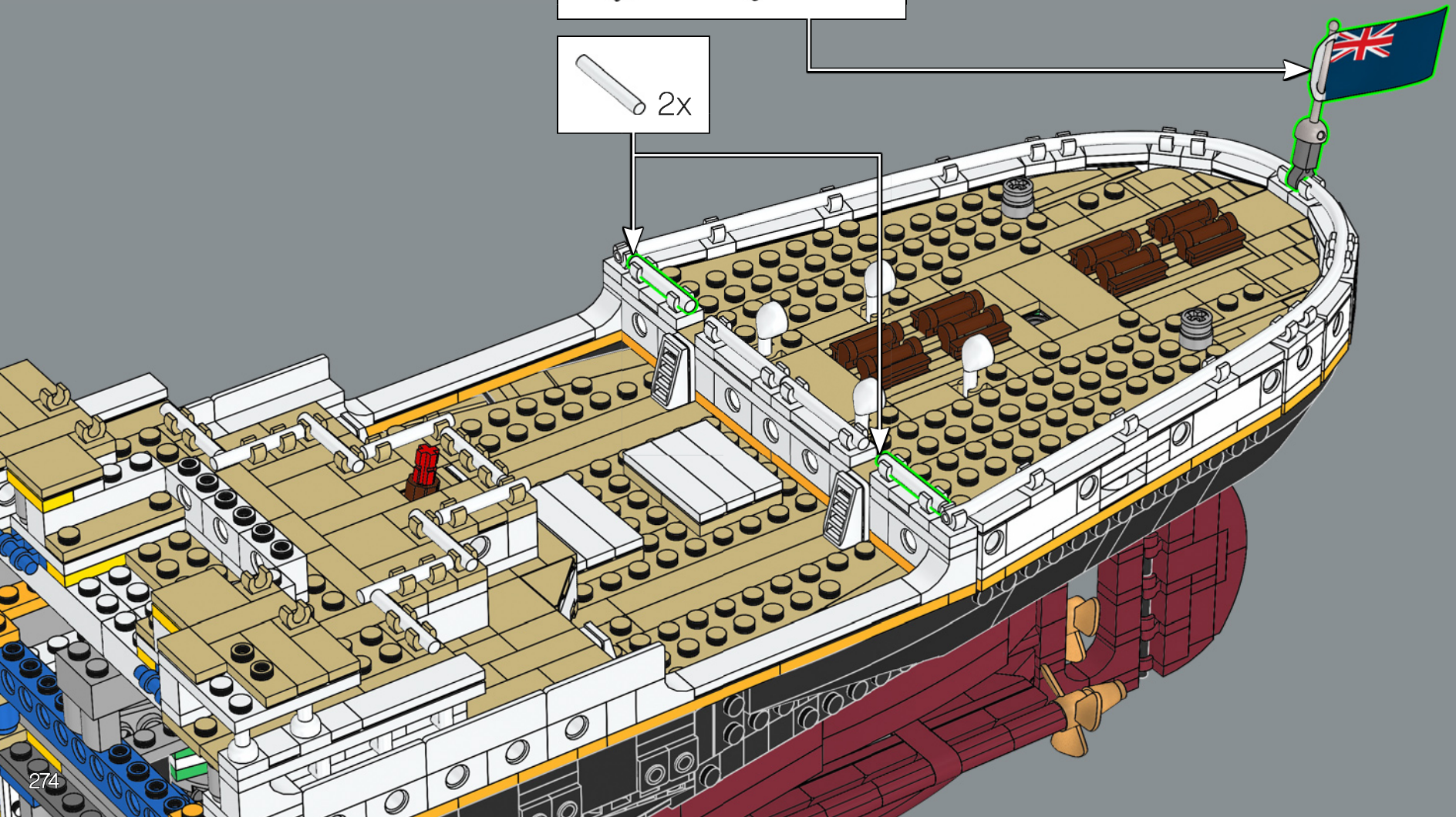
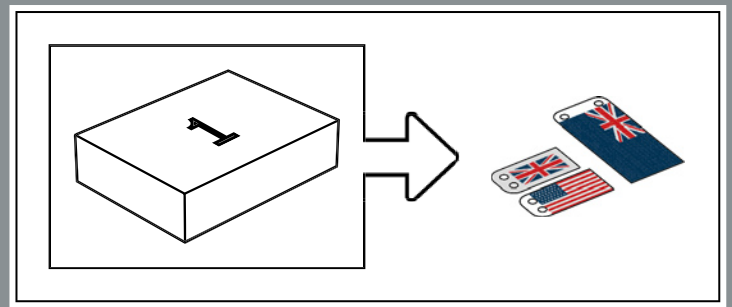
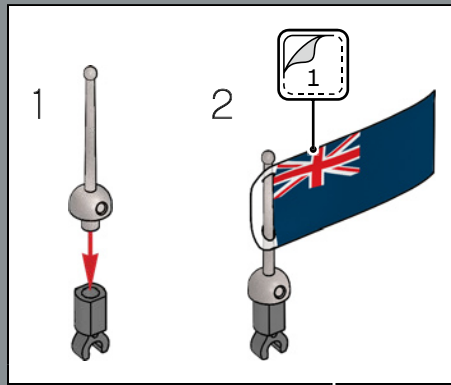

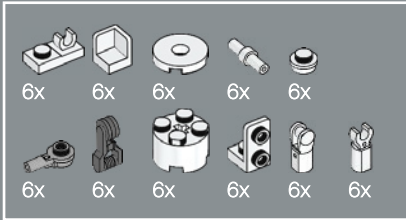
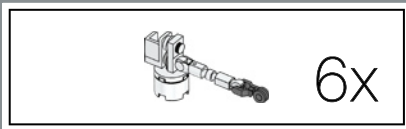

377

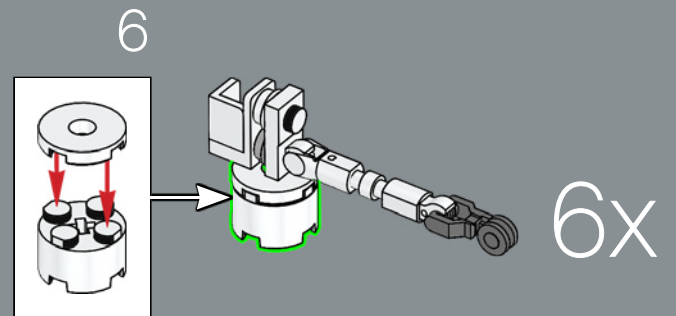
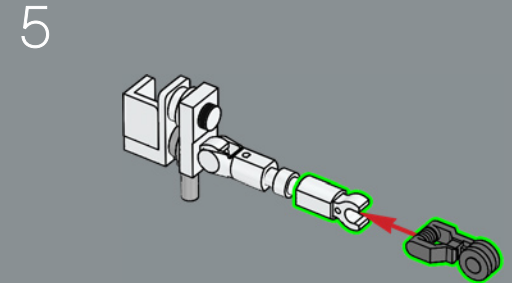
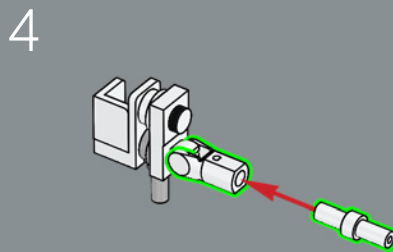
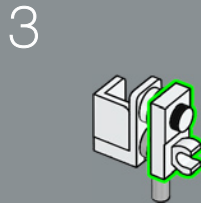
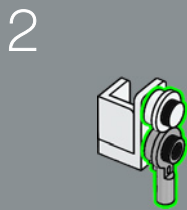
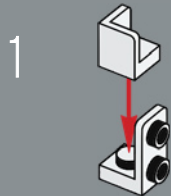

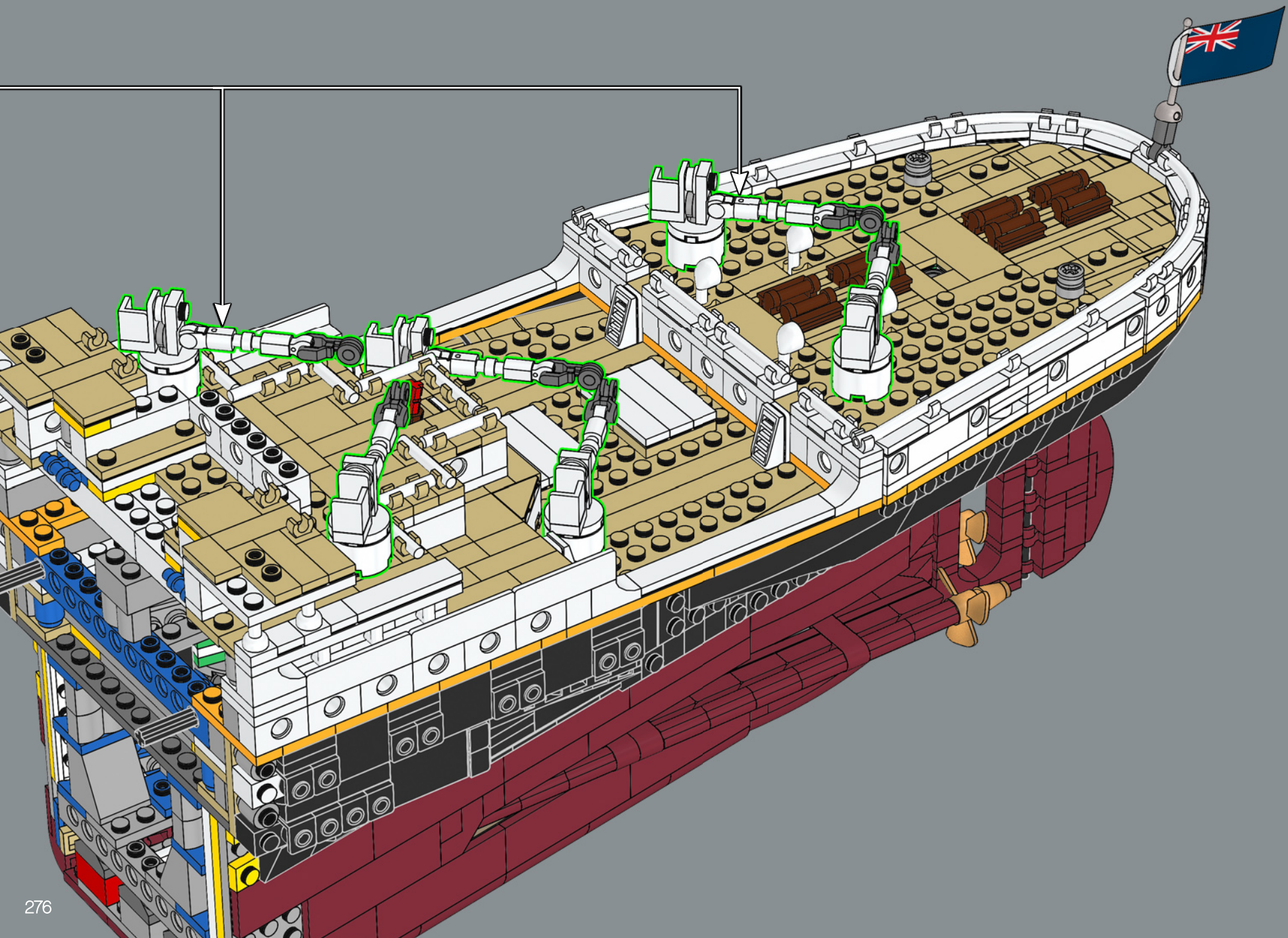

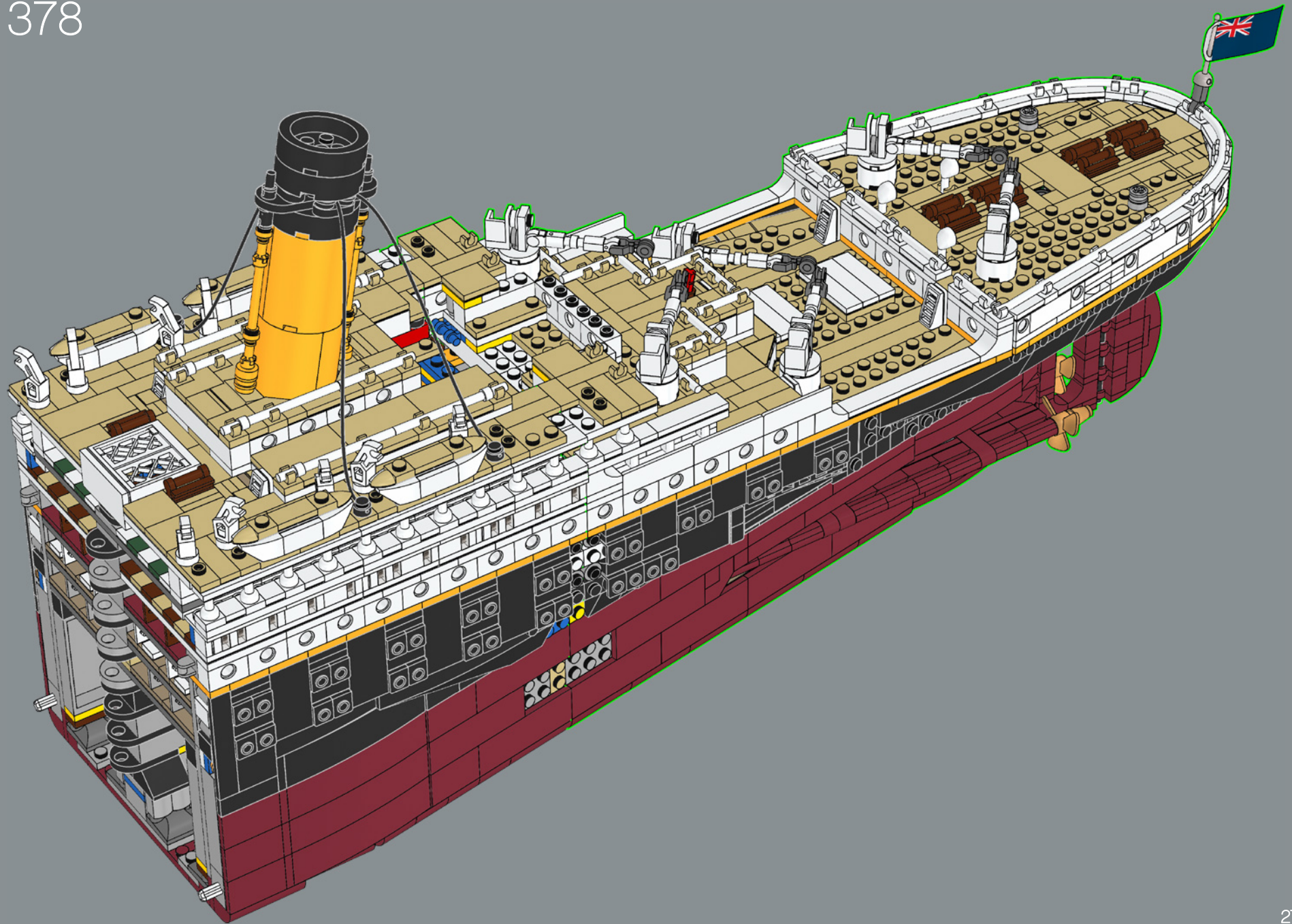

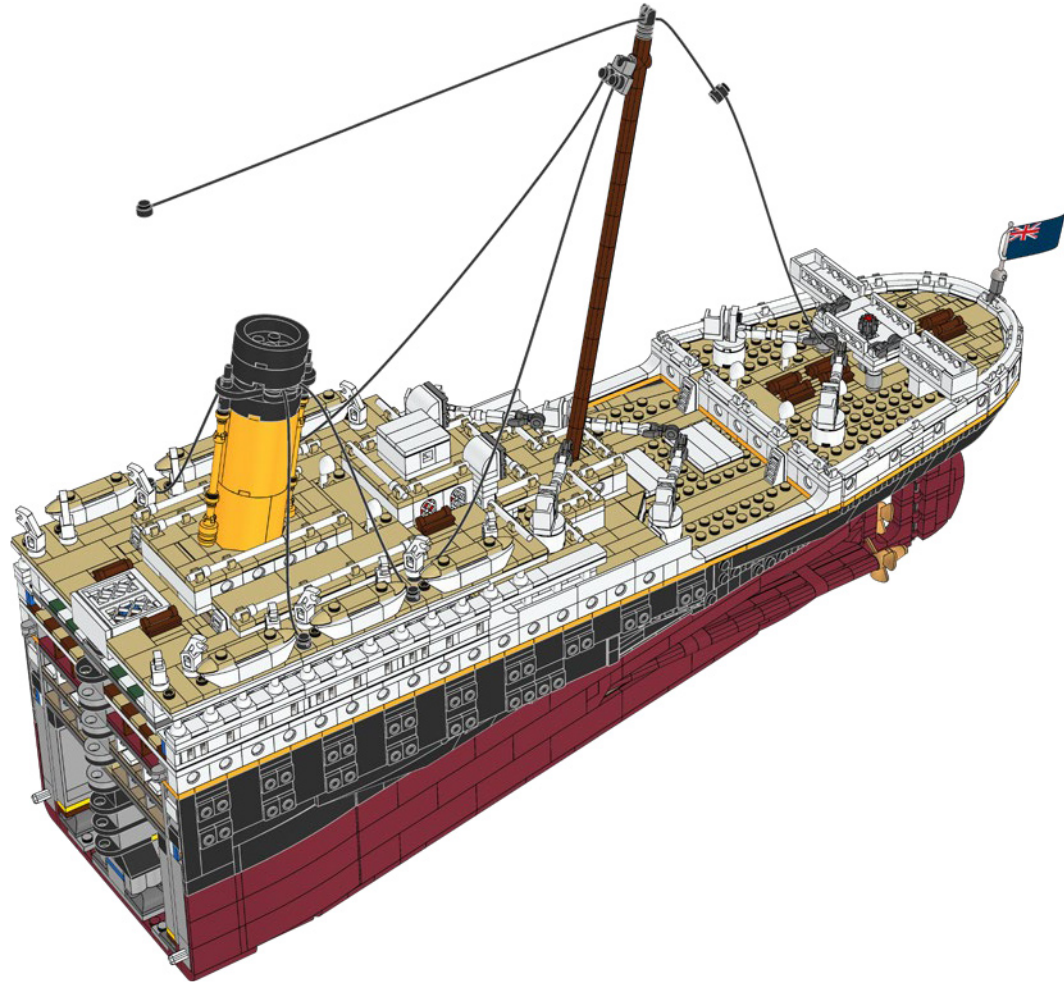
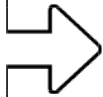

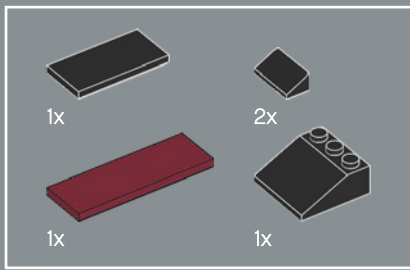

379

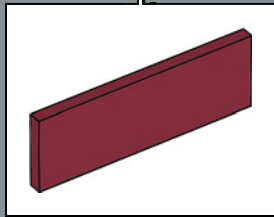
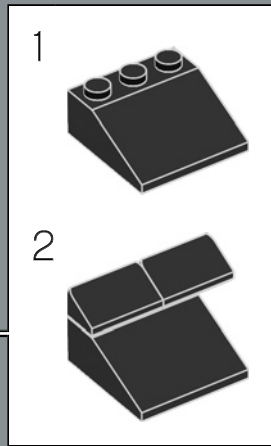
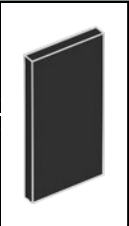
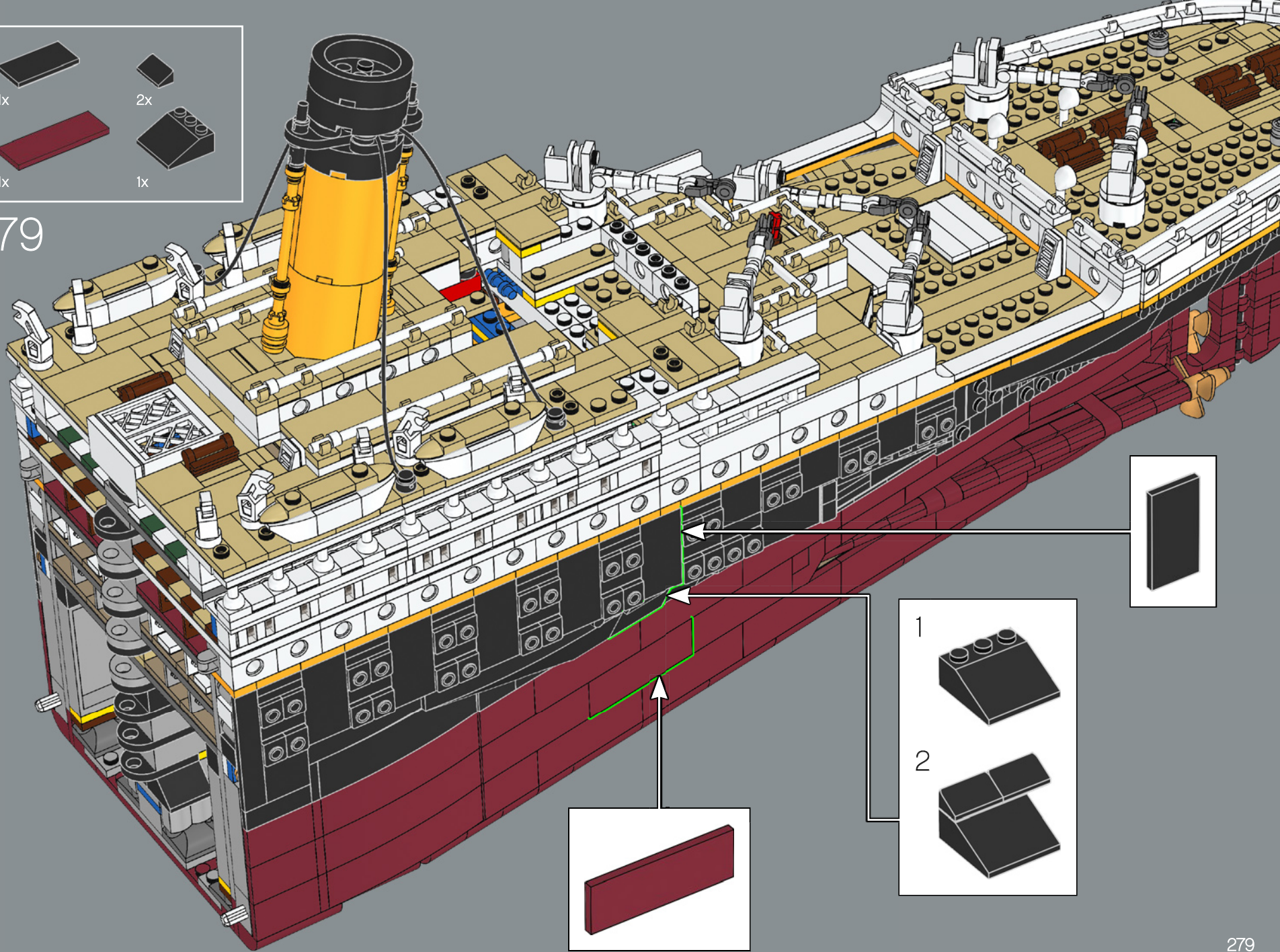

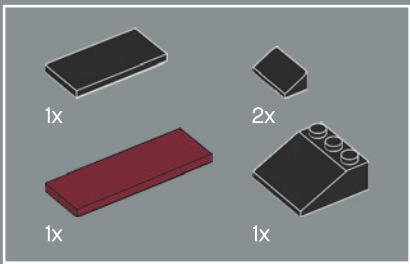

380

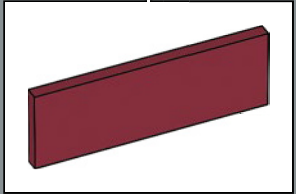
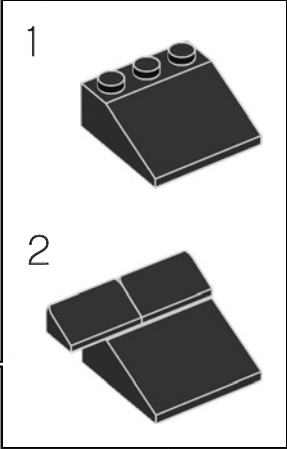
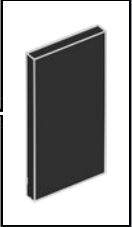
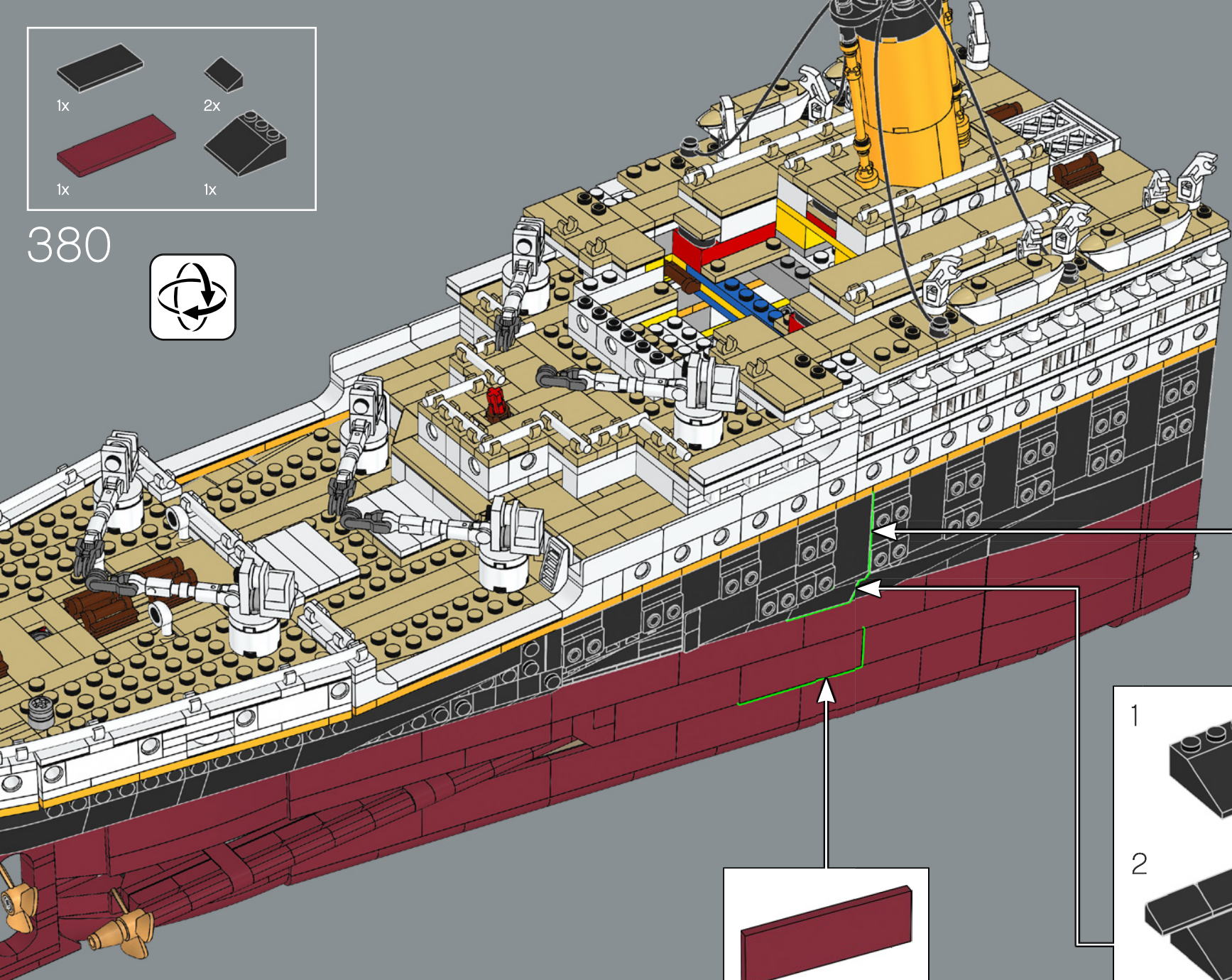



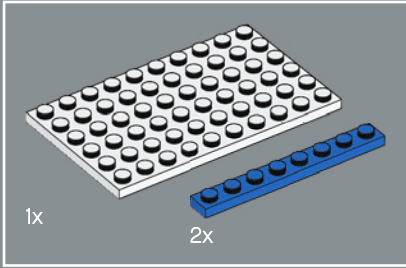
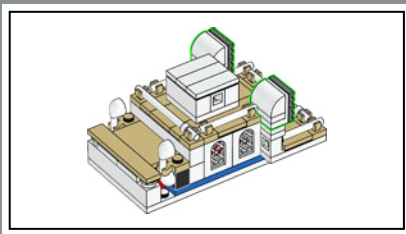

381

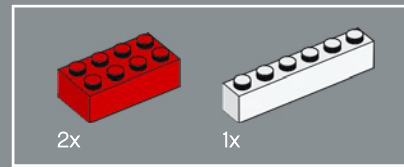
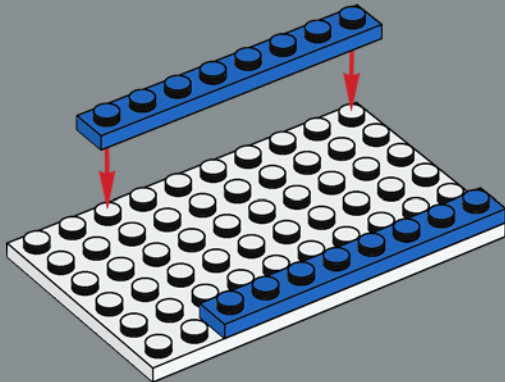

382

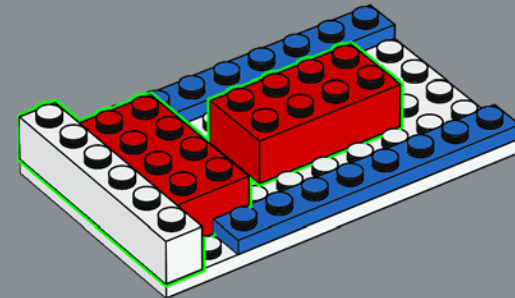

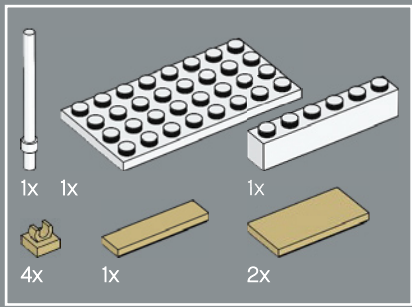

383

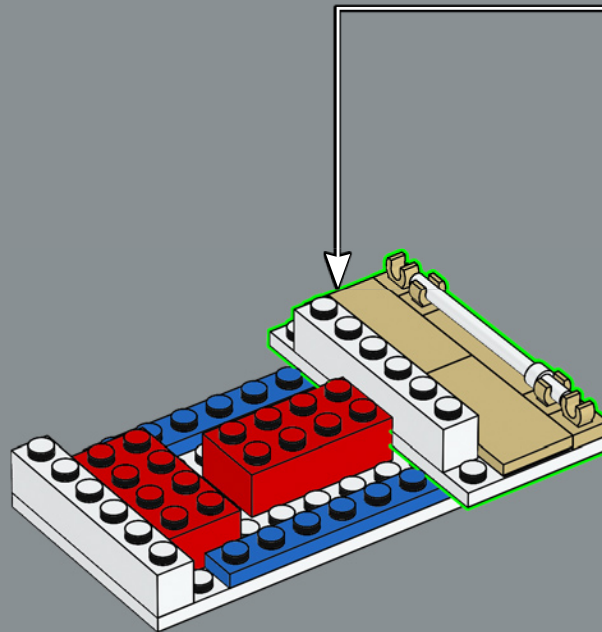
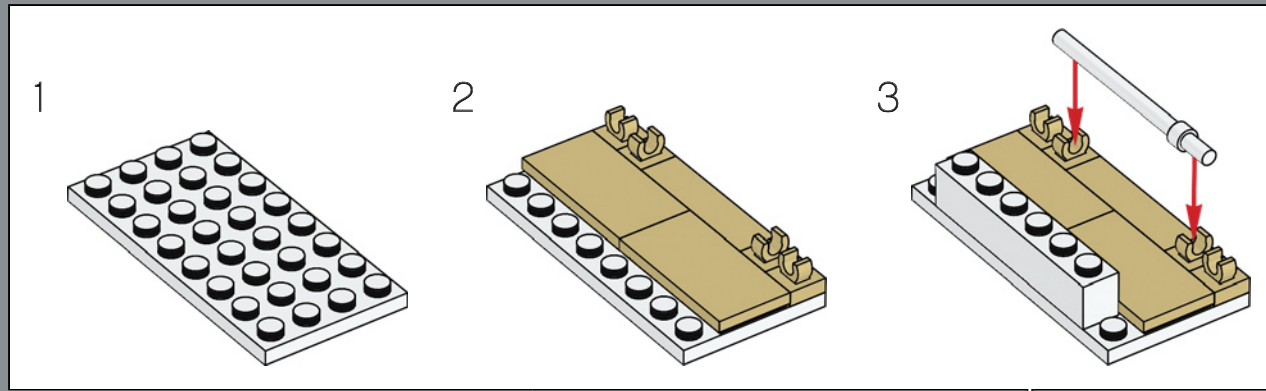

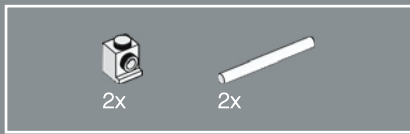

384

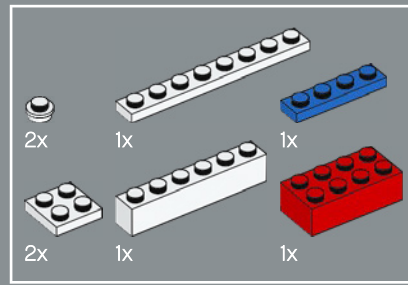
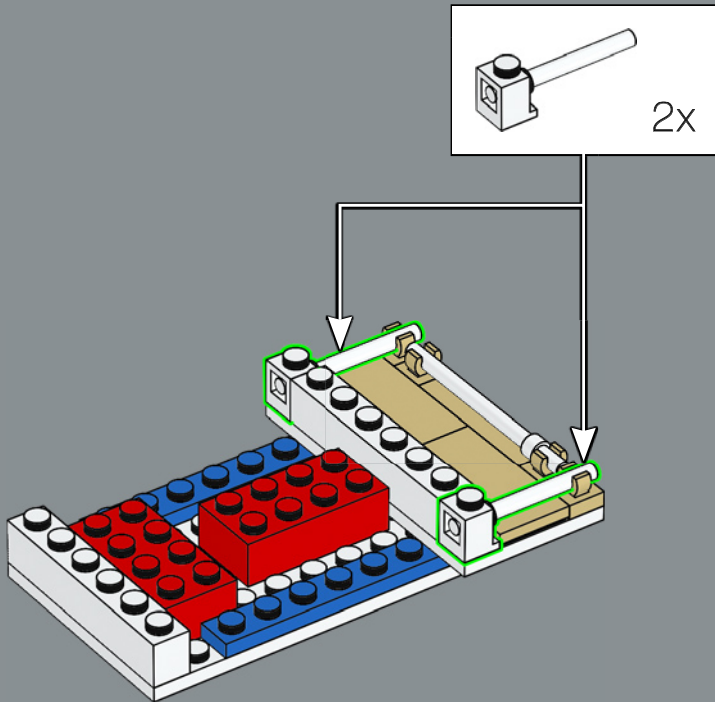

385

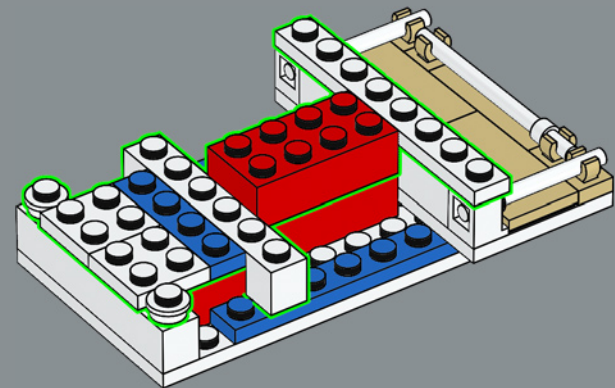

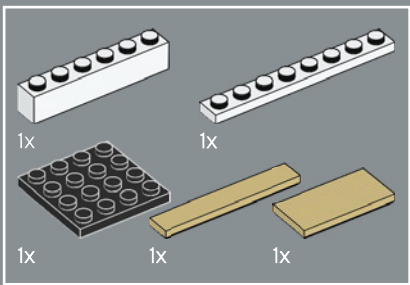

386

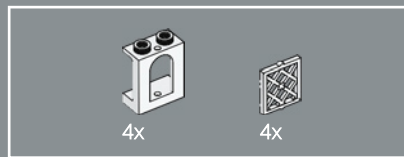
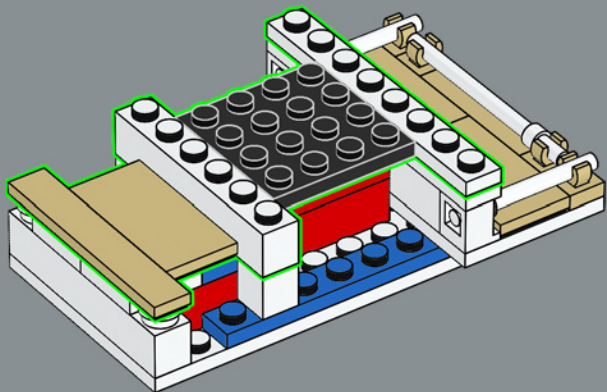

387

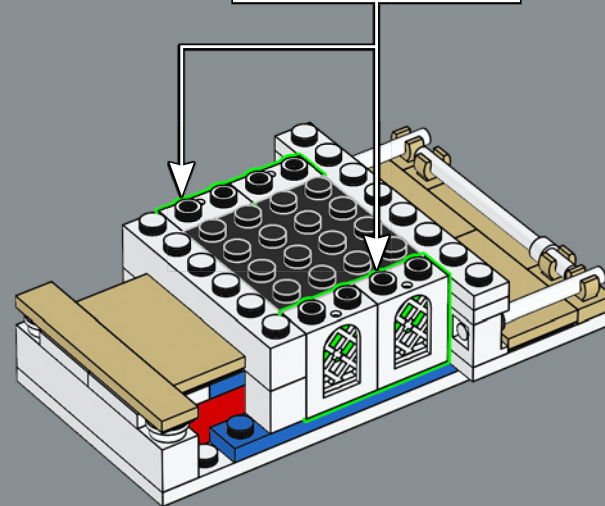
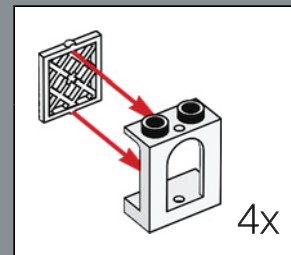

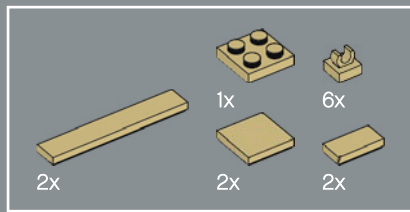

388

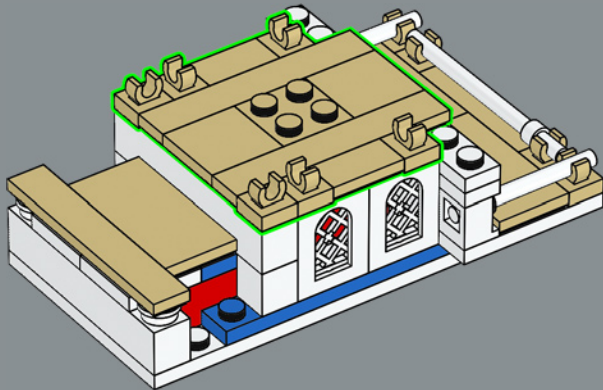

389

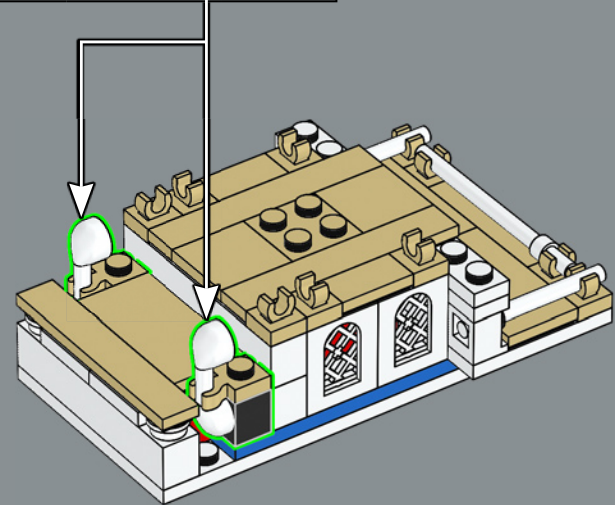
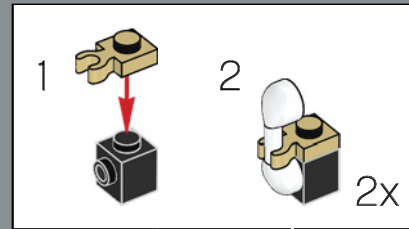

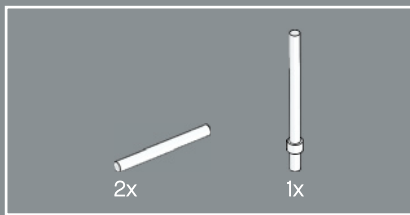

390

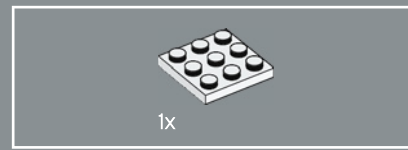
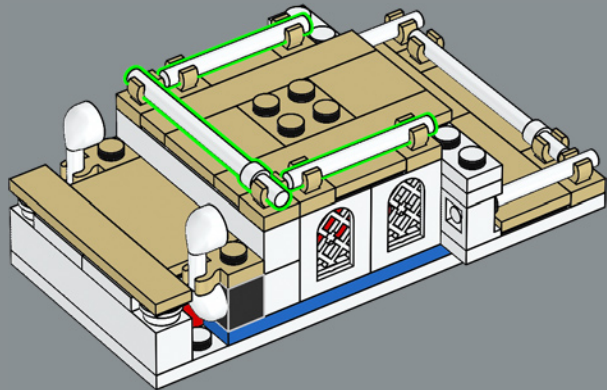

391

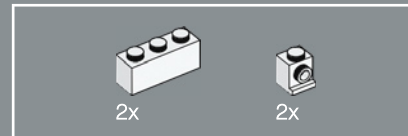
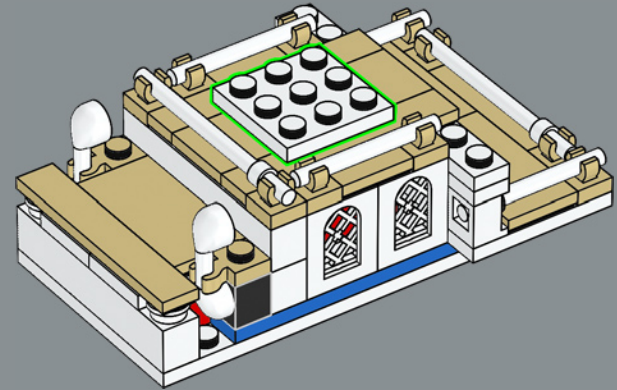

392

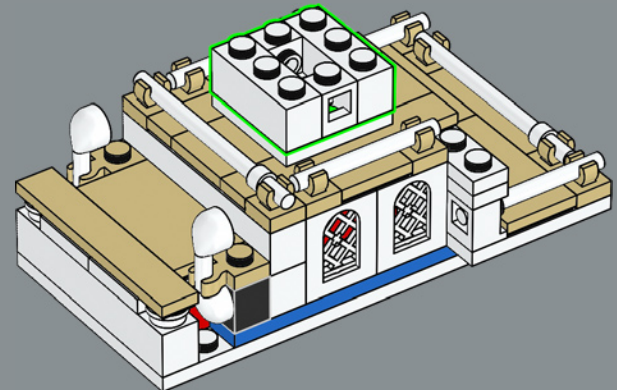

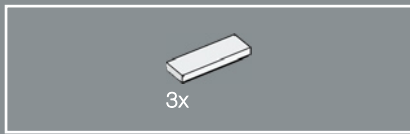

393

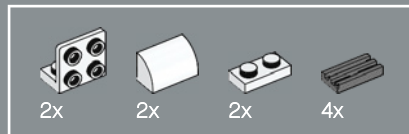
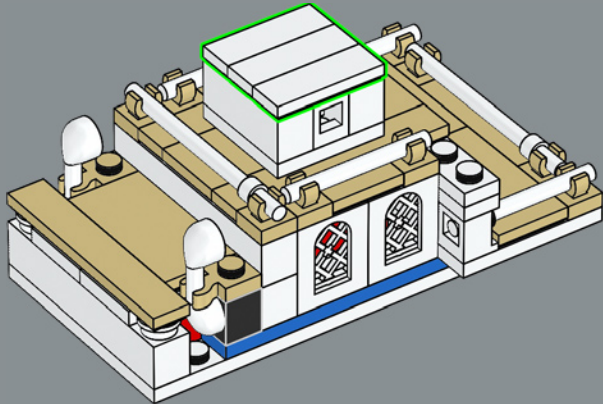

394

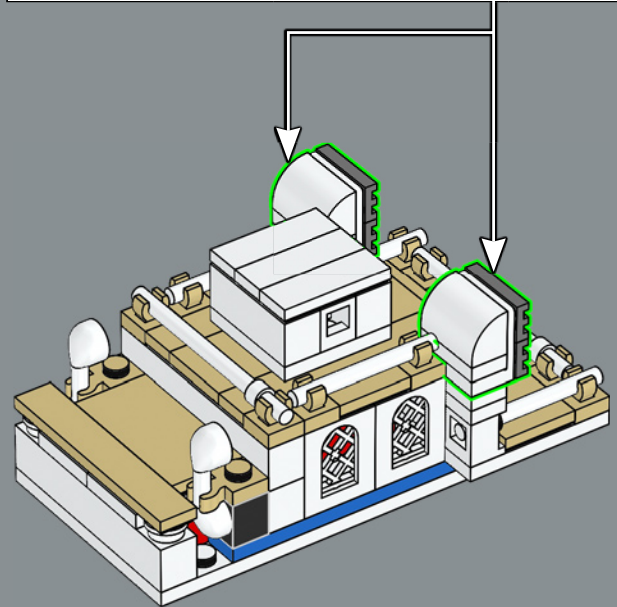
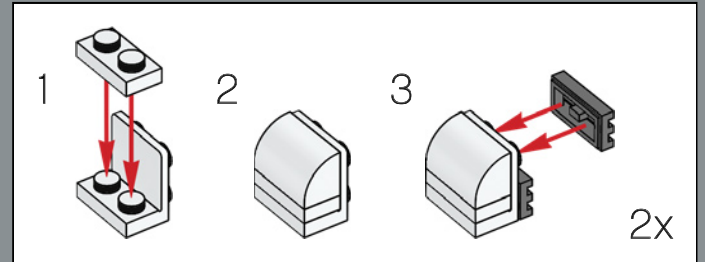

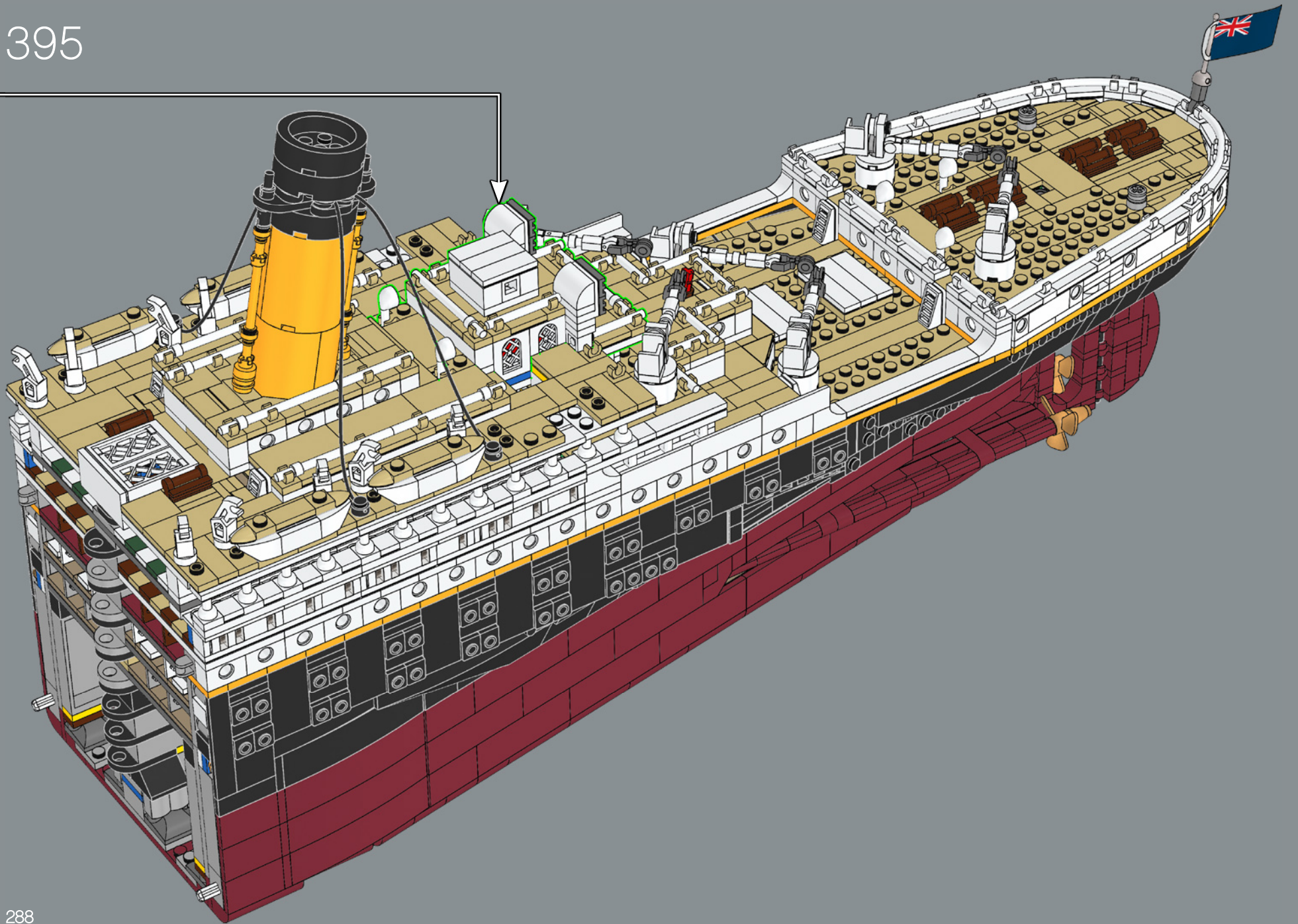



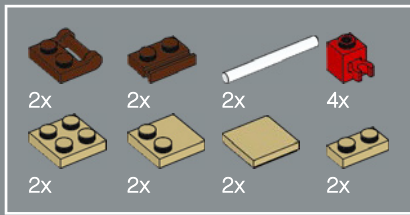

396

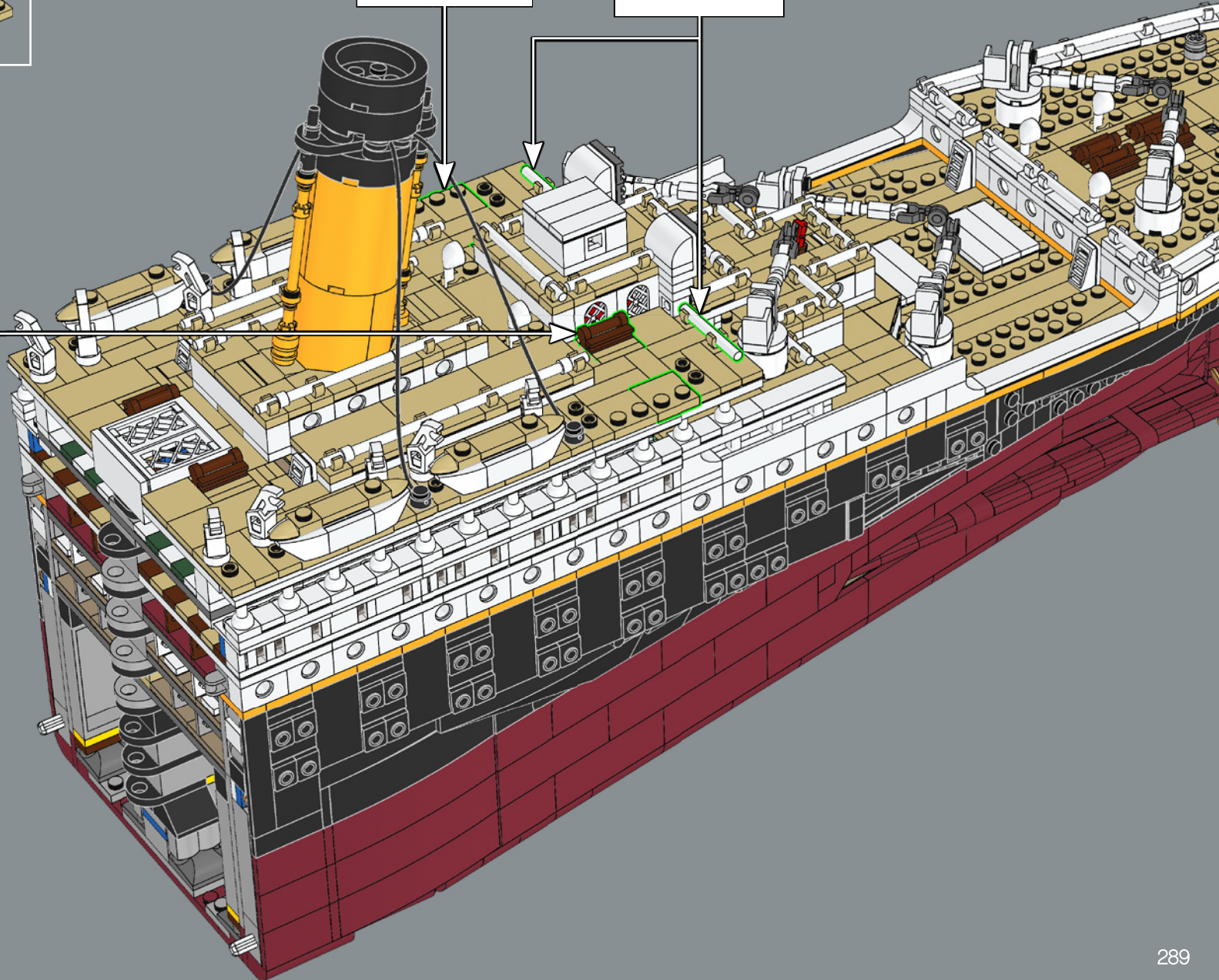
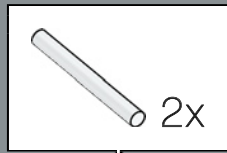
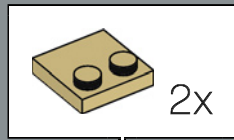
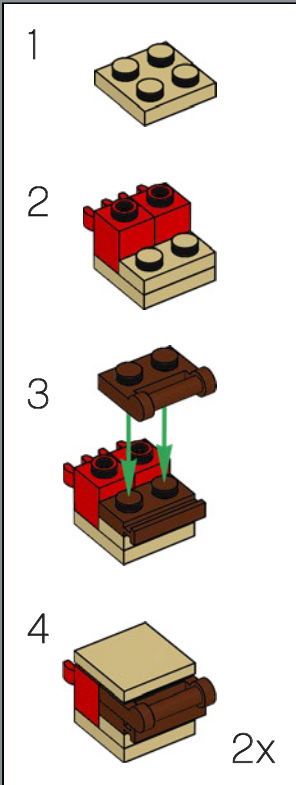

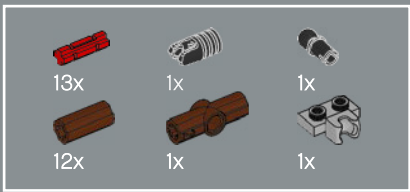

397

1

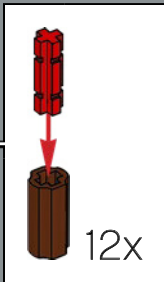
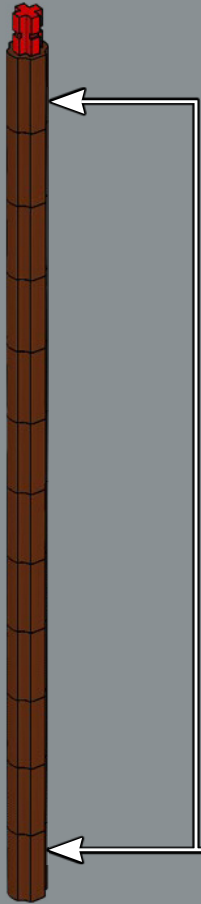

2



3

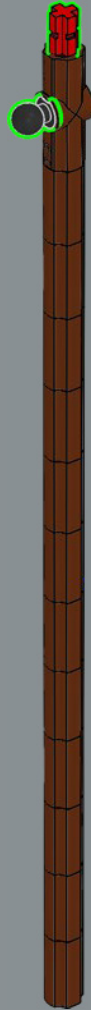

4

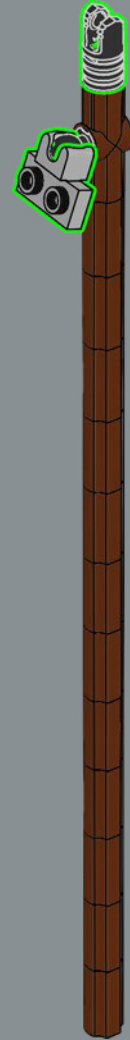

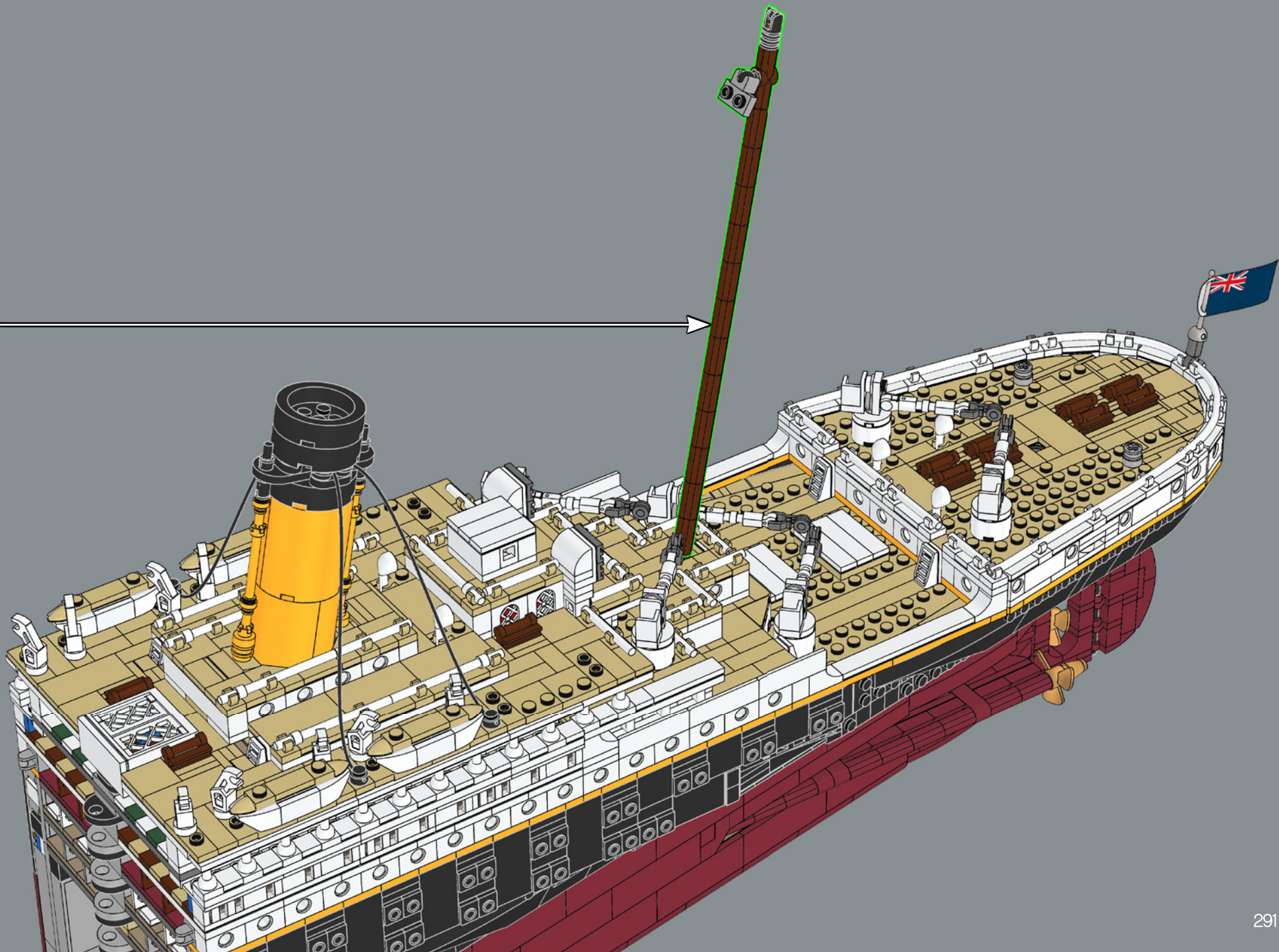

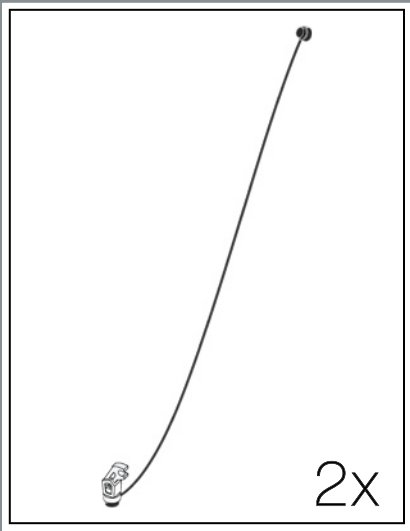

398

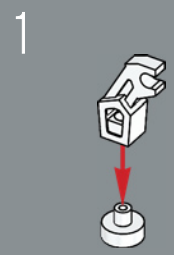



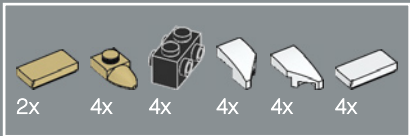

399

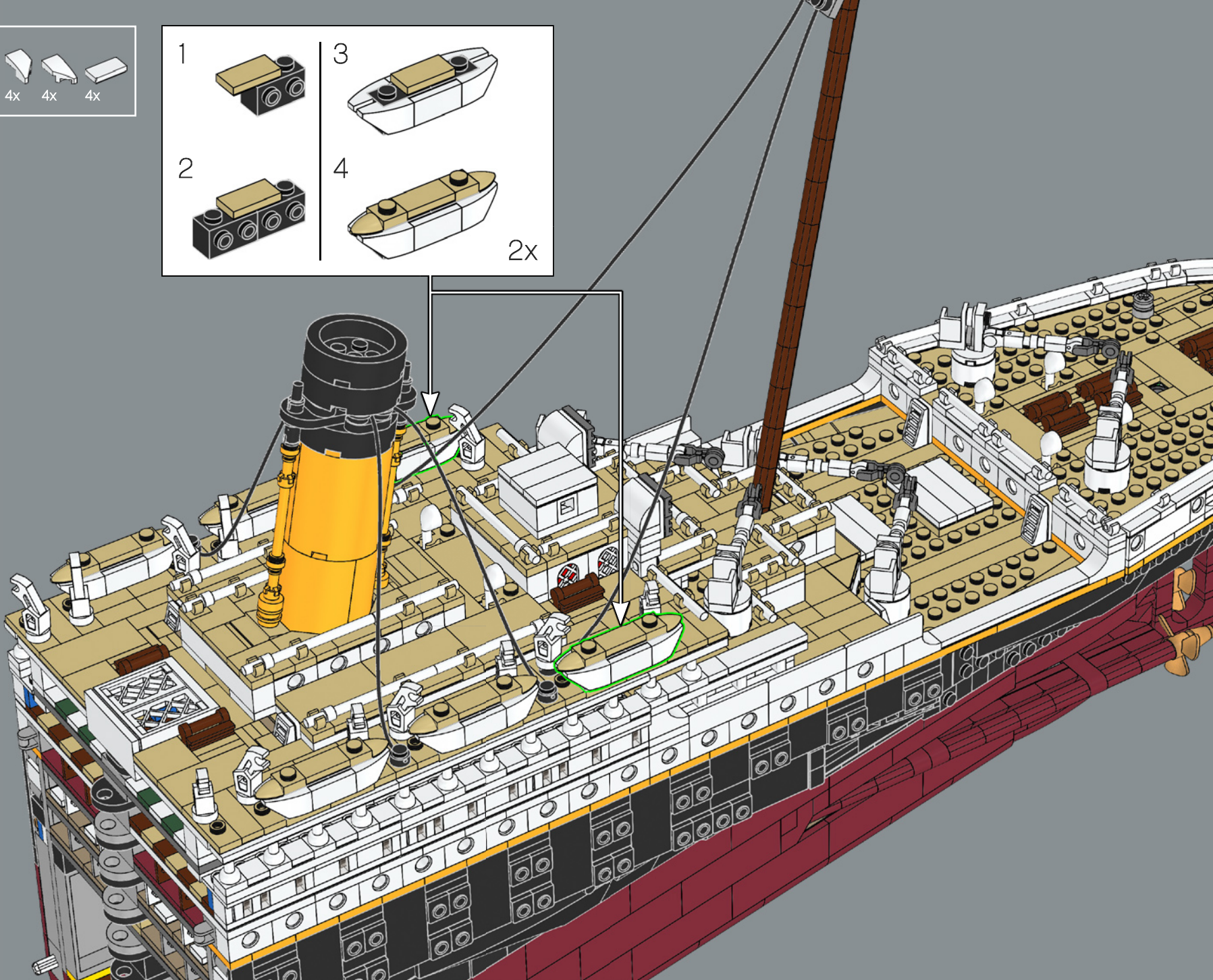
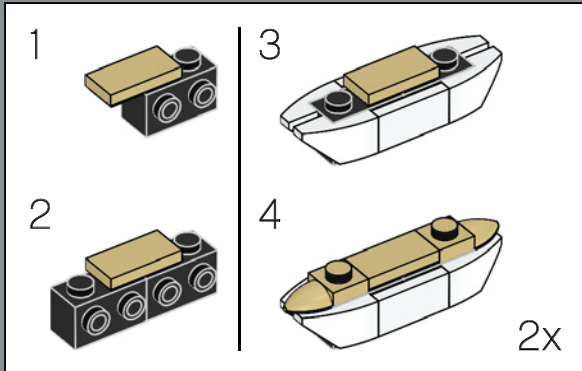



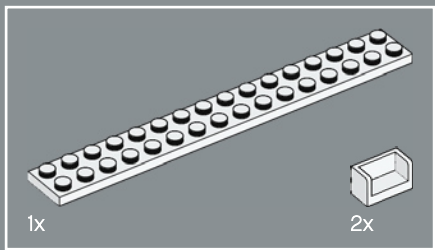

401

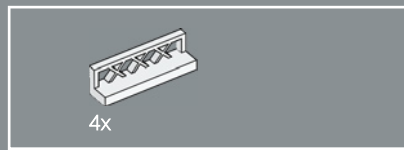
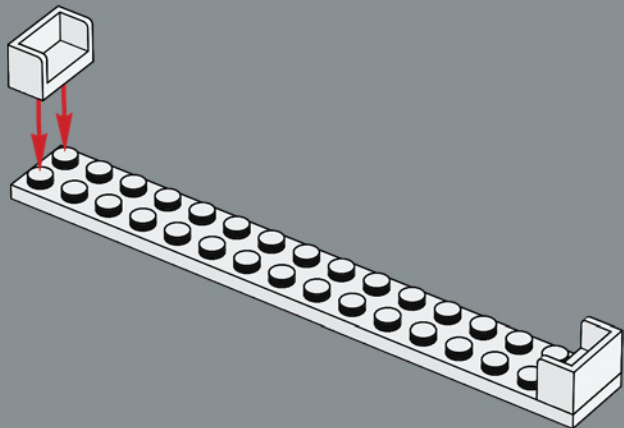

402

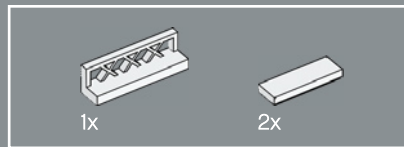
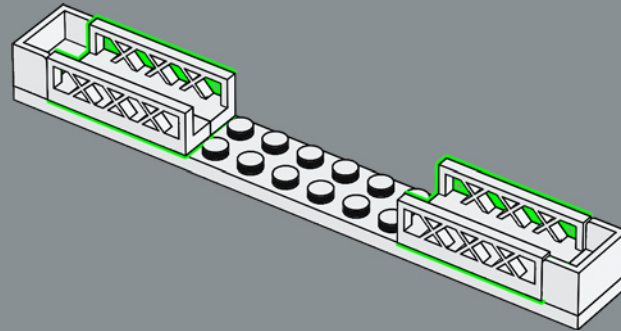

403

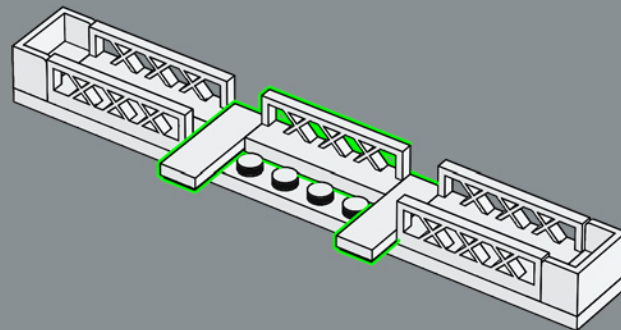





404

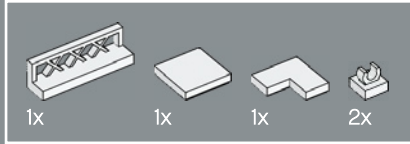
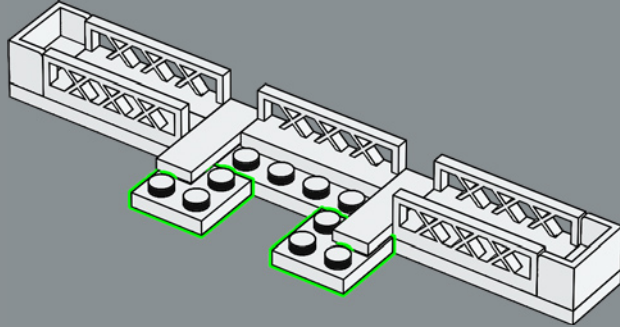

405

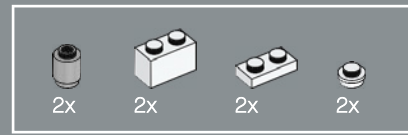
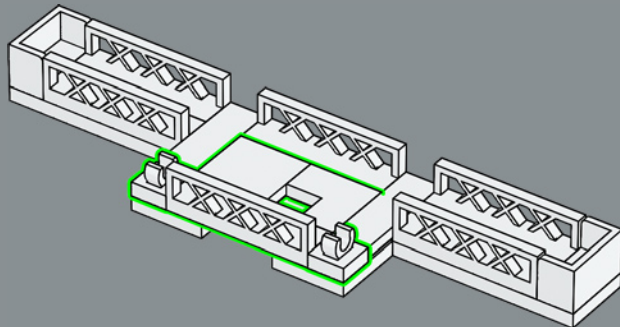

406

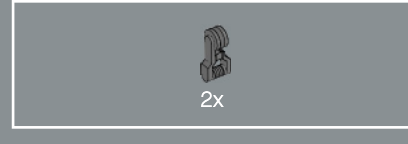
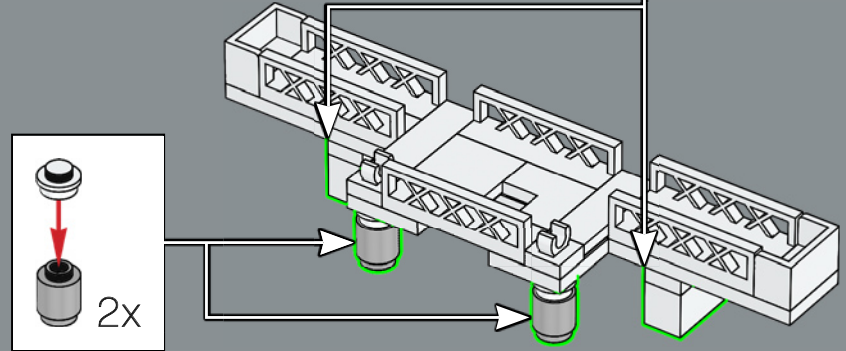

407

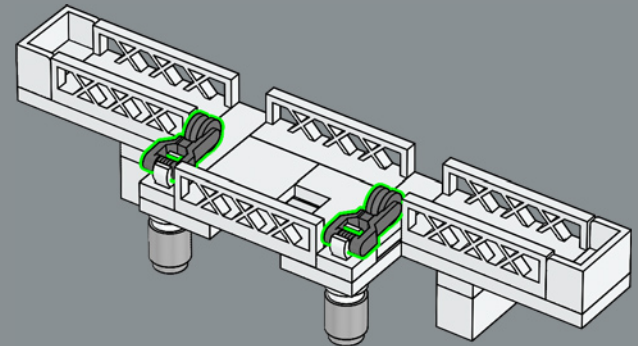



1x

408

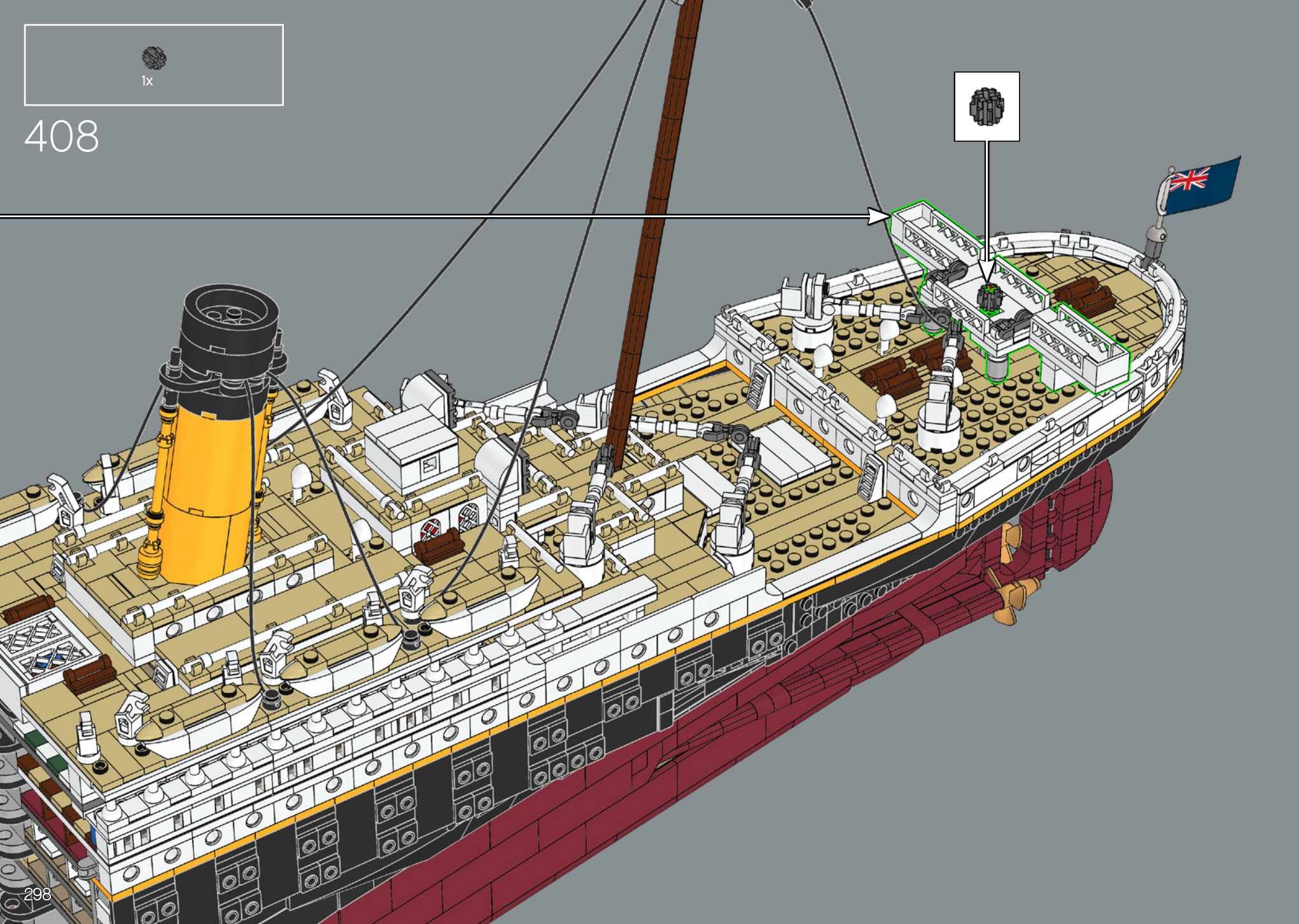

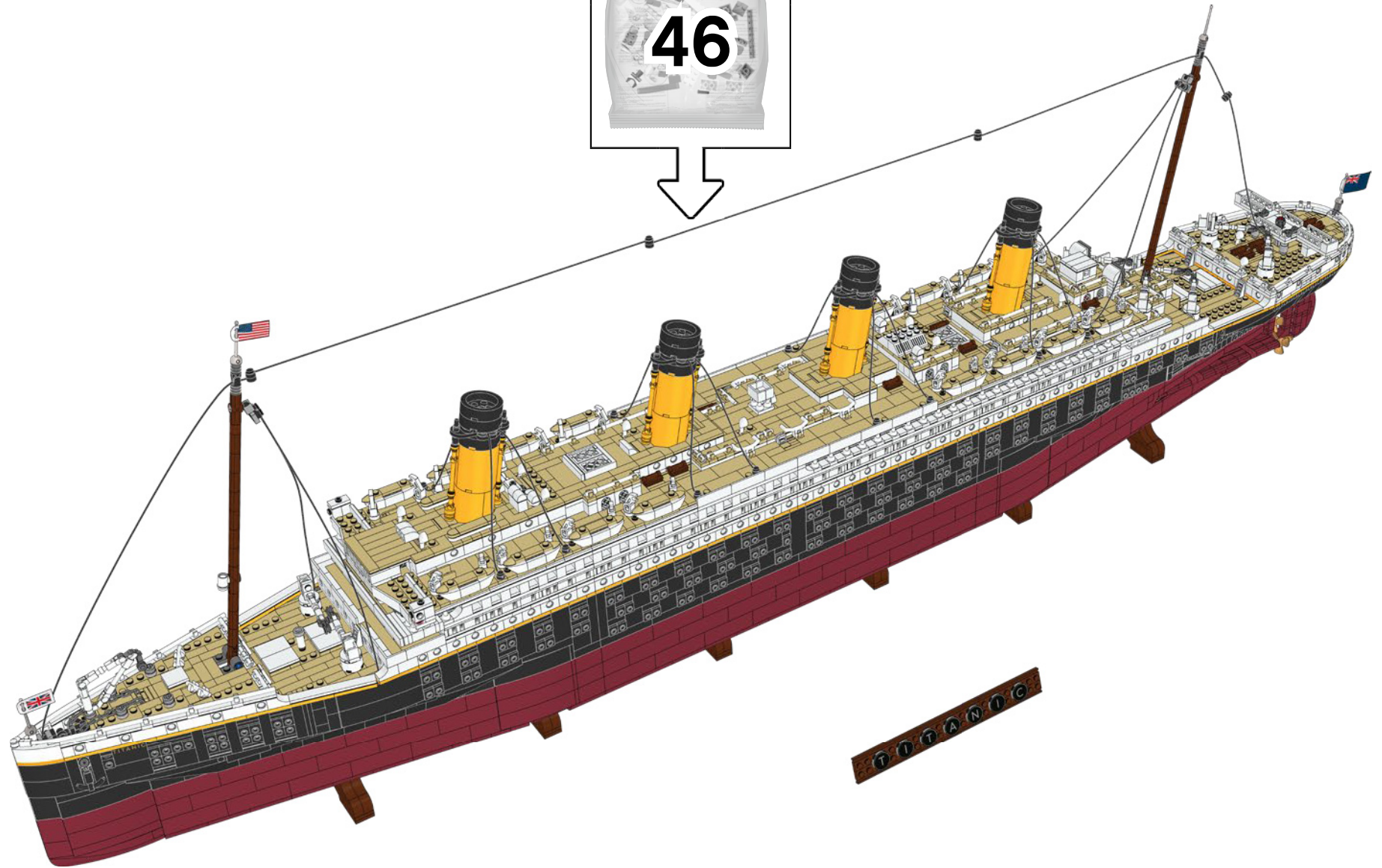

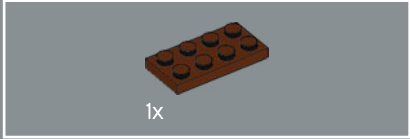
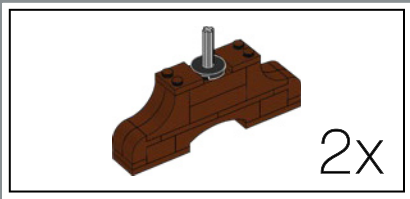

409

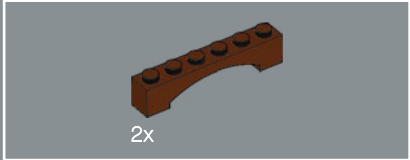
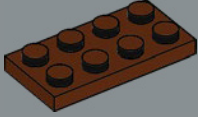

410

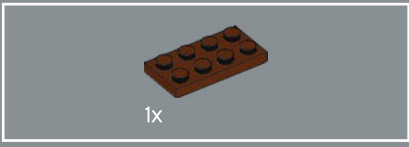
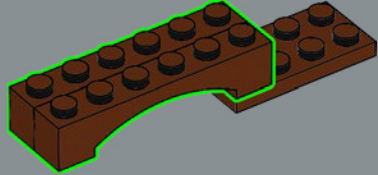

411

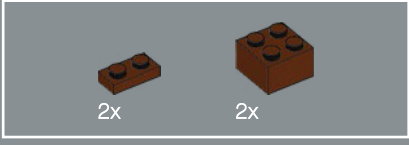
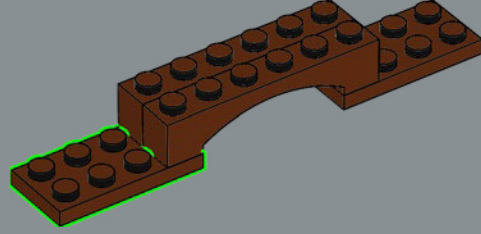

412

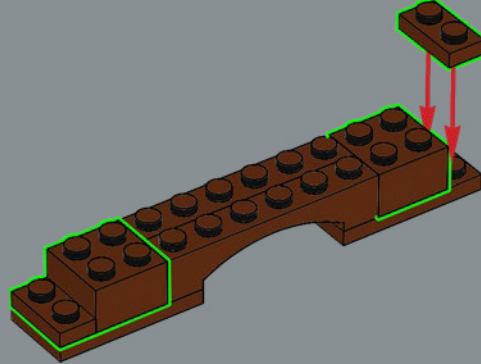

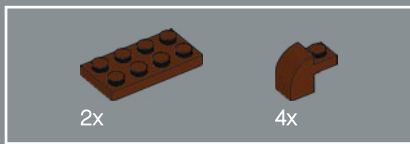

413

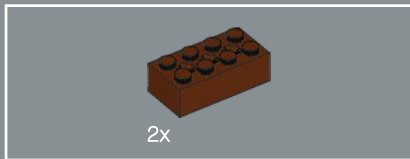
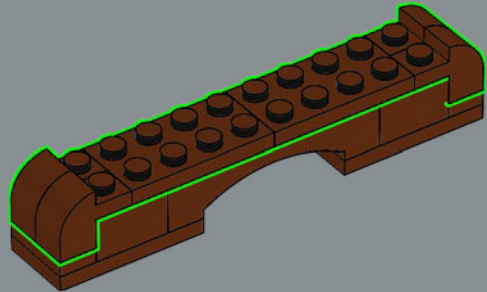

414

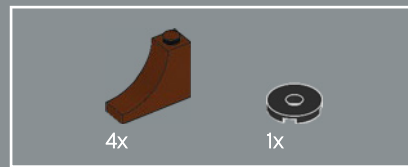
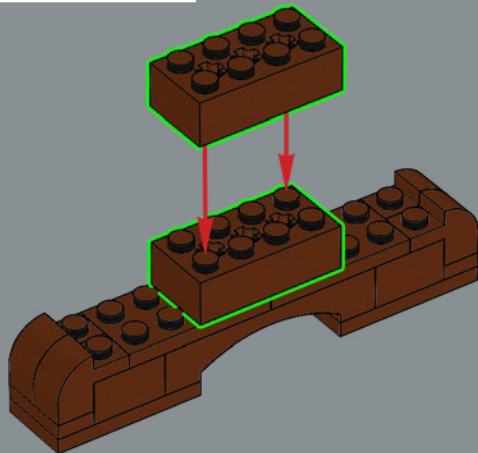

415

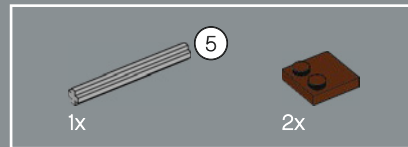
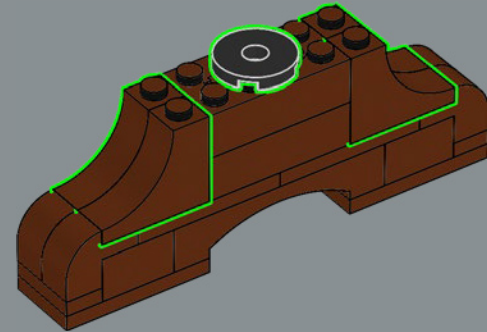

416

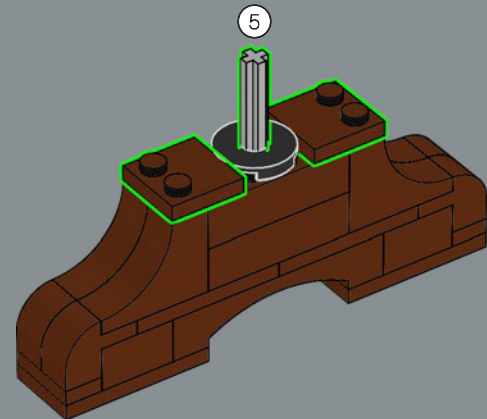

2x



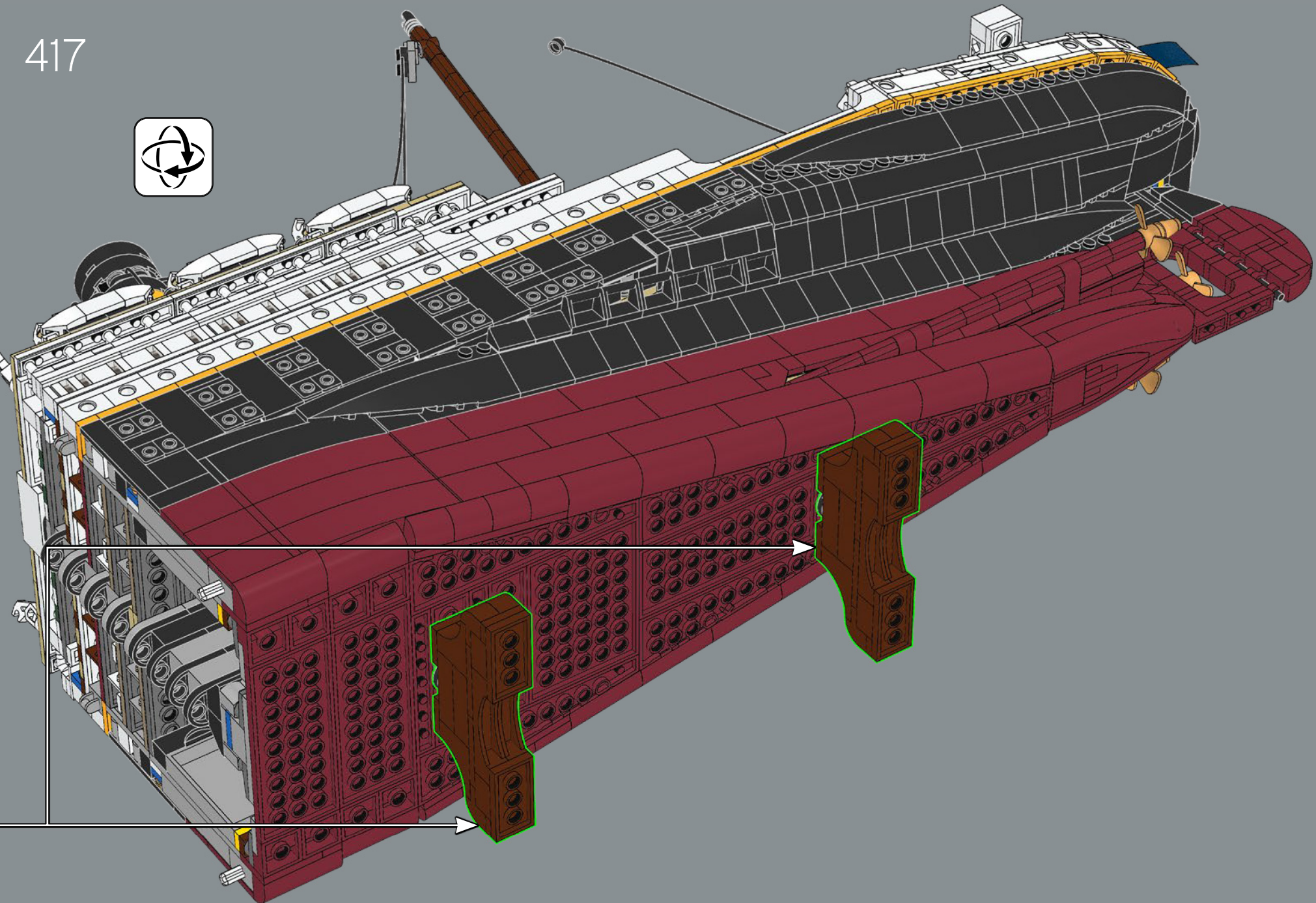

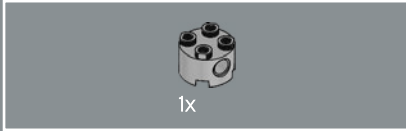
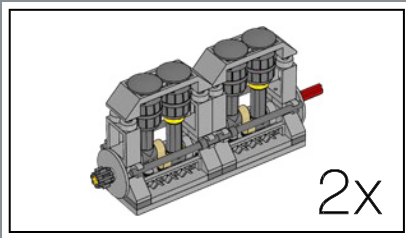

418

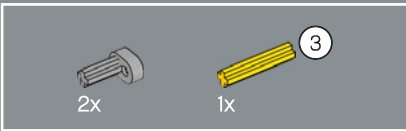
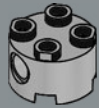

419

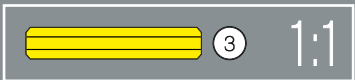
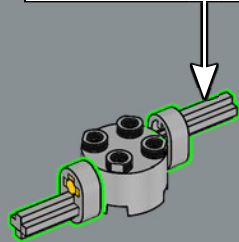
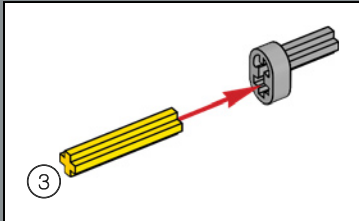

420

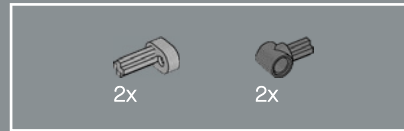
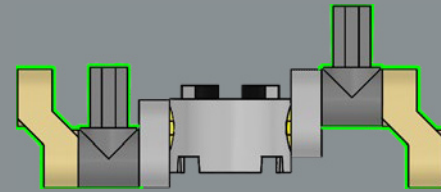

421

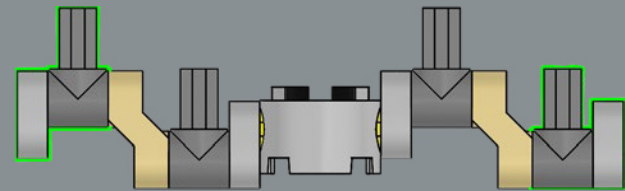

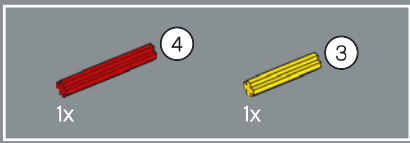

422

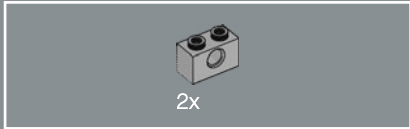
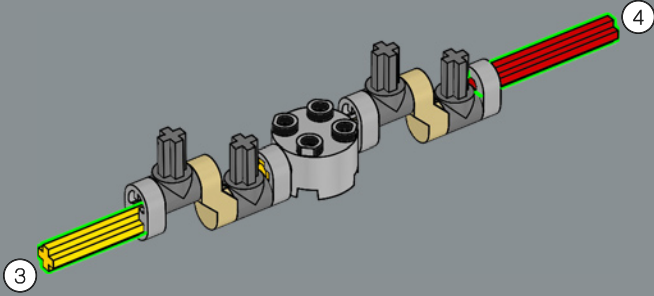

423

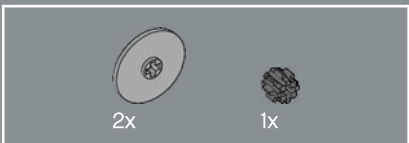
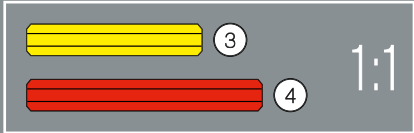
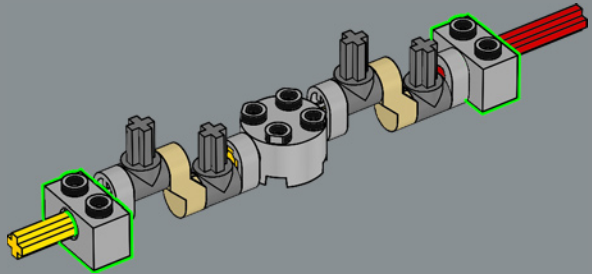

424

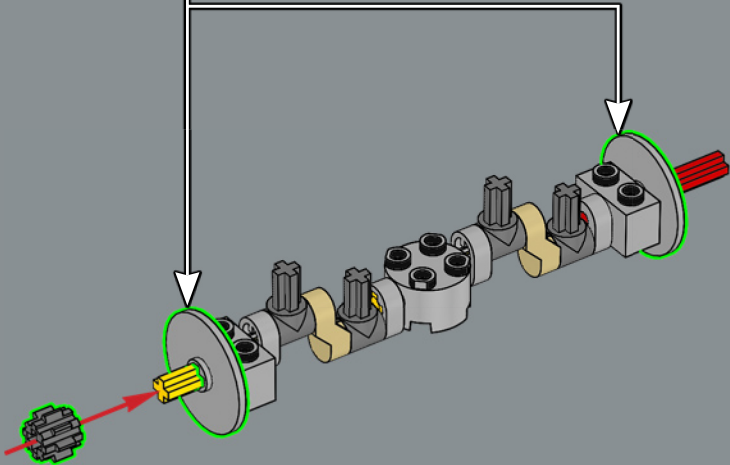
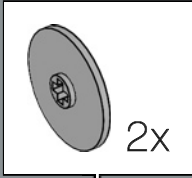



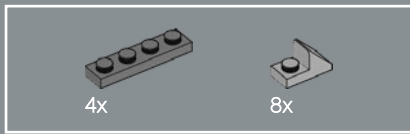

425

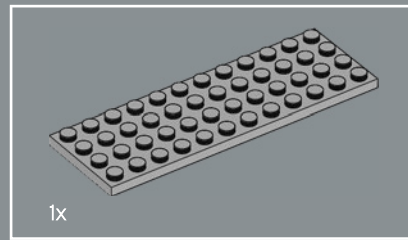
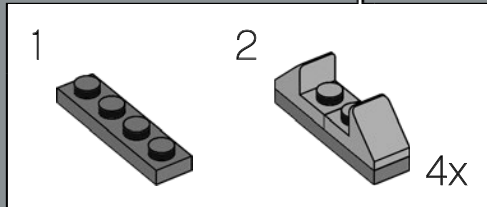
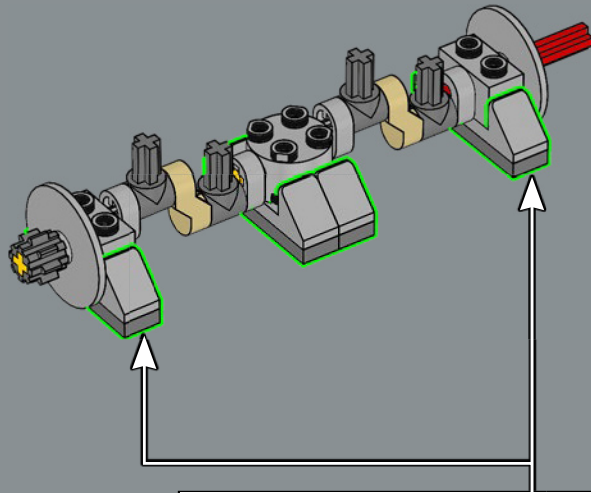

426

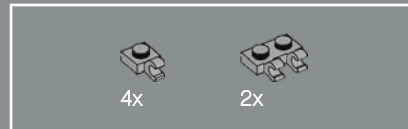
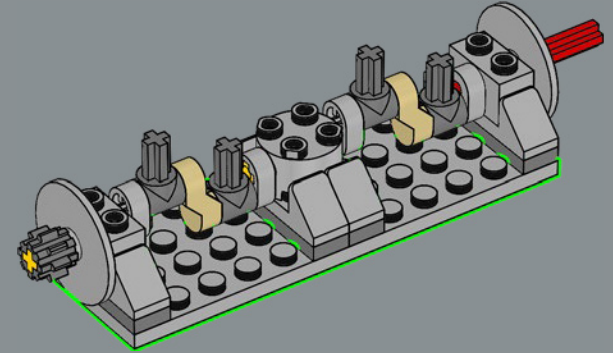

427

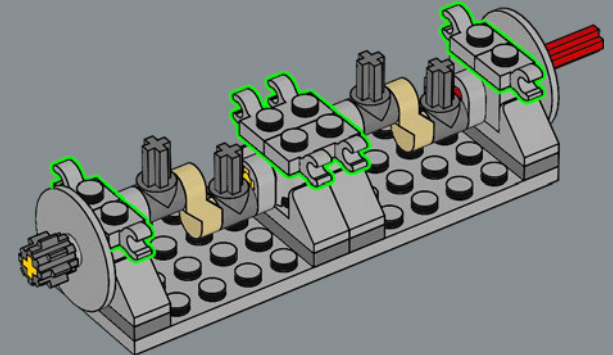



428

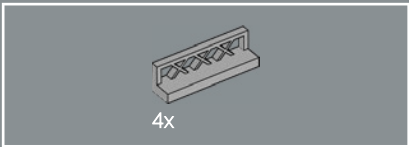
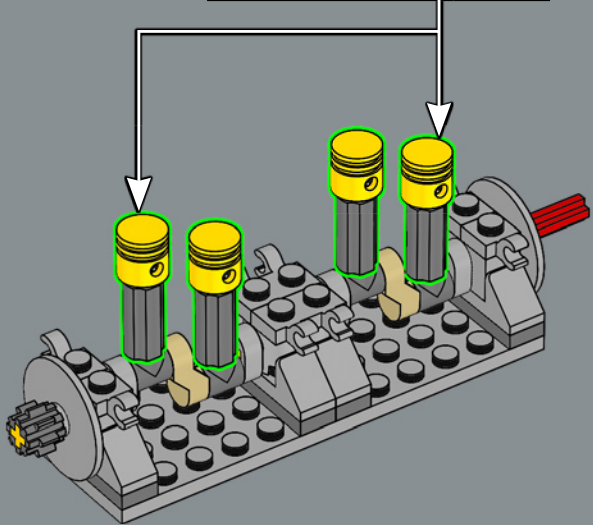
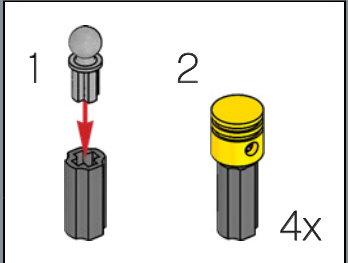

429

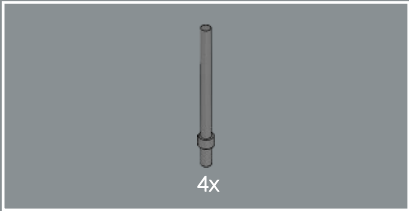
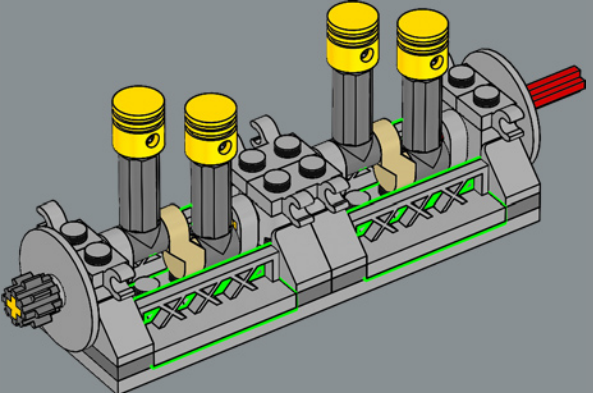

430

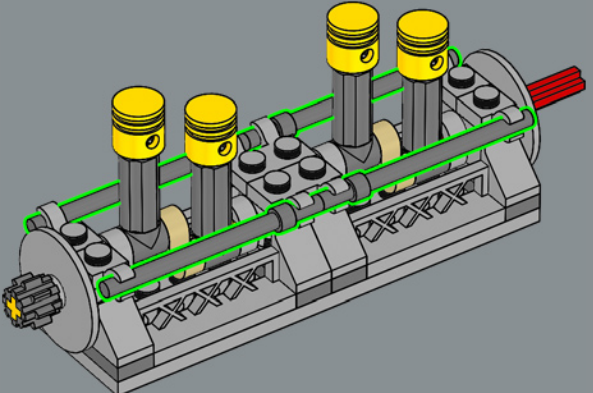

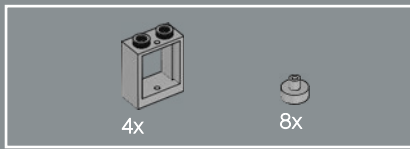

431

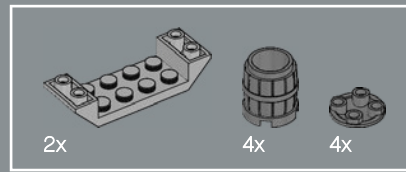
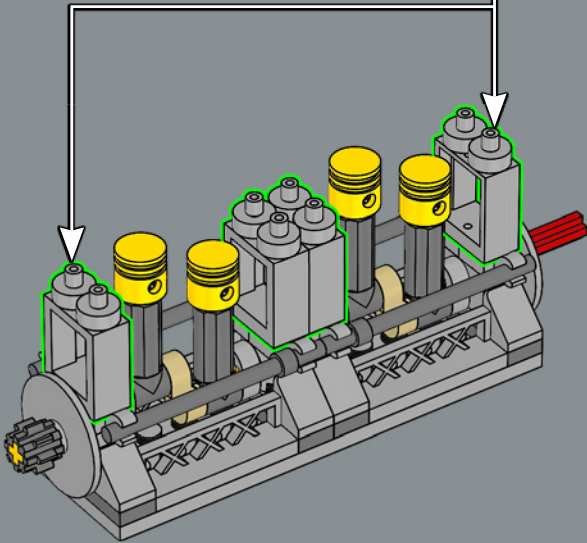
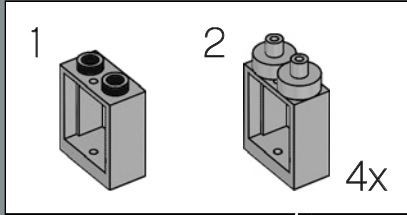

432

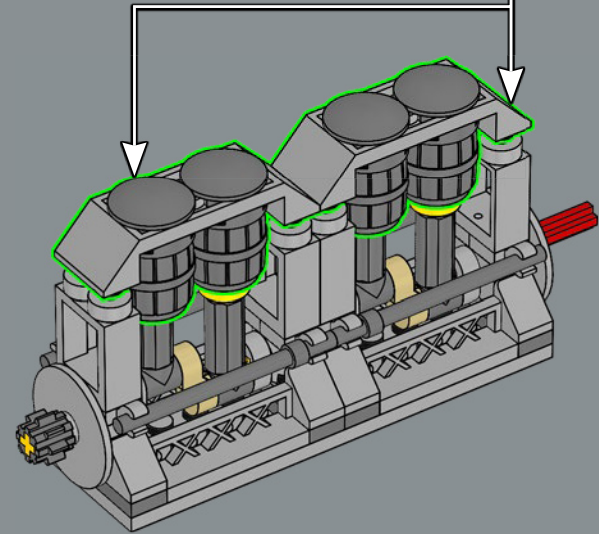
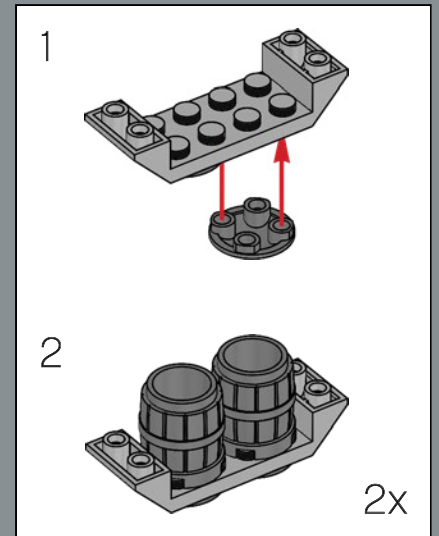

2x

433

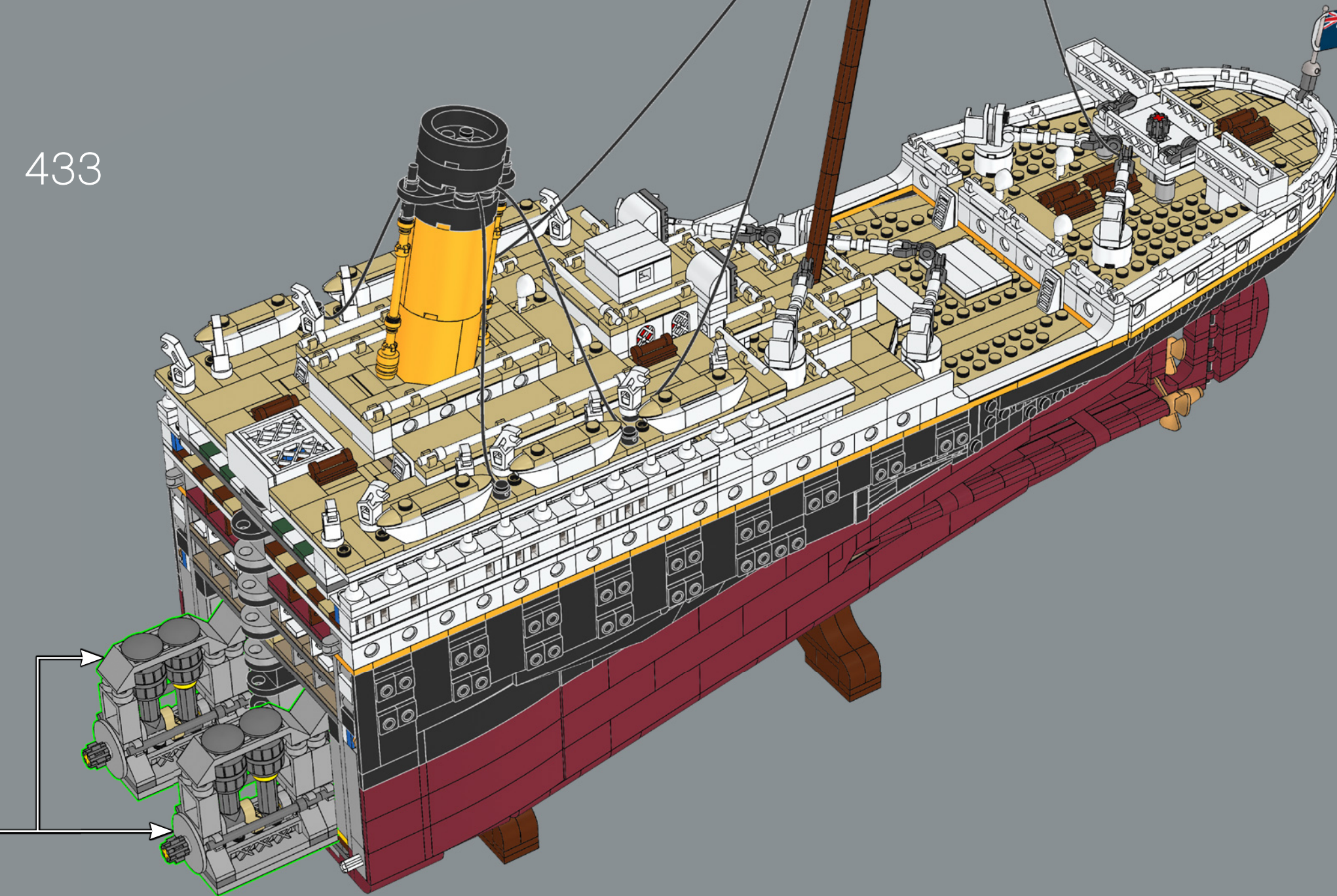

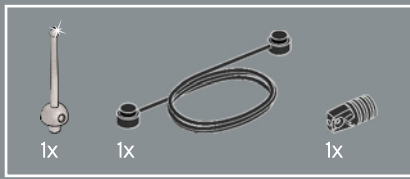

434

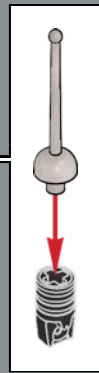
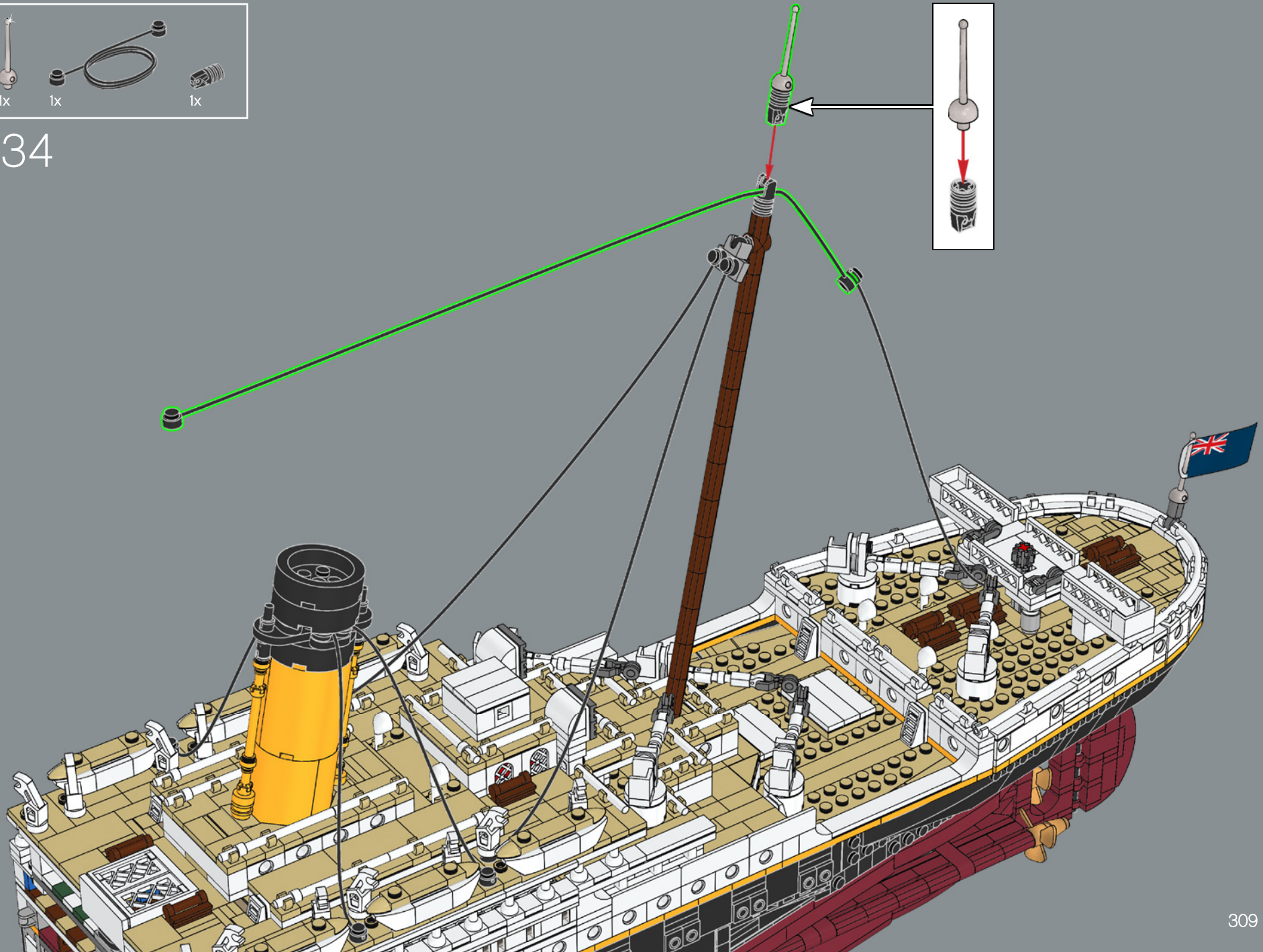

435

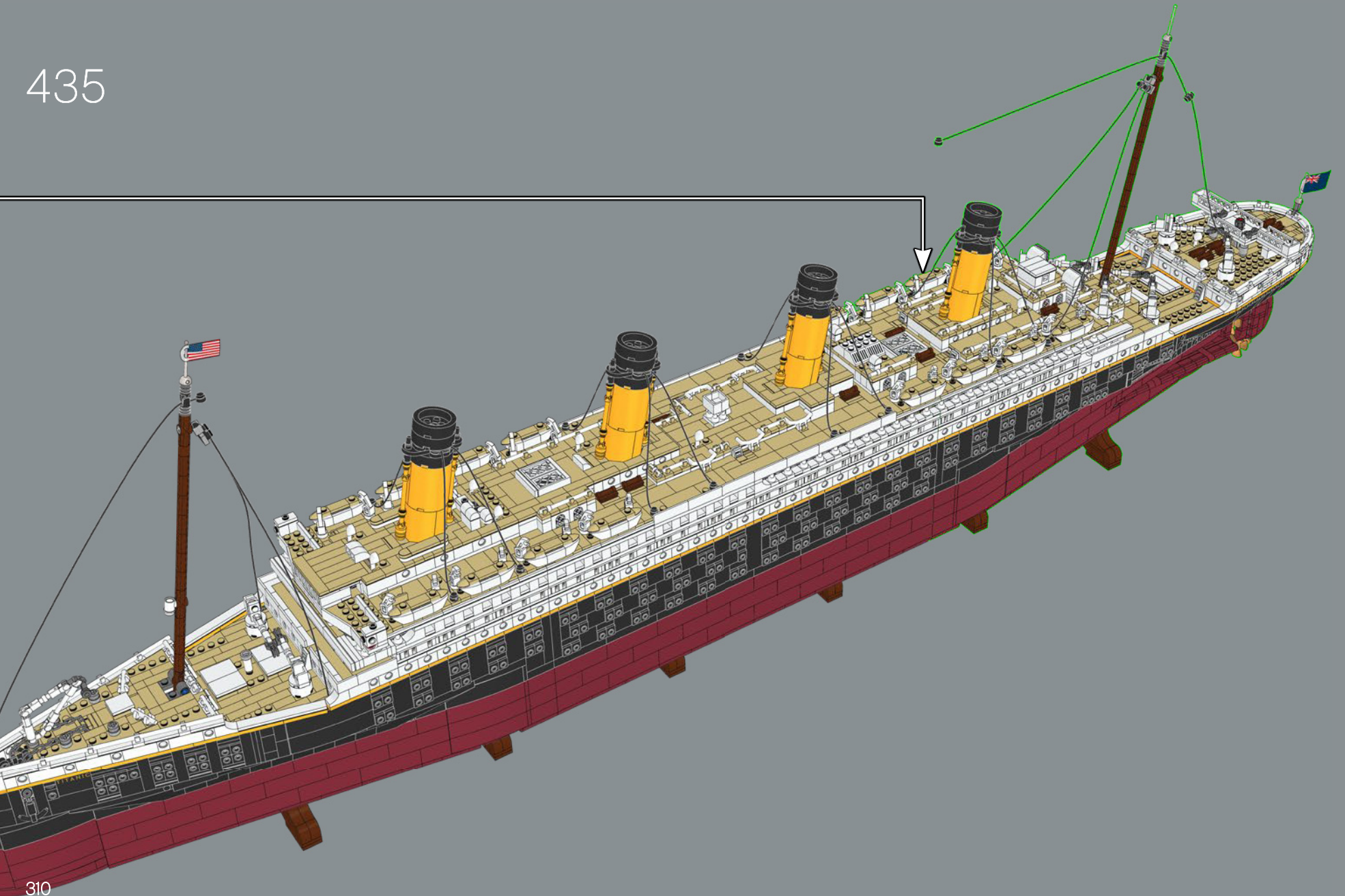

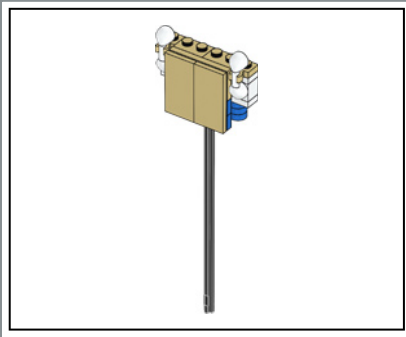

436

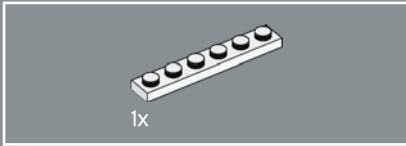
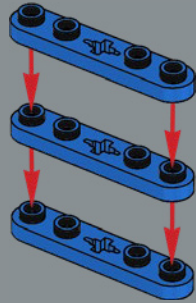

437

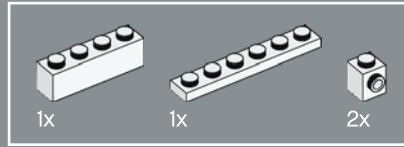
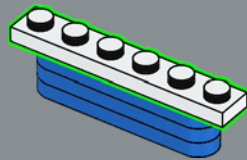

438

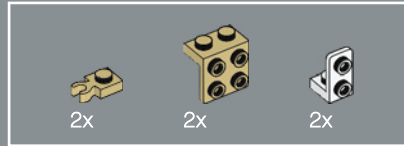
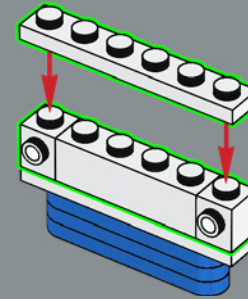

439

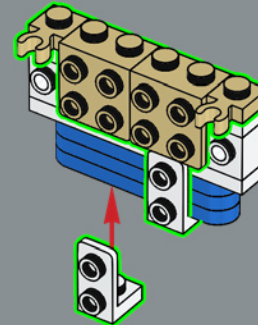

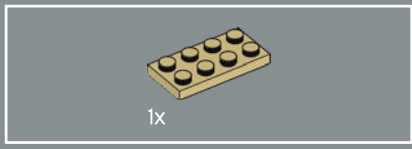

440

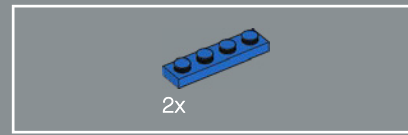
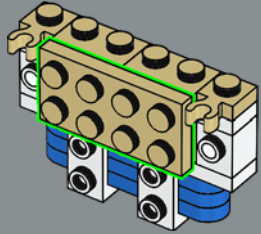

441

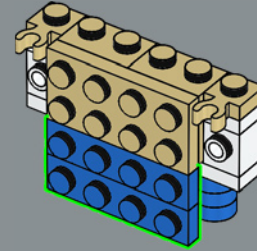



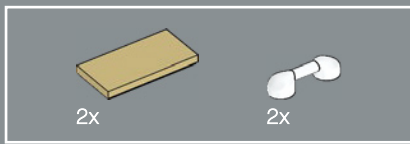

442

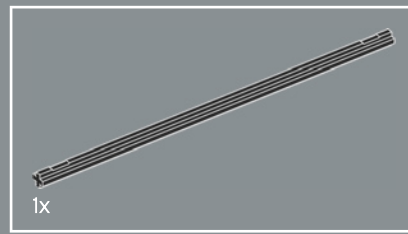
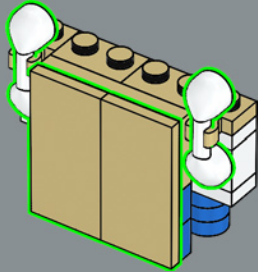

443

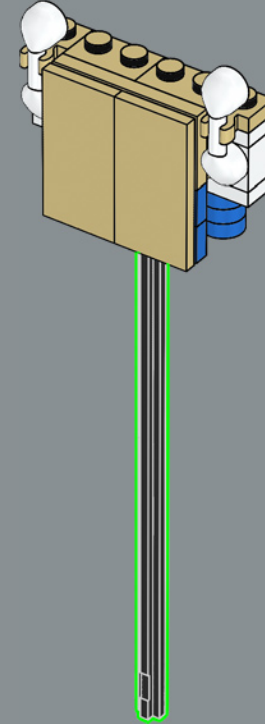

L'année 2021 marque le 110<sup>e</sup> anniversaire du lancement du Titanic, le 31 mai 1911.

444

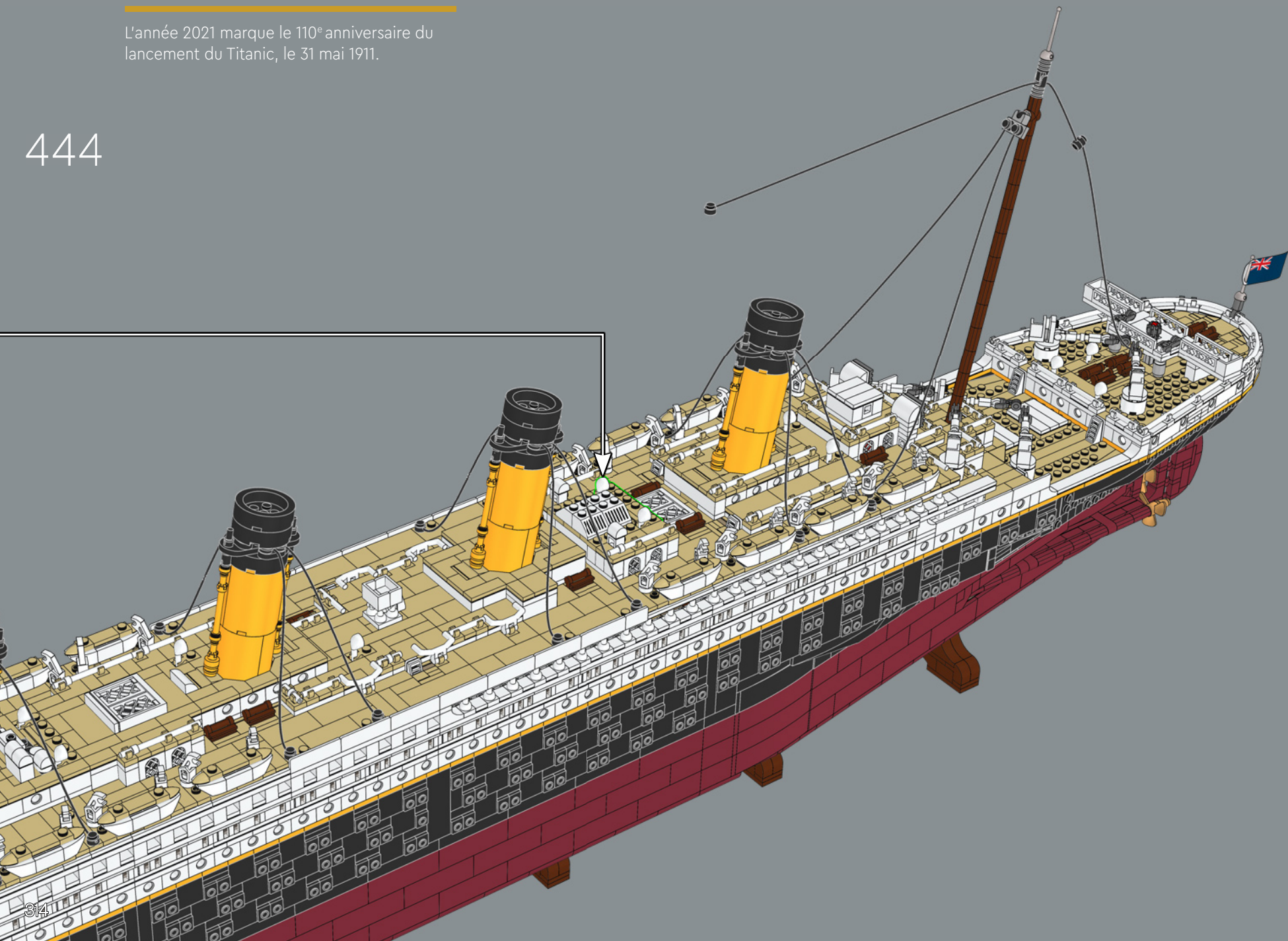

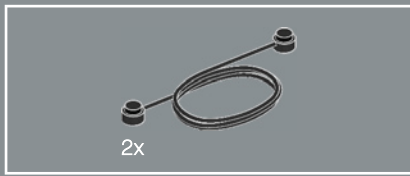

445

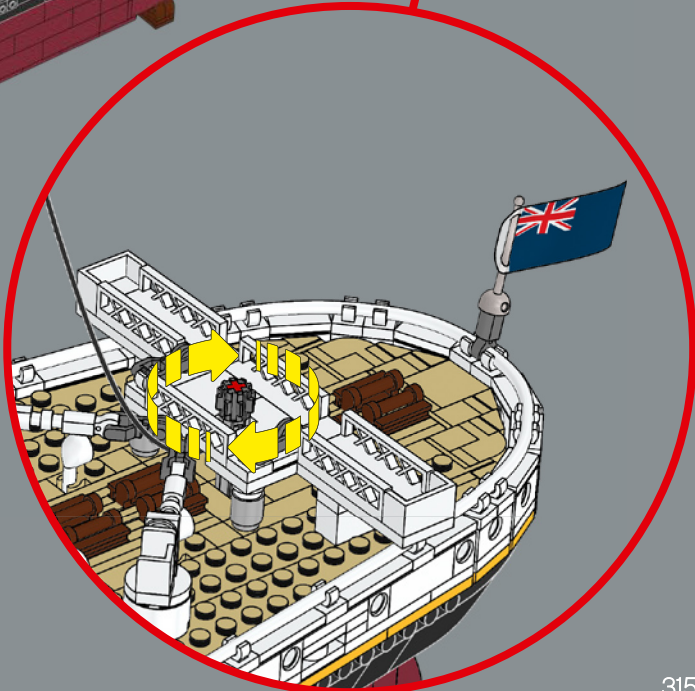
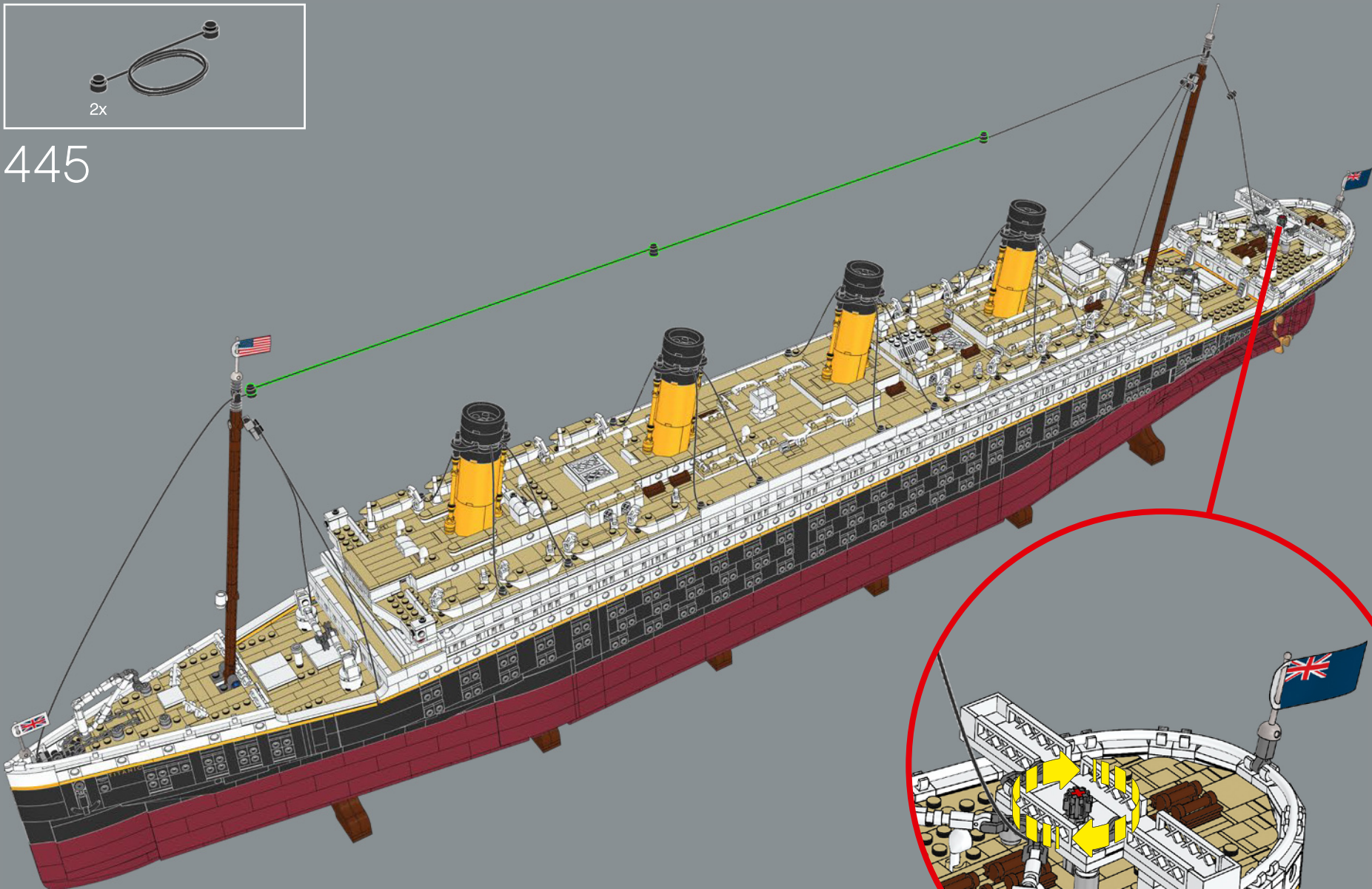

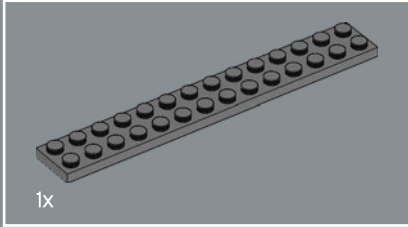
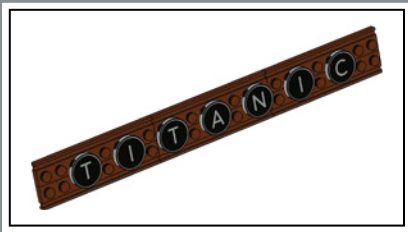

1x

446

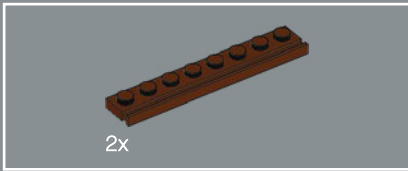
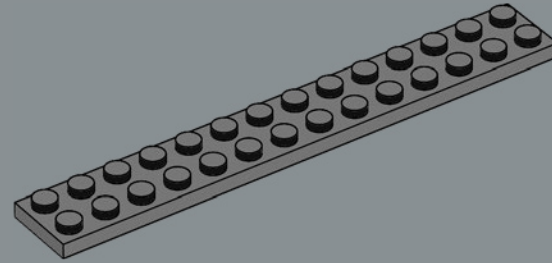

2x

447

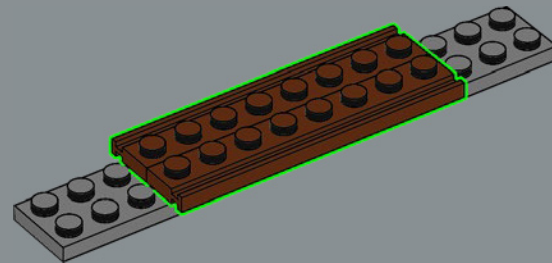

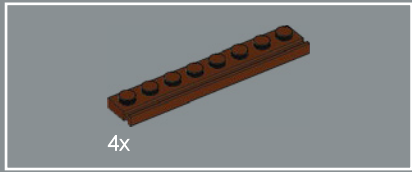

448

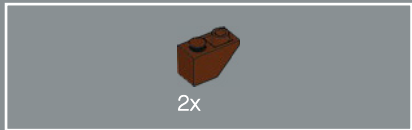
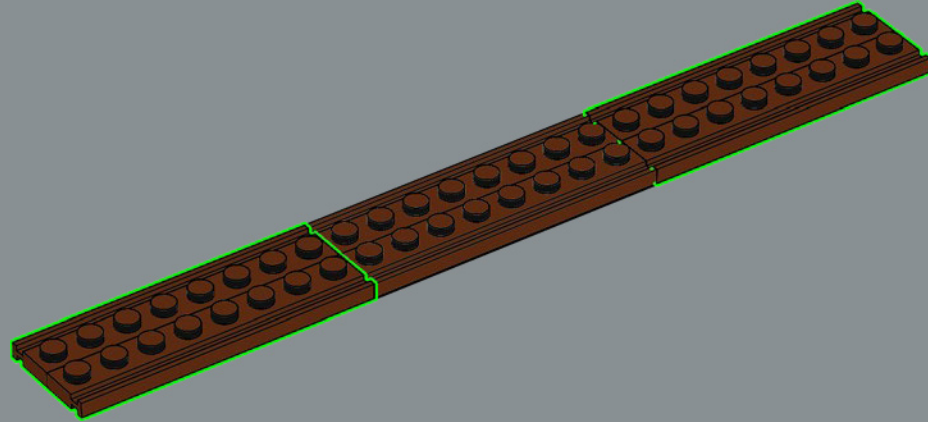

449

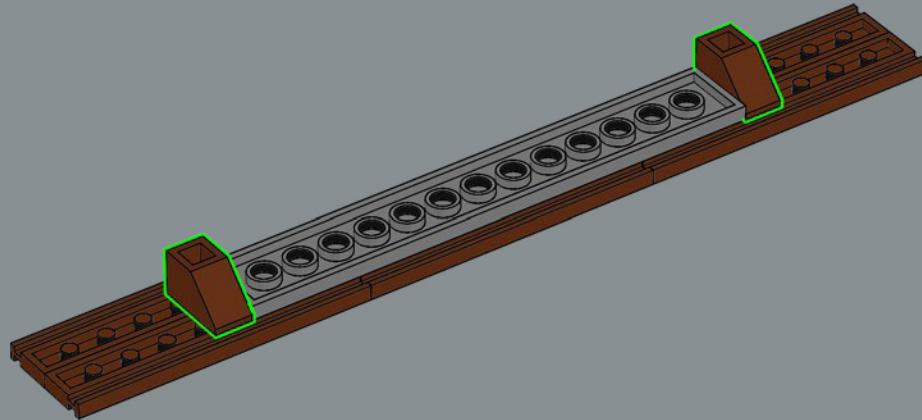



450

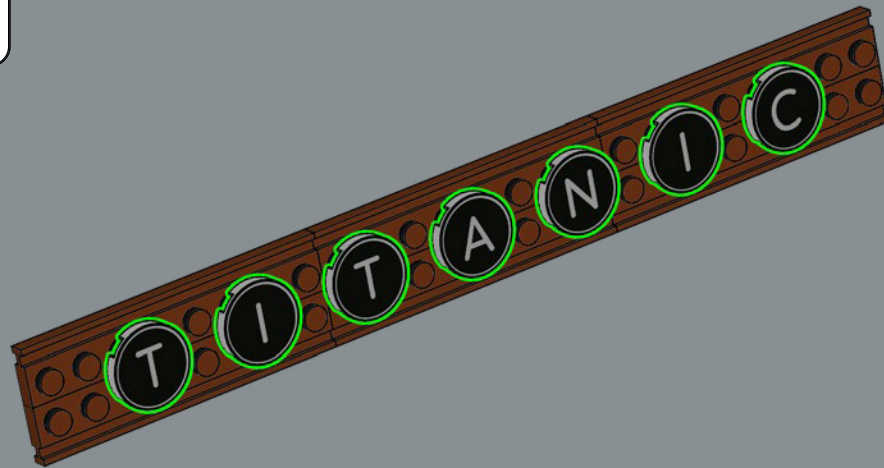

Le nom Titanic vient des titans de la mythologie grecque.

