



Booklet available in English on  
Livret disponible en français sur  
Folleto disponible en español en

[LEGO.com/service/buildinginstructions](https://www.lego.com/service/buildinginstructions)





## WELCOME/BIENVENUE/ TE DAMOS LA BIENVENIDA

● We are delighted to introduce you to our latest Modular Building set, the 16th building in this popular series. Whether you are building one for the first time or adding to your collection, we hope it gives you hours of LEGO® building fun.

● Nous sommes ravis de vous présenter notre nouvel ensemble, le 16<sup>e</sup> de la populaire série de bâtiments modulaires. Qu'il s'agisse du premier bâtiment modulaire que vous construisez ou d'un ajout à votre collection, nous espérons qu'il vous offrira des heures de plaisir de construction LEGO®.

● Nos alegra presentarte nuestro último set Modular Buildings: el 16<sup>o</sup> modelo de esta serie tan popular. Tanto si es la primera vez que construyes uno como si estás ampliando tu colección, esperamos que te proporcione horas de diversión construyendo con LEGO®.



Chris McVeigh, LEGO® Designer  
Chris McVeigh, concepteur LEGO®  
Chris McVeigh, diseñador de LEGO®



## BUILD A STORY/CONSTRUIRE UNE HISTOIRE/ CONSTRUYE UNA HISTORIA

● LEGO® Designer Chris McVeigh, and the rest of the LEGO design team, wanted to ensure you could build a story as well as a model with this Police Station set, that's why it's packed with intricate details and hidden features that fuel the imagination. In Chris's narrative, the local newsstand operator has fallen on hard times, but he's cooked up a sweet scheme to generate headlines and sell papers. Feel free to build further on this or start a completely different story of your own.

● Le concepteur LEGO® Chris McVeigh et le reste de l'équipe de conception LEGO voulaient s'assurer que vous pourriez non seulement construire un modèle, mais aussi une histoire avec cet ensemble de poste de police. C'est pourquoi il contient une pléthore de détails complexes et de fonctions cachées qui stimulent l'imagination. Dans le récit de Chris, le commis du kiosque à journaux traverse une période difficile, mais il a concocté un ingénieux stratagème pour générer des grands titres et vendre des journaux. Vous pouvez poursuivre la construction de cette histoire, ou bâtir la vôtre de toute pièce.

● El diseñador de LEGO® Chris McVeigh y el resto del equipo de diseño de LEGO querían asegurarse de que, además de un modelo, el set Estación de Policía te permitiera construir una historia, así que decidieron incluir un montón de elaborados detalles y funciones ocultas para dar rienda suelta a la imaginación. Según el relato de Chris, el dueño del puesto de periódicos cercano pasa por momentos difíciles, pero ha elaborado un buen plan para fabricar titulares y vender periódicos. Puedes seguir trabajando en su historia o inventar una completamente nueva.





[LEGO.com/brickseparator](https://LEGO.com/brickseparator)



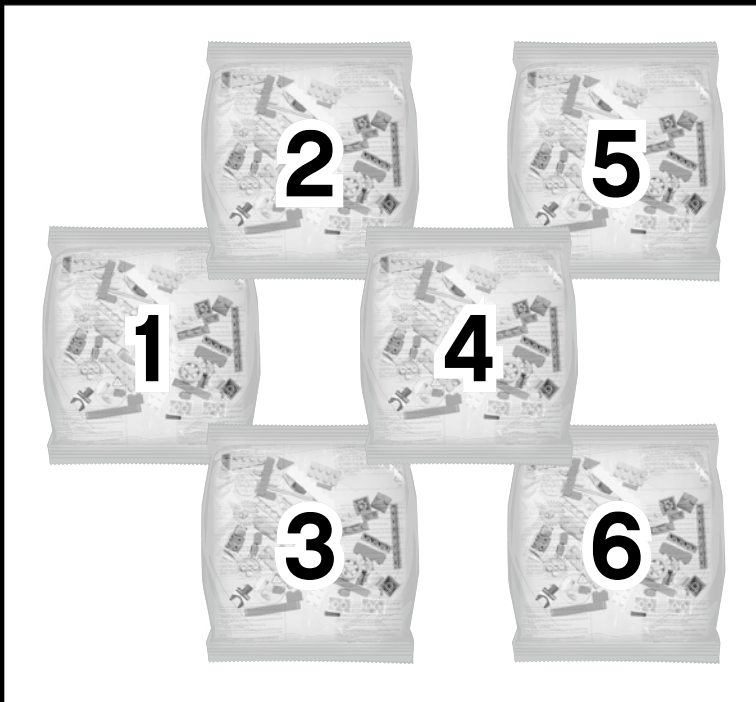



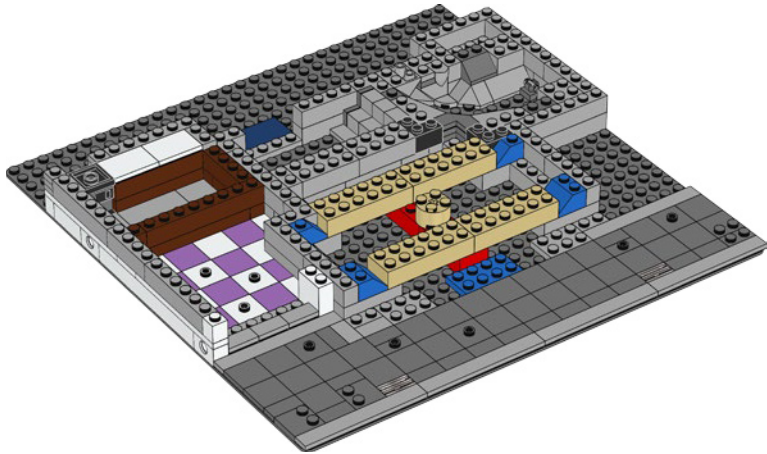
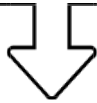
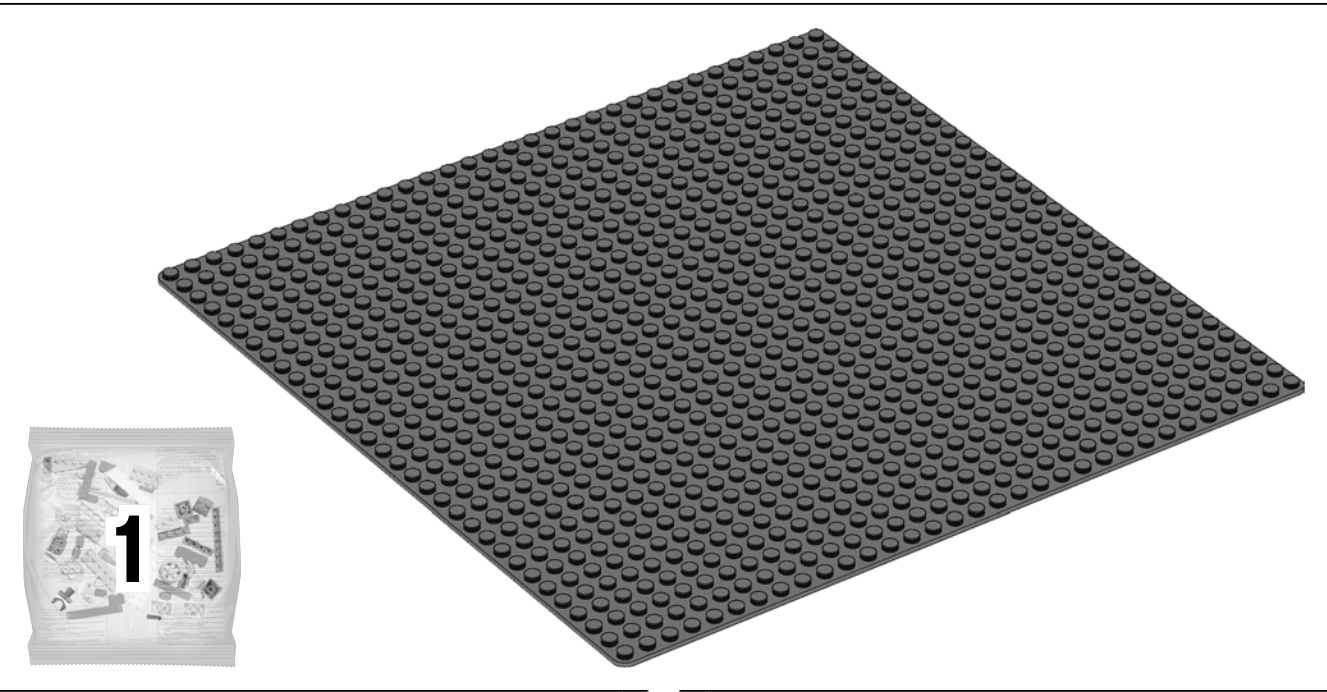



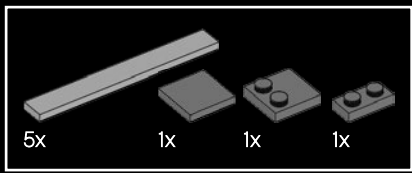

1

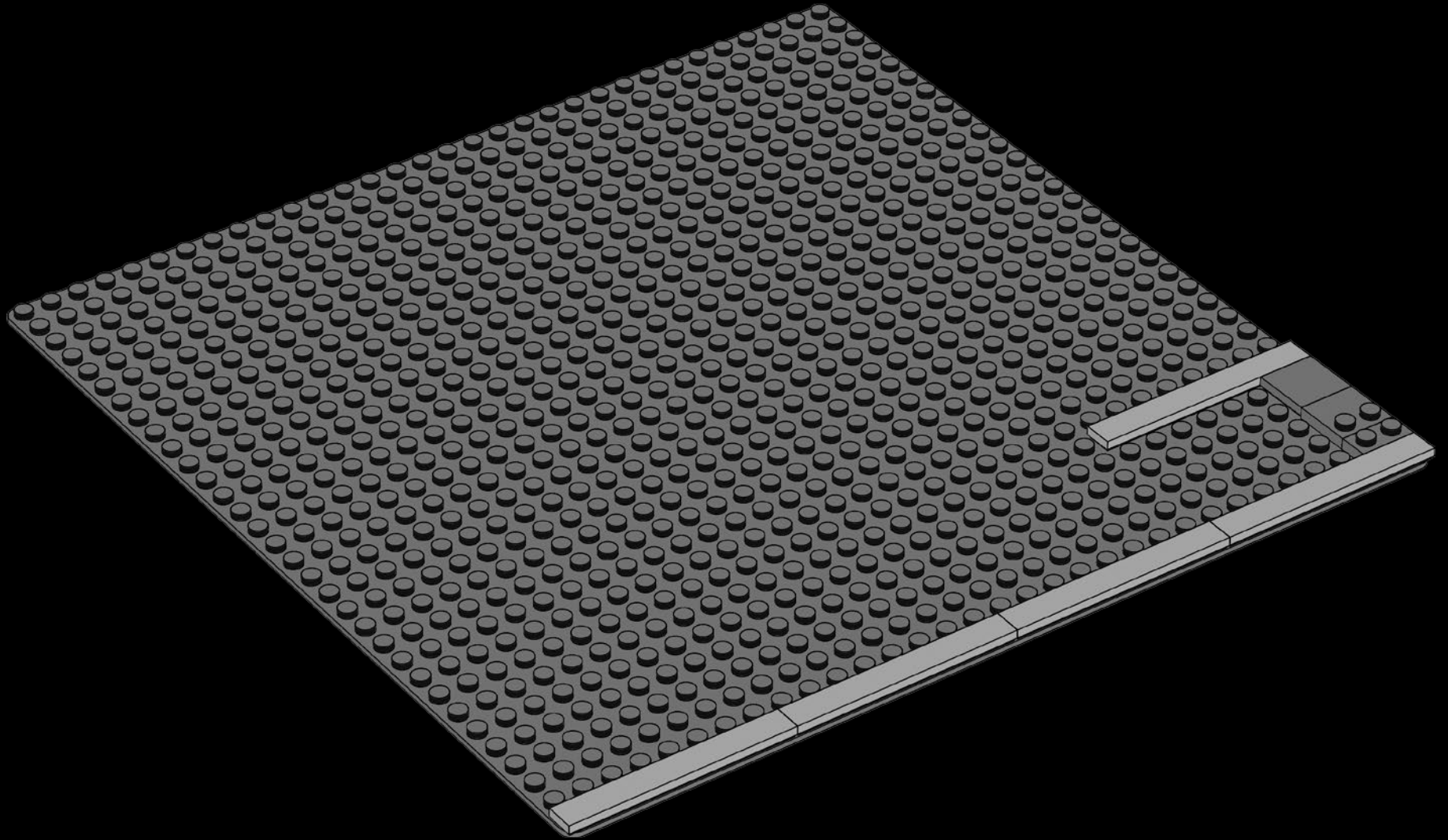

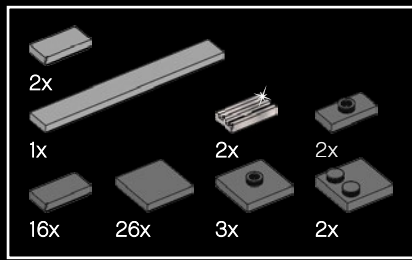

2

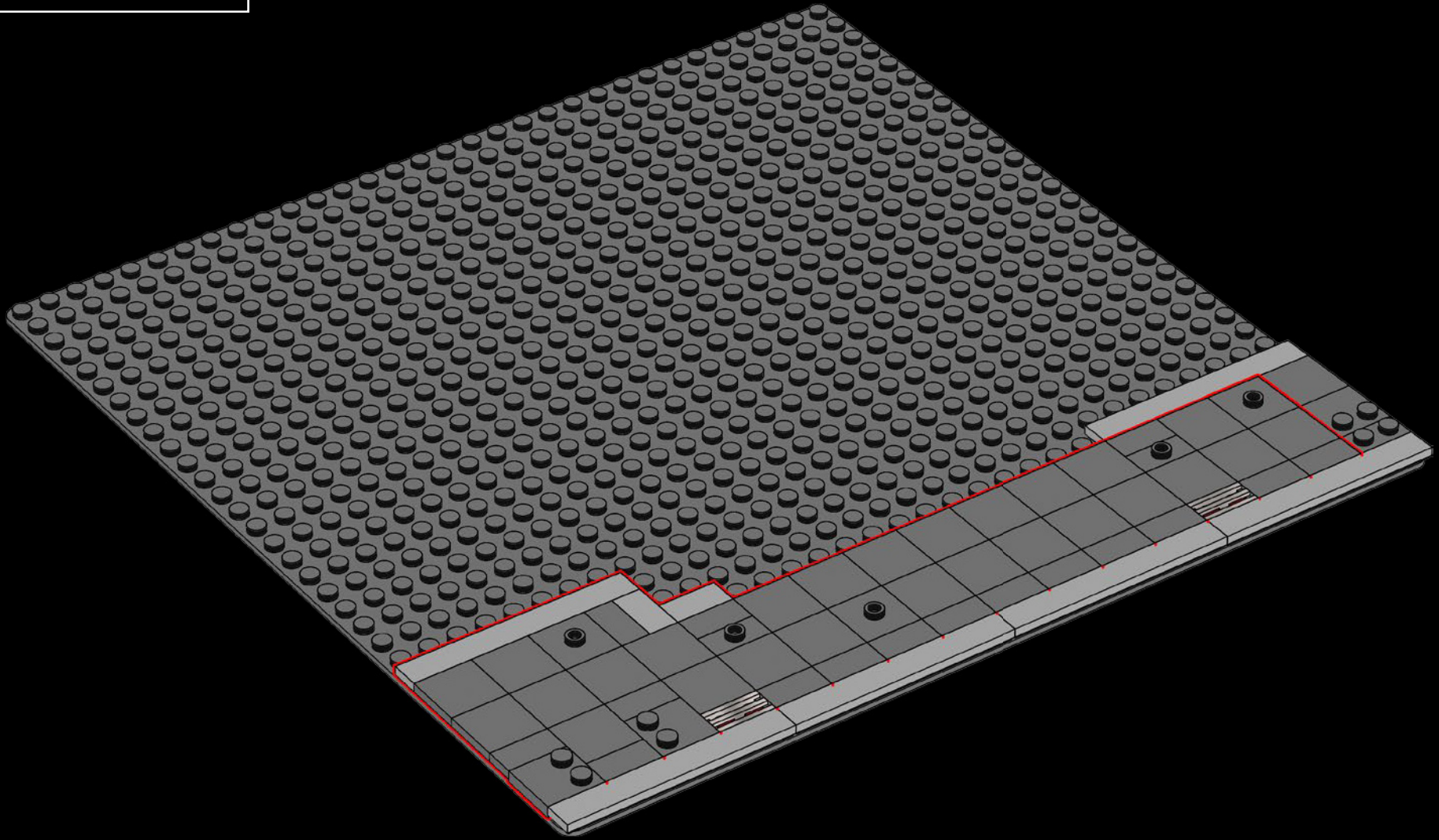

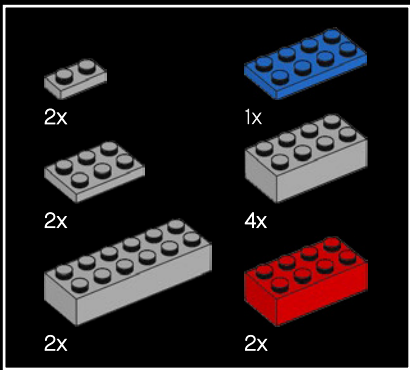

3

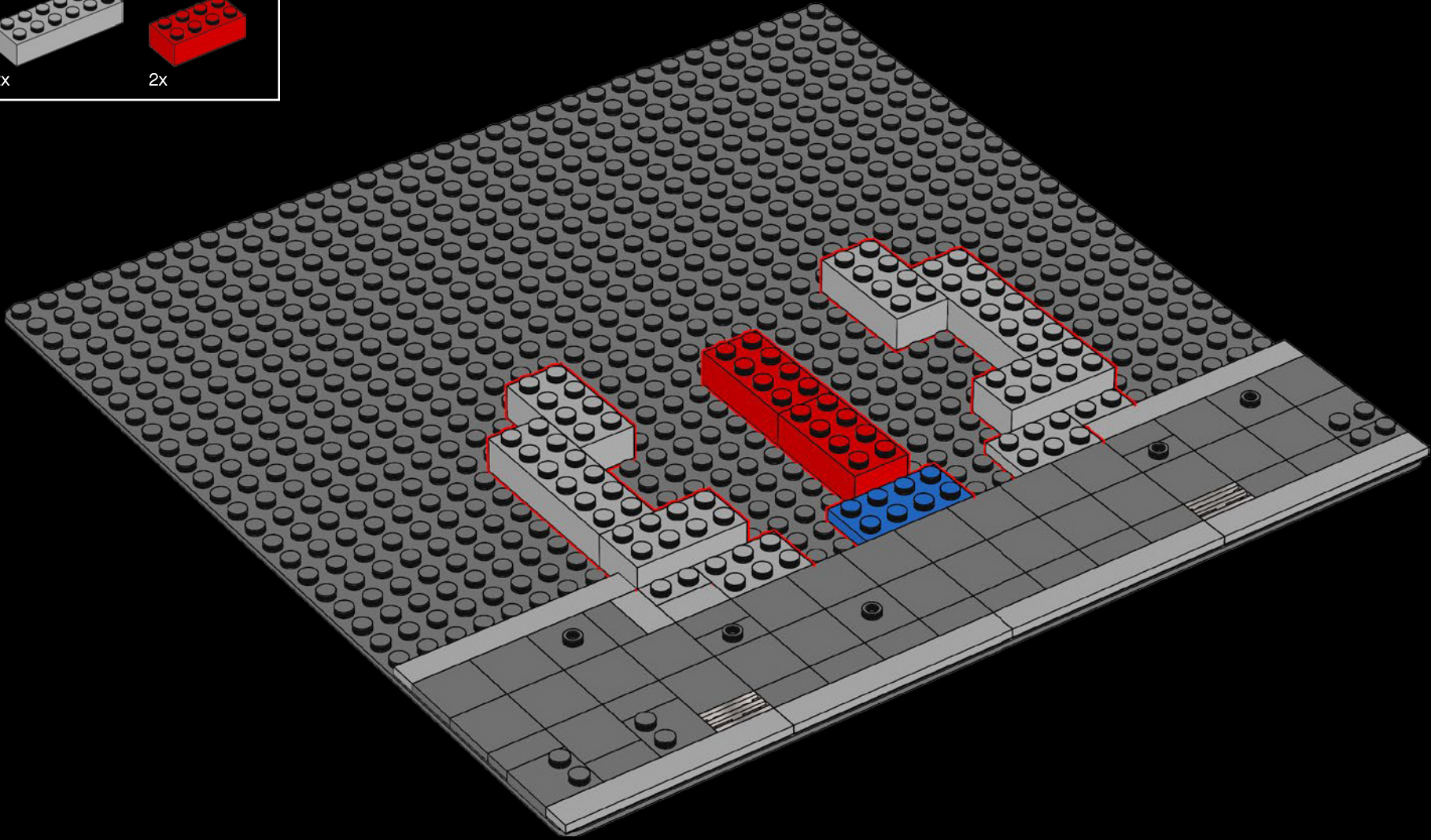



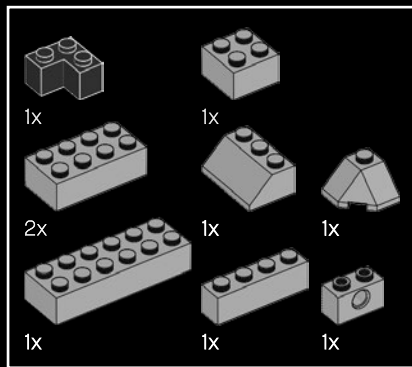

4

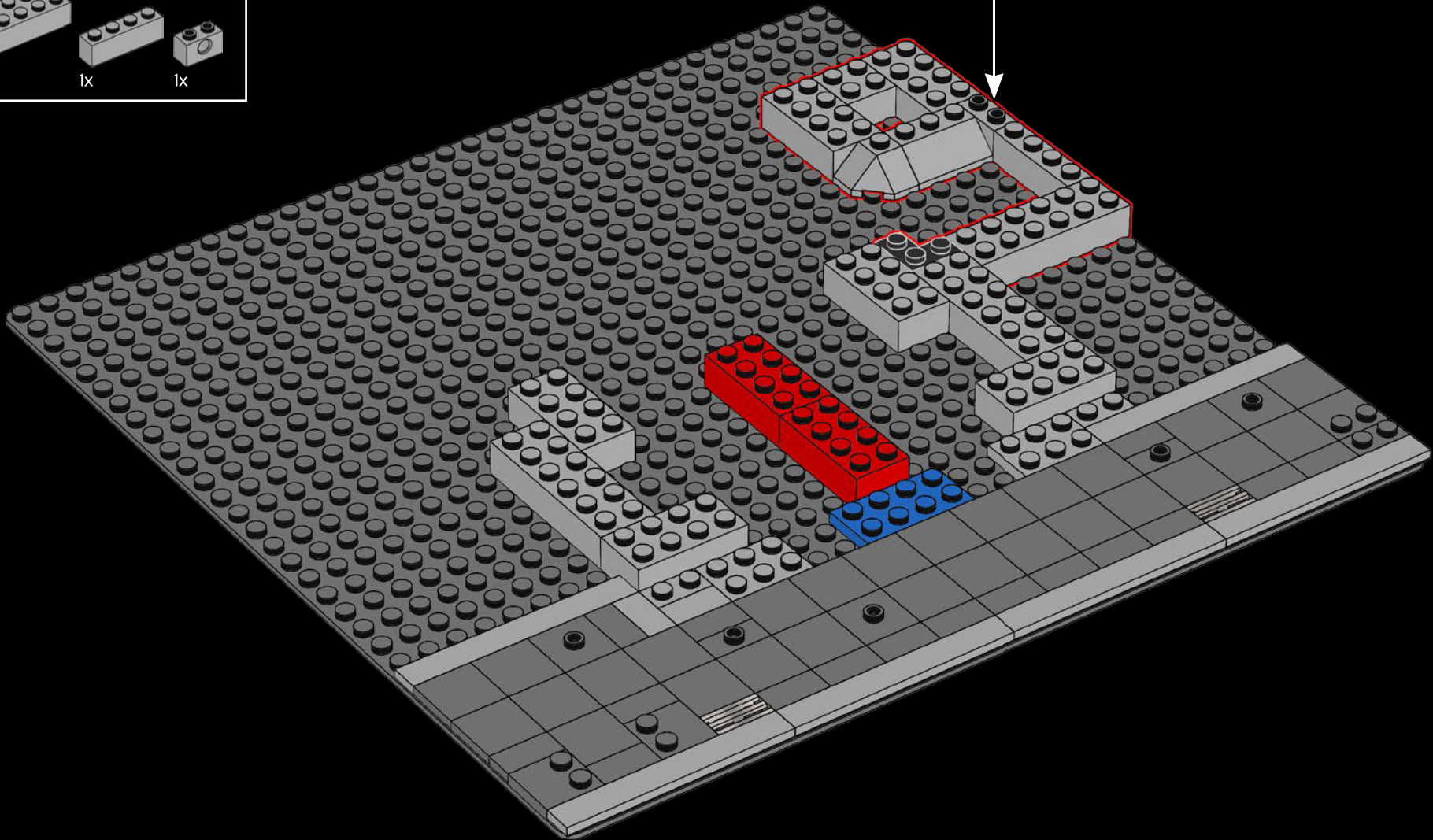
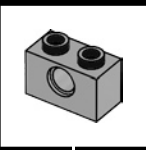

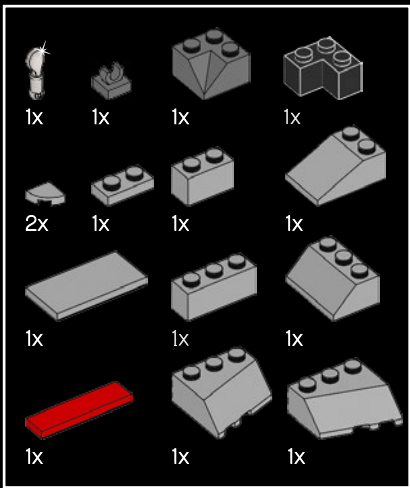

5

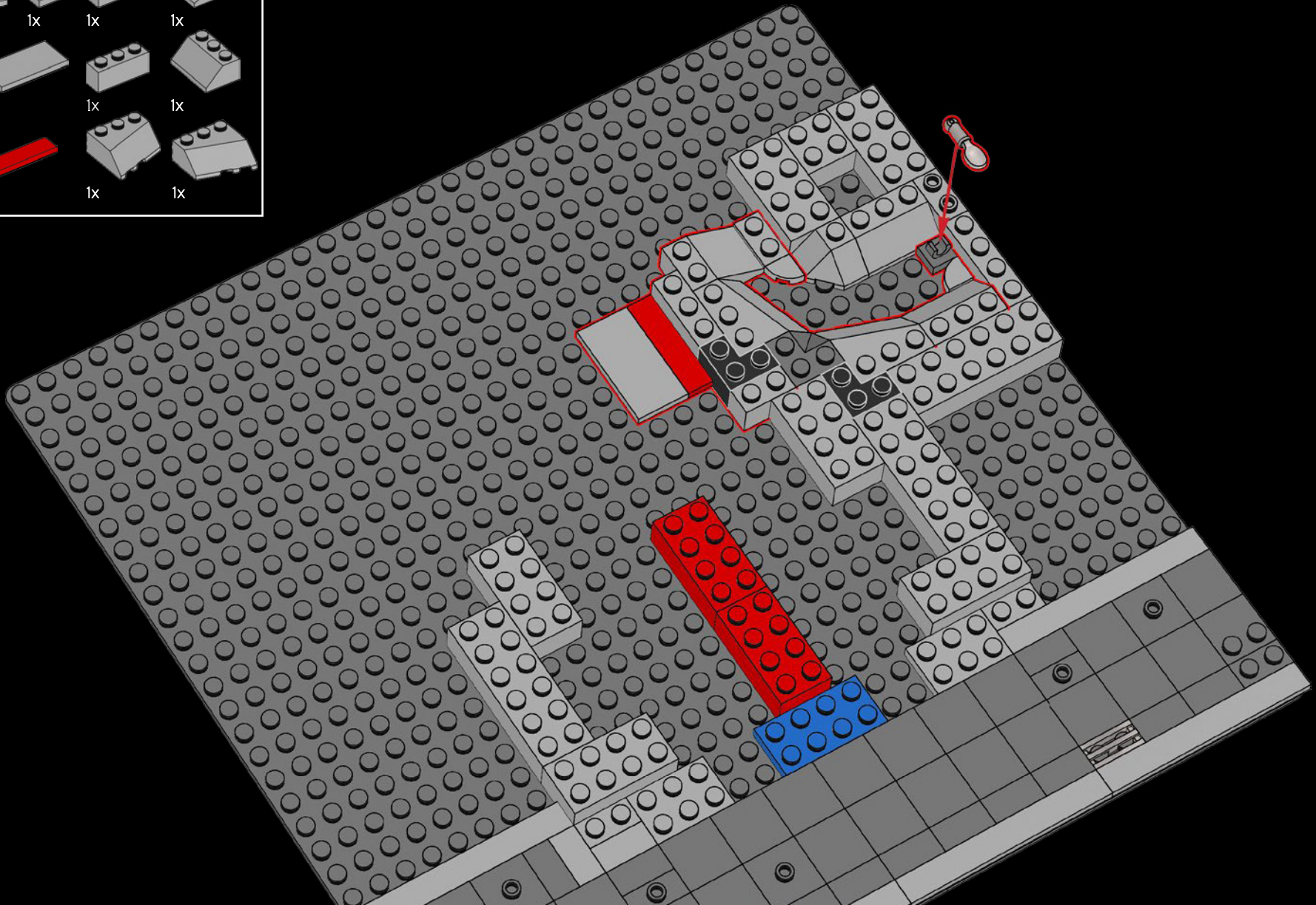



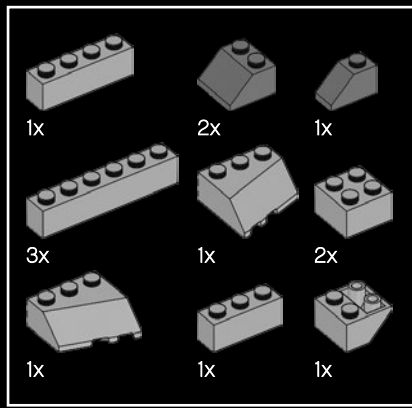

6

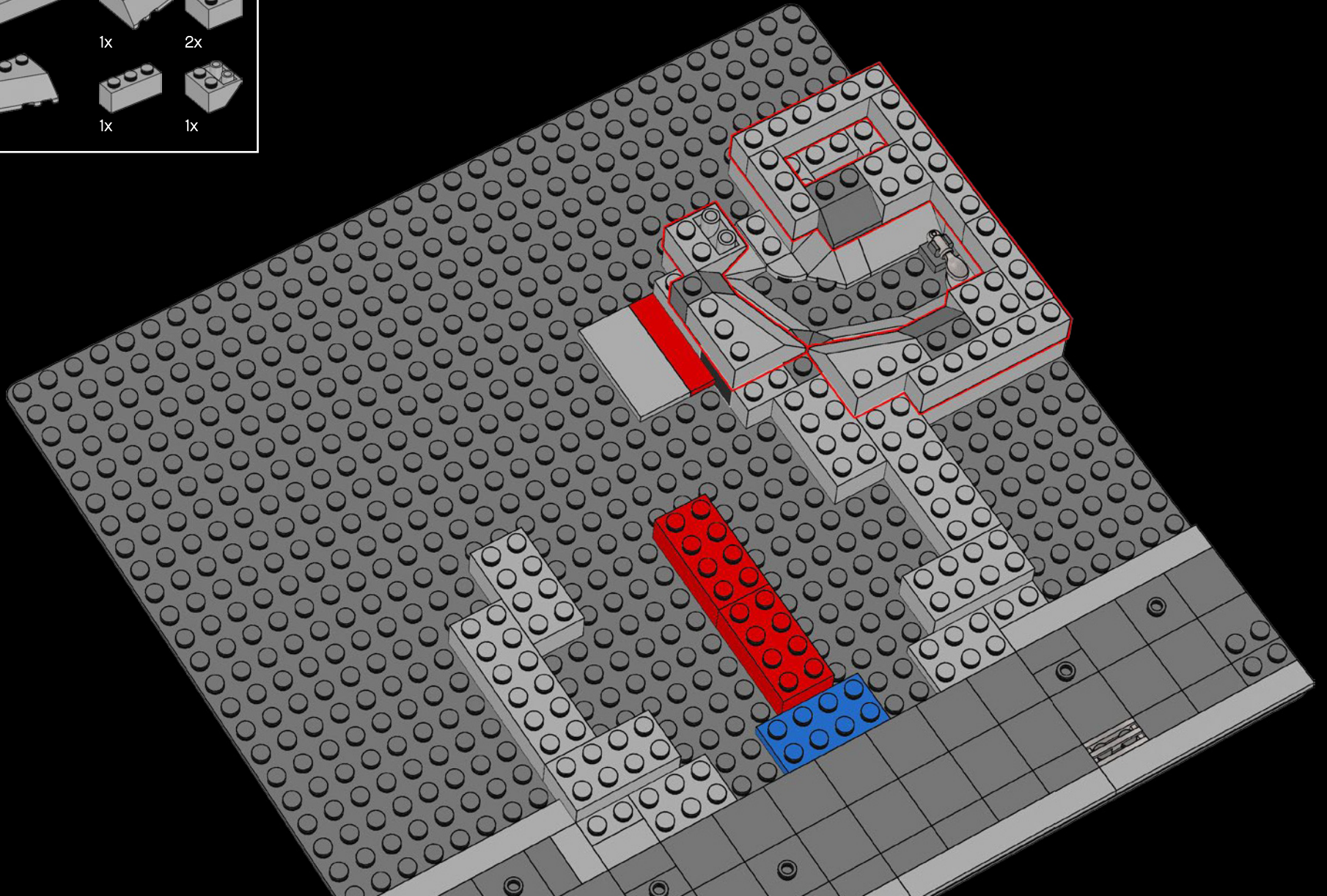



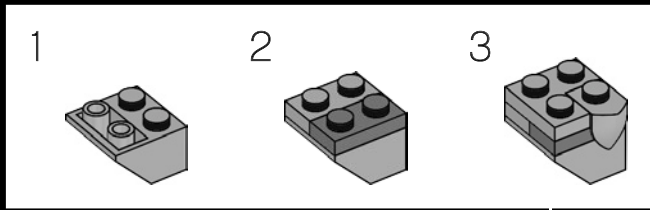
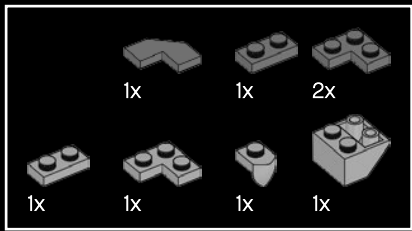

7

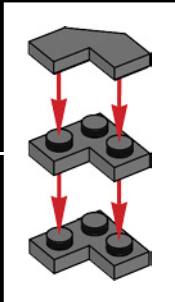
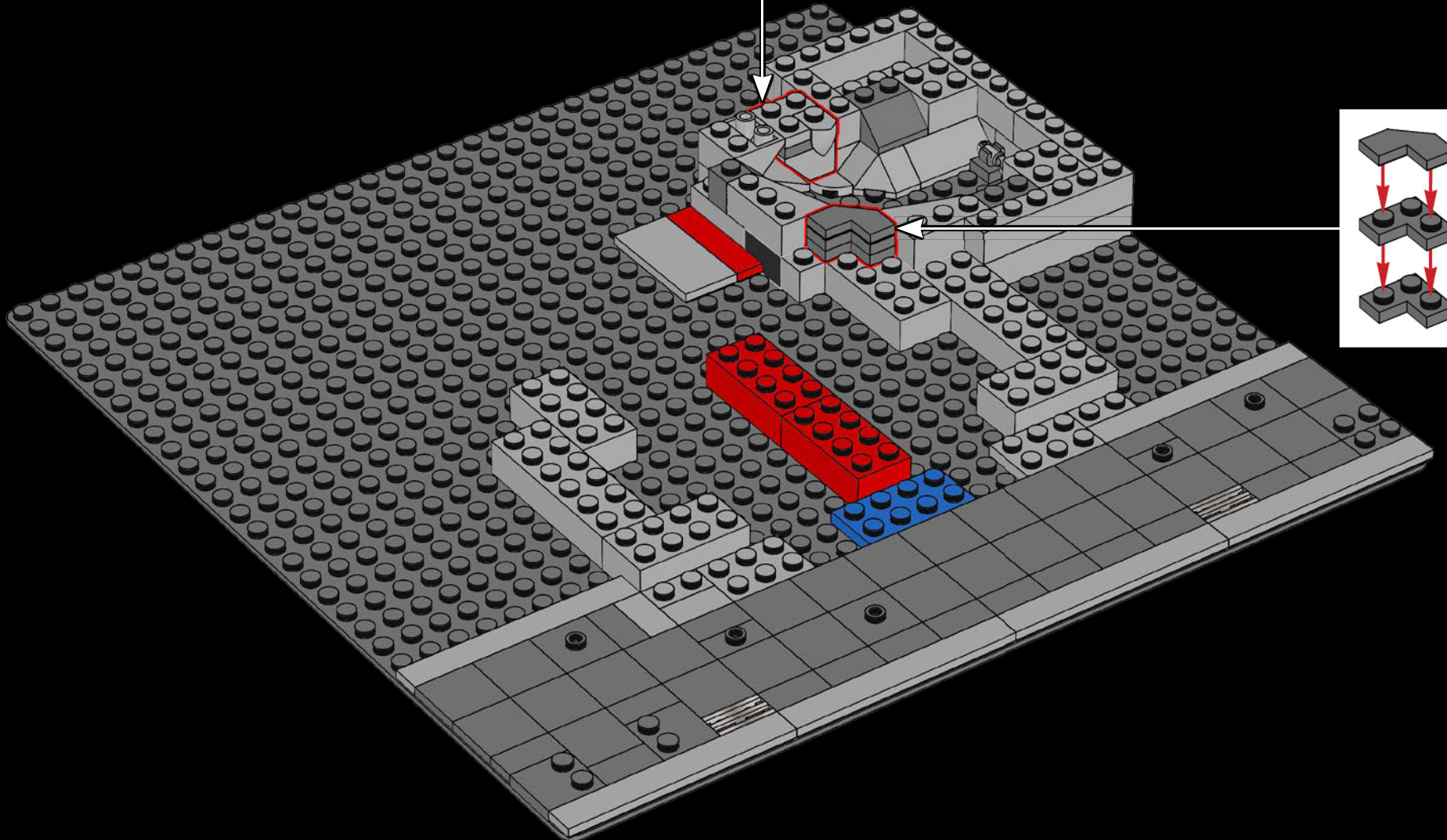

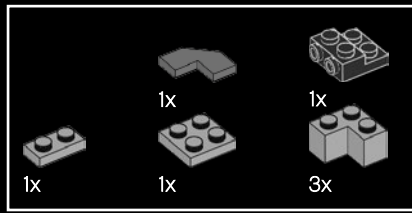

8

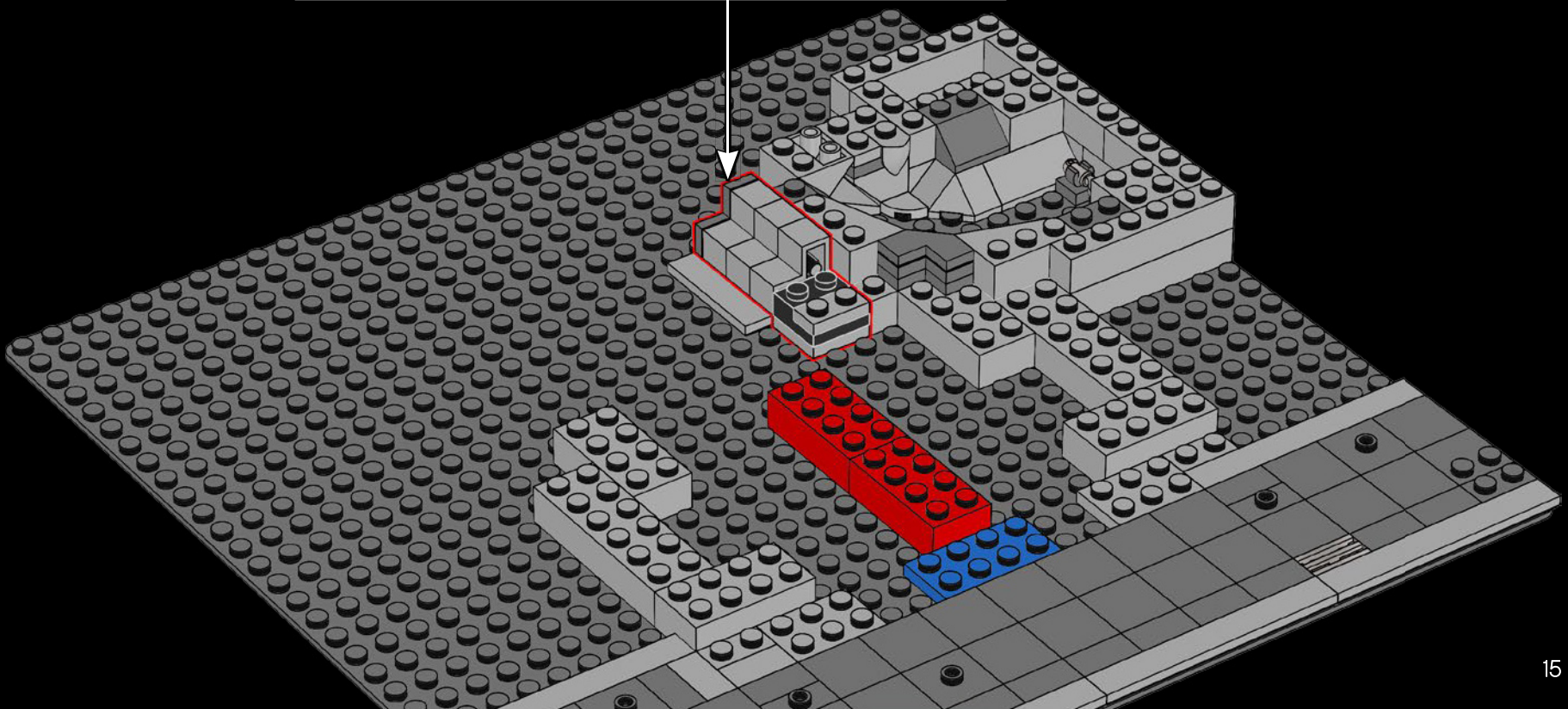
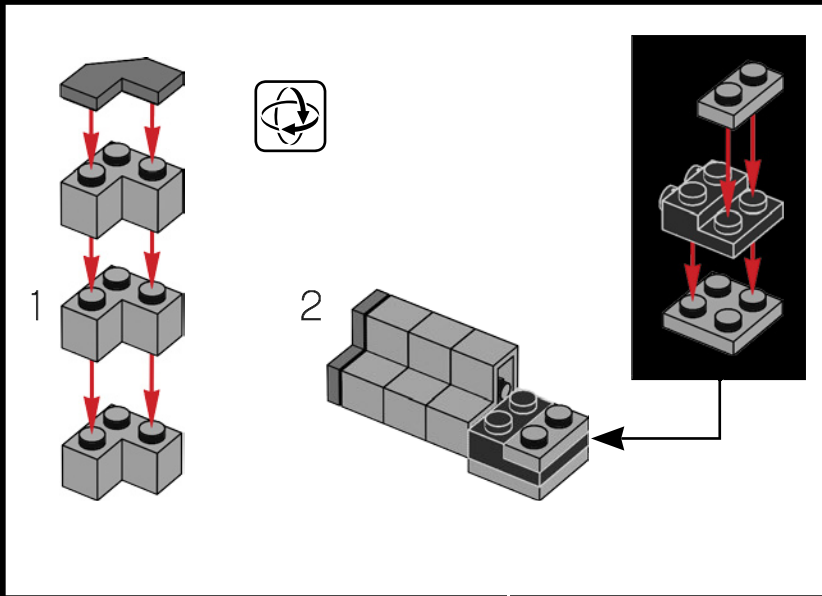



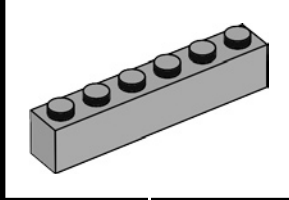
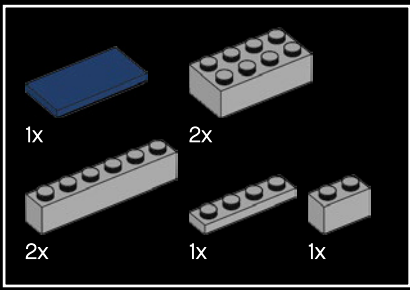

9

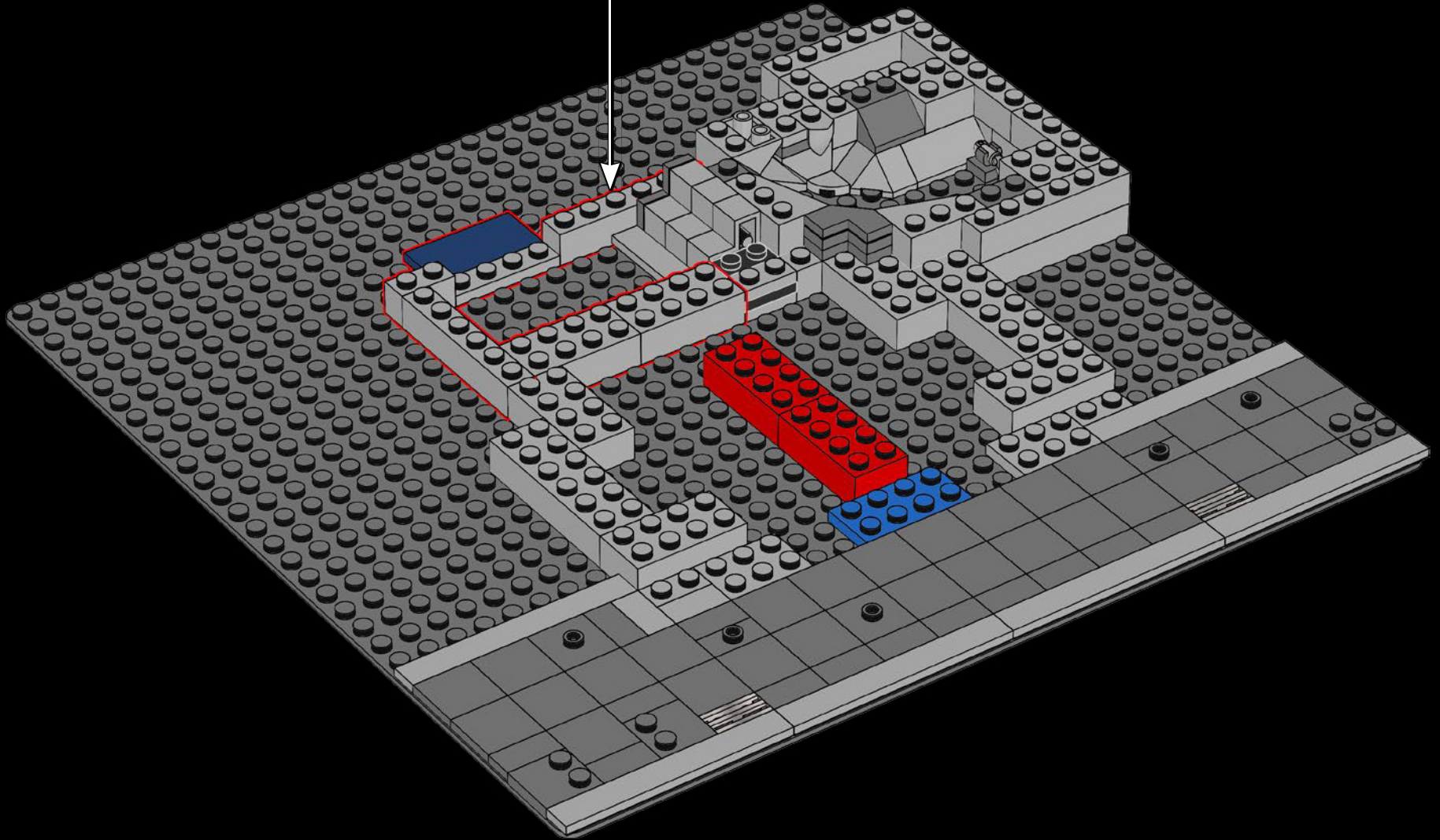

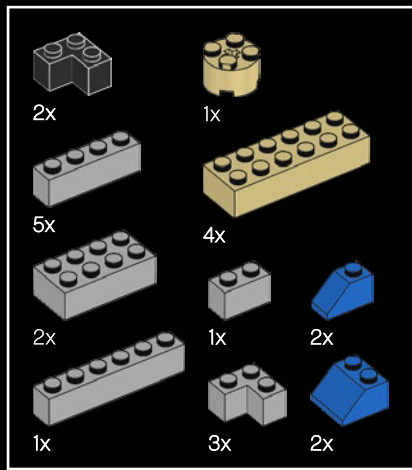

10

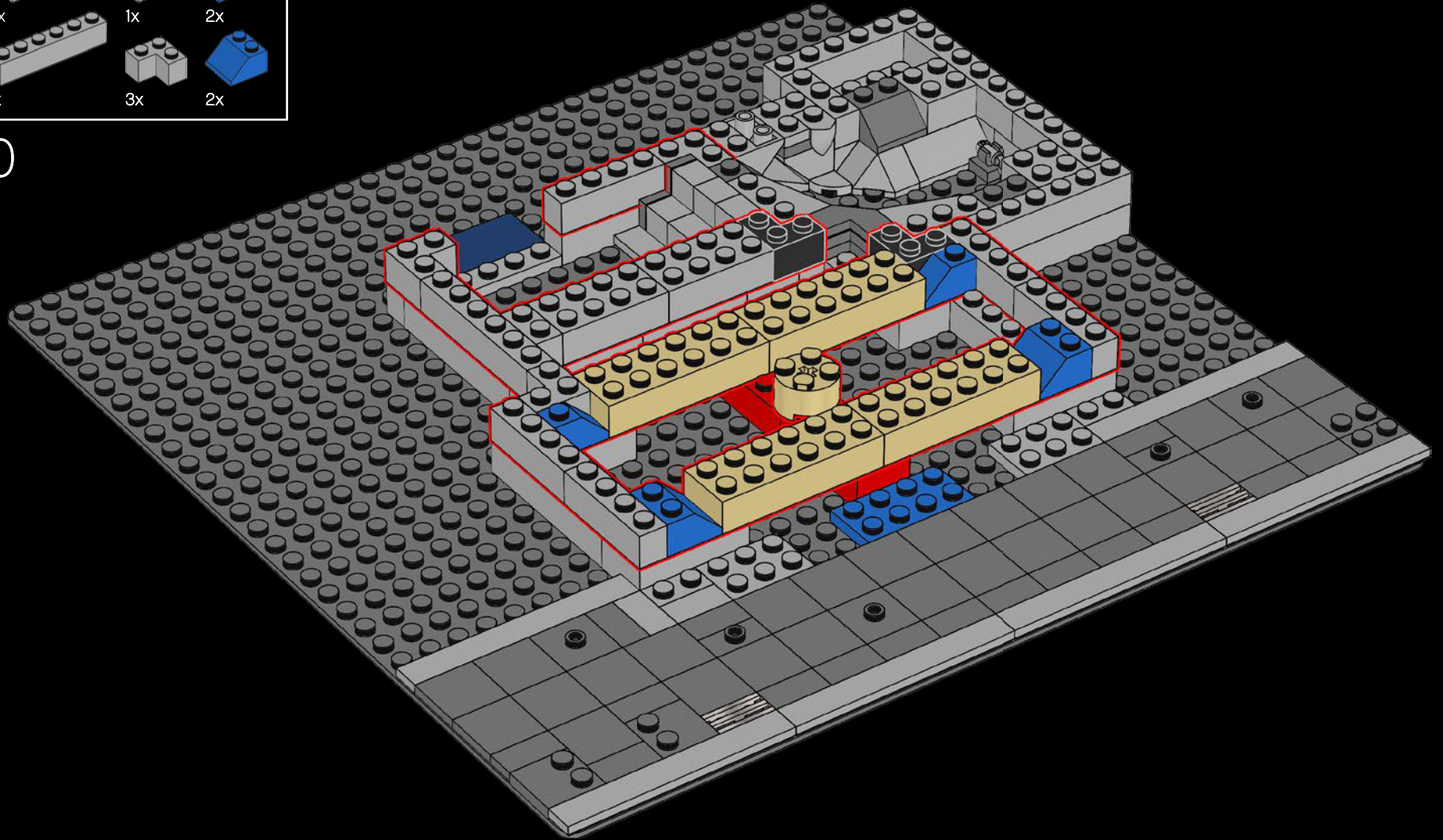



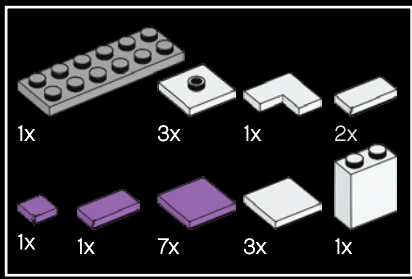

11

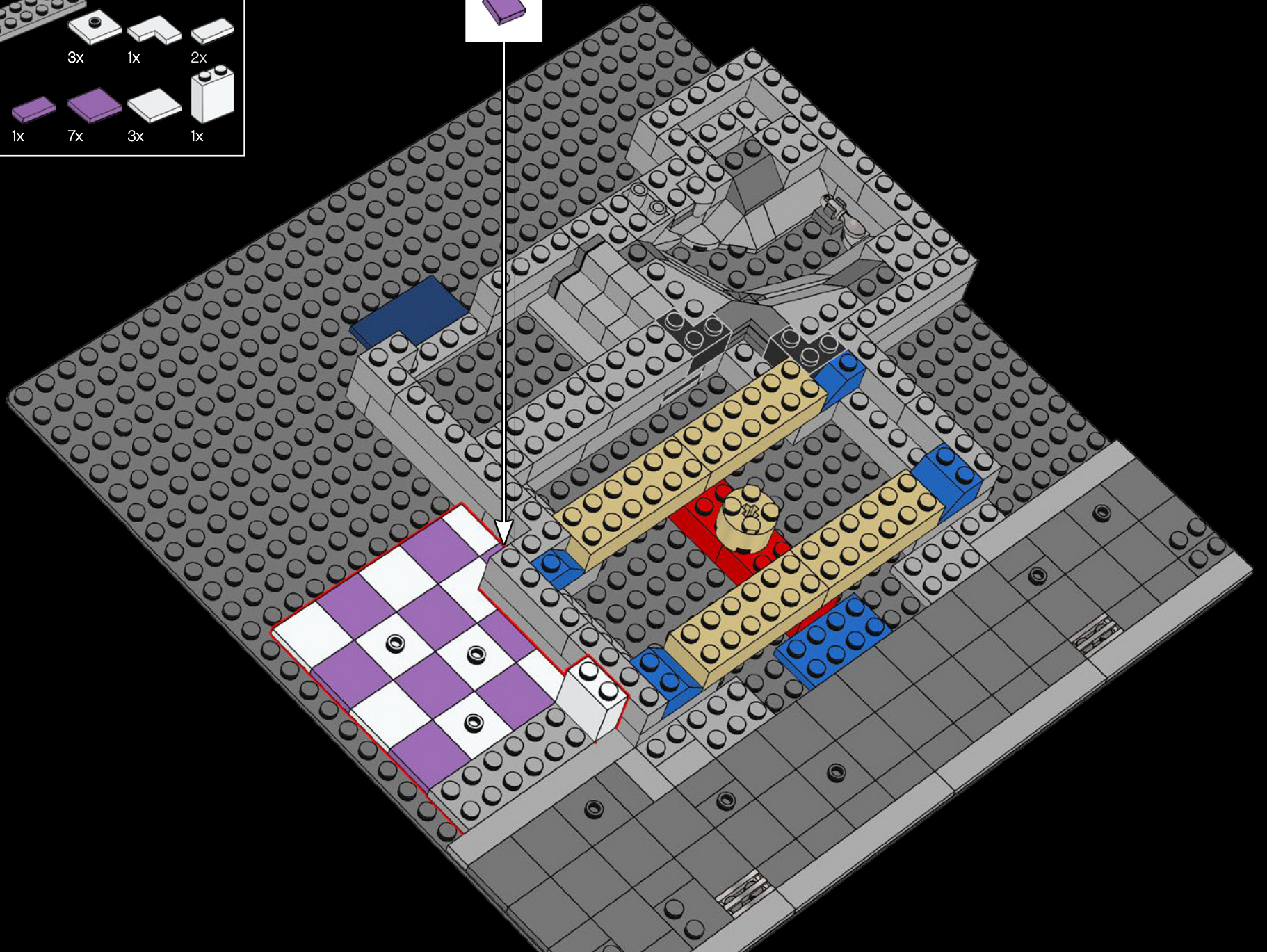



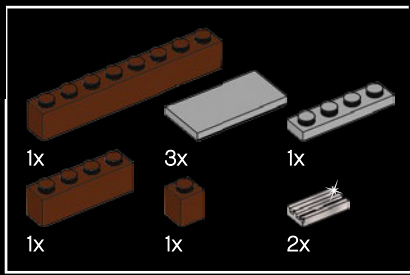

12

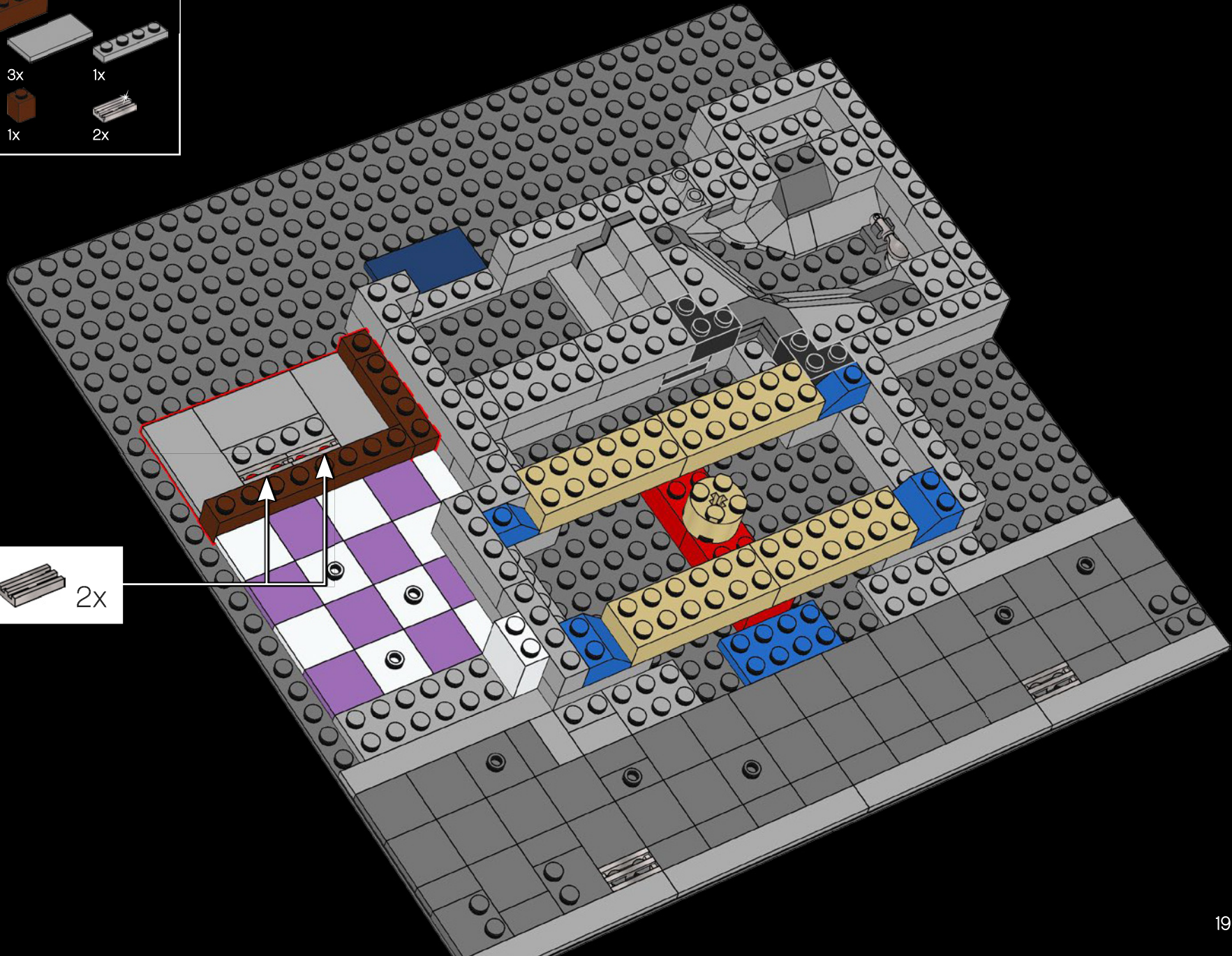
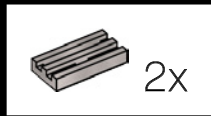





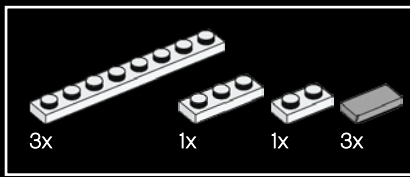

14

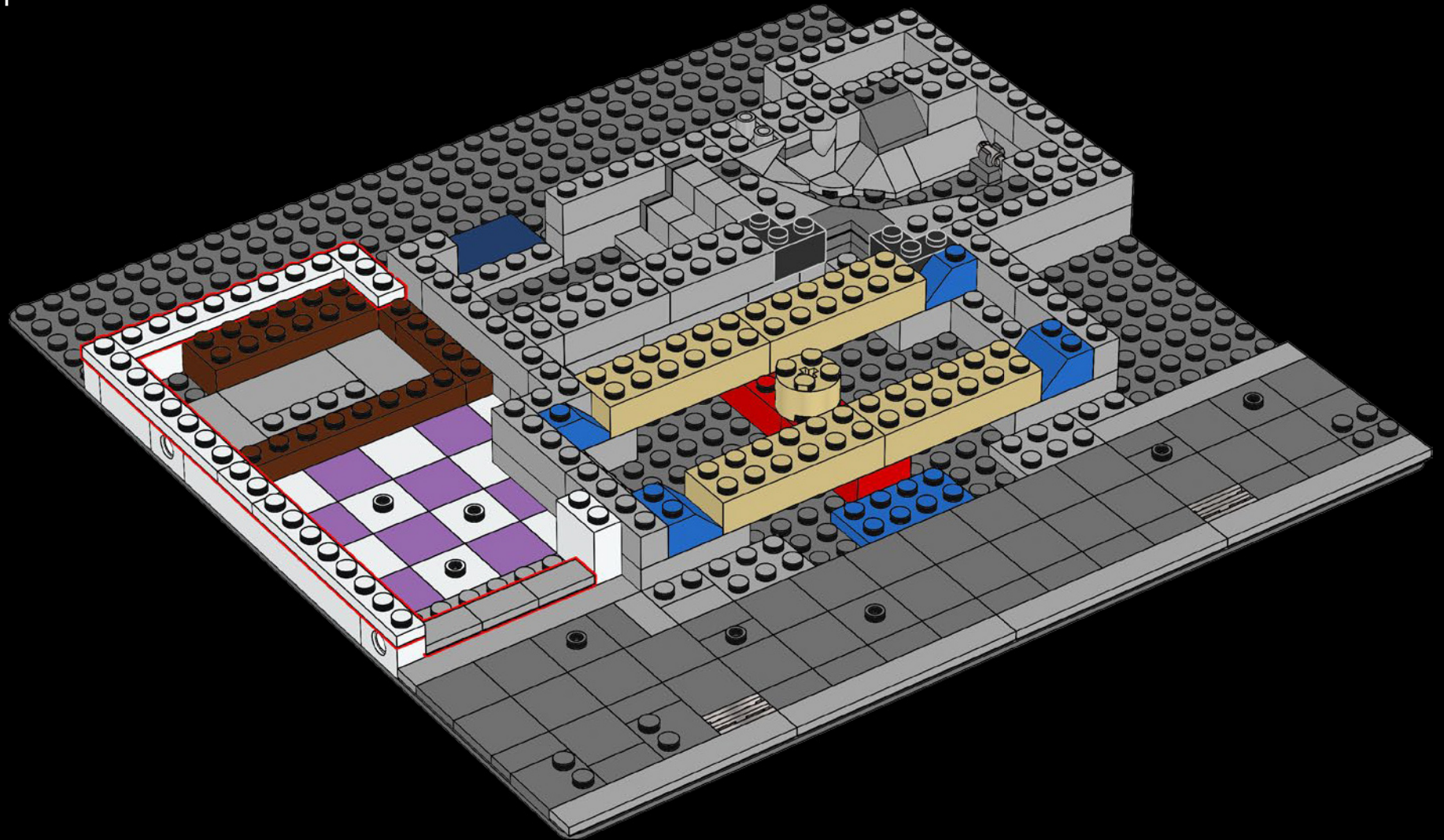



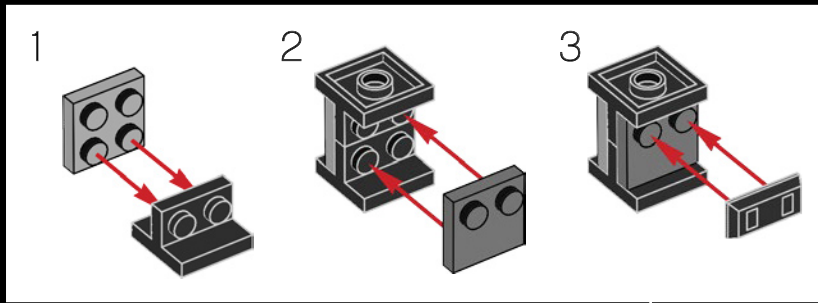
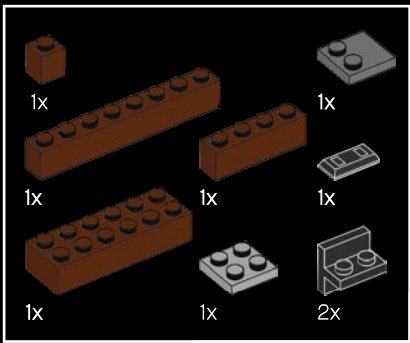

15

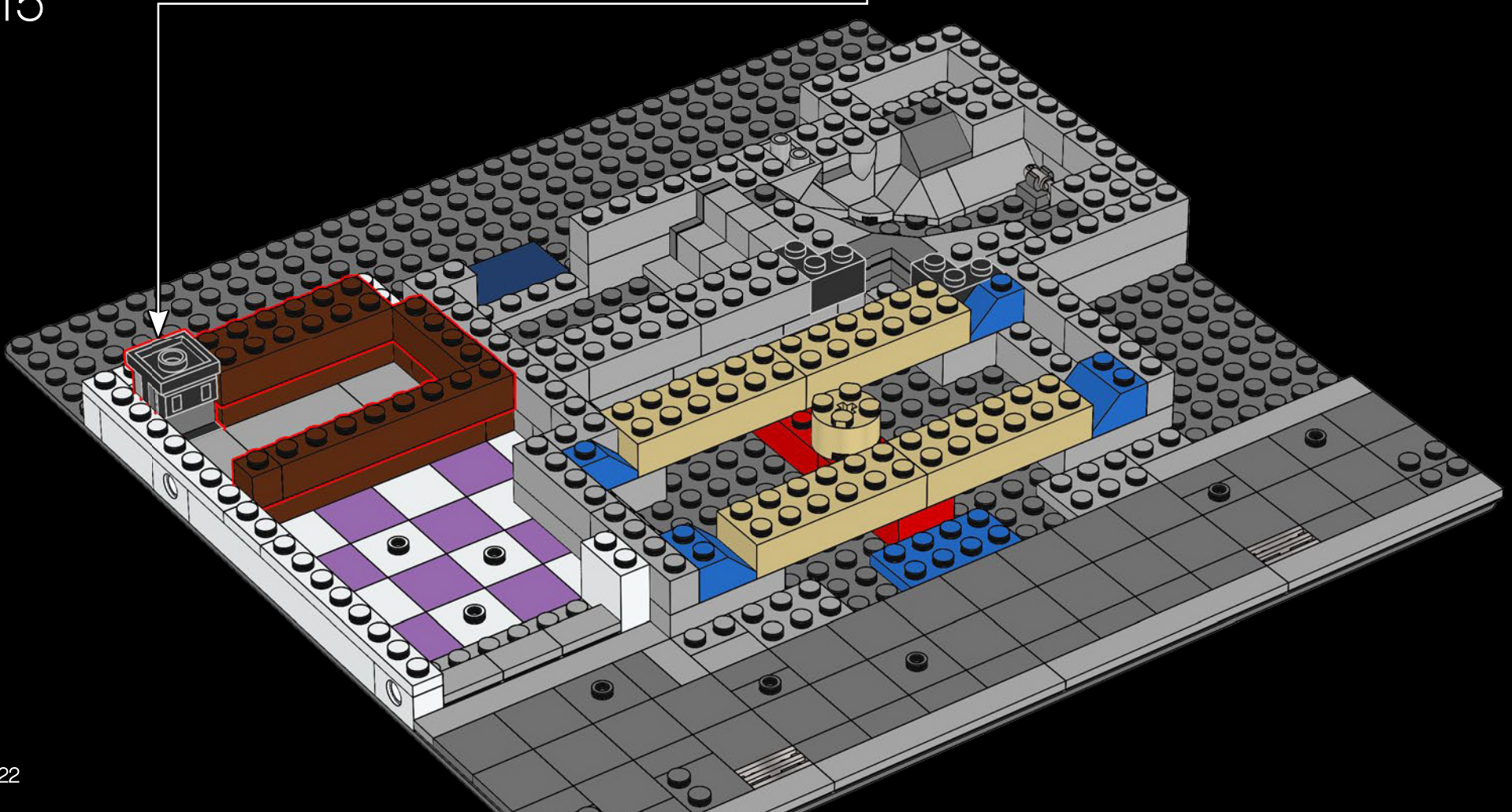

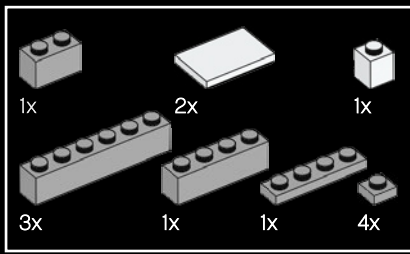

16

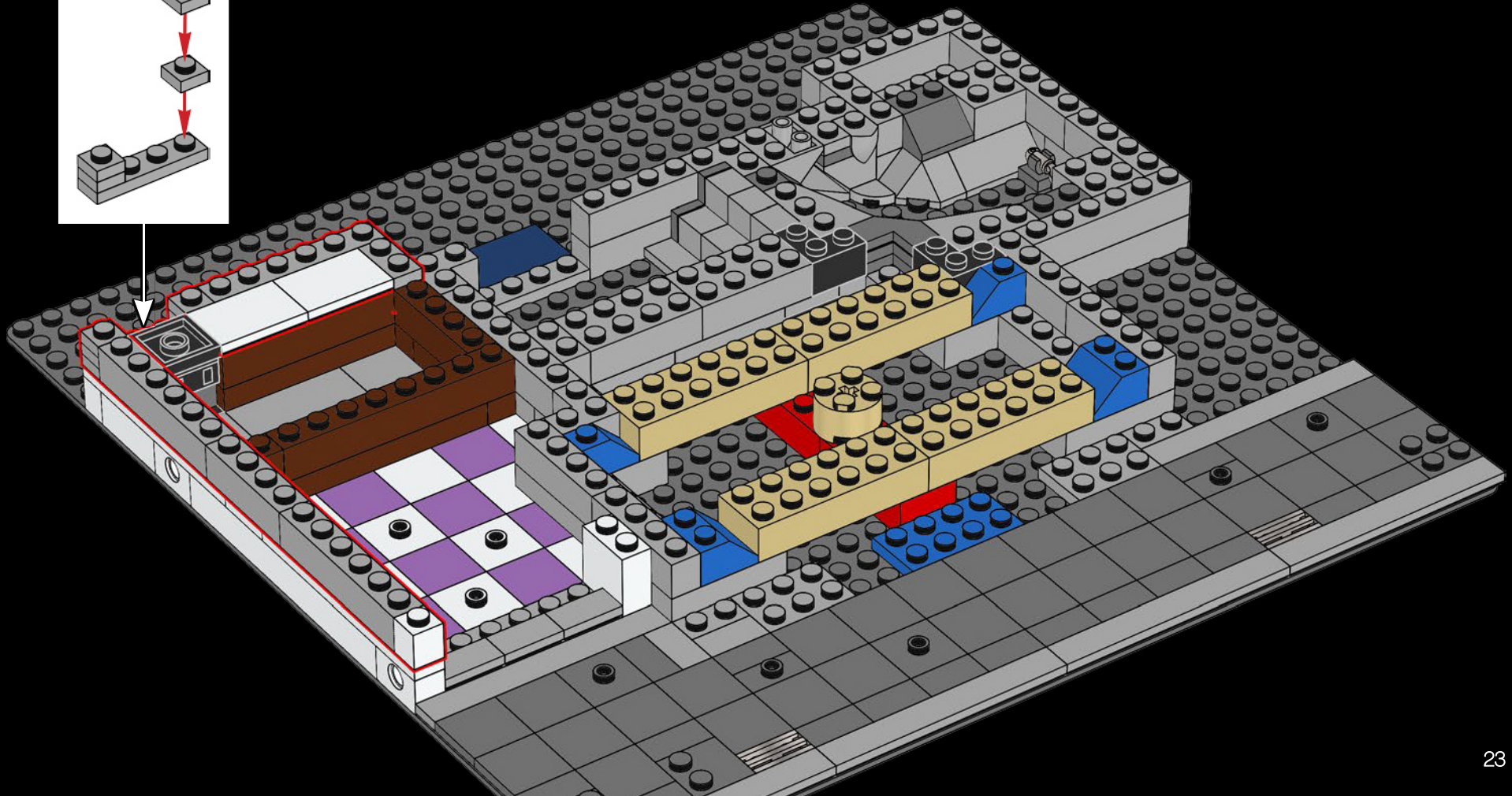
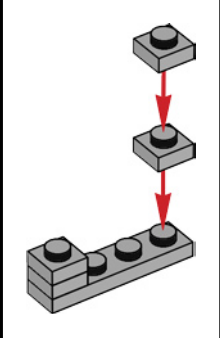



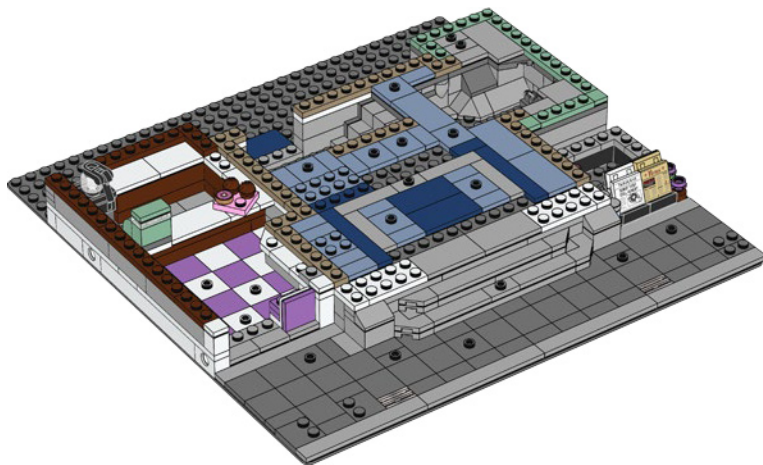



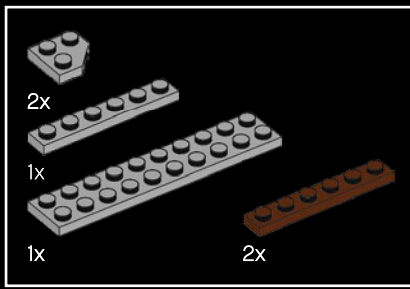

17

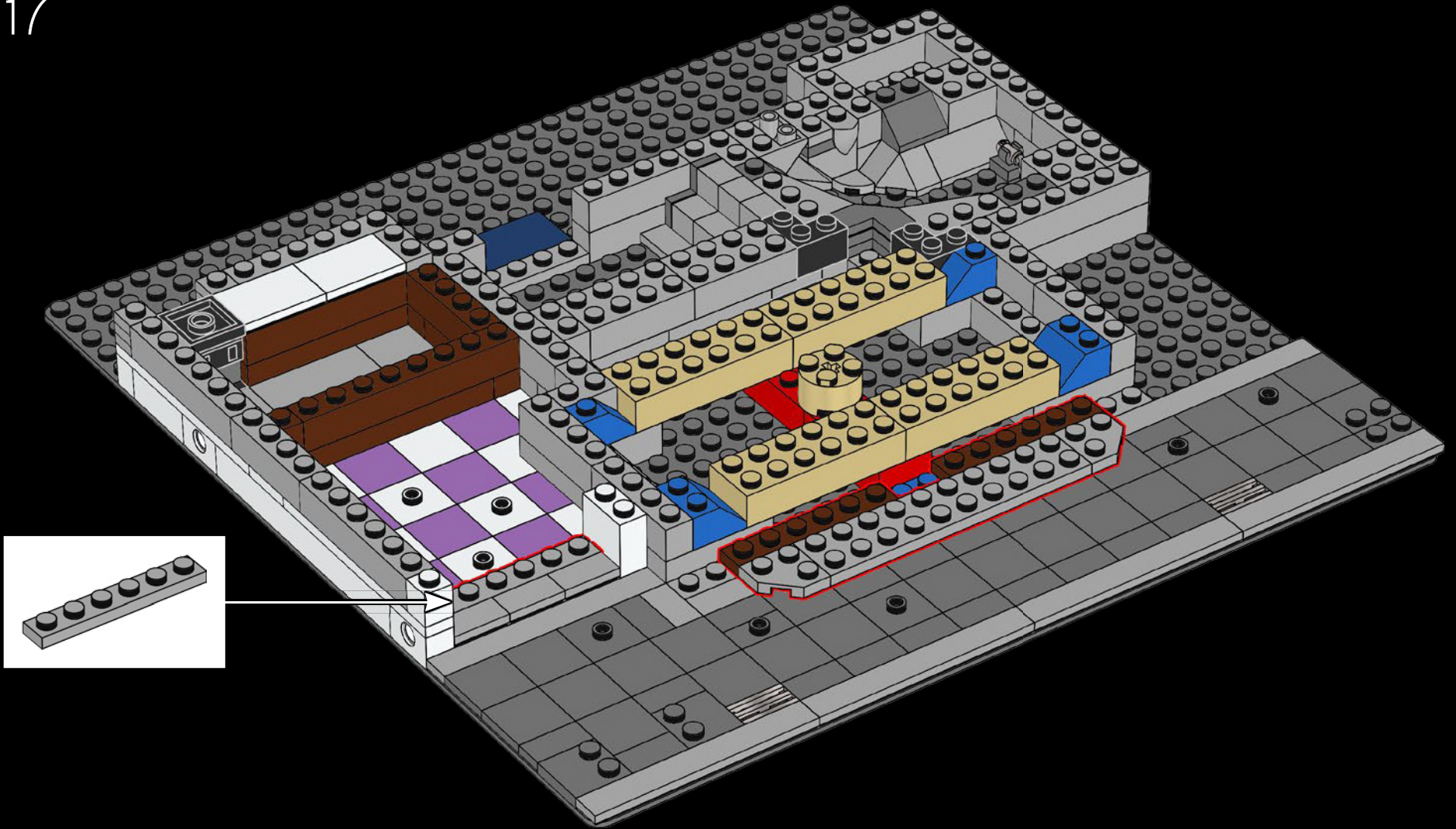

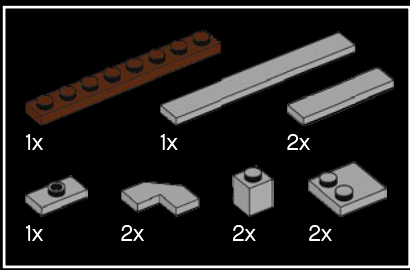

18

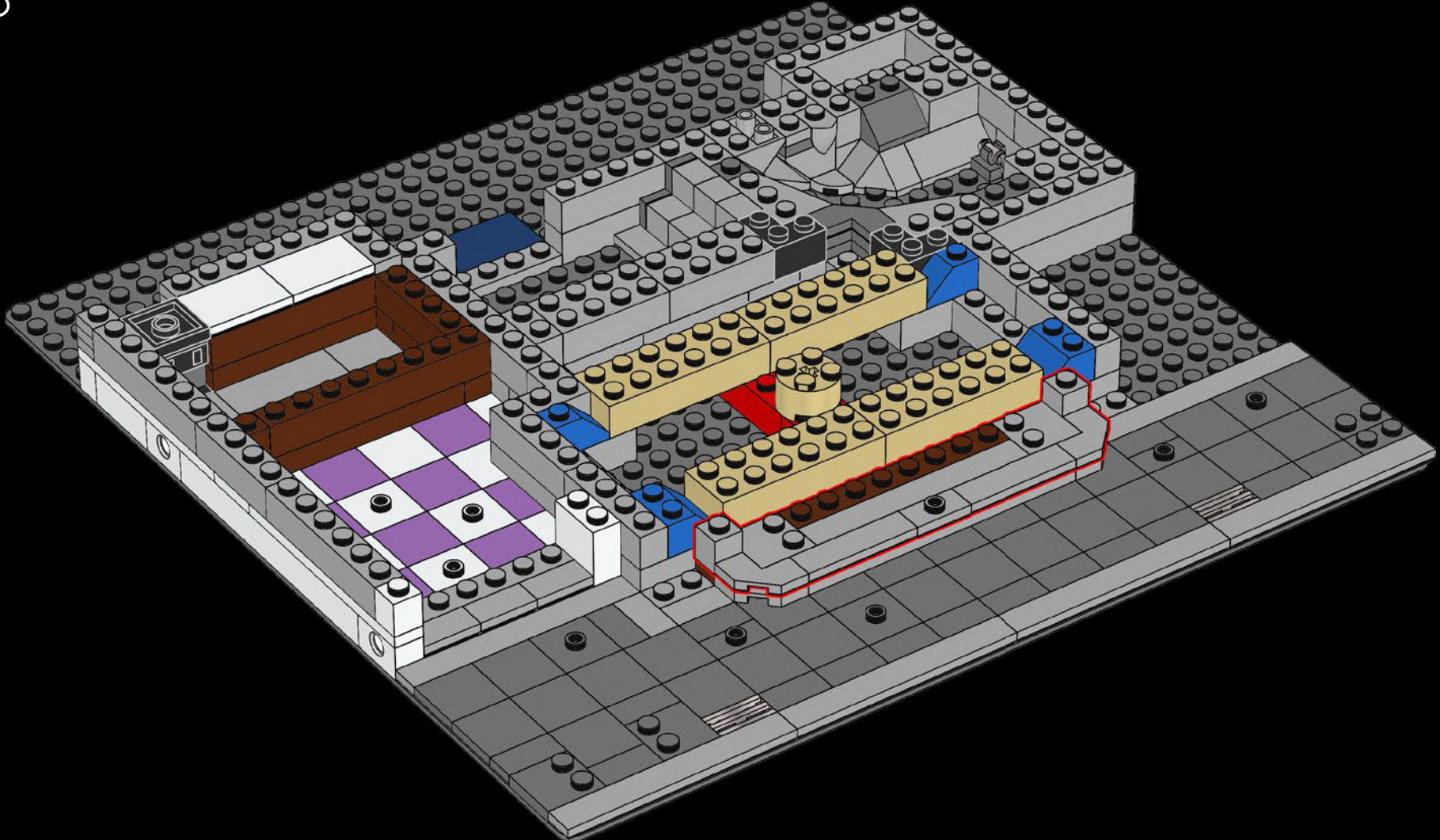



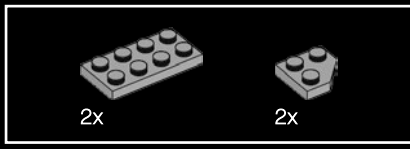

19

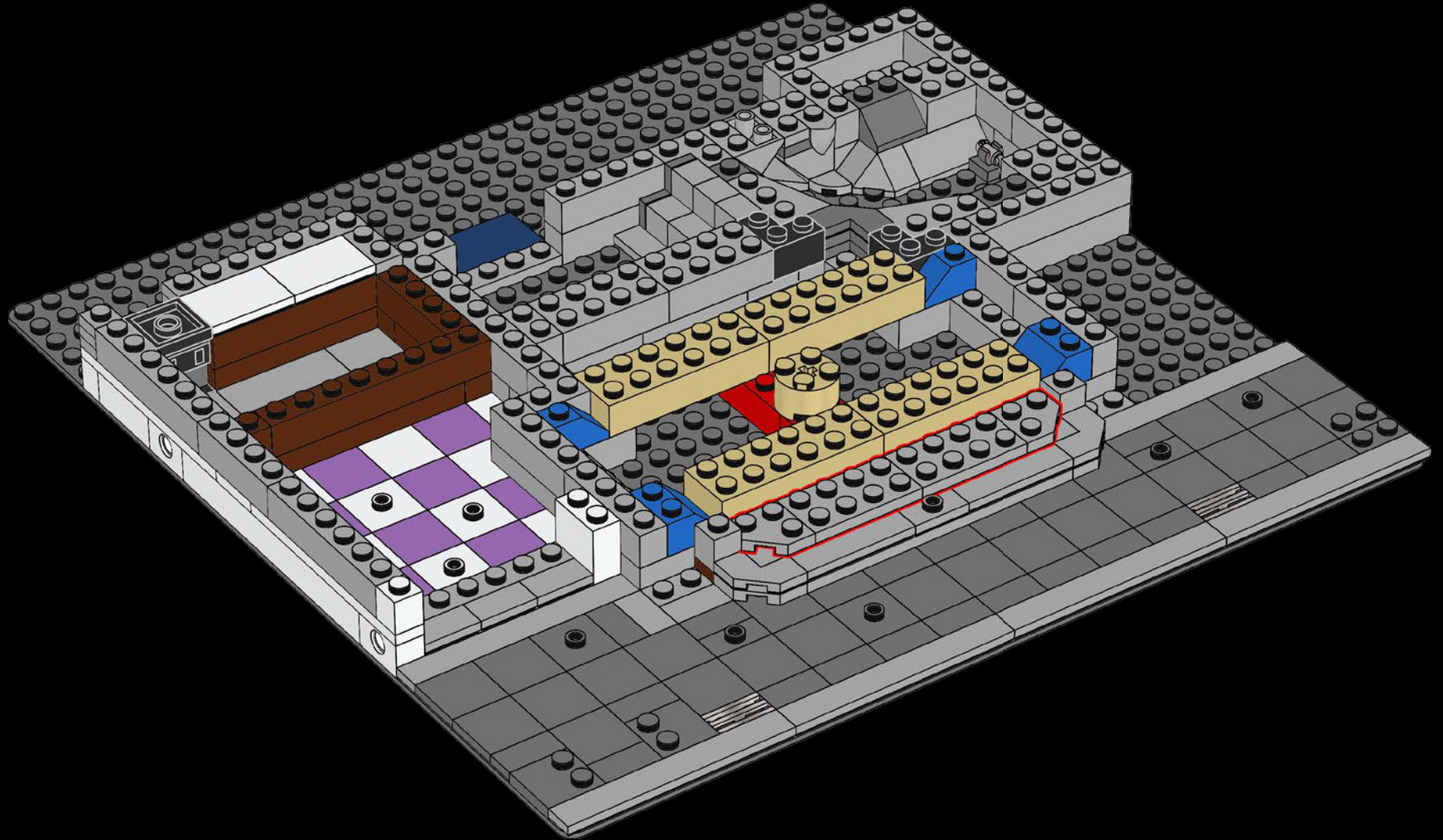



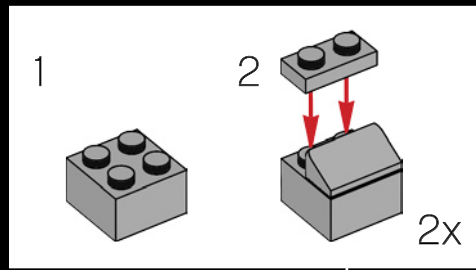
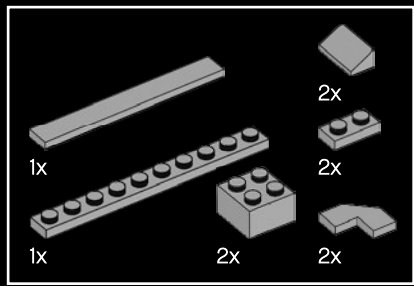

20

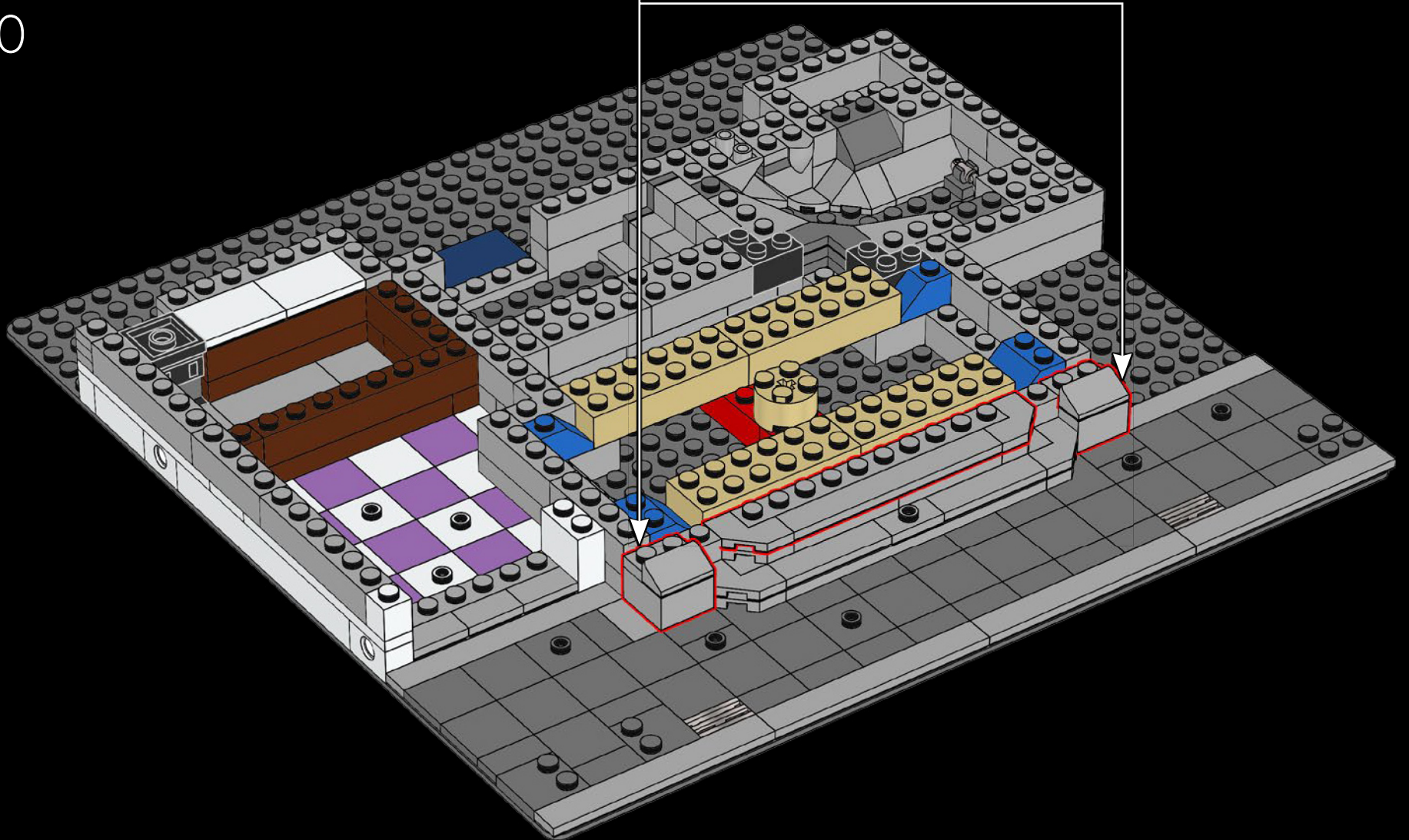

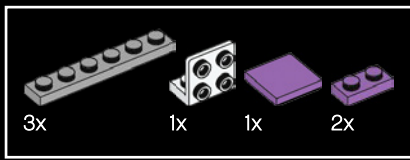

21

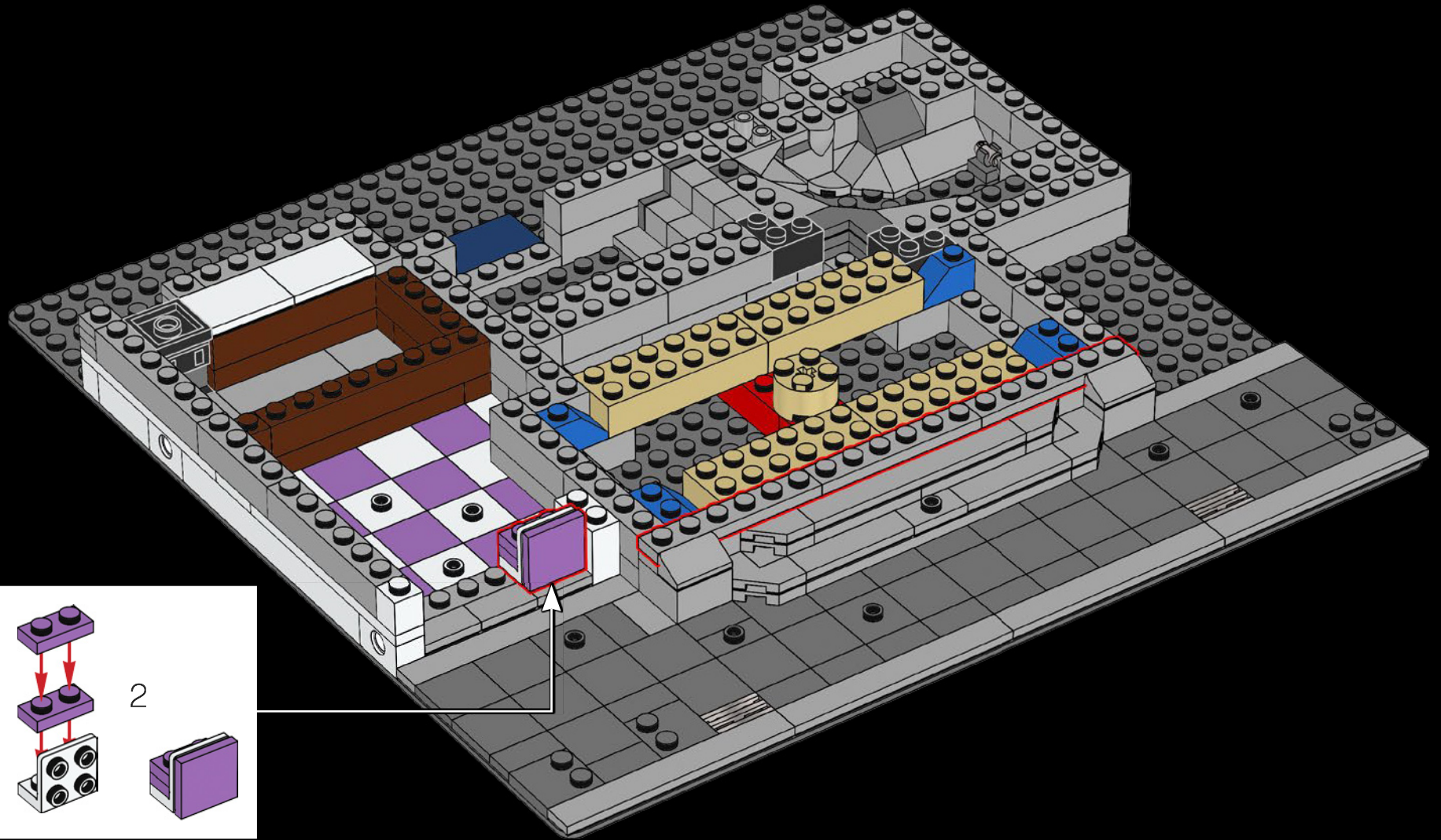







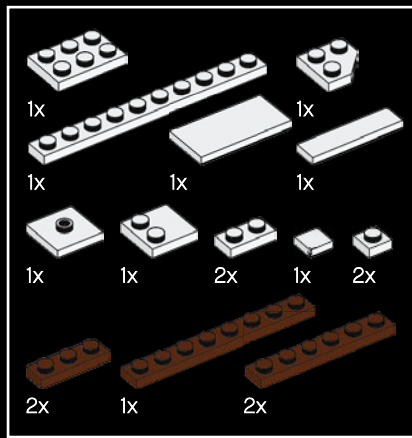

23

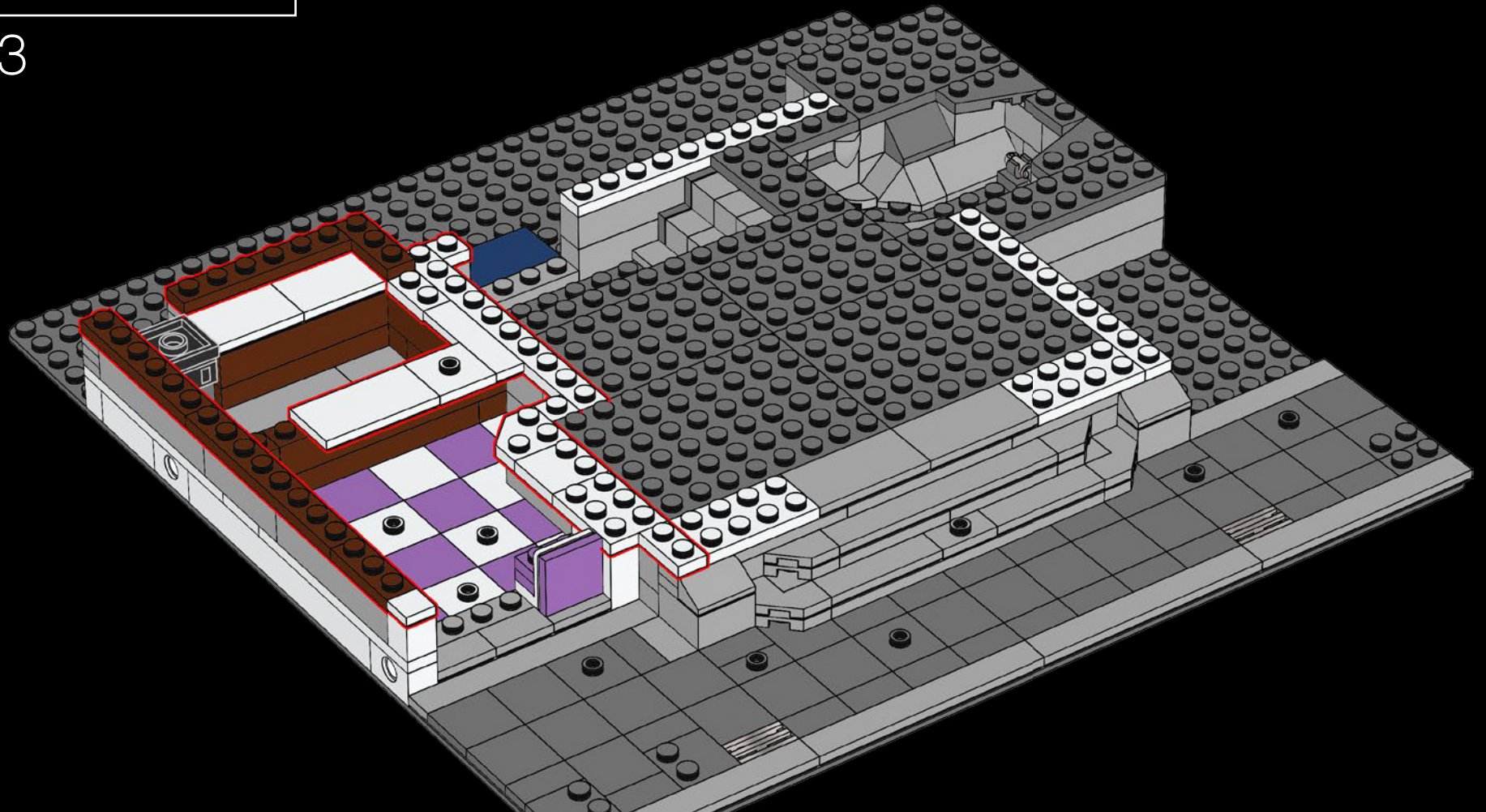

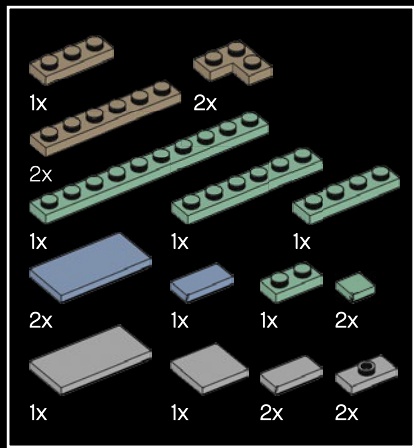

24

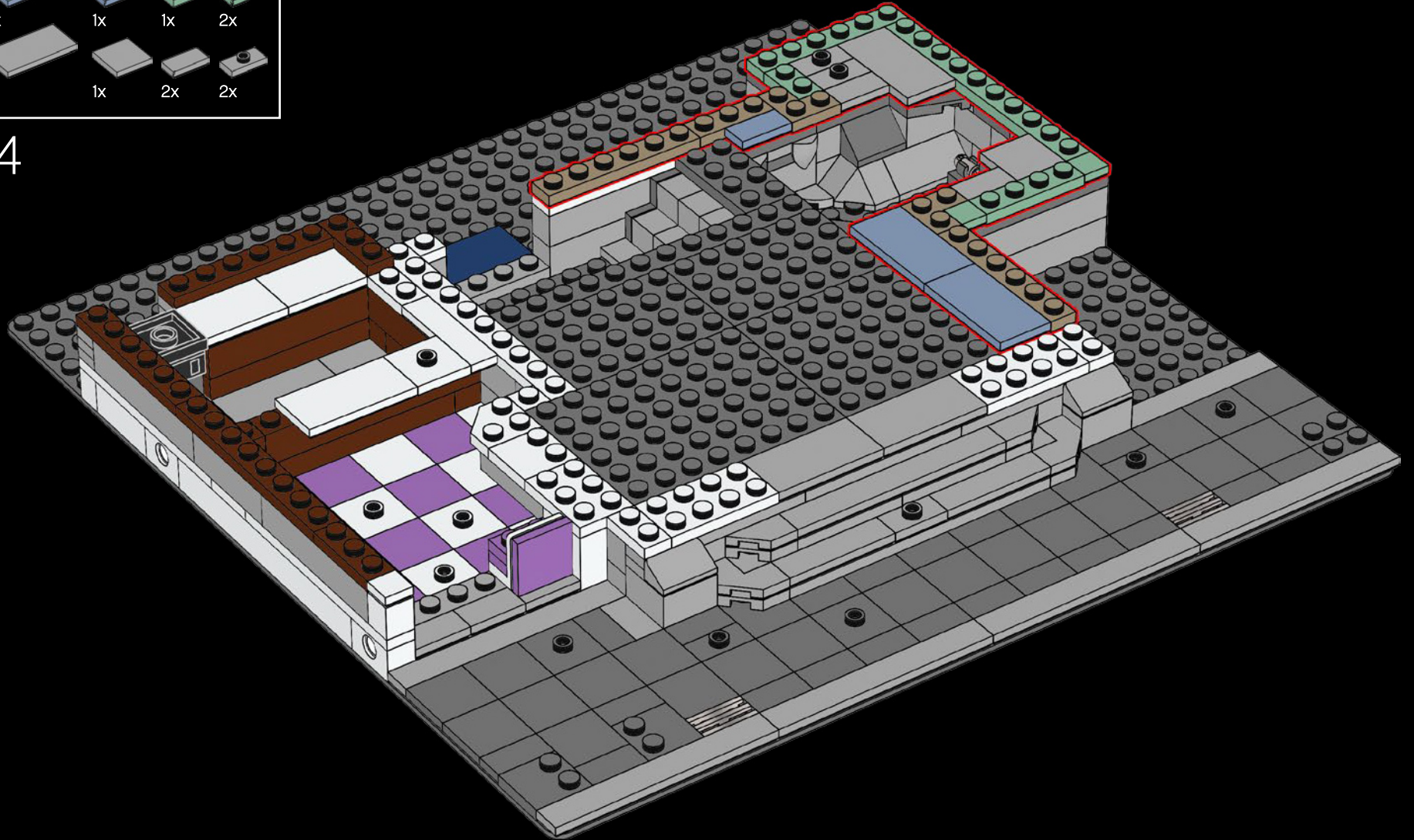



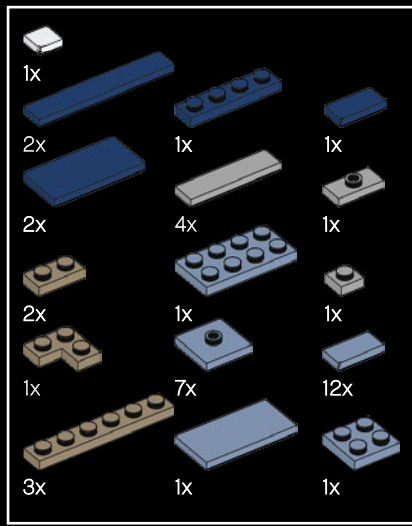

25

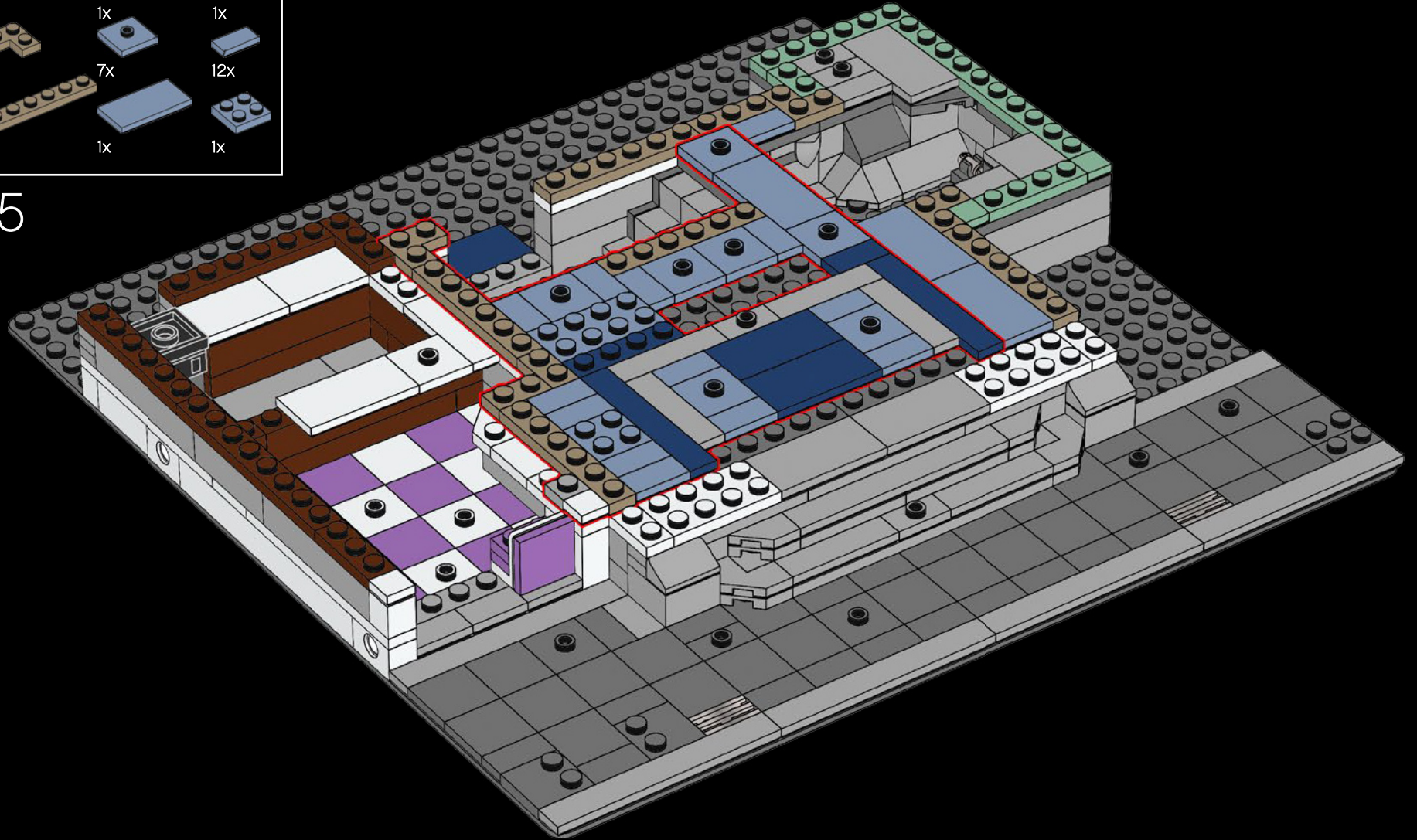

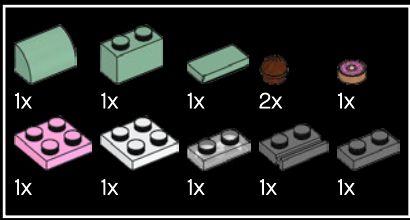

26

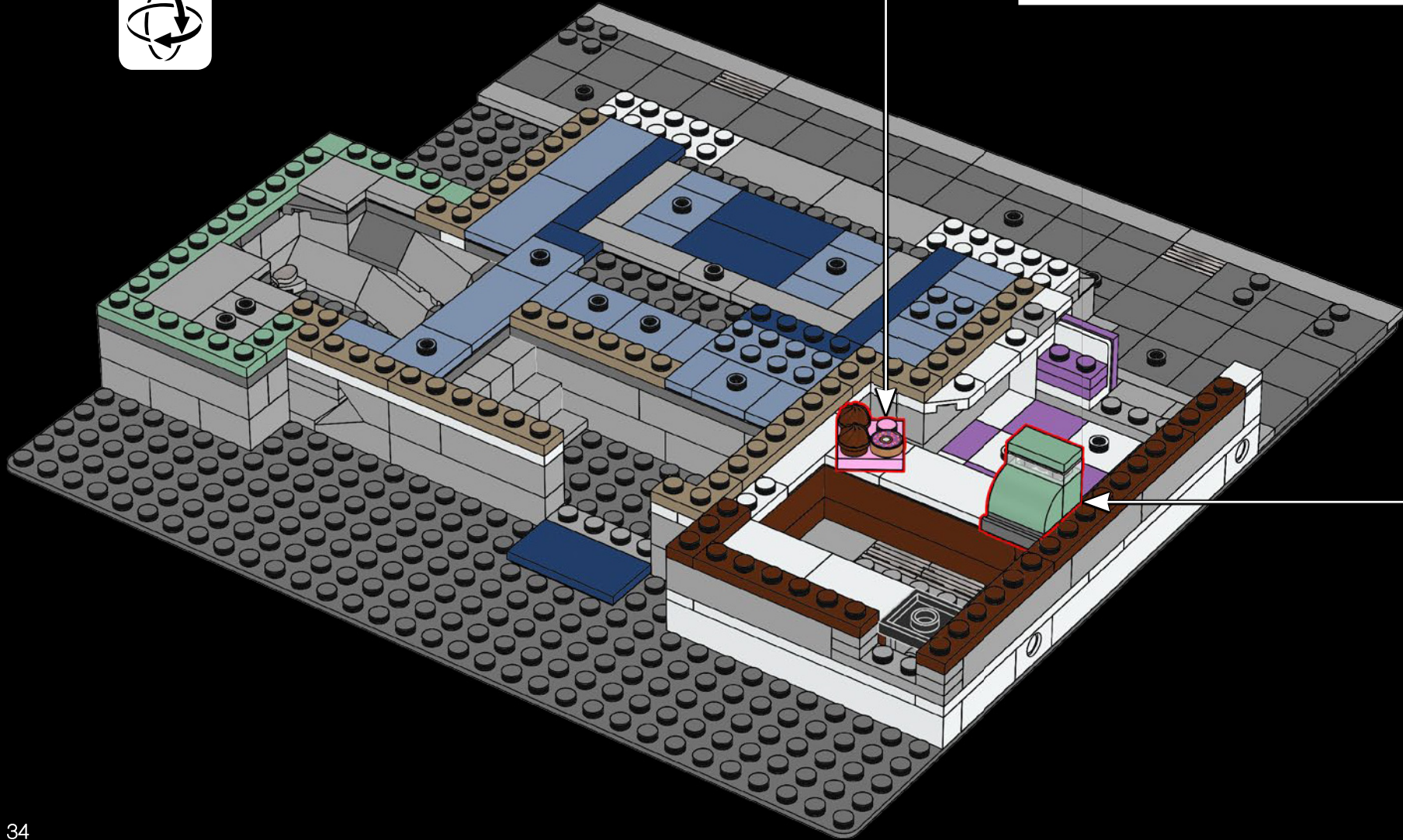
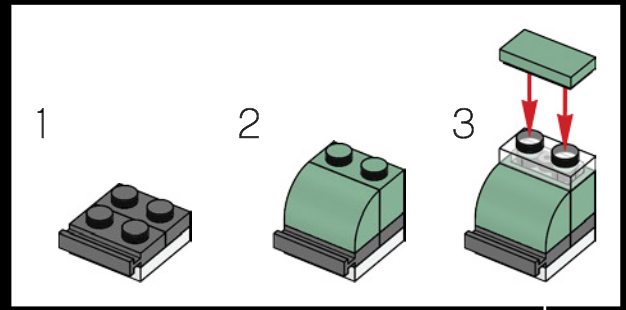
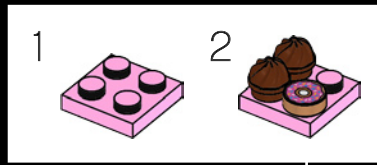



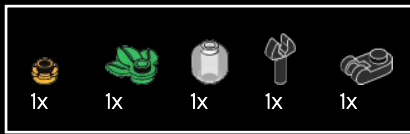

27

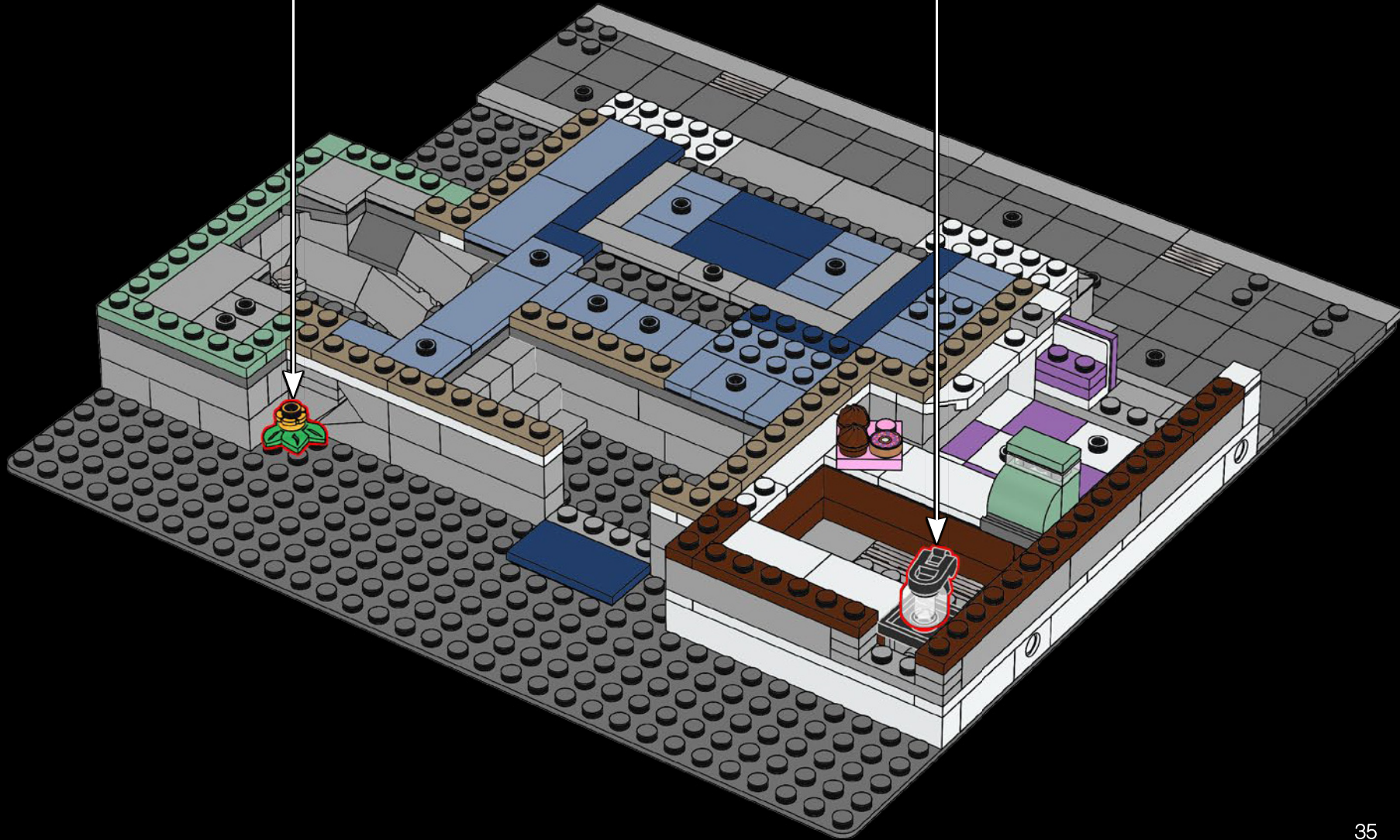
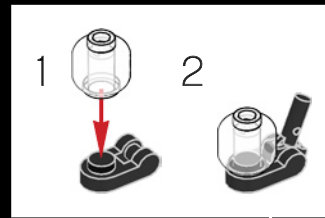
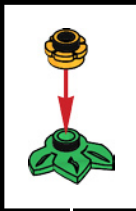

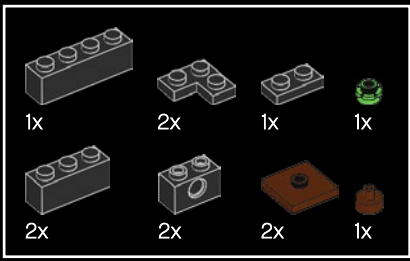

28

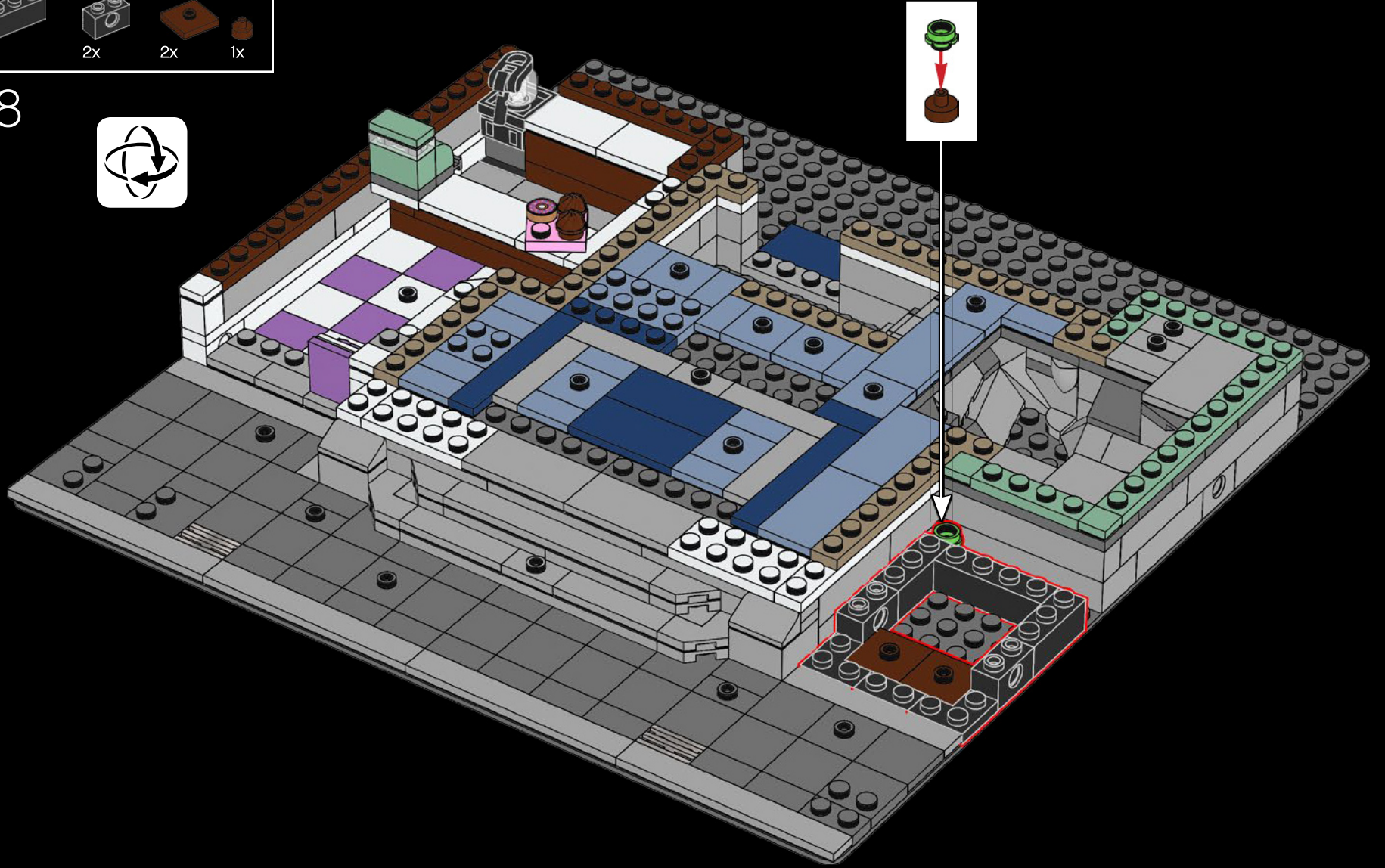



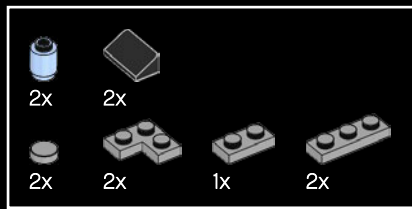

29

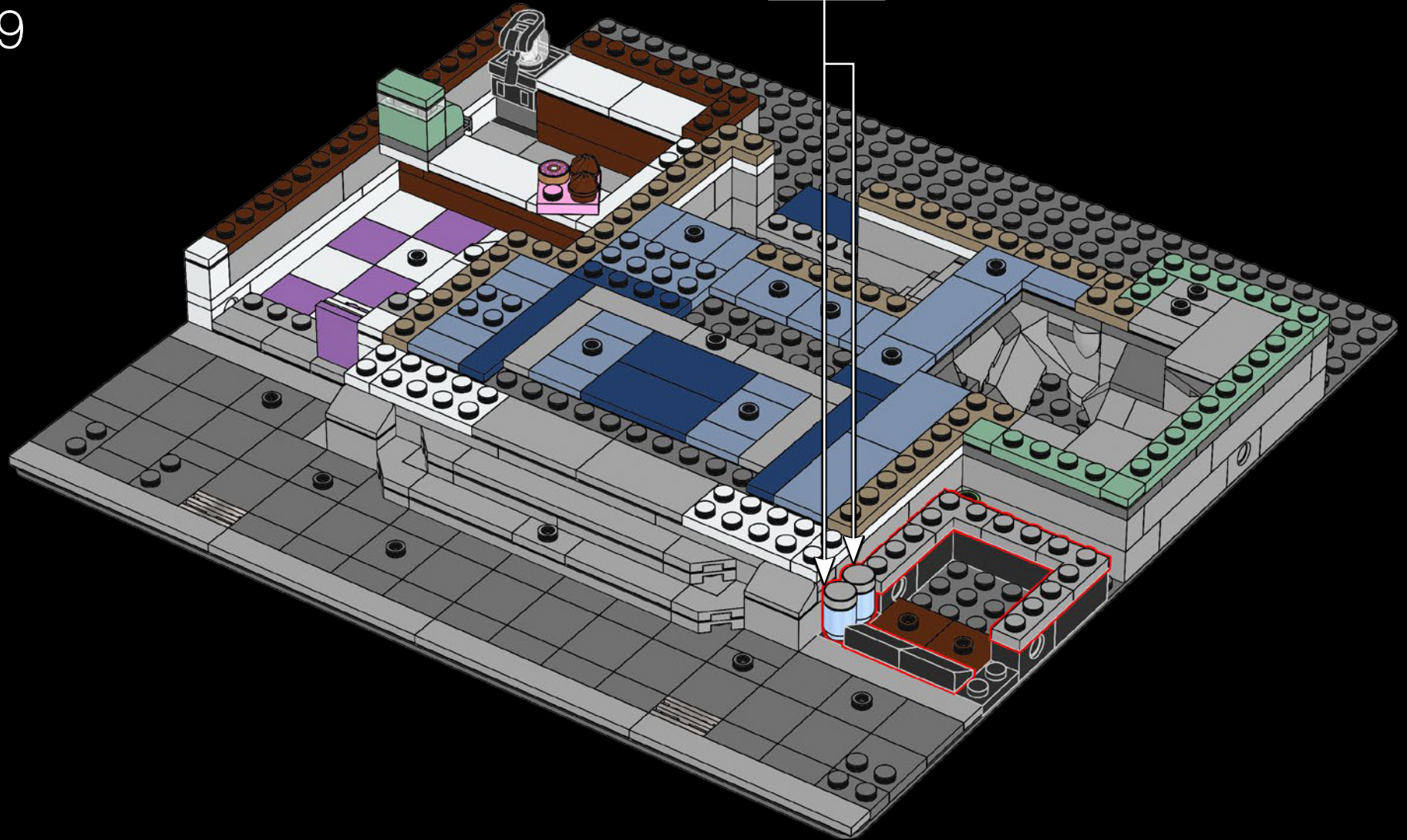
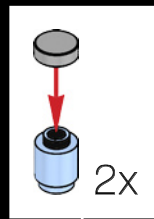

-  2x
-  2x
-  1x
-  2x
-  1x

30

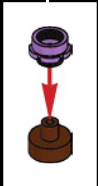
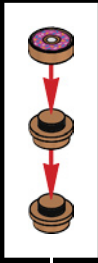
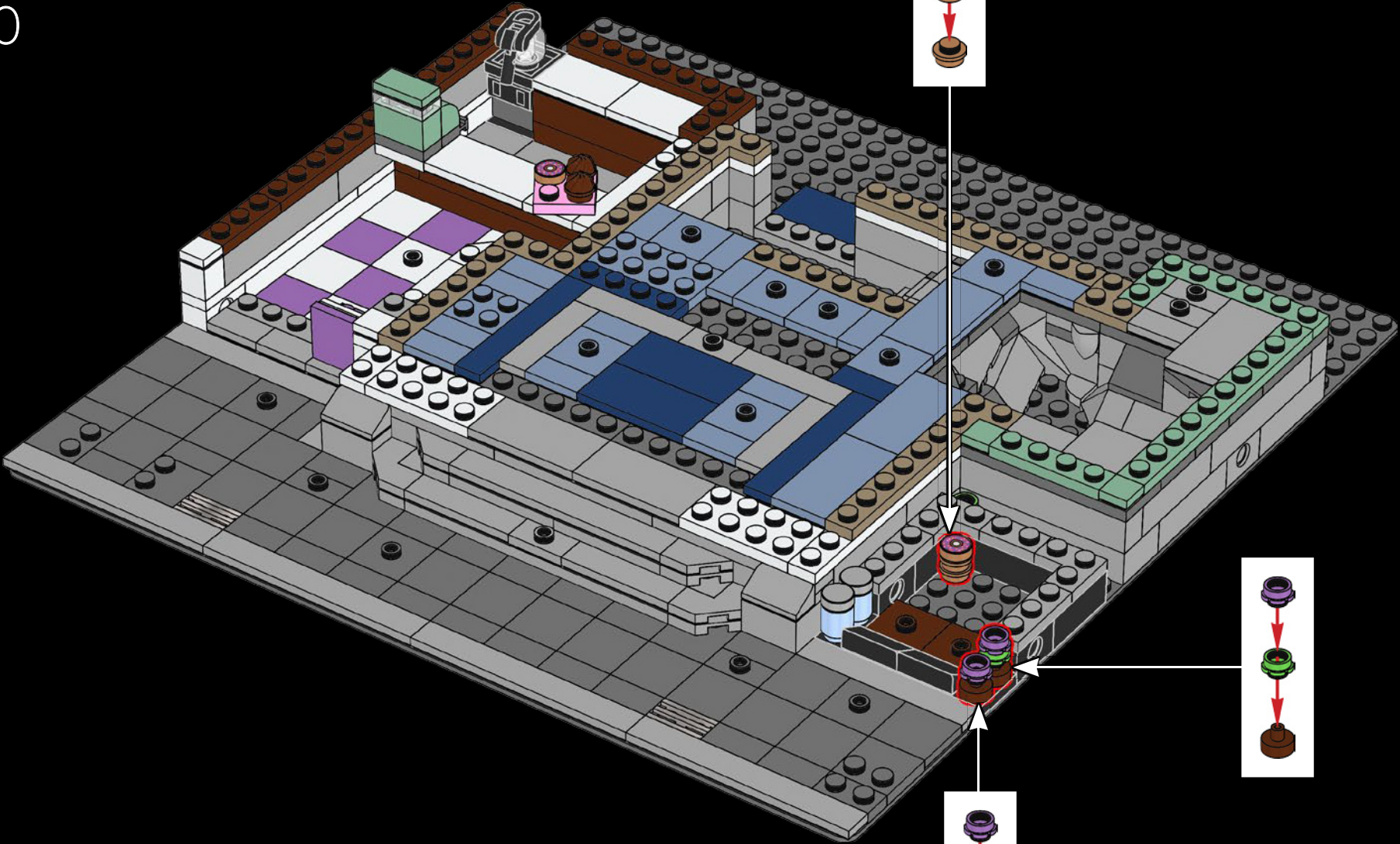



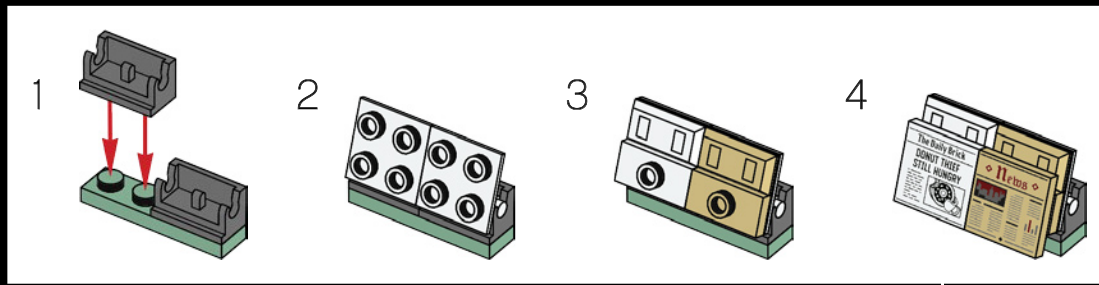
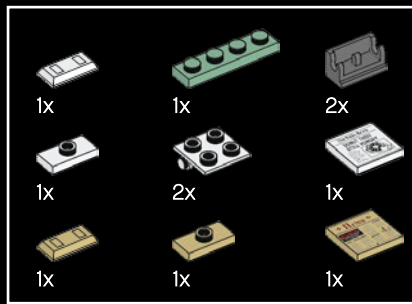

31

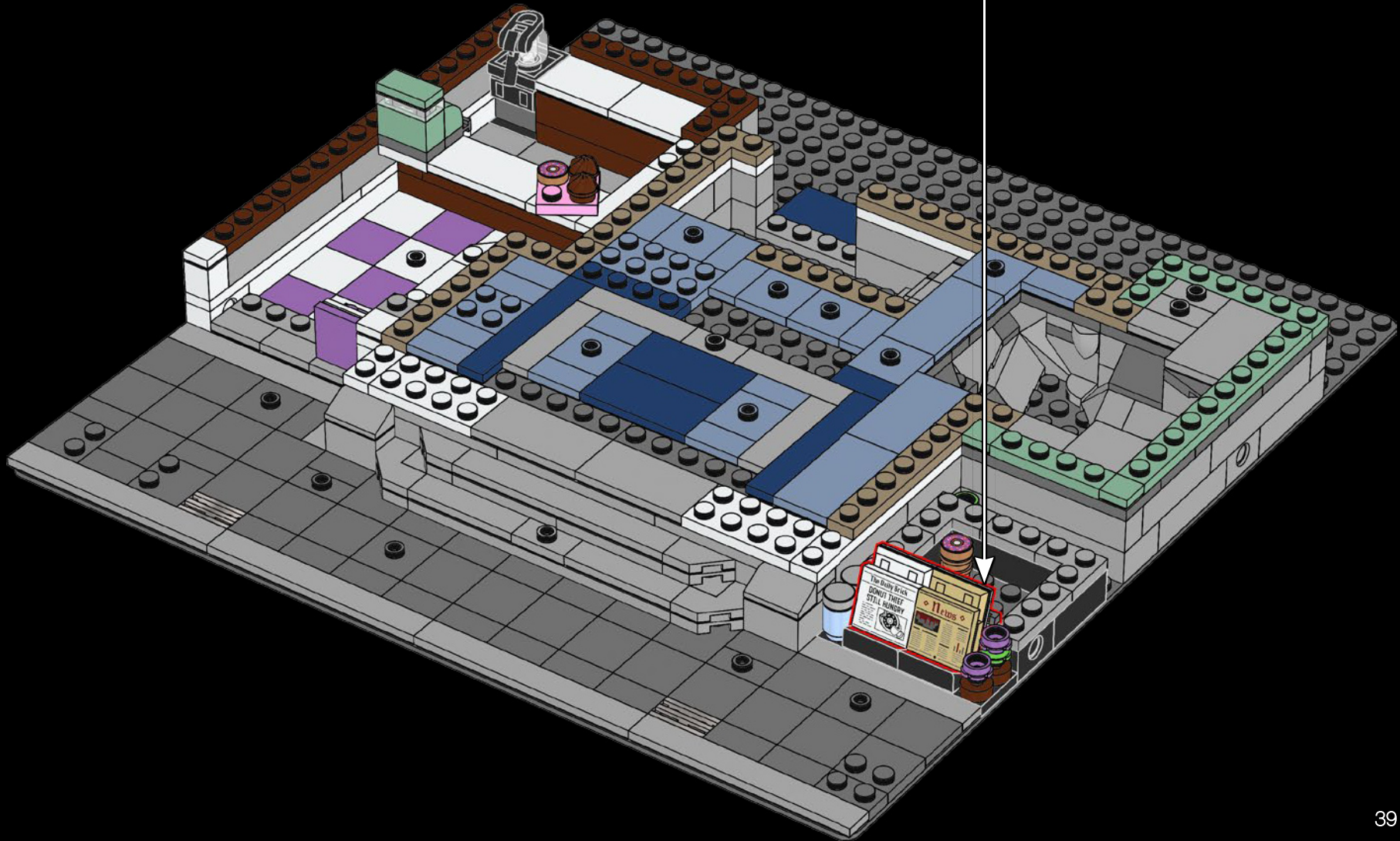

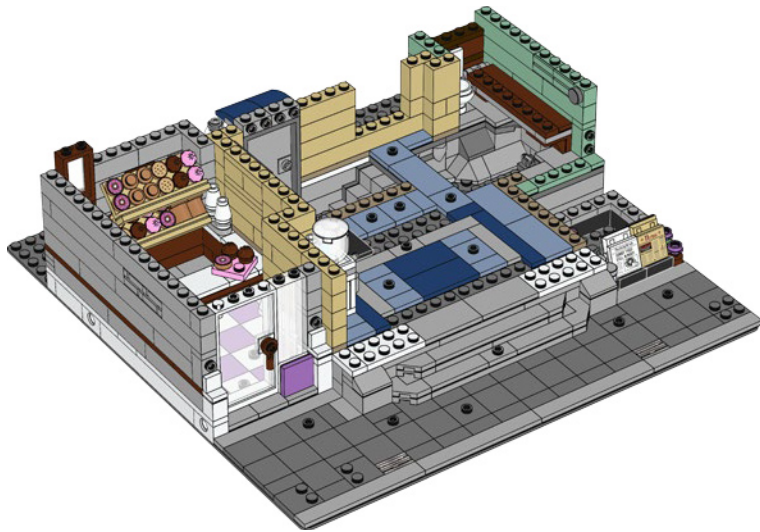

- Our good-natured shop owner runs the delicious donut shop.
- La joviale propriétaire dirige la délicieuse beignerie.
- Nuestro bondadoso tendero administra la encantadora tienda de donas.

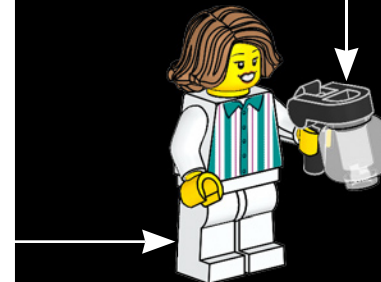
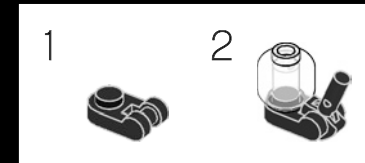
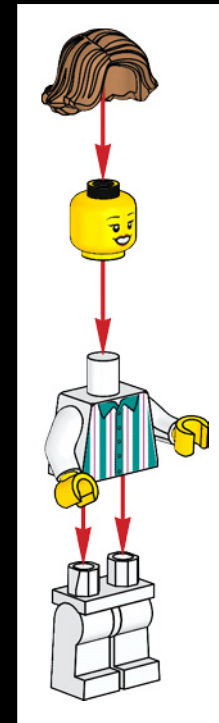



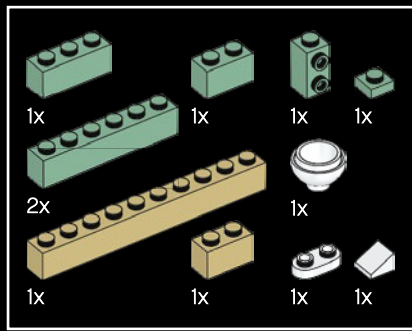

32

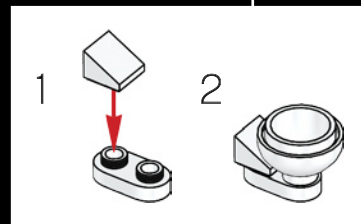
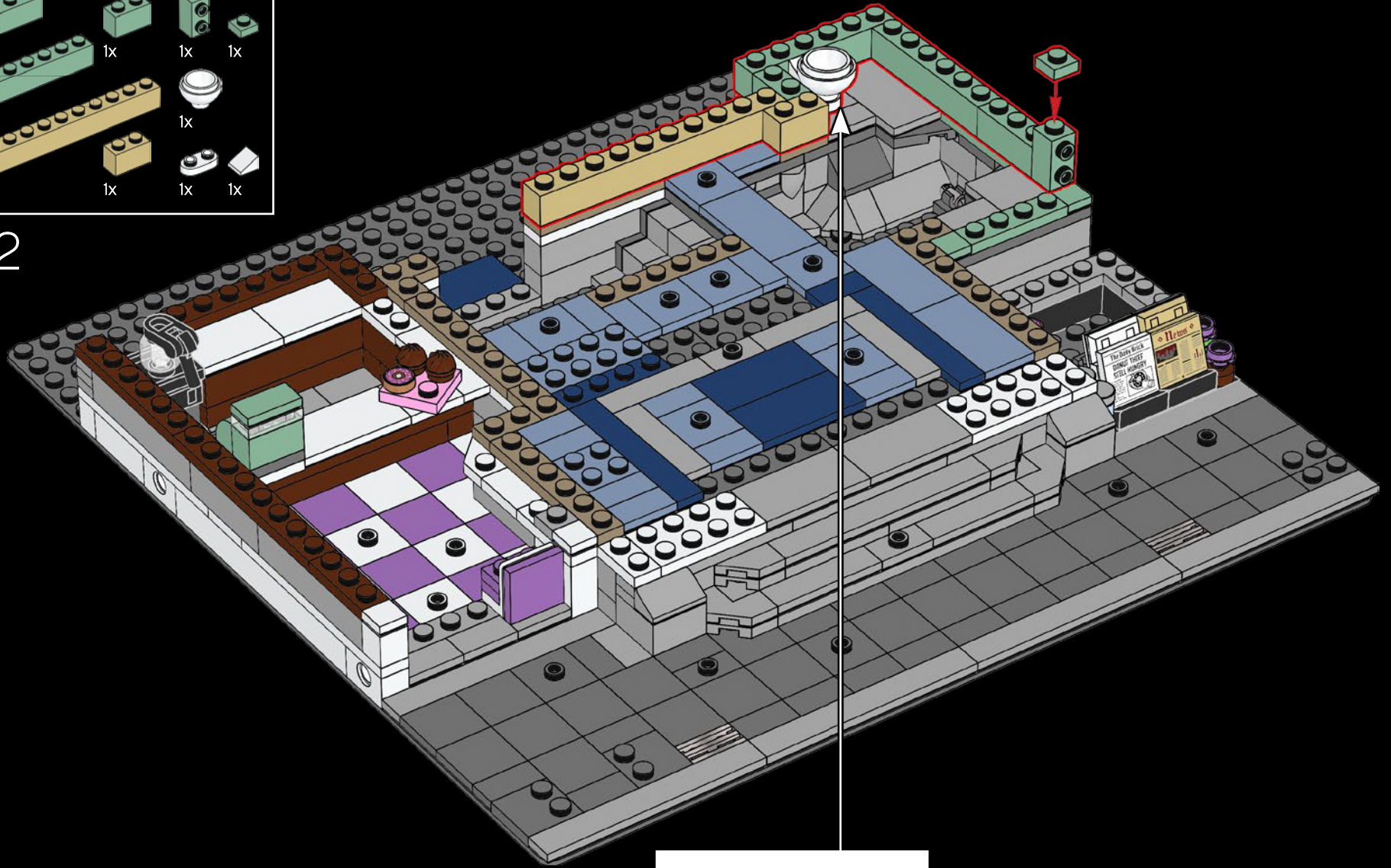

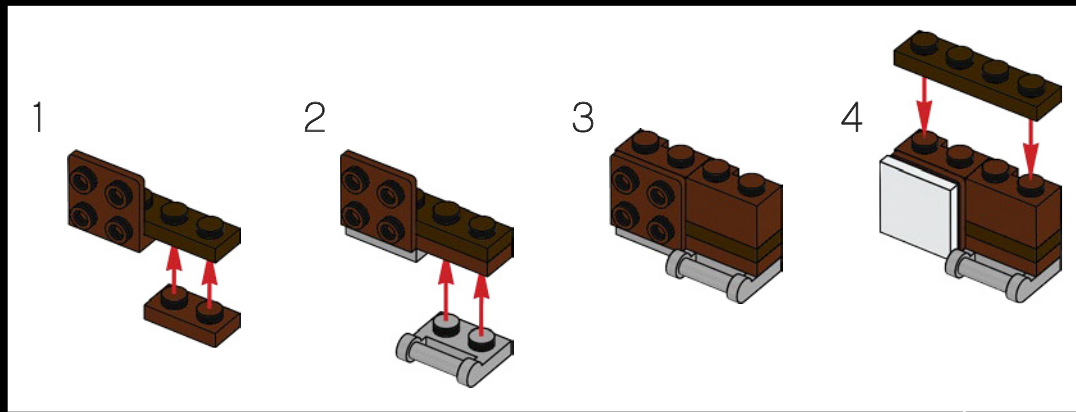
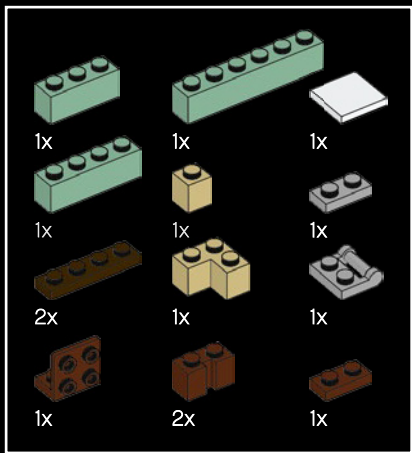

33

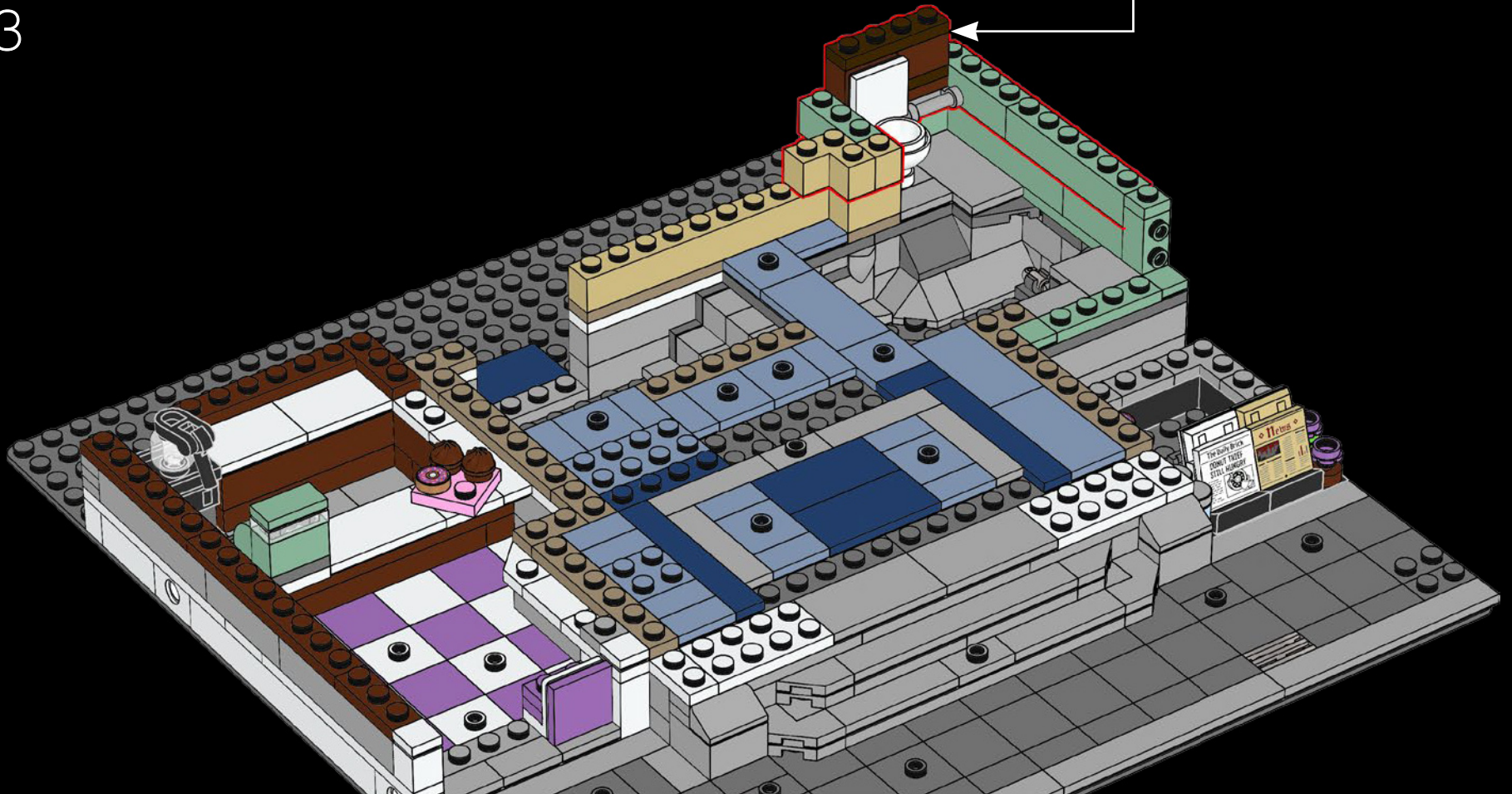



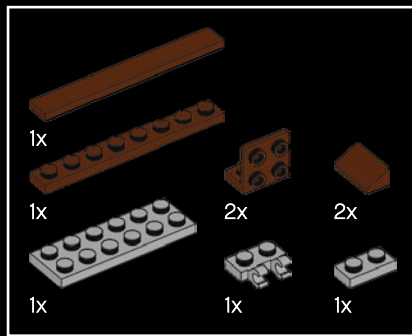

34

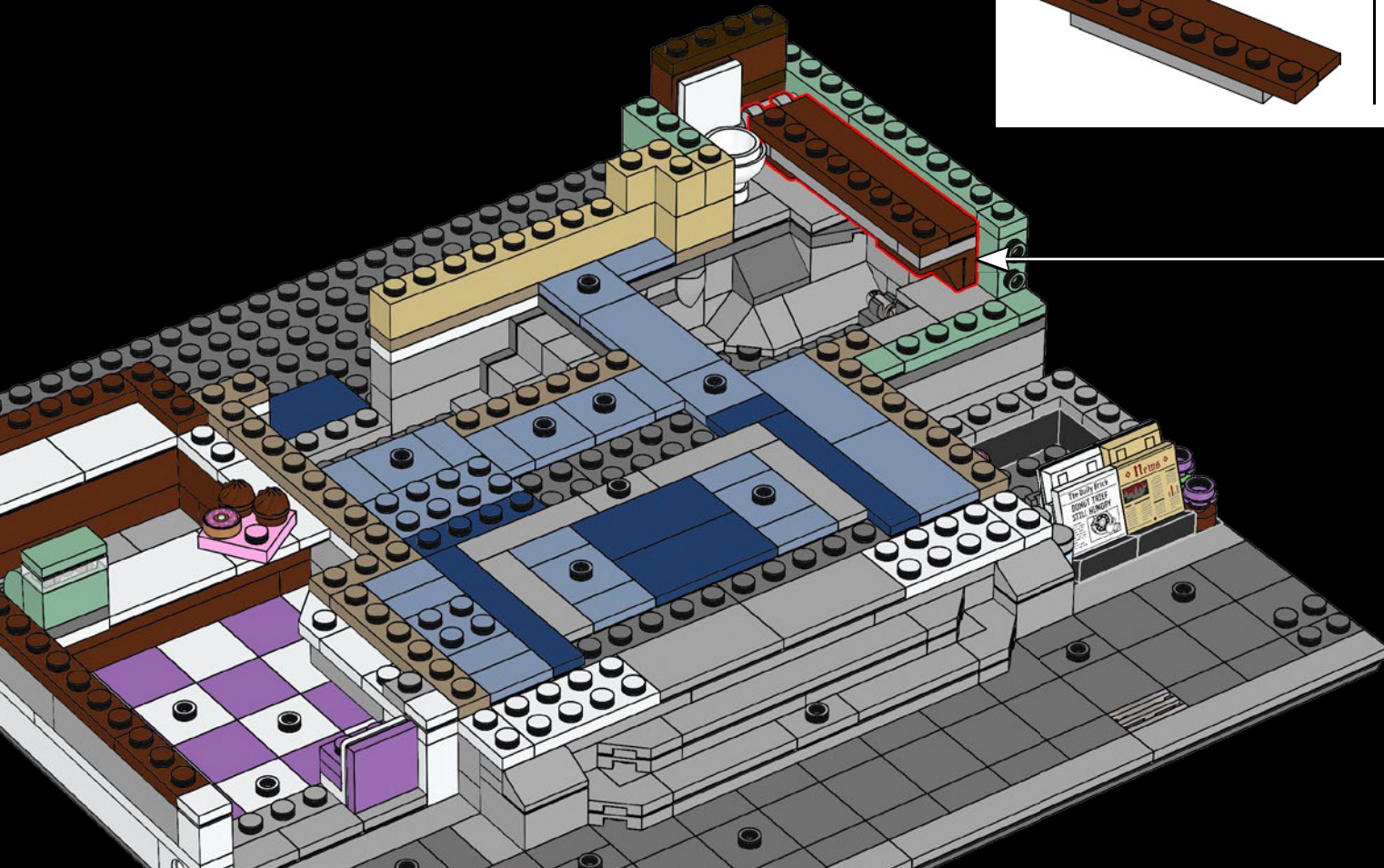
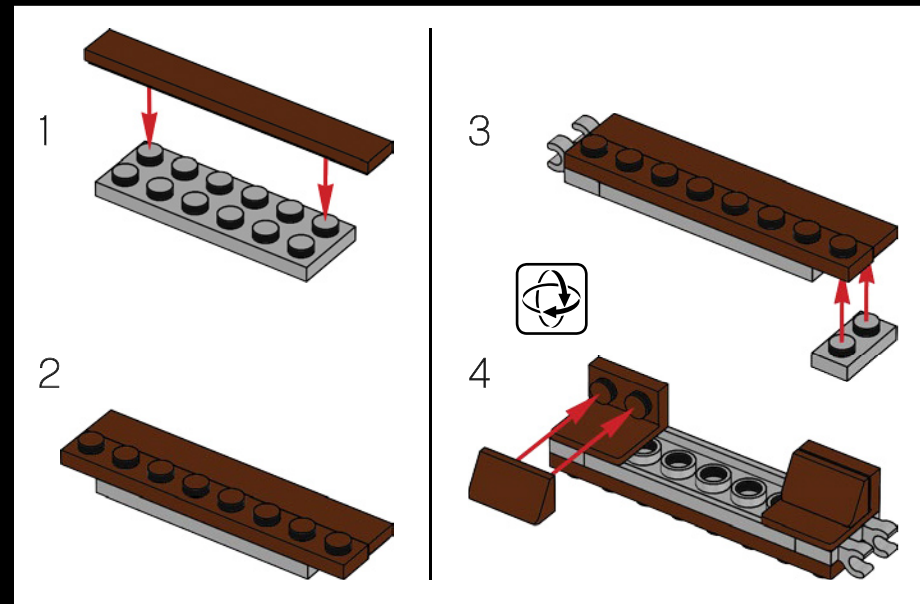

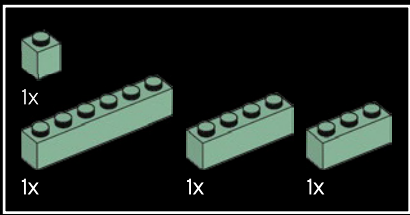

35

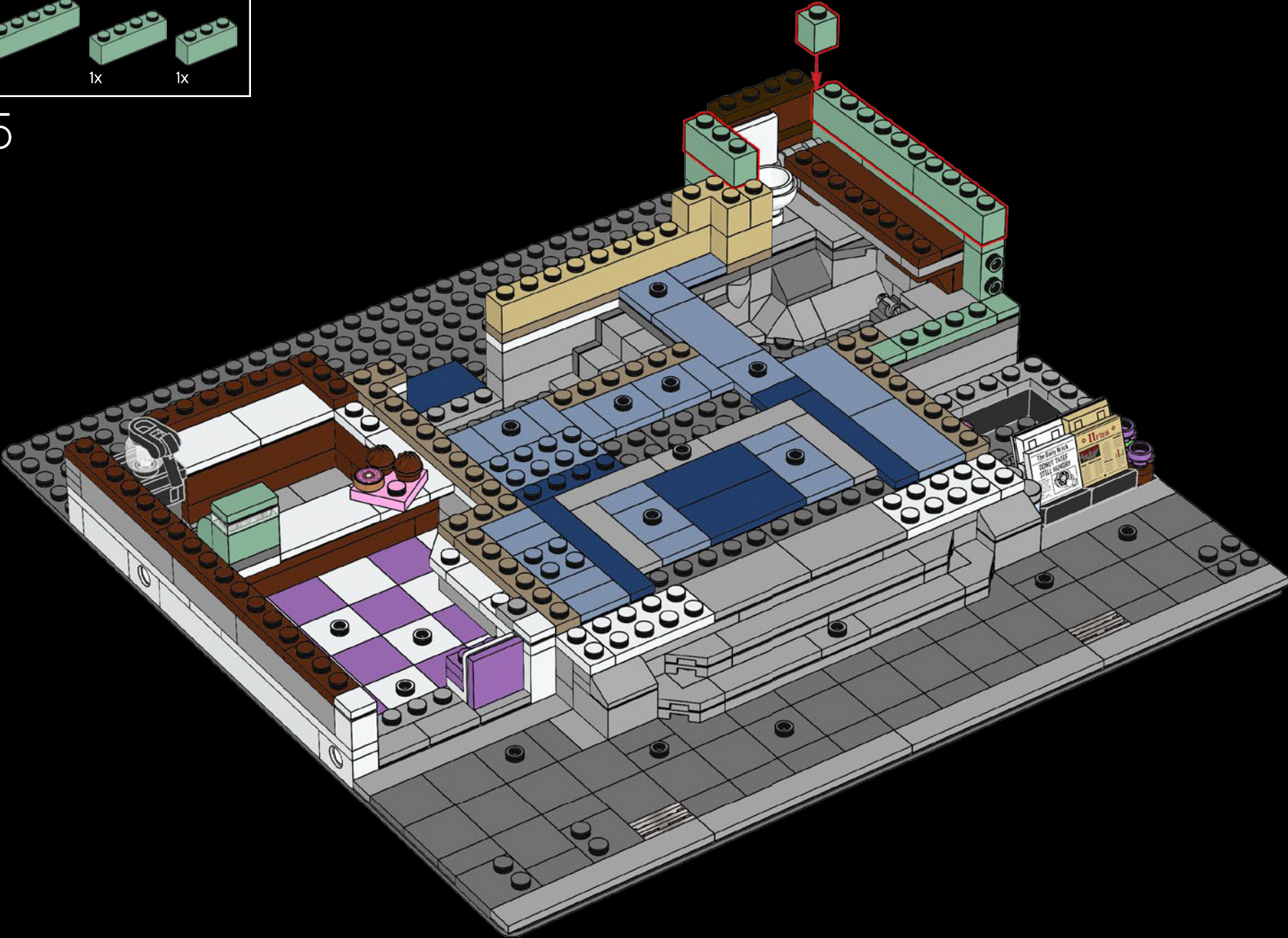



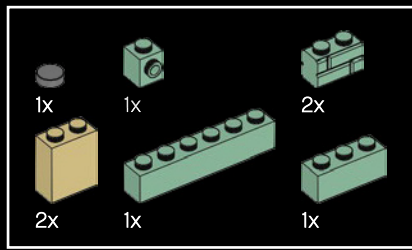

36

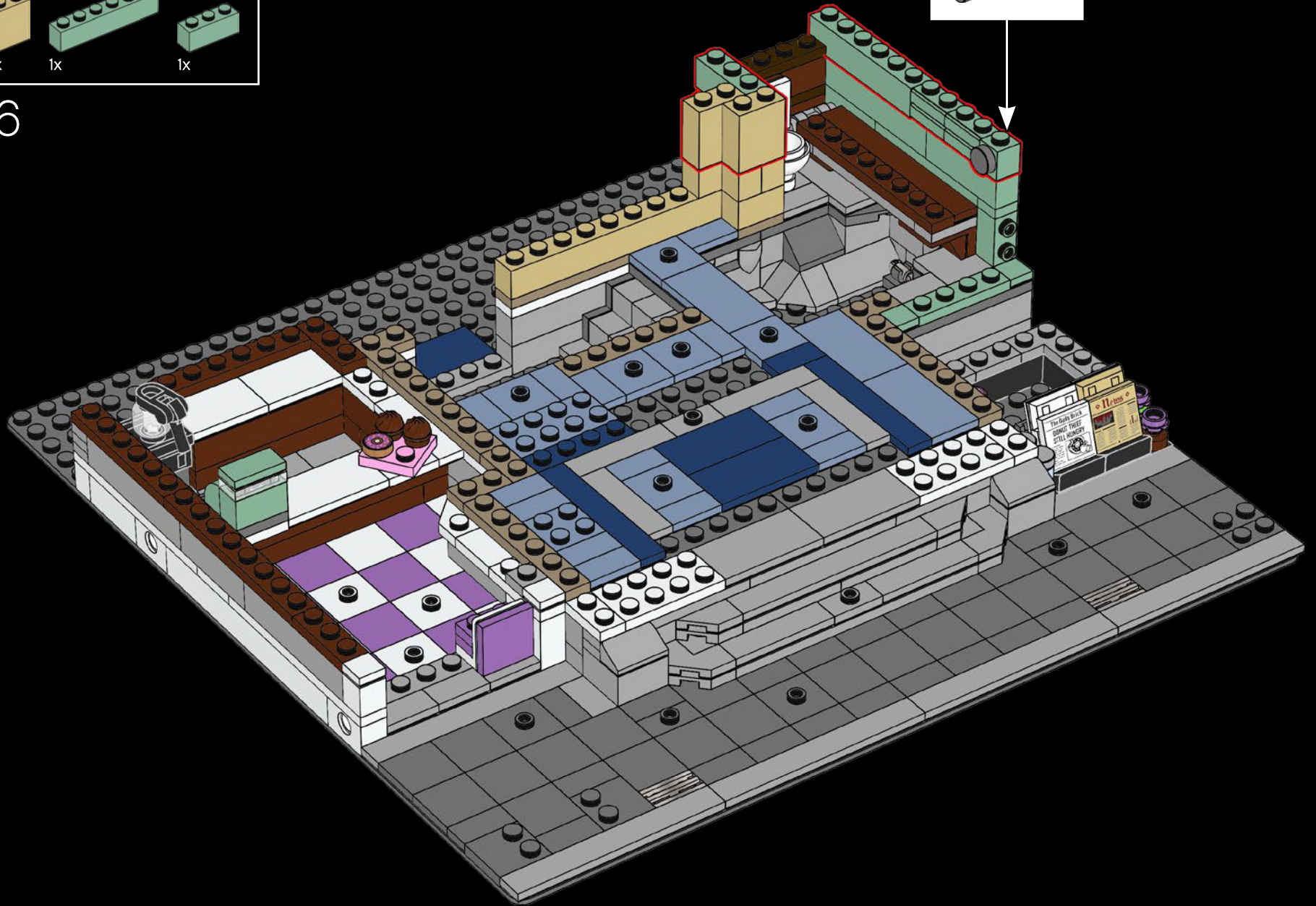
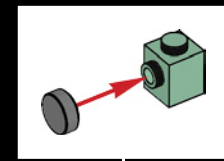





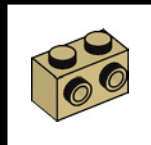
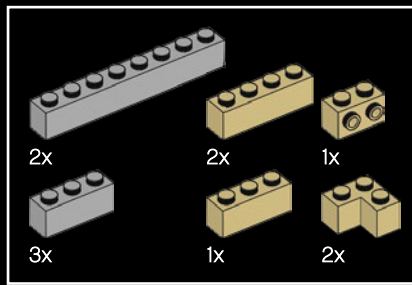

38

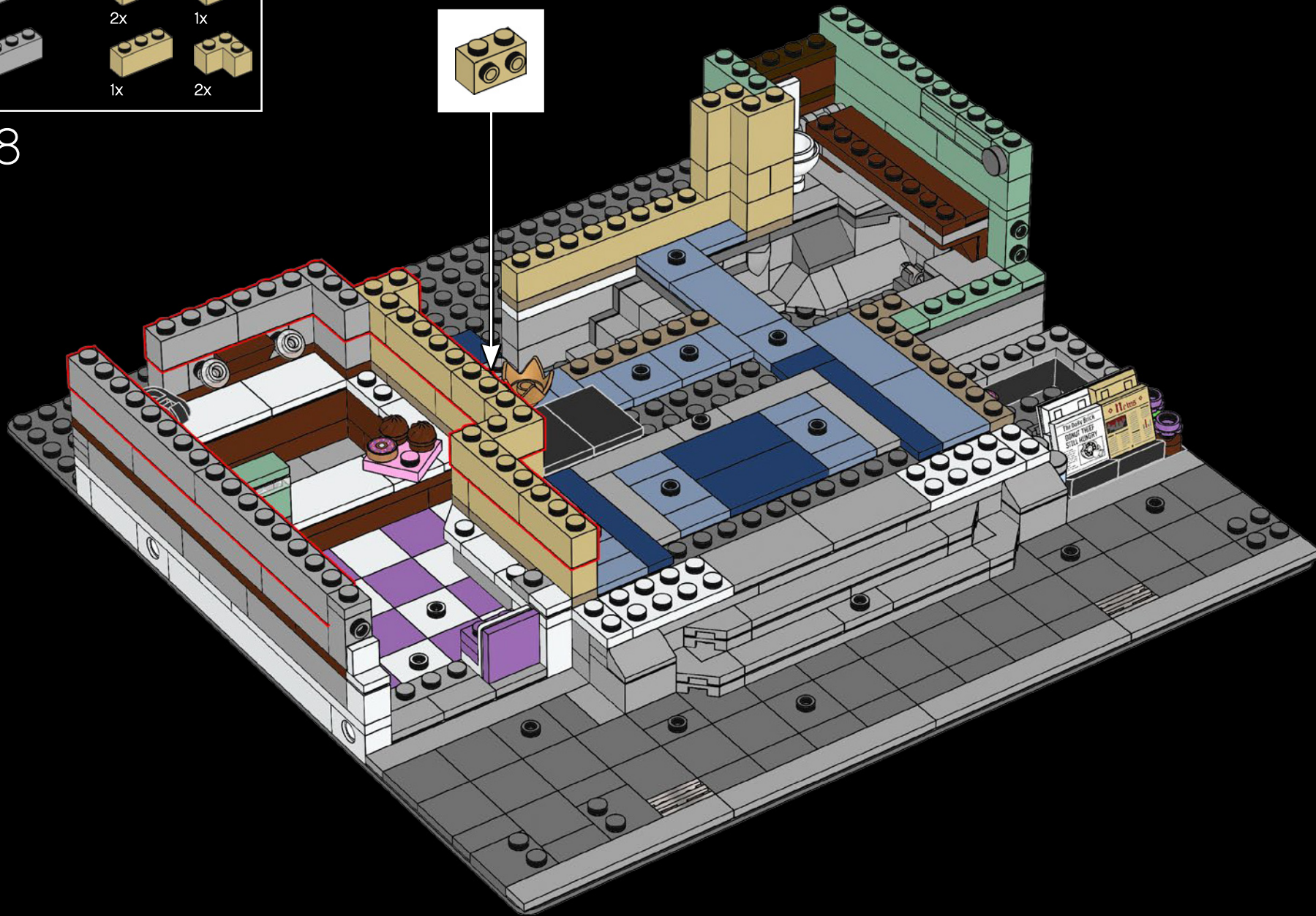





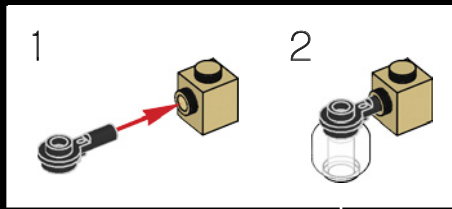
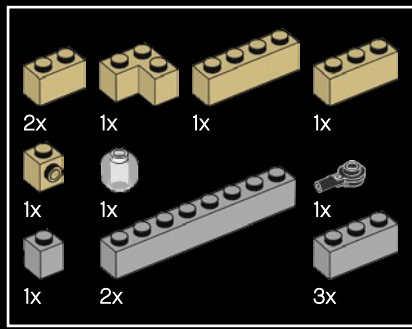

40

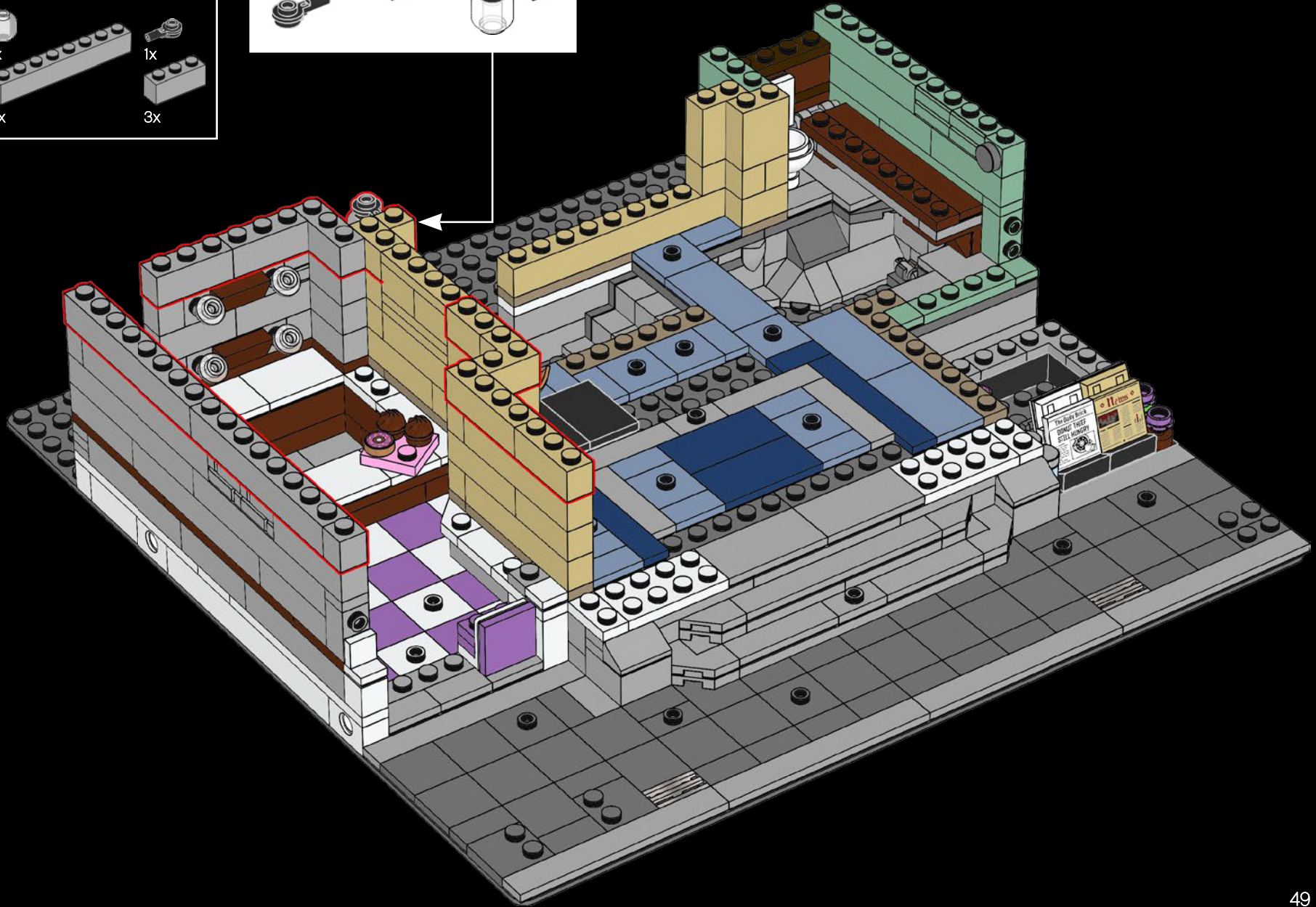



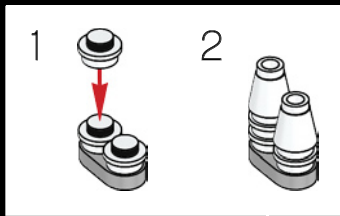
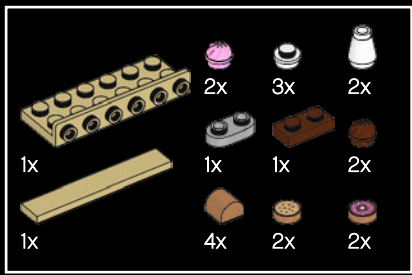

41

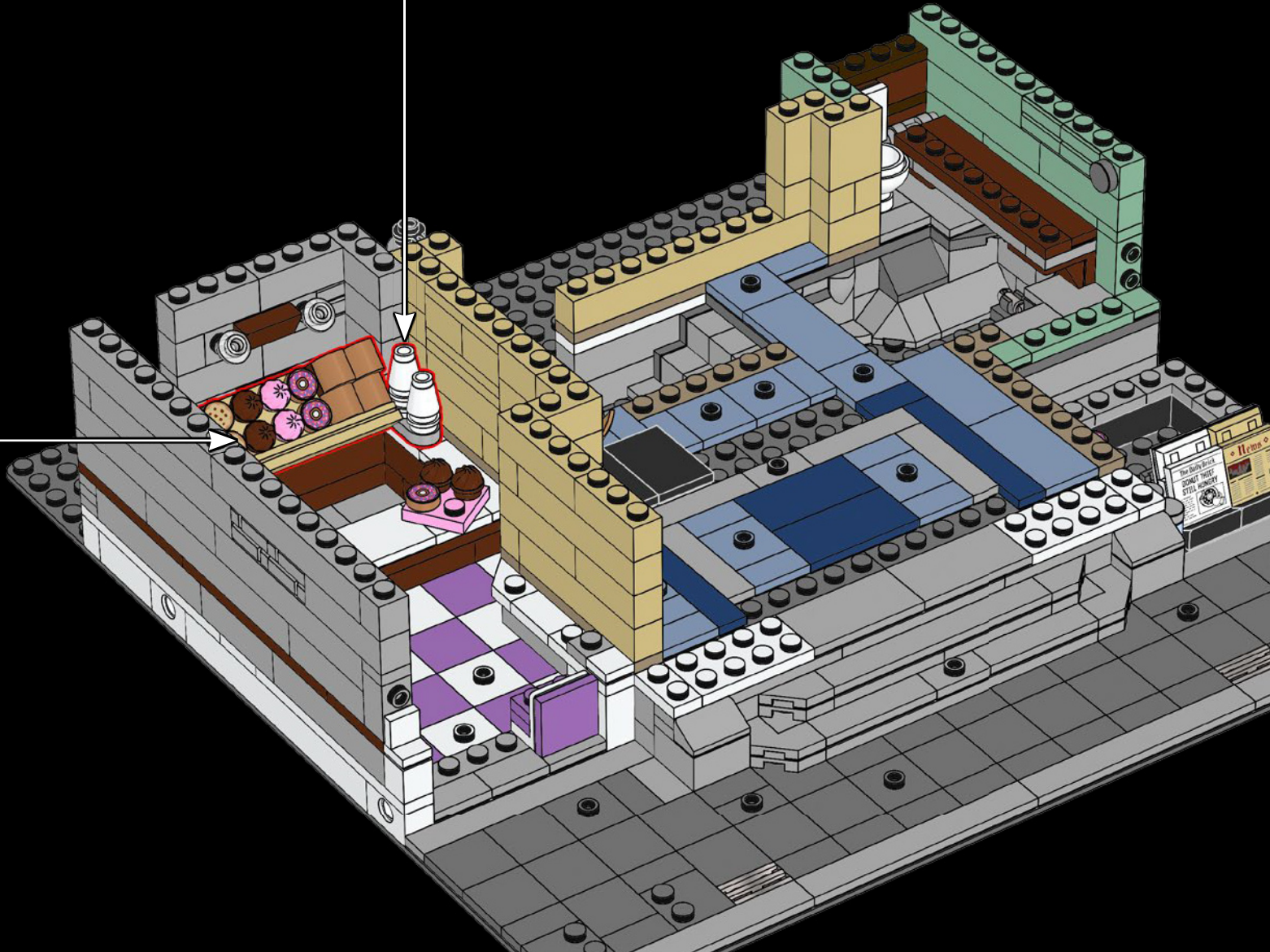
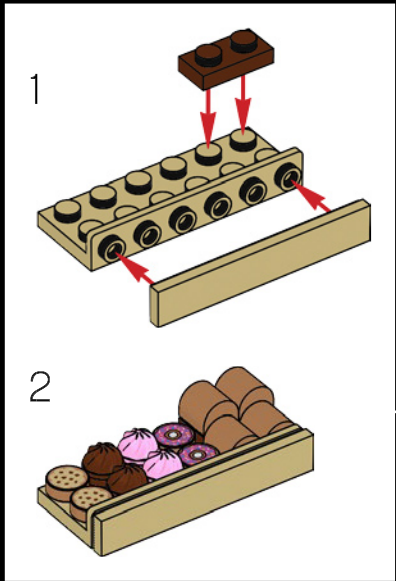



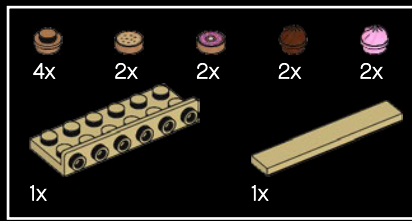

42

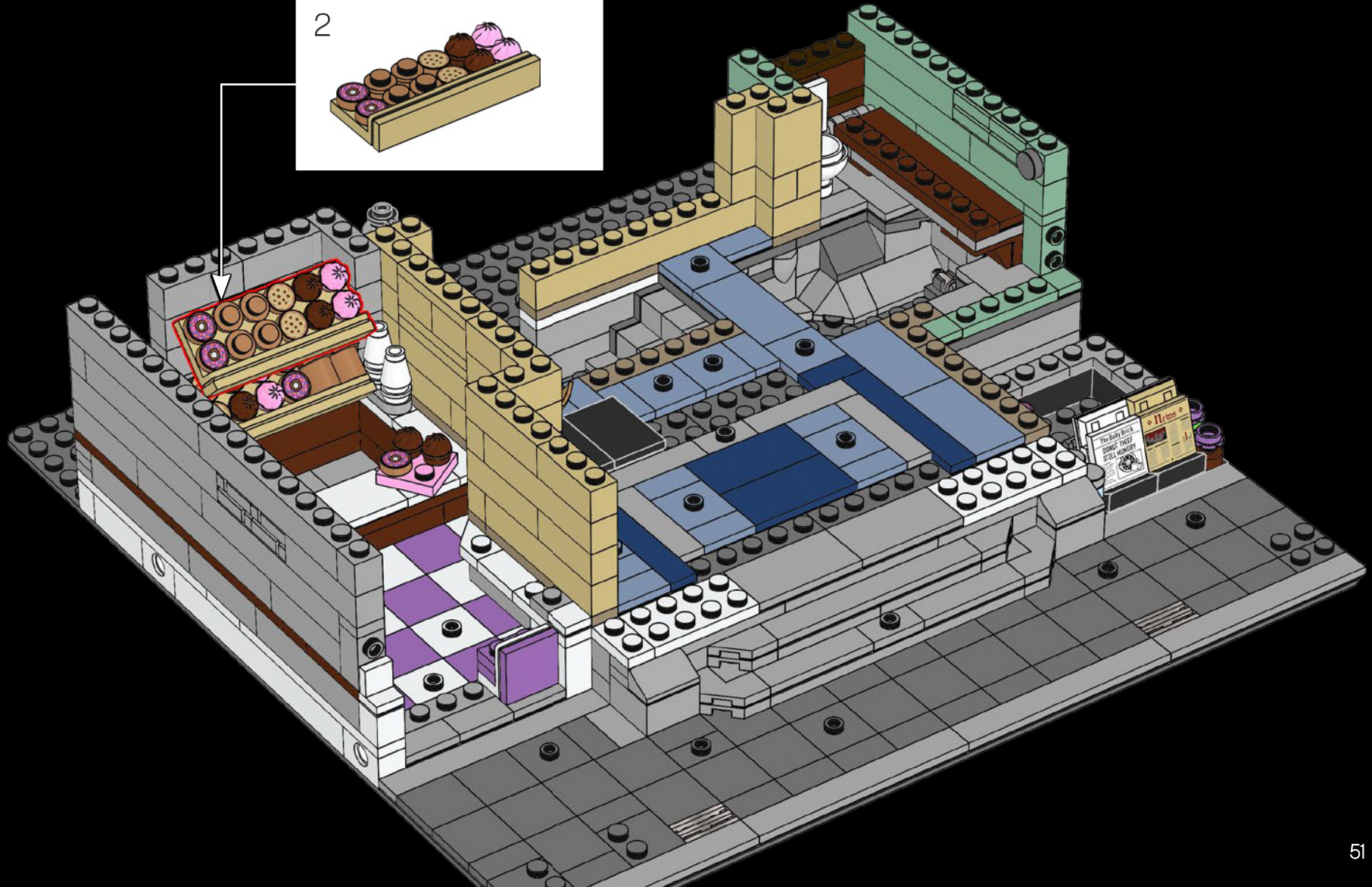
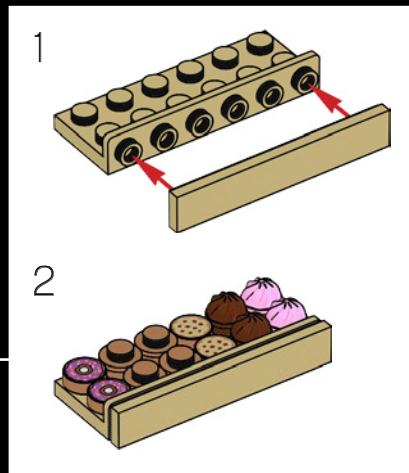

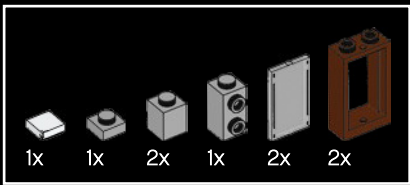

43

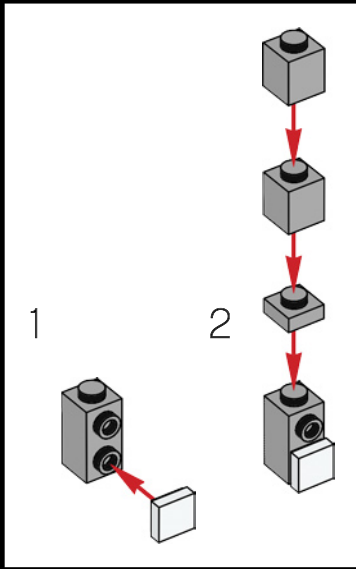
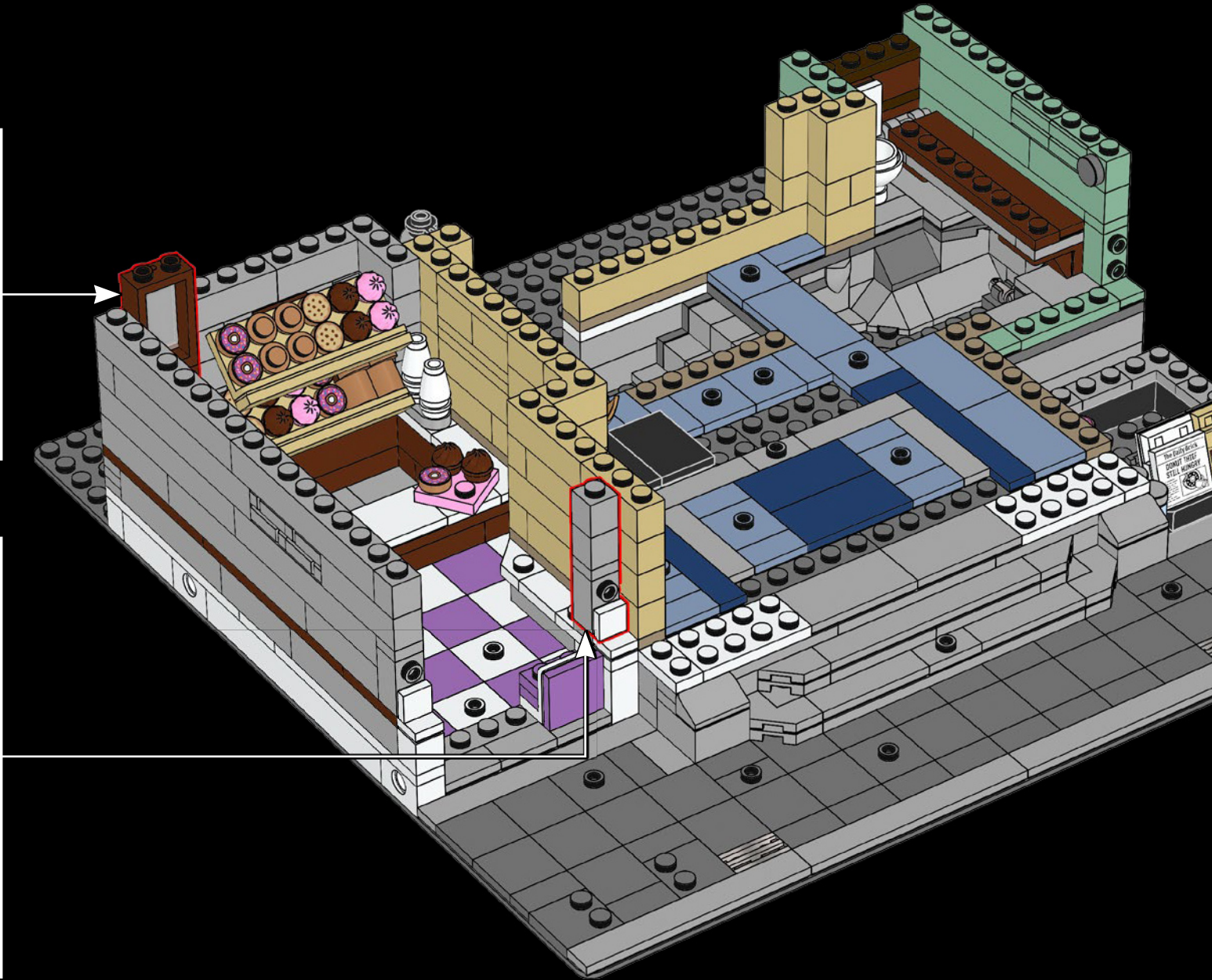
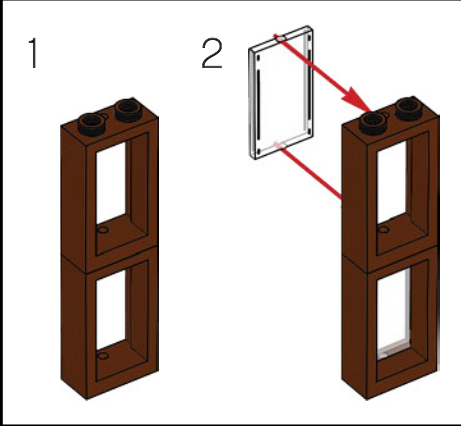



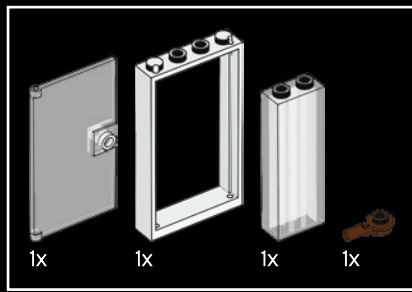

44

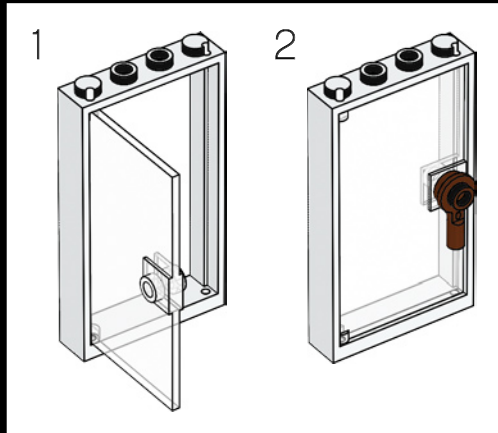
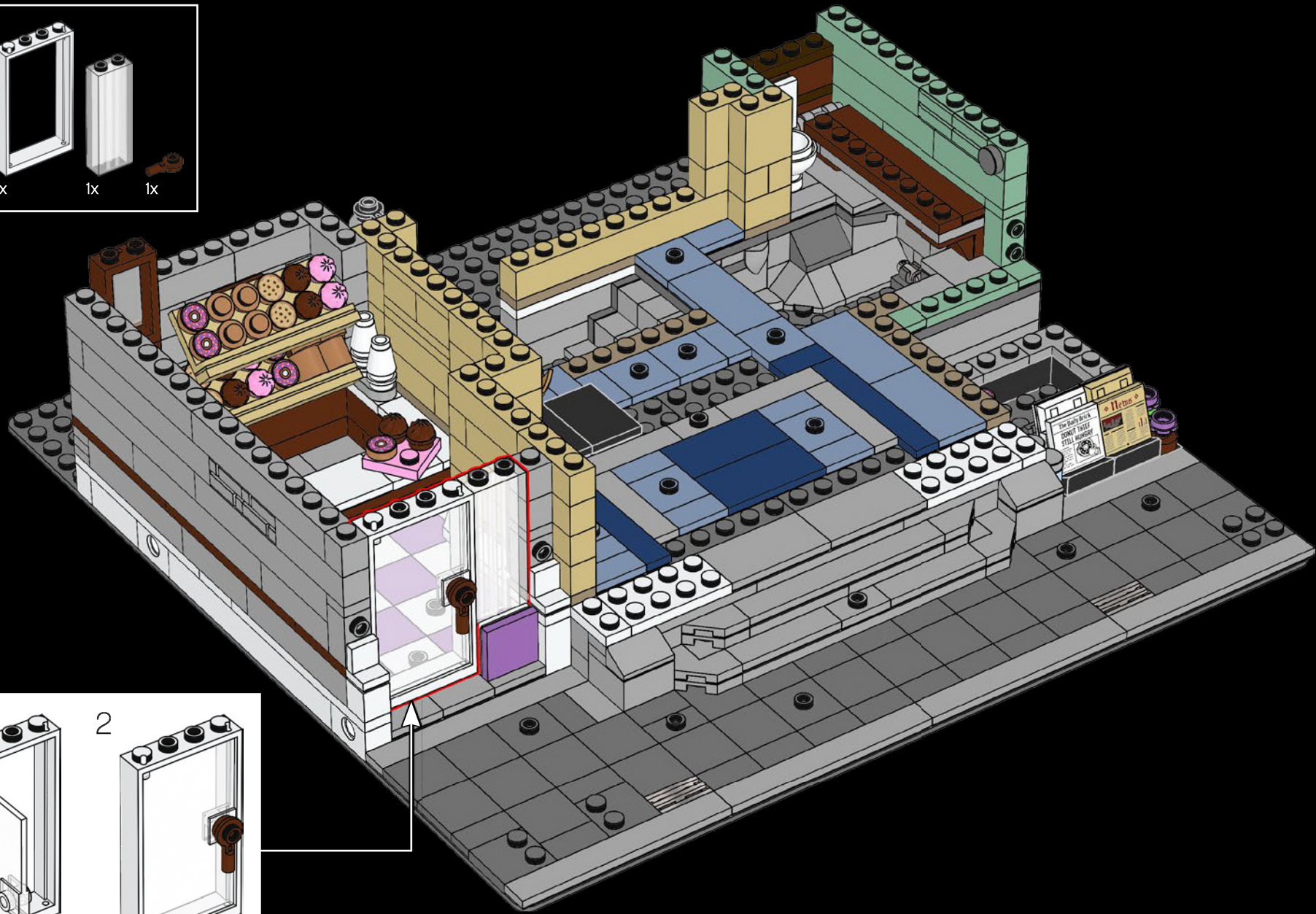



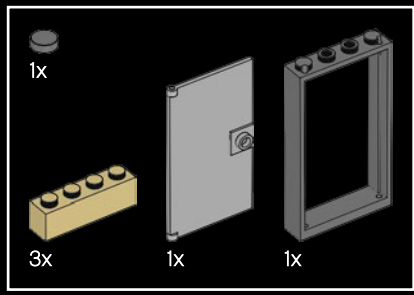

45

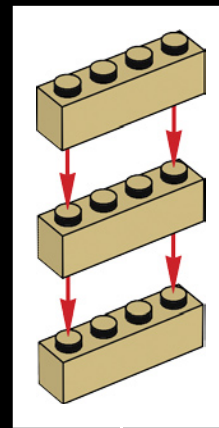
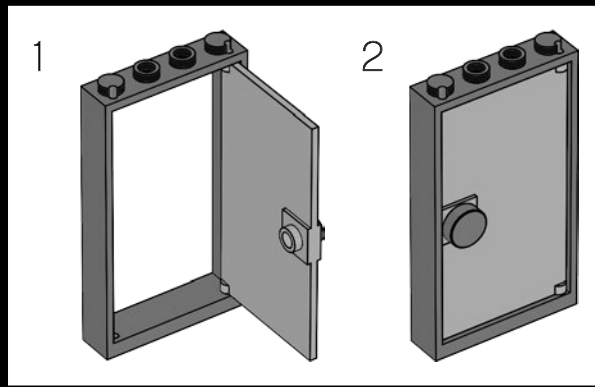



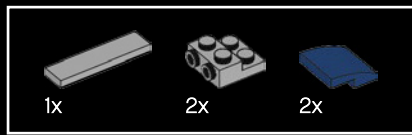

46

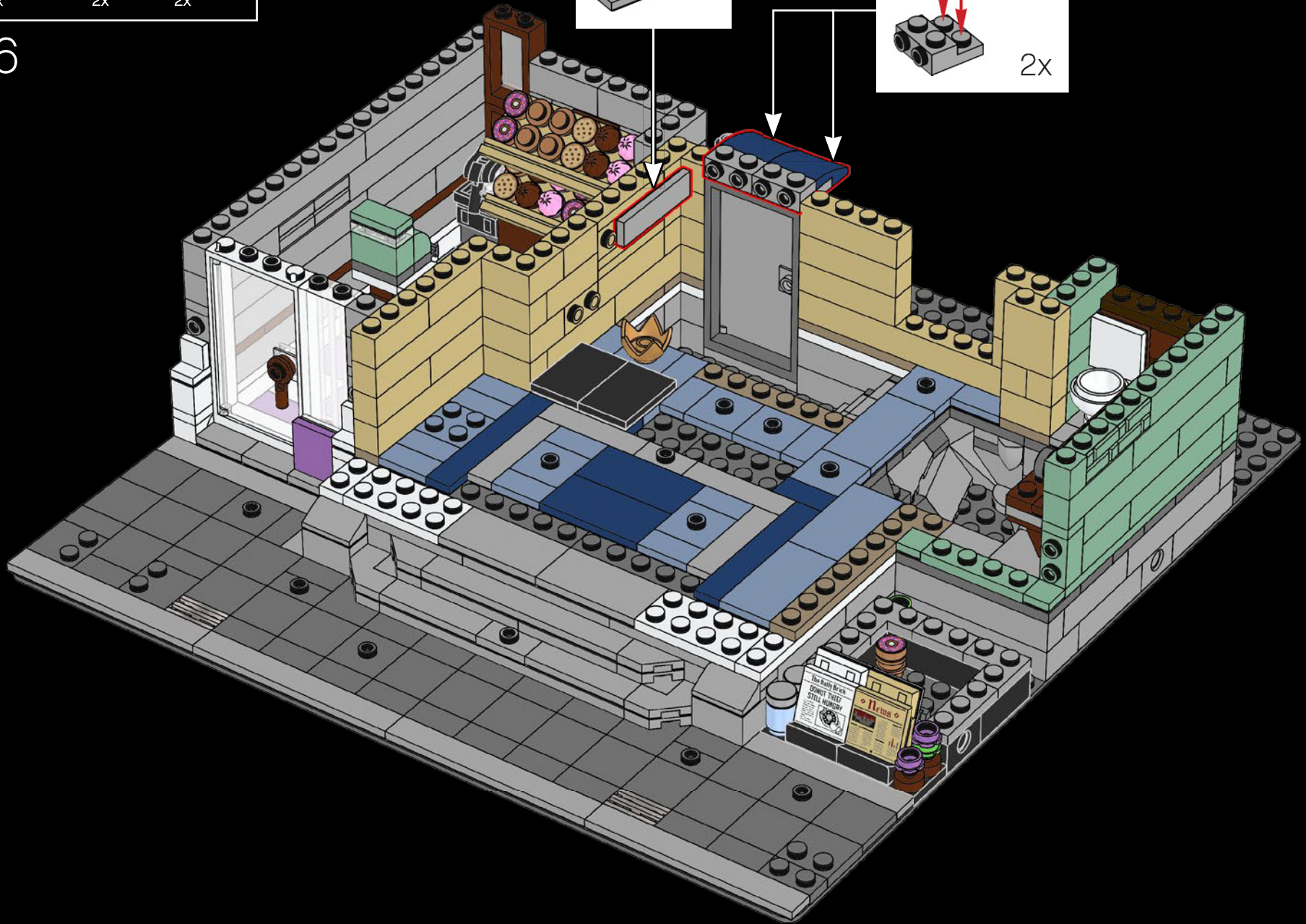
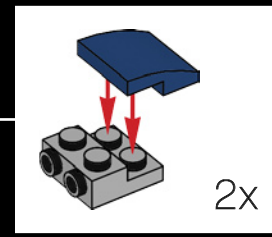
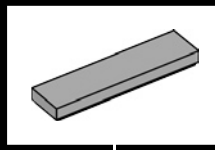



47

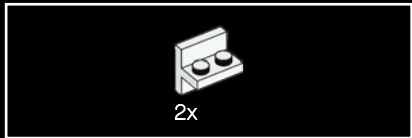
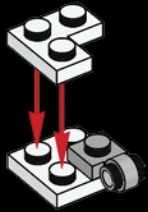

48

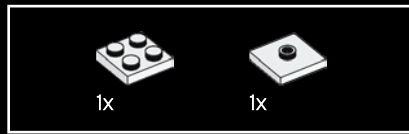

49

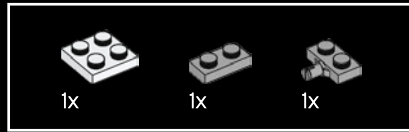
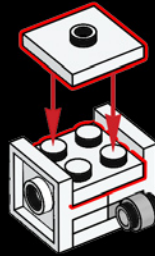

50

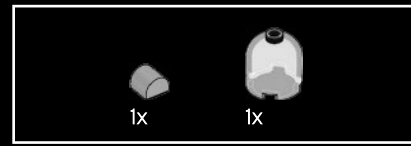
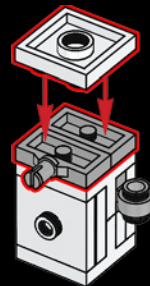

51

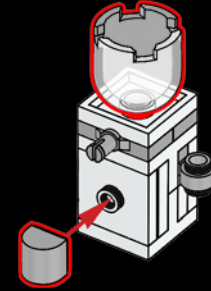

52

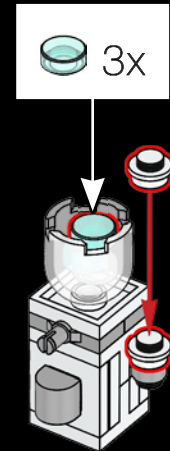





1x



1x

53

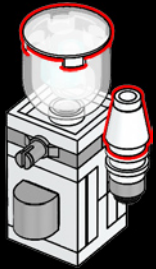

54

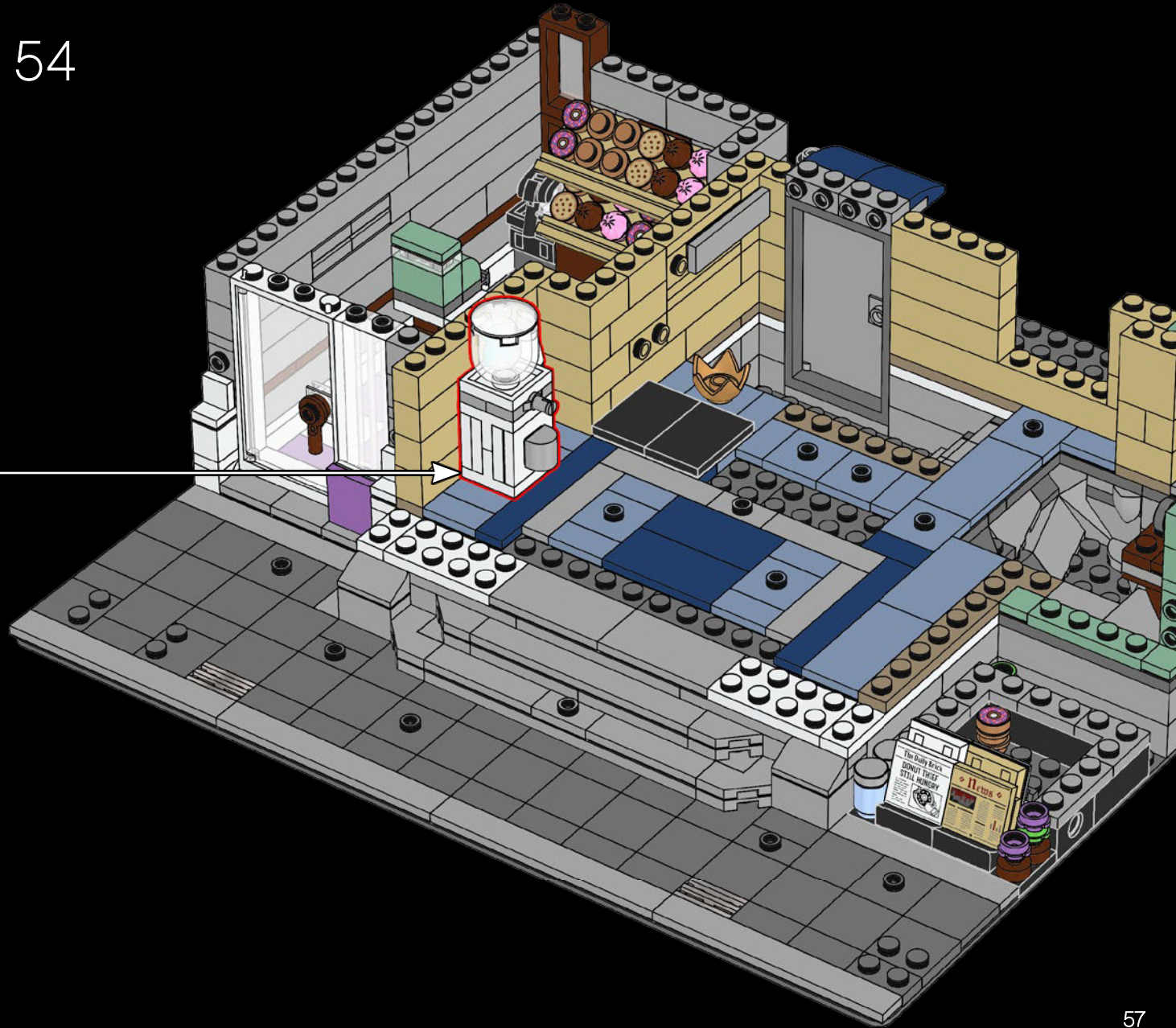

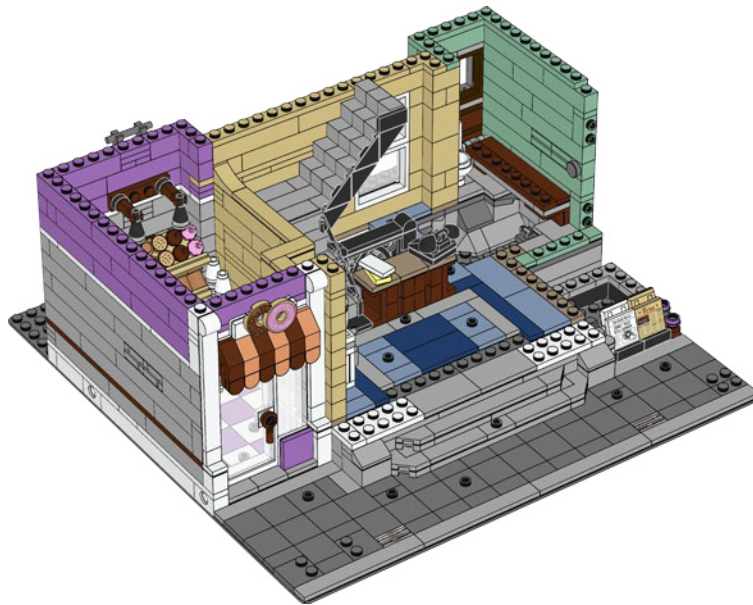



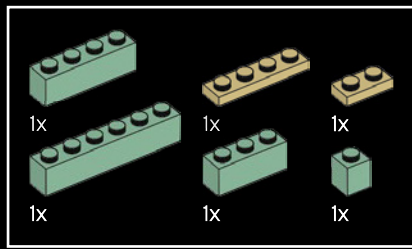

55

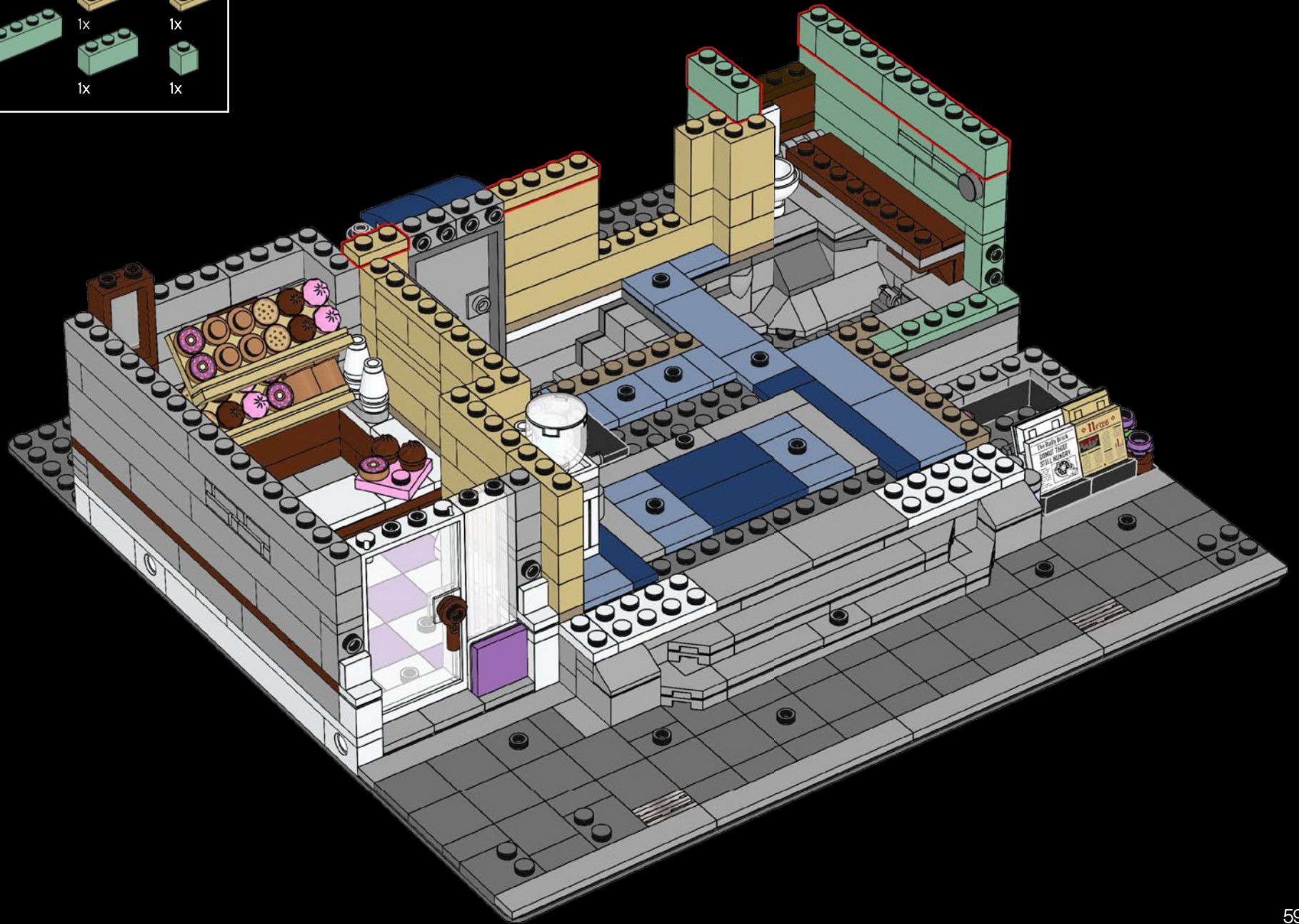







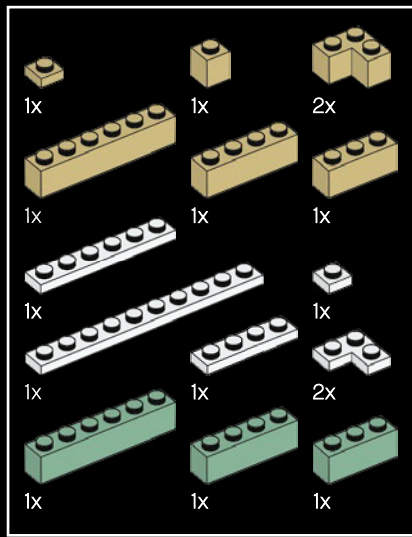

57

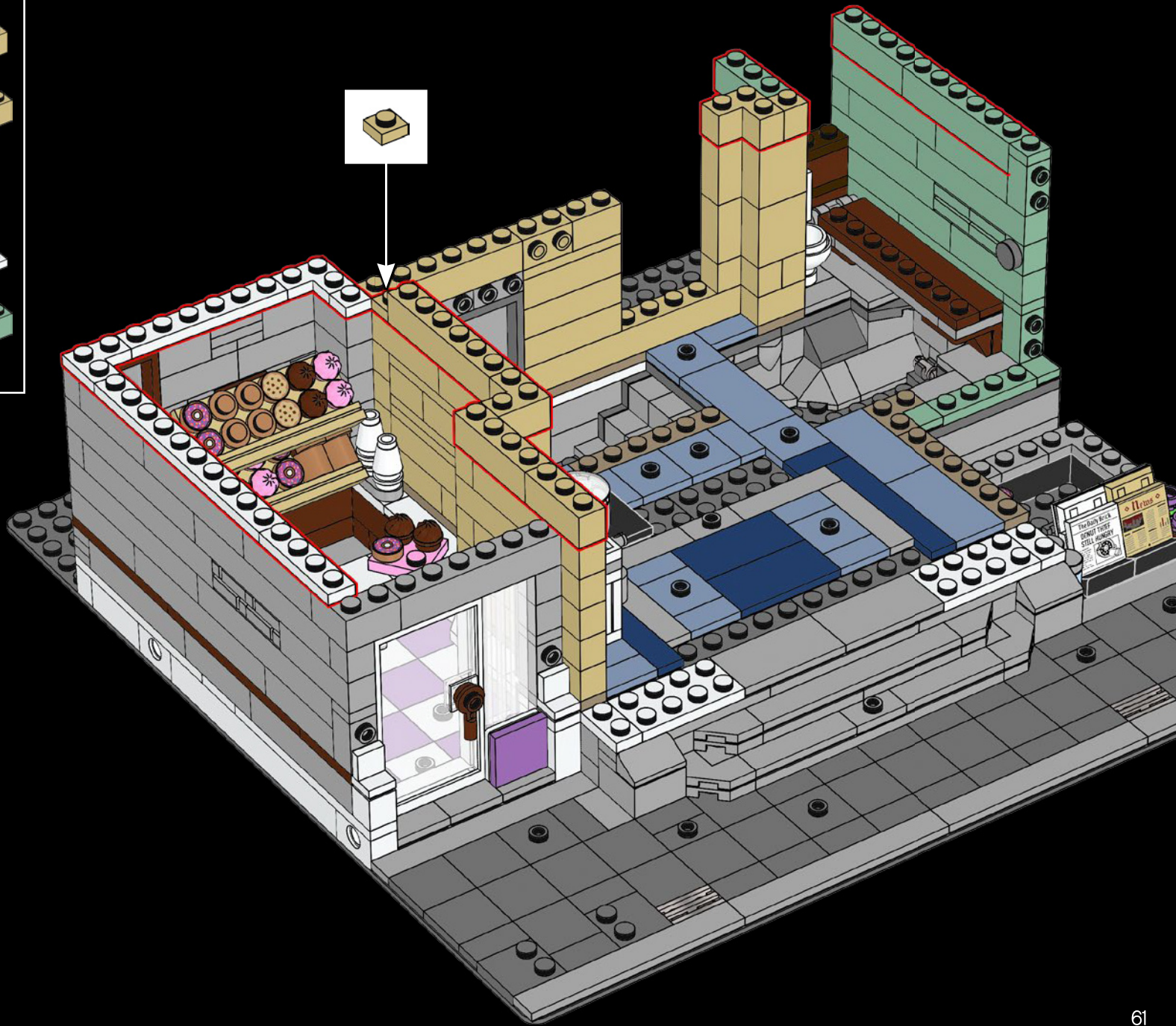

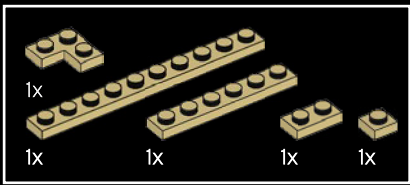

58

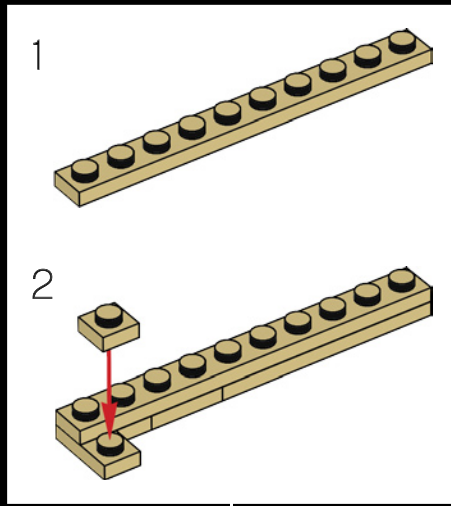



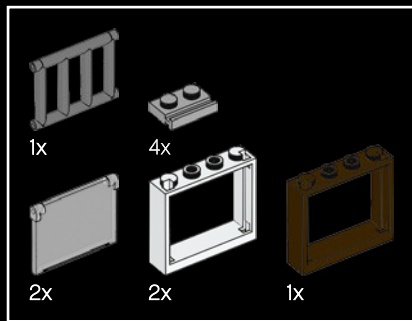

59

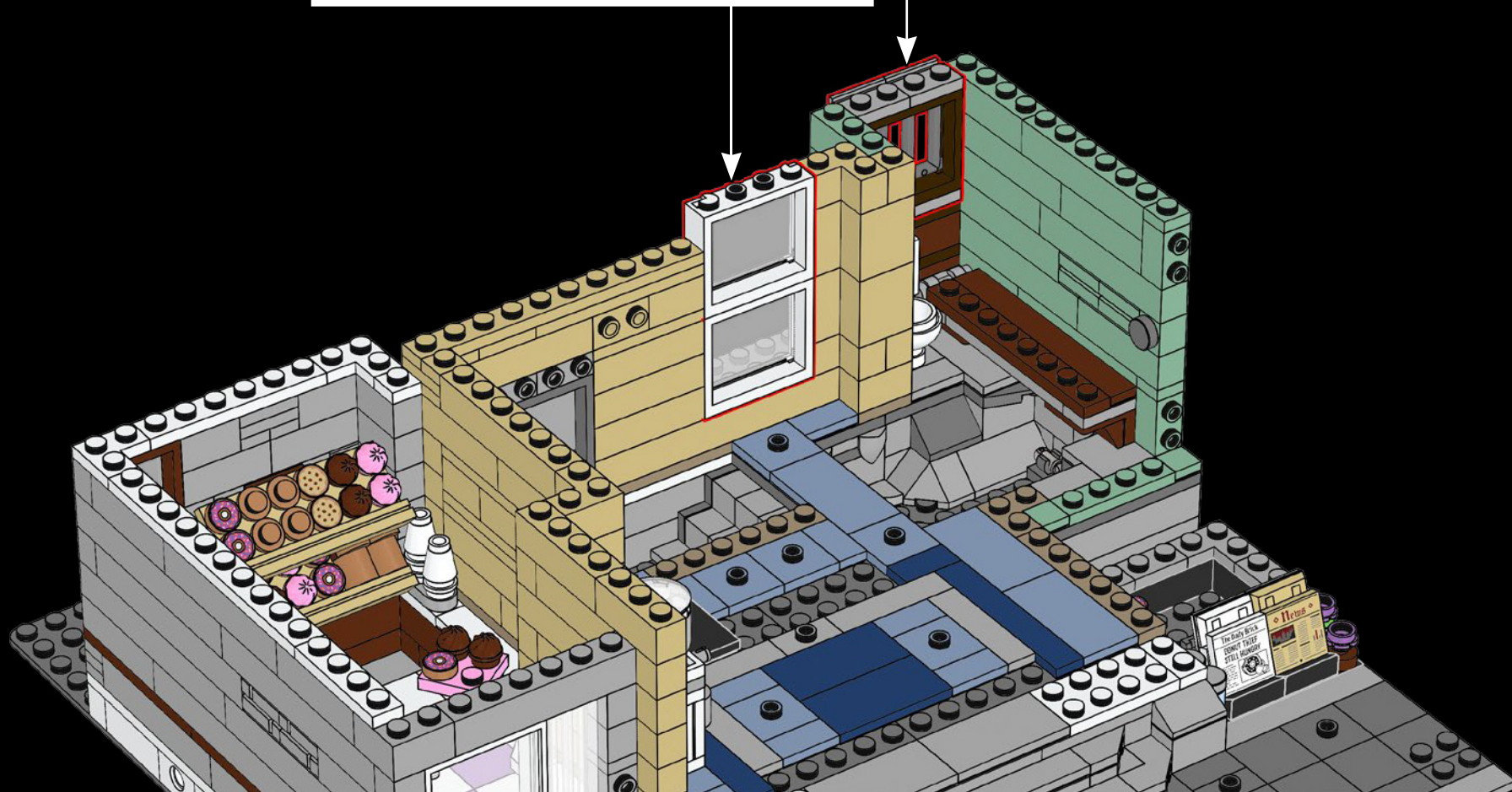
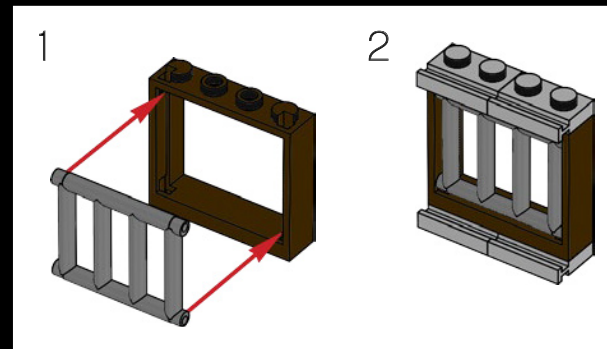
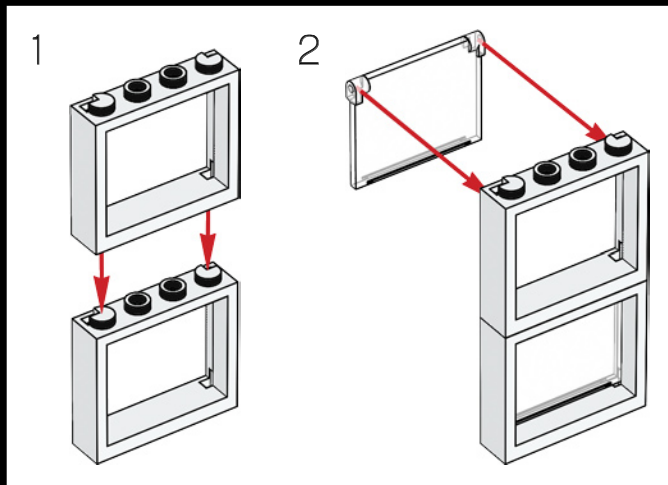



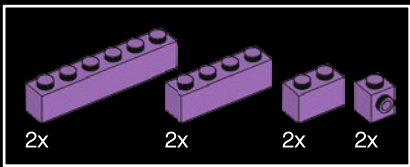

60

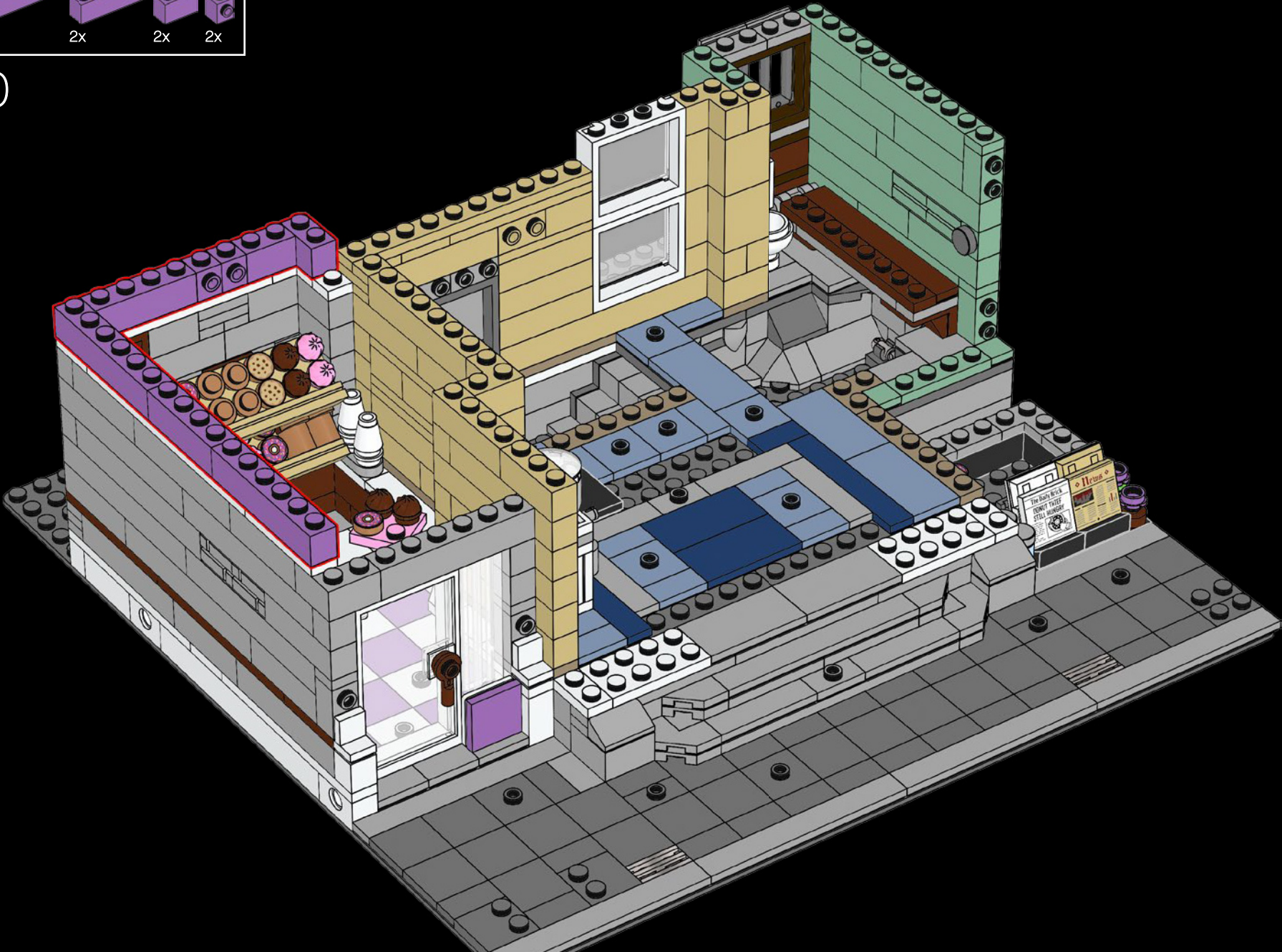



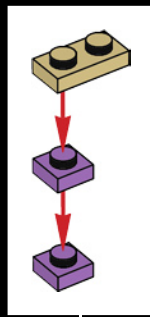
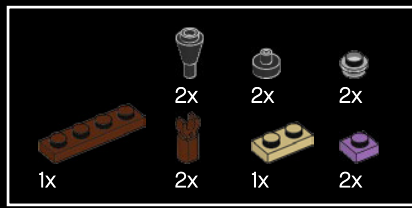

61

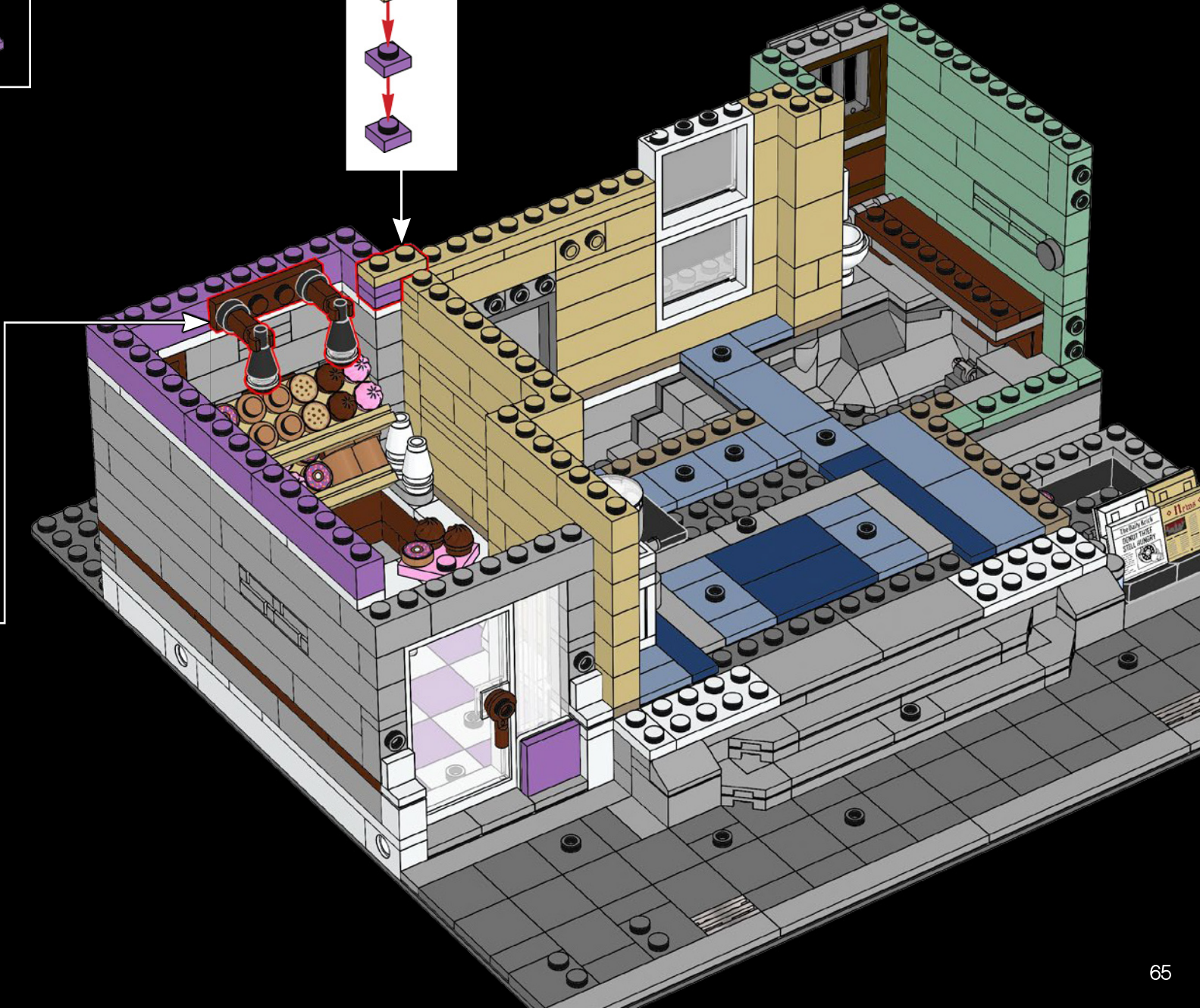
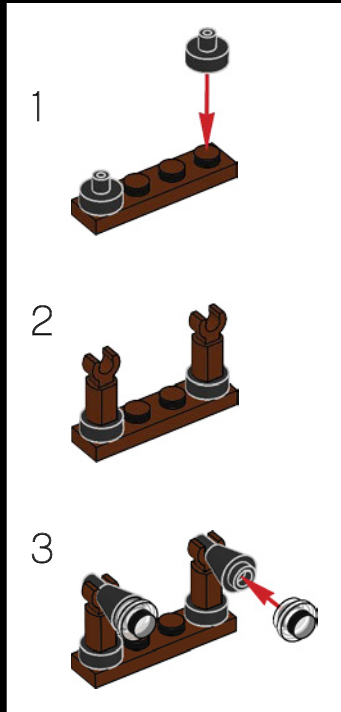



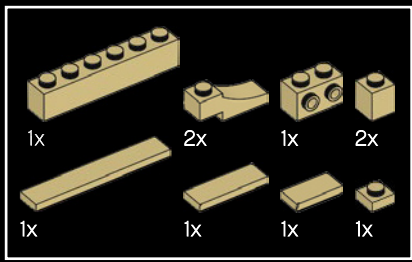

62

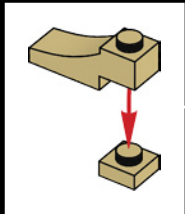
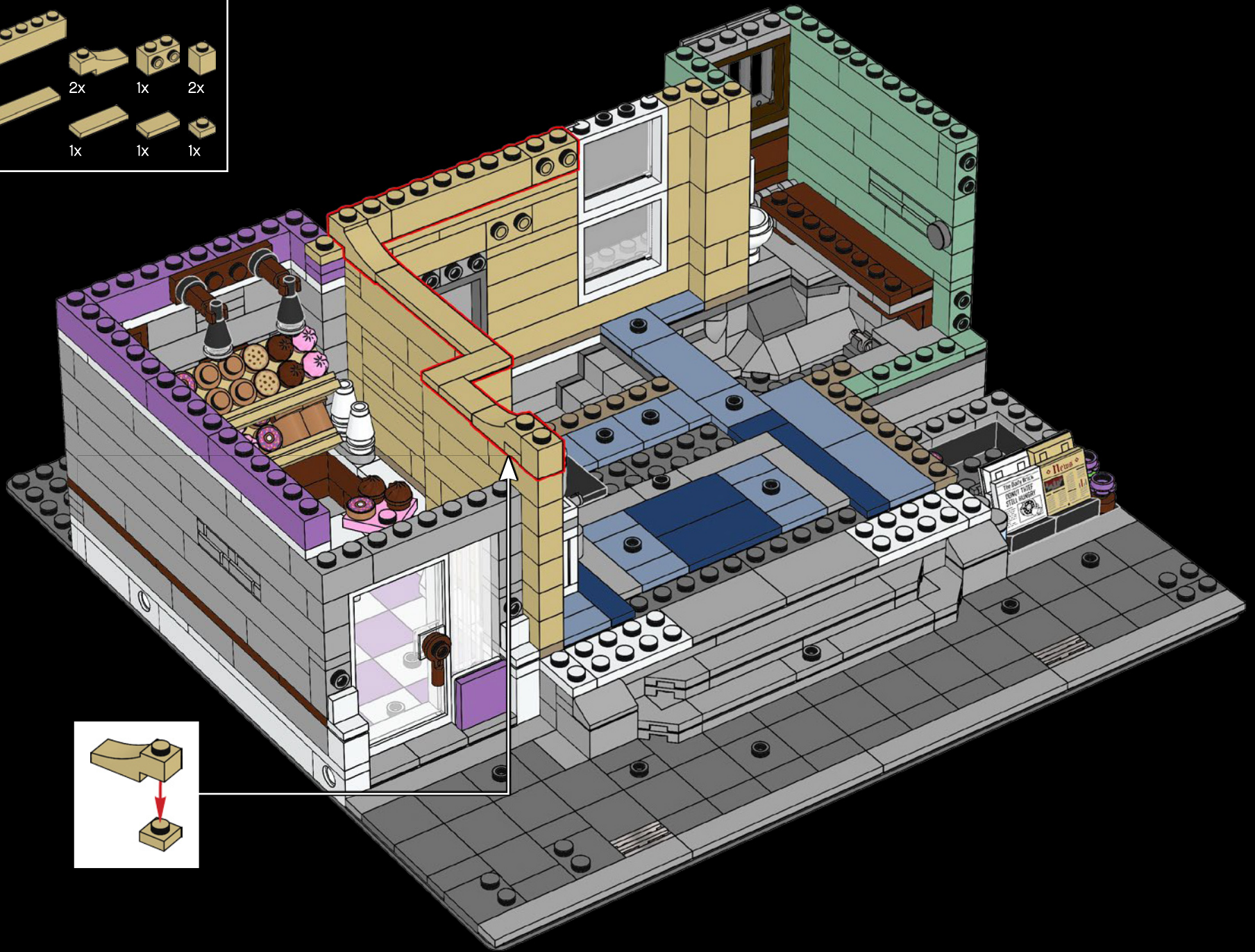



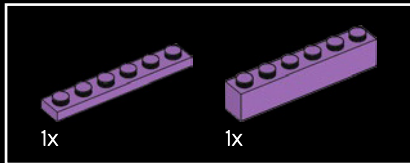
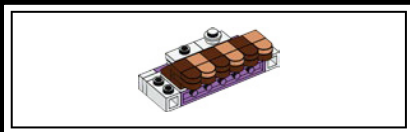

63

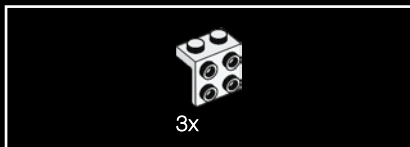
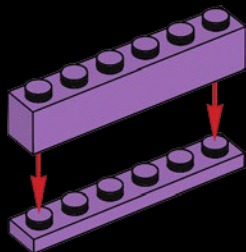

64

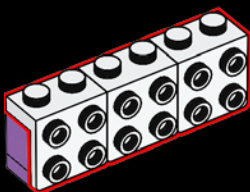

65

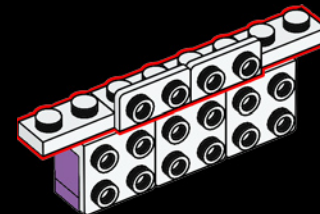

66

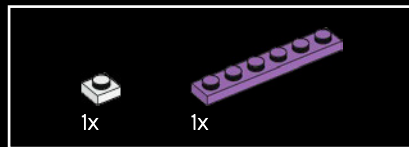
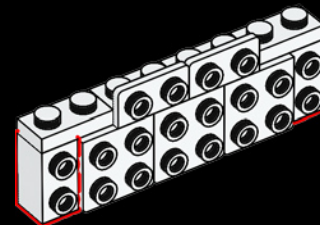

67

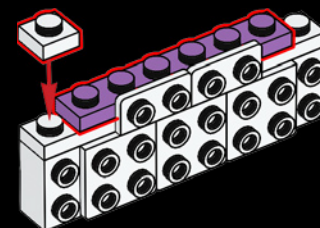

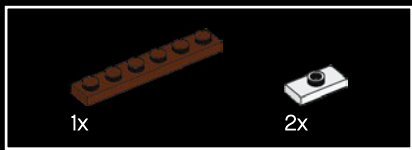

68

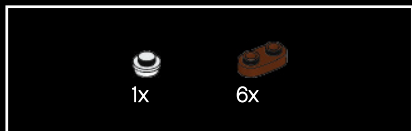
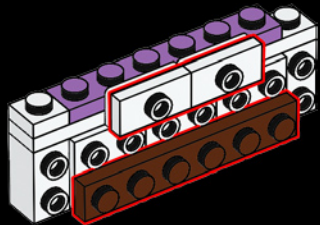

69

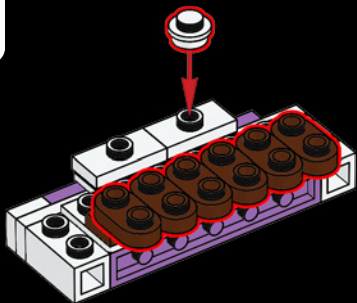

70

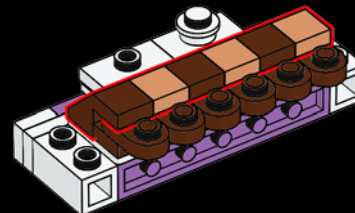

71

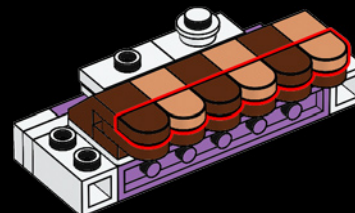



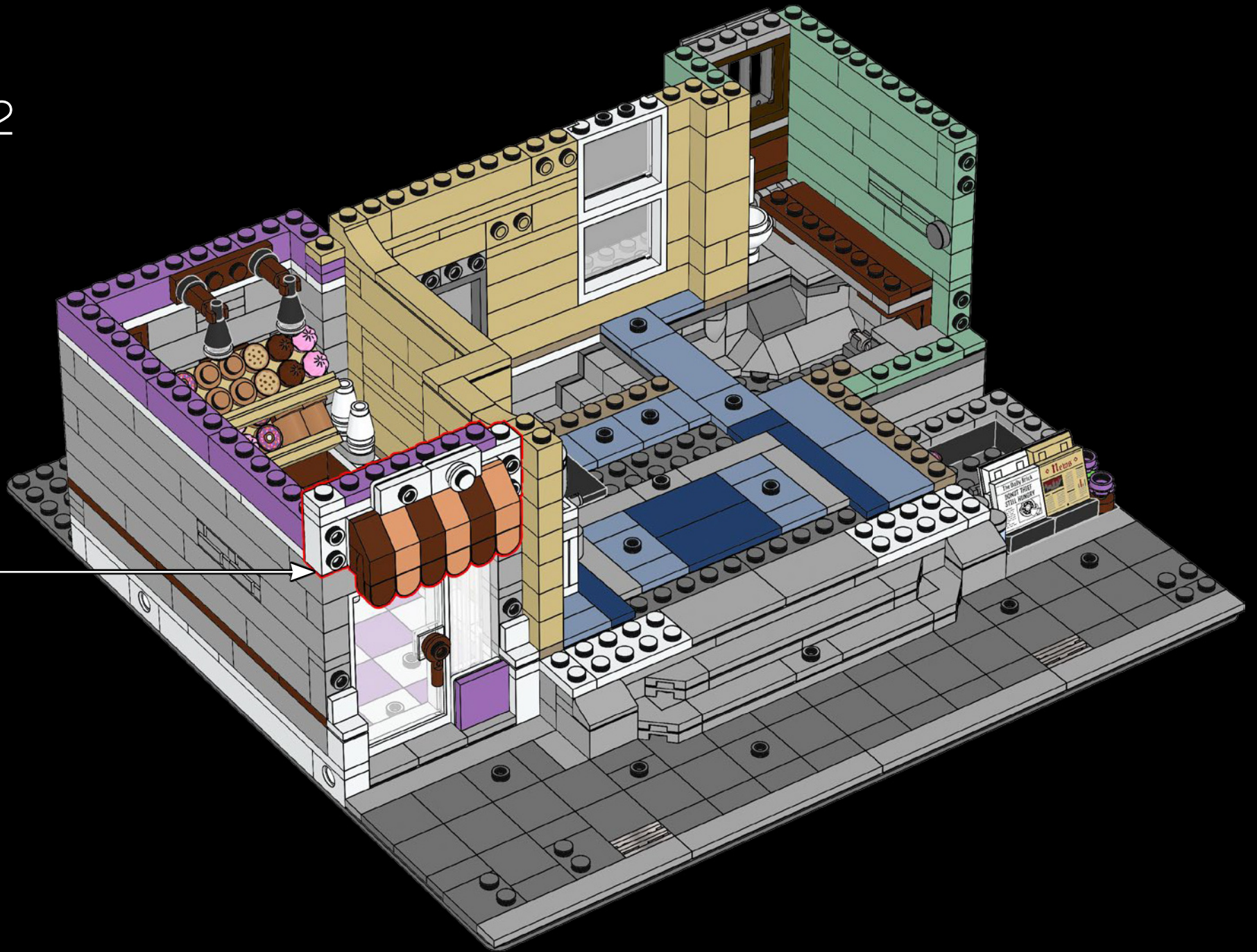



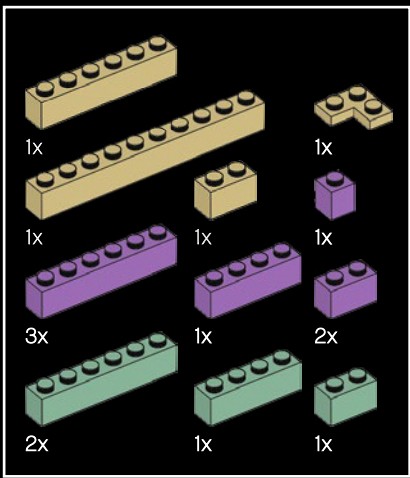

73

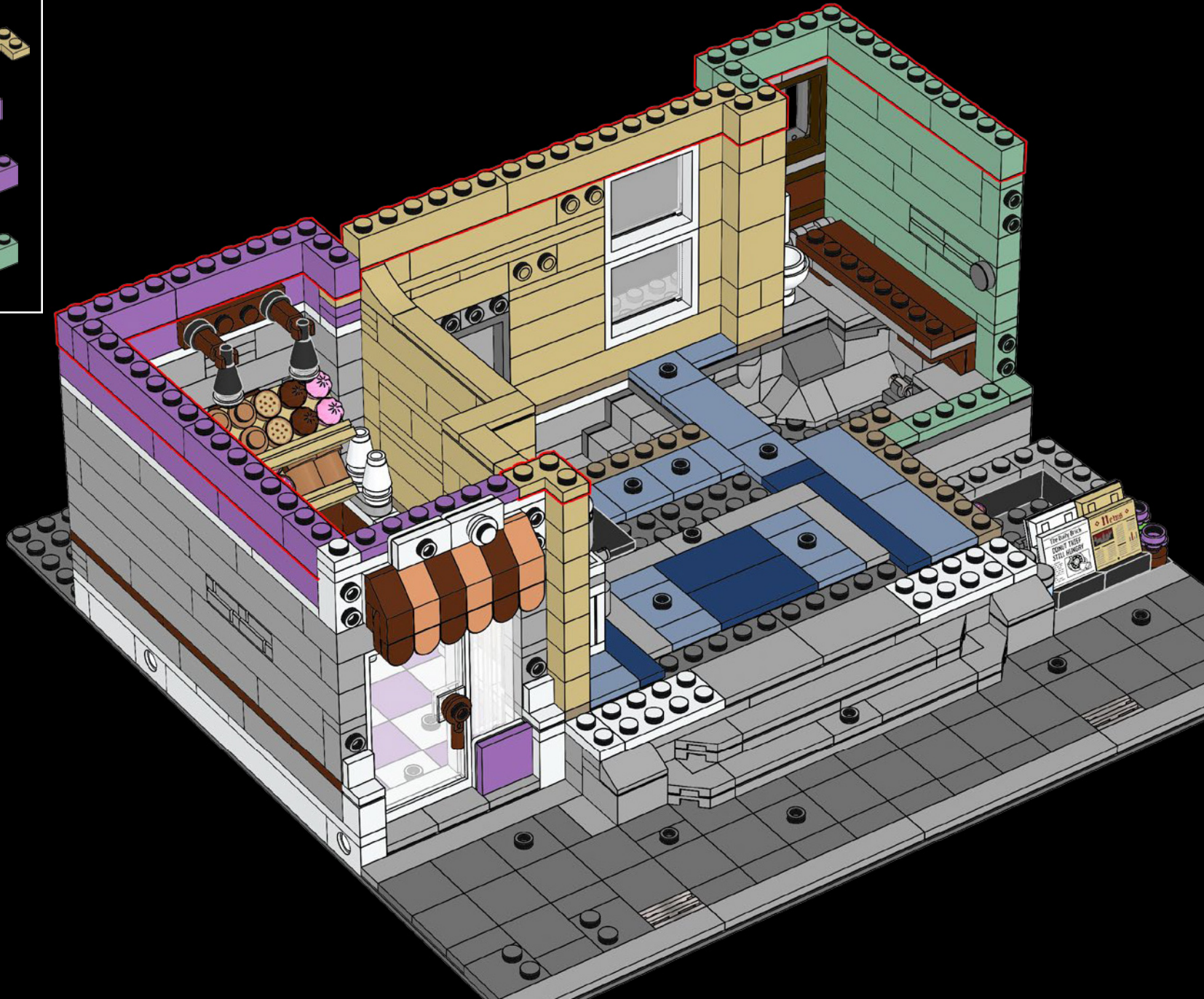



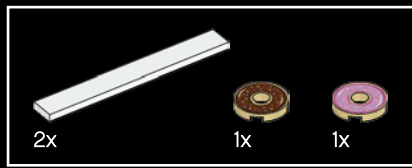

74

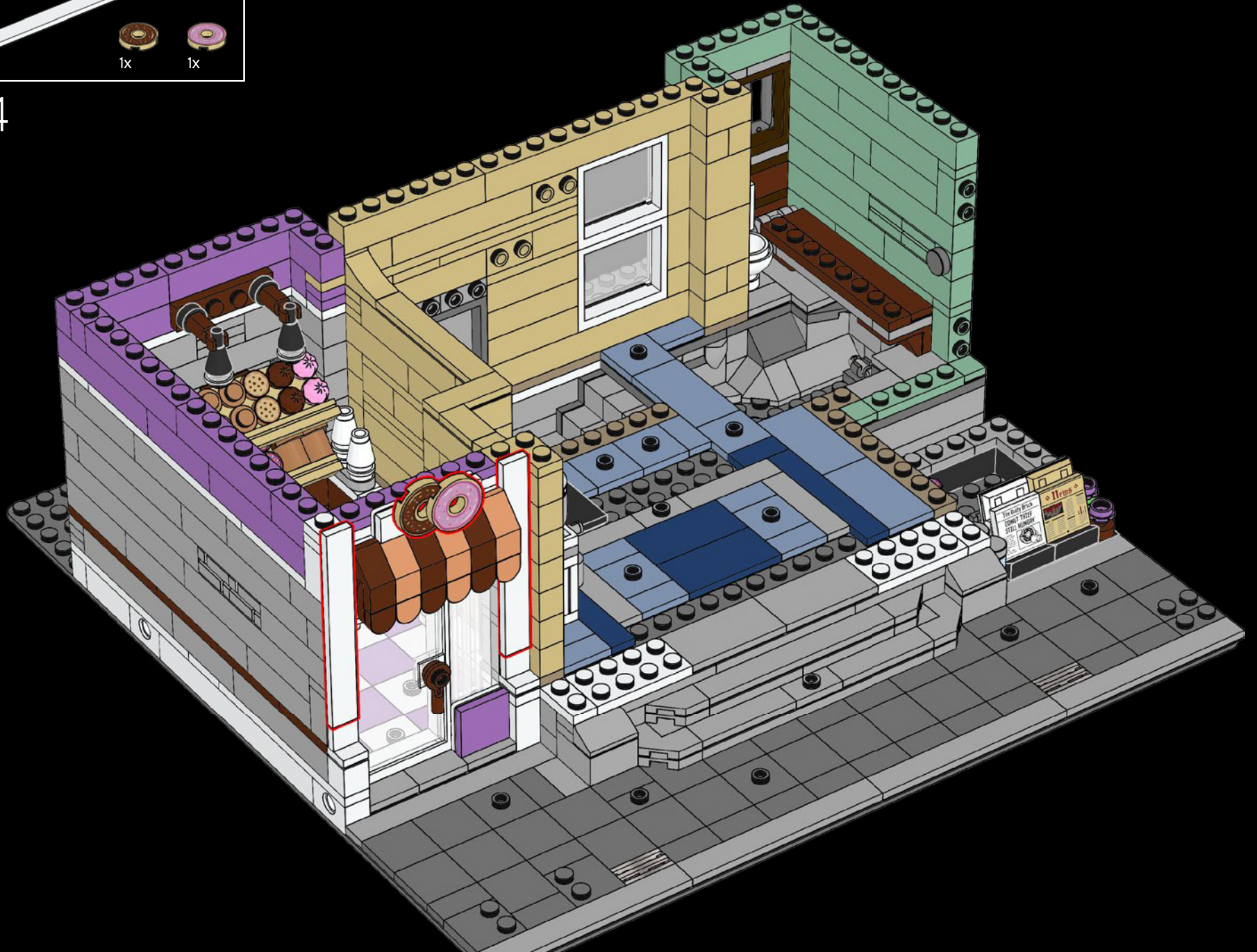



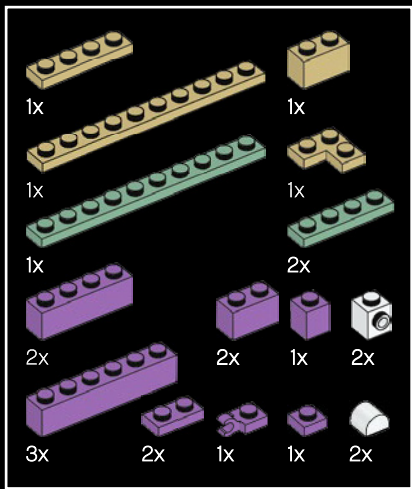

75

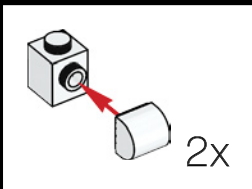
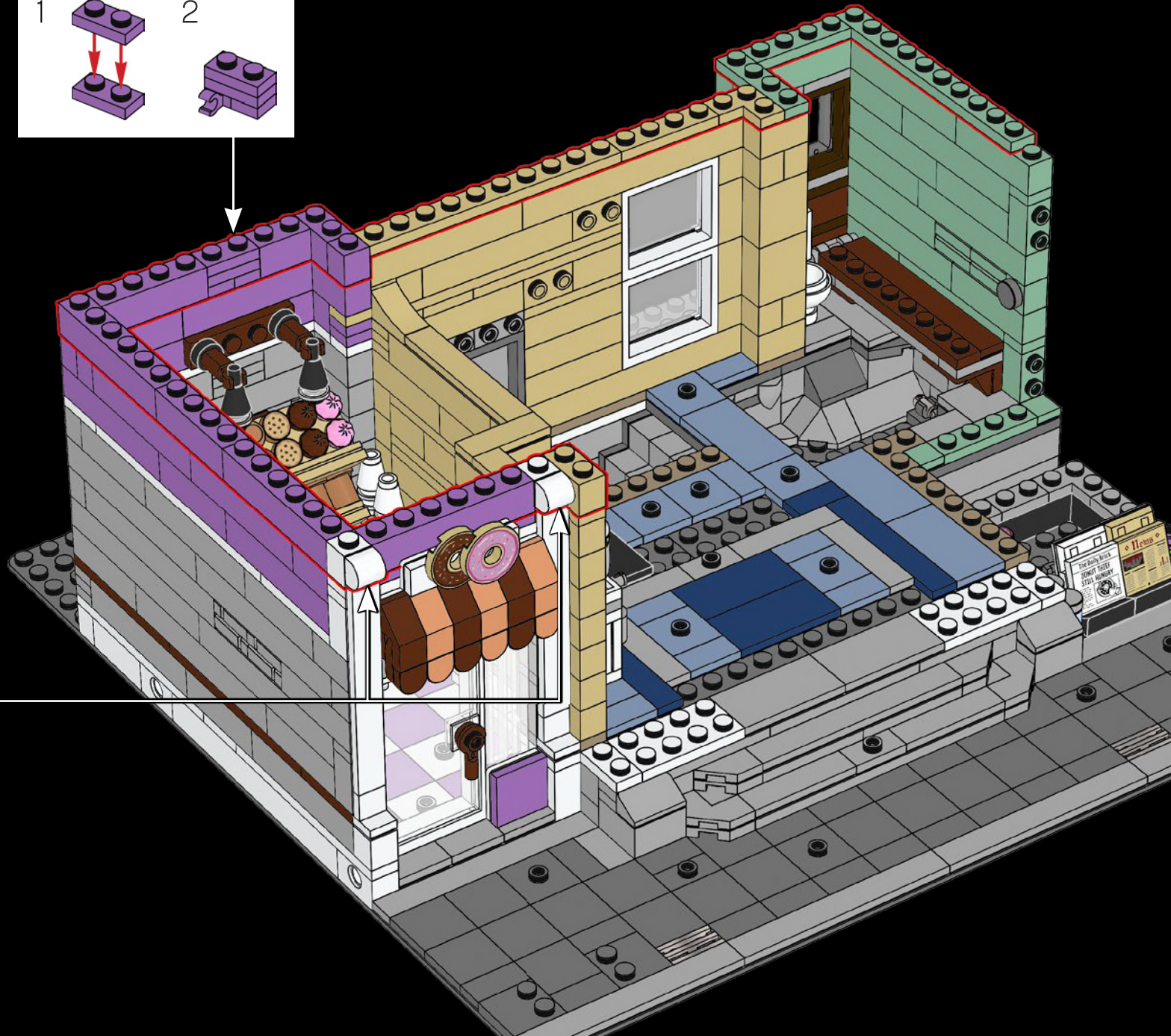
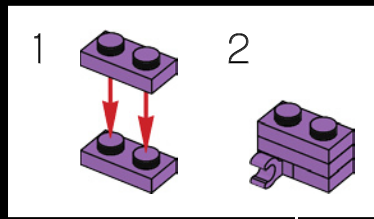



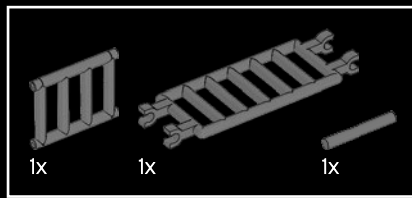

76

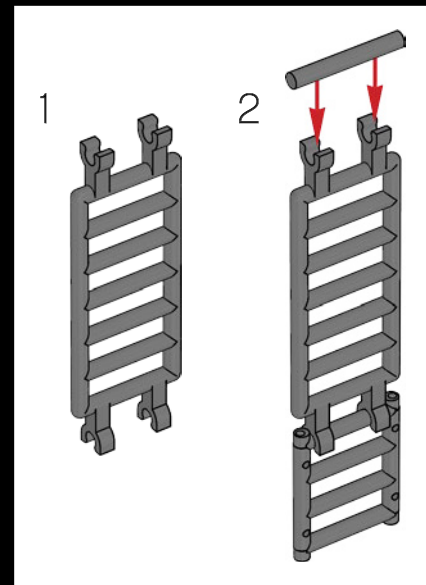
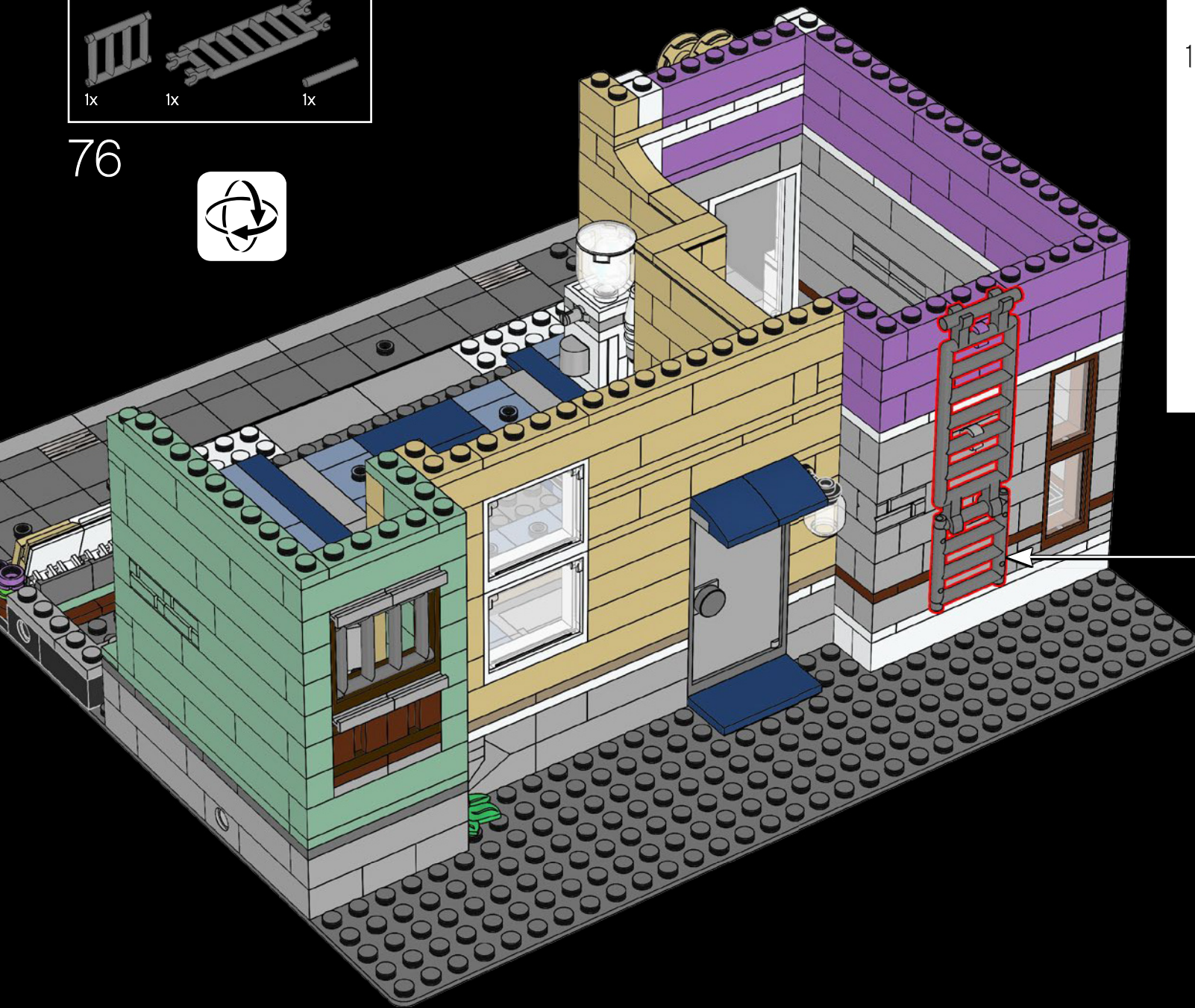

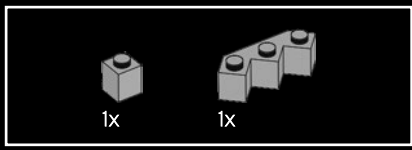

77

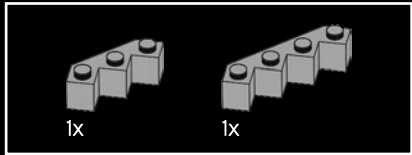
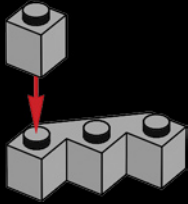

78

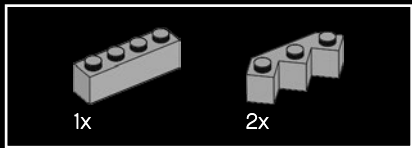
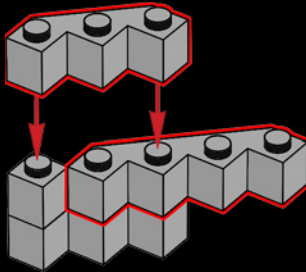

79

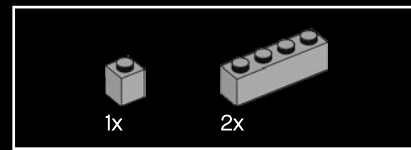
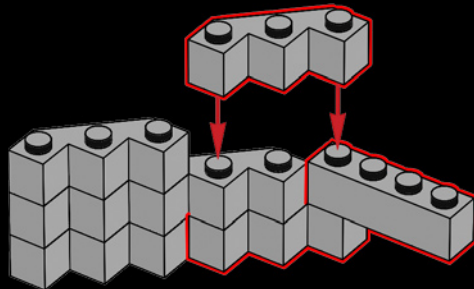

80

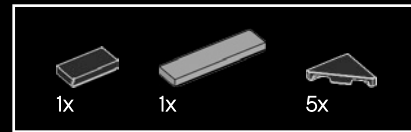
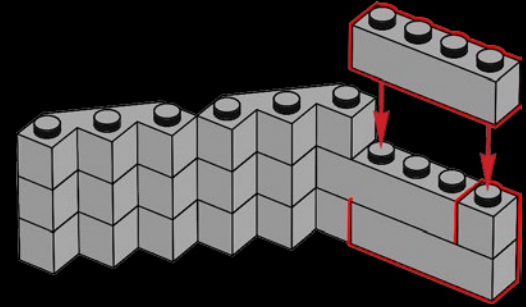

81

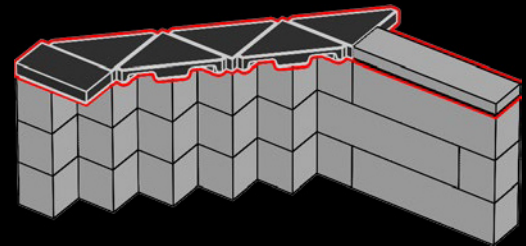





- The station's grand staircase is constructed with facet bricks that have been flipped on their sides.
- Le grand escalier du poste est construit avec des briques à facettes tournées sur le côté.
- La escalera principal de la estación se construye con bricks facetados colocados de lado.

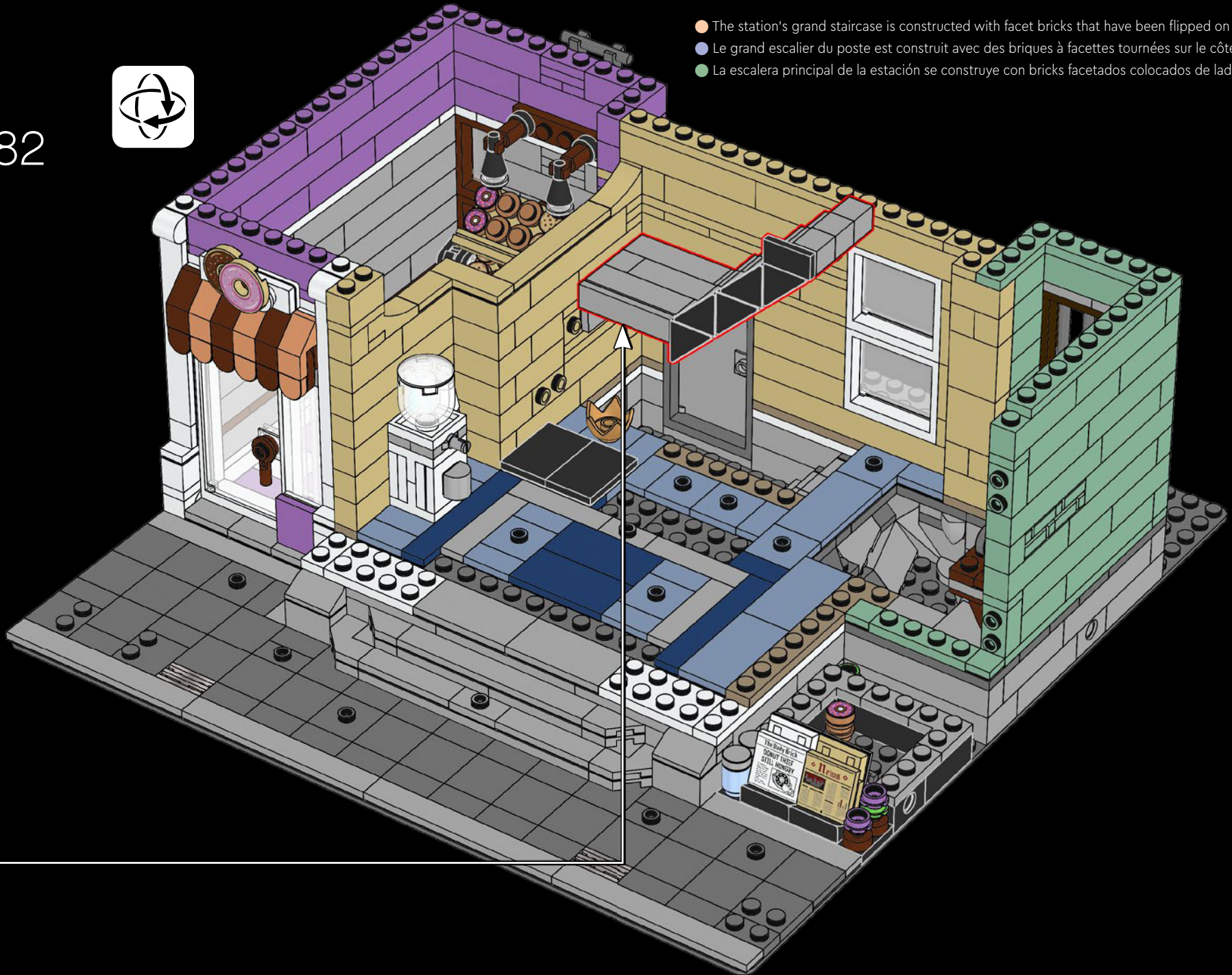



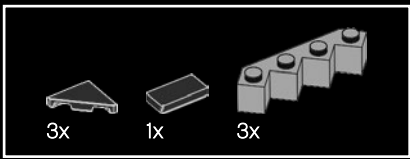

83

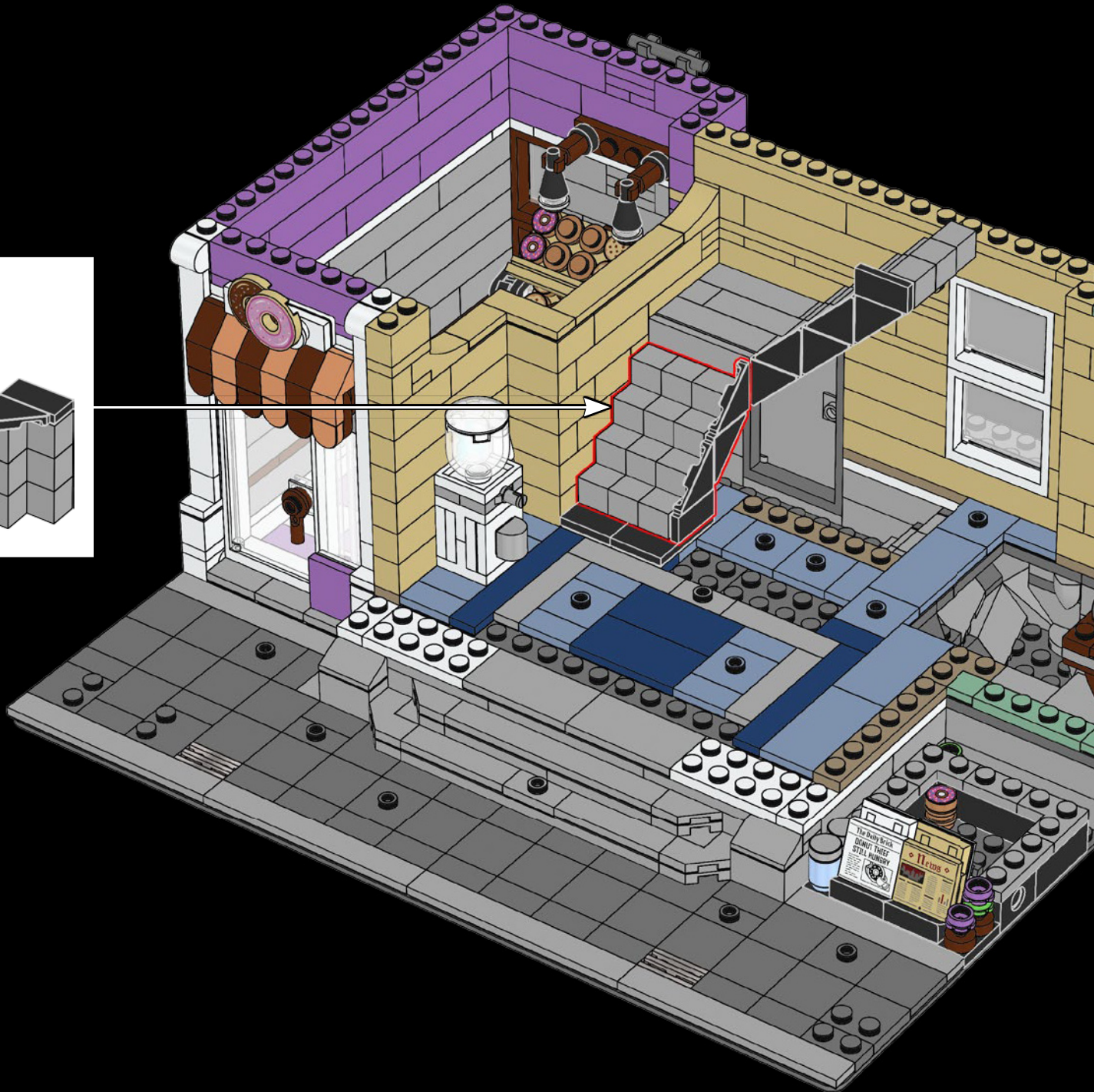
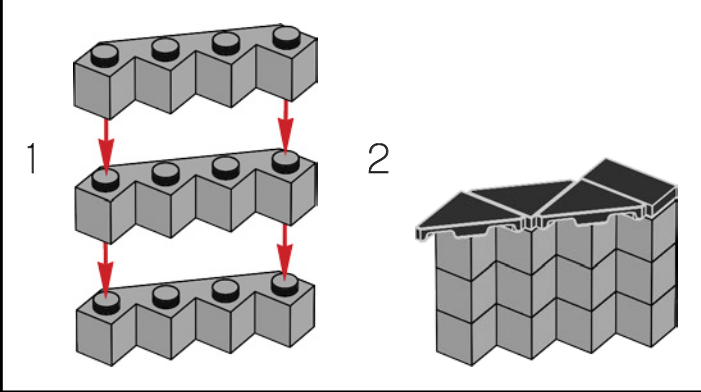



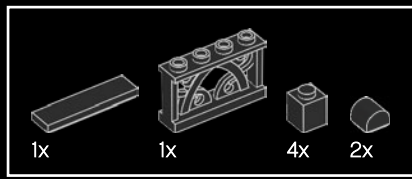

84

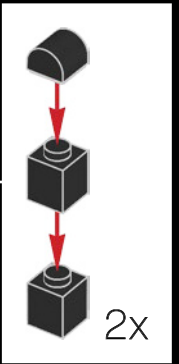
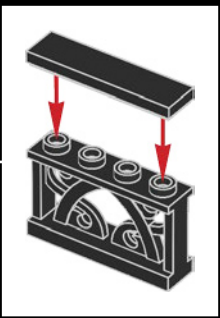
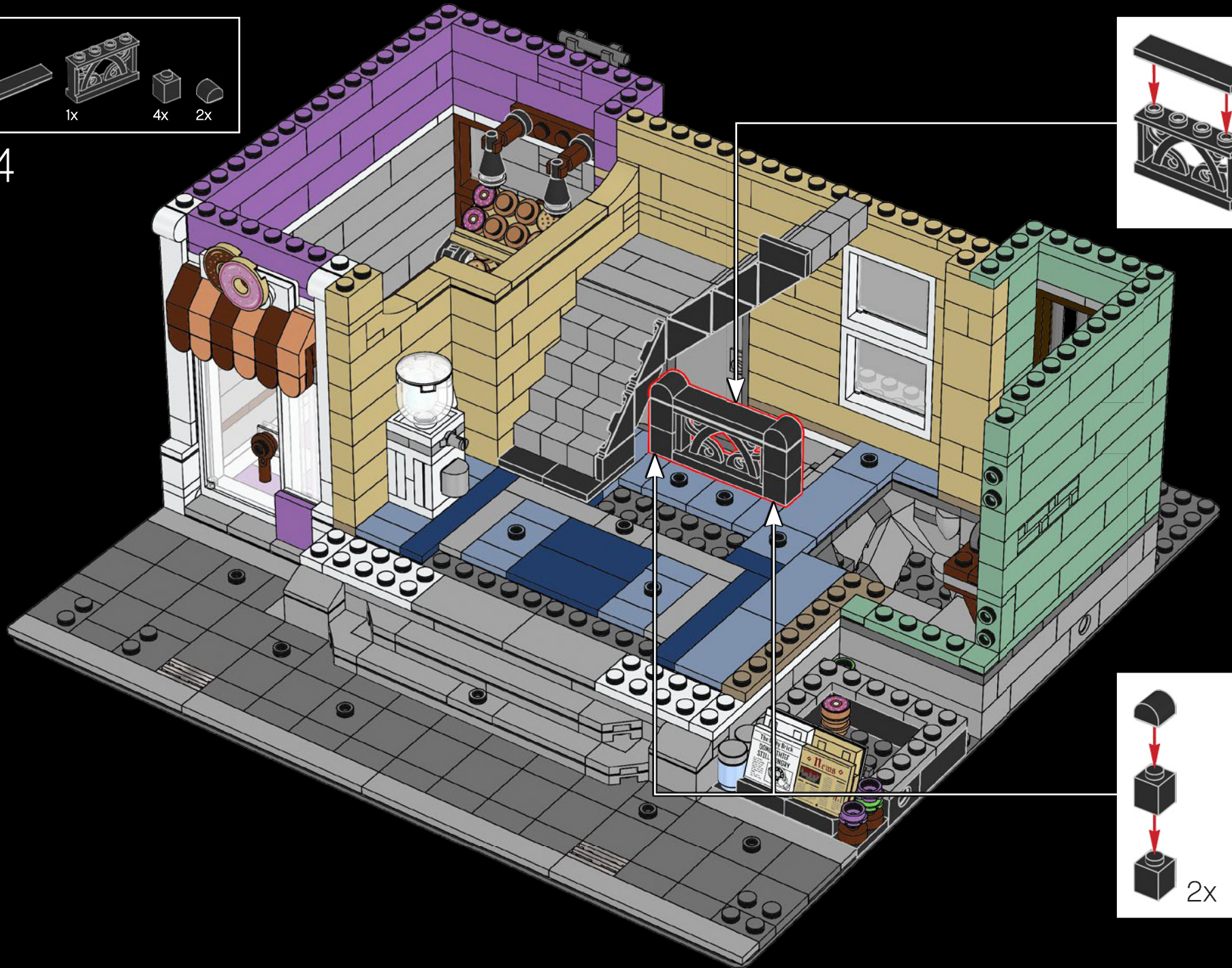





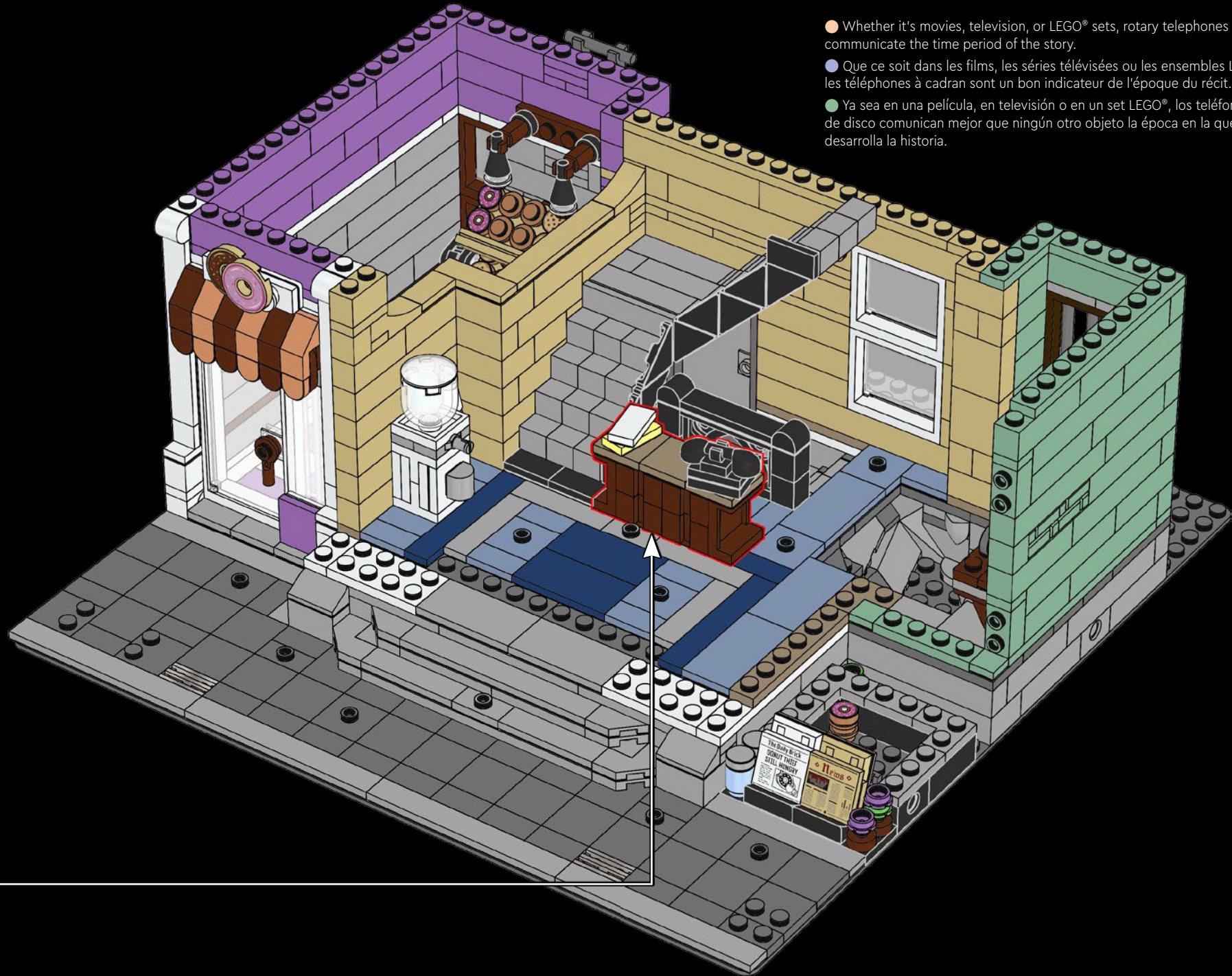

- Whether it's movies, television, or LEGO® sets, rotary telephones really communicate the time period of the story.
- Que ce soit dans les films, les séries télévisées ou les ensembles LEGO®, les téléphones à cadran sont un bon indicateur de l'époque du récit.
- Ya sea en una película, en televisión o en un set LEGO®, los teléfonos de disco comunican mejor que ningún otro objeto la época en la que se desarrolla la historia.

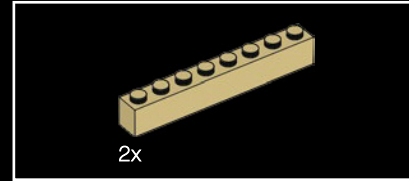
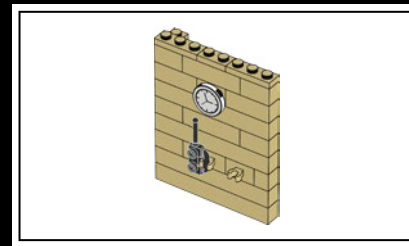
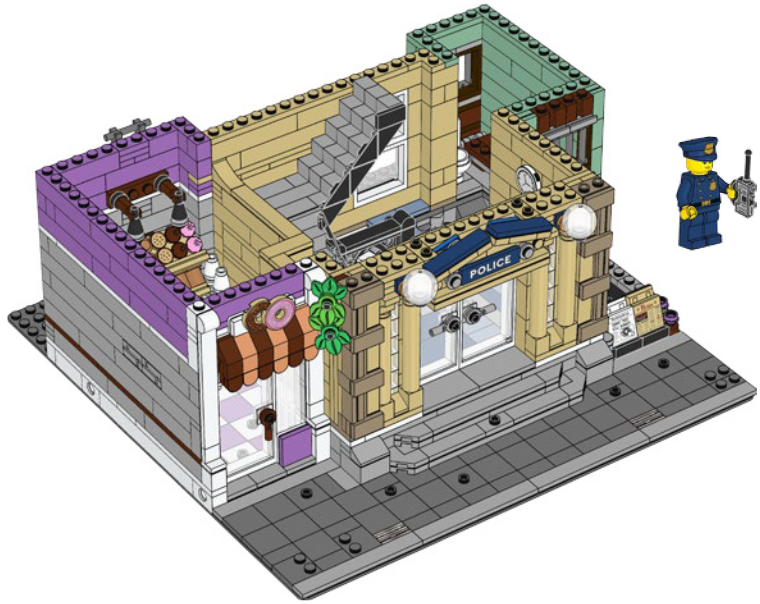
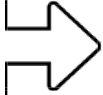

86

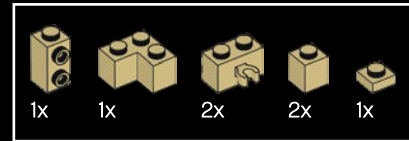
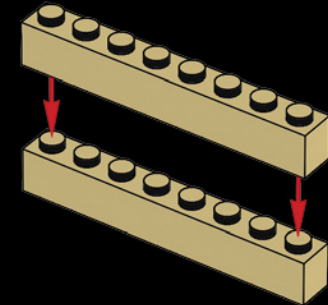

87

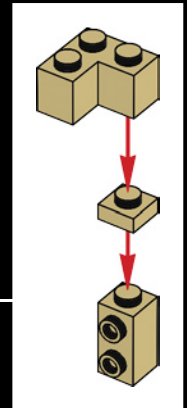
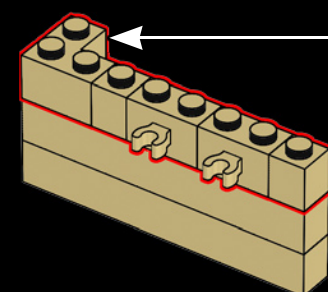

- The fresh-faced police officer is a recent graduate from the academy.
- La nouvelle recrue vient tout juste d'obtenir son diplôme de l'académie.
- Este policía es una cara nueva en la estación: acaba de graduarse de la academia.

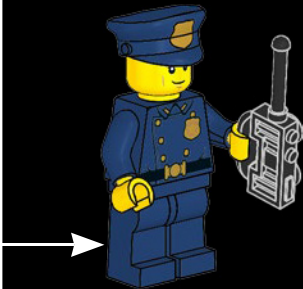
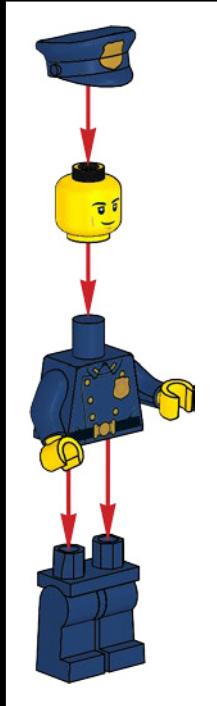



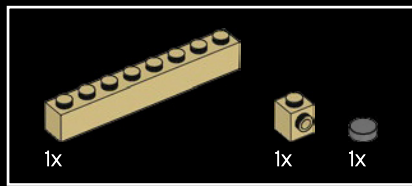

88

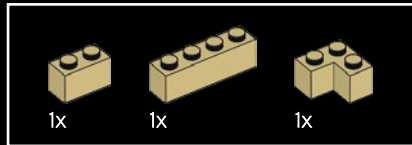
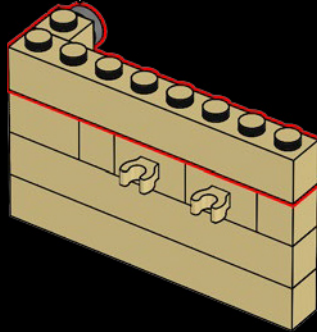
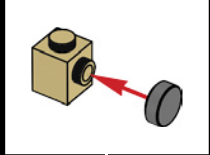

89

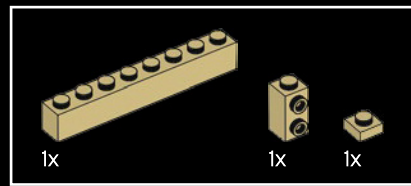
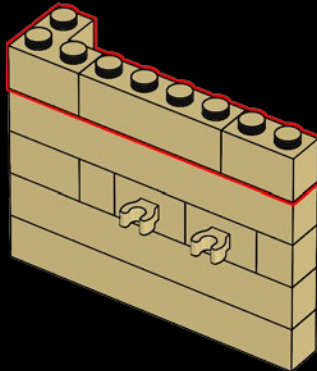

90

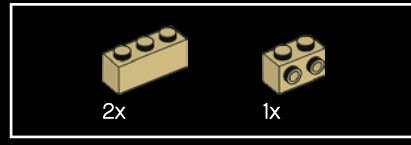
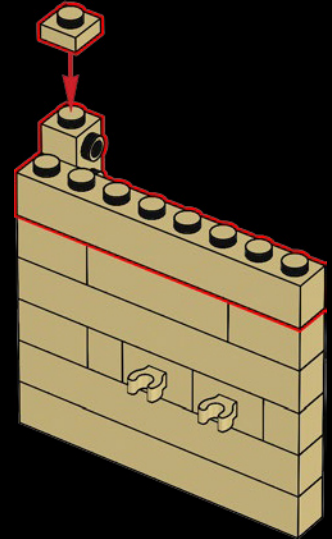

91

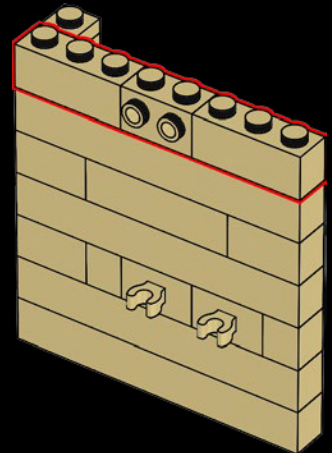

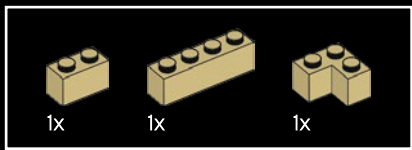

92

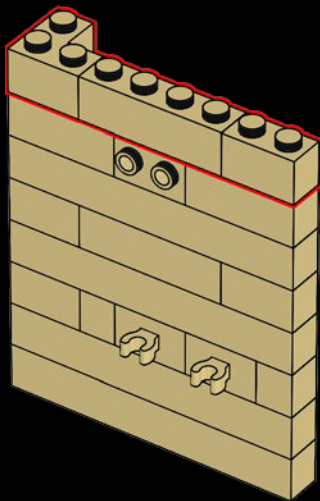

93

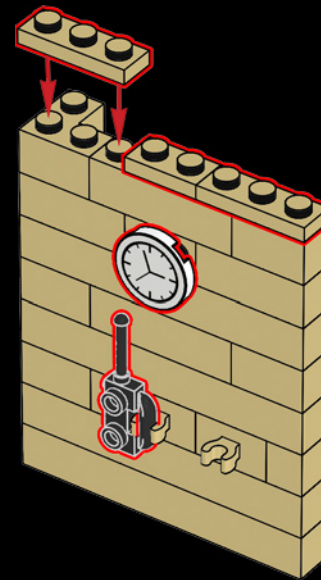



94

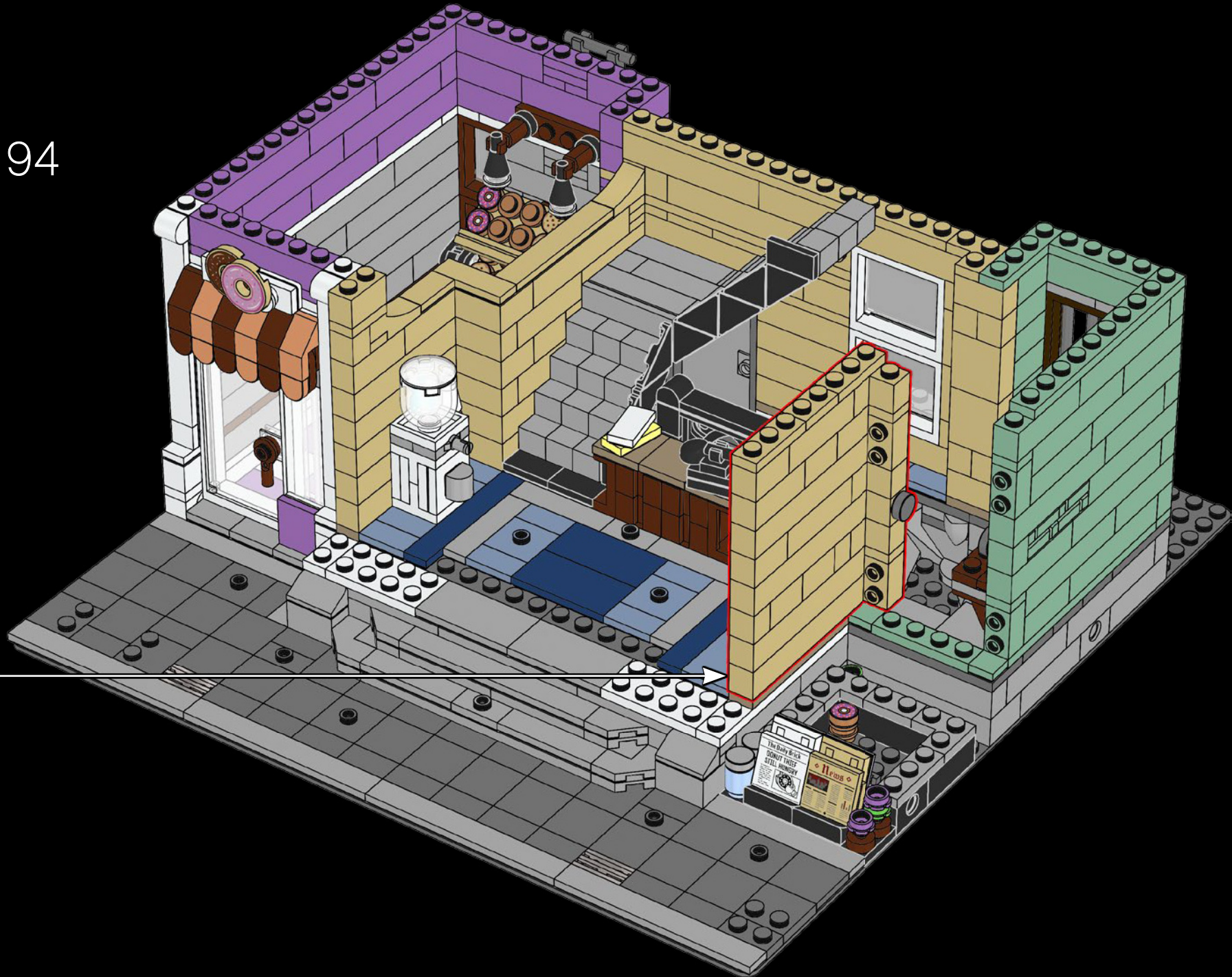



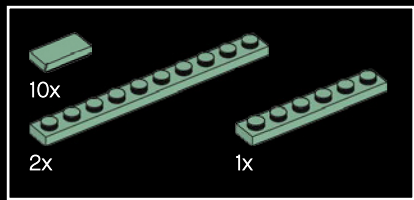

95

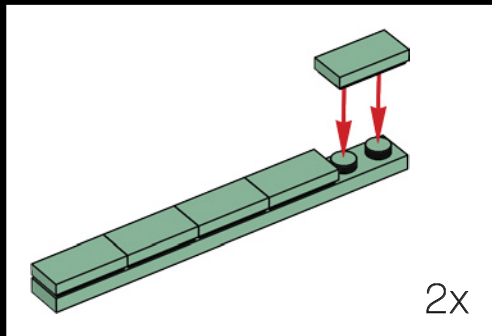
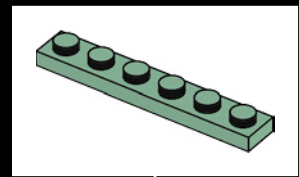
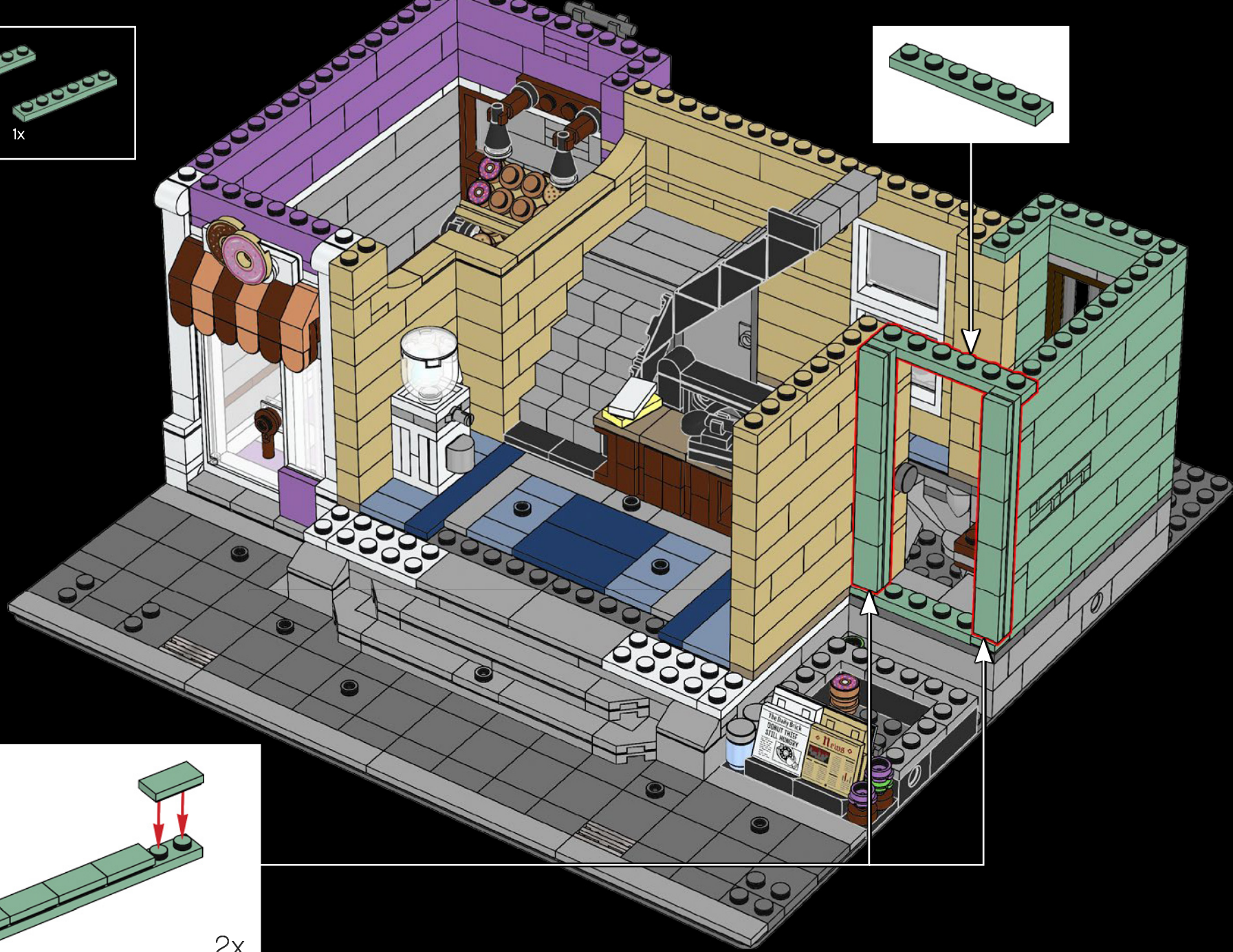



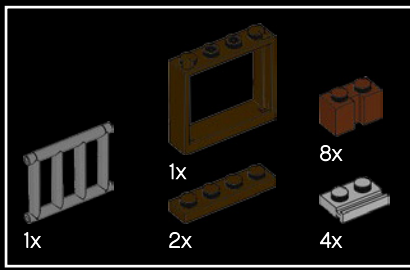

96

1

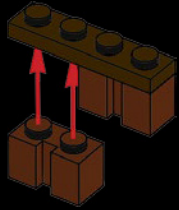

2

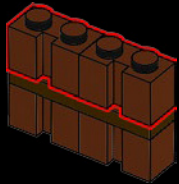

3

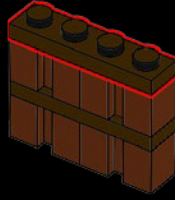

4

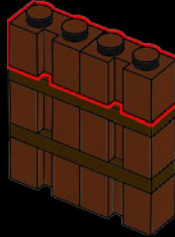

5

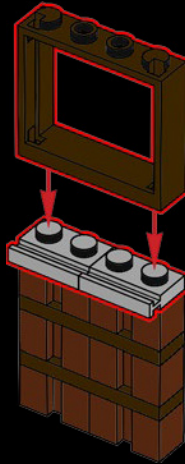

6

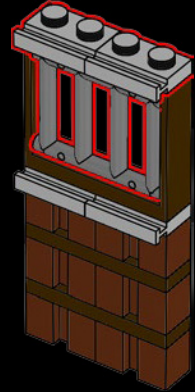

7

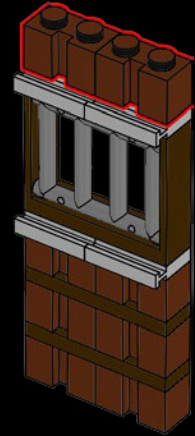

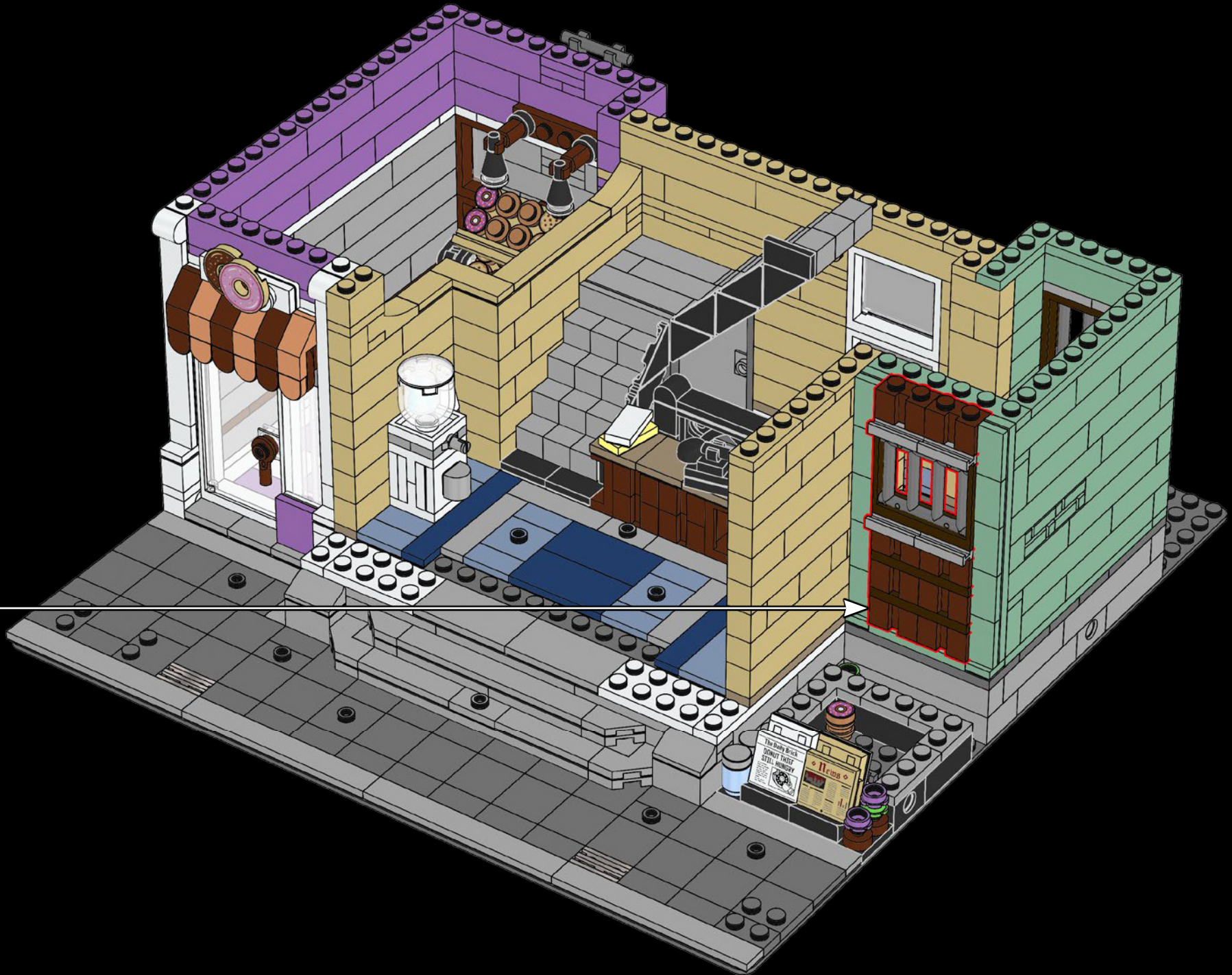



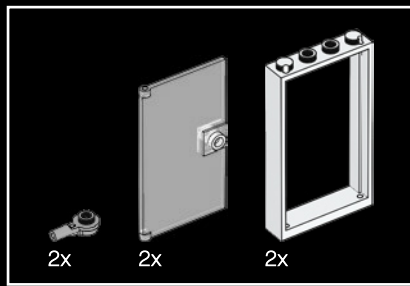

97

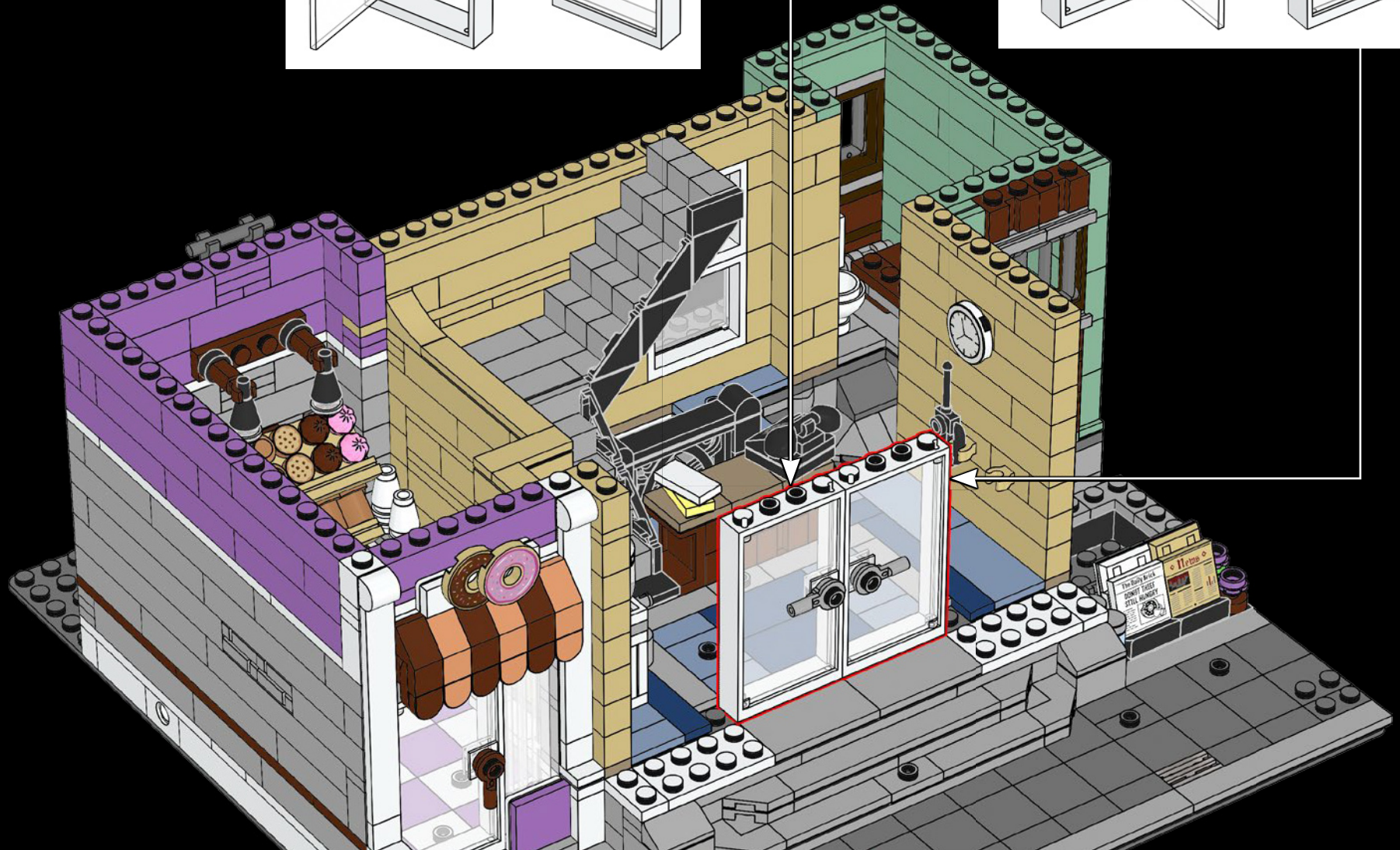
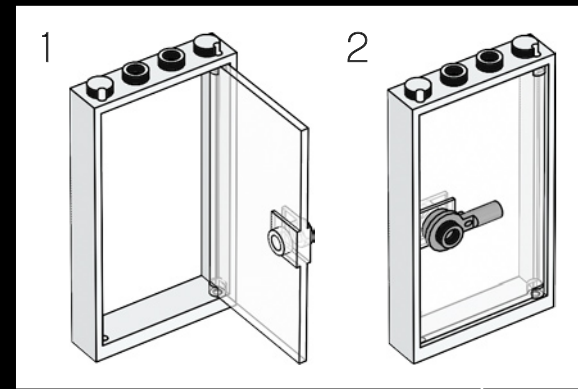
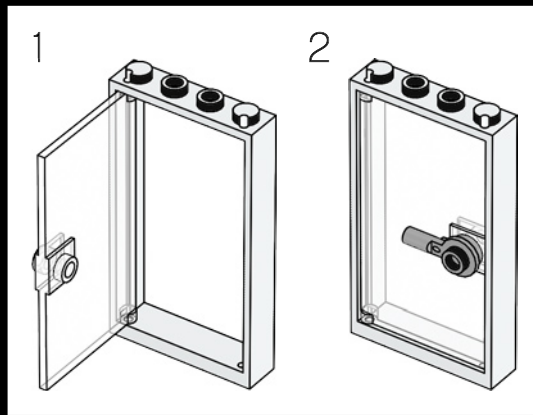





6x

98

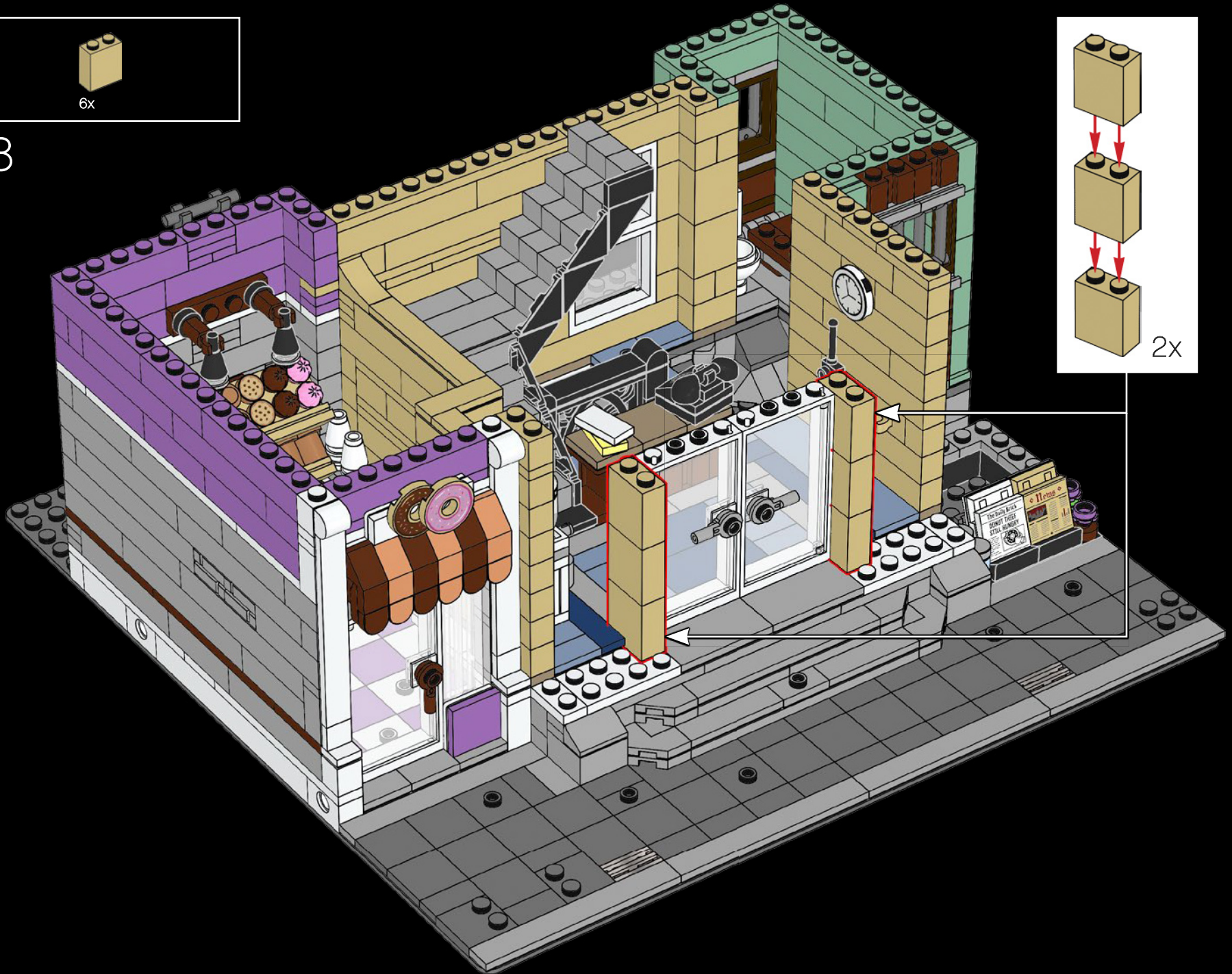

2x



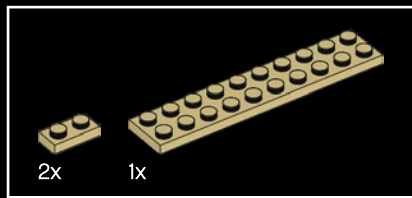

99

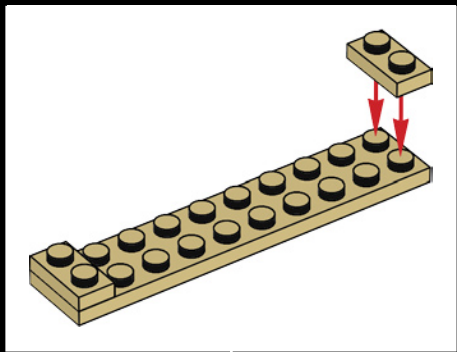
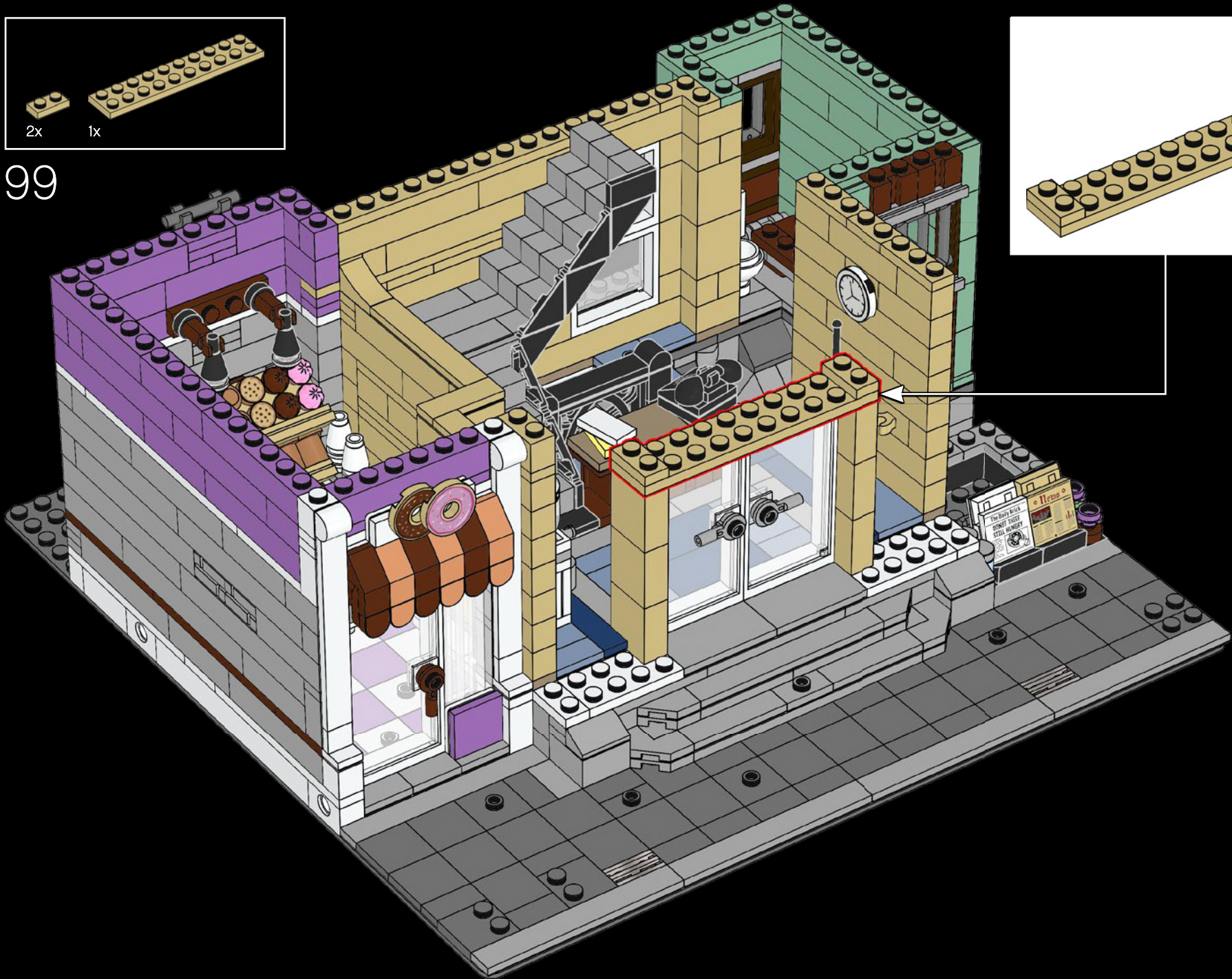

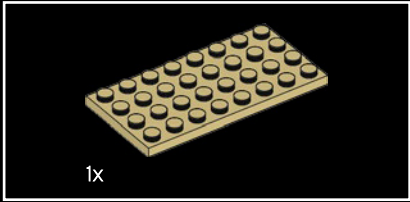

1x

100

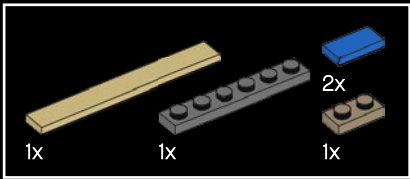
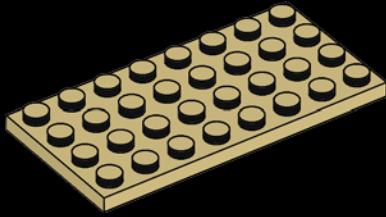

1x

1x

2x

1x

101

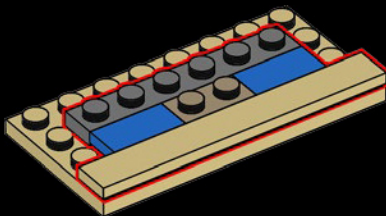

1x

1x

102

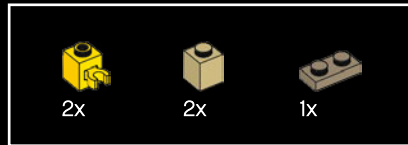
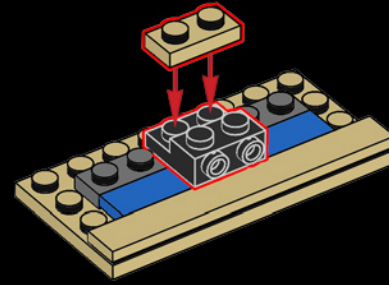

2x

2x

1x

103

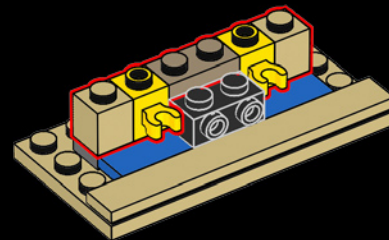



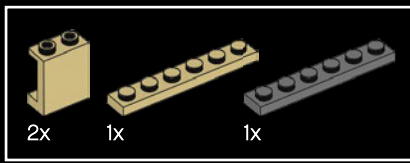

104

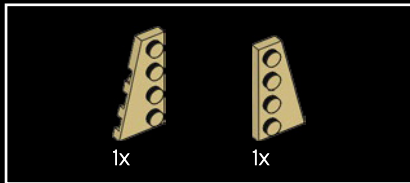
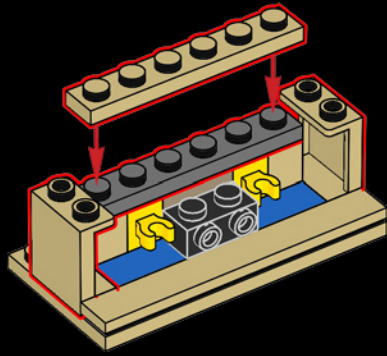

105

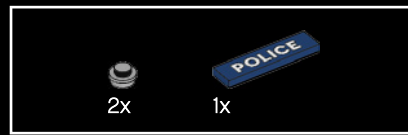
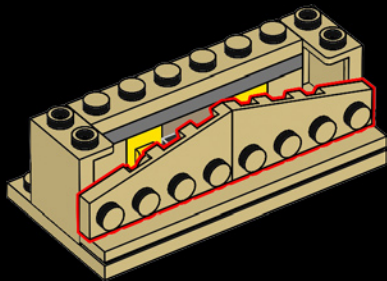

106

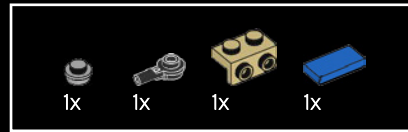
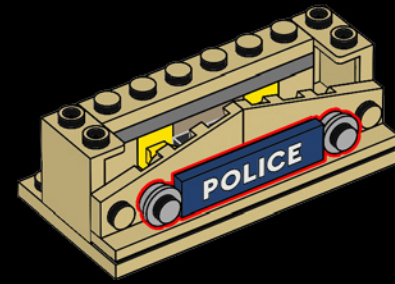

107

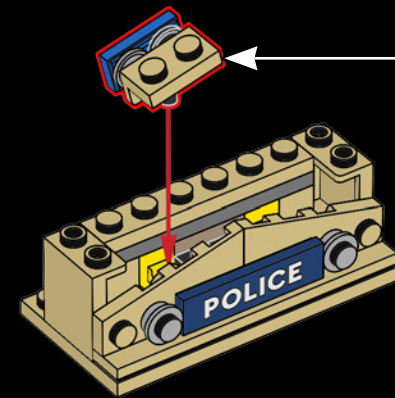



108

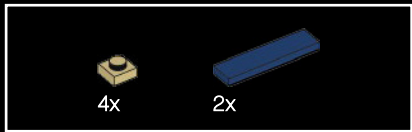
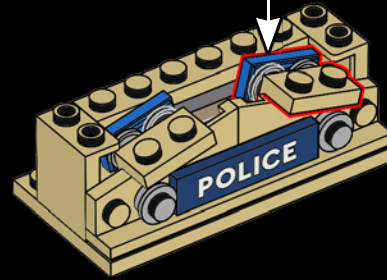
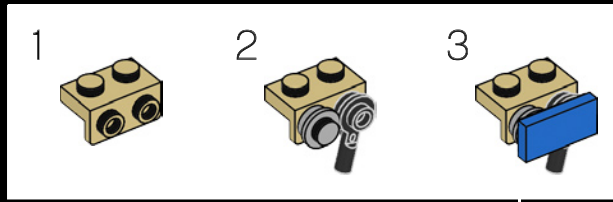

109

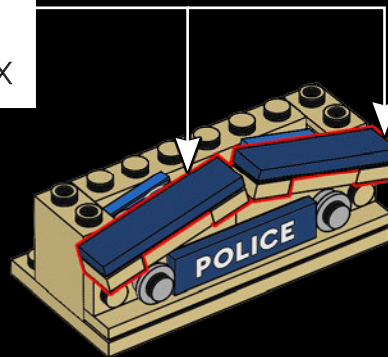
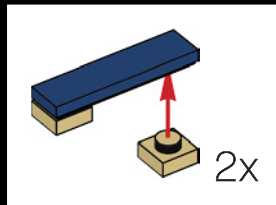



110

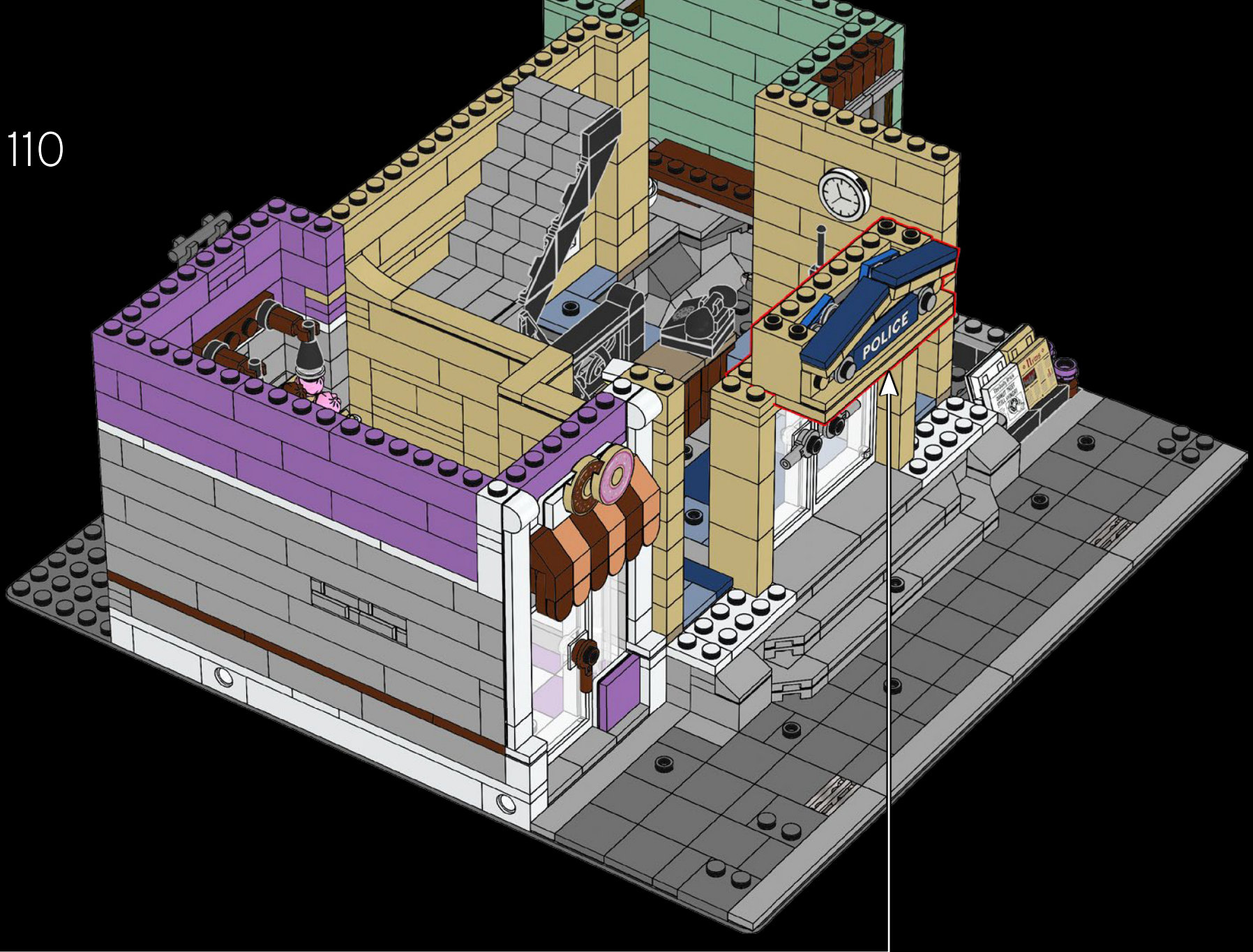



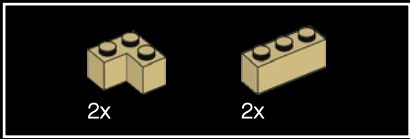

111





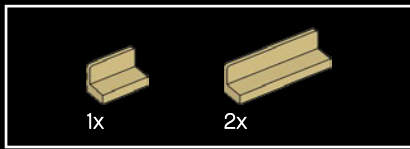

112





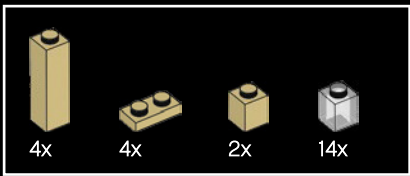

113

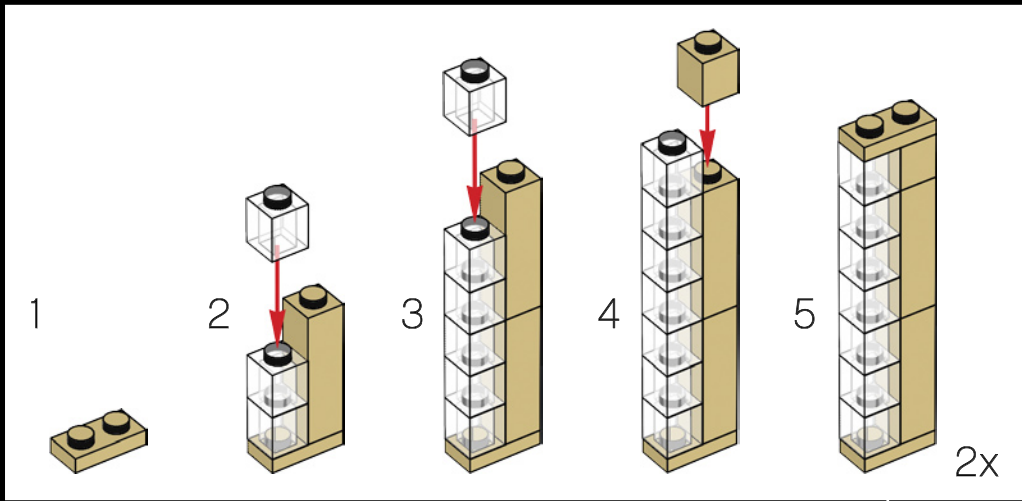
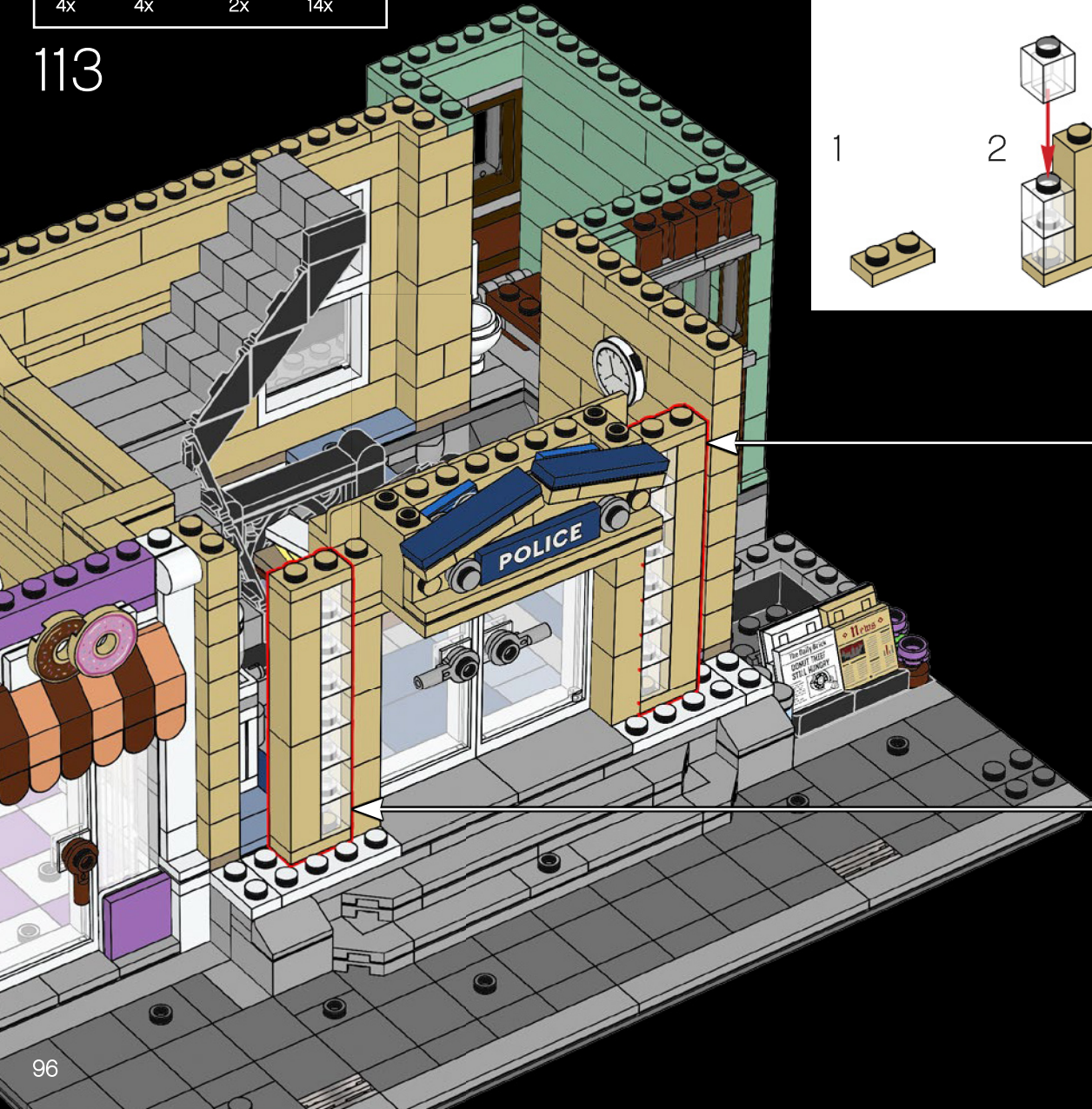



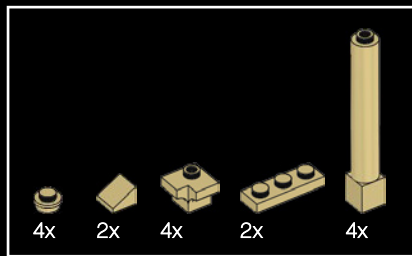

114

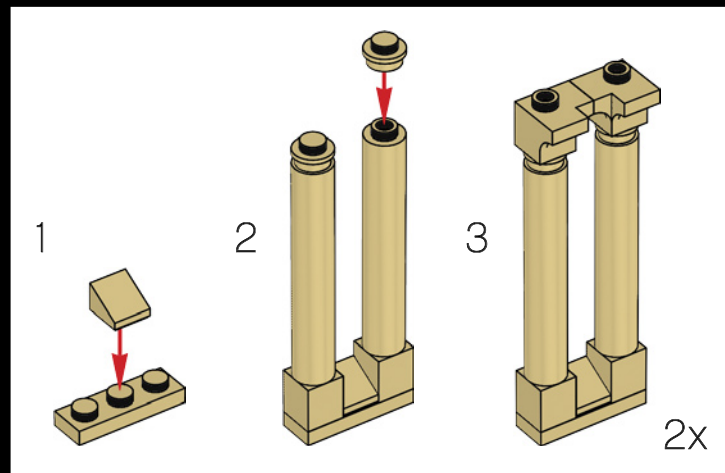
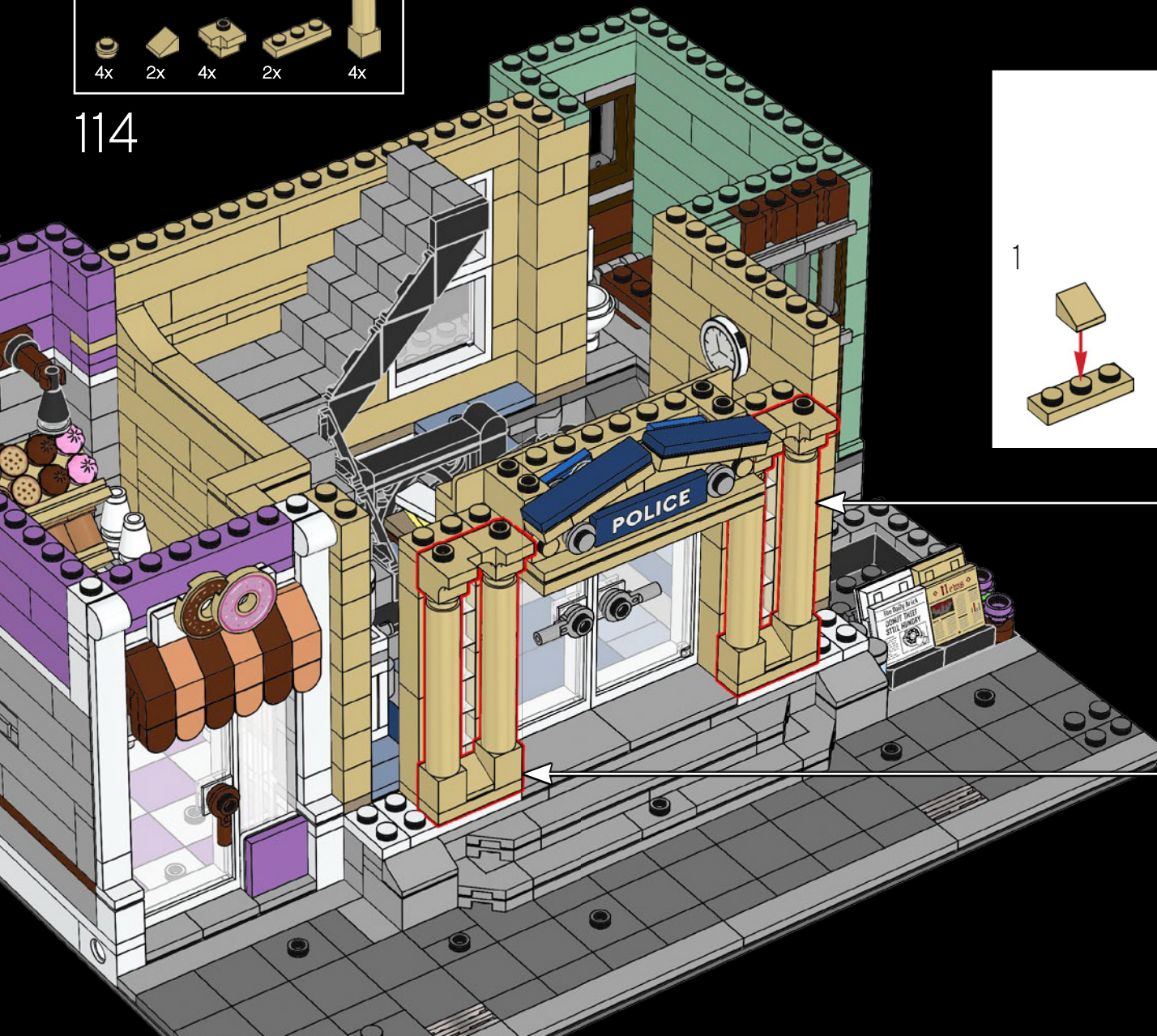

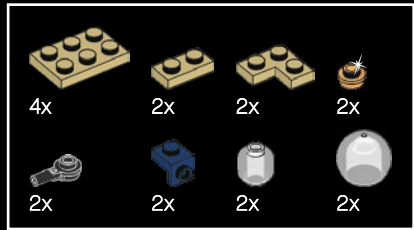

115

1



2

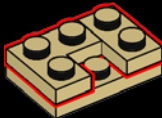

3

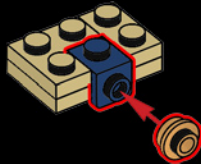

4



5

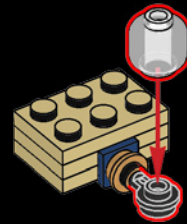

6





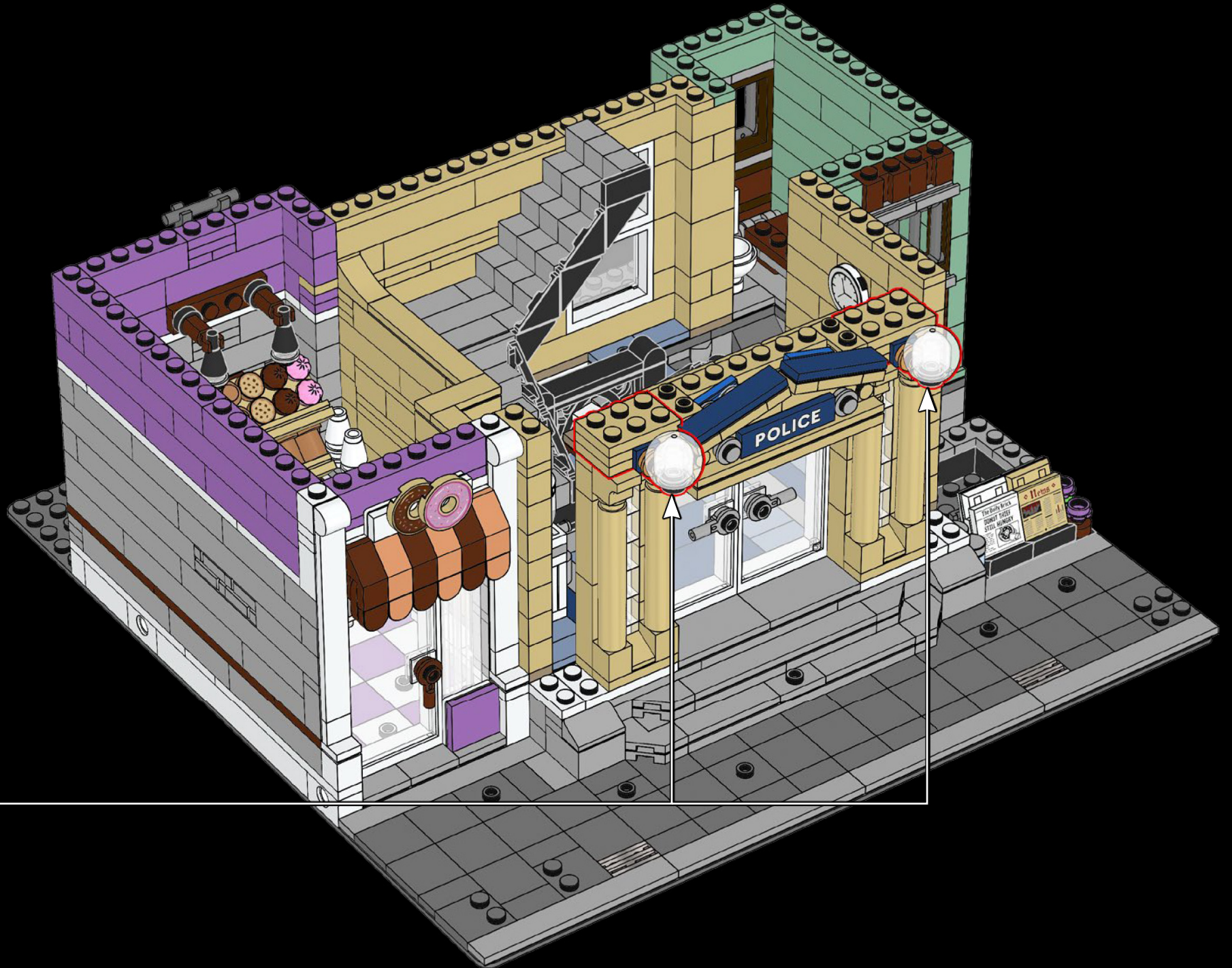

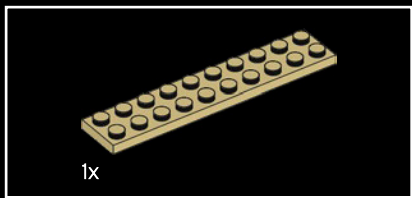

116

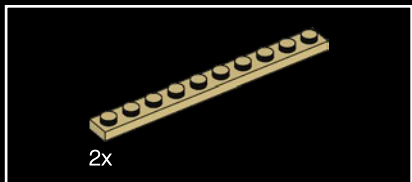
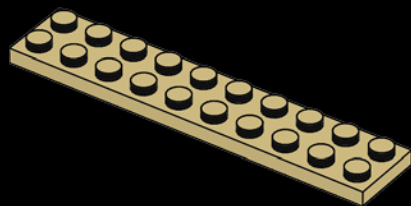

117

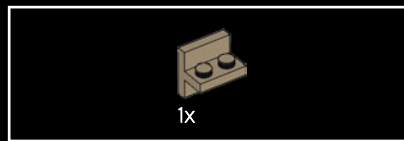
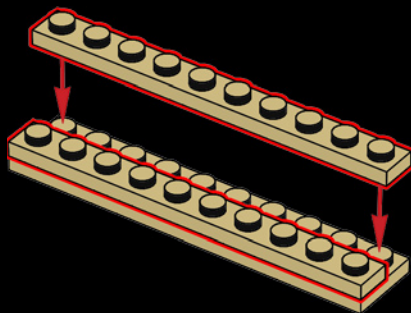

118

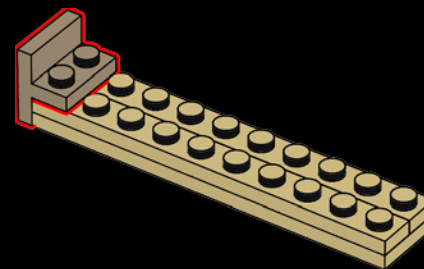



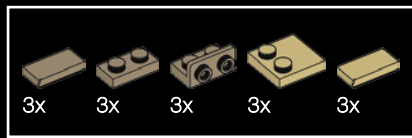

119

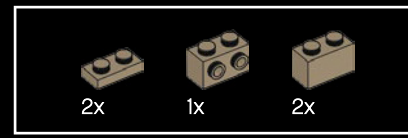
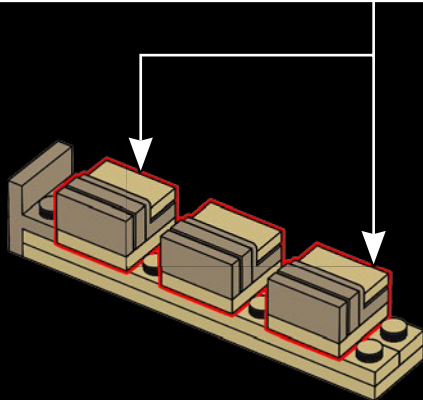
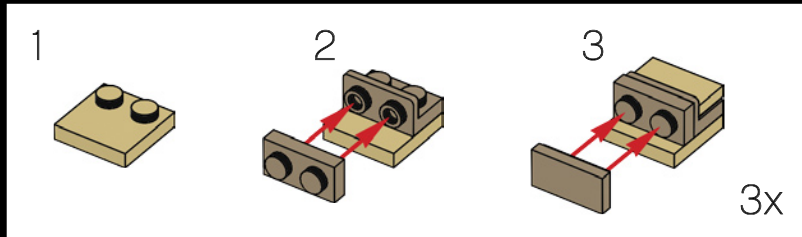

120

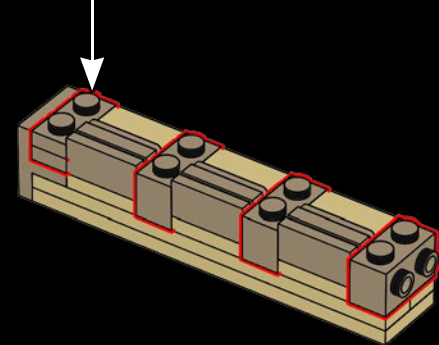
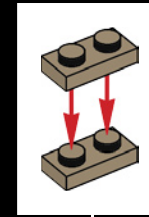

121

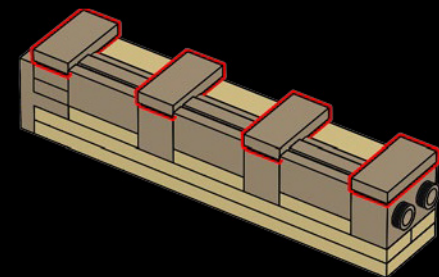

122

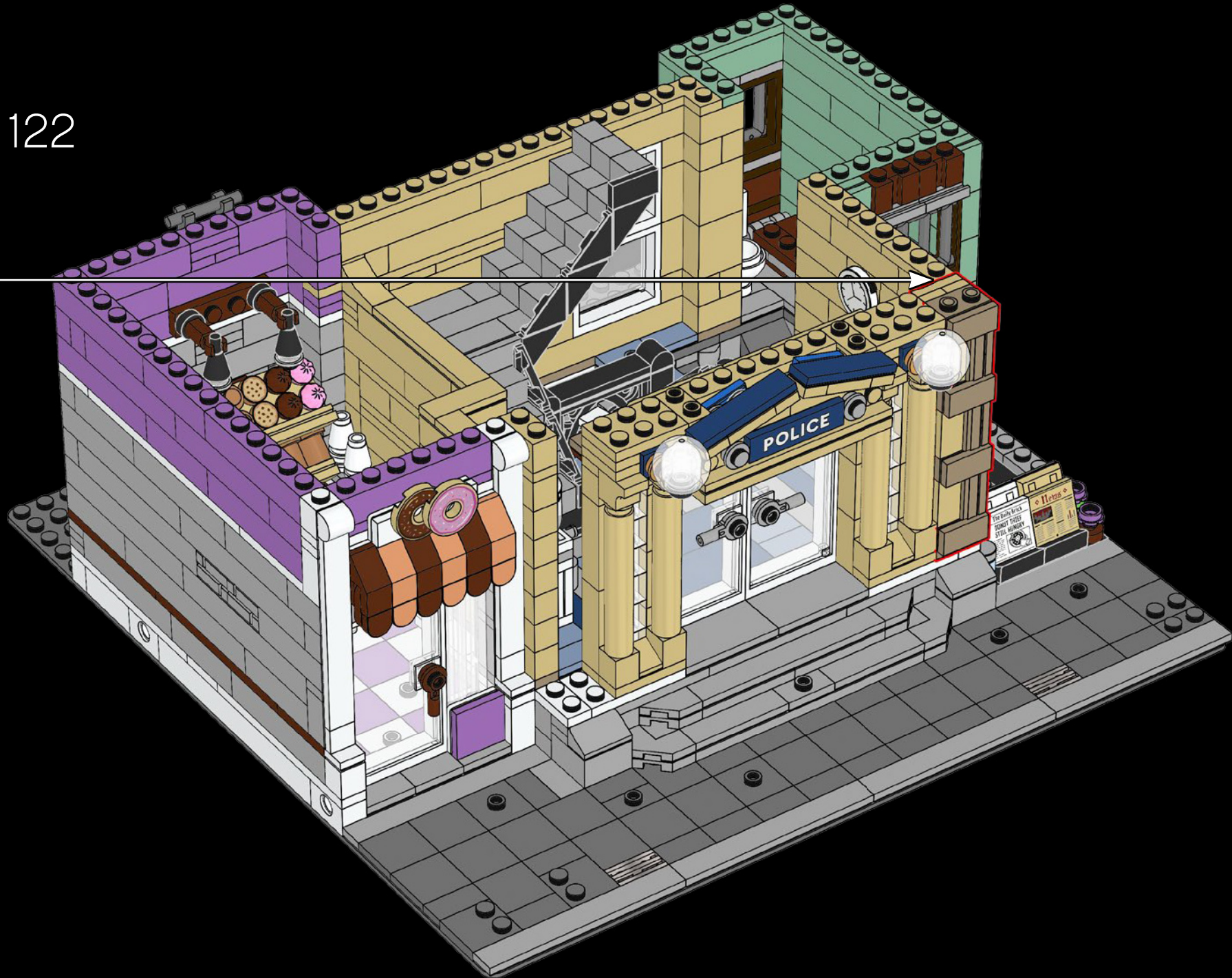



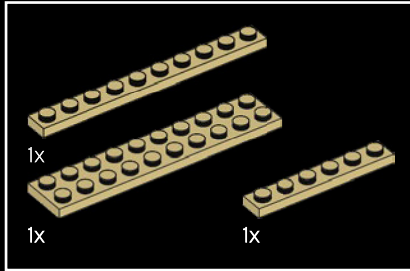
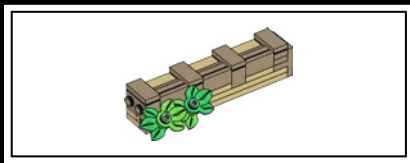

123

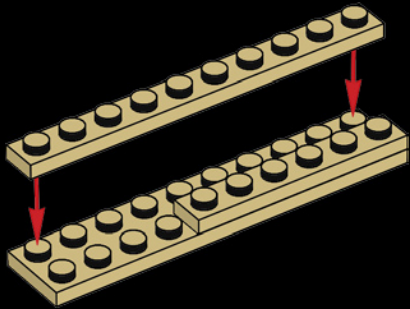

124

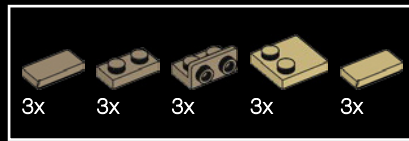
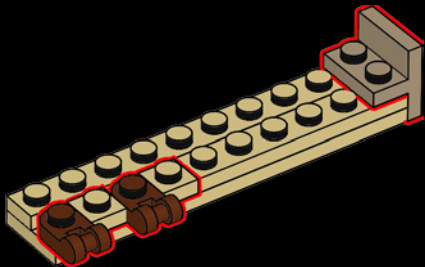

125

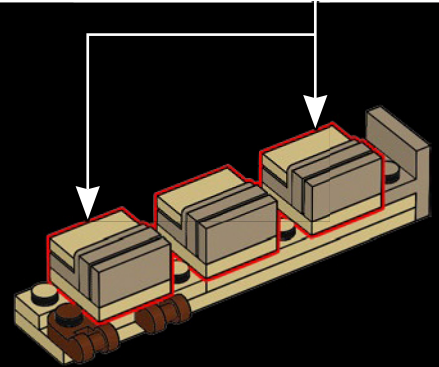
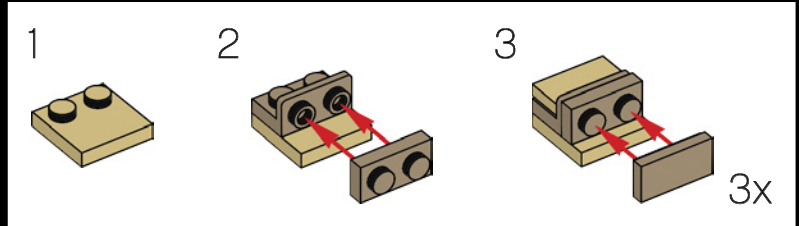

126

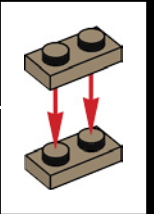
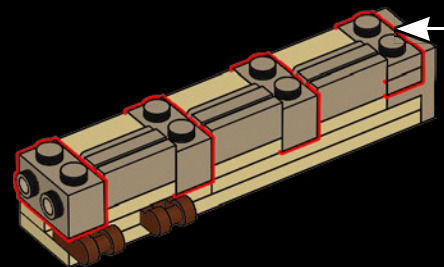



4x

127

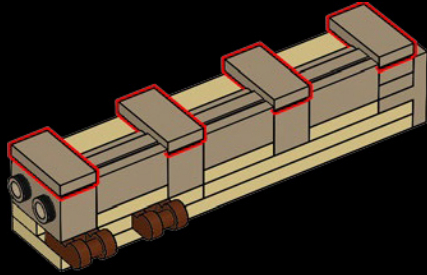

2x

128

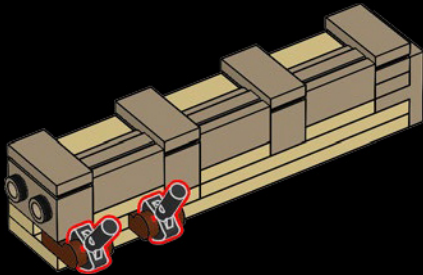

1x



1x

129

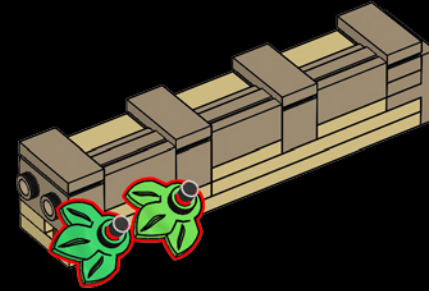

1x



1x

130

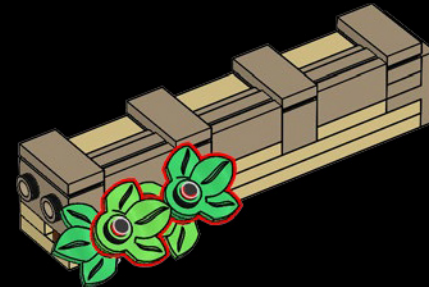



131

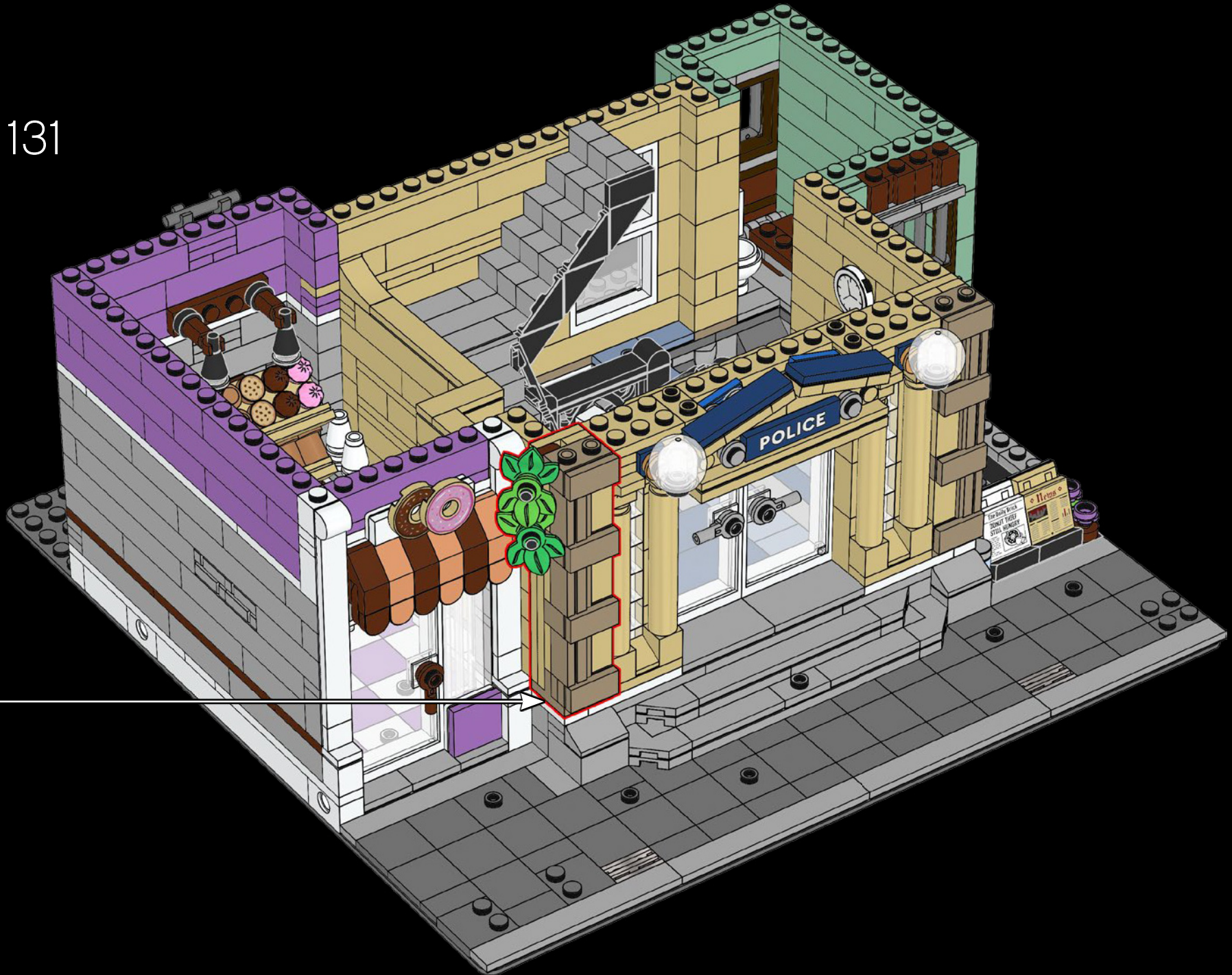

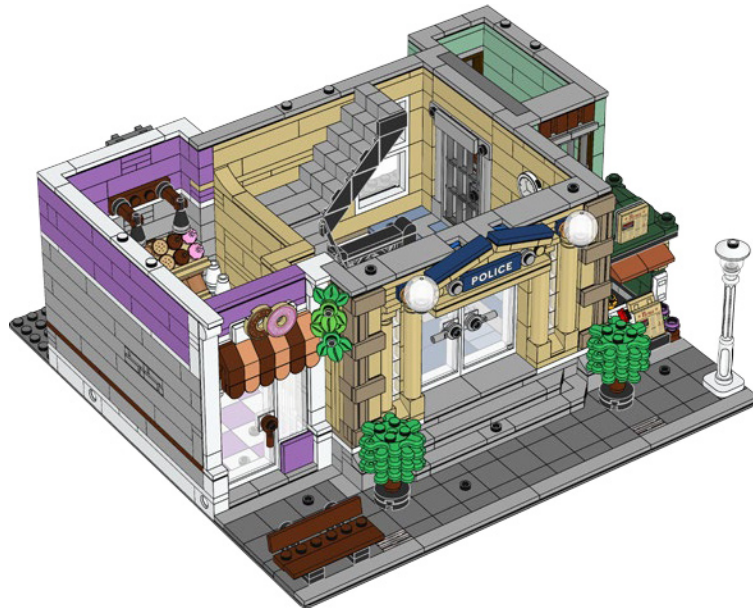



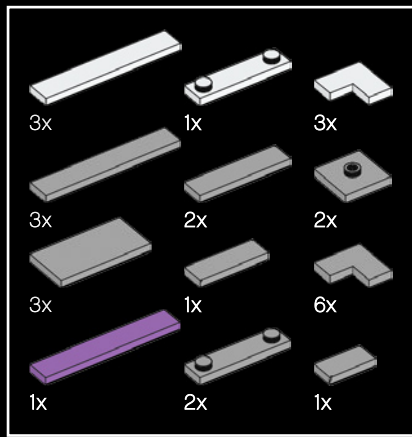

132

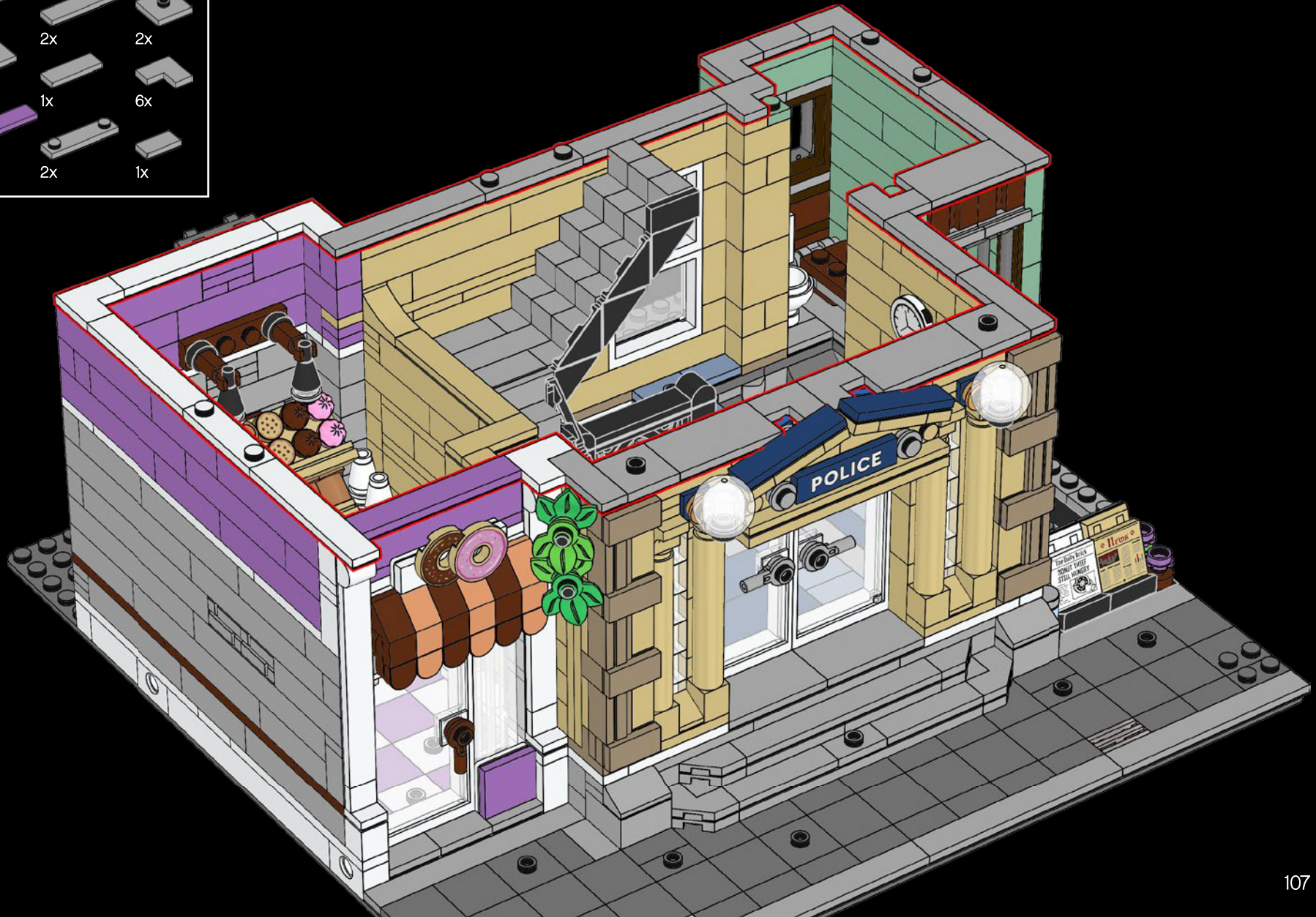

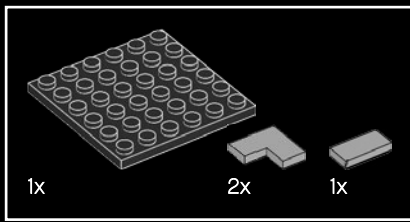

133

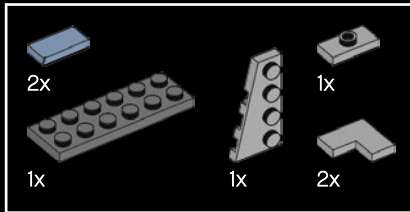
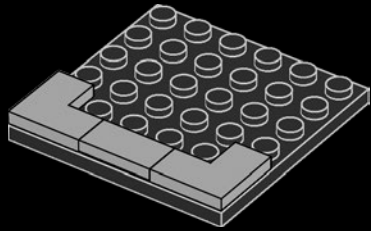

134

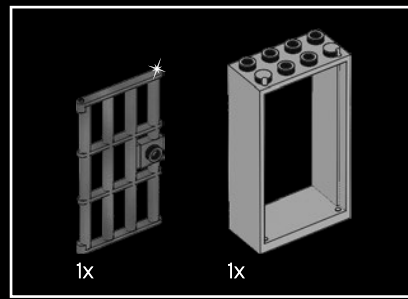
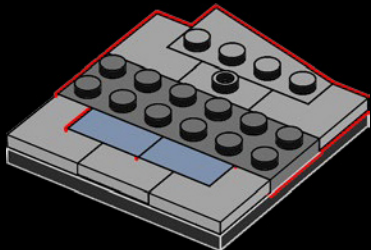

135

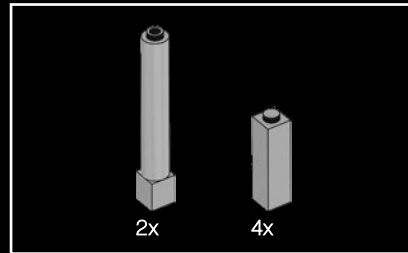
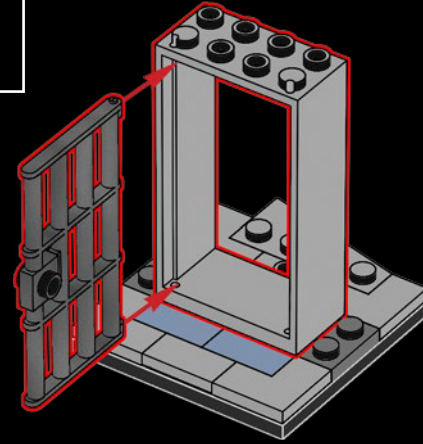

136

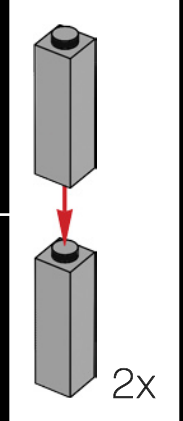
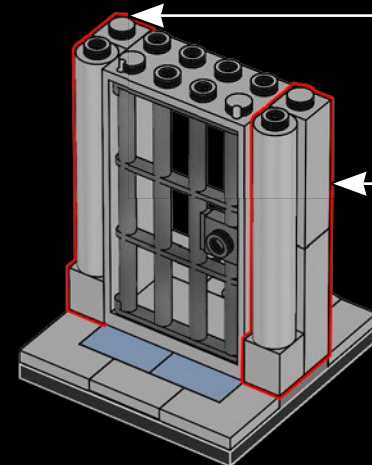



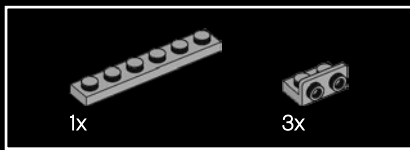

137

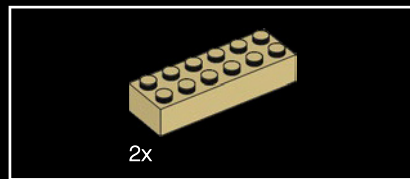
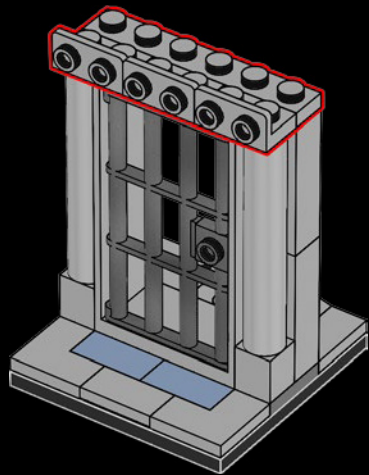

138

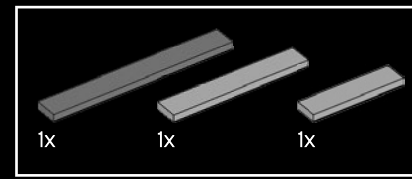
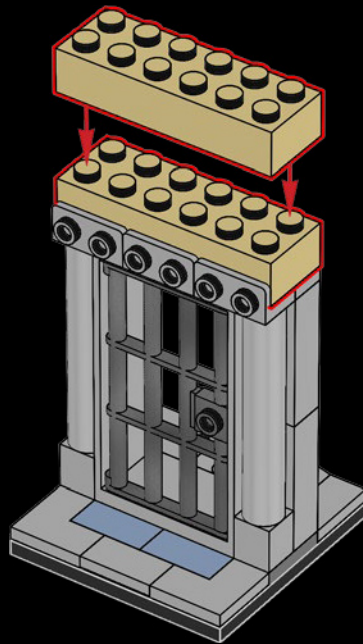

139

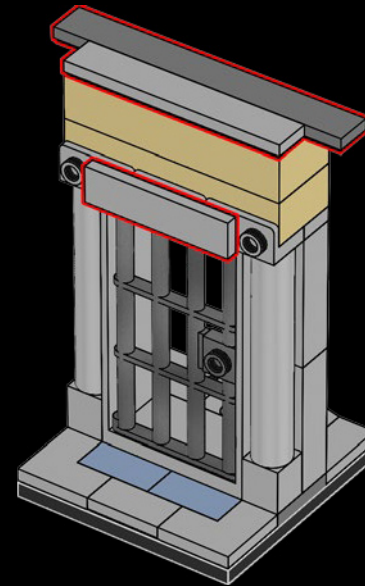

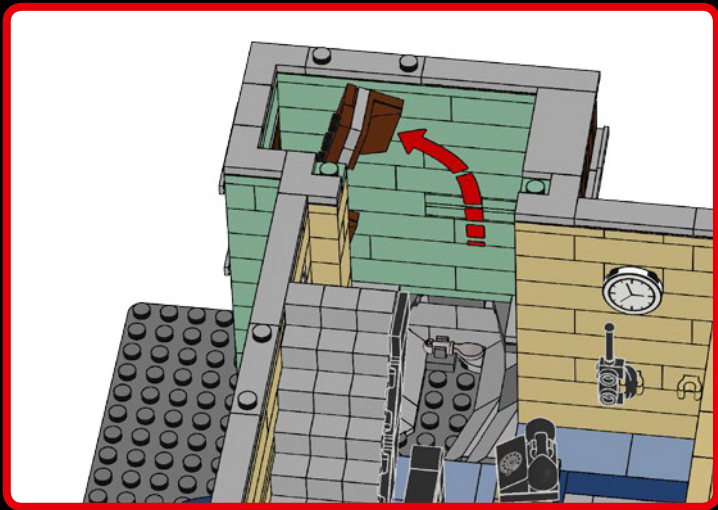

140





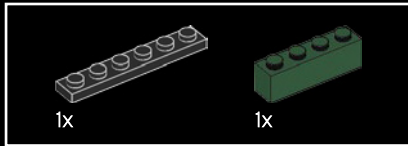
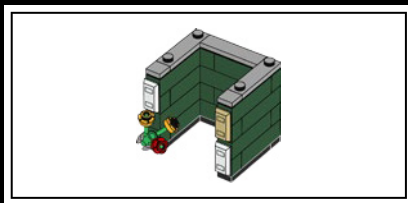

141

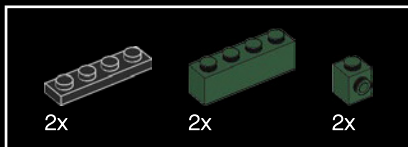
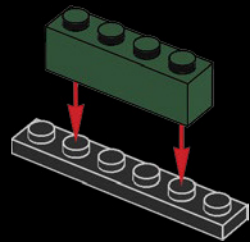

142

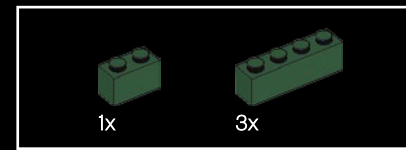
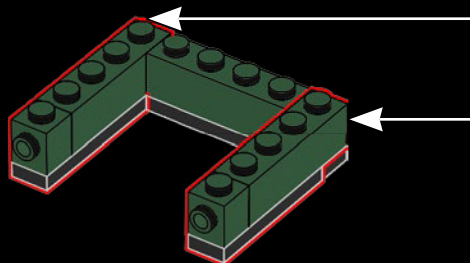
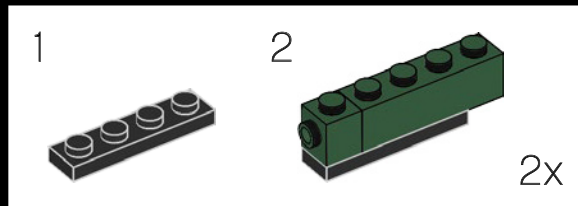

143

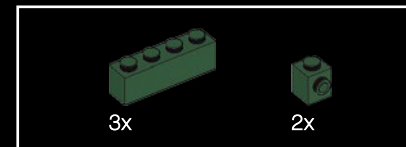
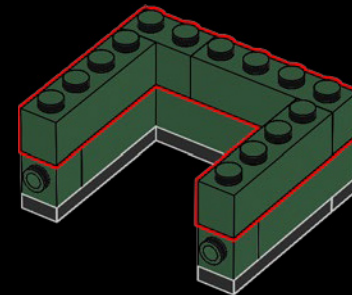

144

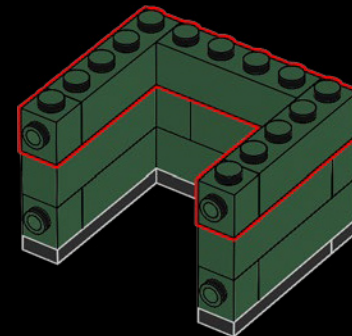

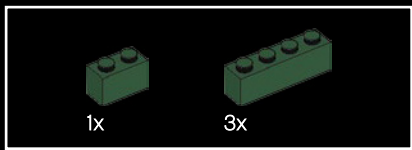

145

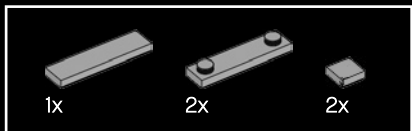
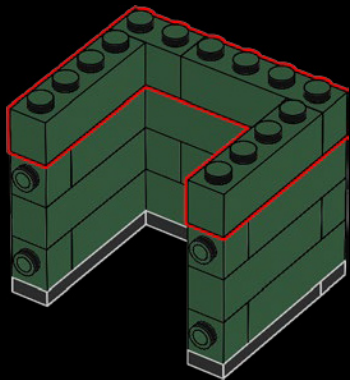

146

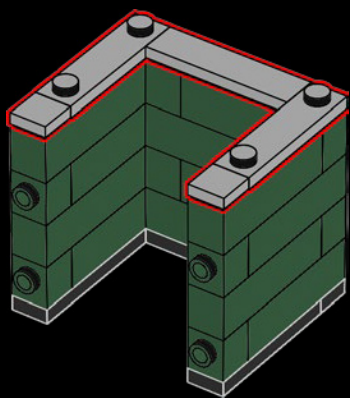

147

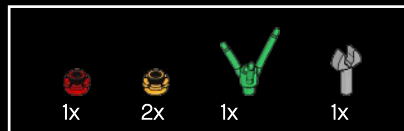
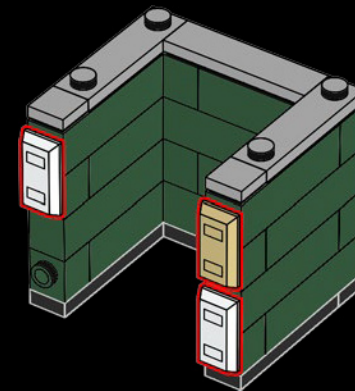

148

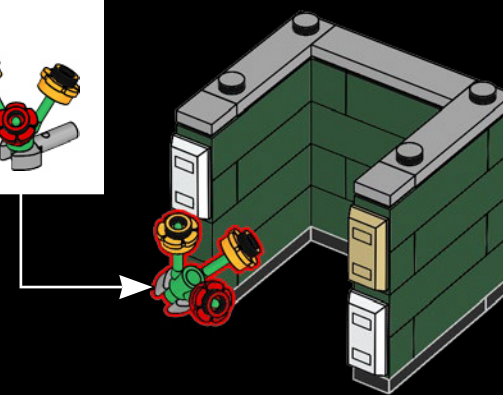
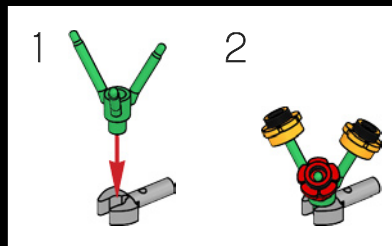



149



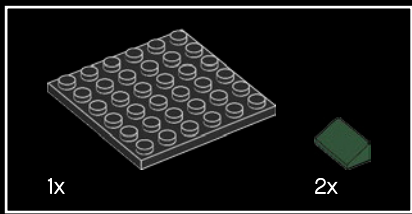

150

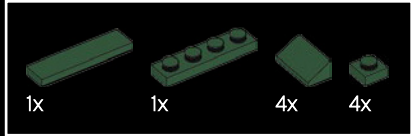
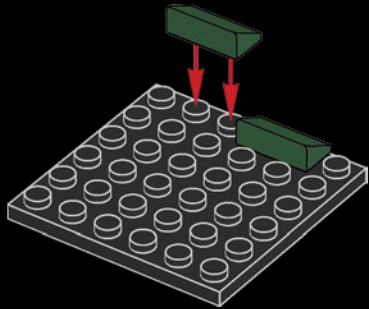

151

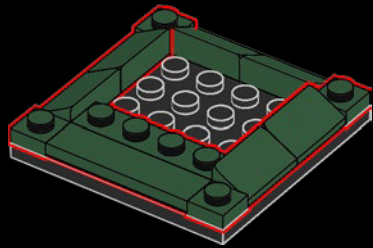

152

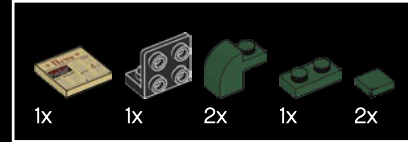
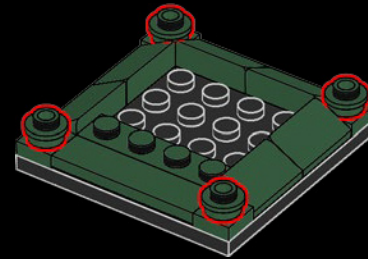

153

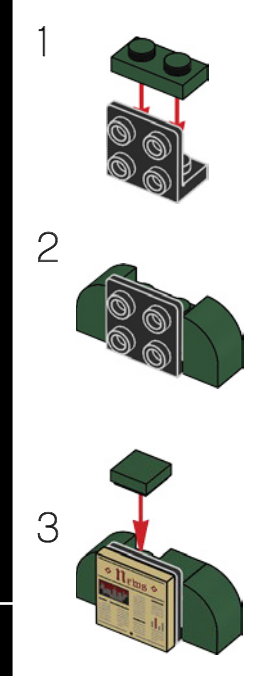
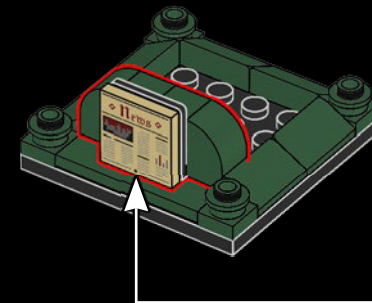



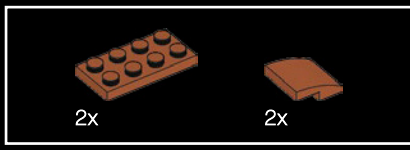

154

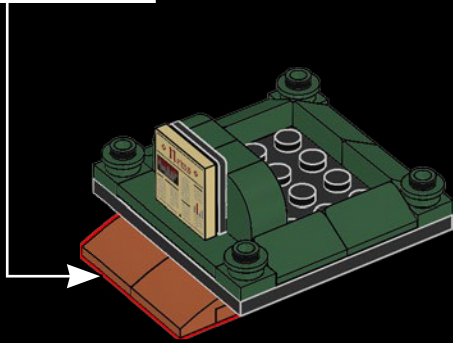
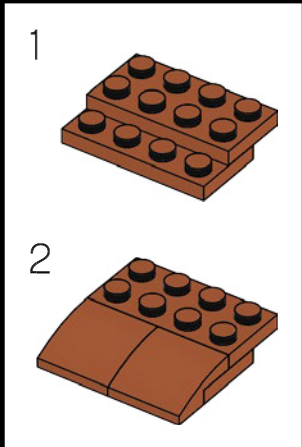

155







156

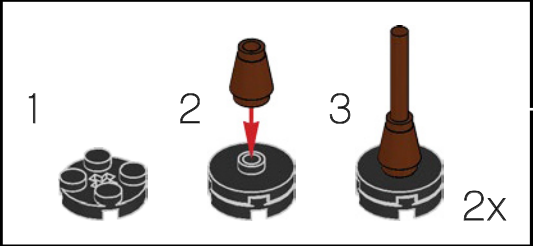
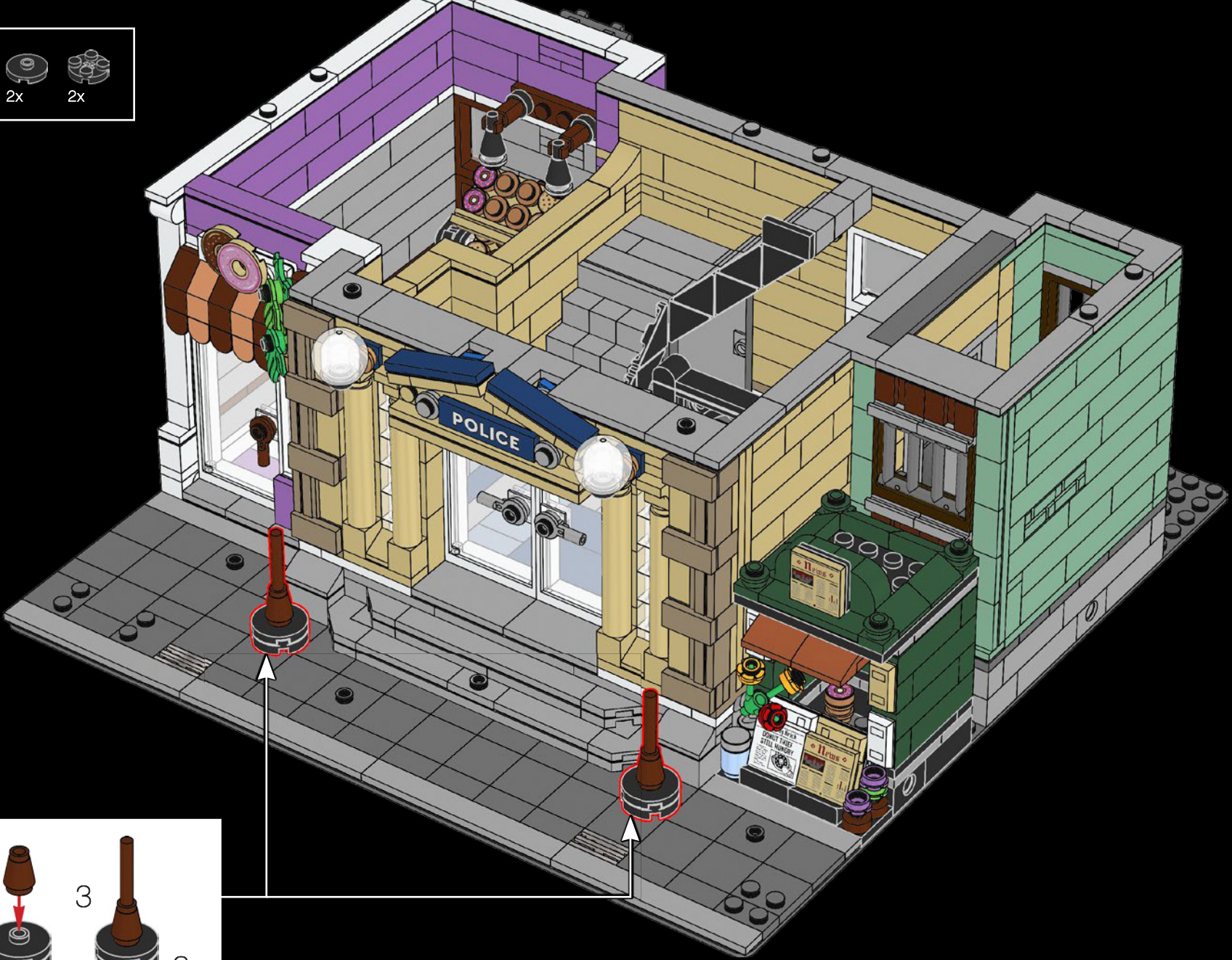





157

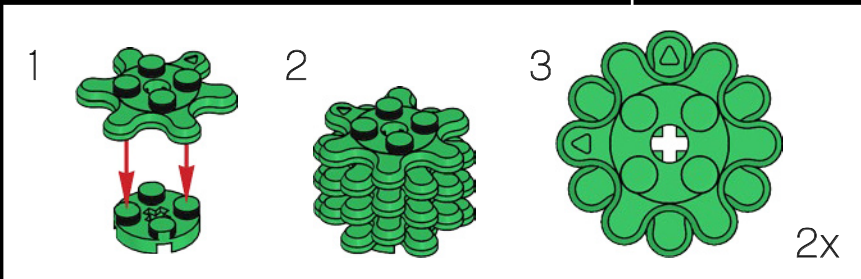

- These convincing brick-built trees were created with new gear parts!
- Ces arbres en briques convaincants ont été créés avec de nouvelles pièces d'engrenage !
- ¡Estos convincentes arbolitos de bricks se crean usando unos engranajes nuevos!





158

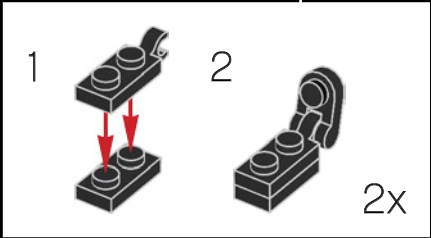



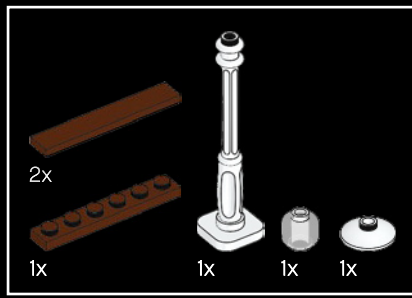

159

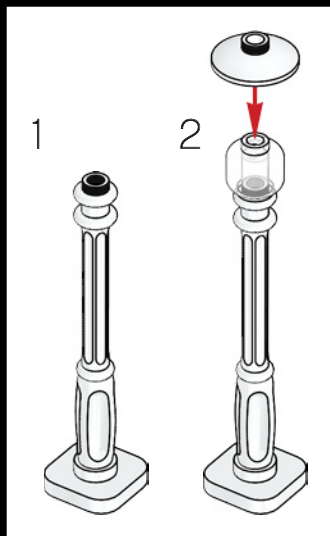

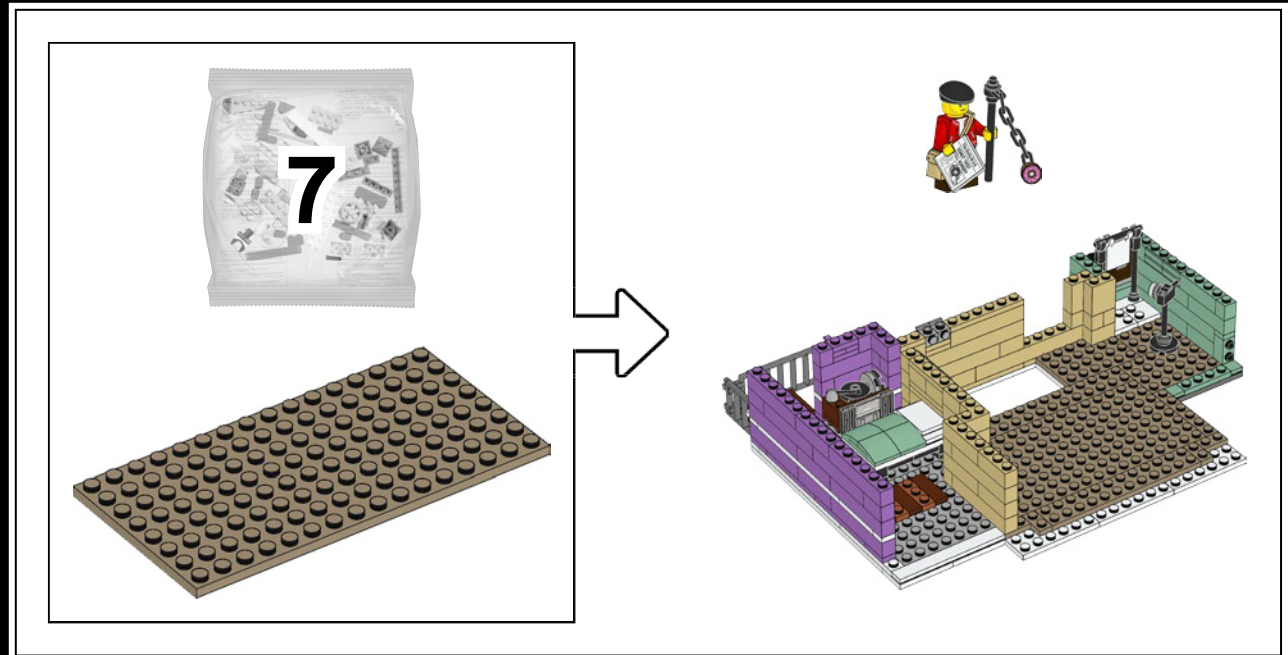

- Our newsstand operator full of big ideas and tall tales.
- Le commis du kiosque à journaux a plein de grandes idées et d'histoires invraisemblables à raconter.
- El dueño del puesto de periódicos está lleno de grandes ideas e historias de altura.

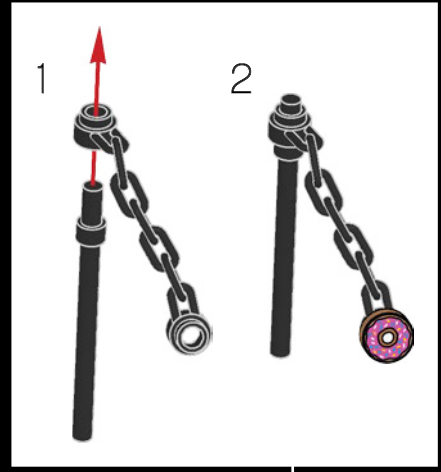
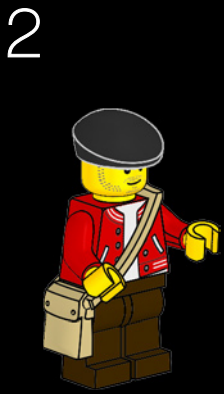
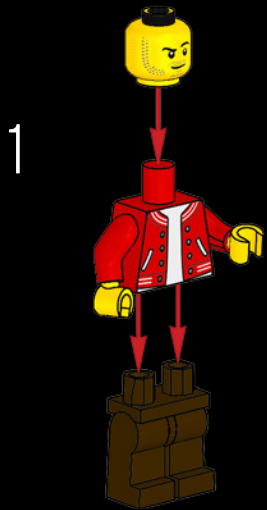



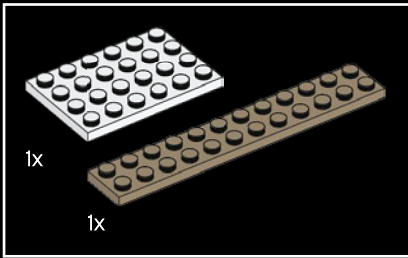
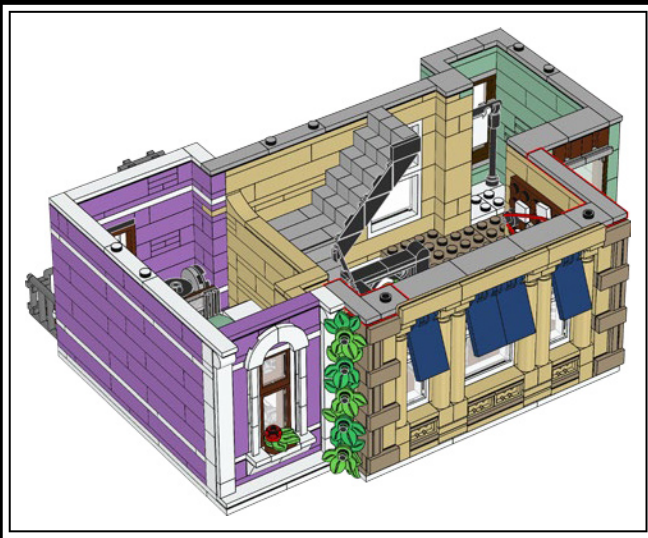

160

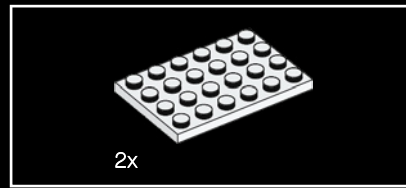
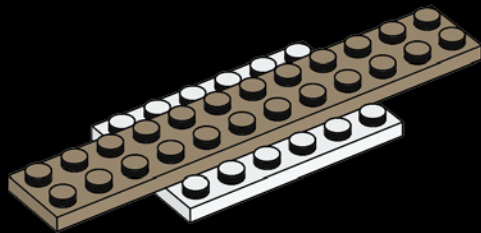

161

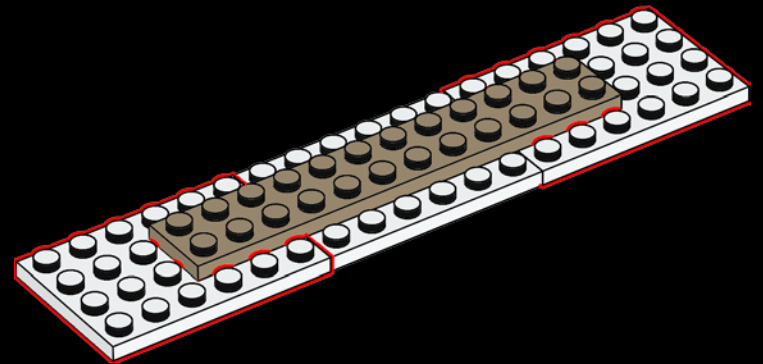

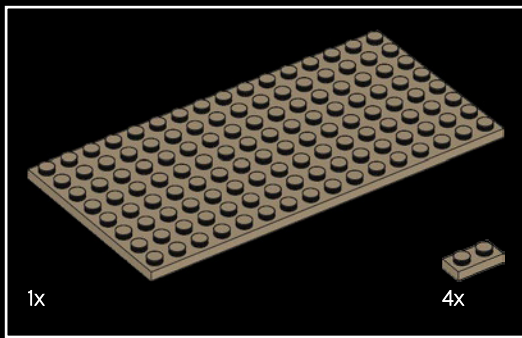

162

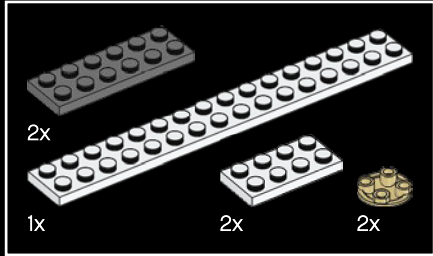
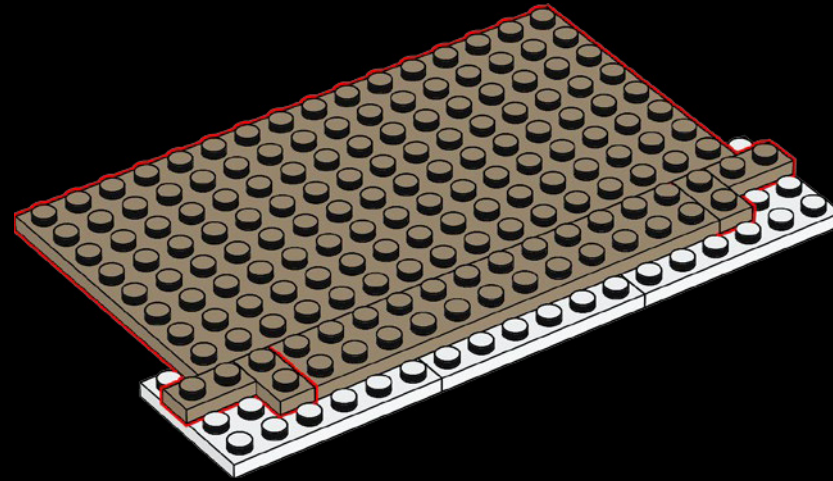

163

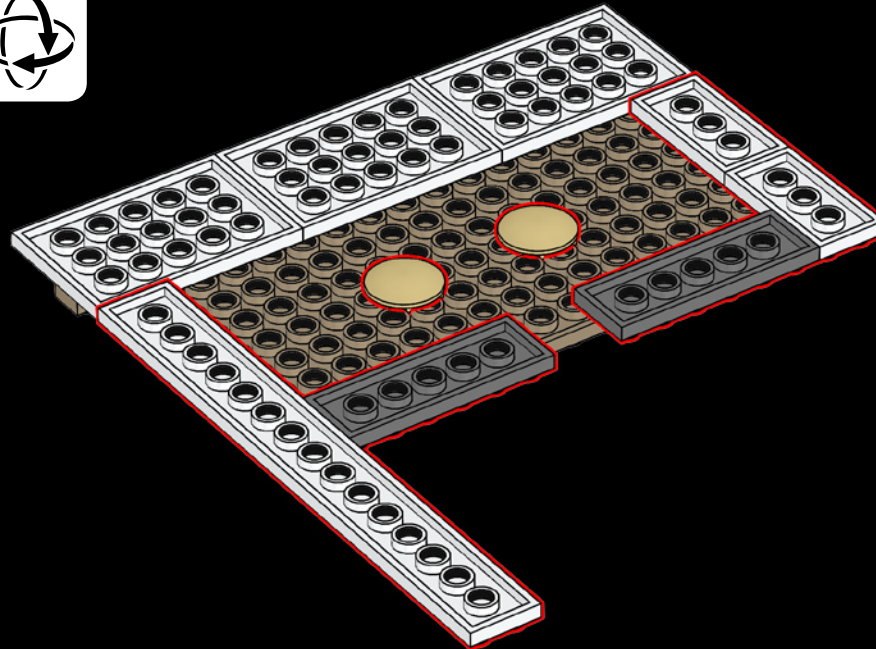



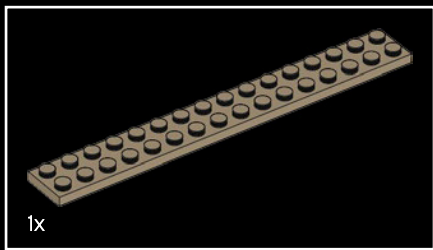

164

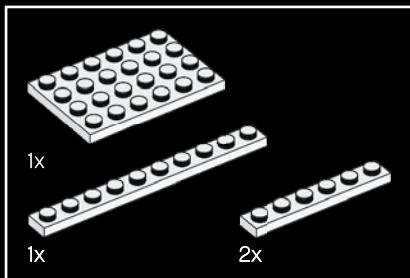
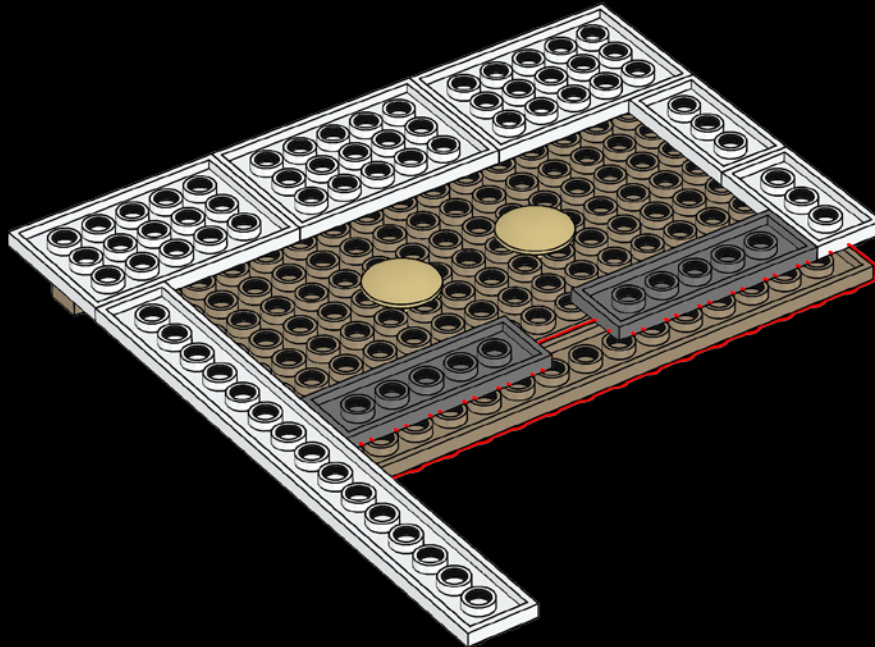

165

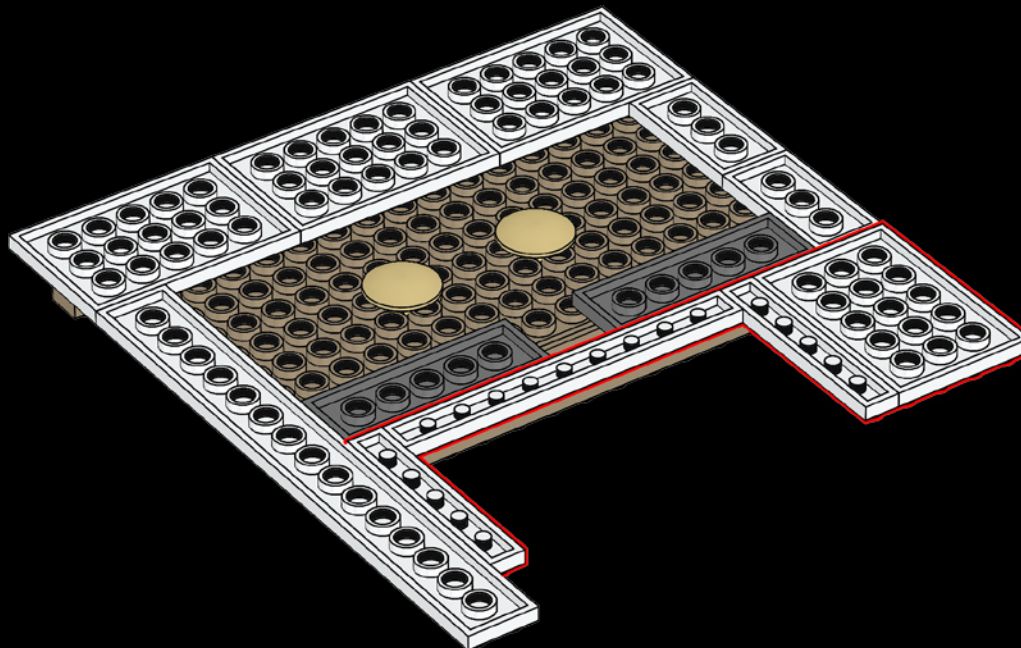

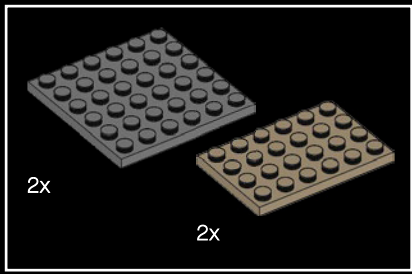

166

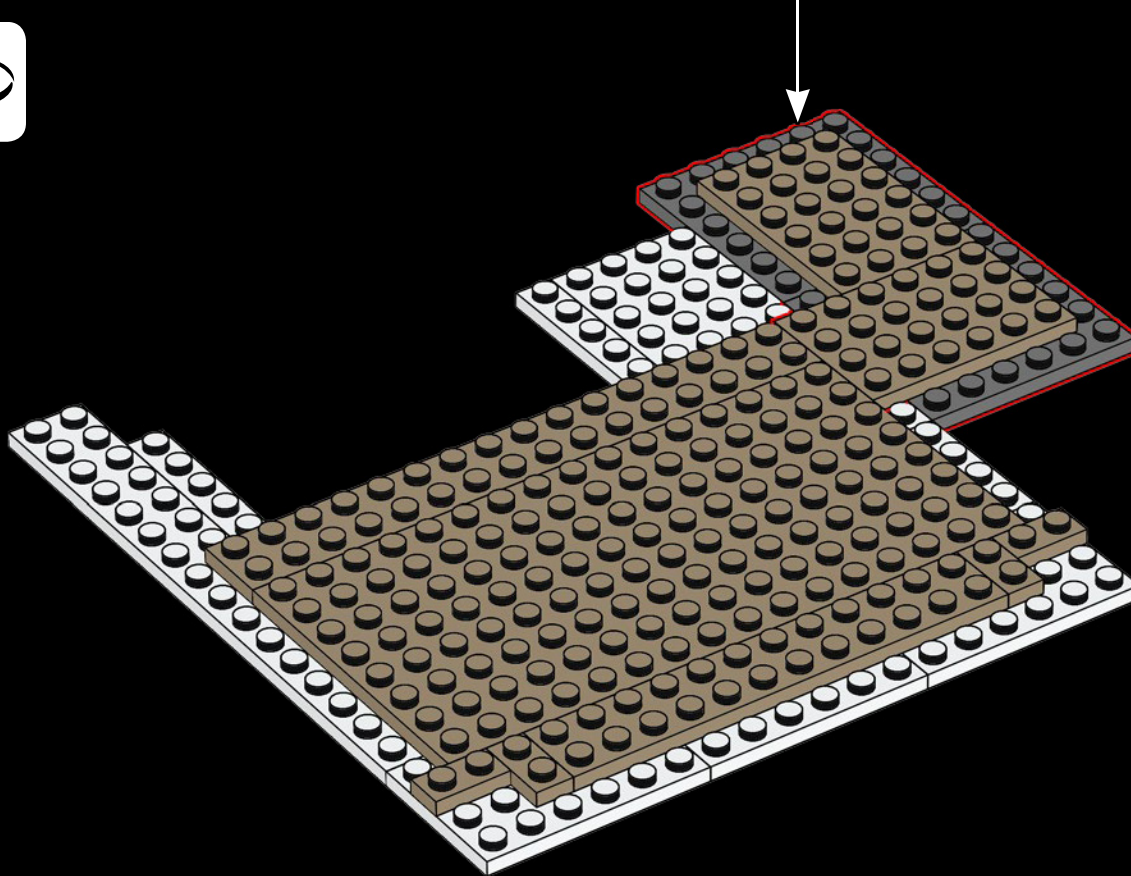
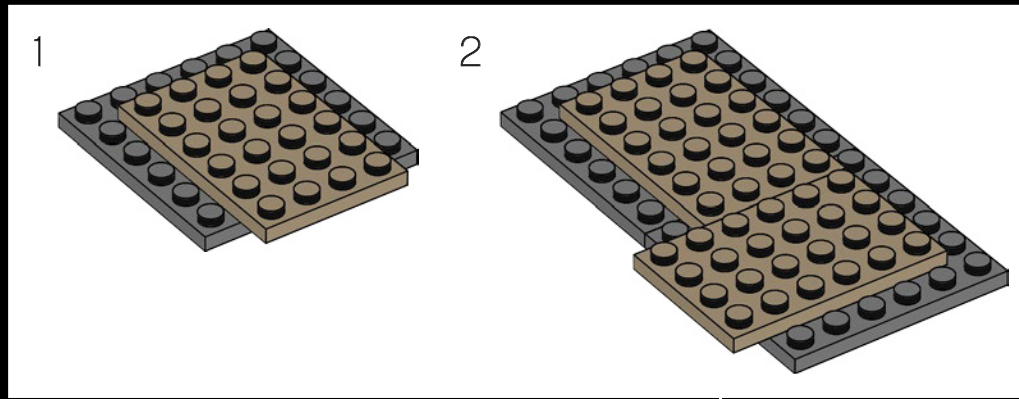



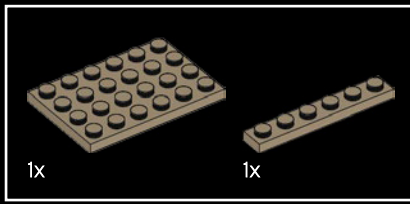

167

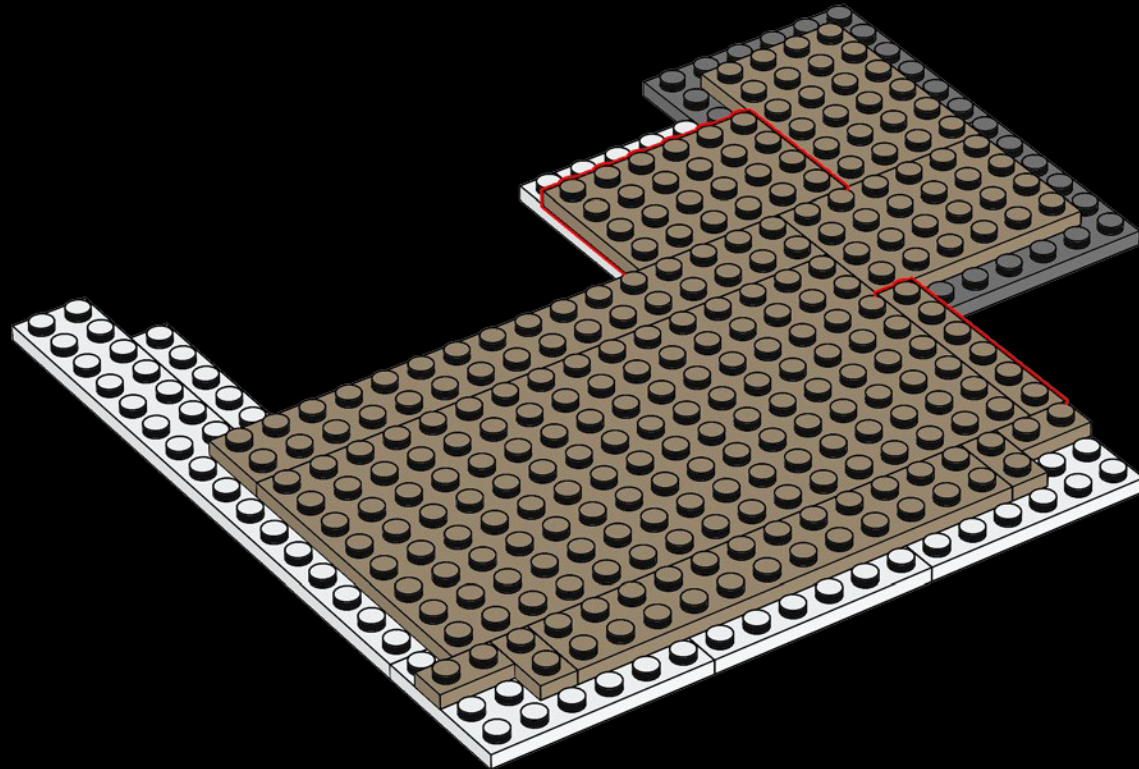

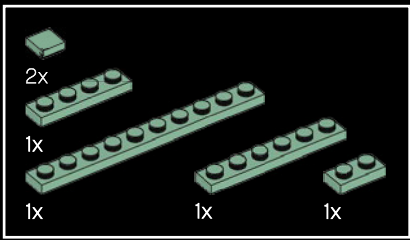

168

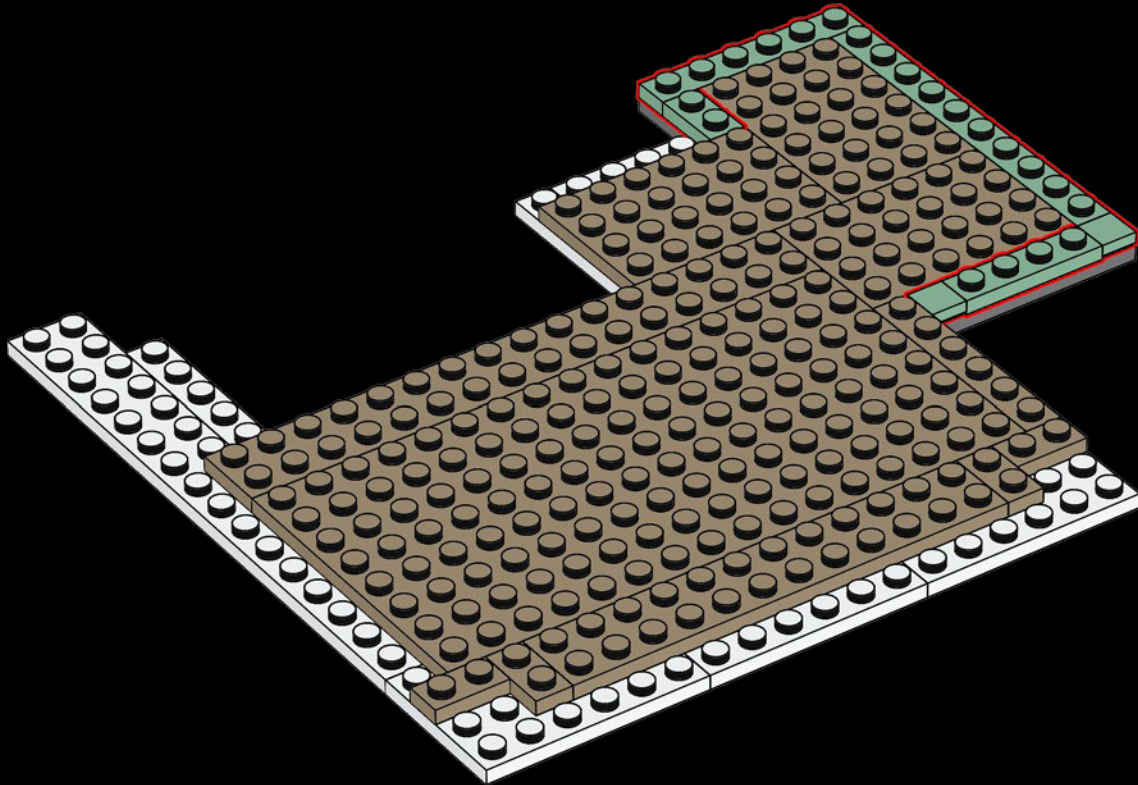



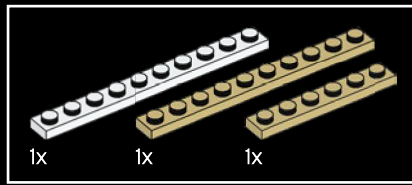

169

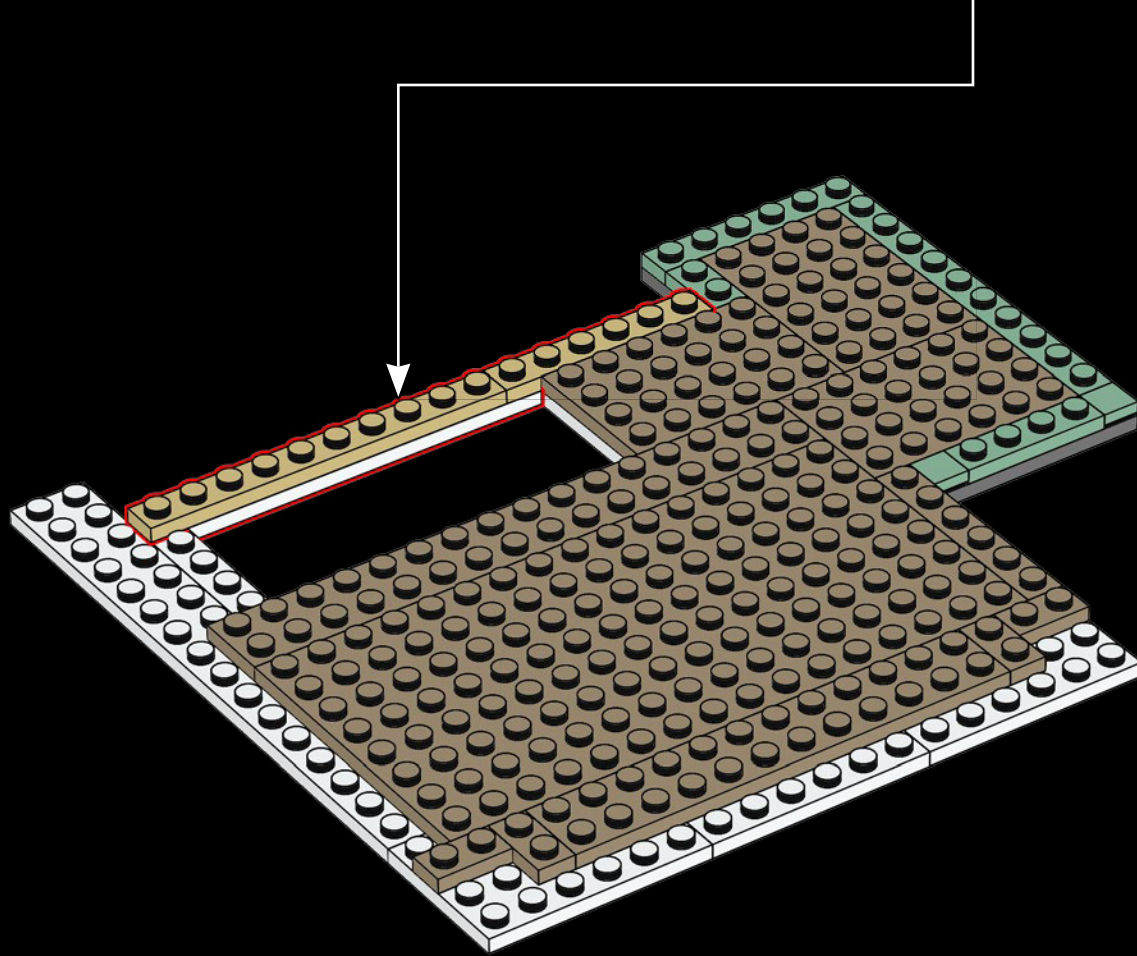
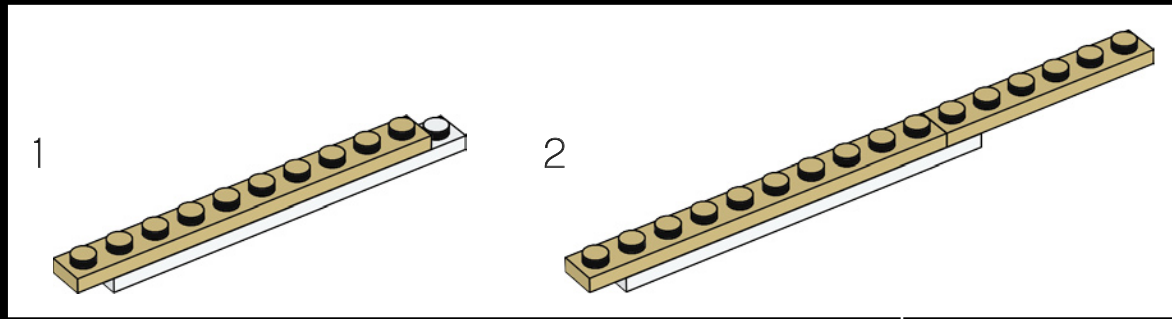

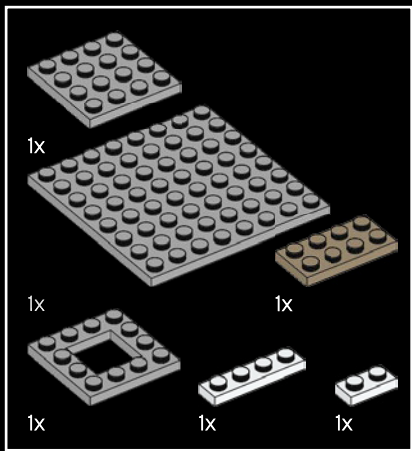

170

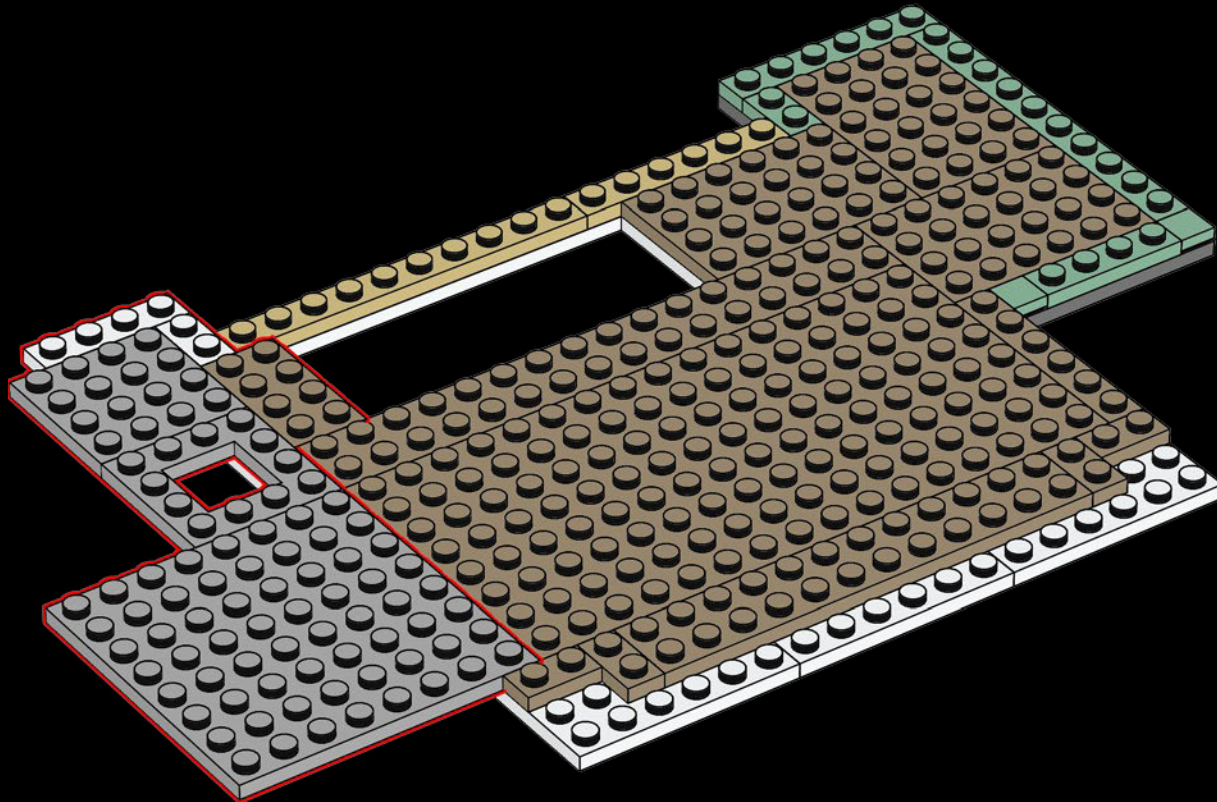



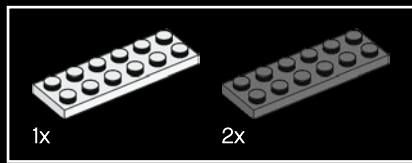

171

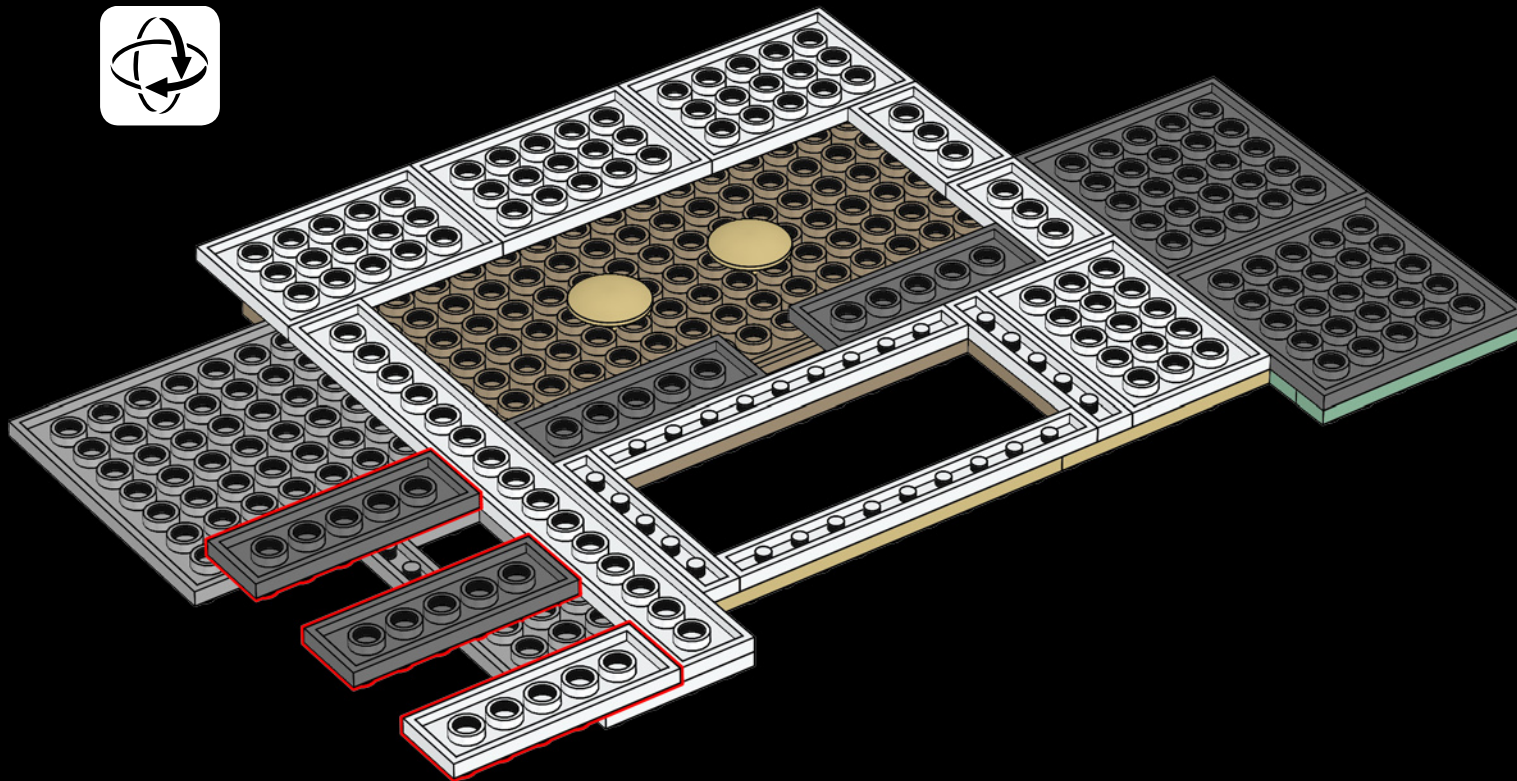

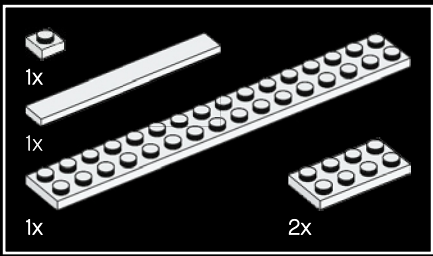

172

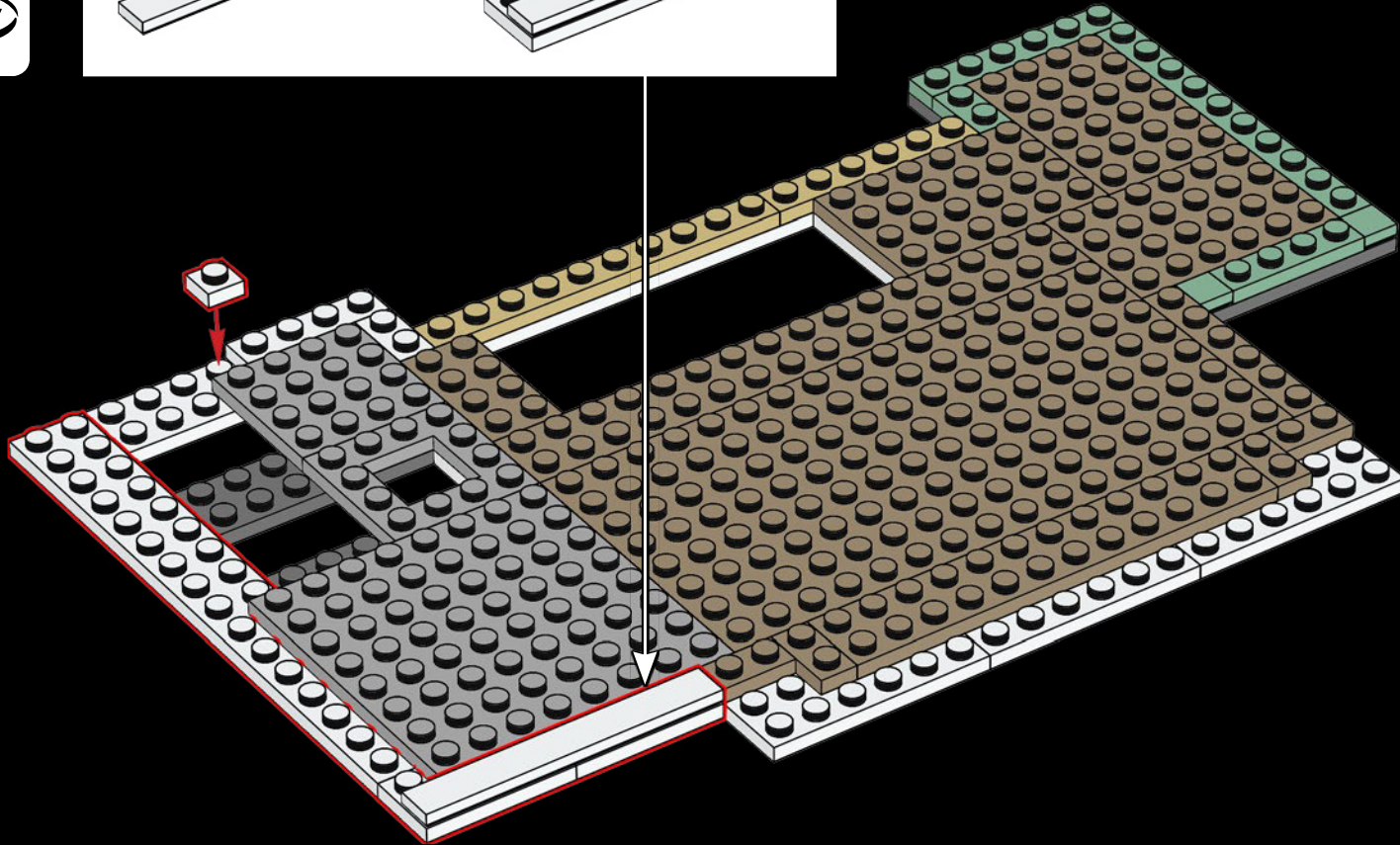
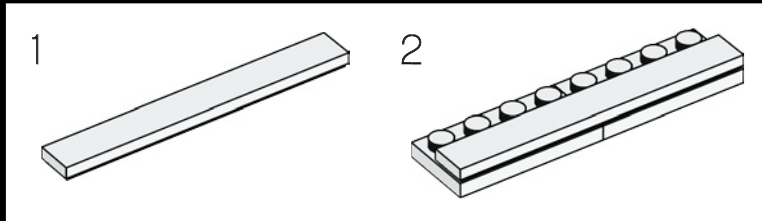



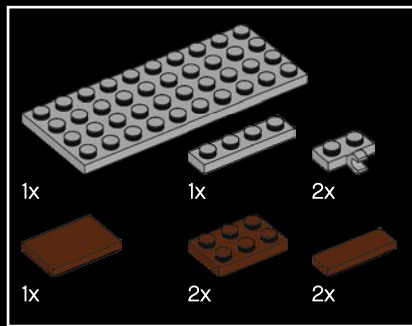

173

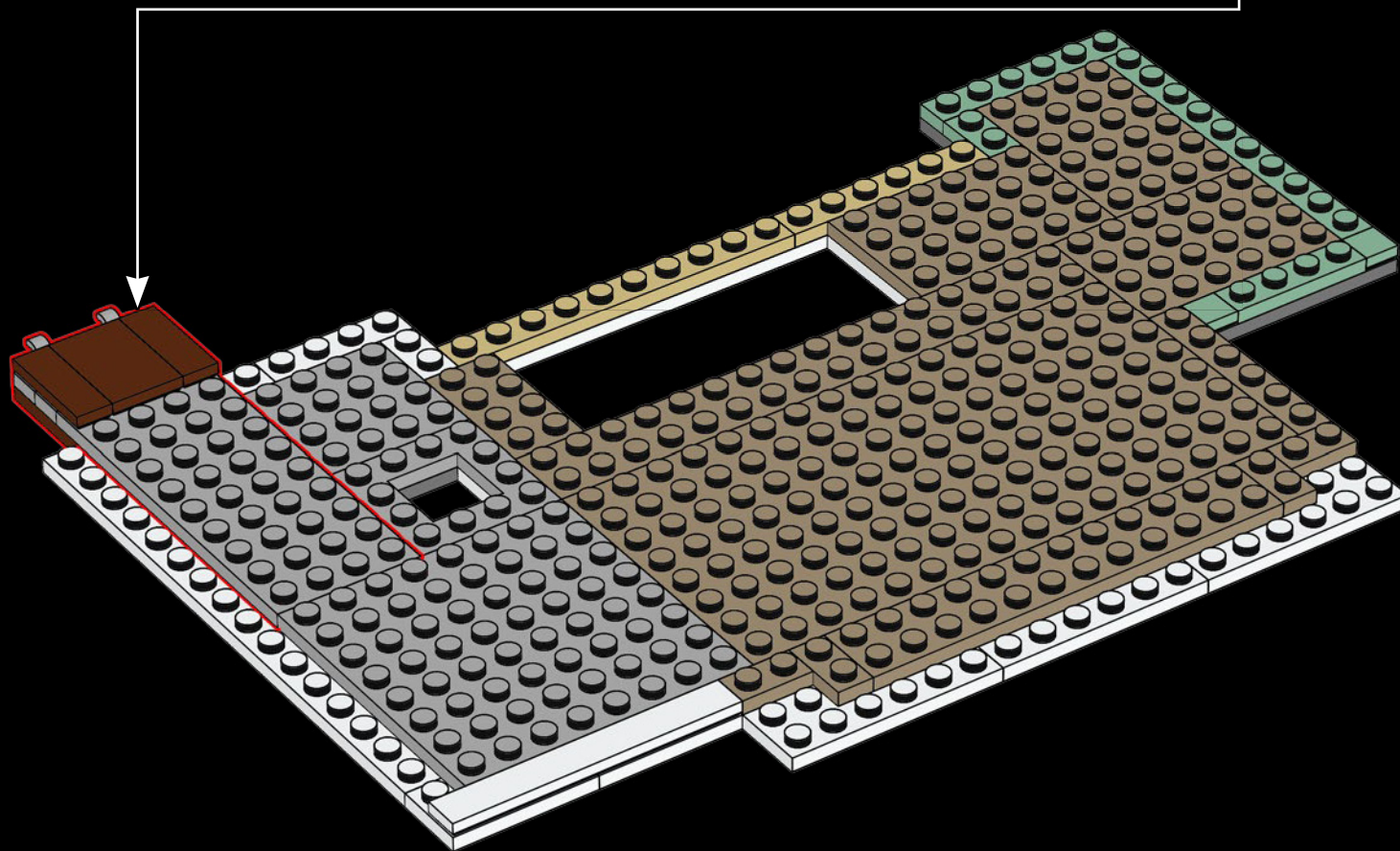
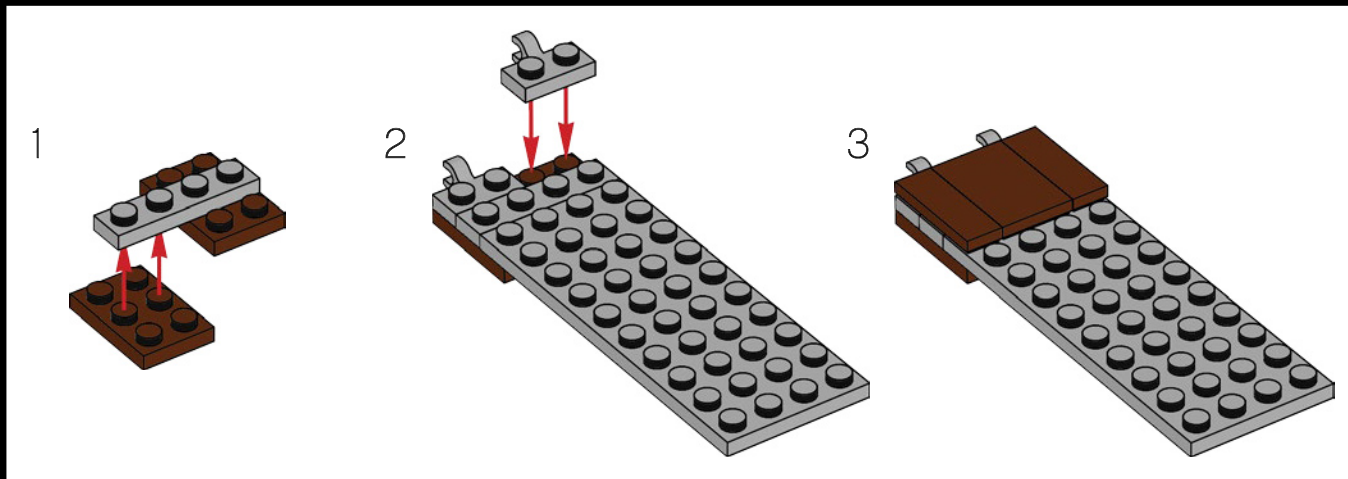

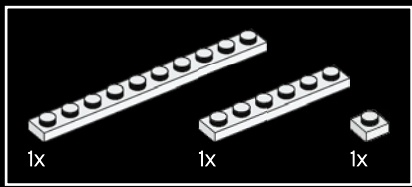

174

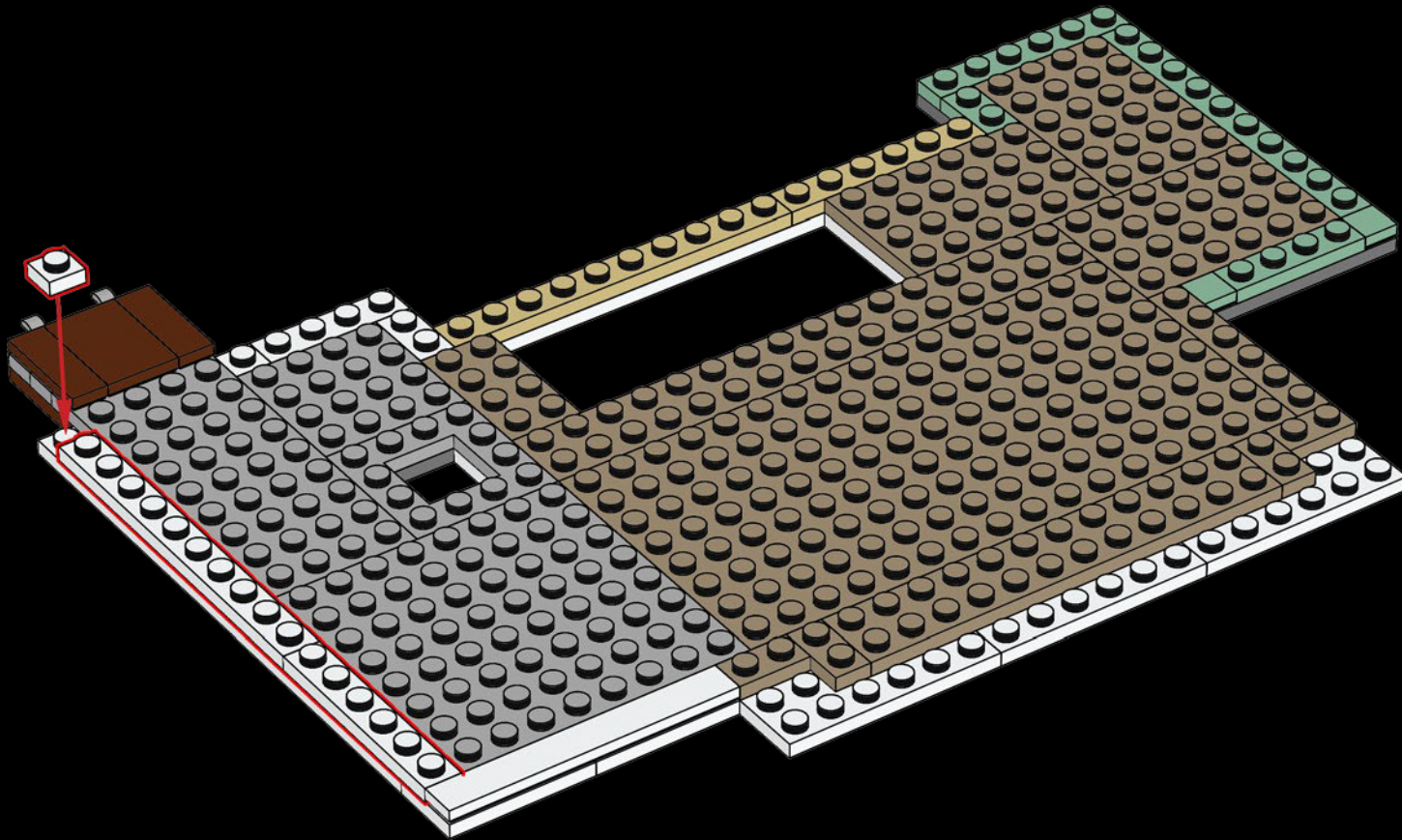



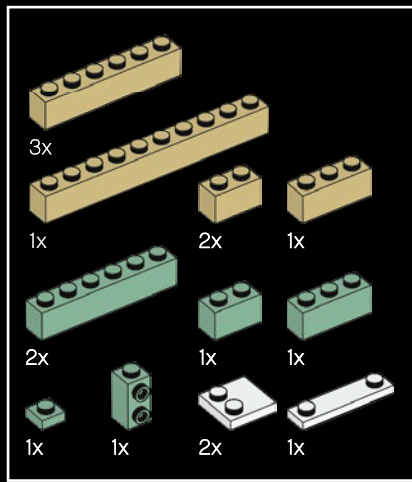

175

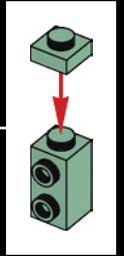
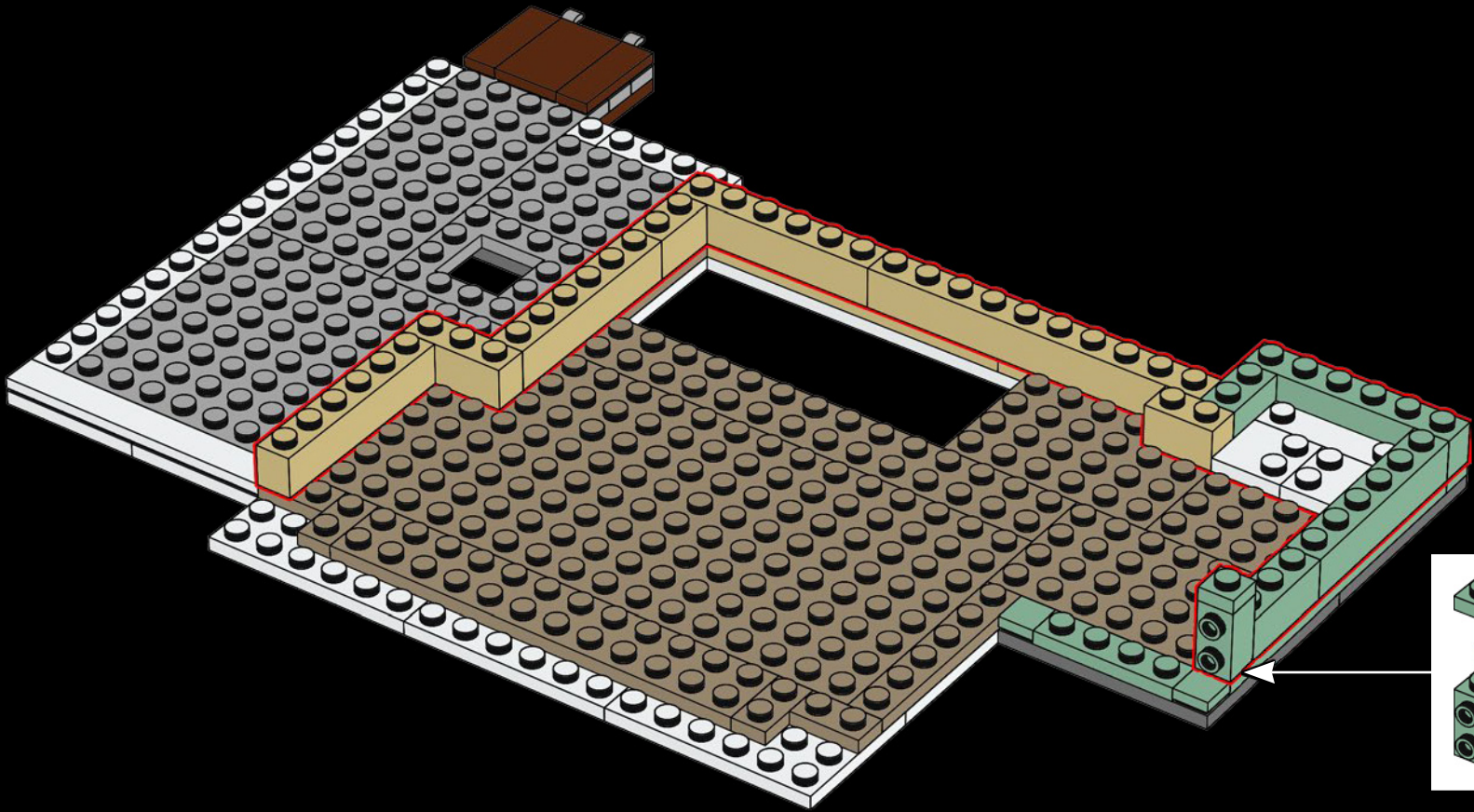





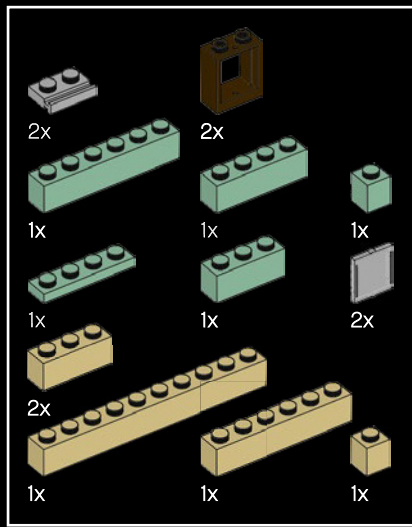

177

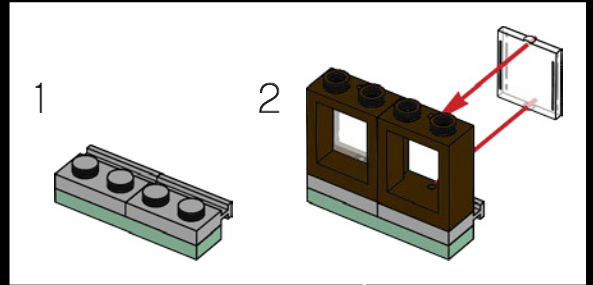
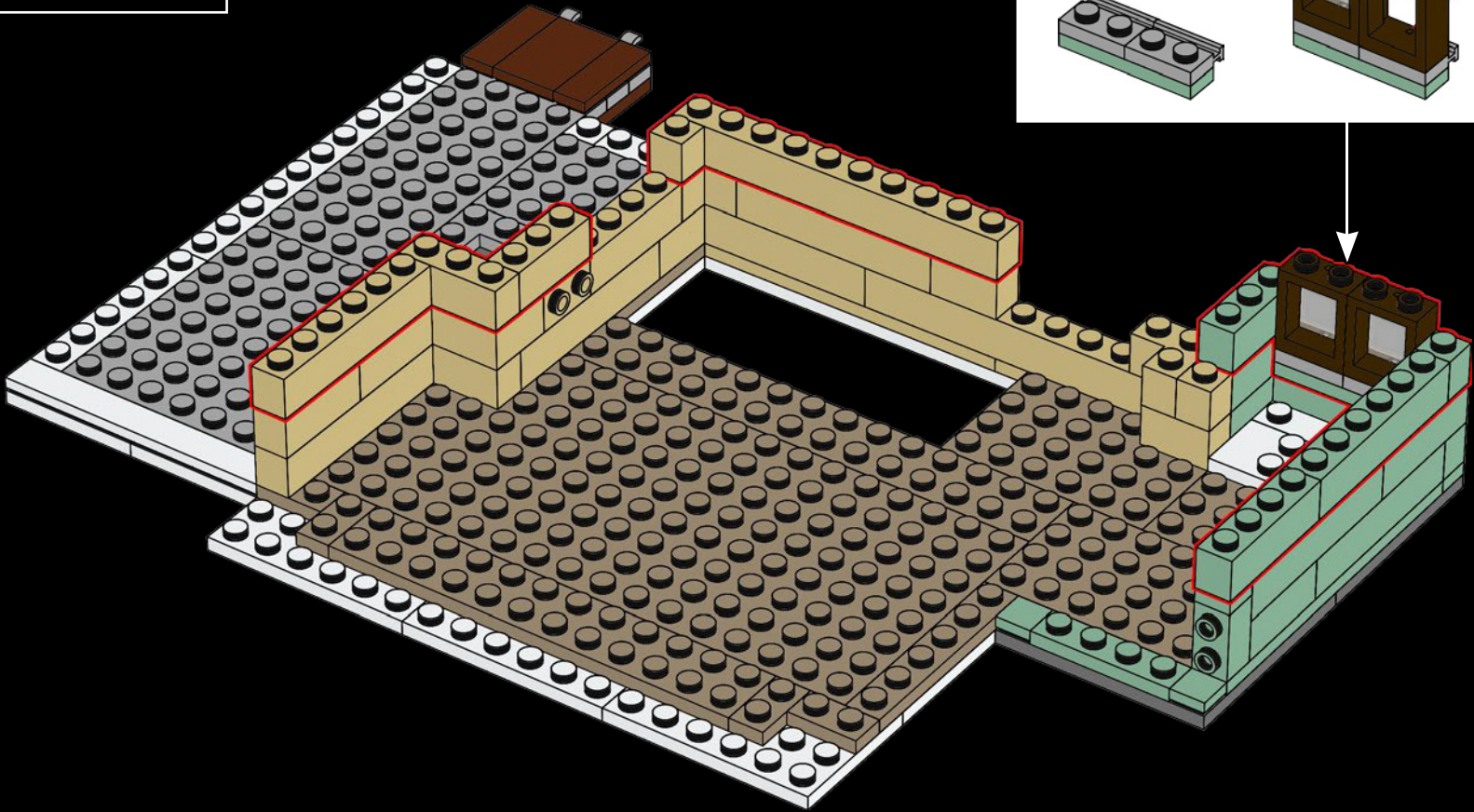





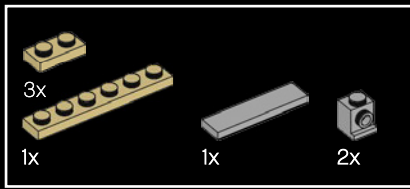

179

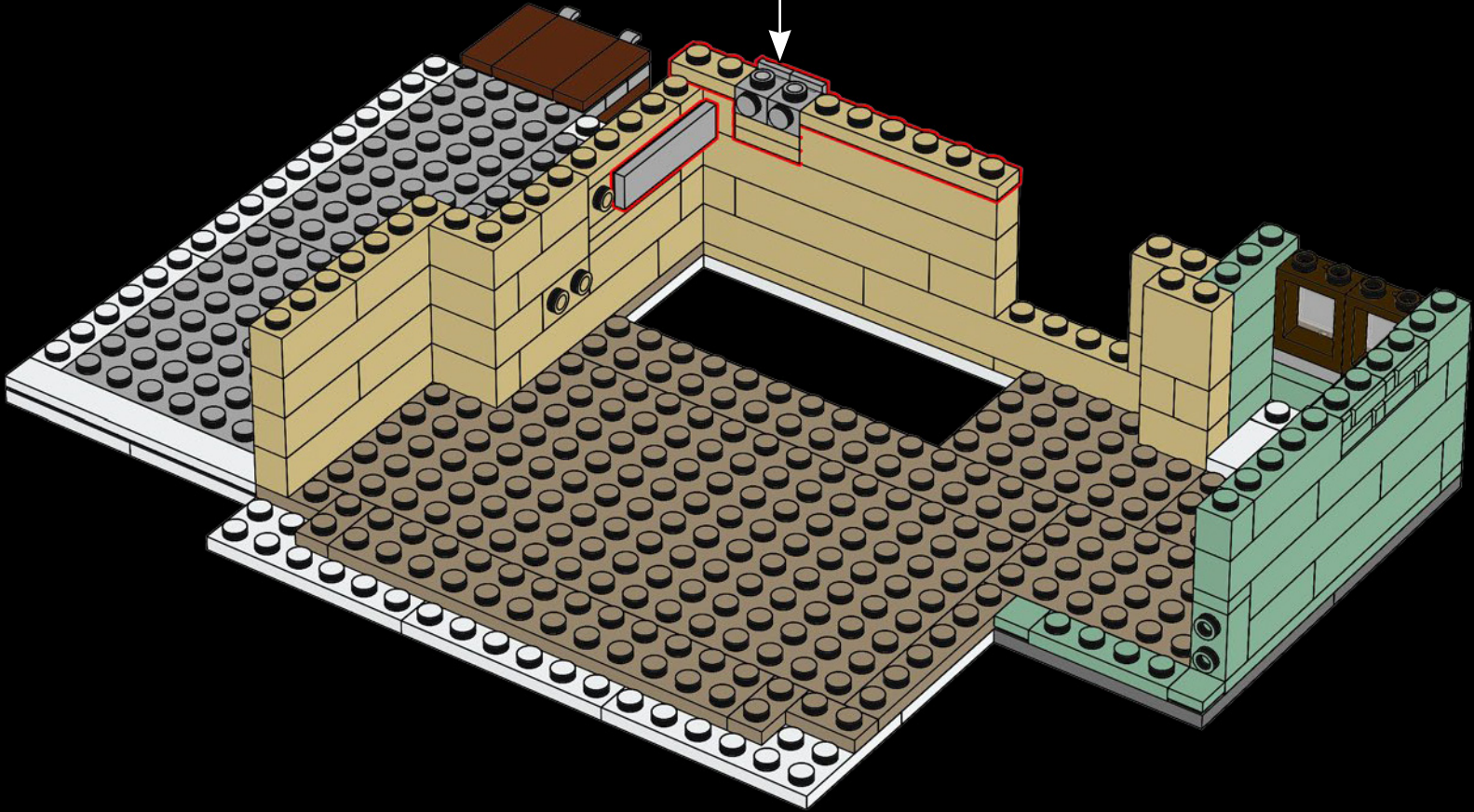
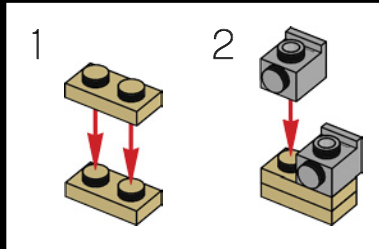

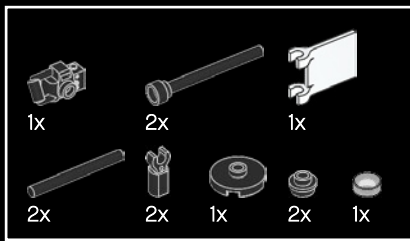

180

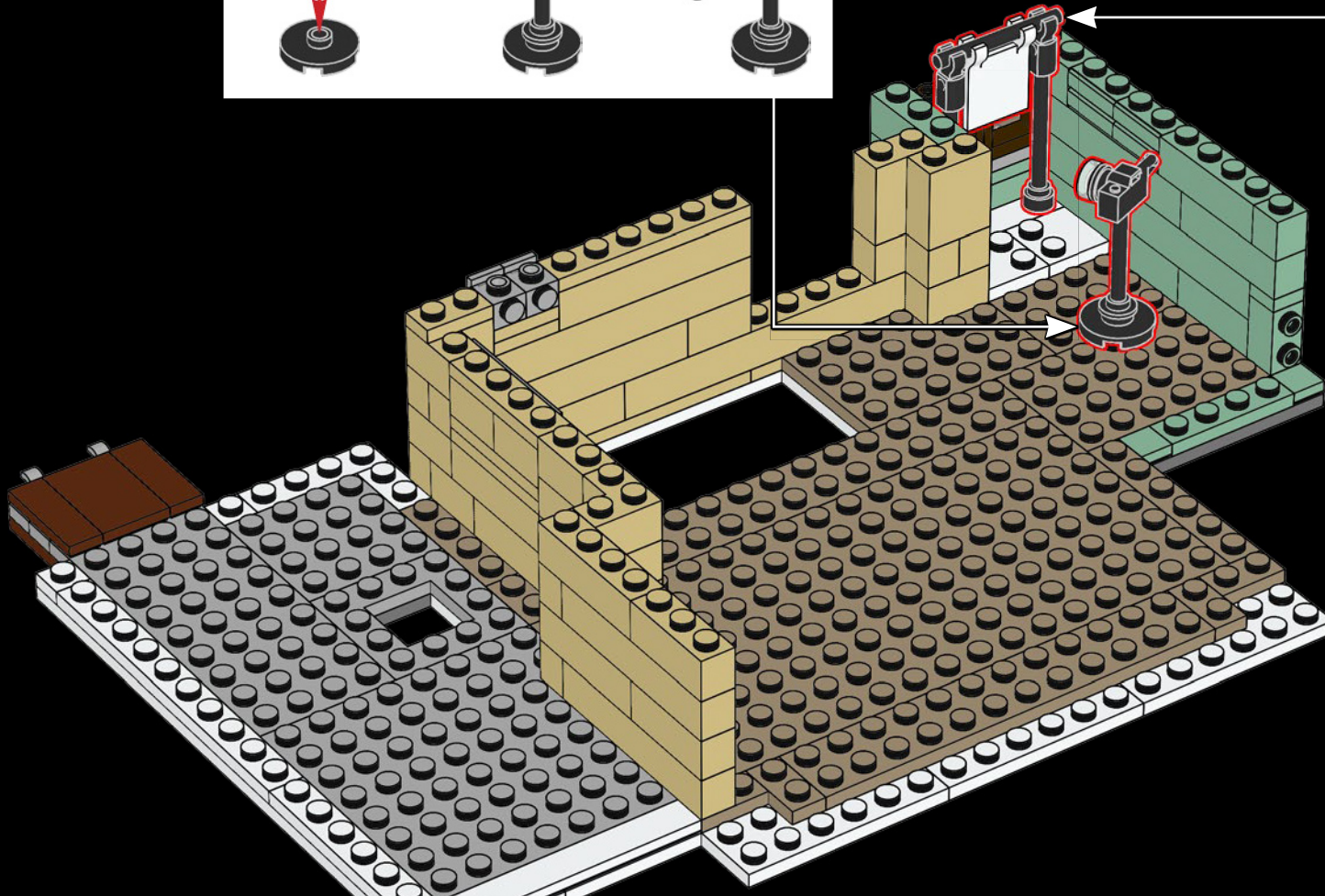
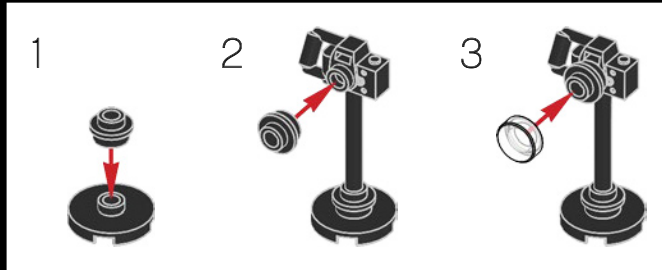
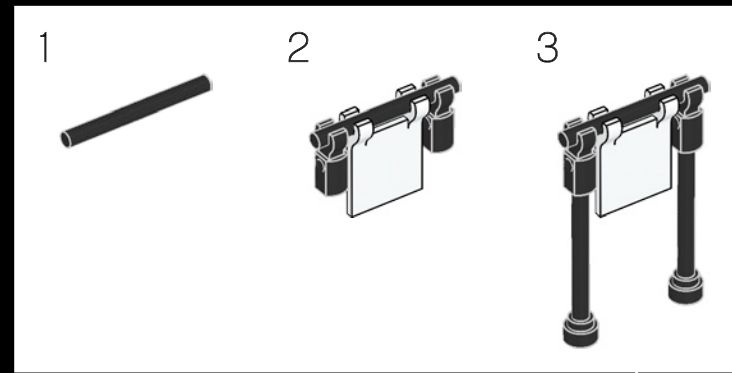



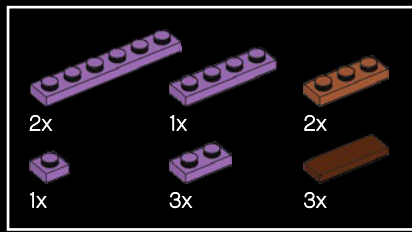

181

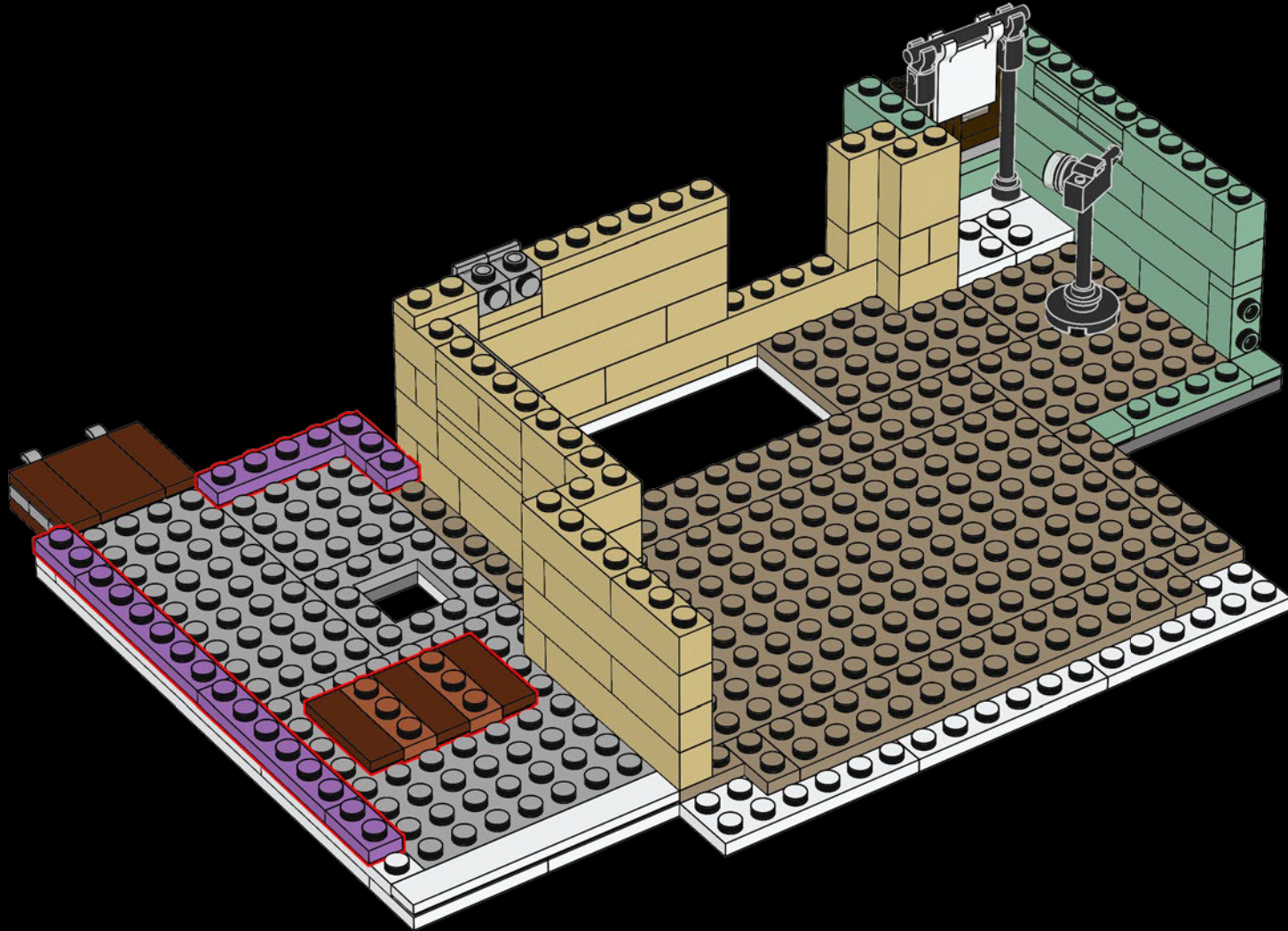

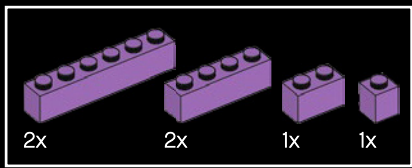

182

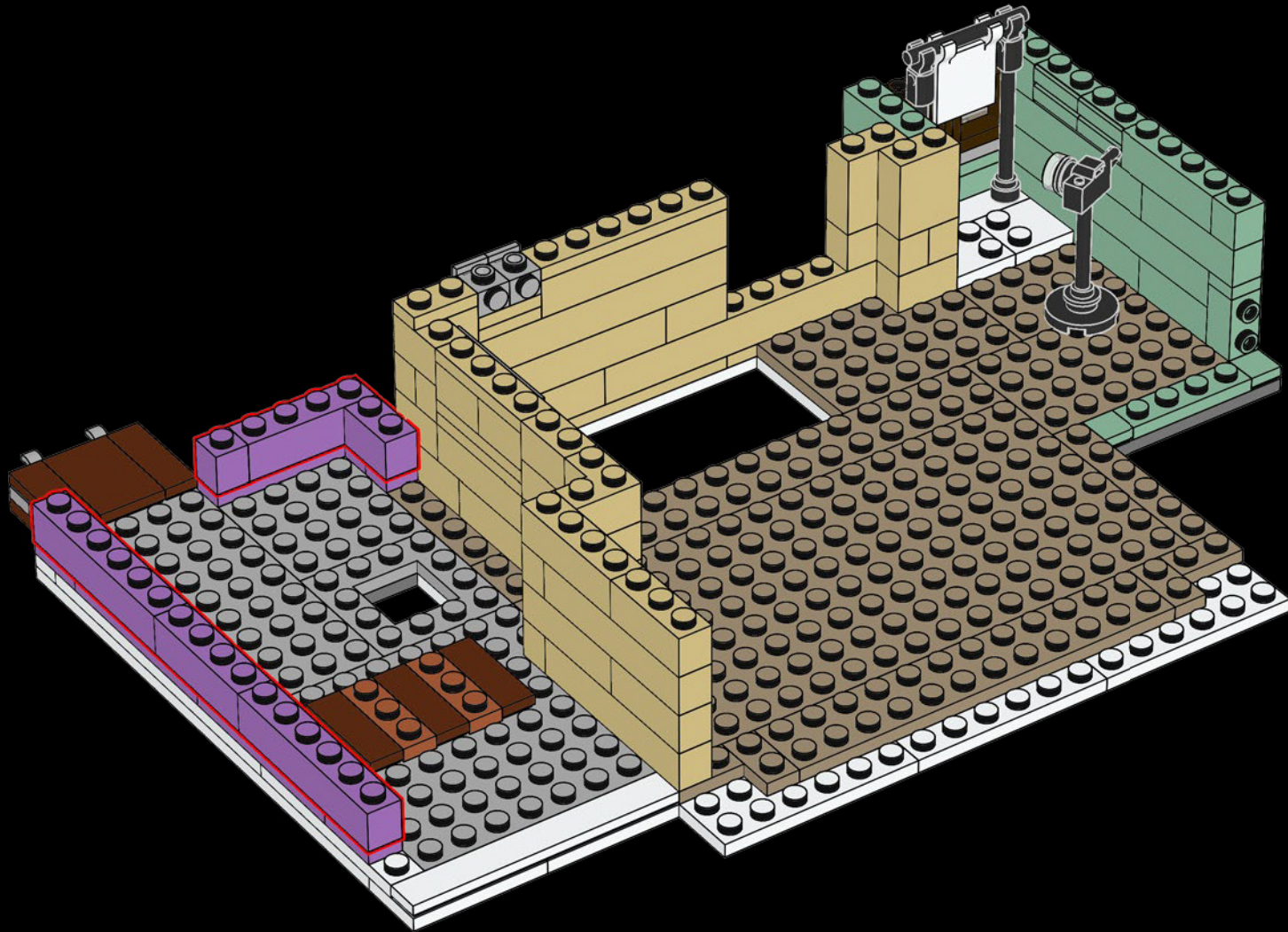



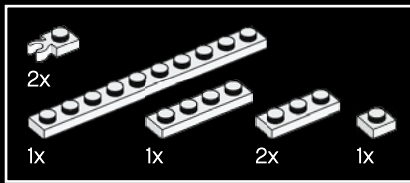

183

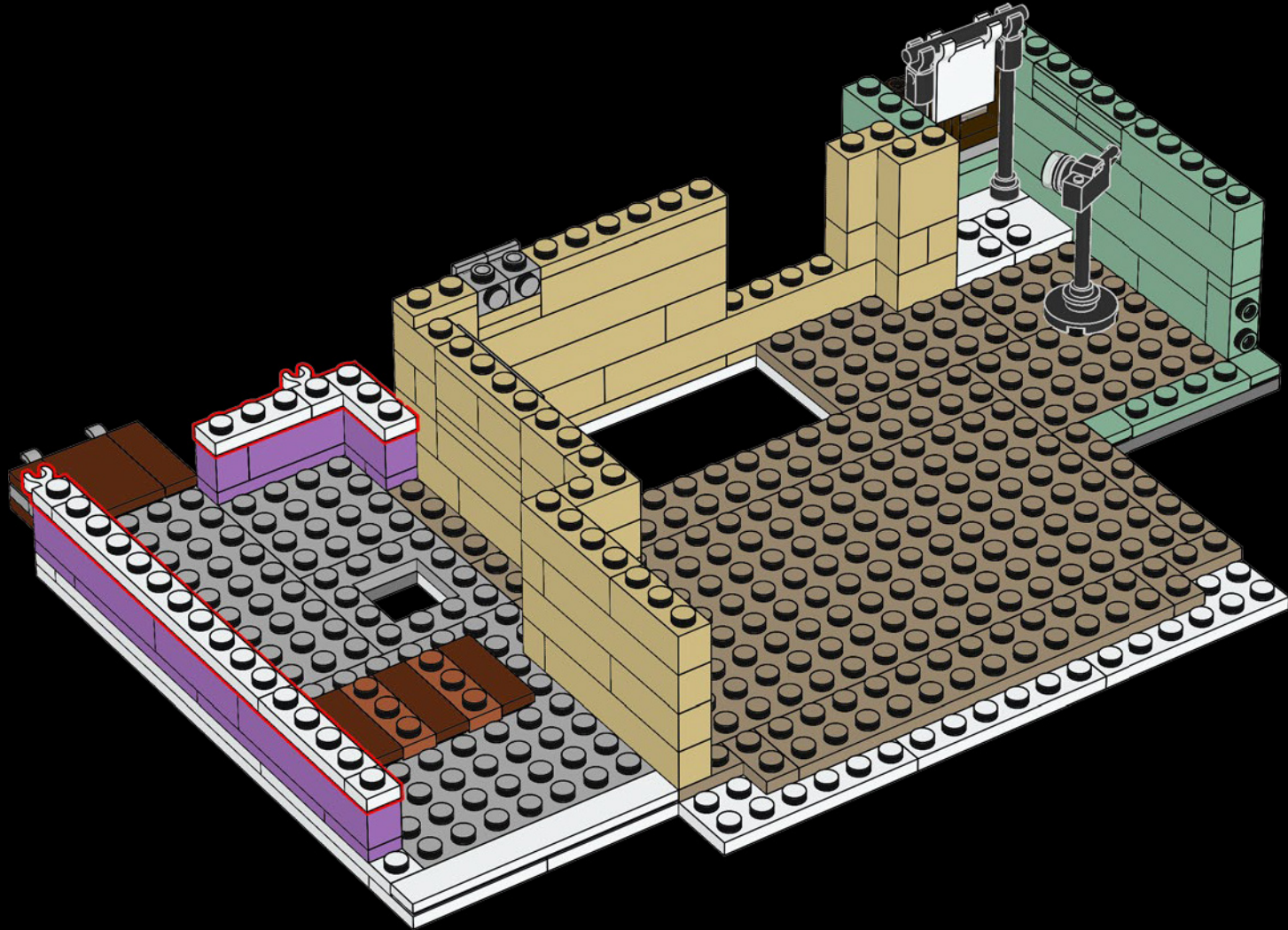

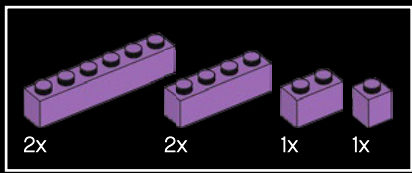

184

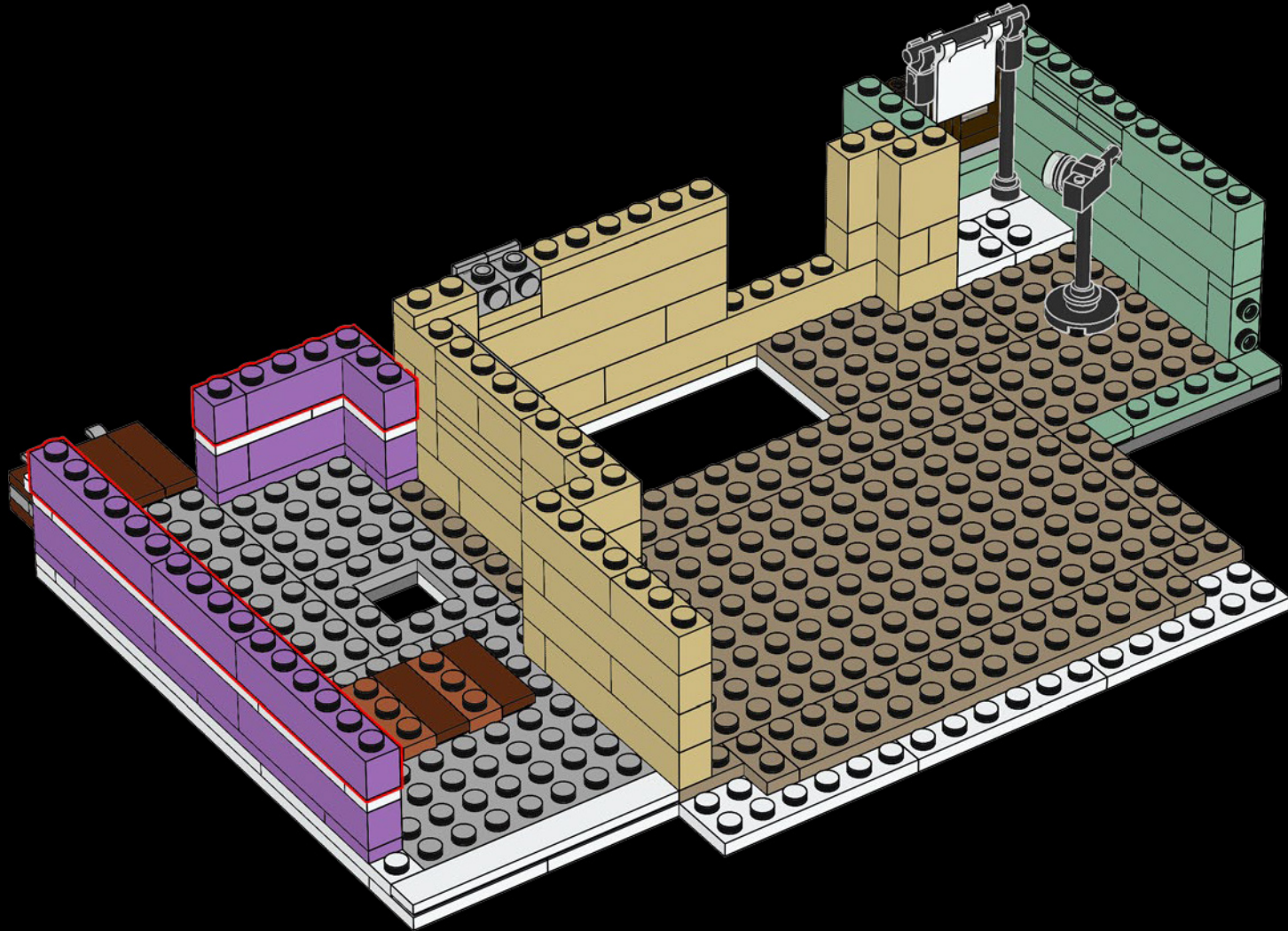



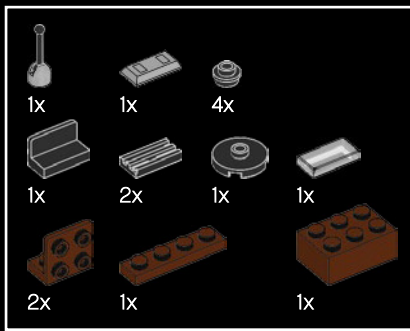

185

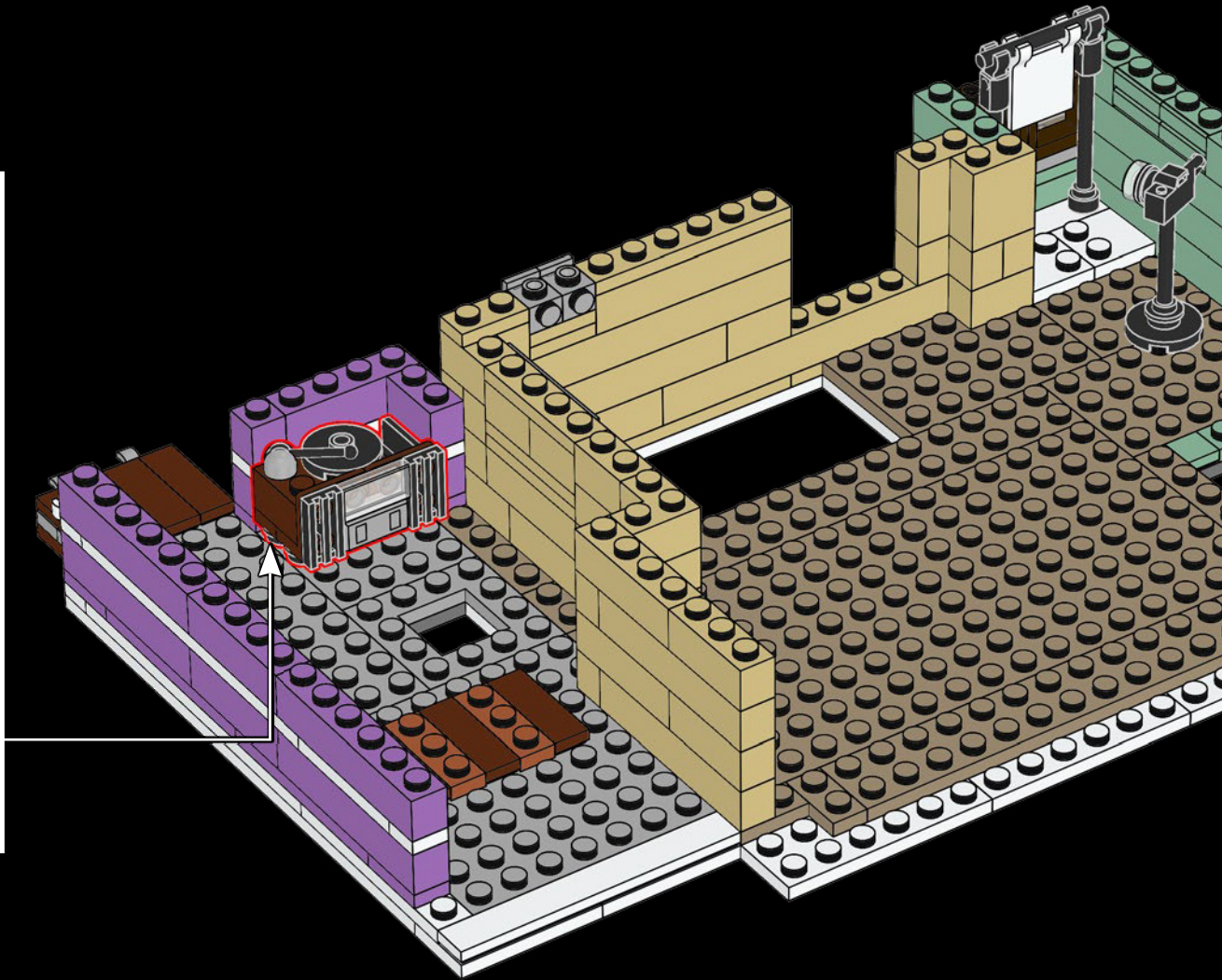
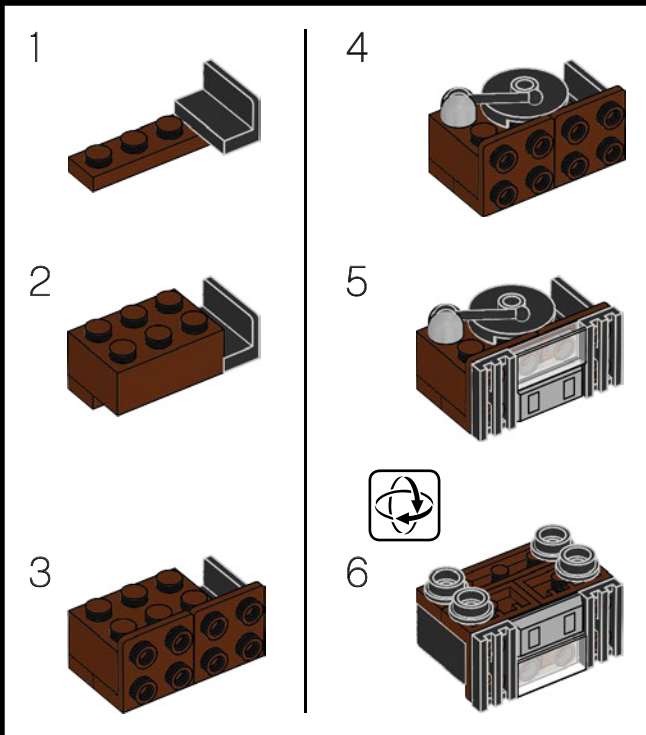

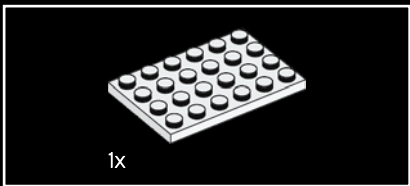

1x

186

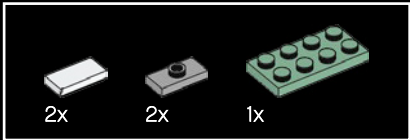
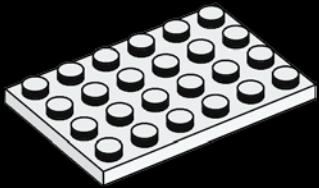

2x

2x

1x

187

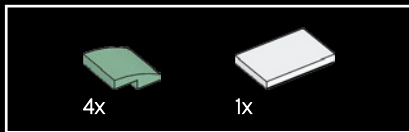
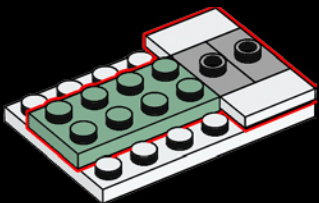

4x

1x

188

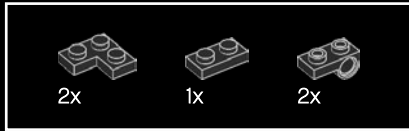
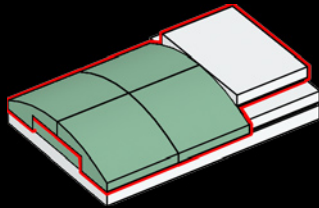

2x

1x

2x

189

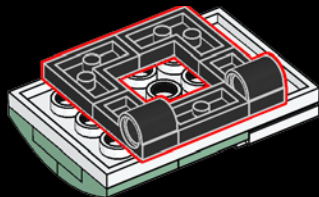

2x

190

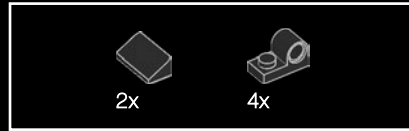
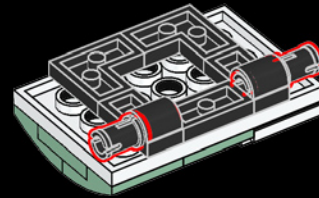

2x

4x

191

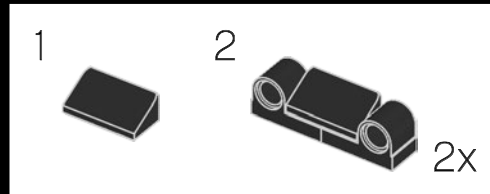

1

2

2x

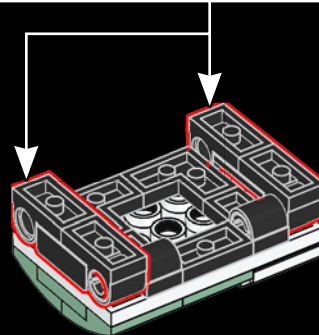



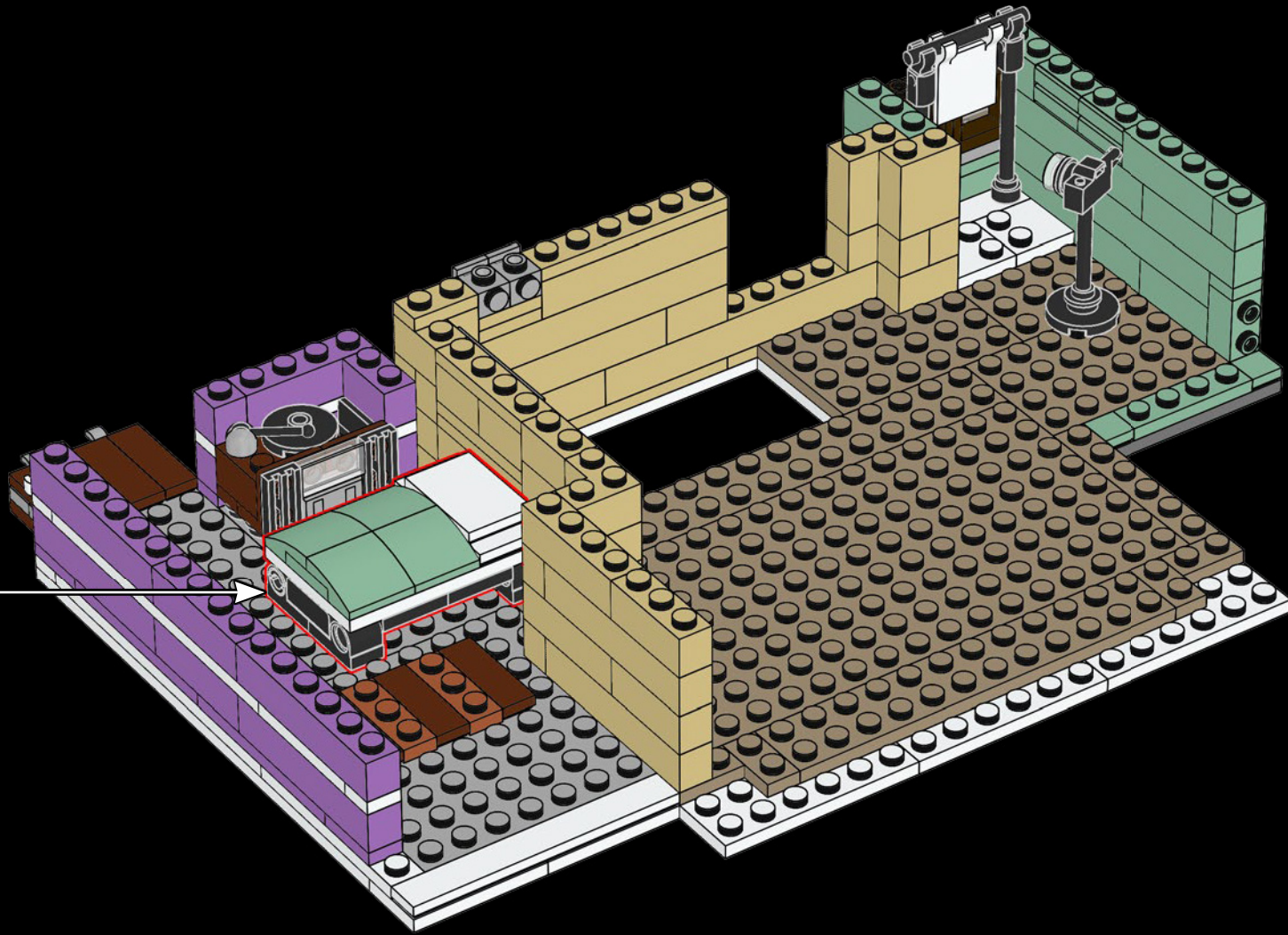

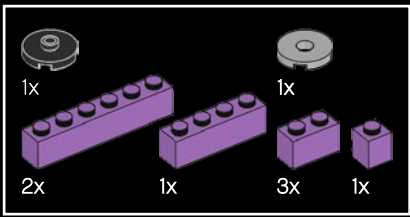

193

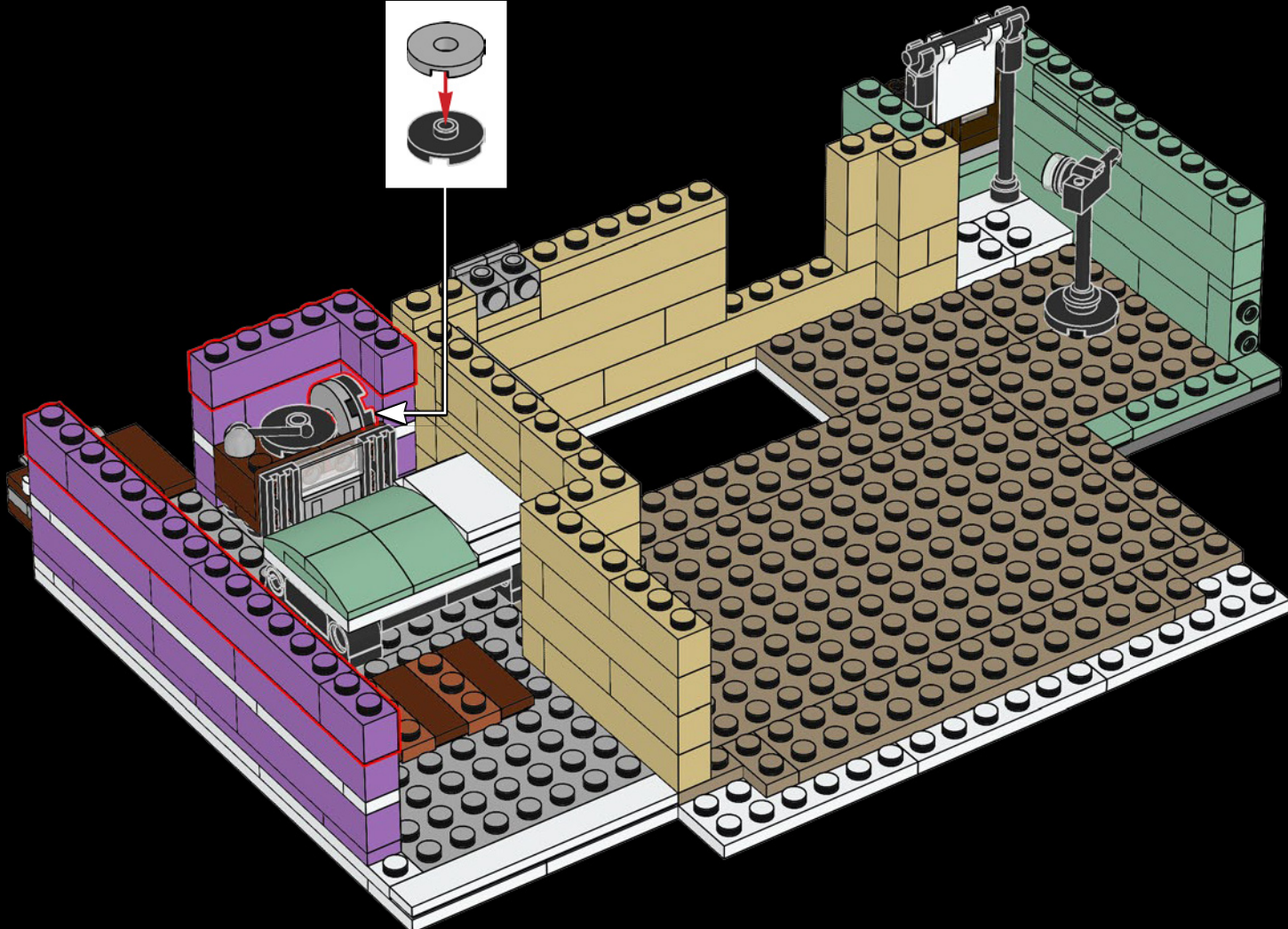



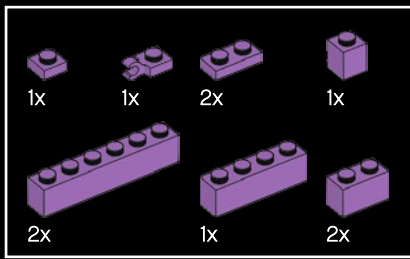

194

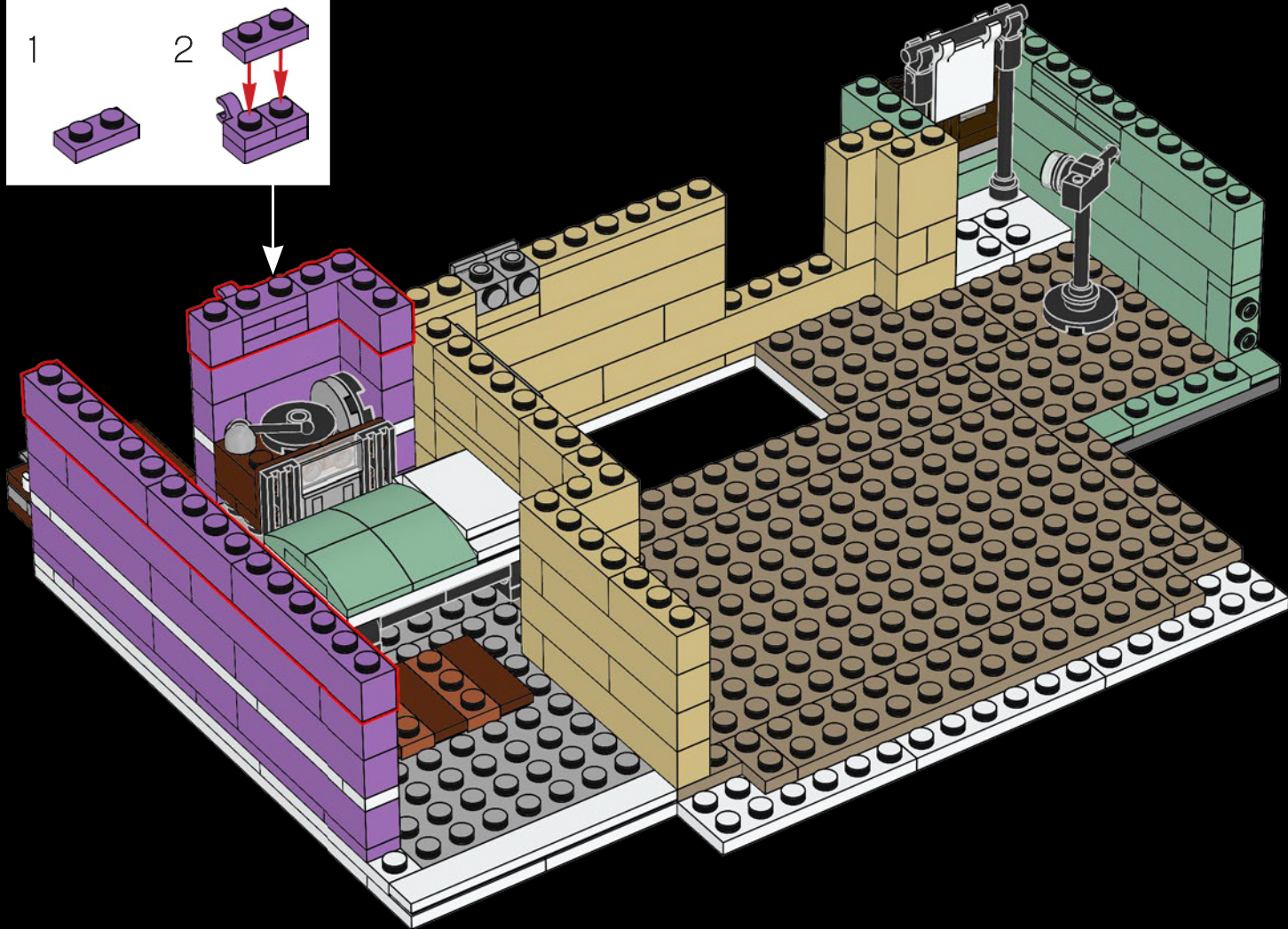
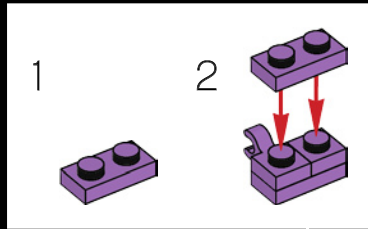

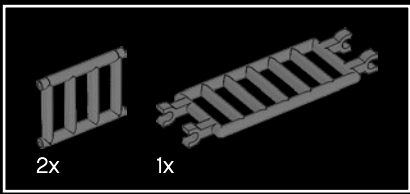

195

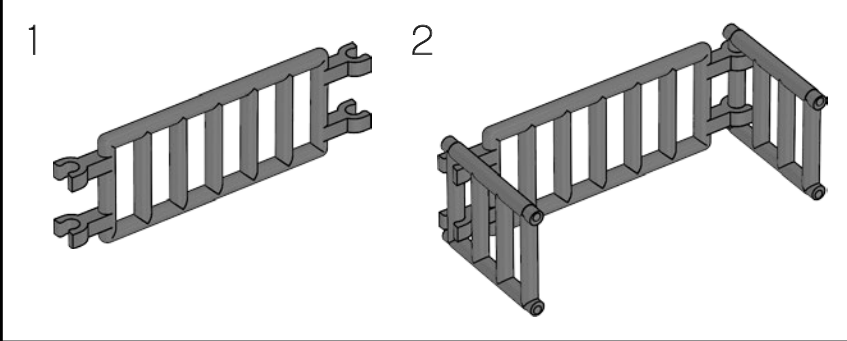
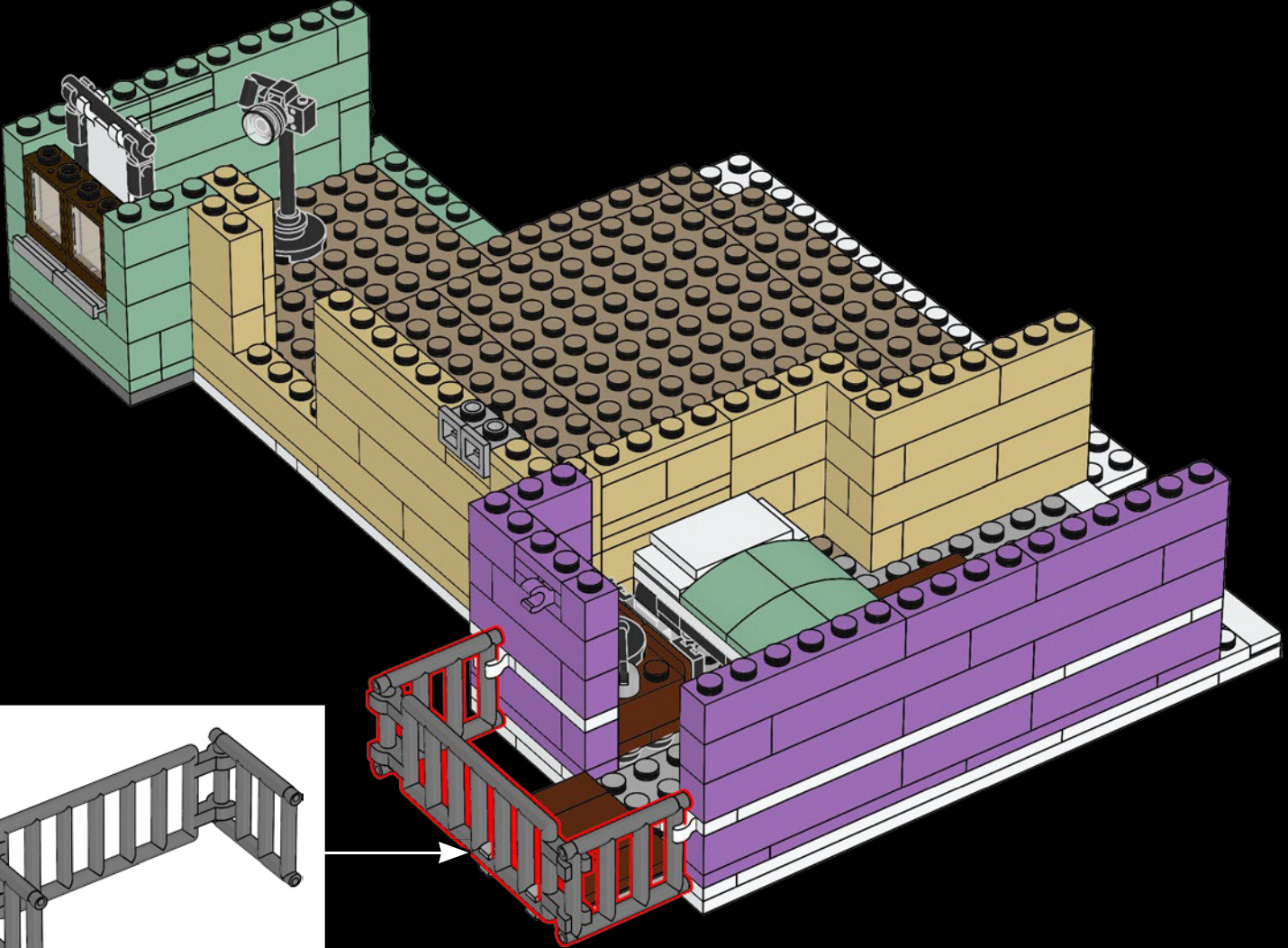



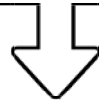

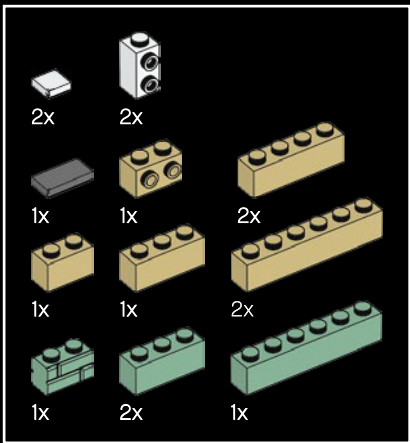

196

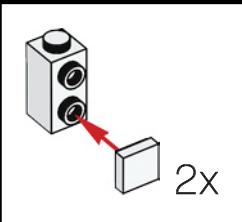
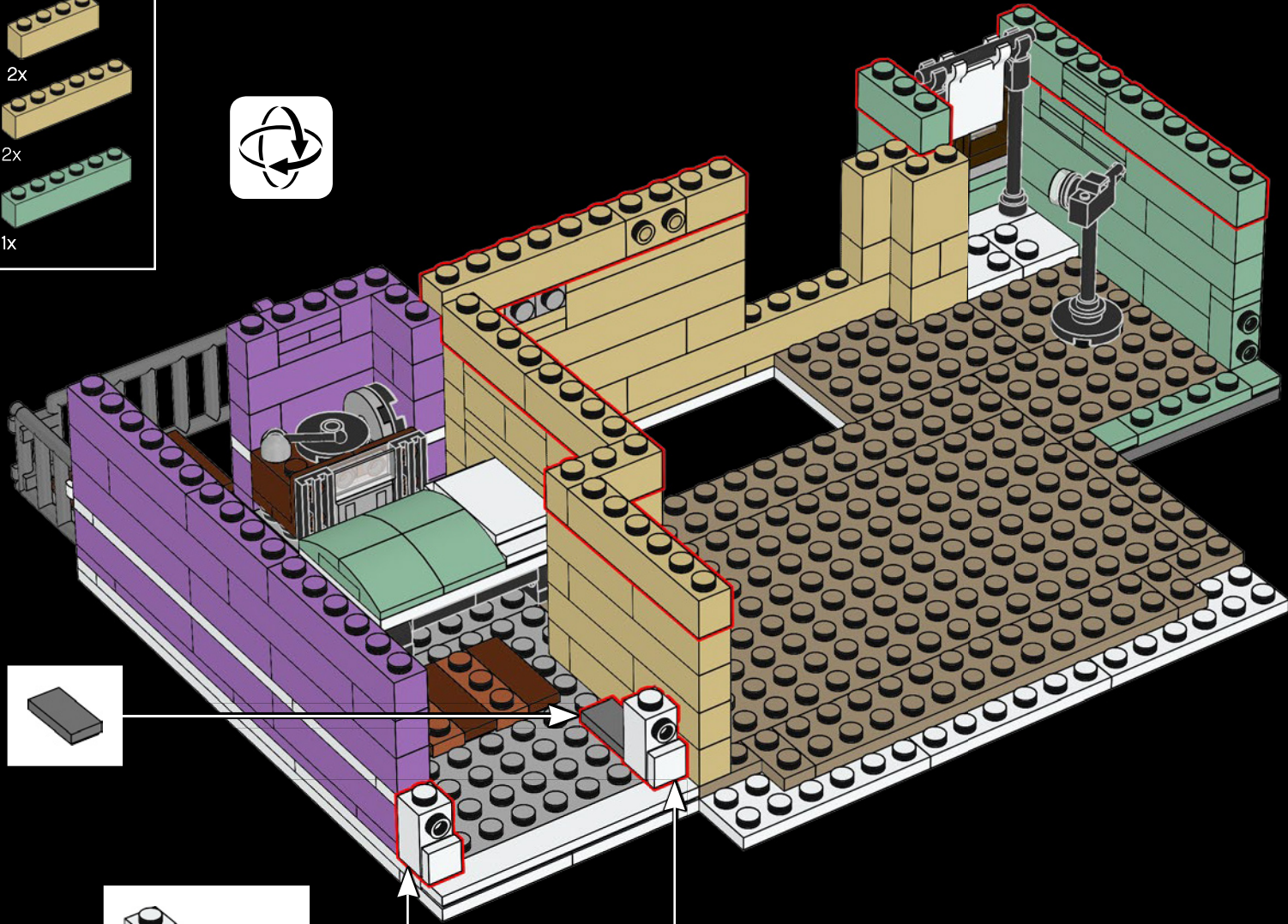



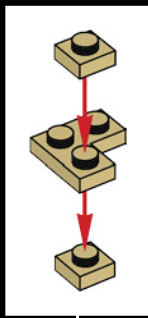
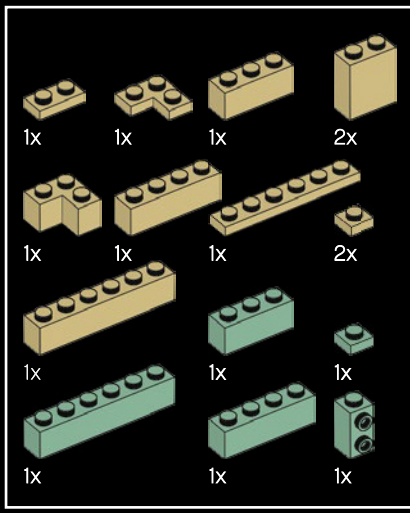

197

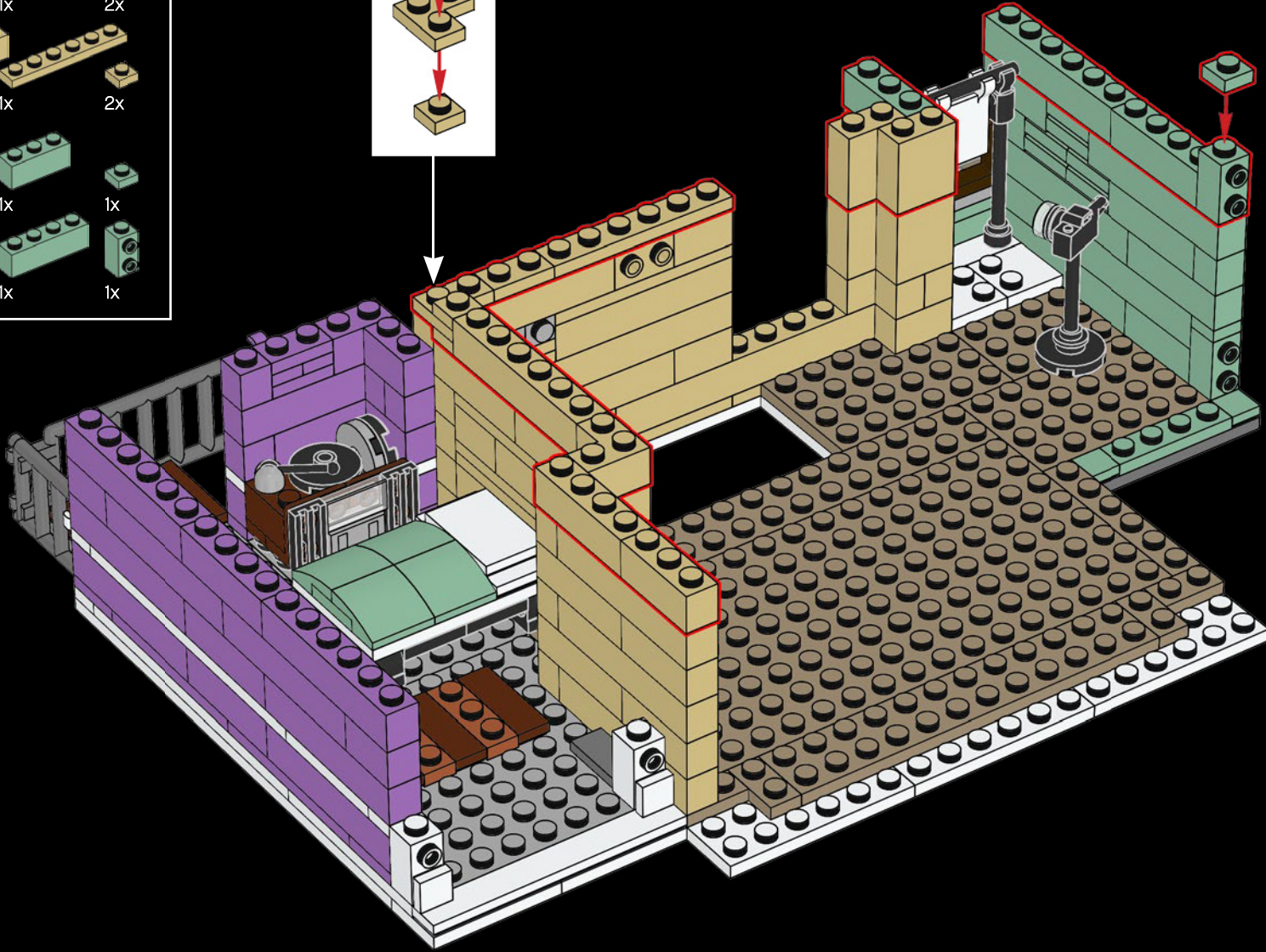

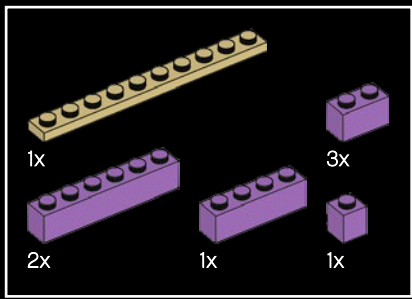

198

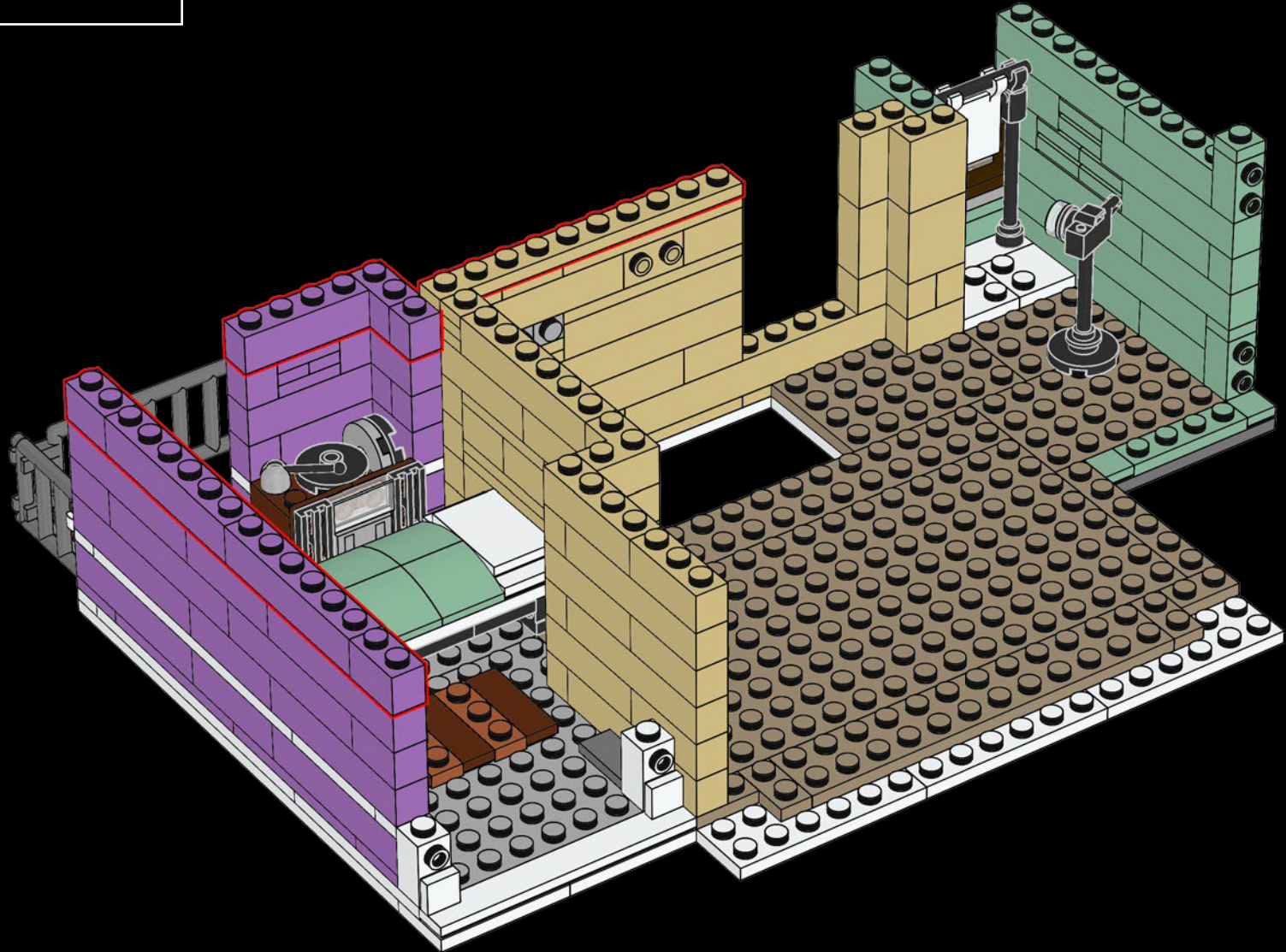



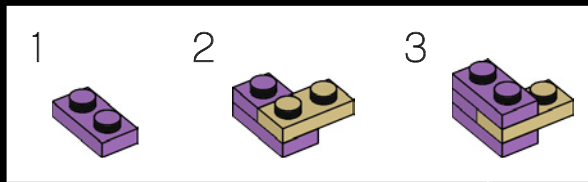
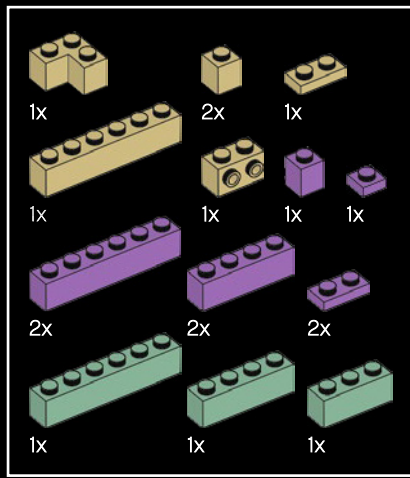

199

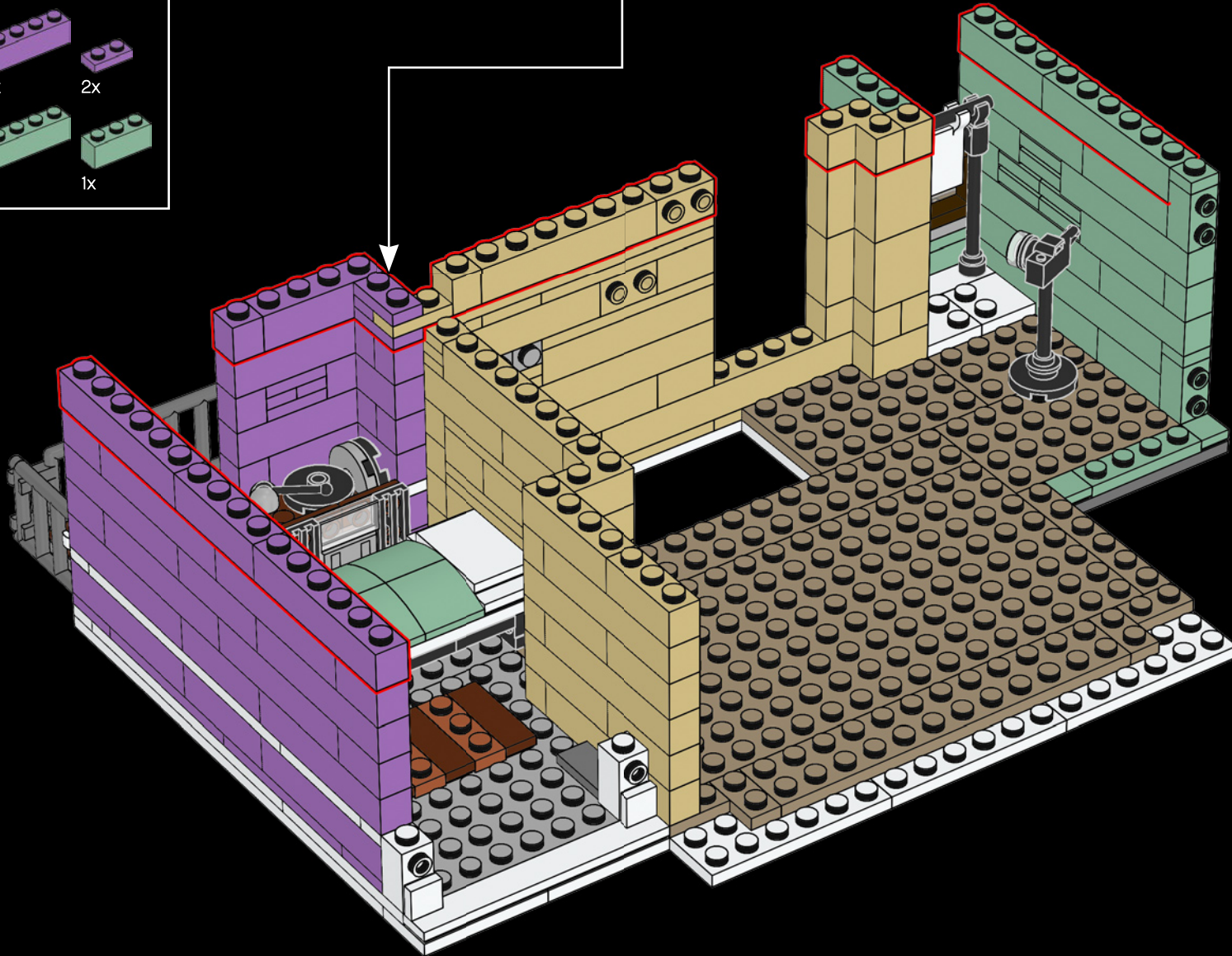

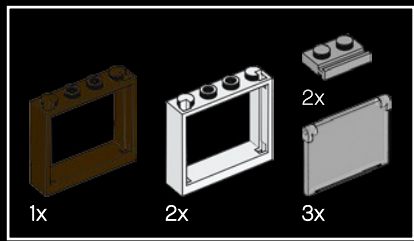

200

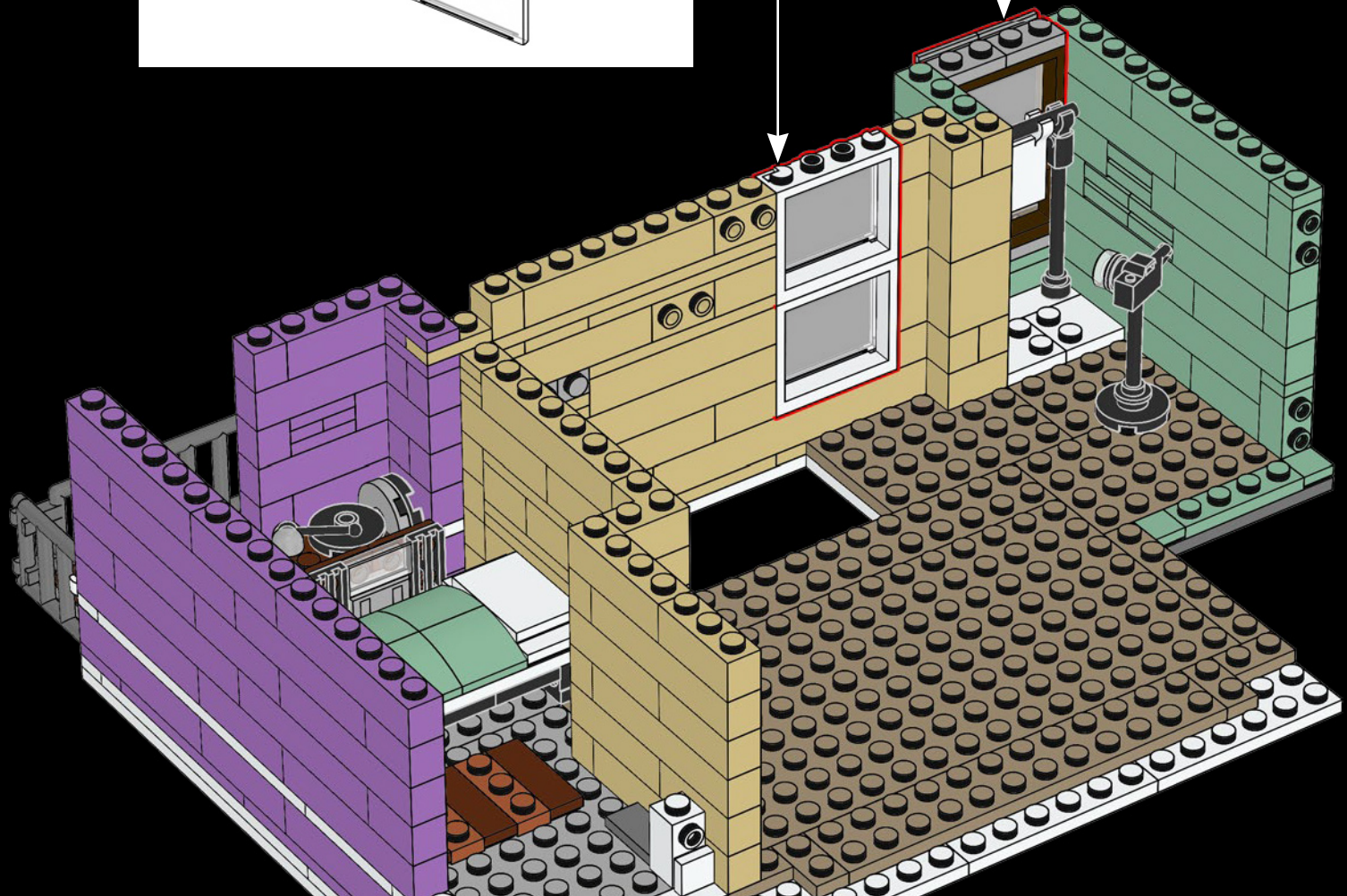
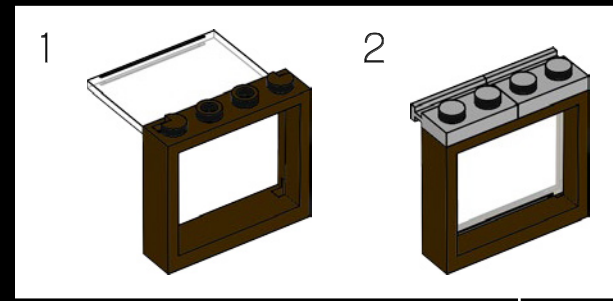
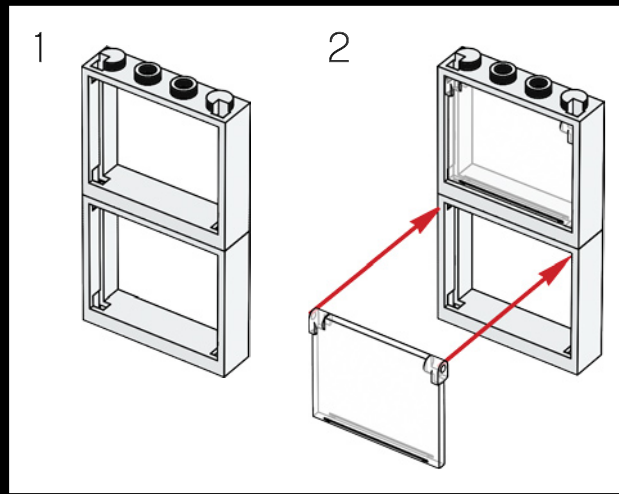



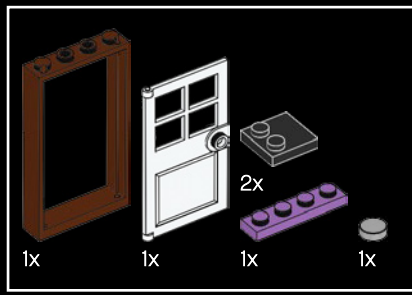

201

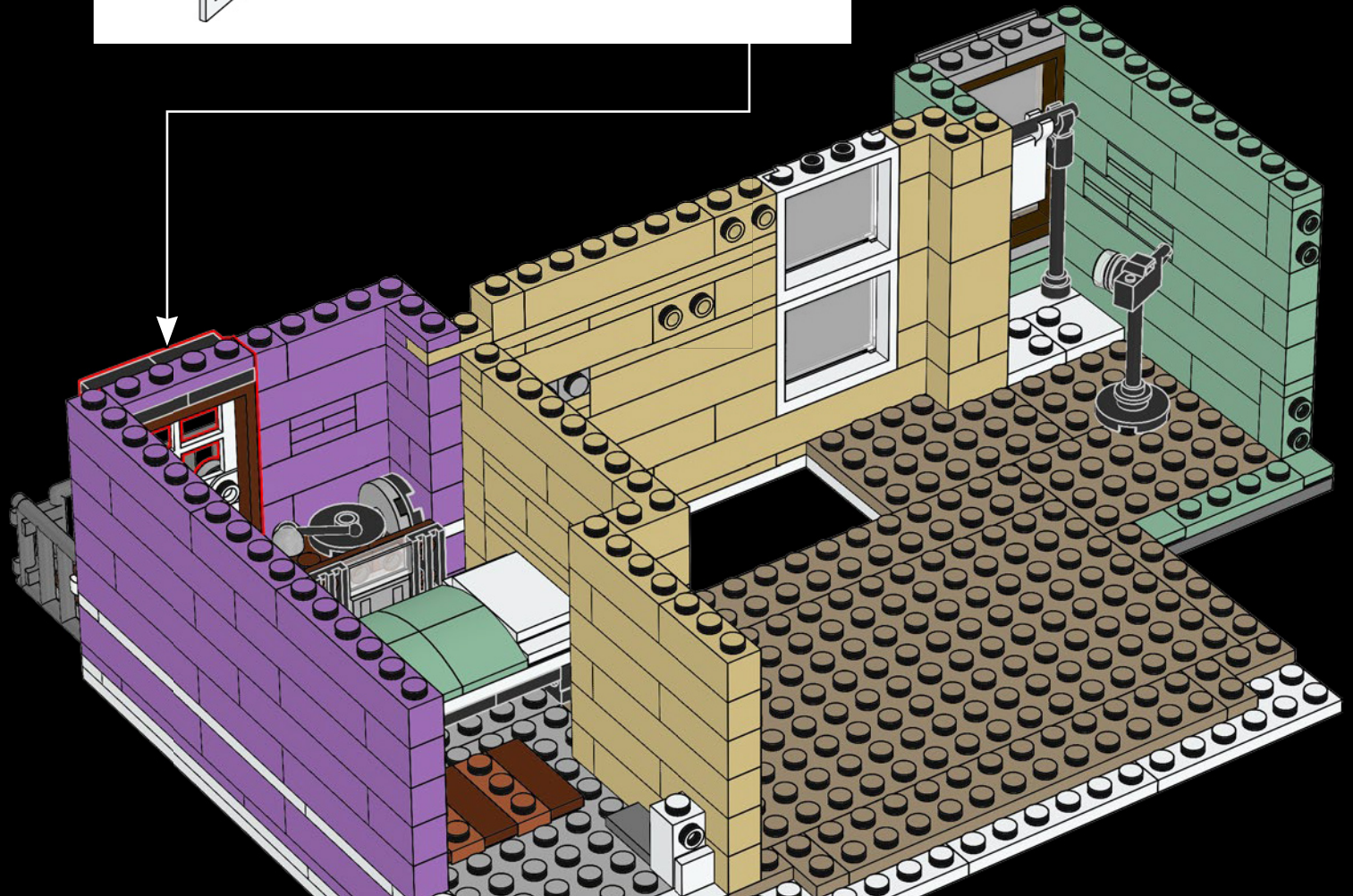
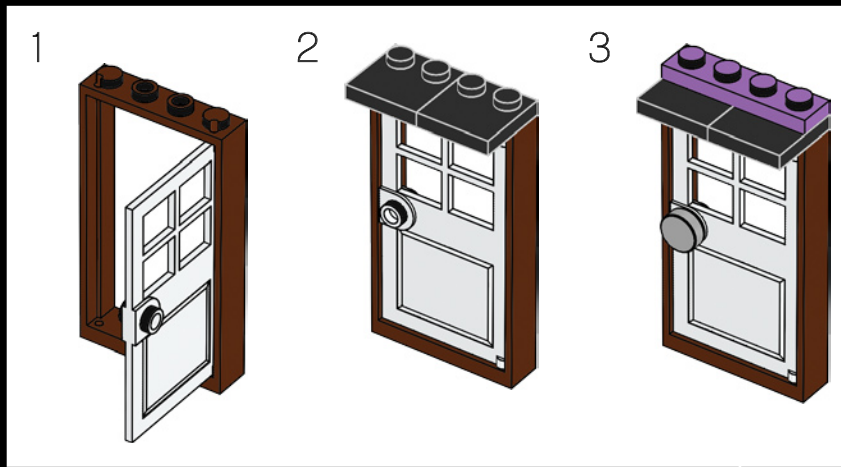

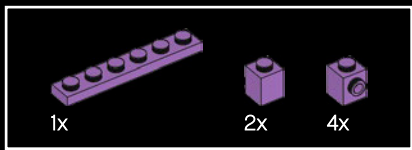

202

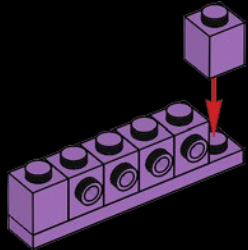

203

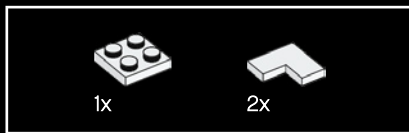
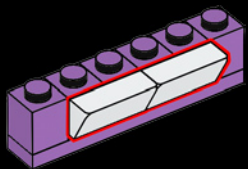

204

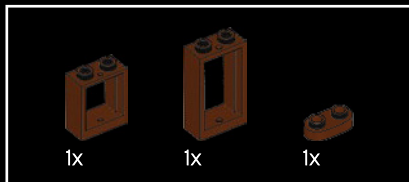
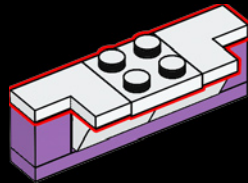

205

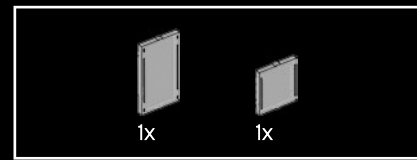
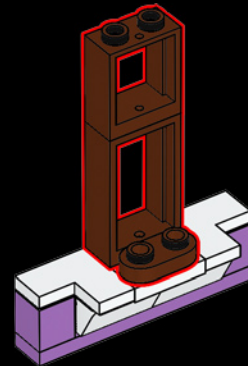

206

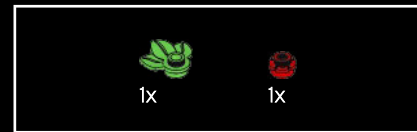
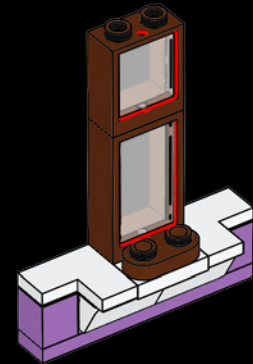

207

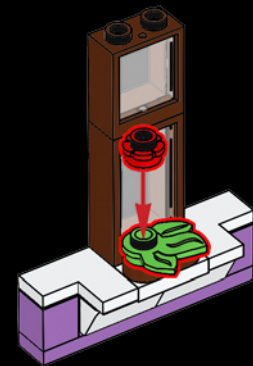



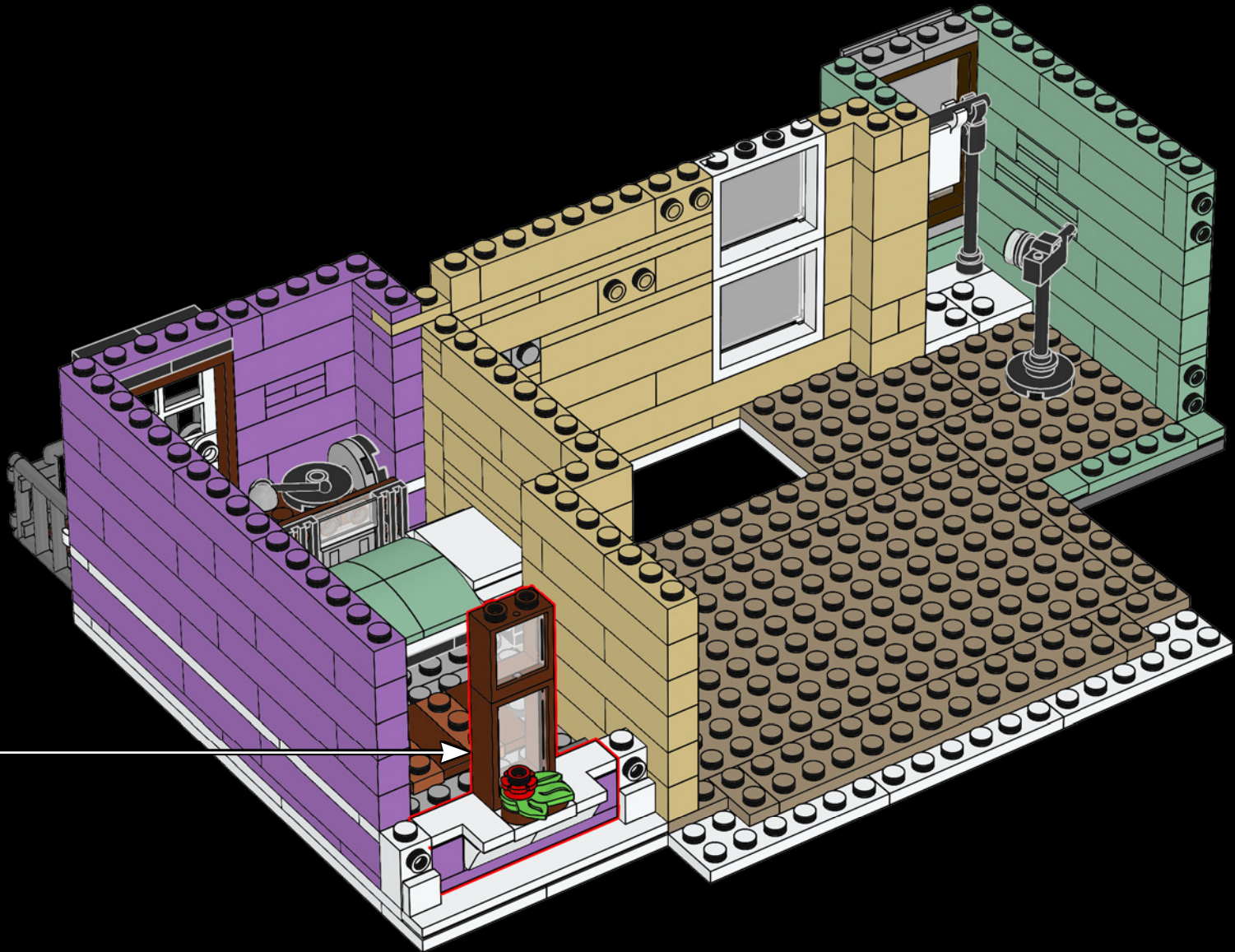

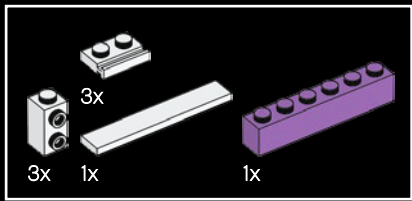

209

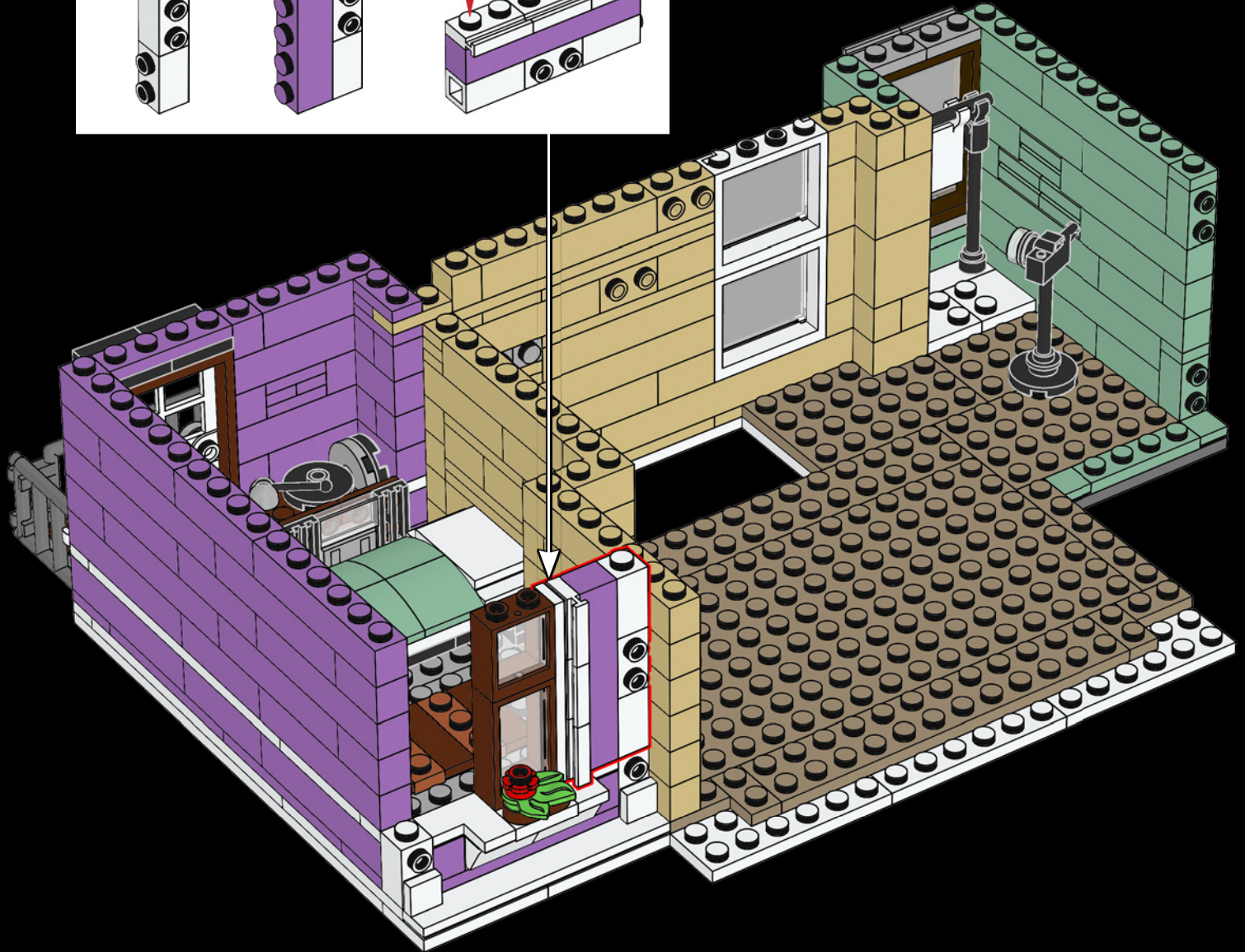
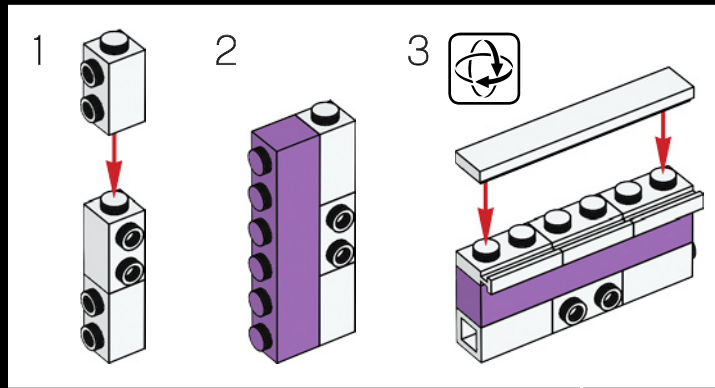



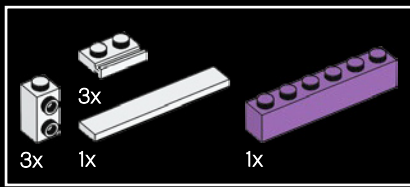

210

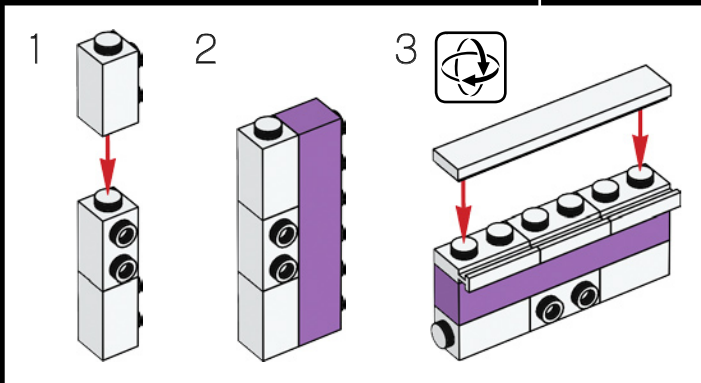
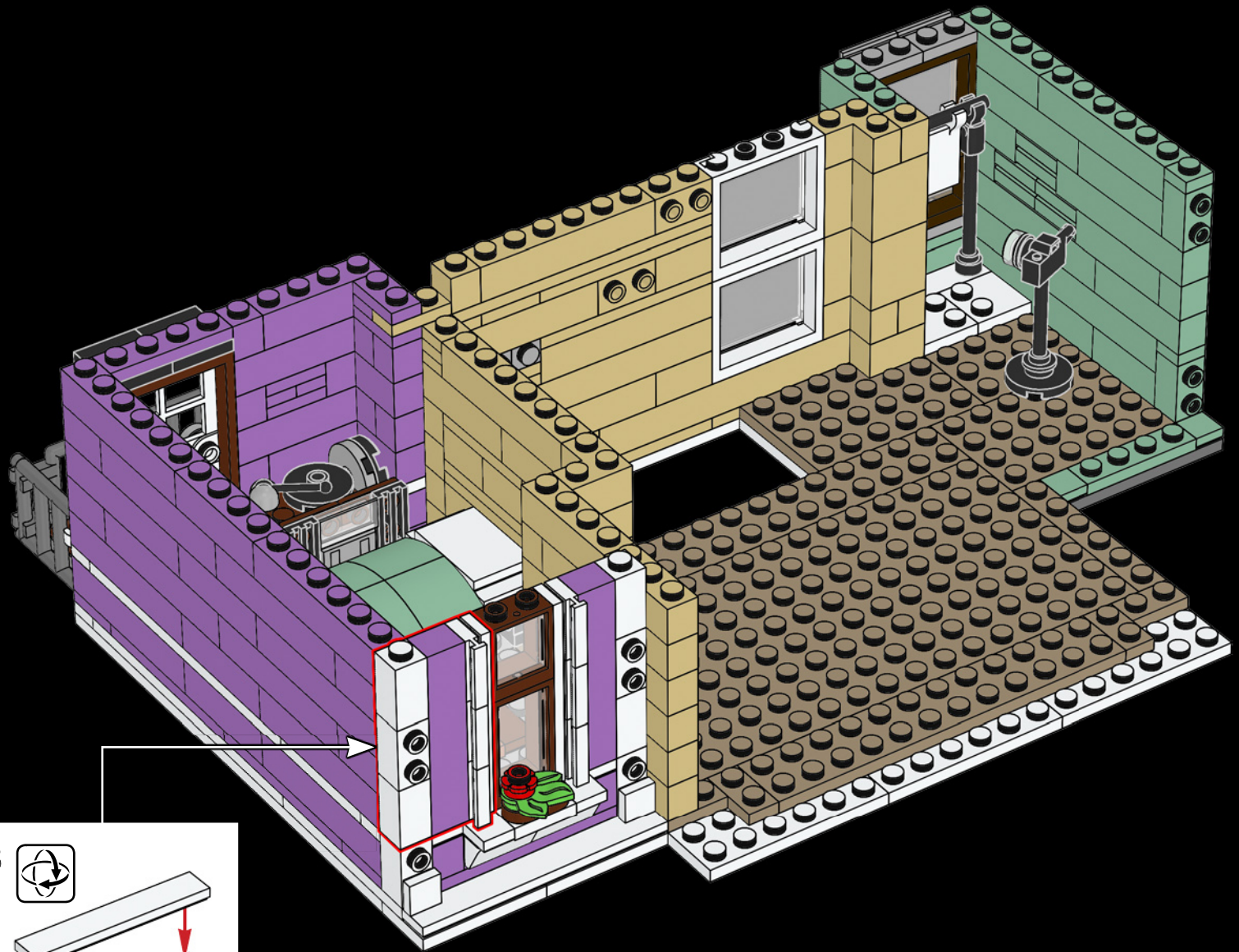

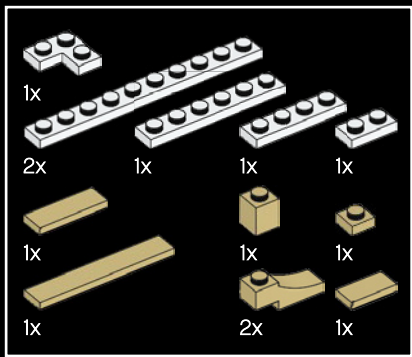

211

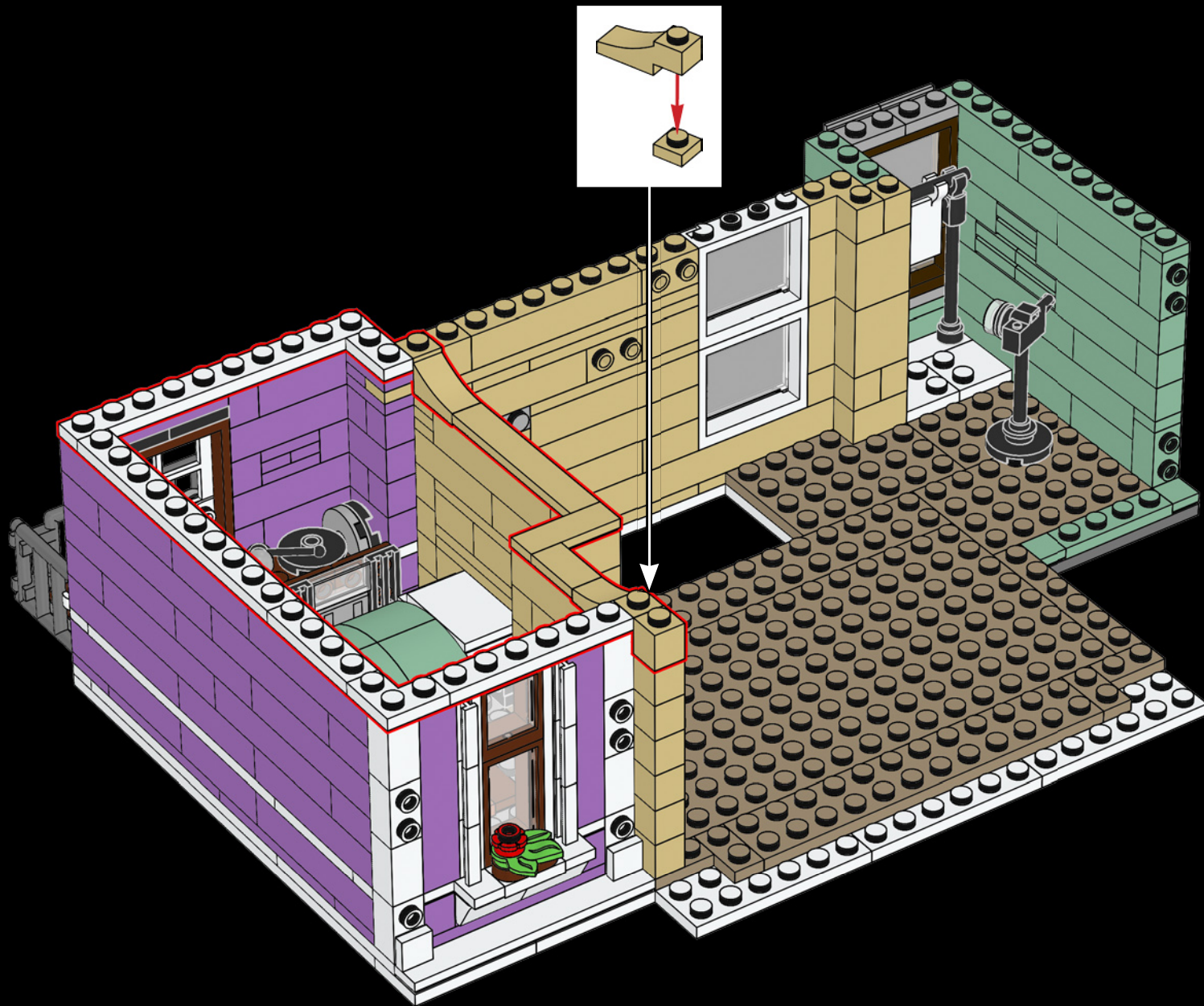



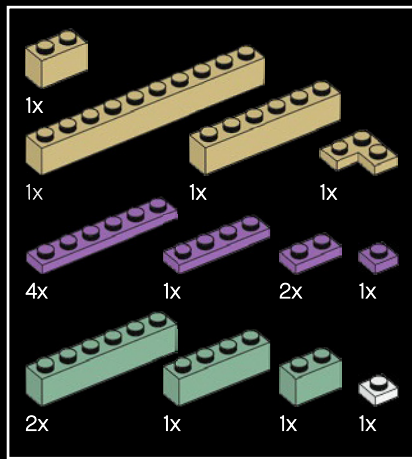

212

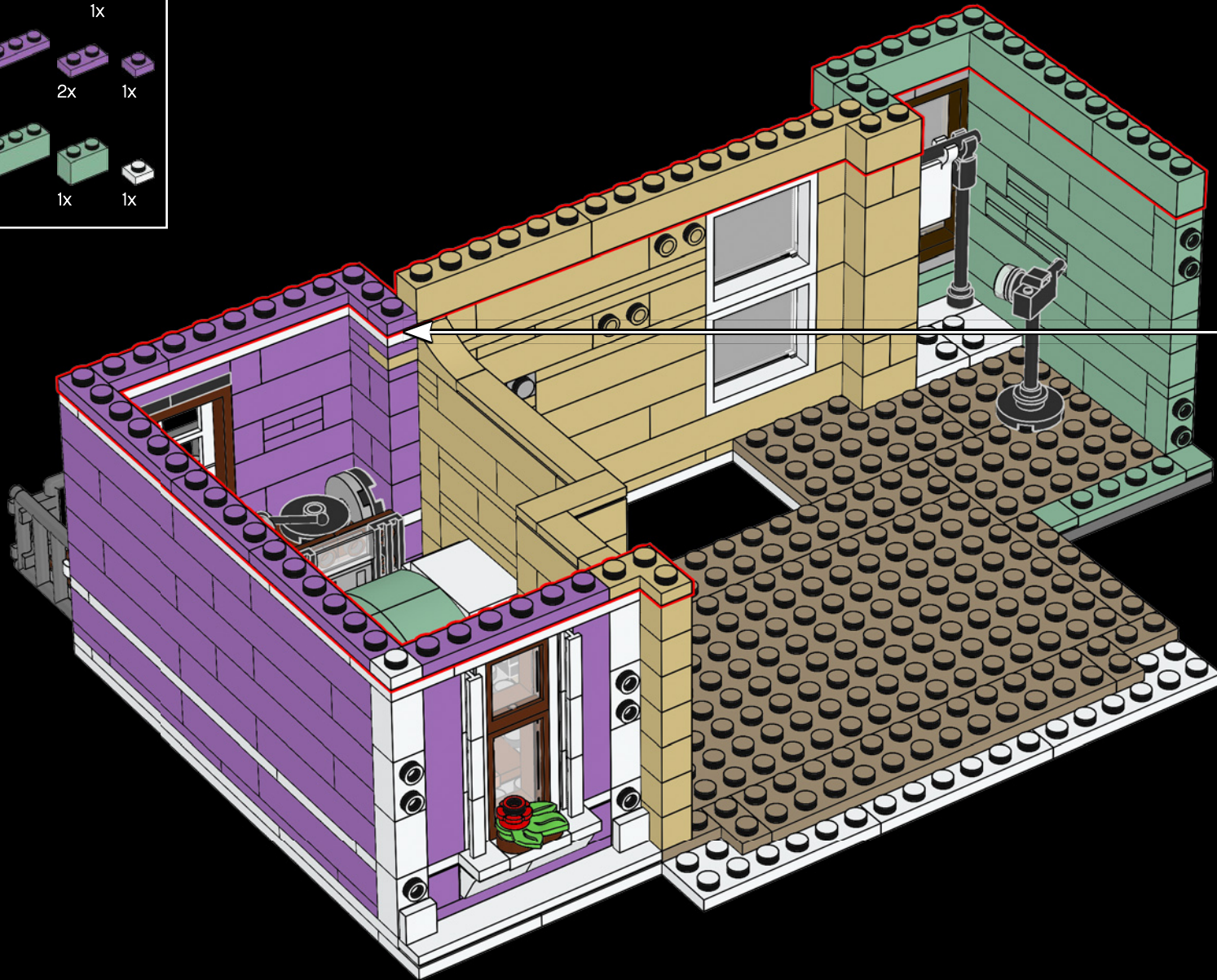





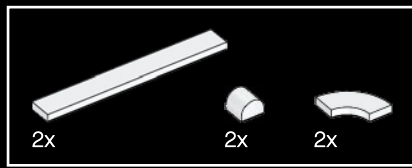

214

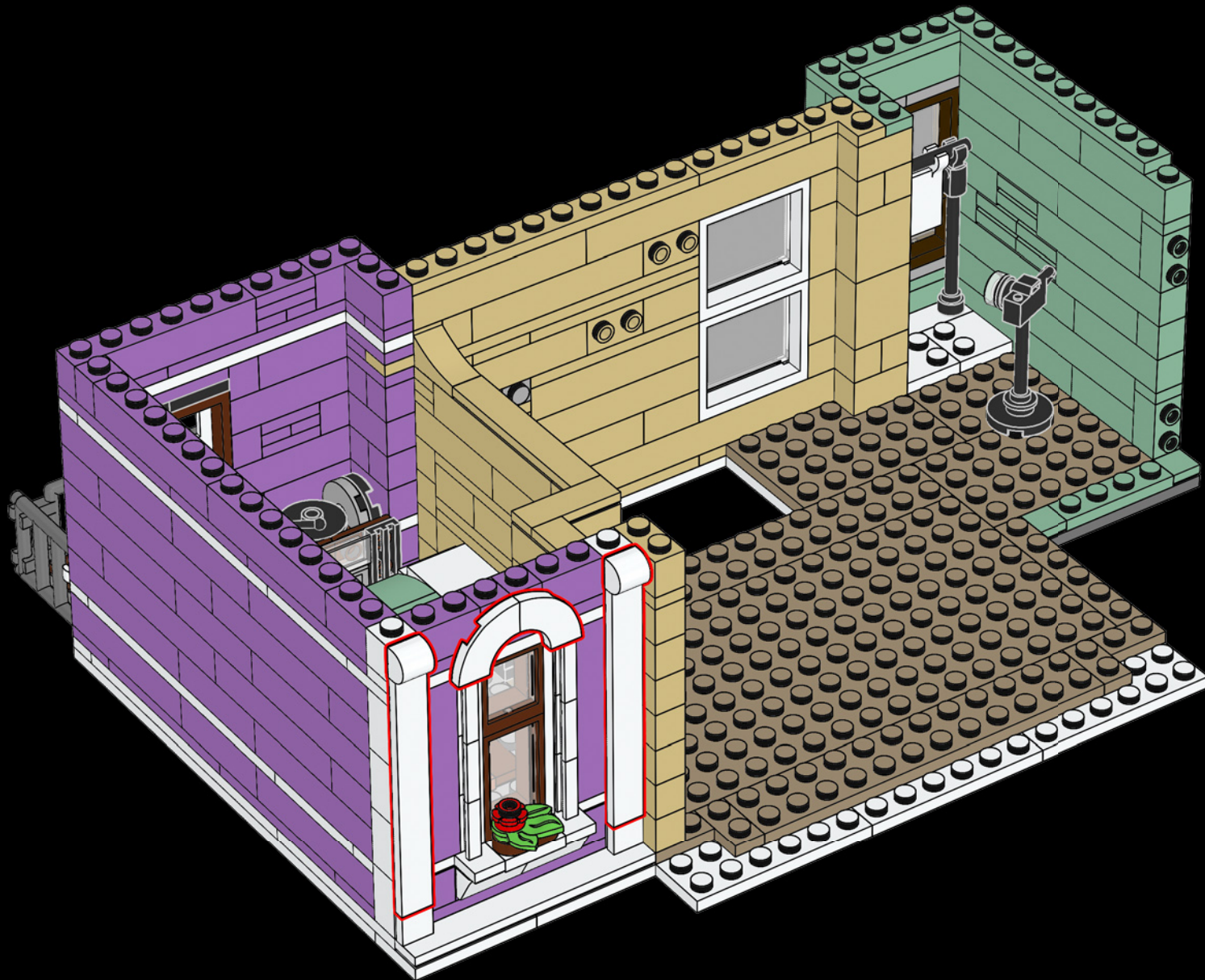

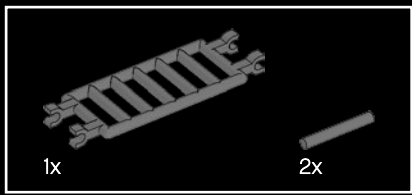

215

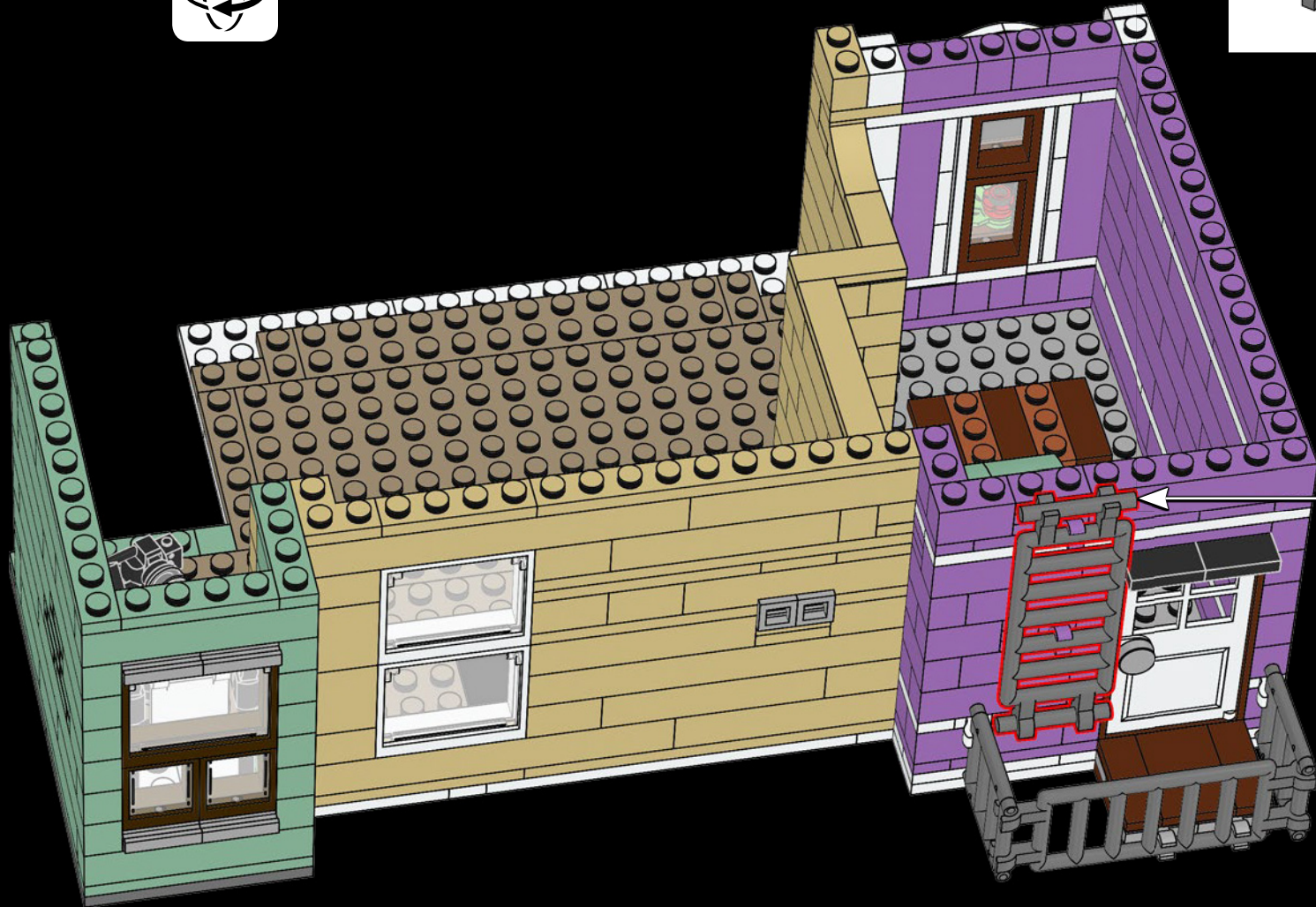
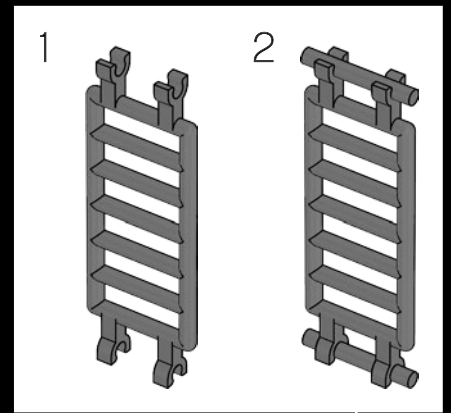



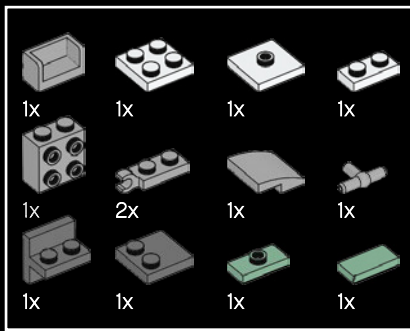

216

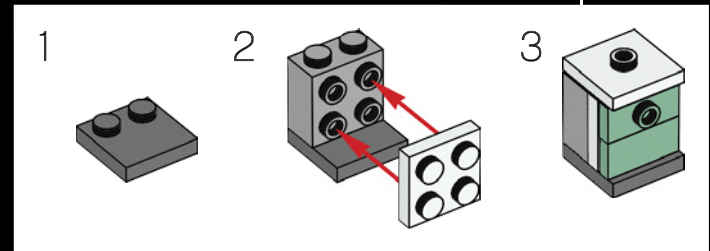
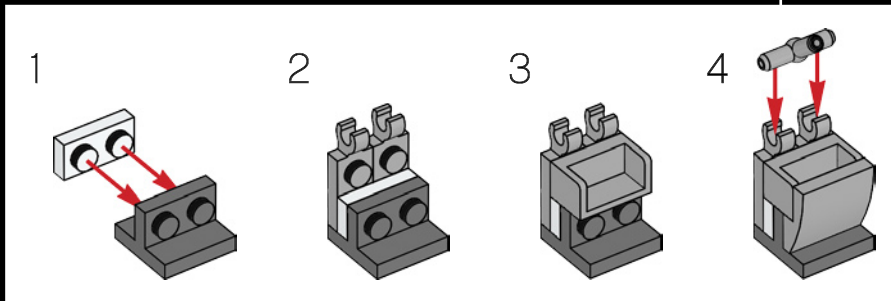
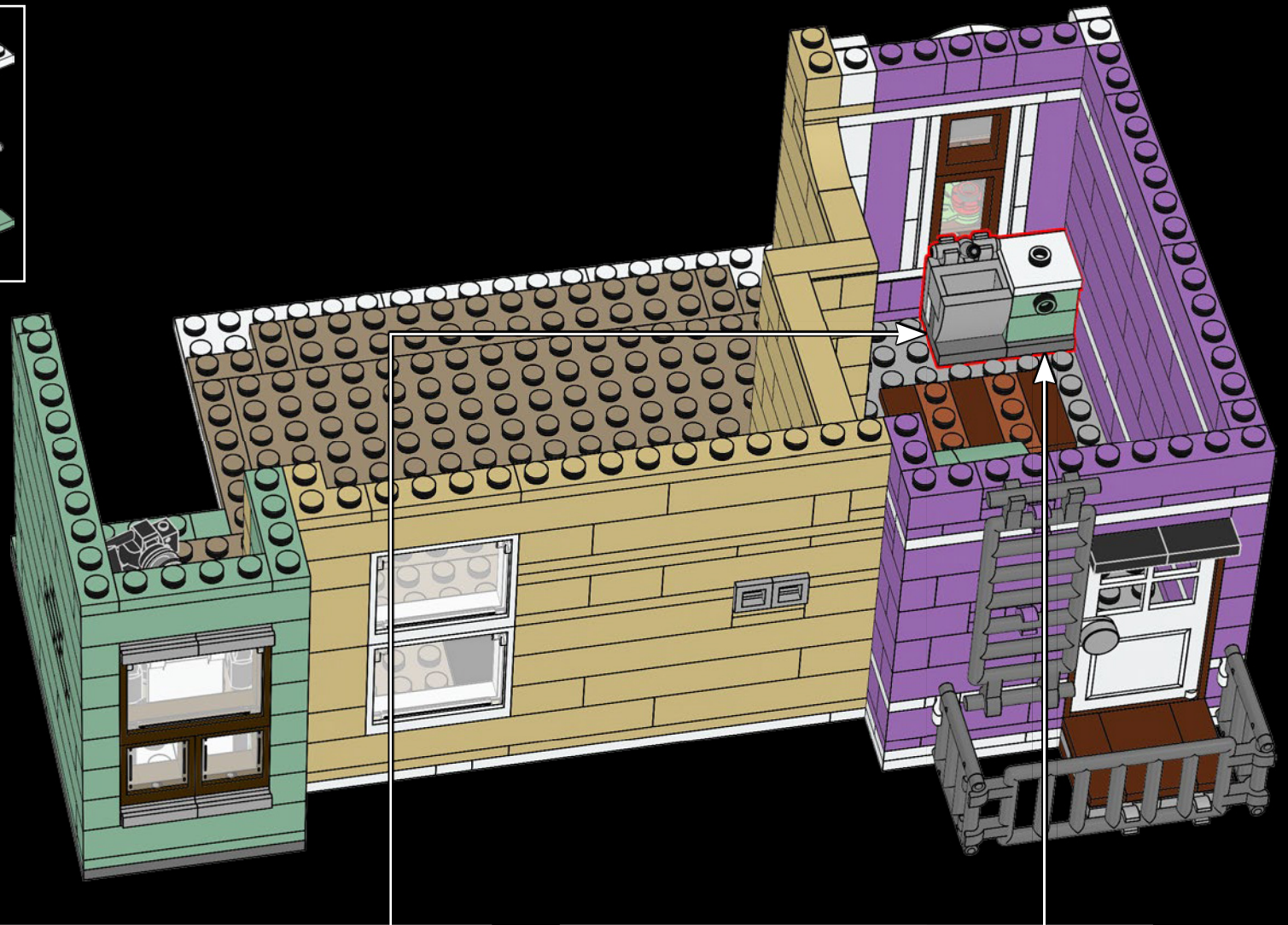





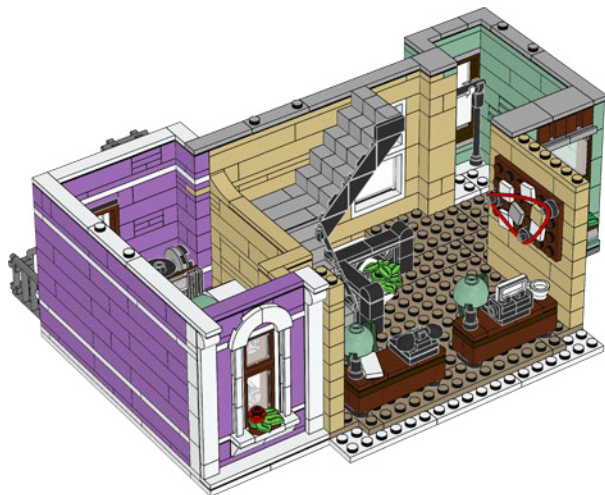

- The veteran police officer is ready to solve any crime that comes his way.
- Le policier expérimenté est prêt à résoudre tous les crimes qui se présentent.
- Este veterano oficial de policía está listo para resolver cualquier crimen que se le presente.

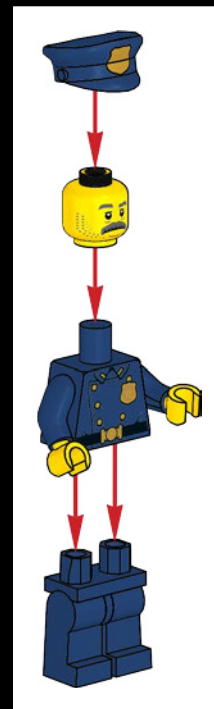

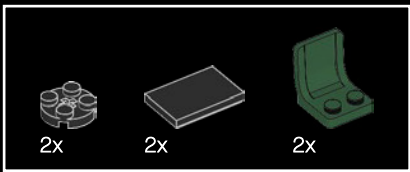

218

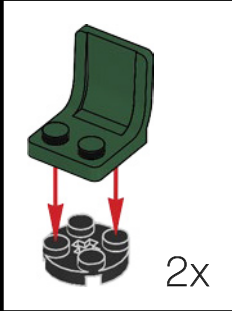
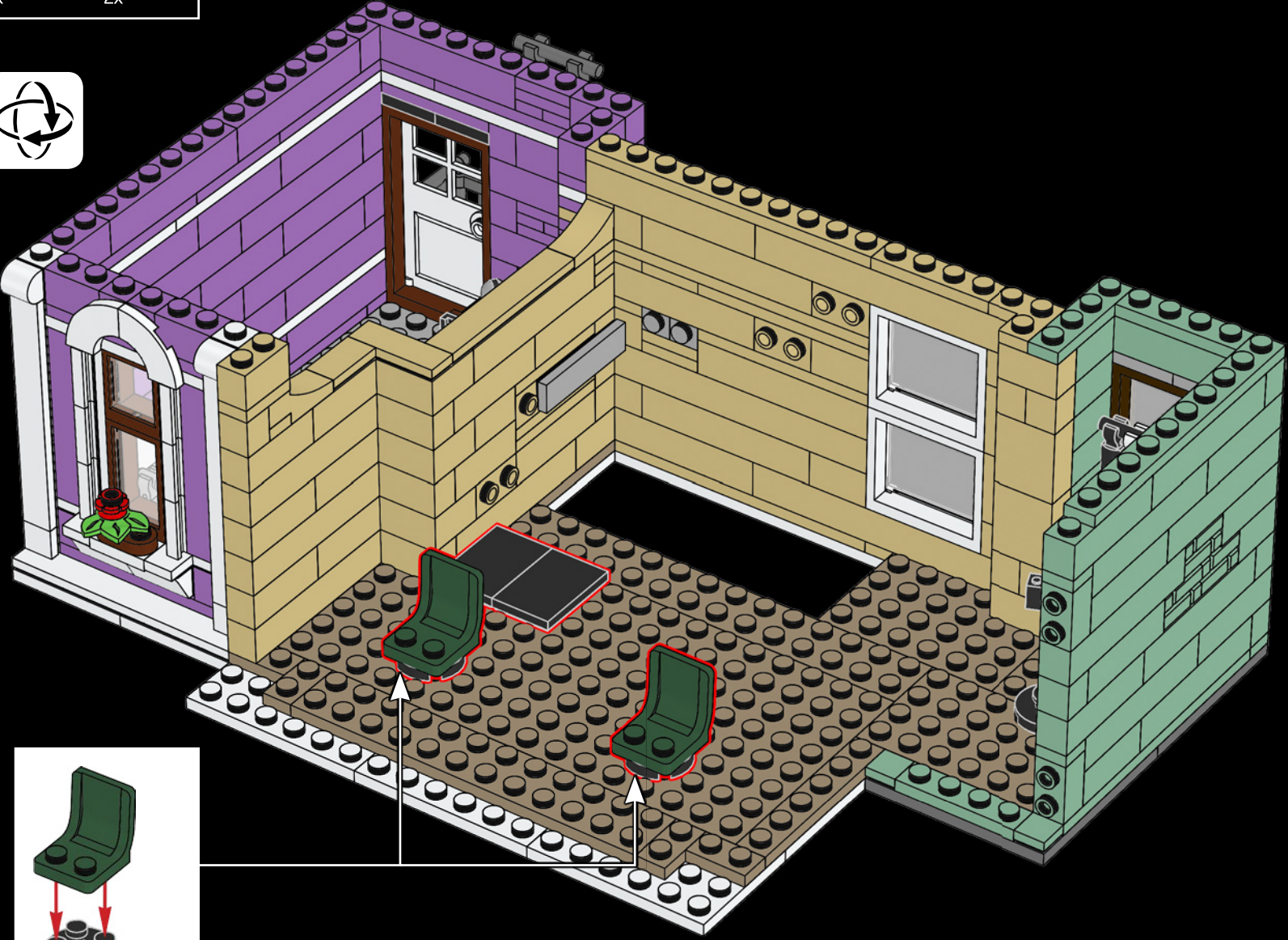



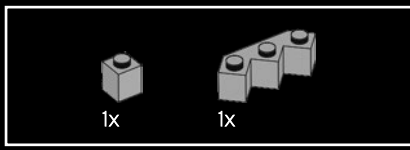

219

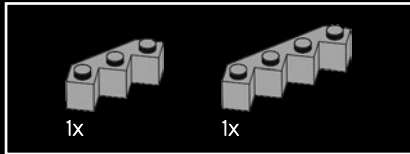
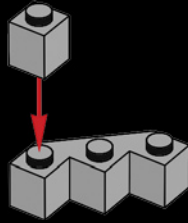

220

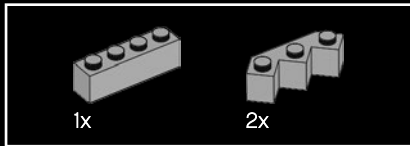
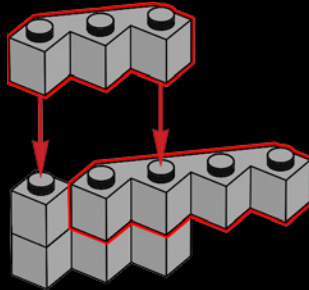

221

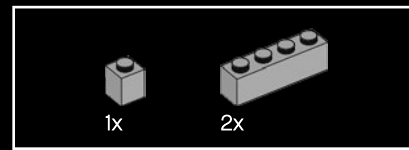
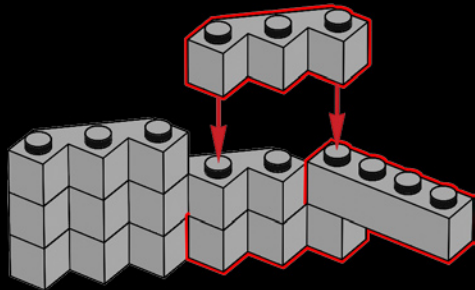

222

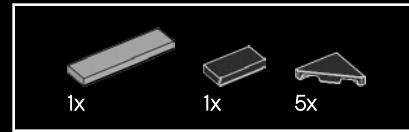
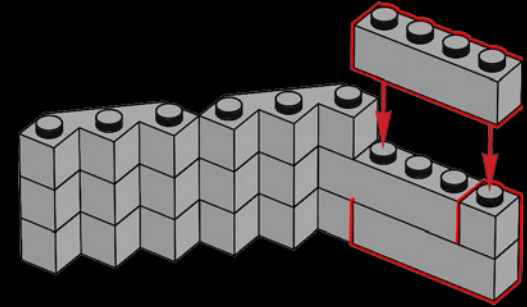

223

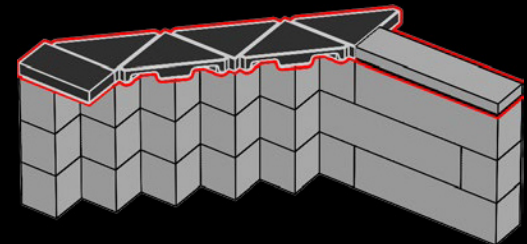

224

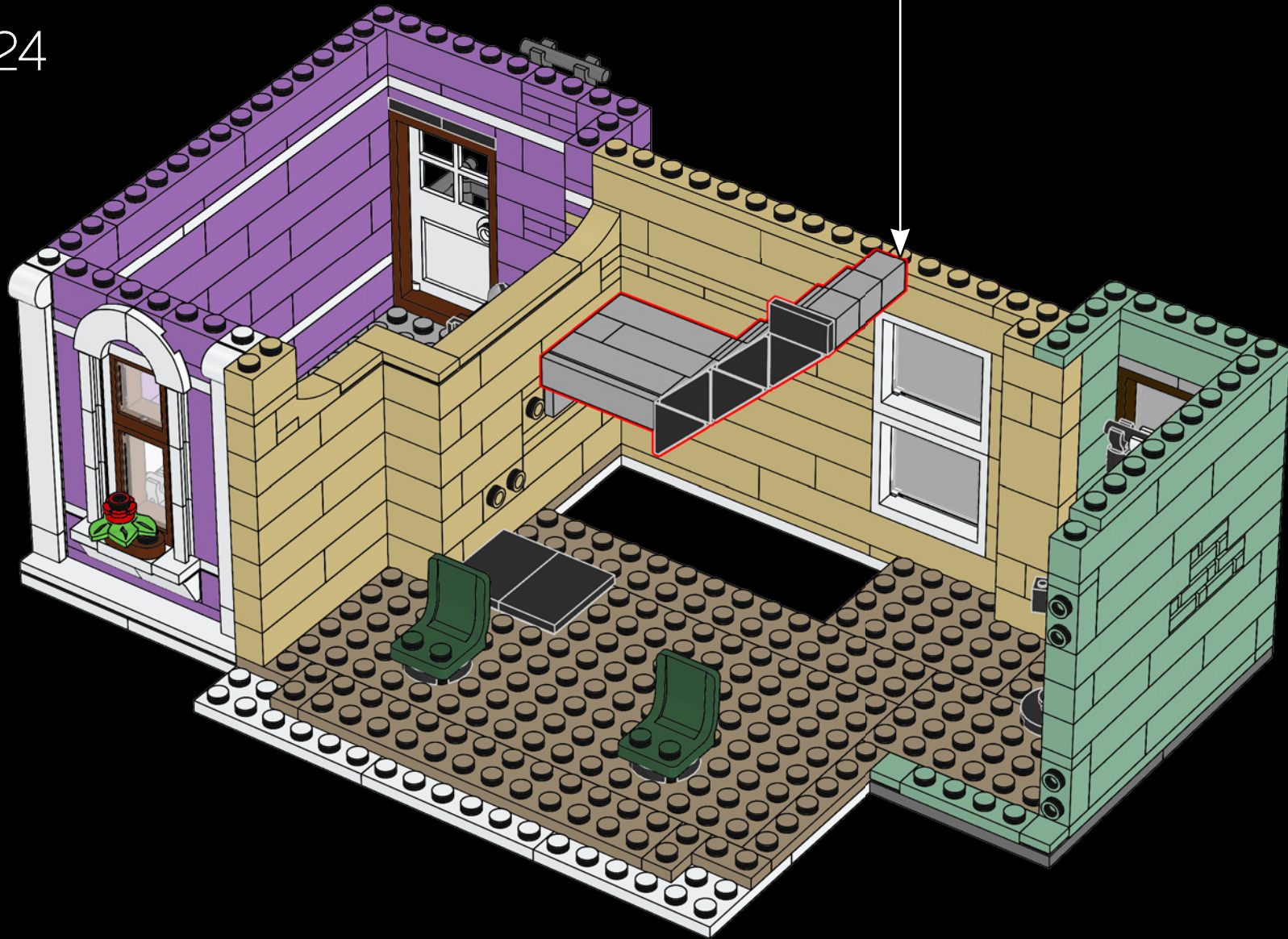



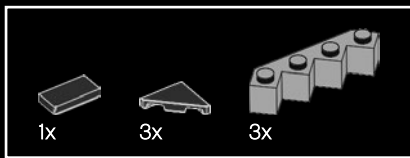

225

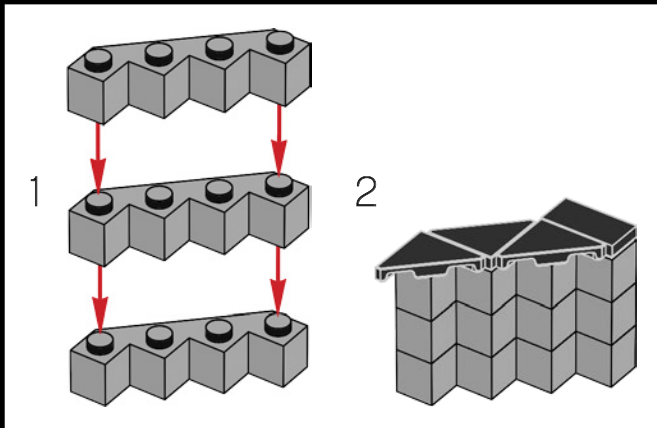
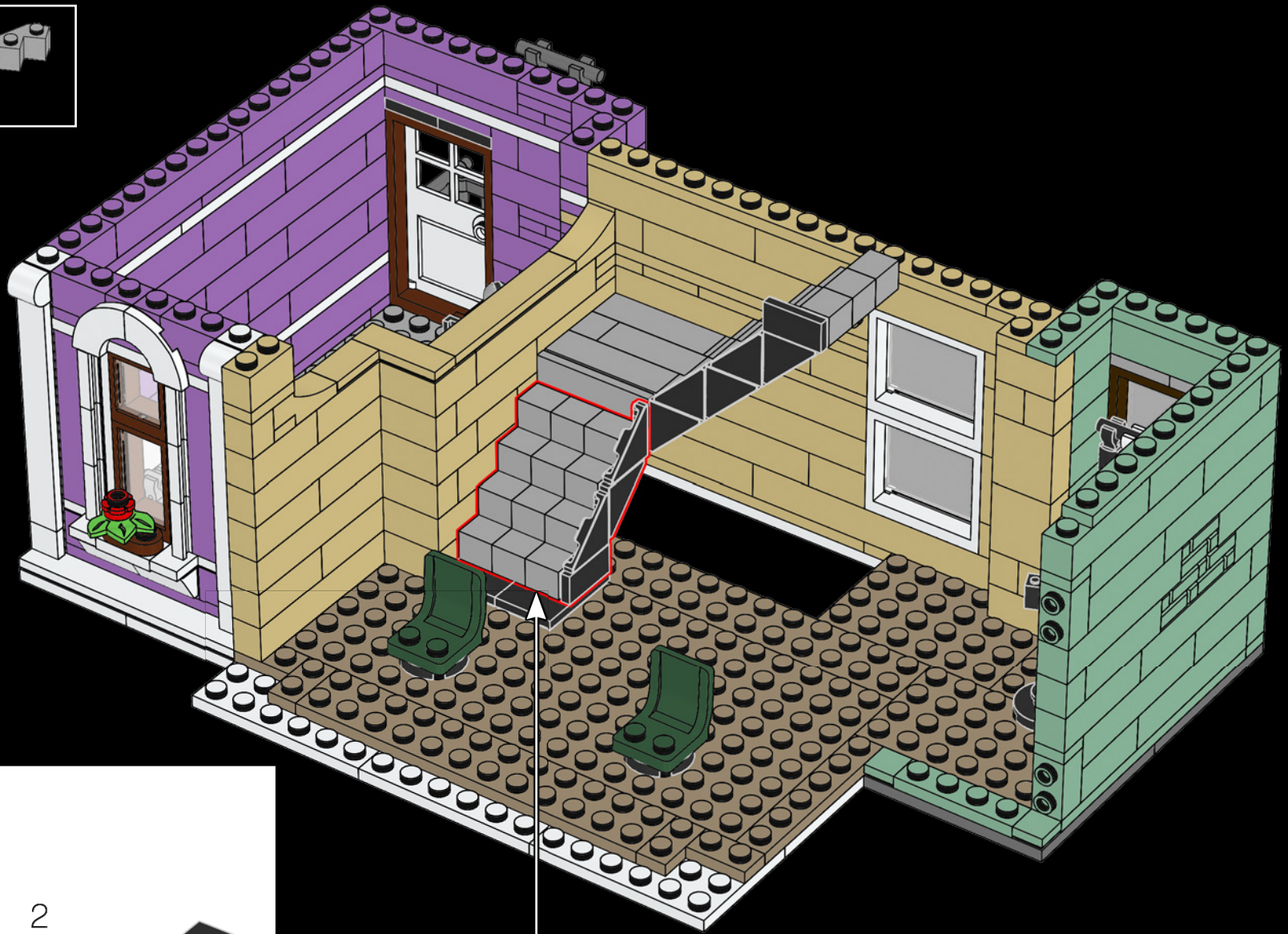

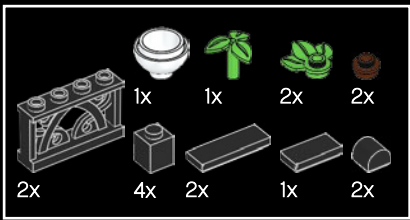

226

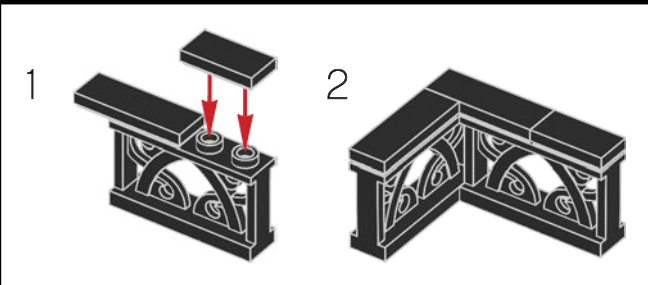
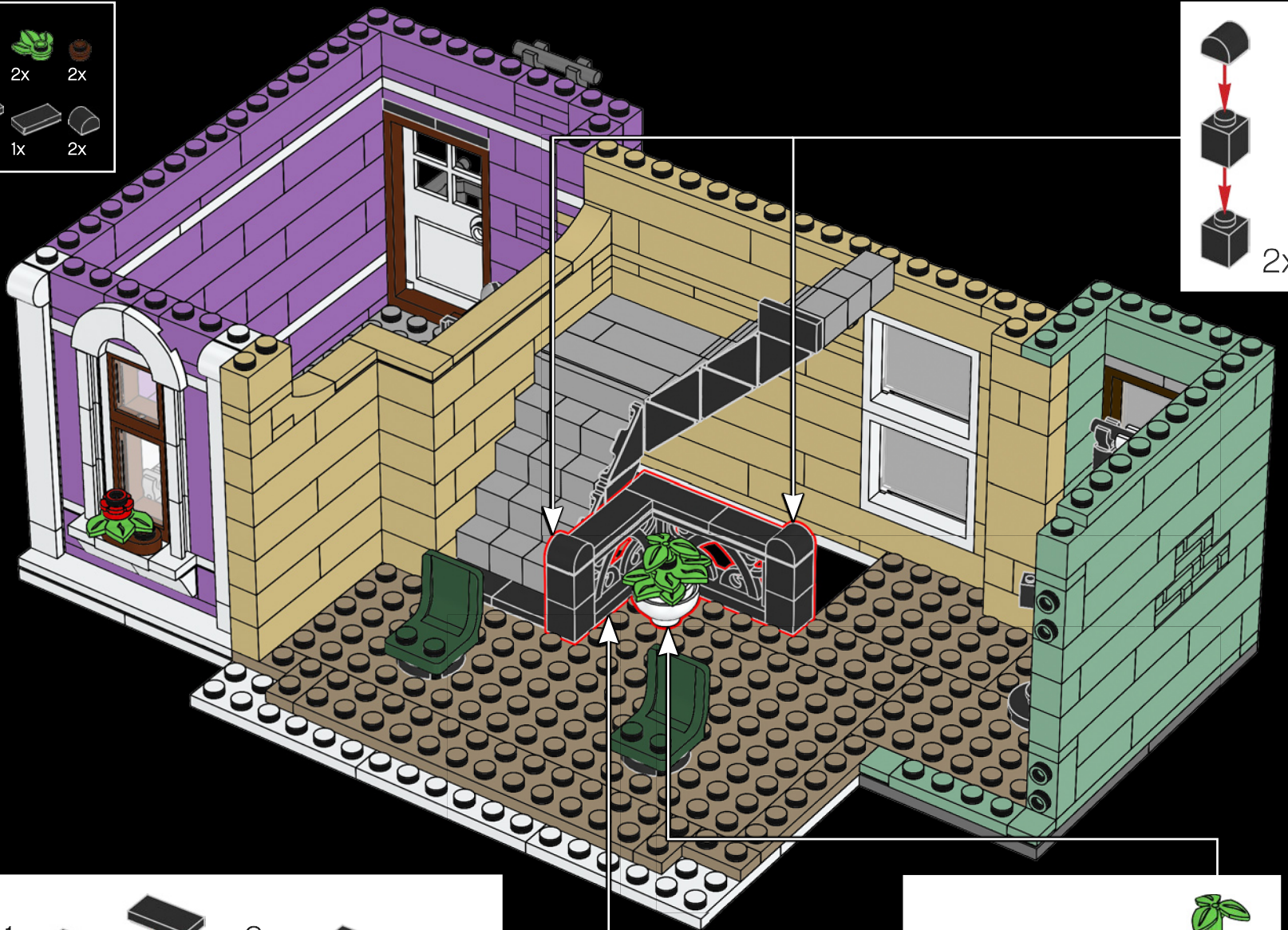



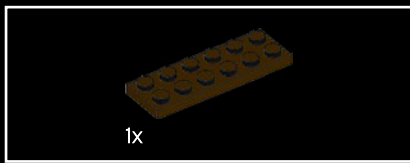

227

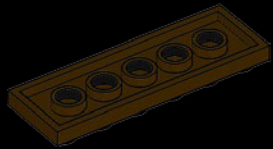

229

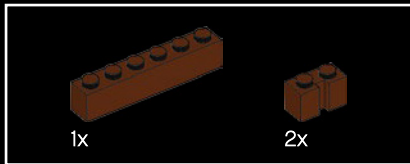
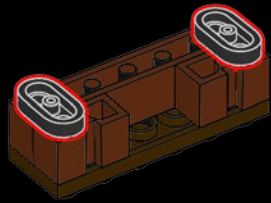

228

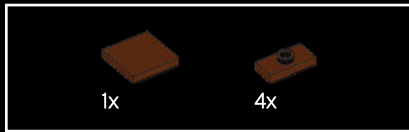
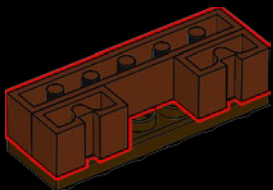

230

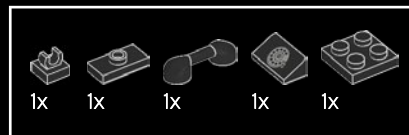
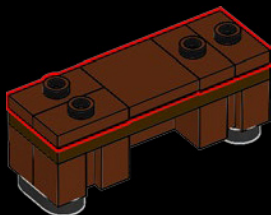

231

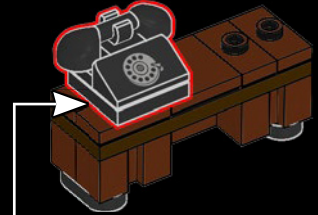
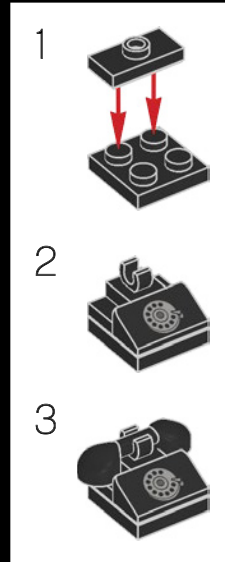

232

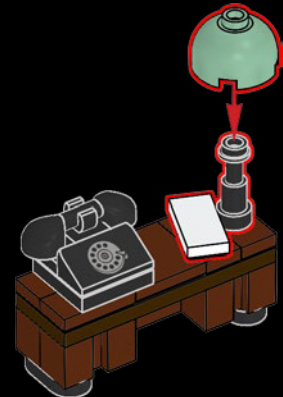

233





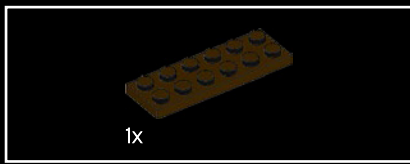

234

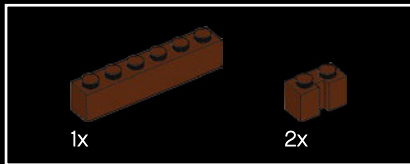
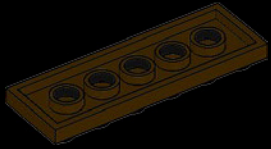

235

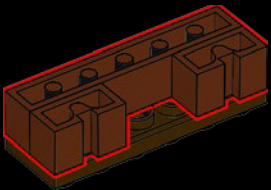

236

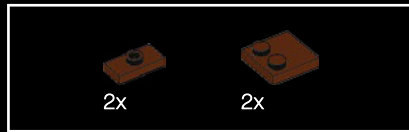
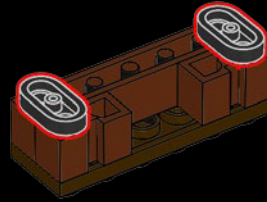

237

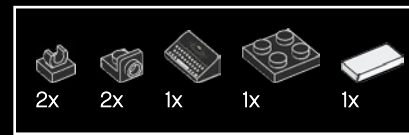
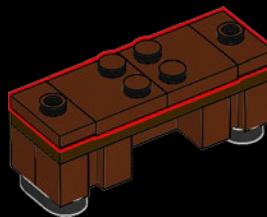

238

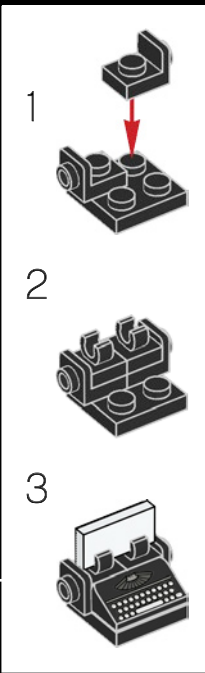
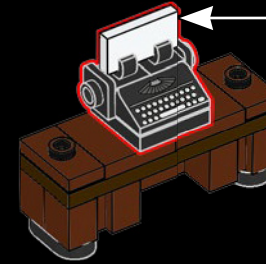

239



- The mechanical typewriter was once an essential piece of office equipment in every police station.
- La machine à écrire mécanique était autrefois un outil essentiel dans tout poste de police.
- La máquina de escribir mecánica llegó a ser parte fundamental del equipo de oficina de cualquier estación.

240





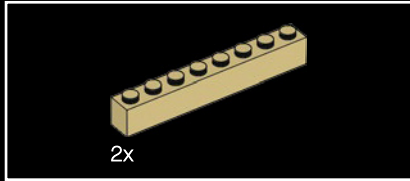
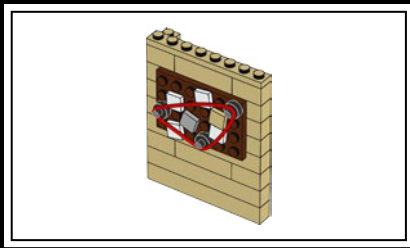

2x

241

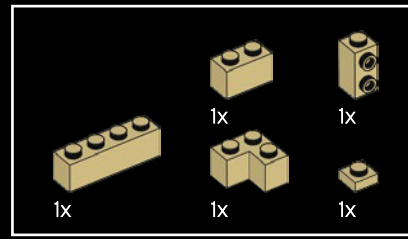
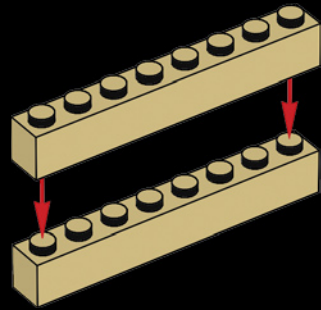

1x

1x

1x

1x

1x

242

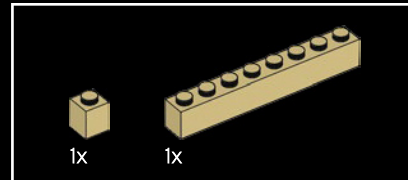
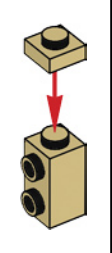
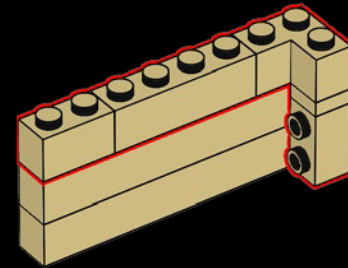

1x

1x

243

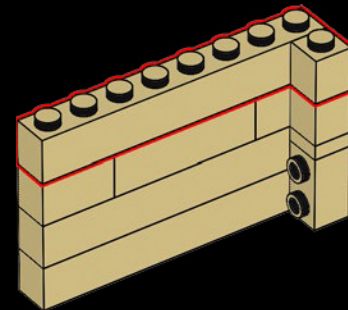

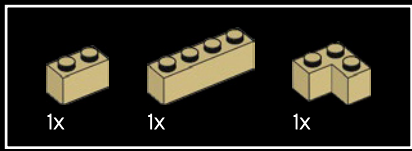

244

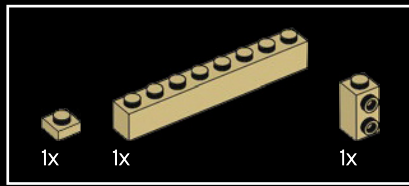
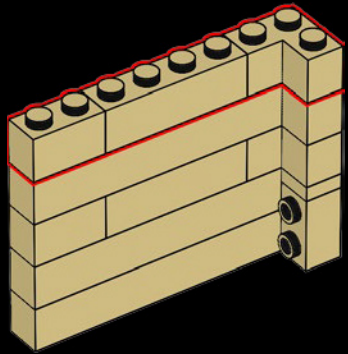

245

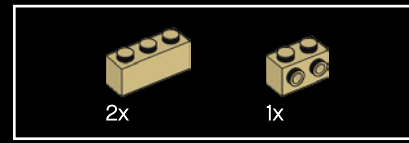
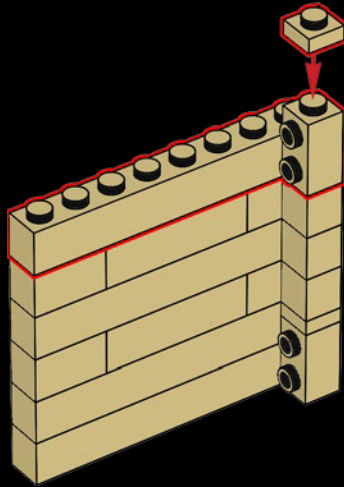

246

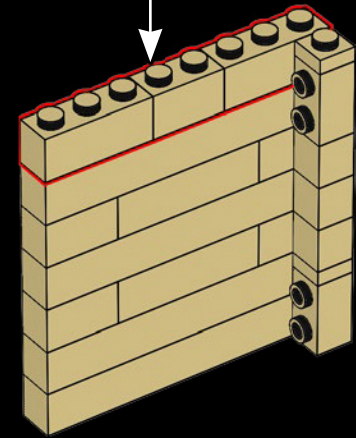
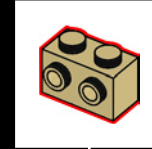



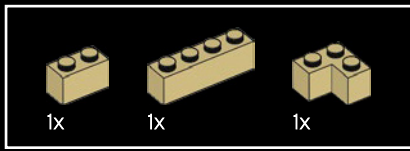

247

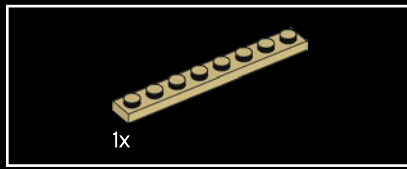
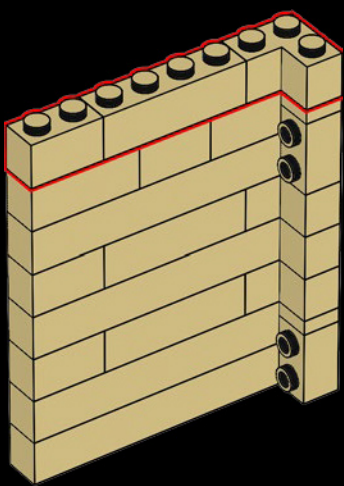

248

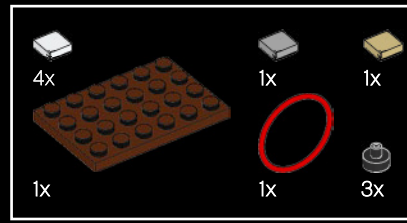
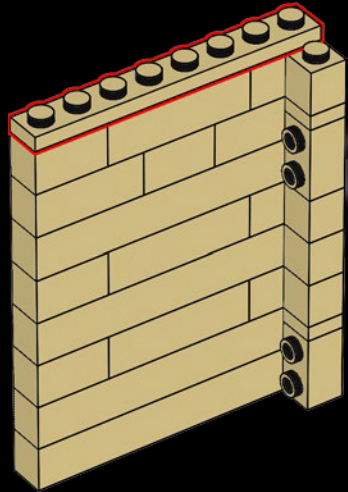

249

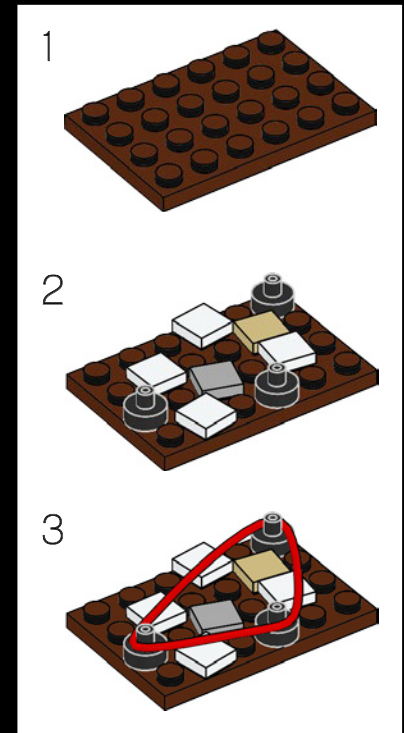
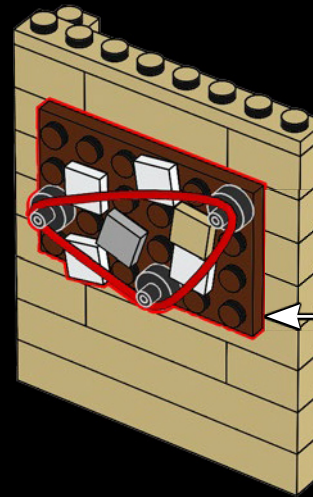

250

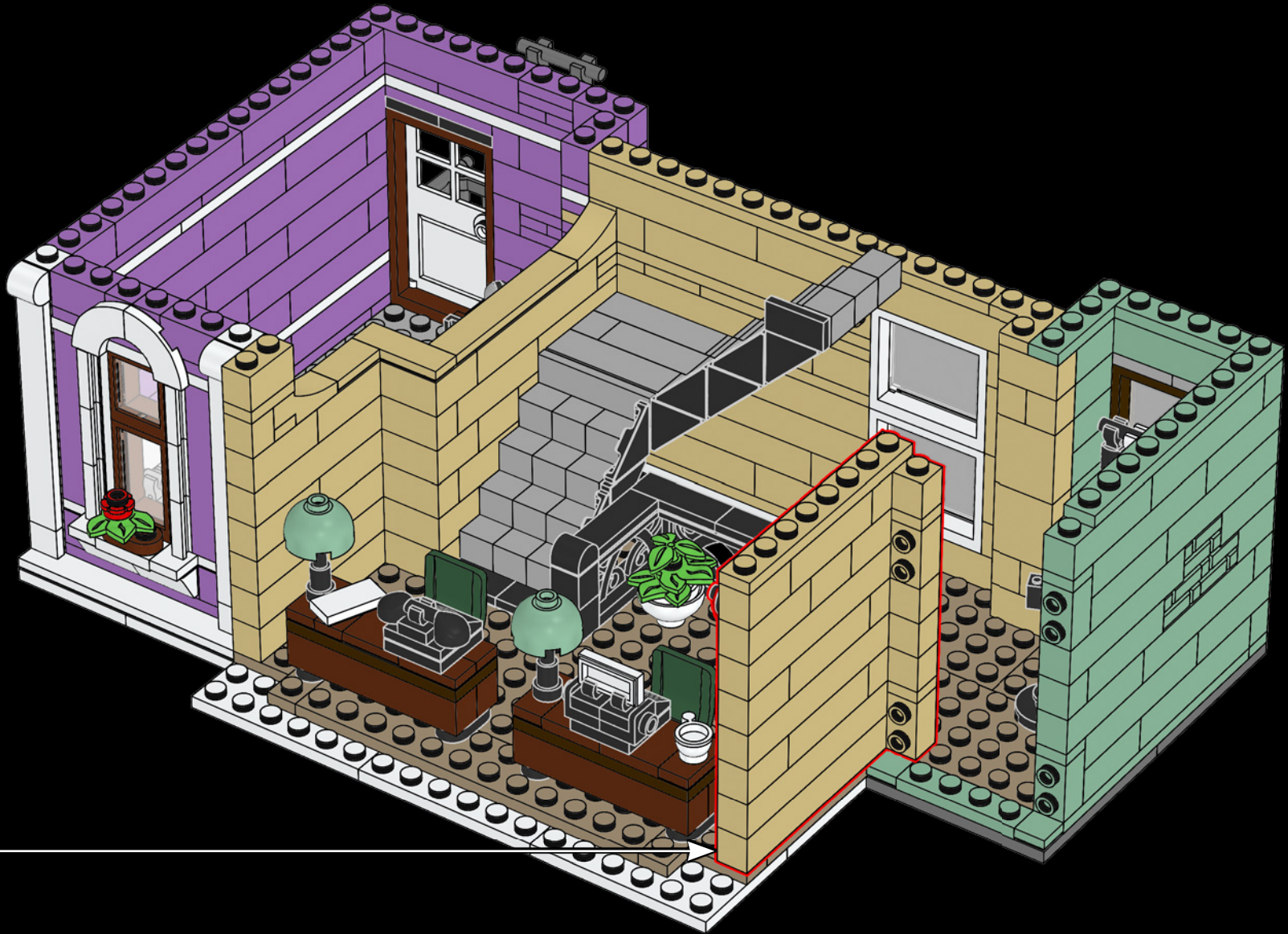



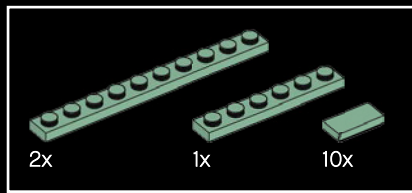

251

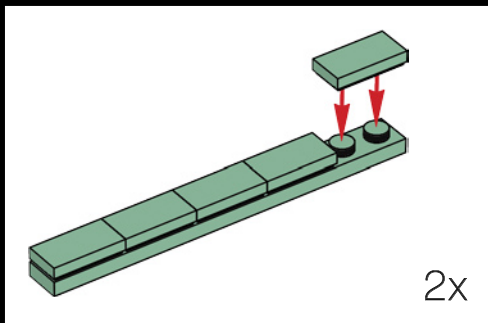
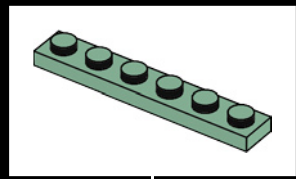
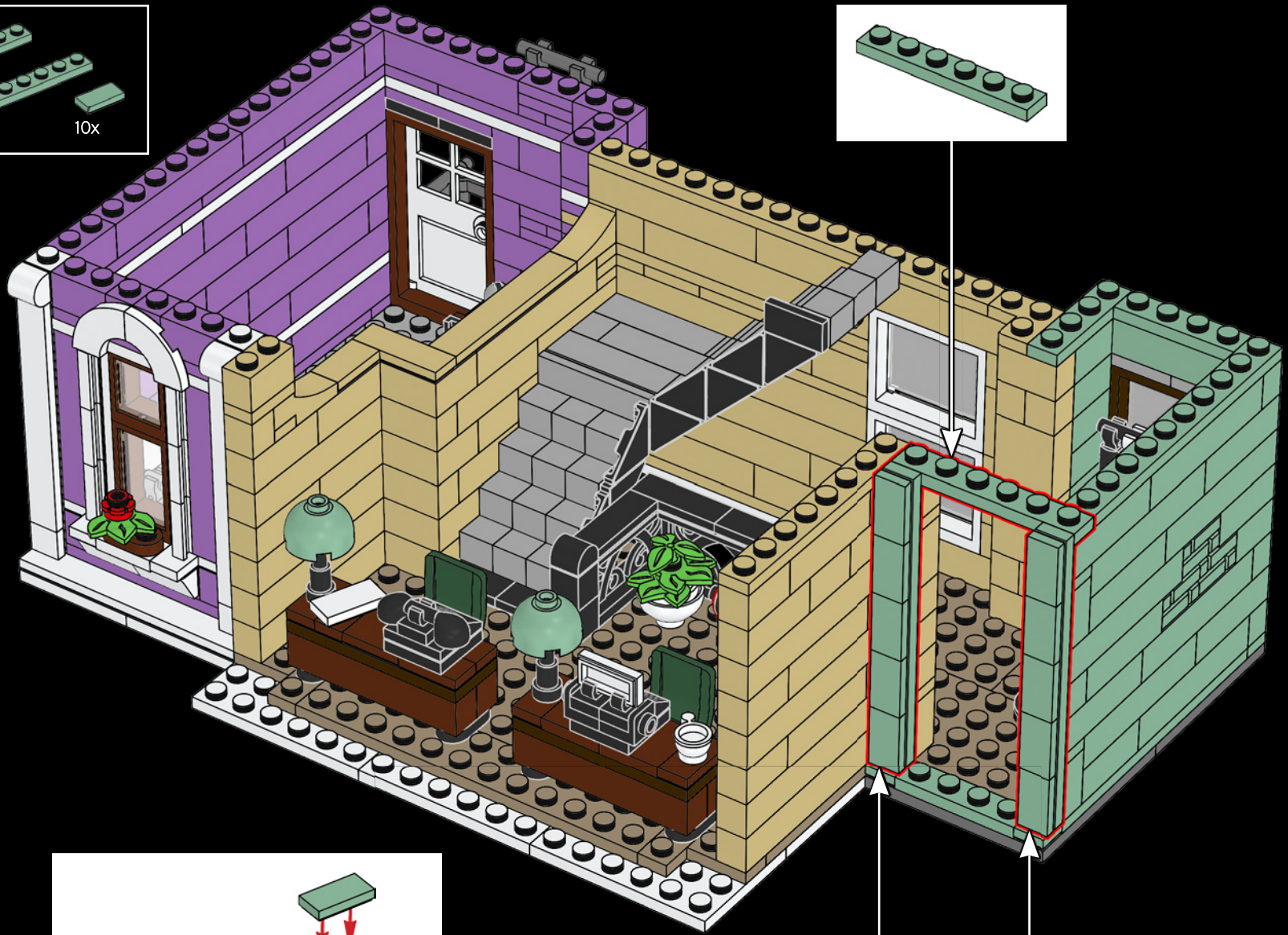

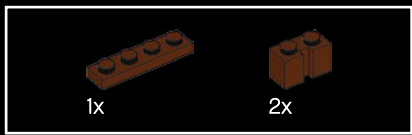

252

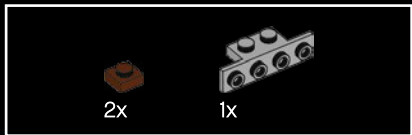
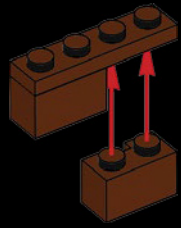

253

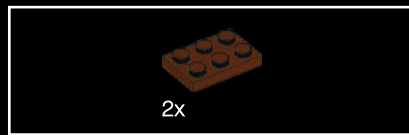
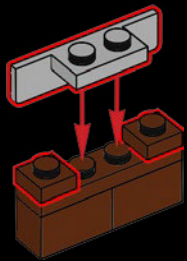

254

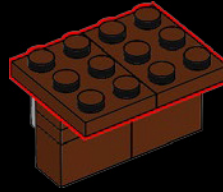

255

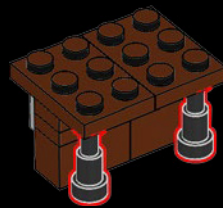

256

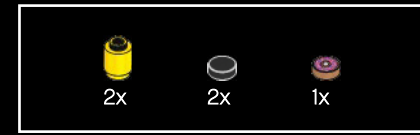
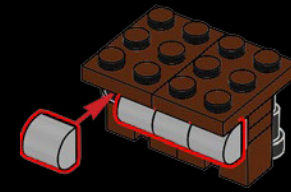

257

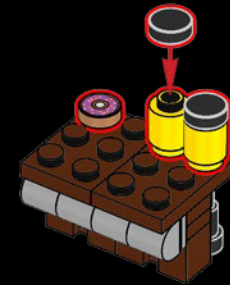



258

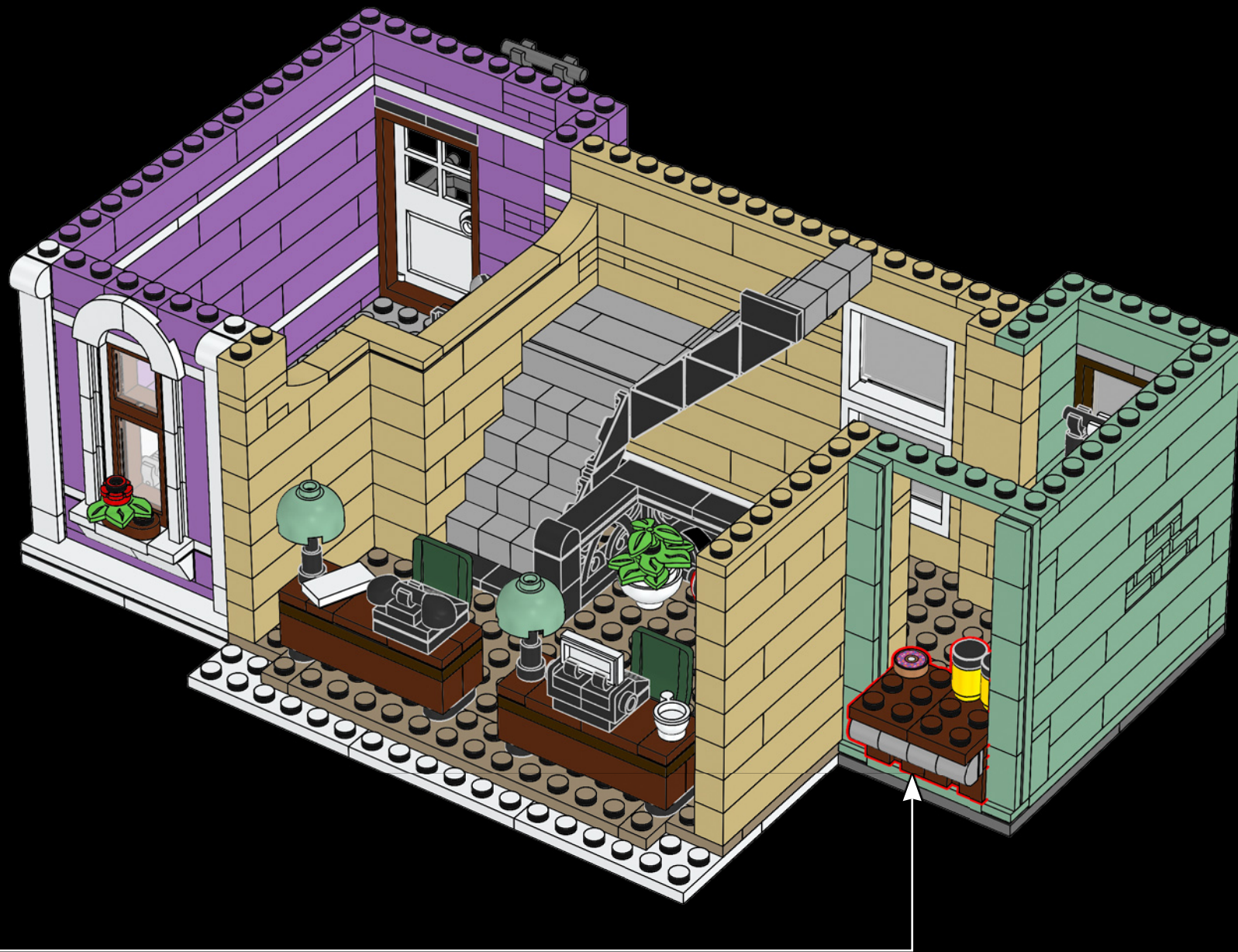

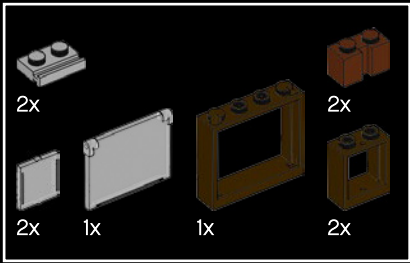

259

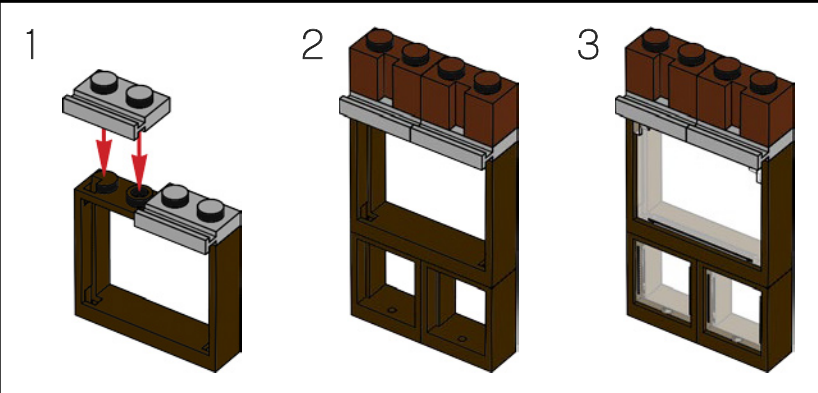



- 1x 
- 2x 
- 1x 
- 1x 

260

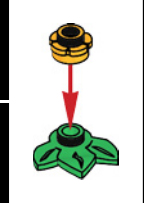
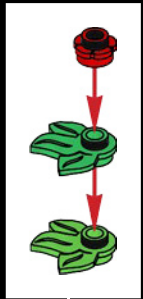

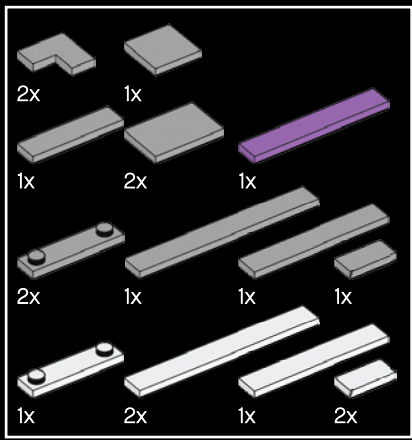

261







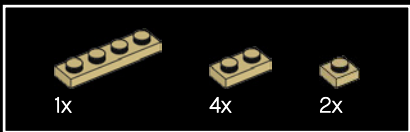

262





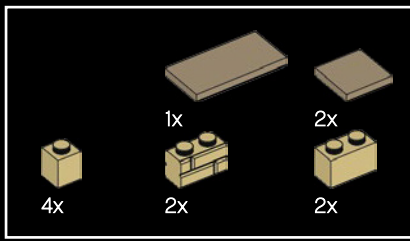

263



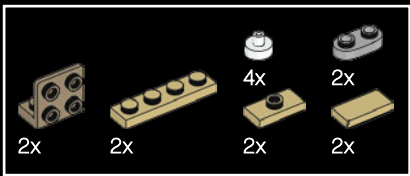

264

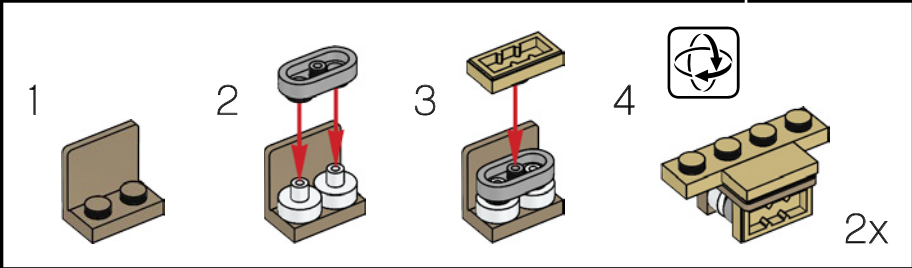



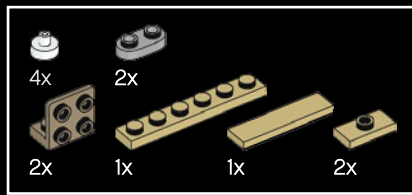

265

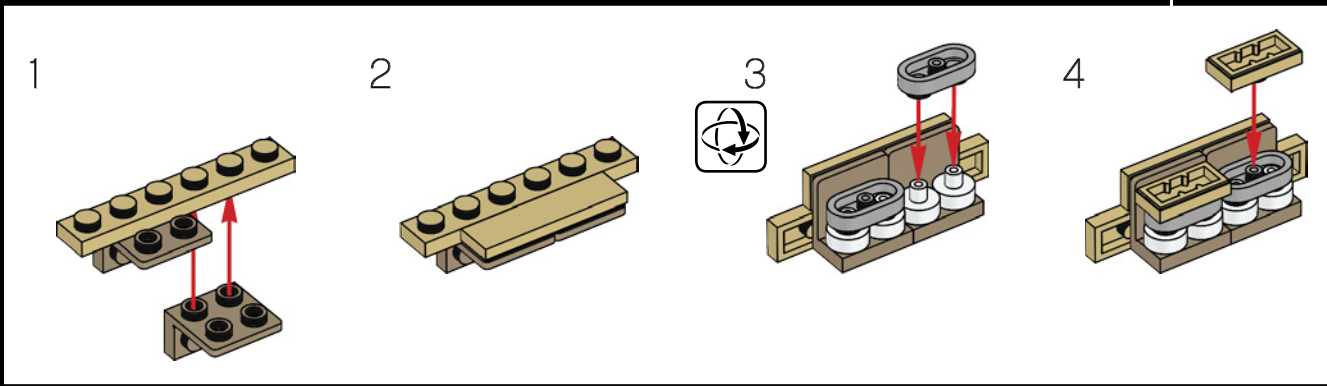



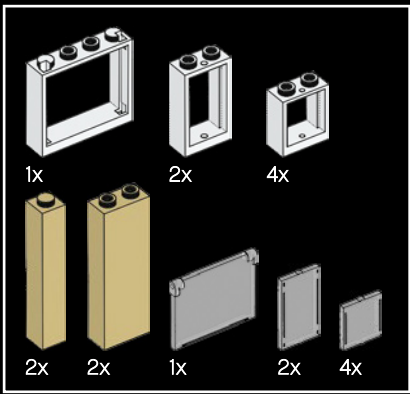

266

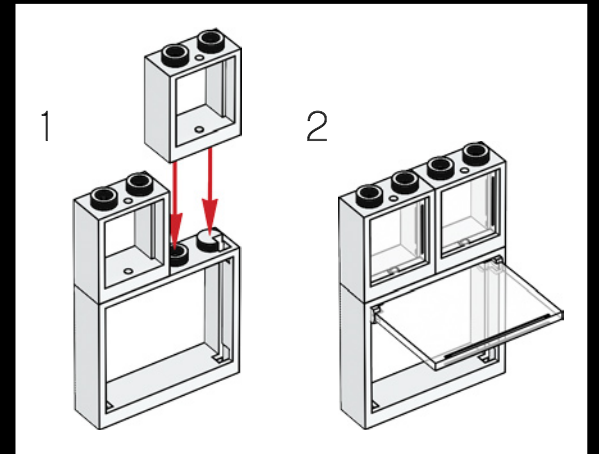
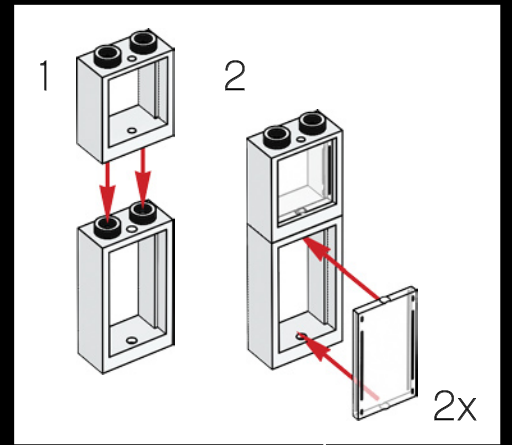



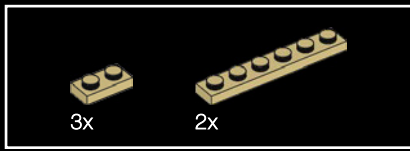

267

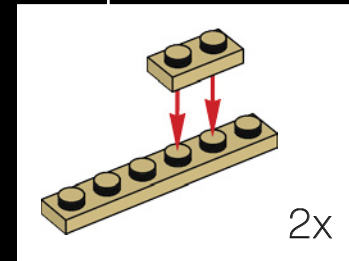
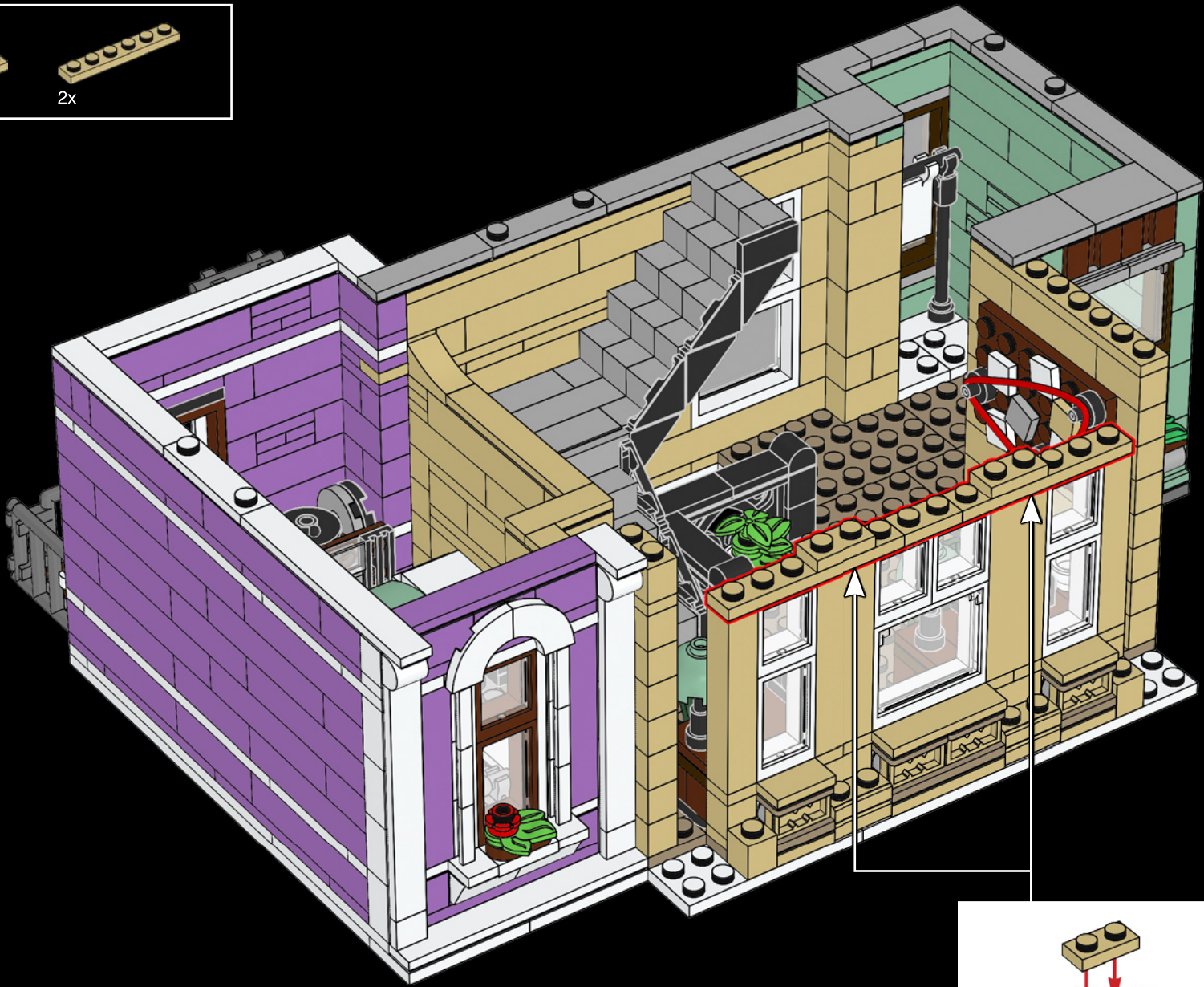

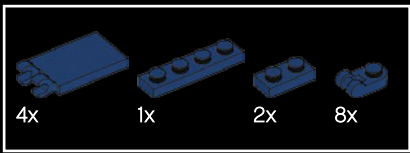

268

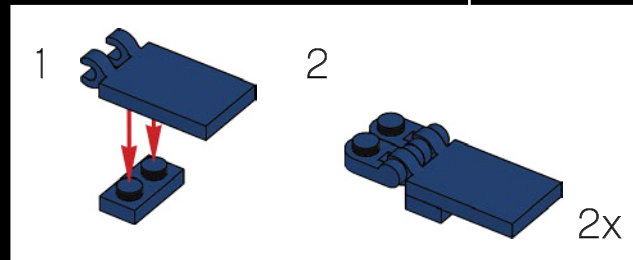
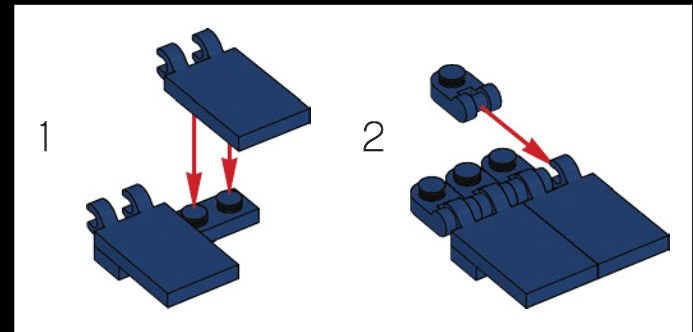



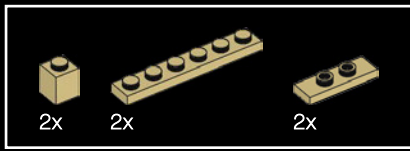

269

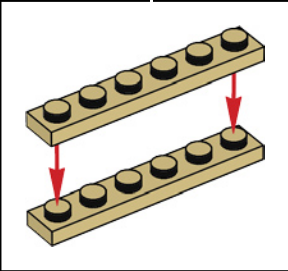

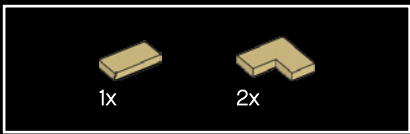

270





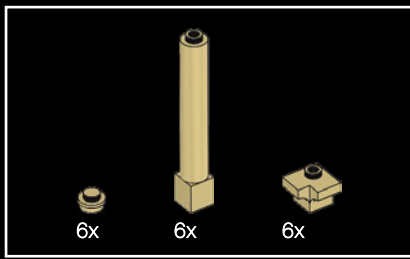

271

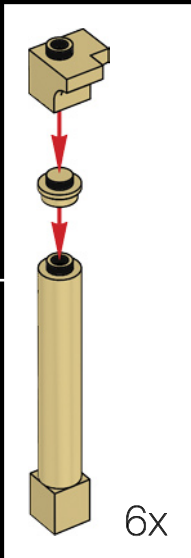
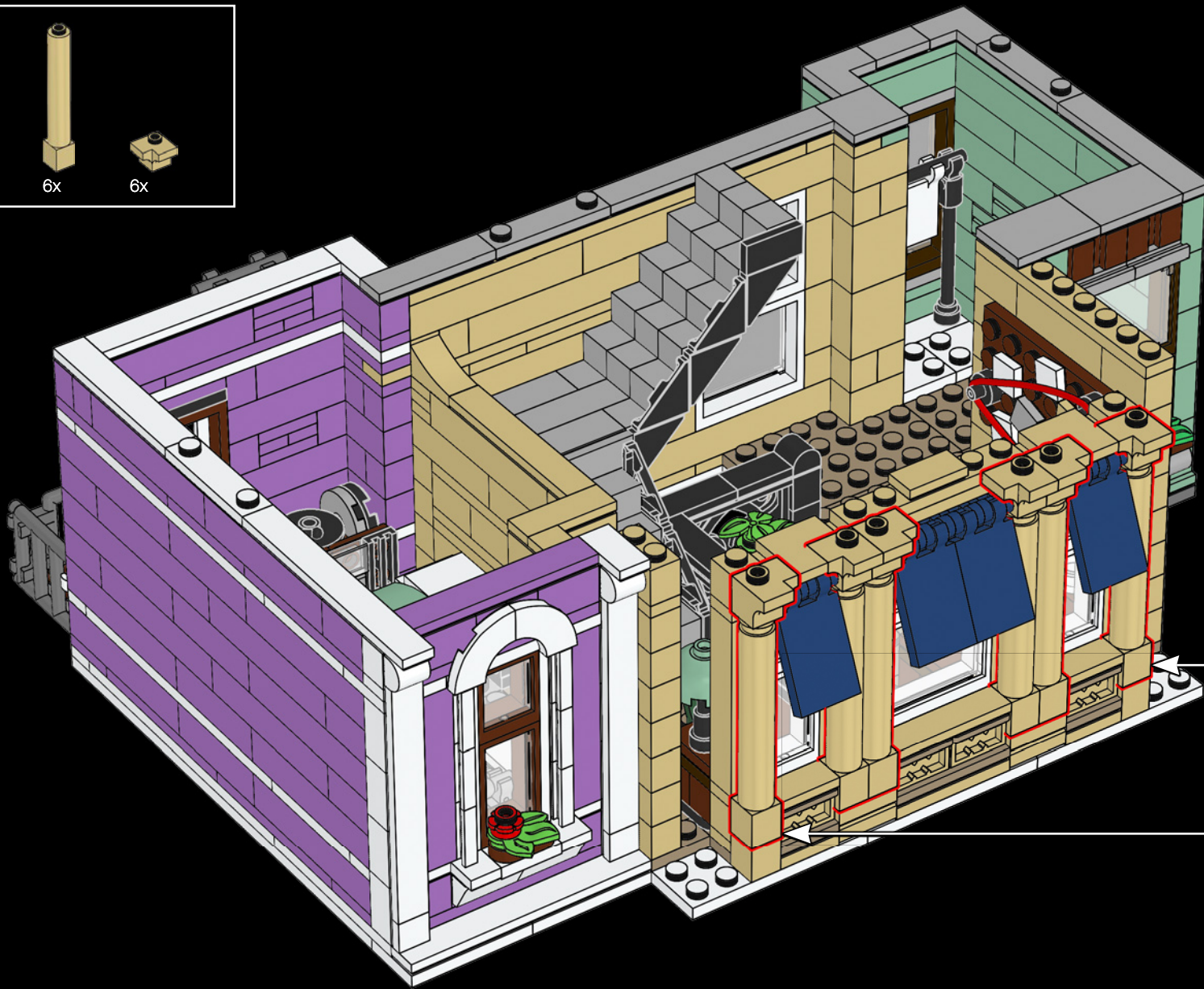

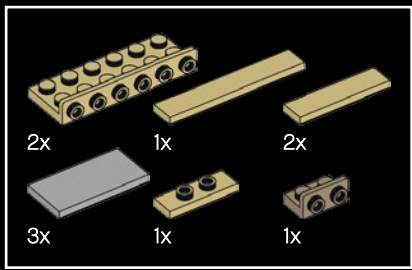

272

1

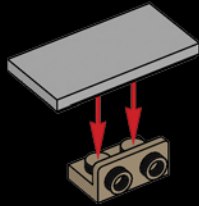

2

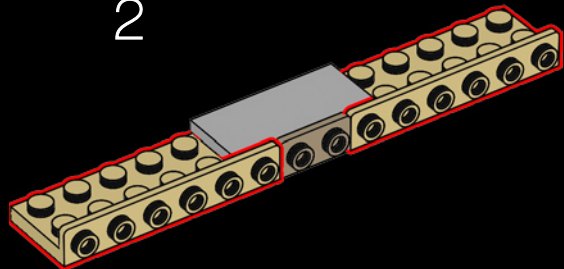

3

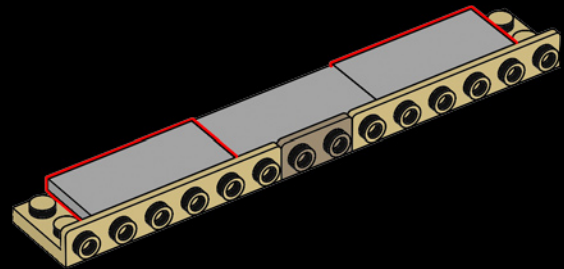

4

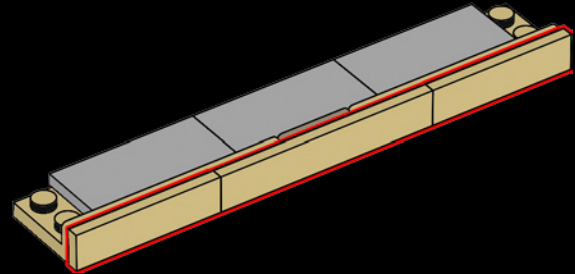

5

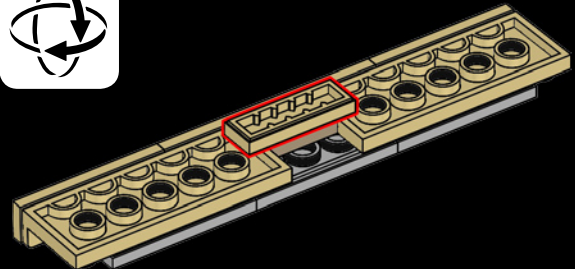



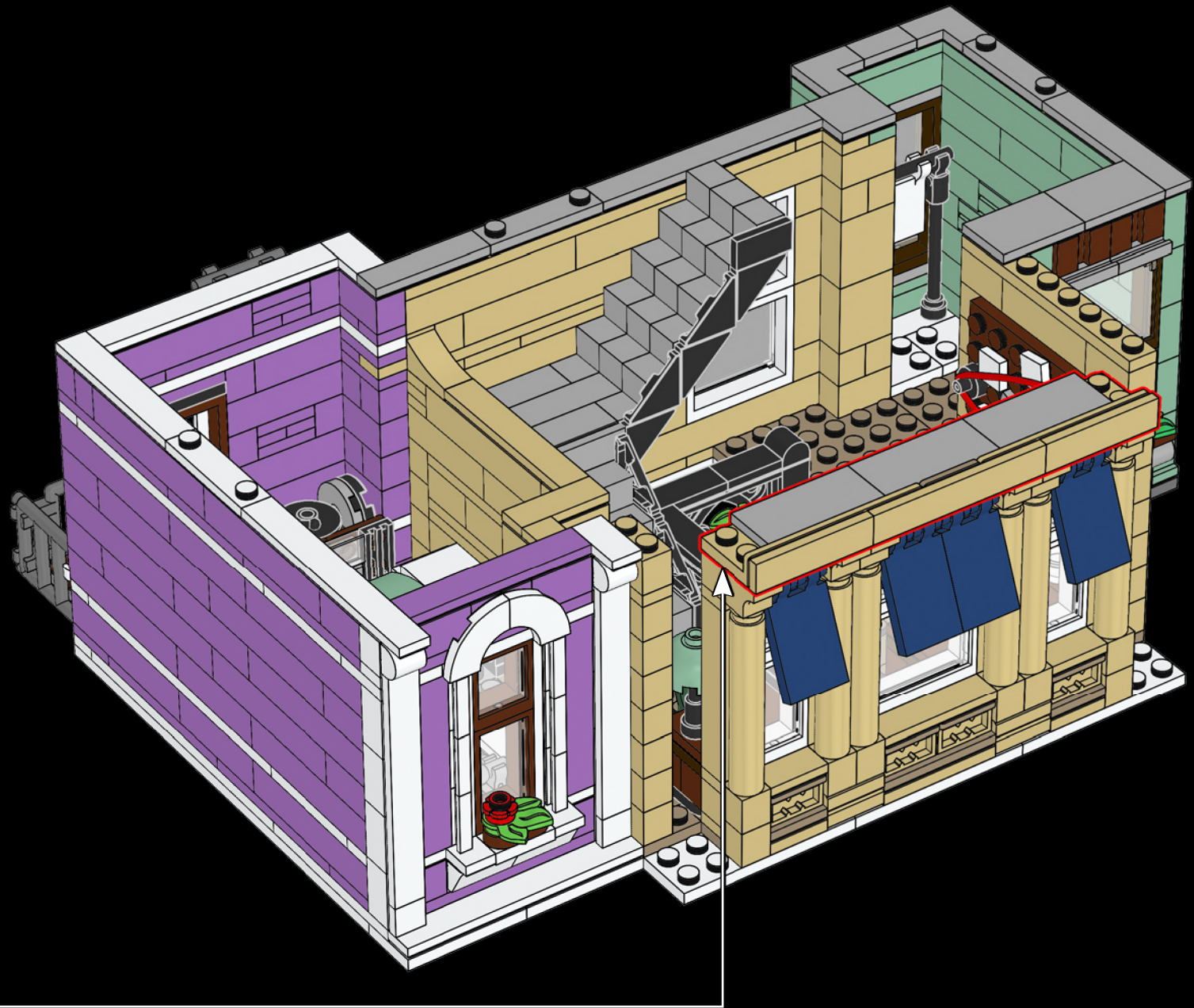

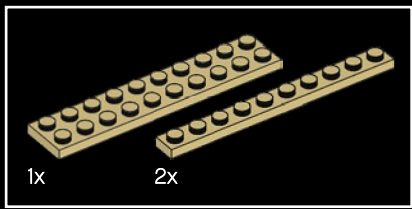

273

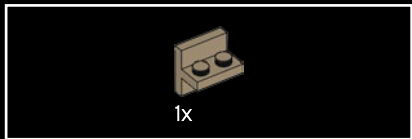
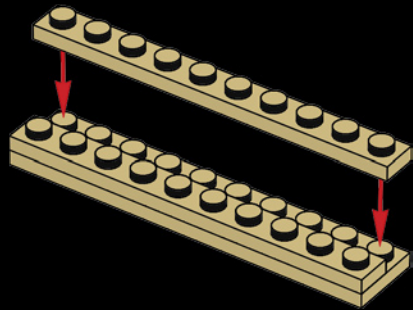

274

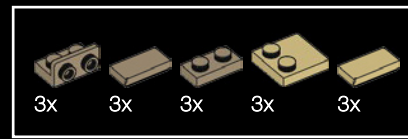
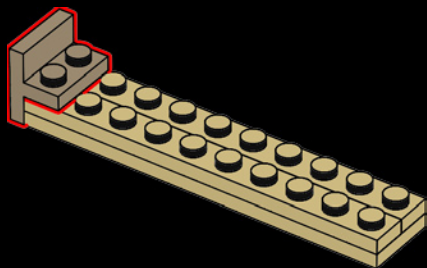

275

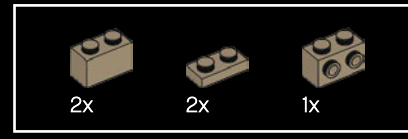
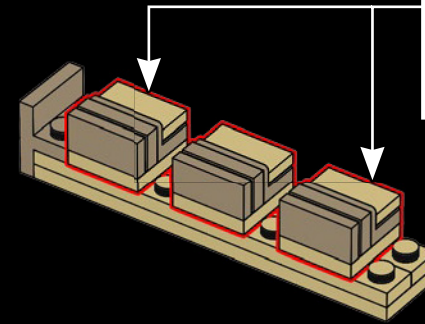

276

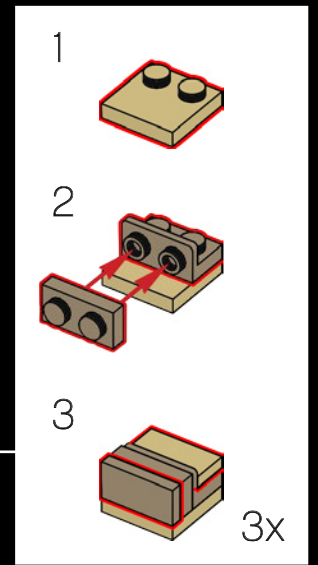
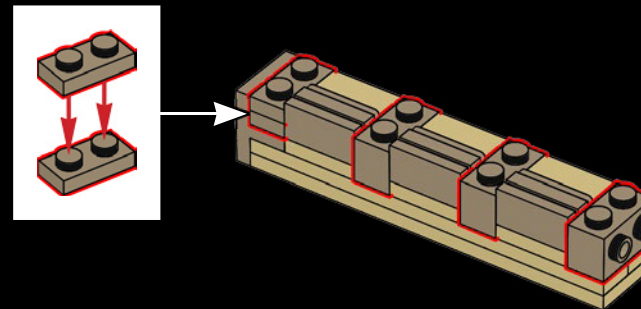





277

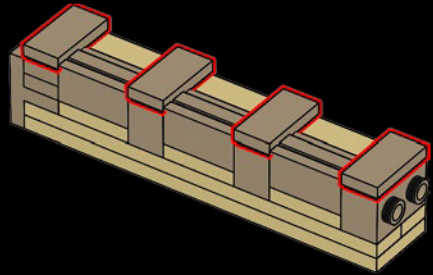

278

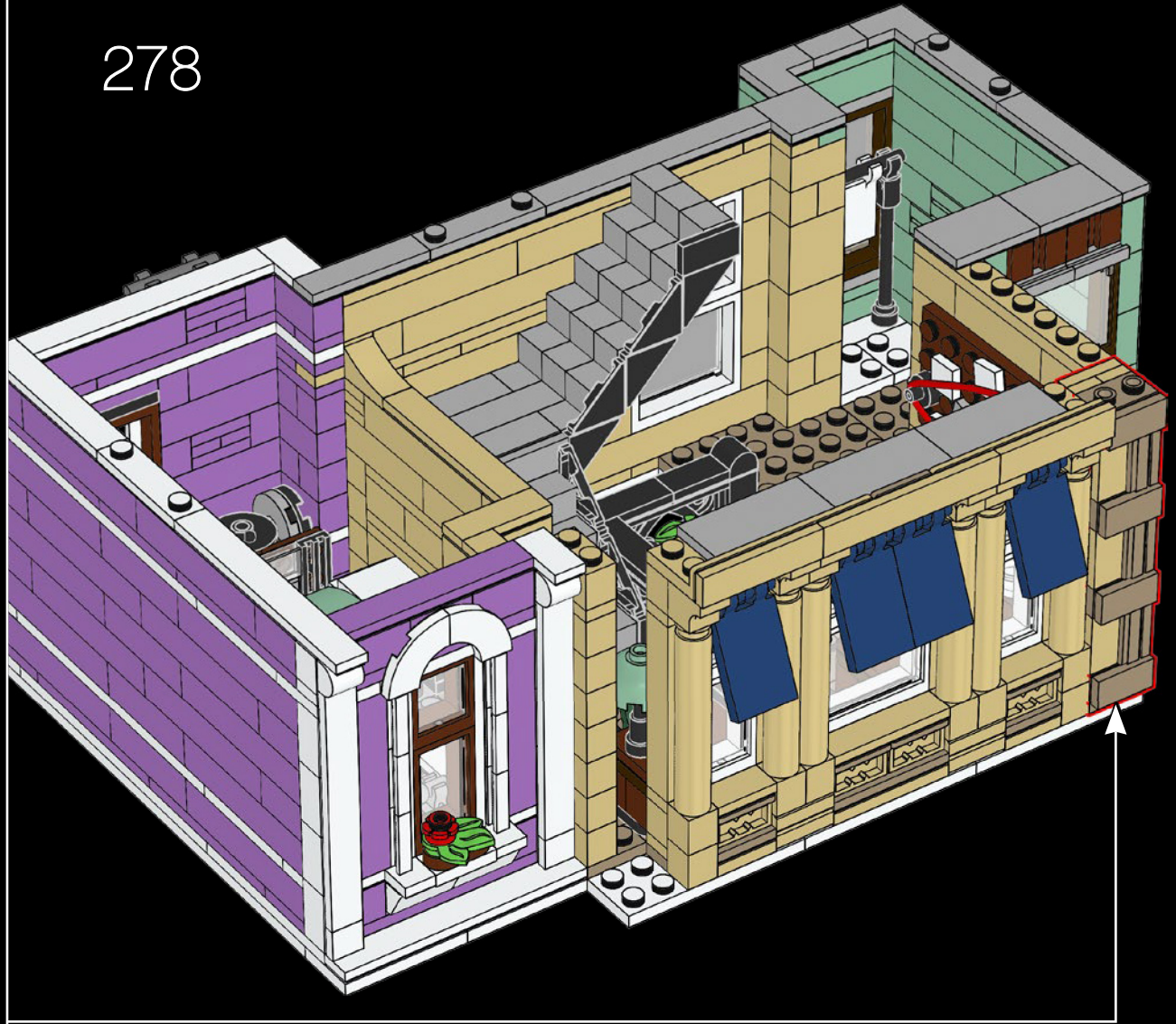

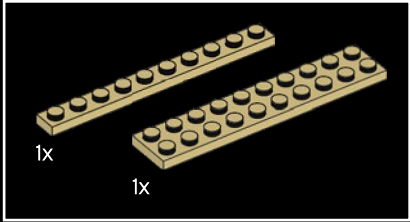
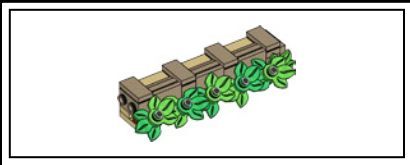

279

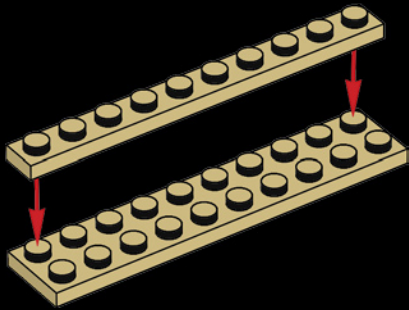

280

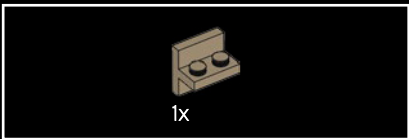
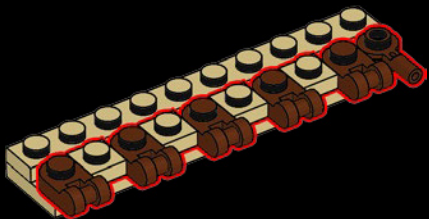

281

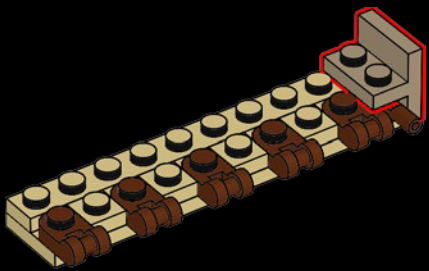



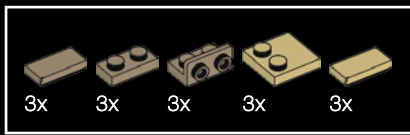

282

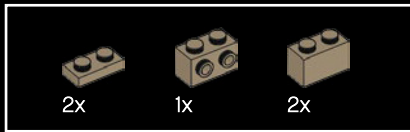
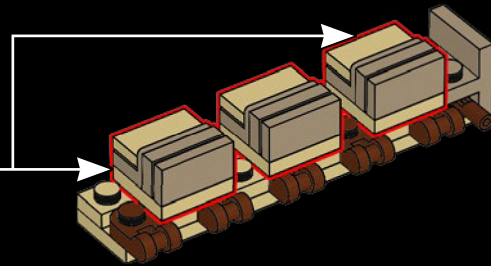
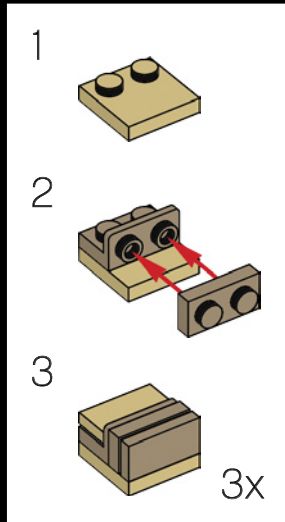

283

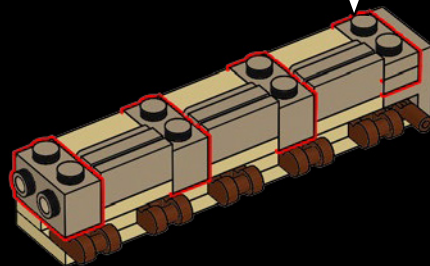
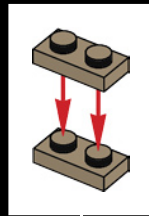

284

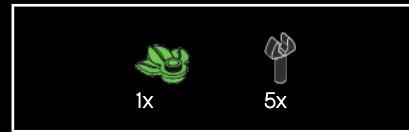
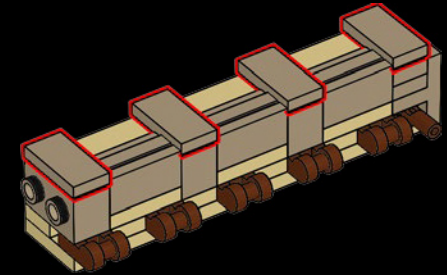

285

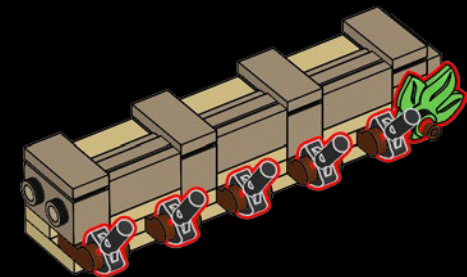

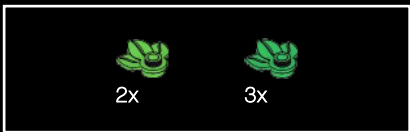

286

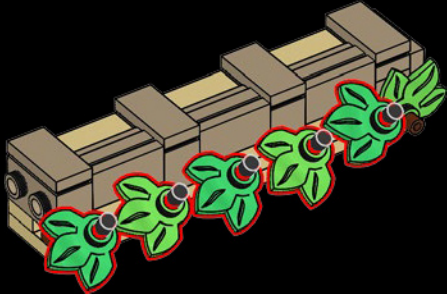

287



288





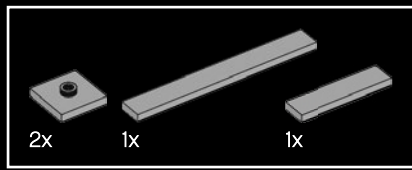

289





290

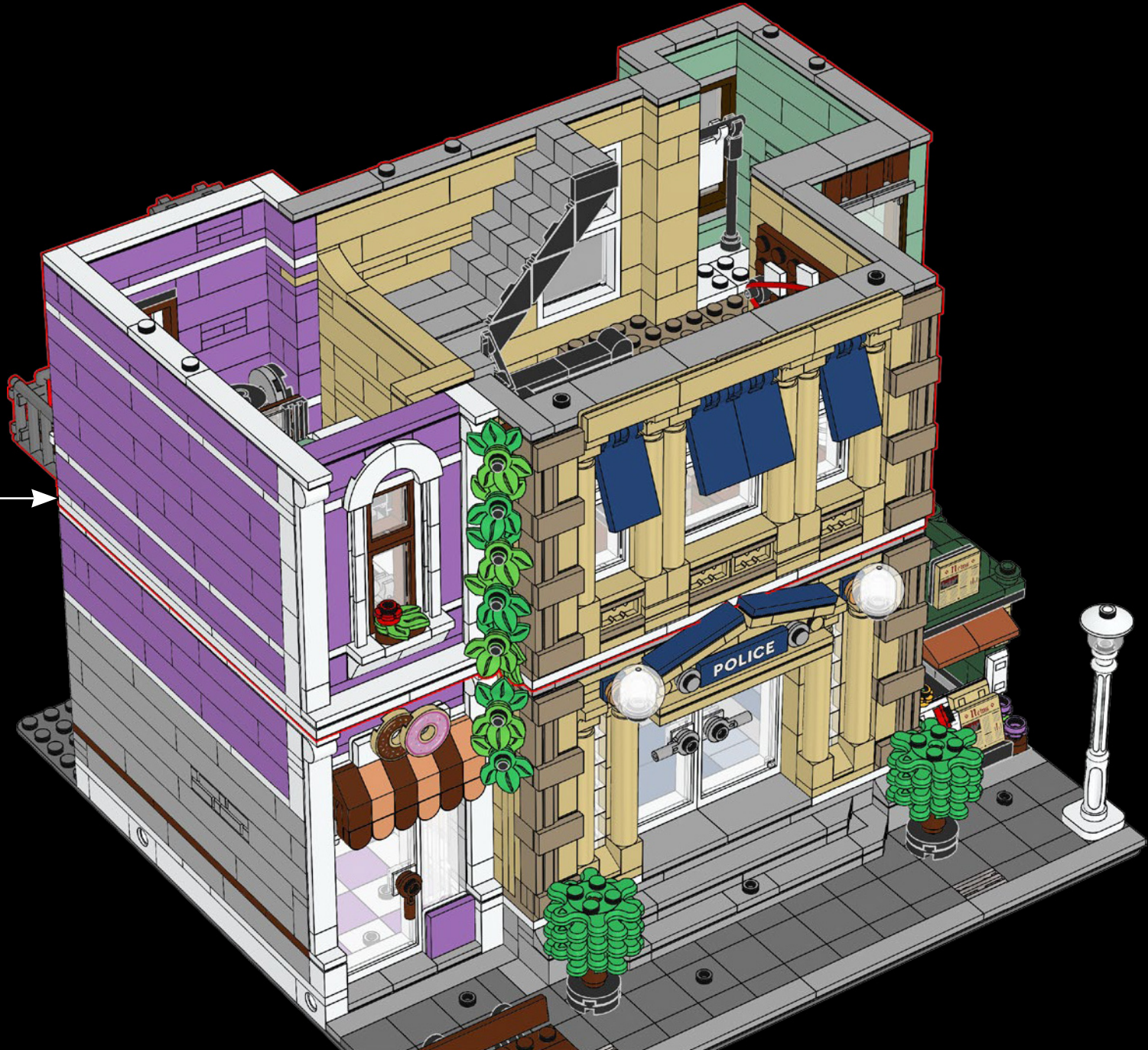



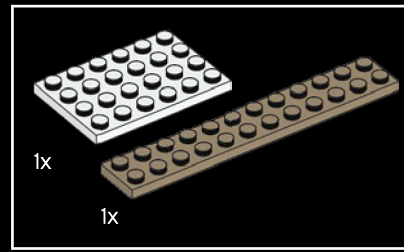
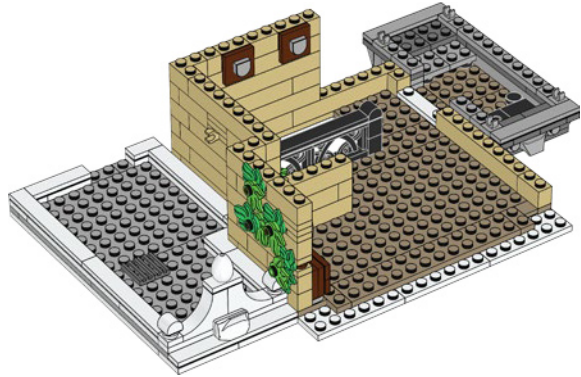
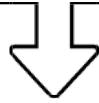
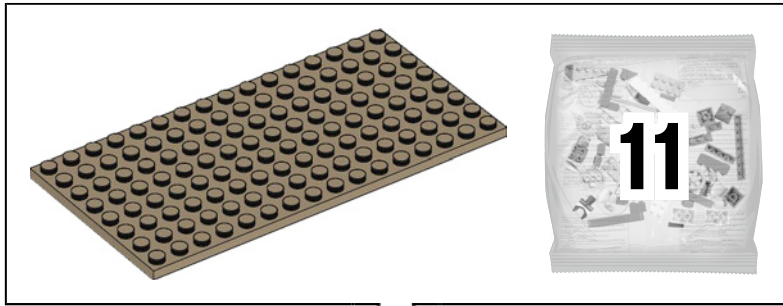

291

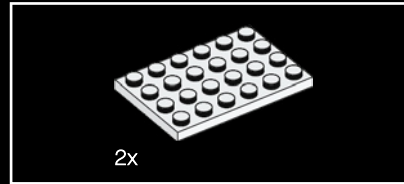
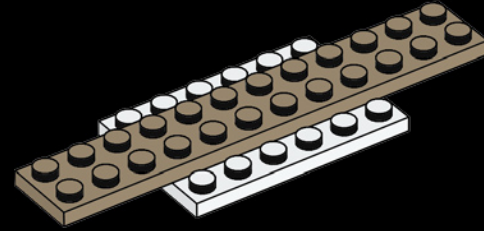

292

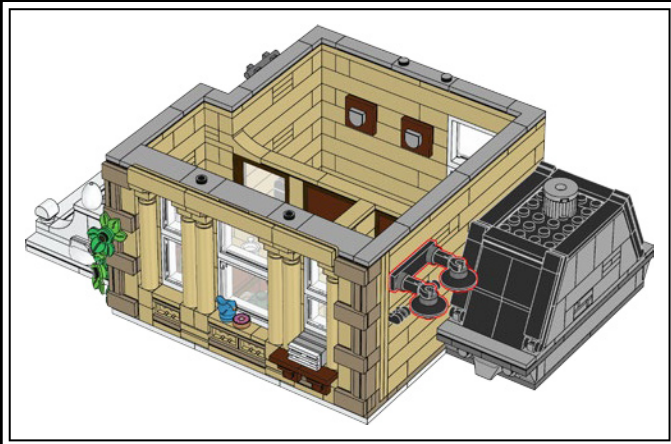
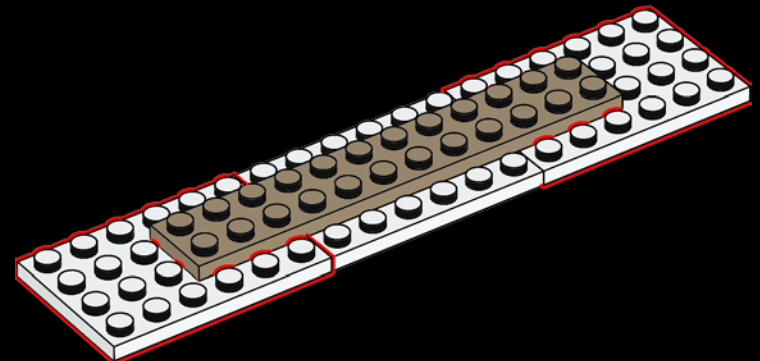





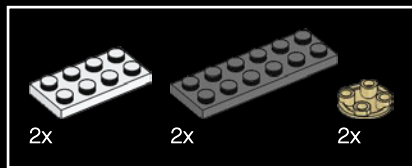

295

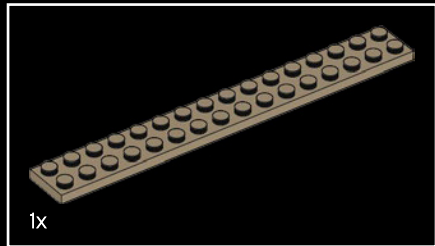
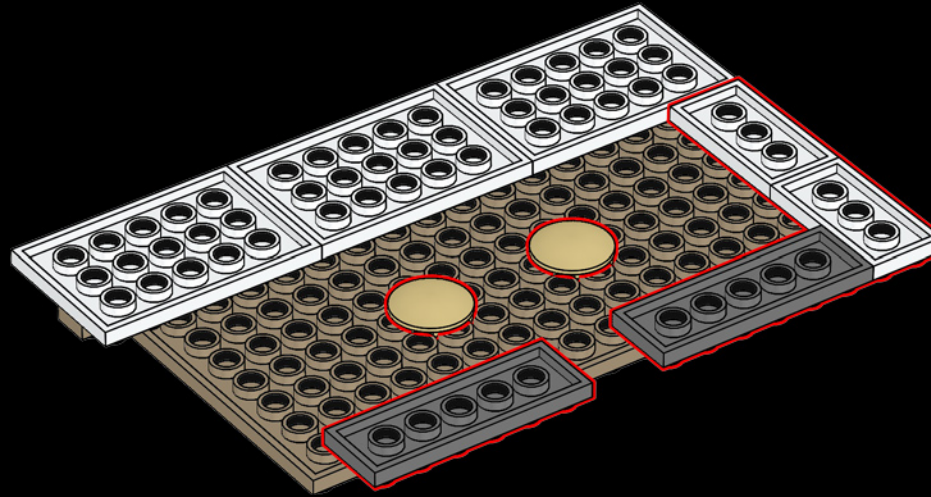

296

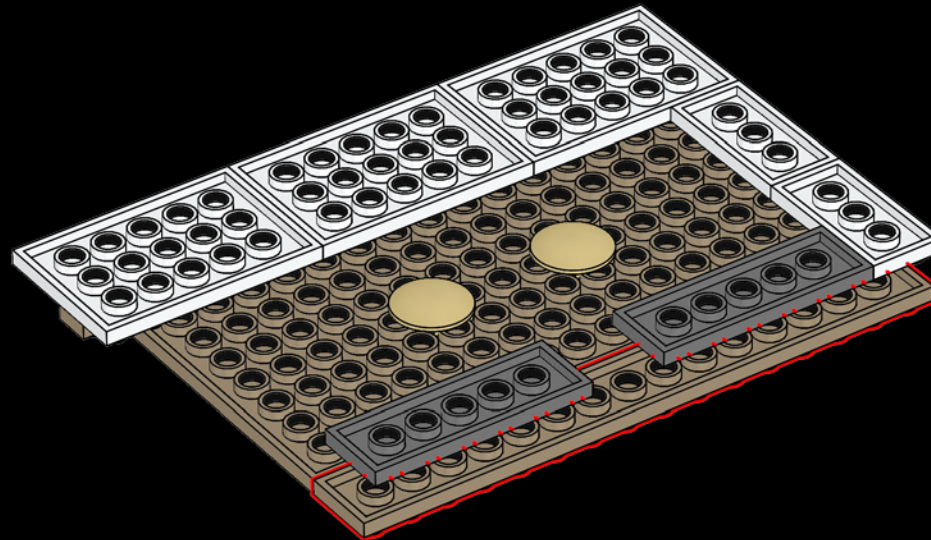

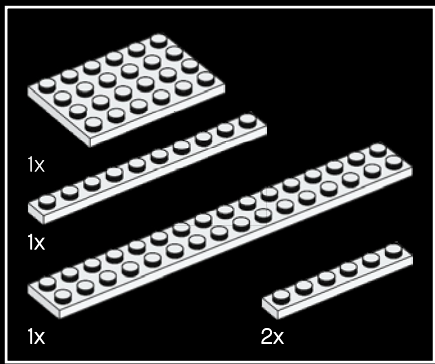

297

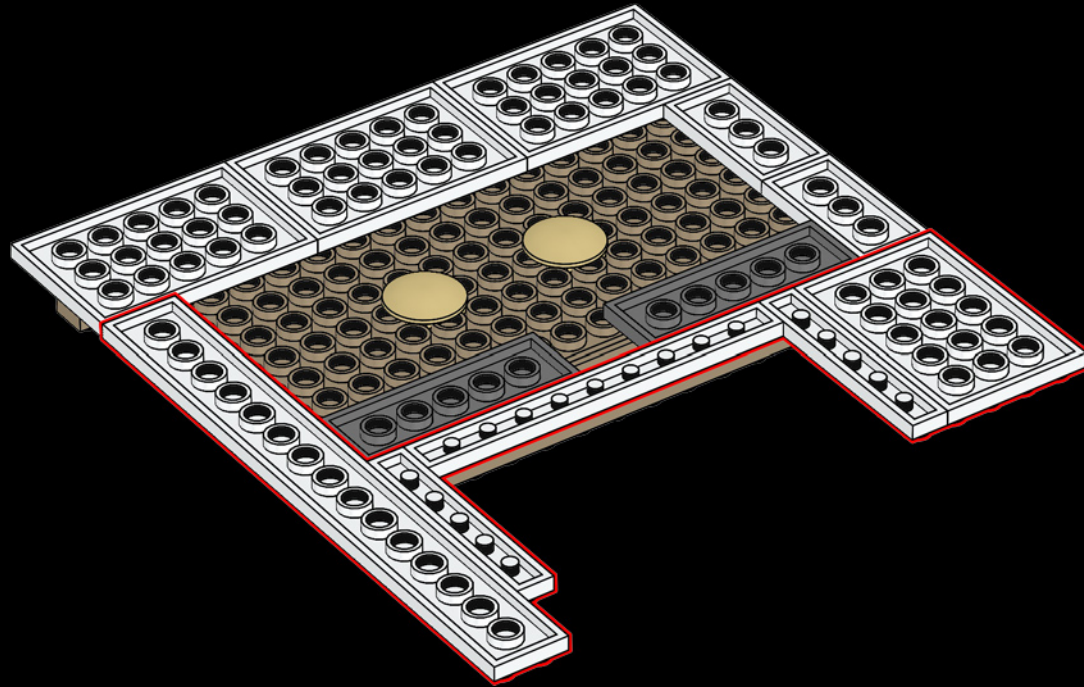



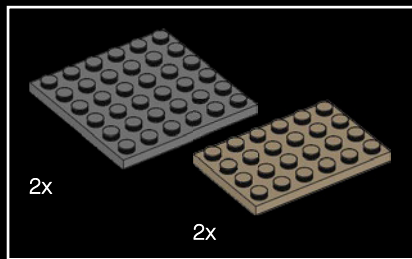

298

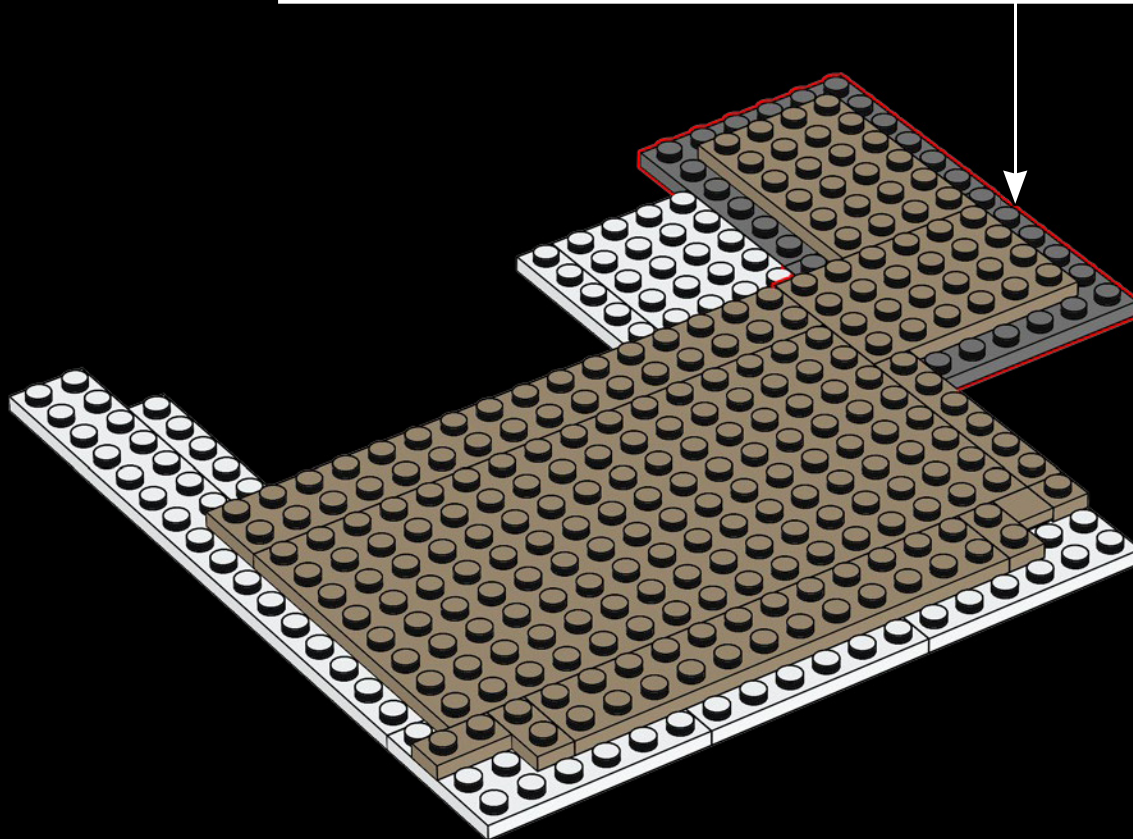
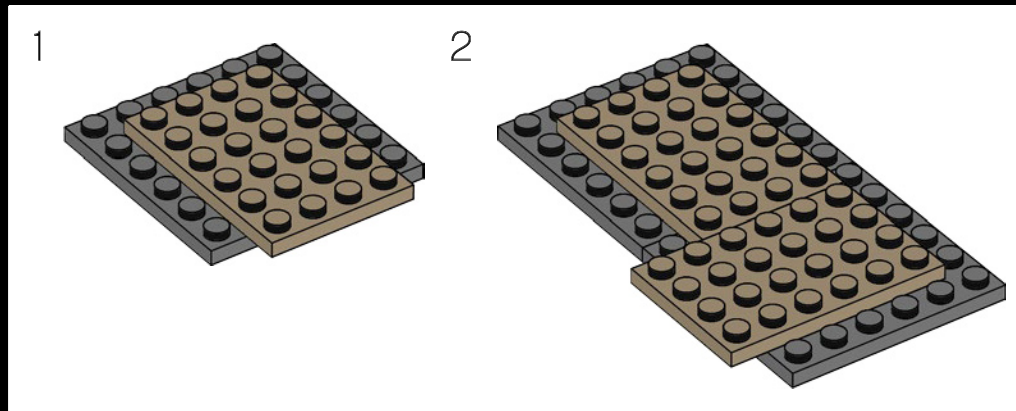

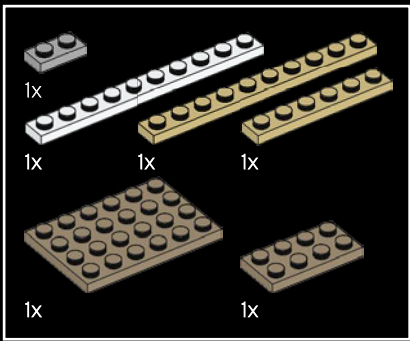

299

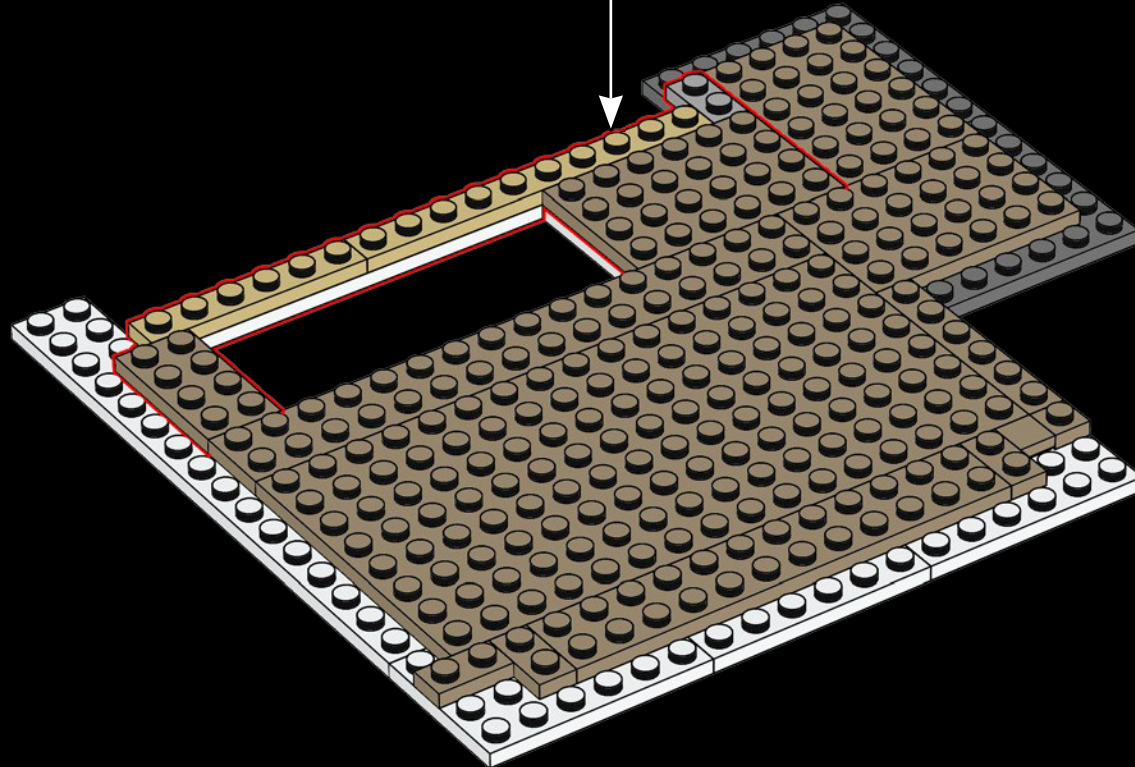
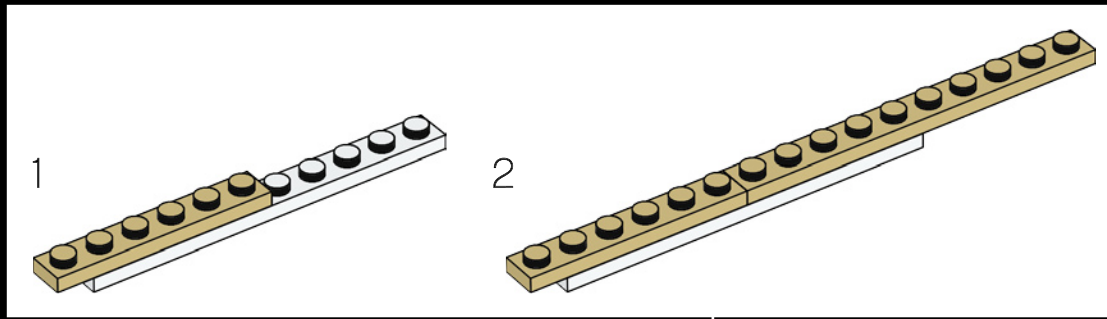



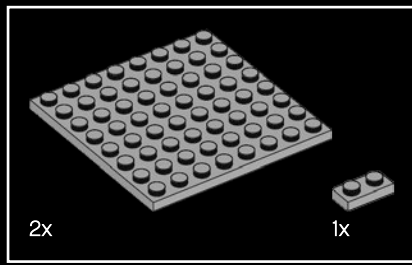

300

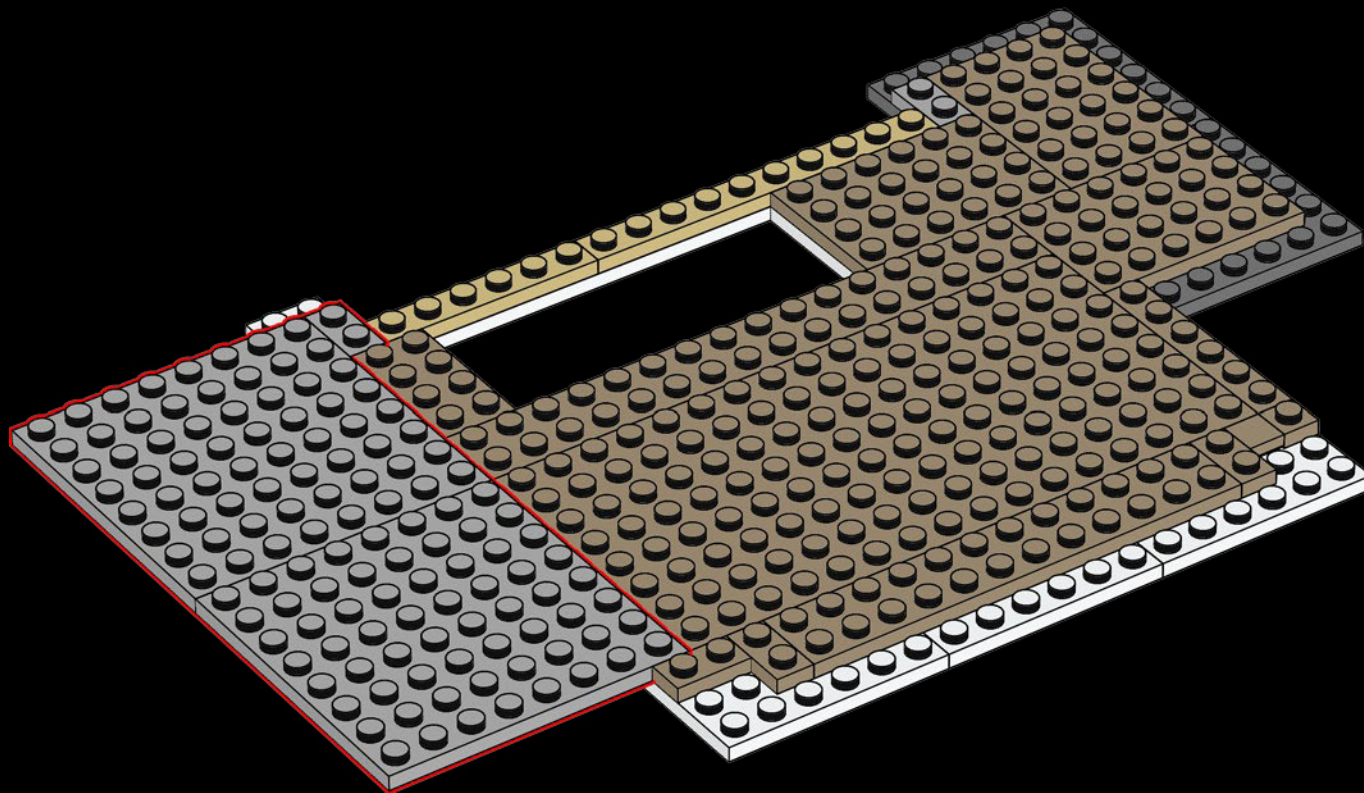

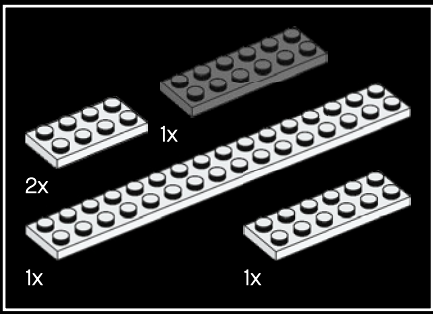

301

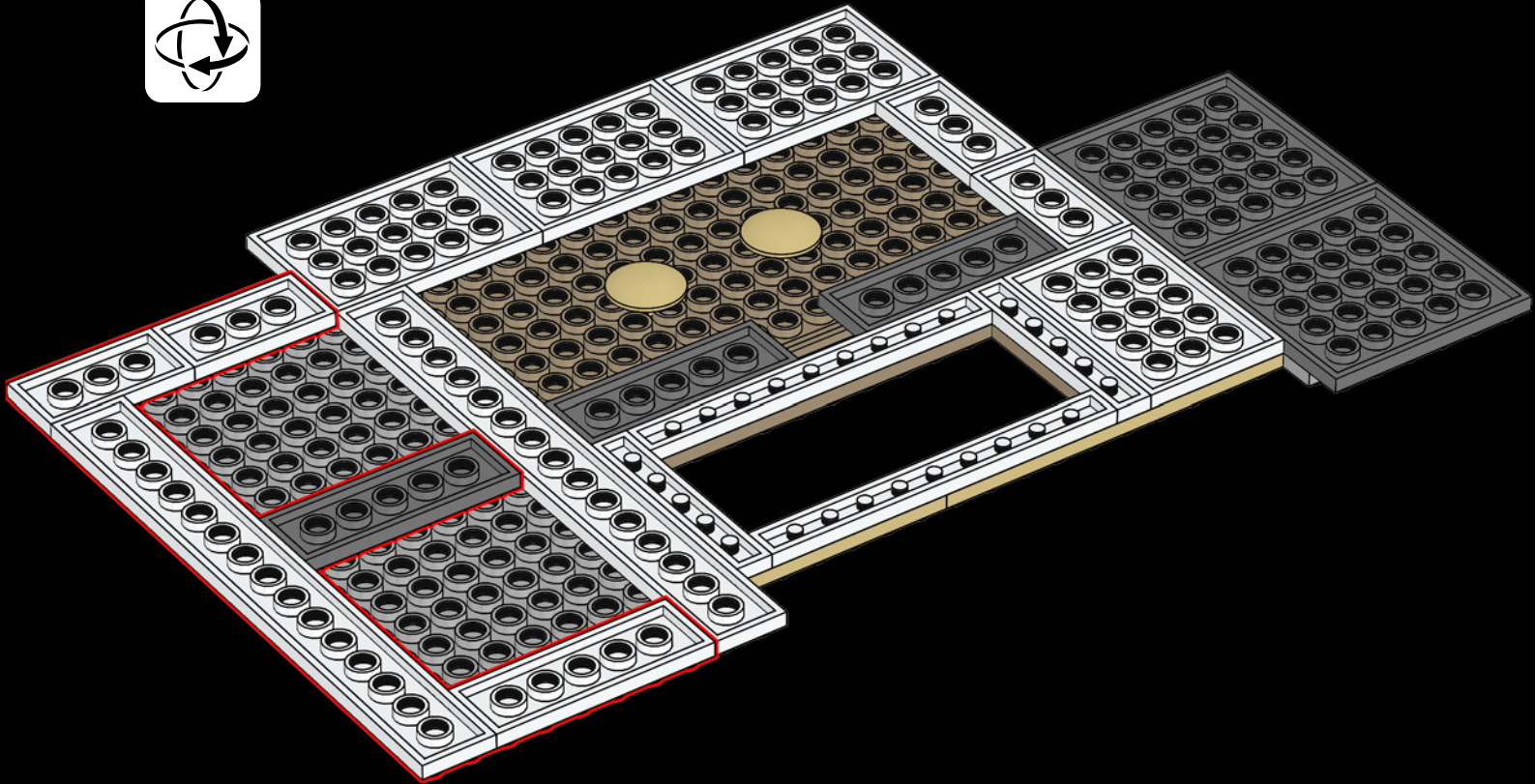



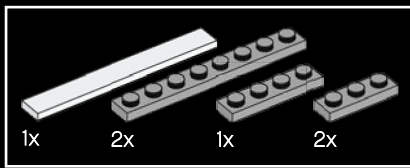

302

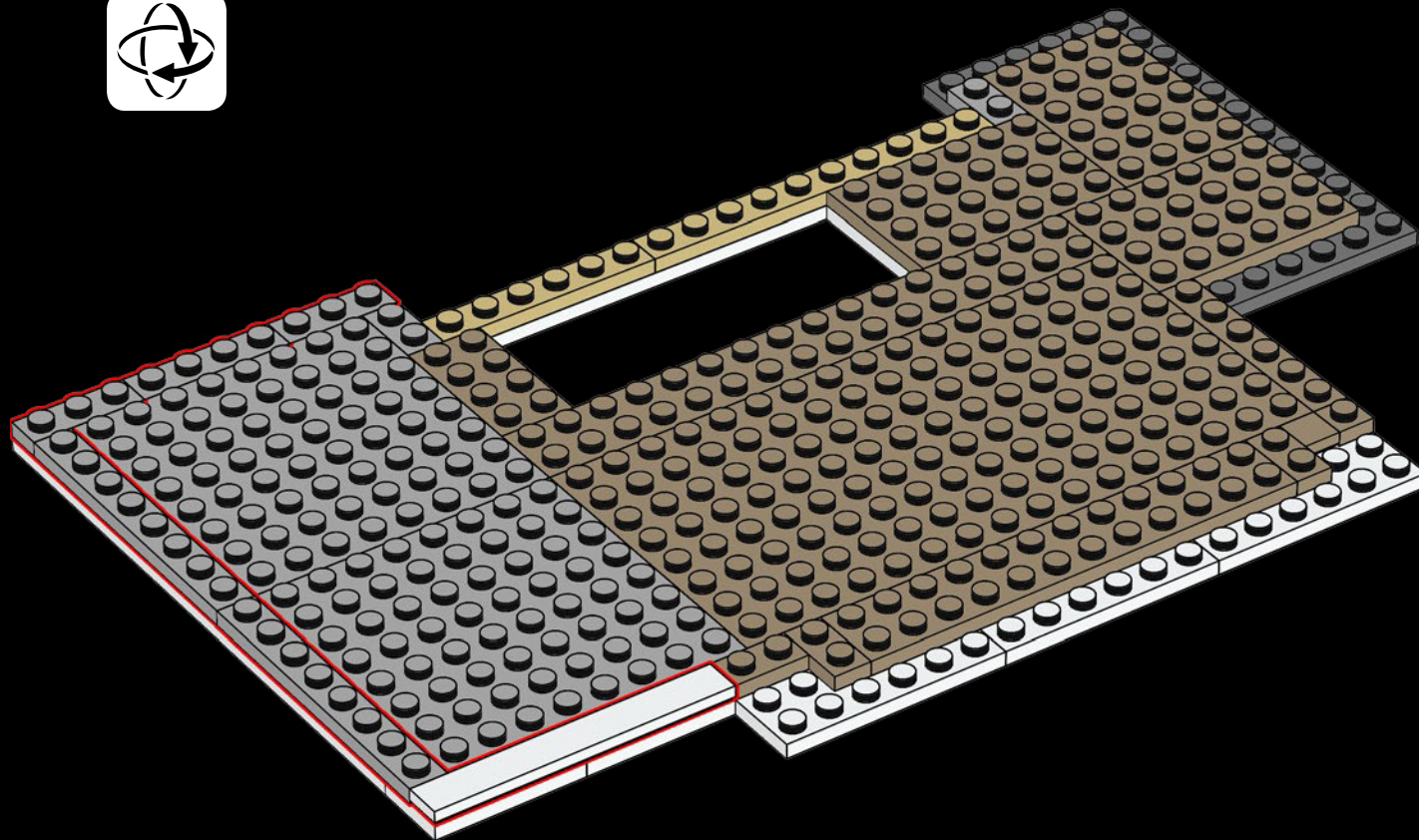

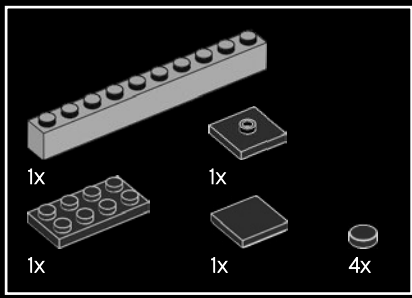

303

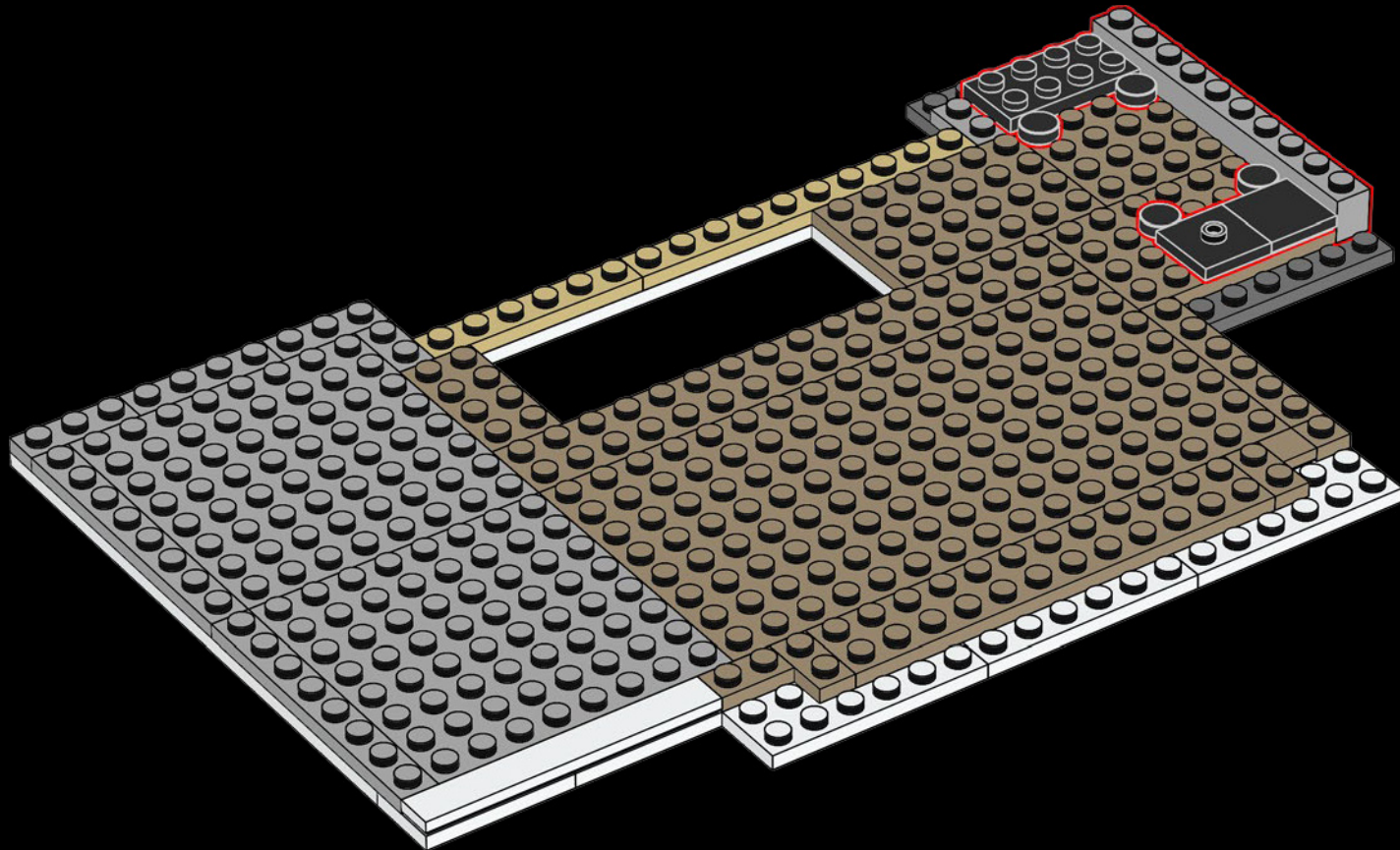





304

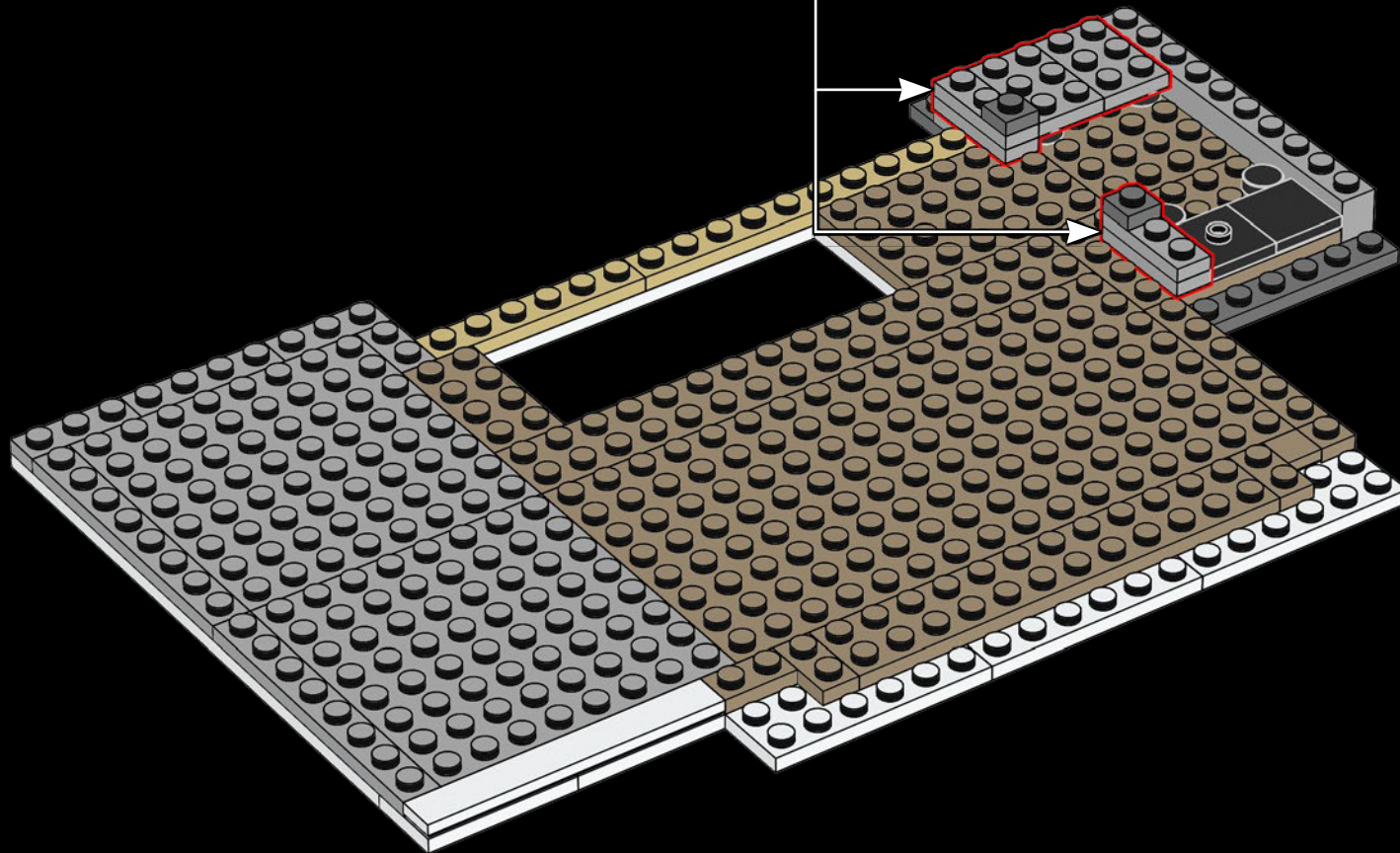
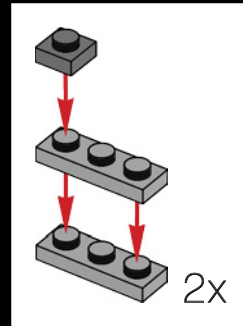

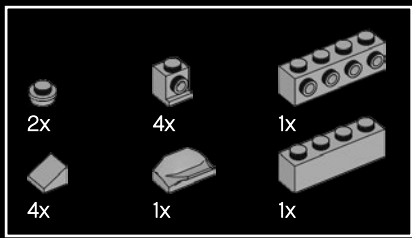

305

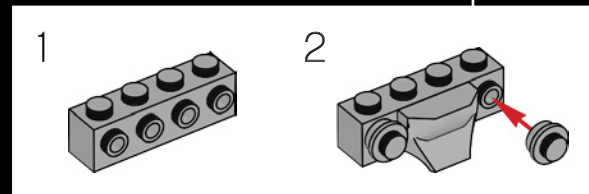
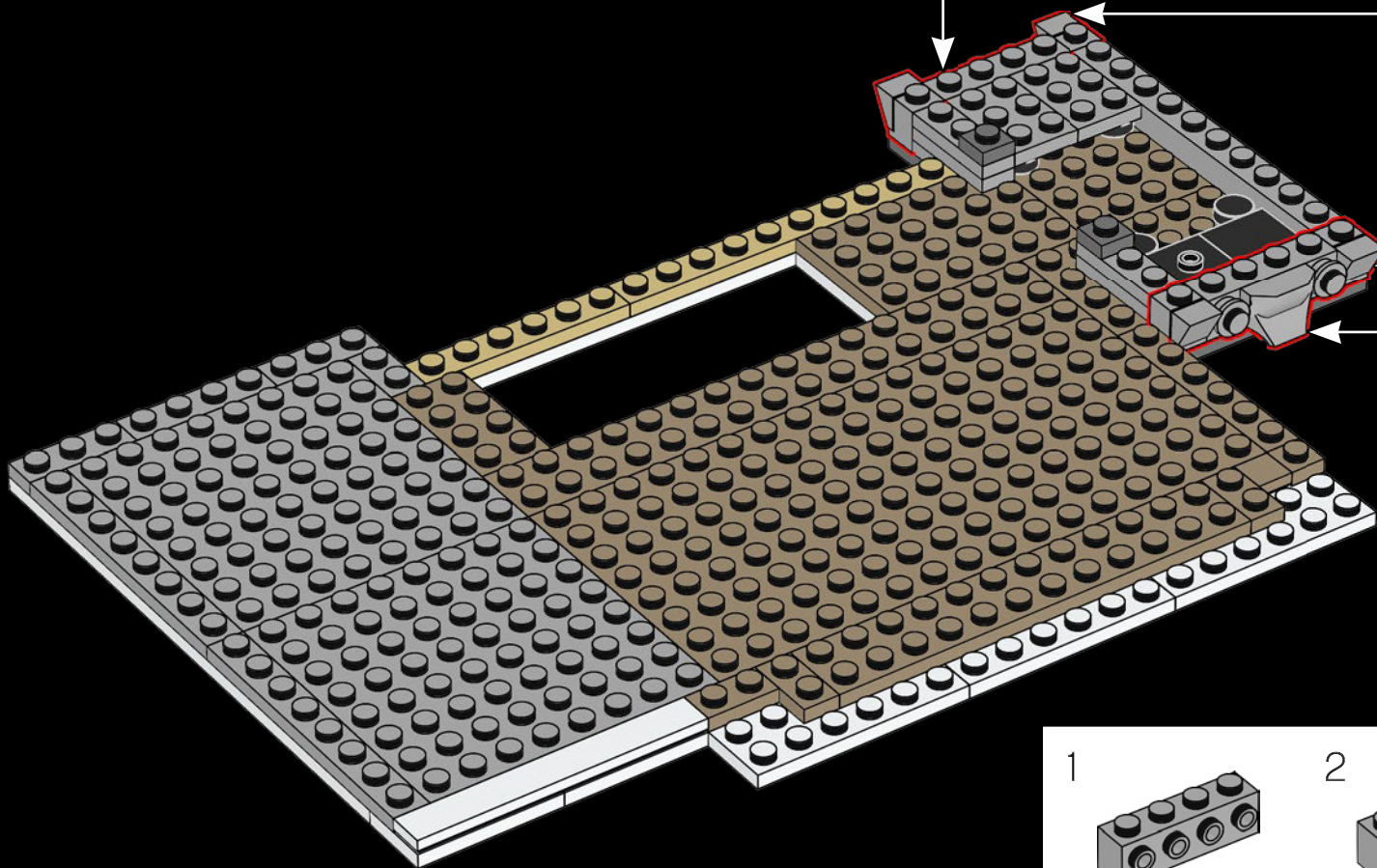
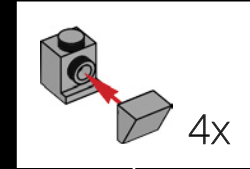
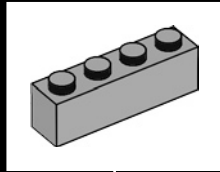



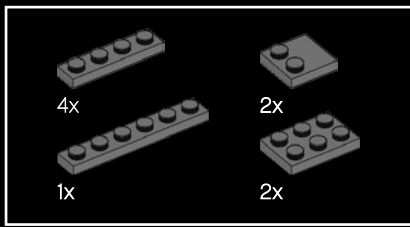

306

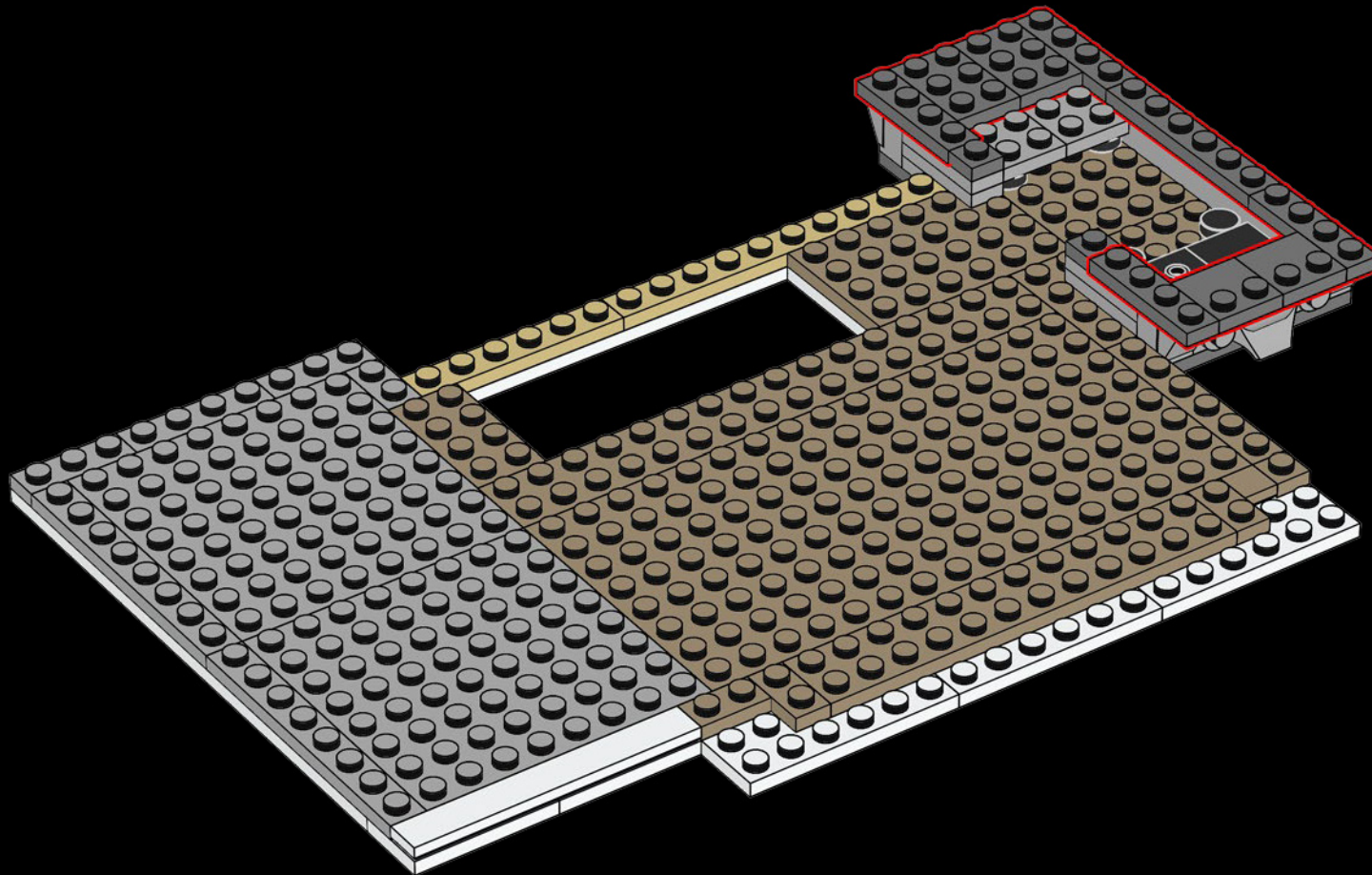

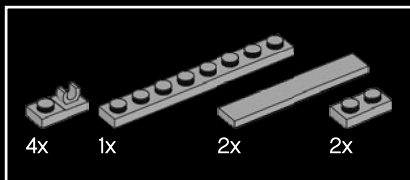

307

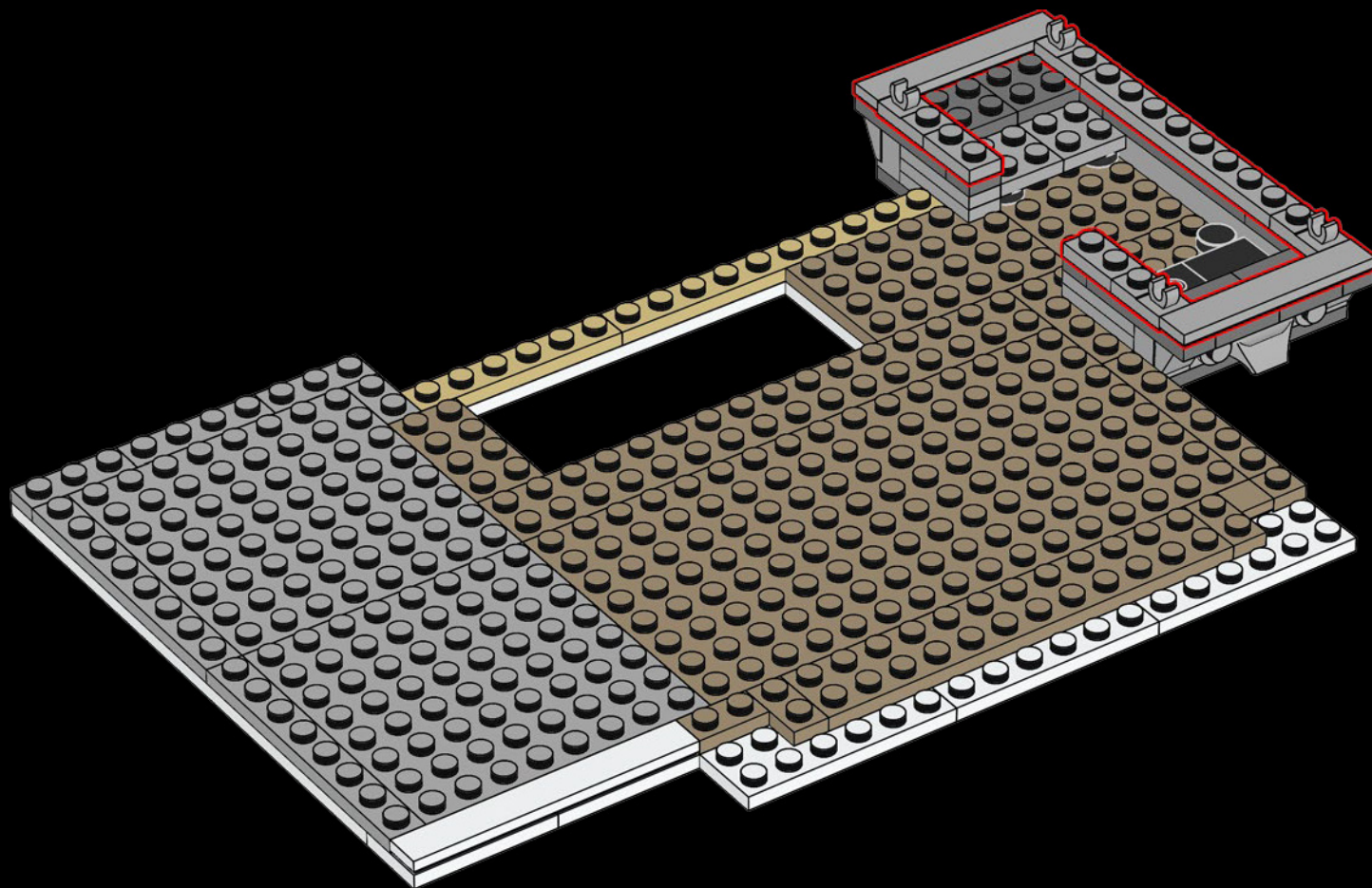



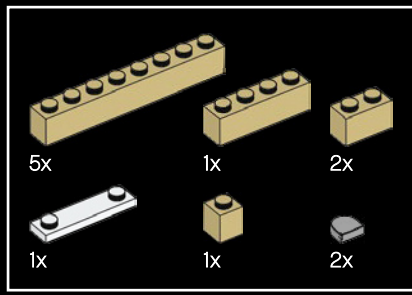

308

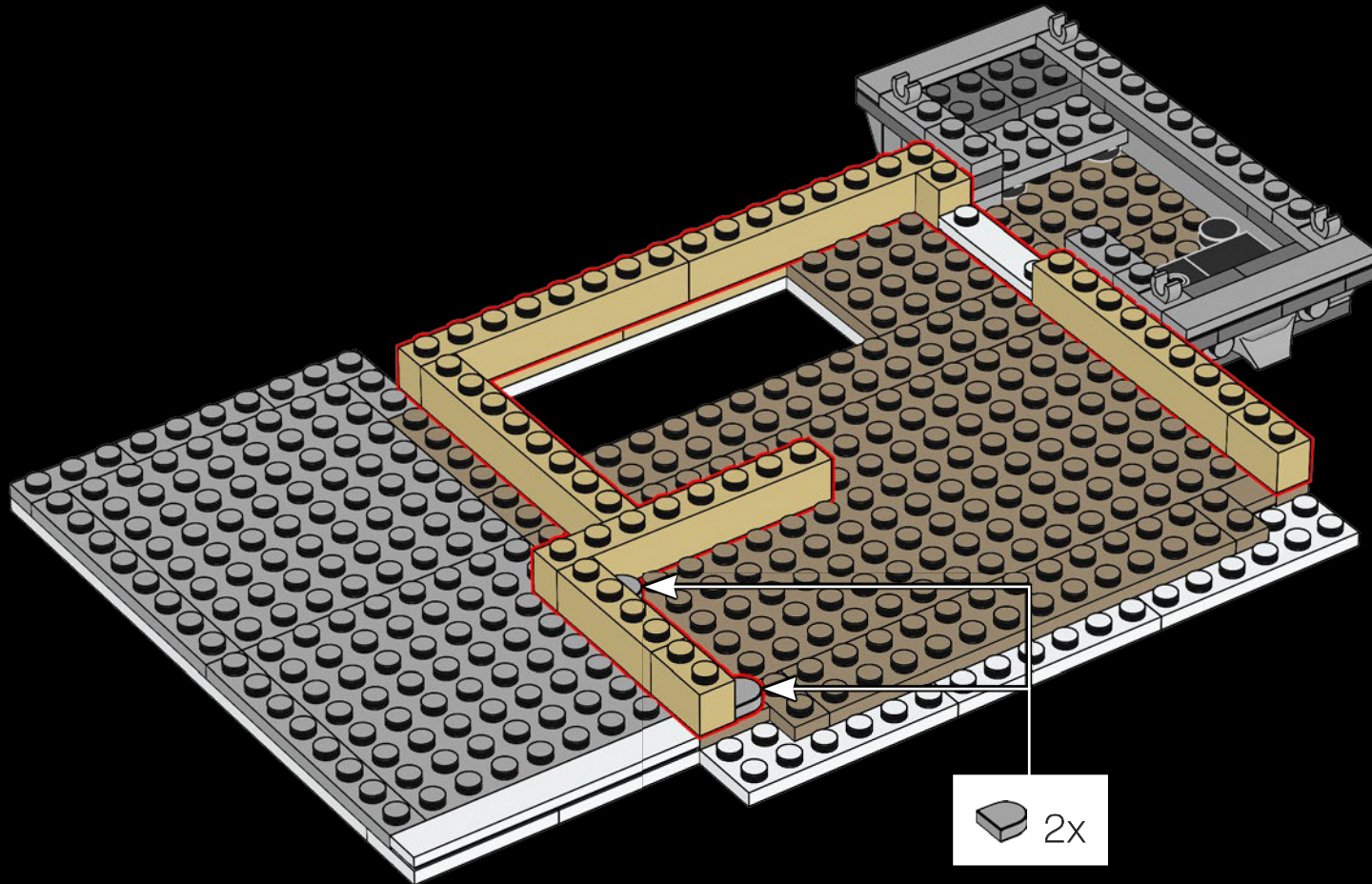

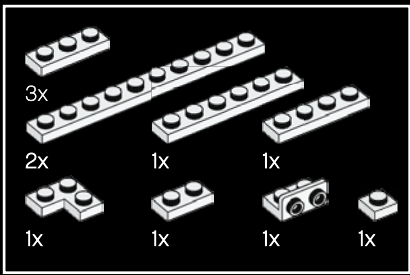

309

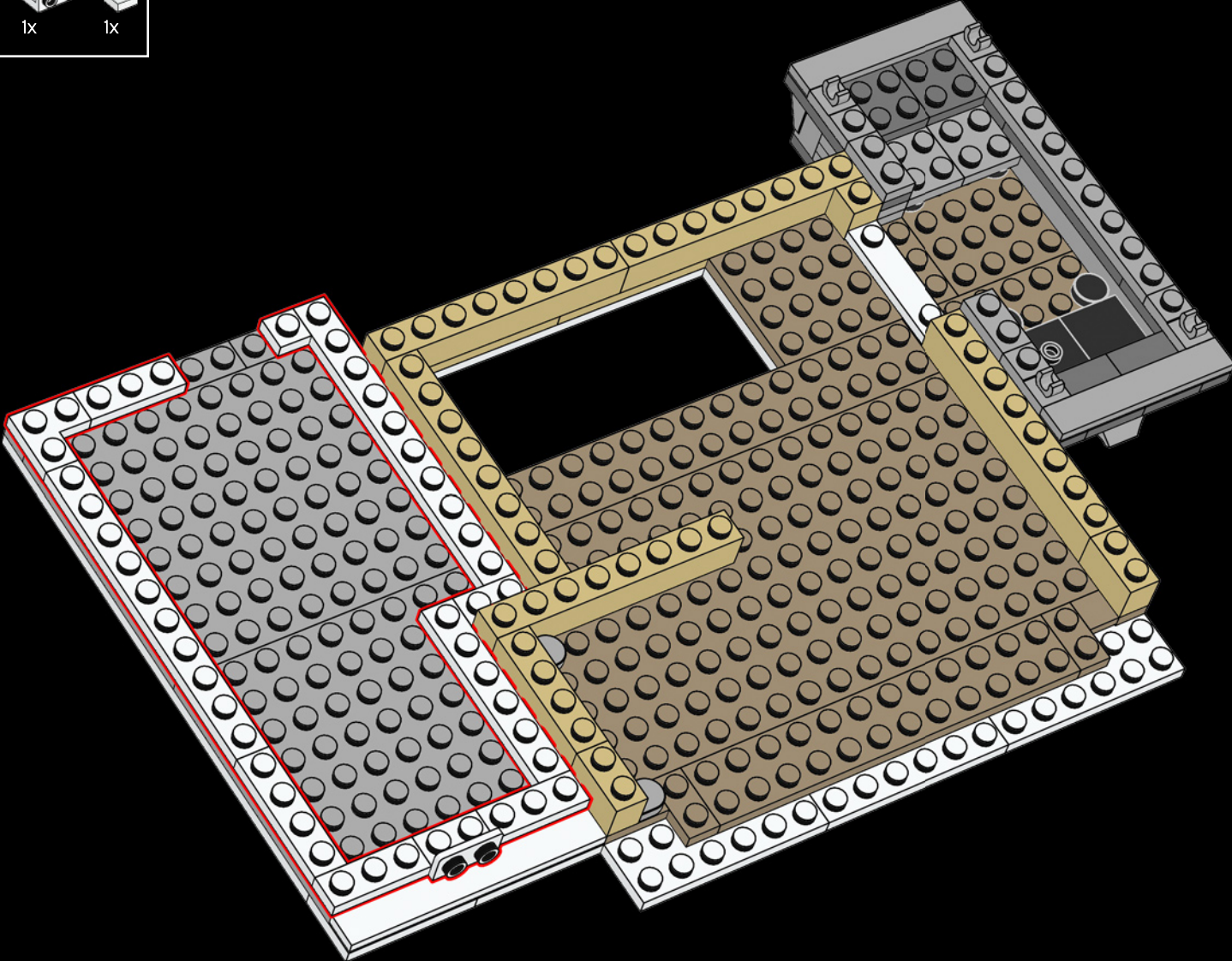



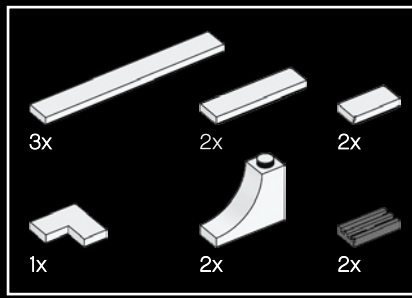

310

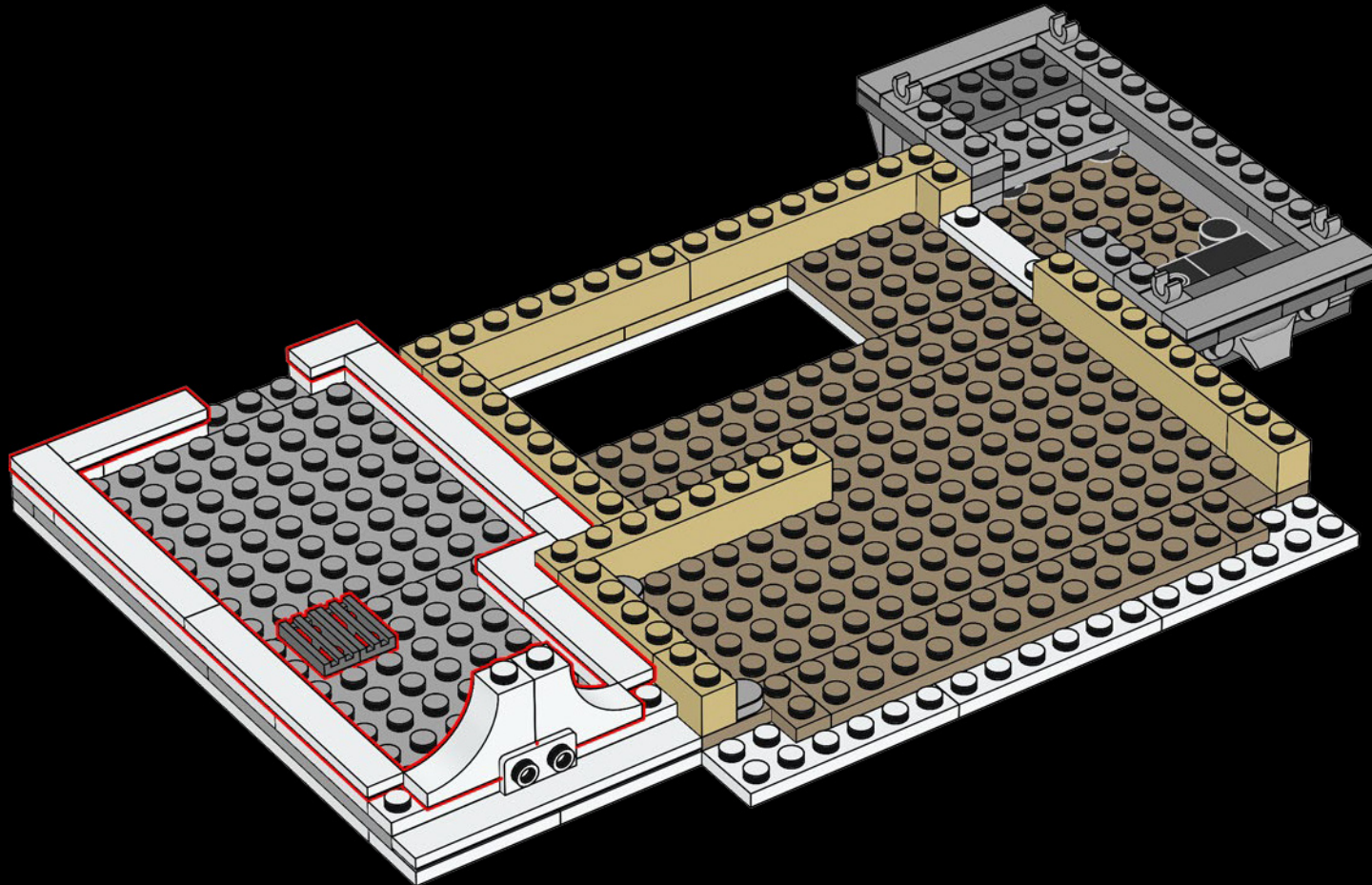



311

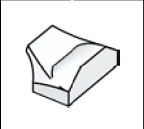
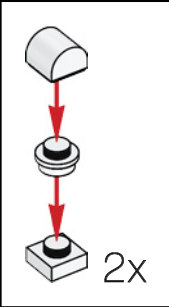
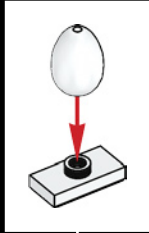
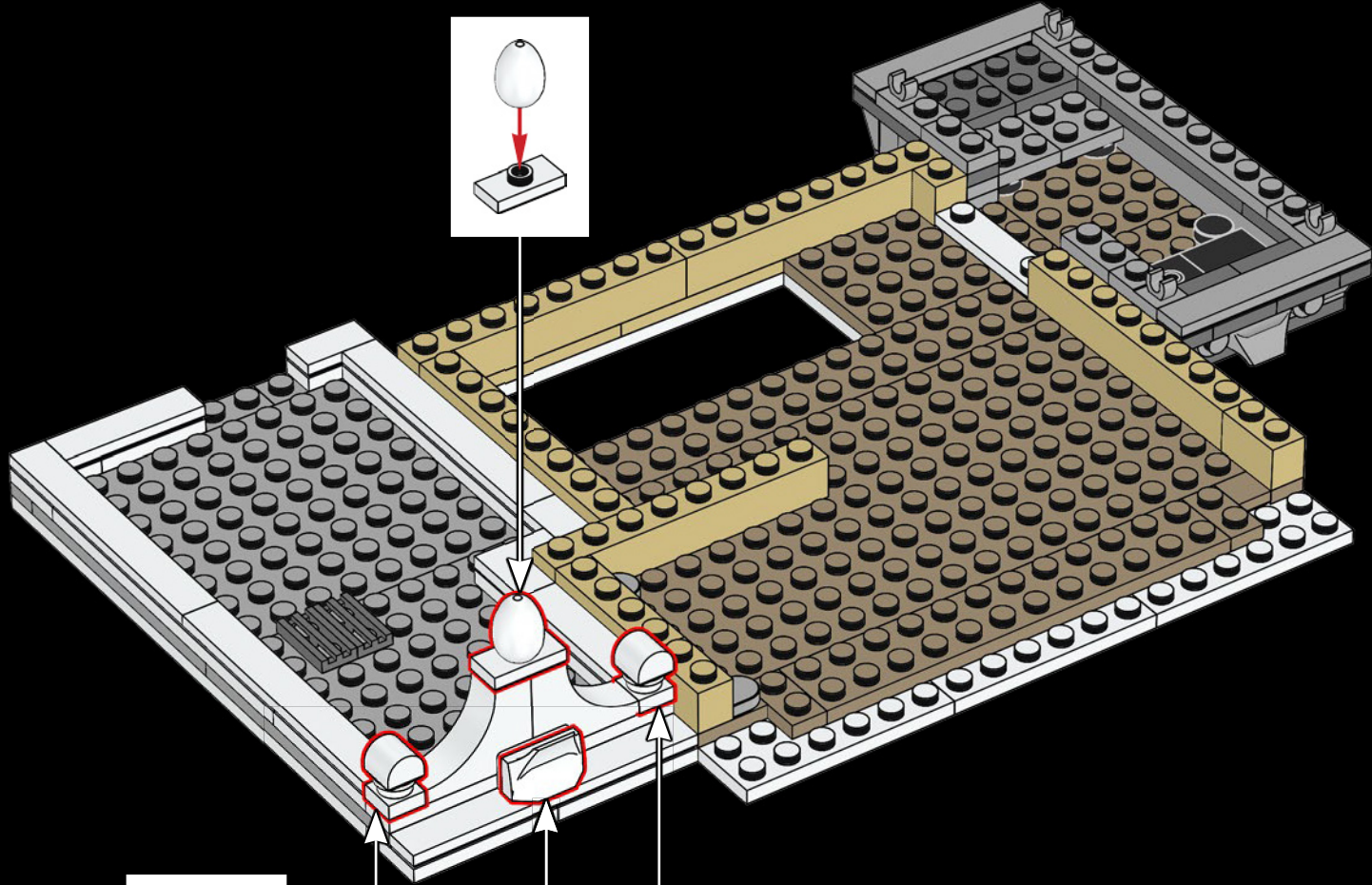



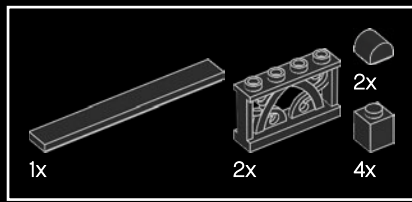

312

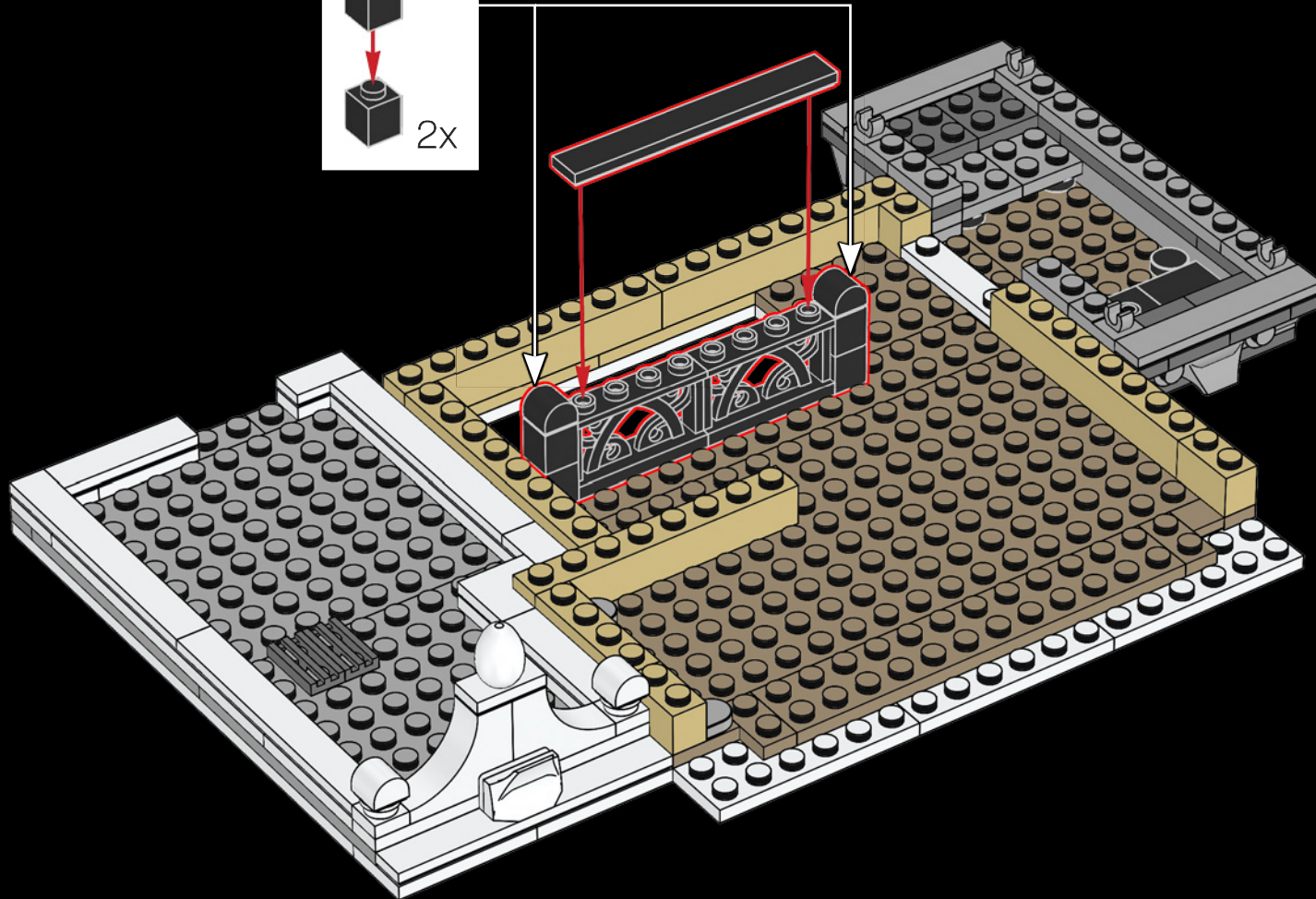
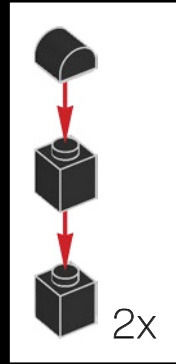



313

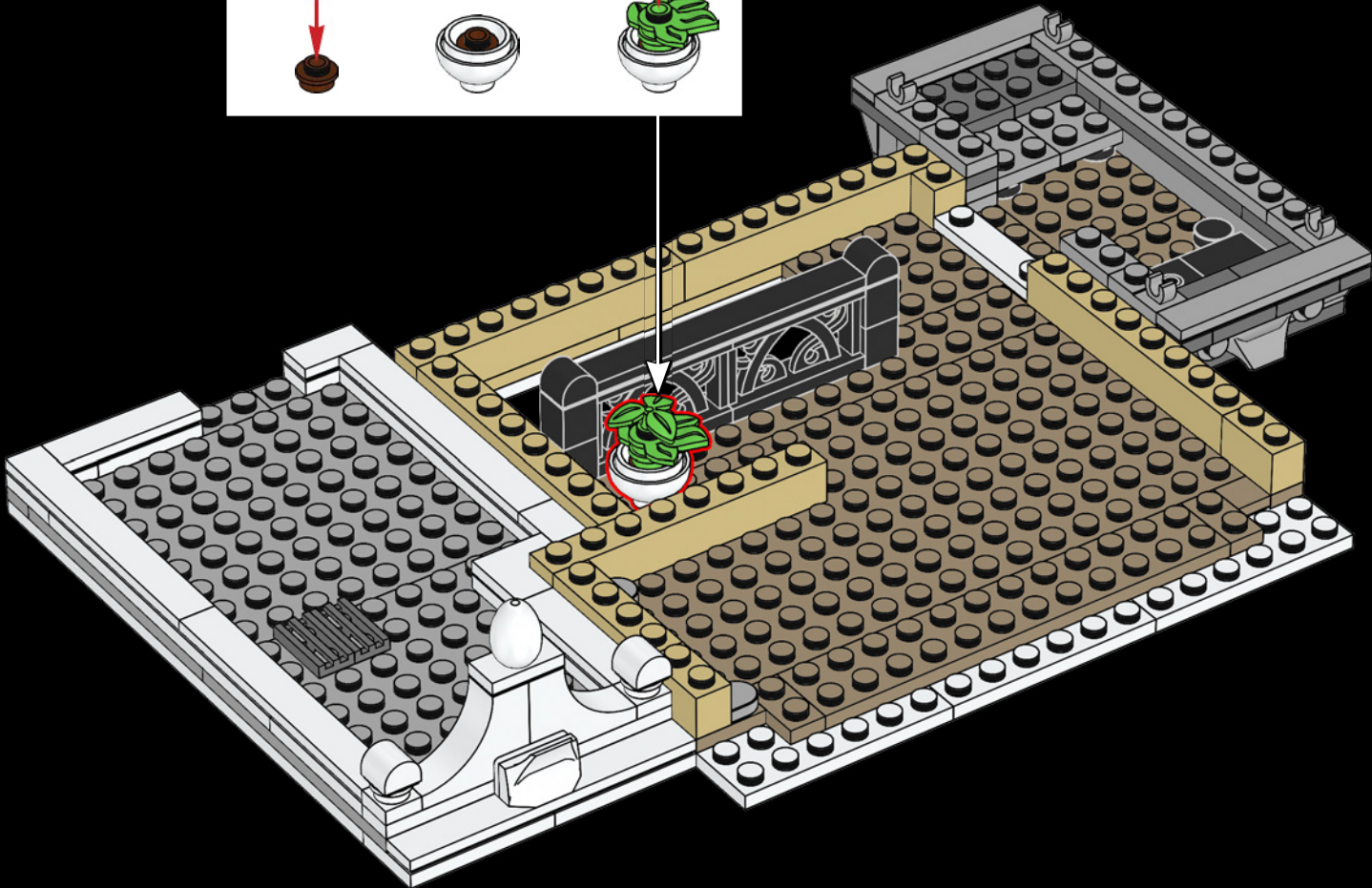
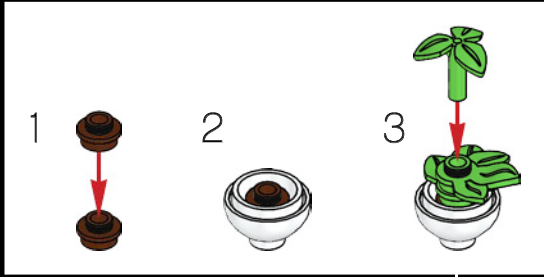



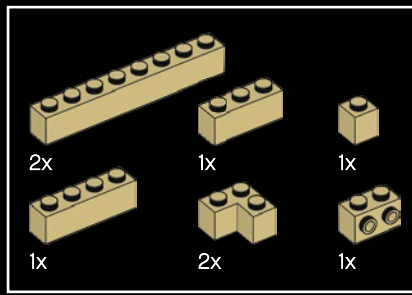

314

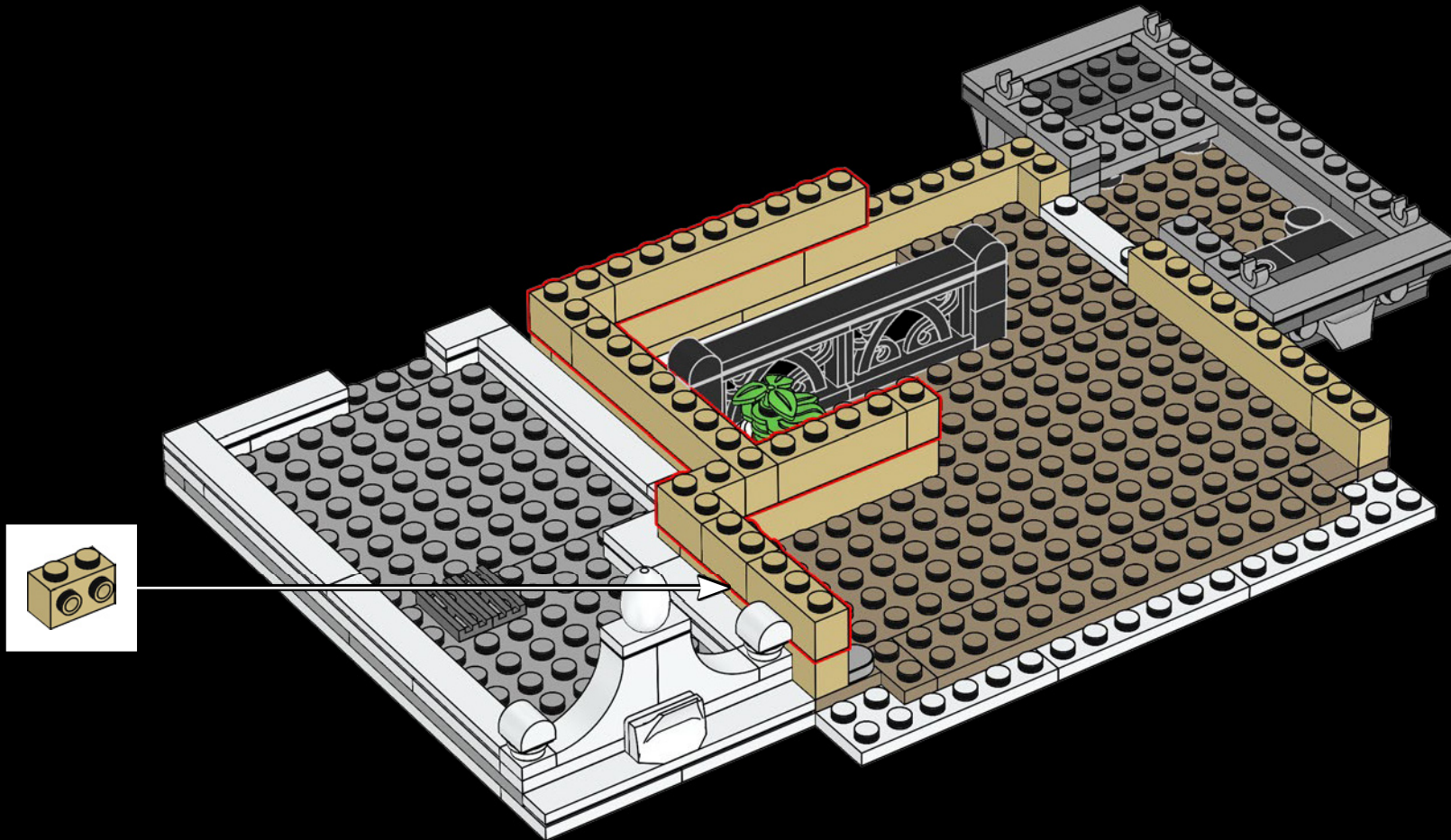

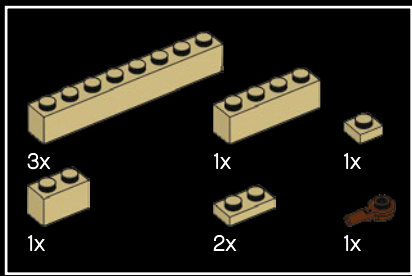

315

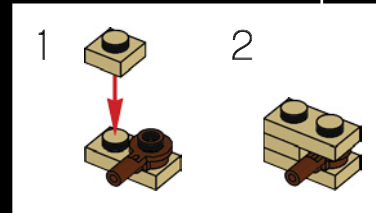
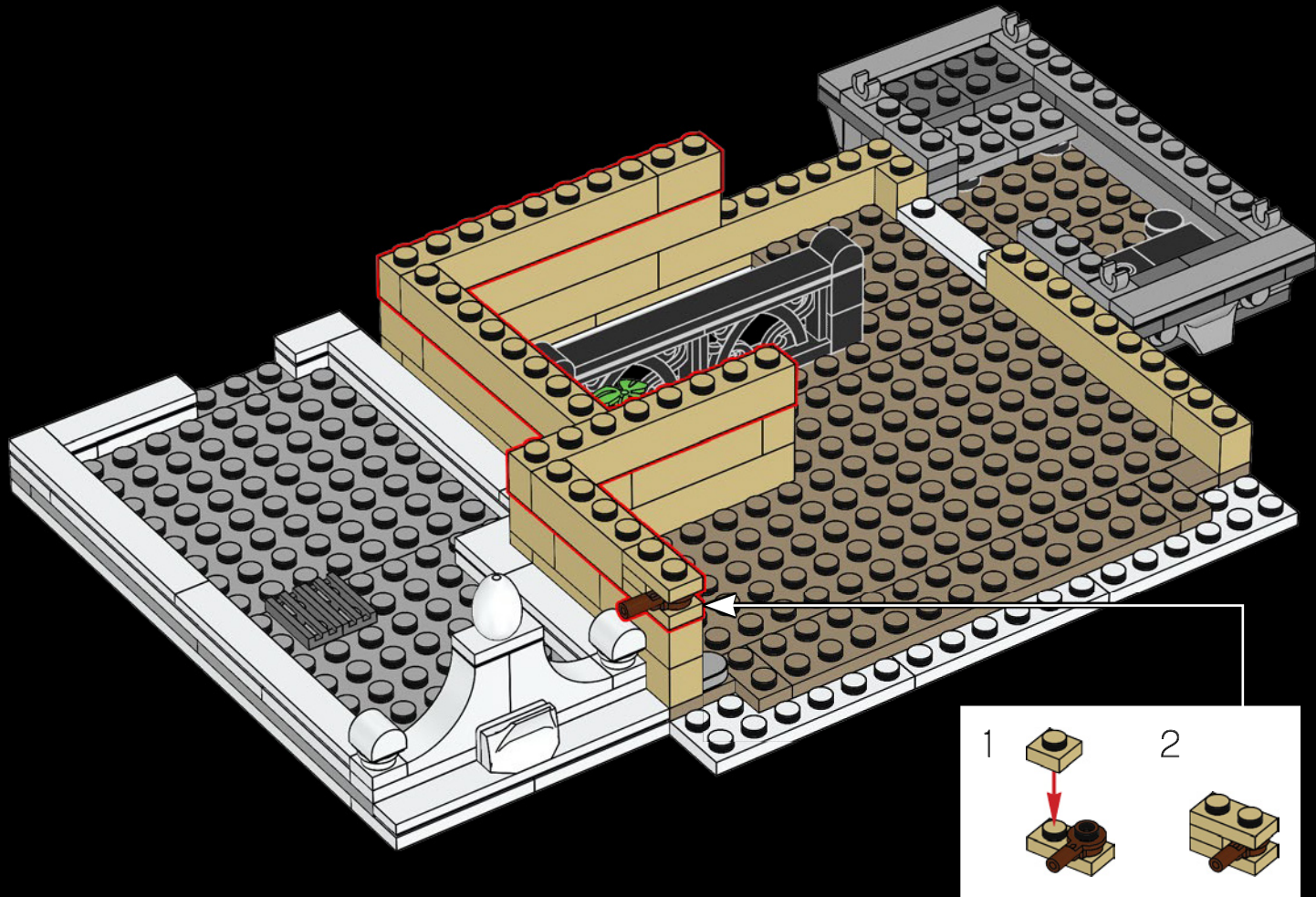



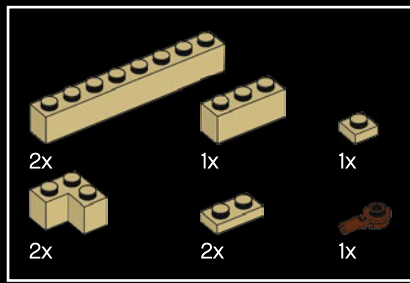

316

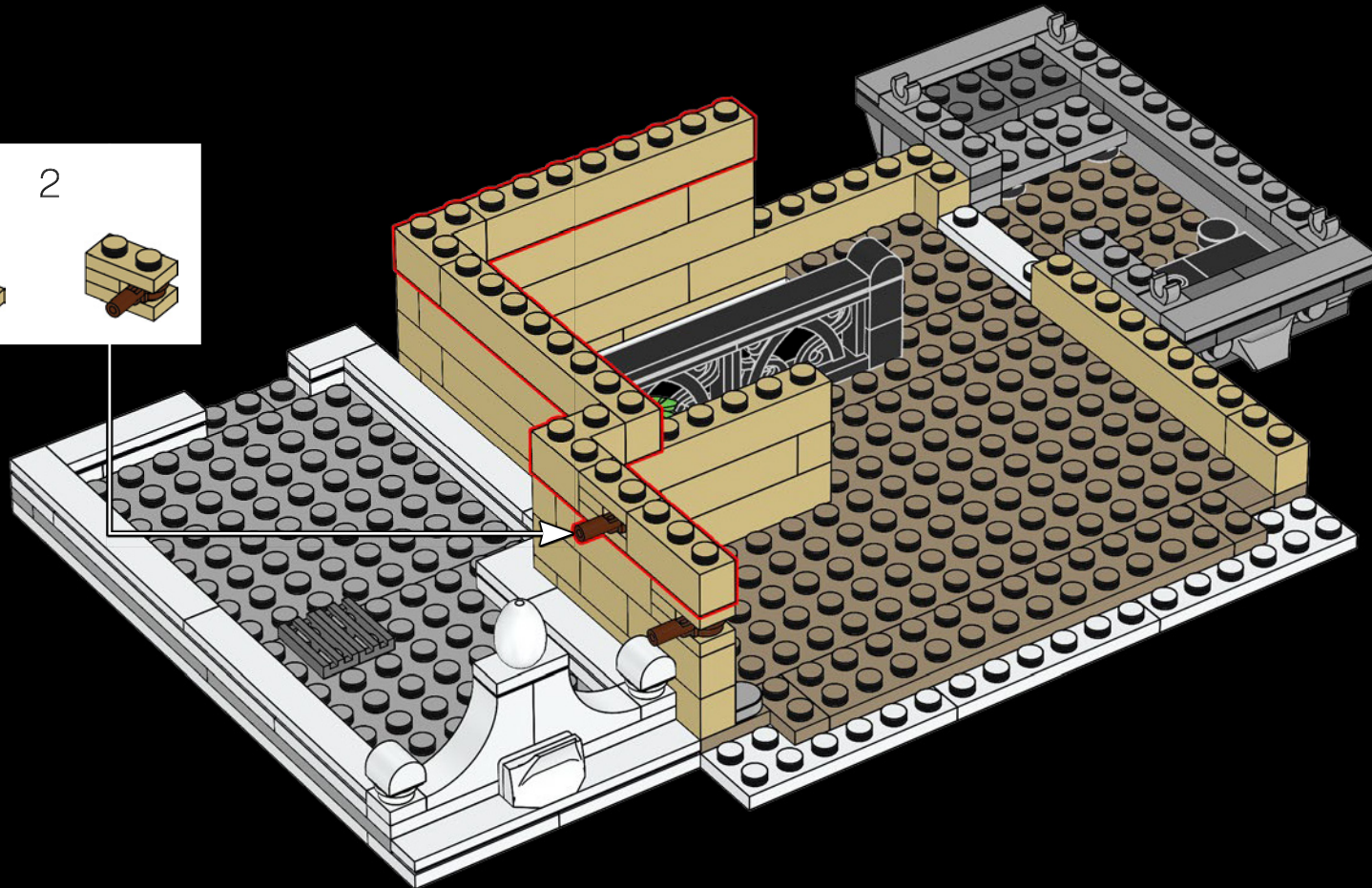
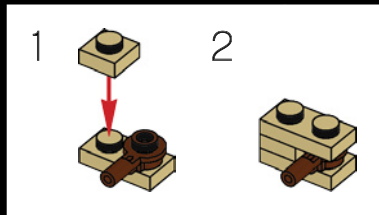

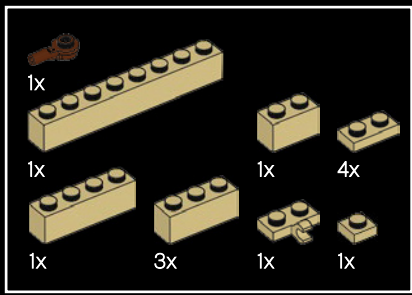

317

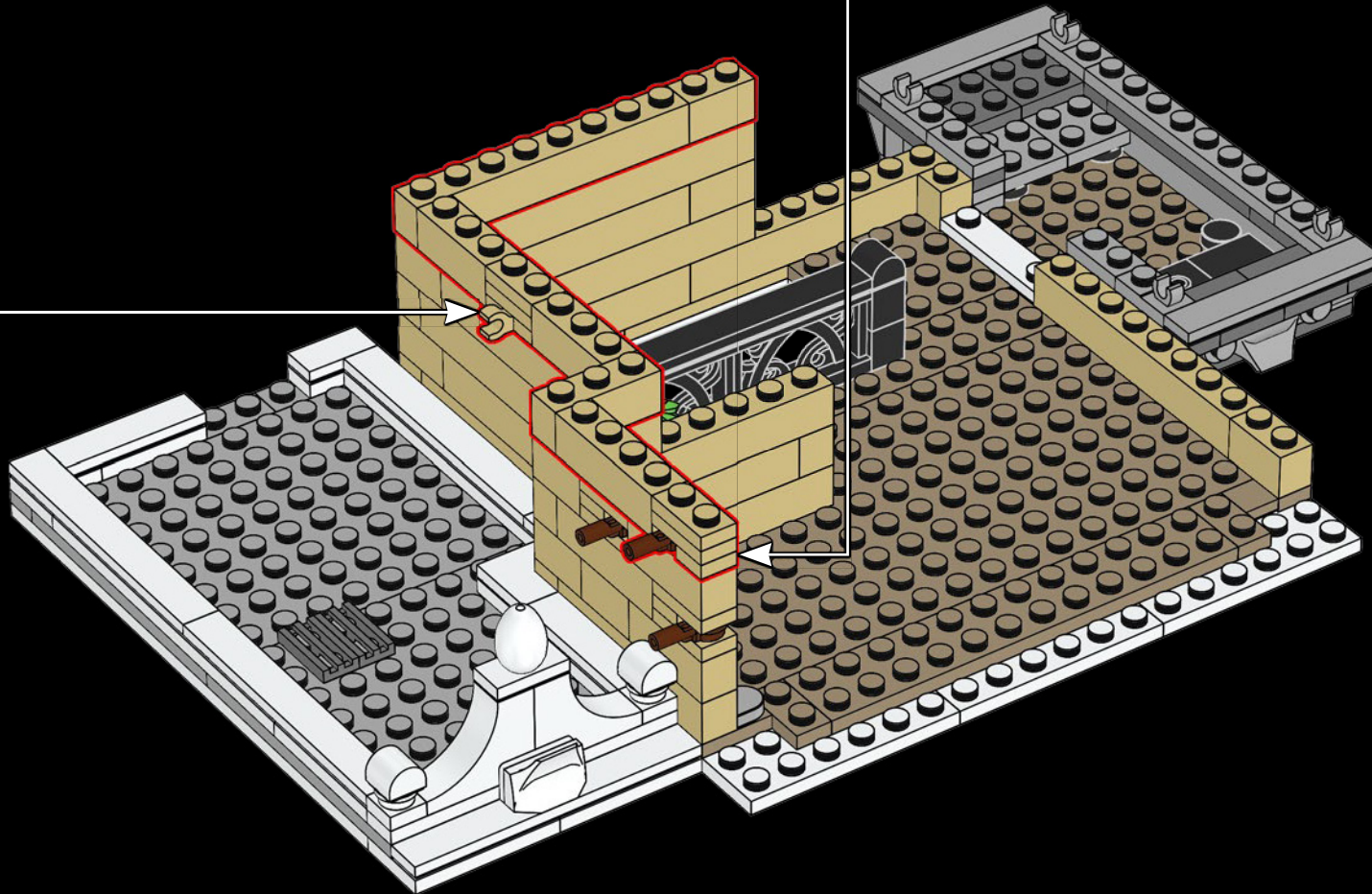
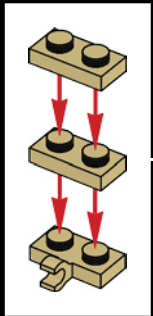
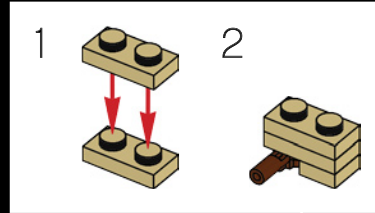



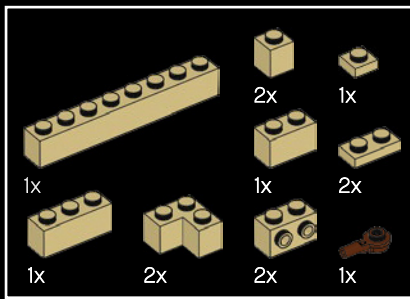

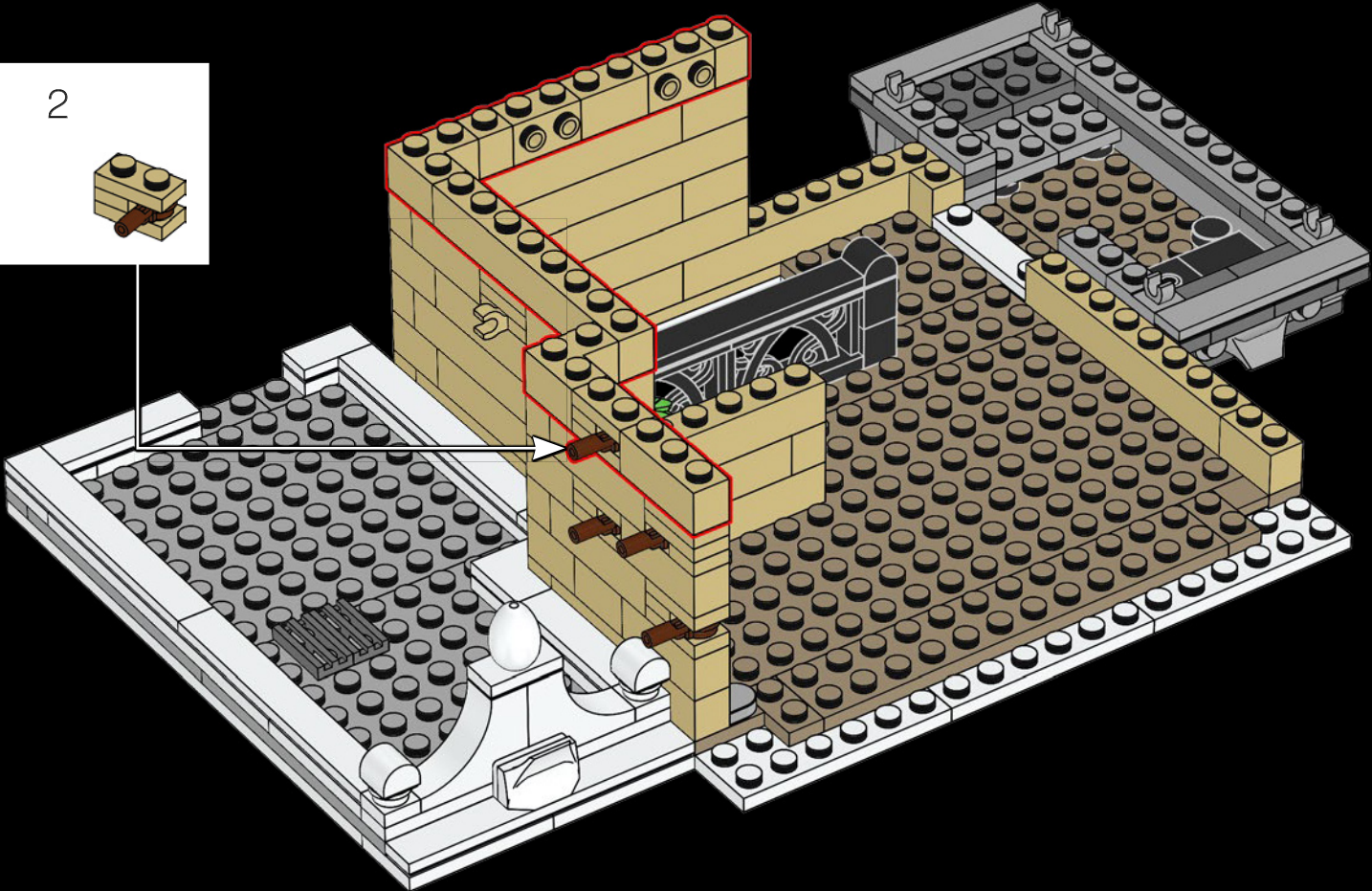
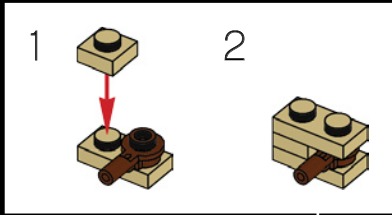

318



	
1x	3x

319

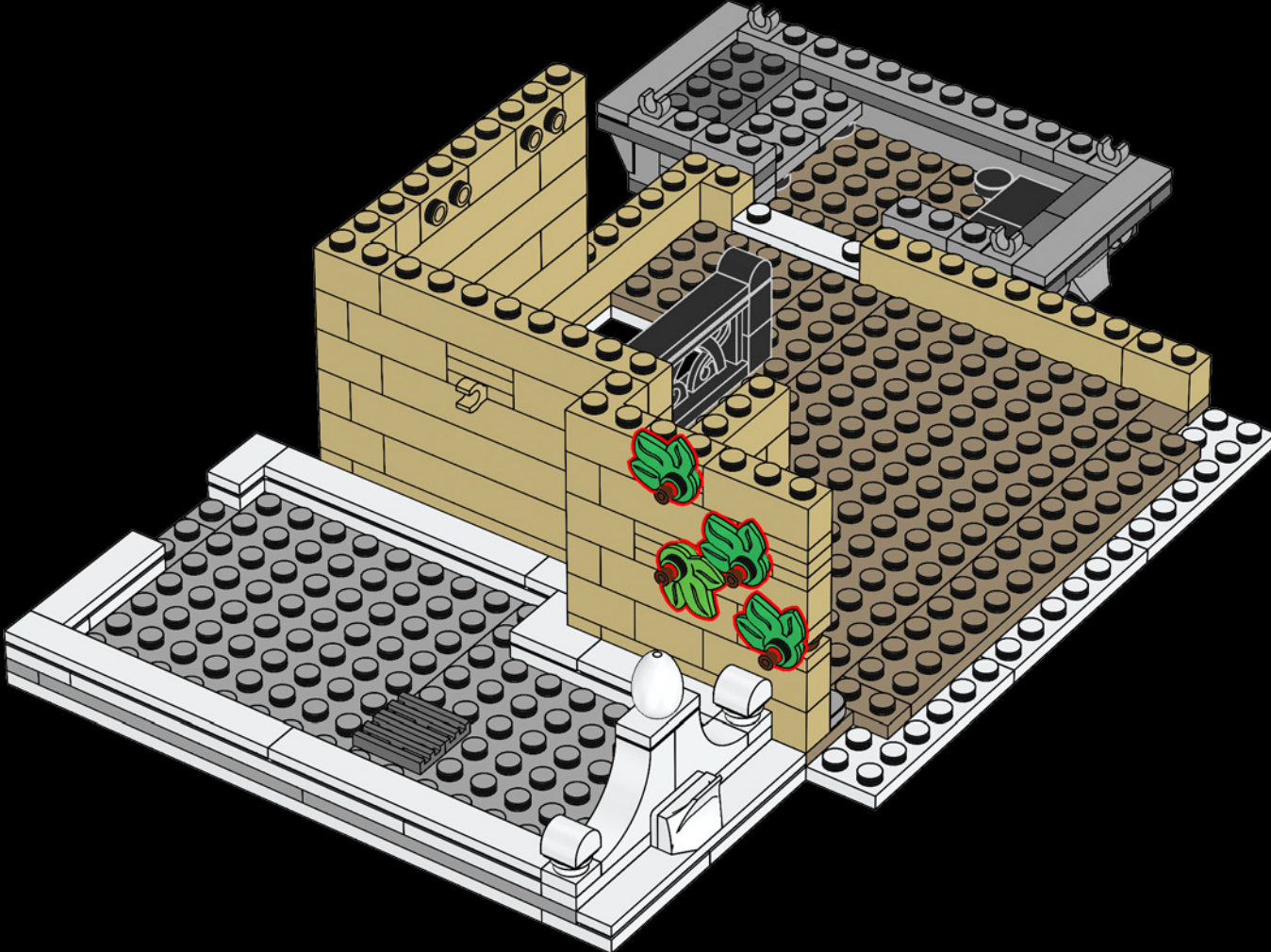





320

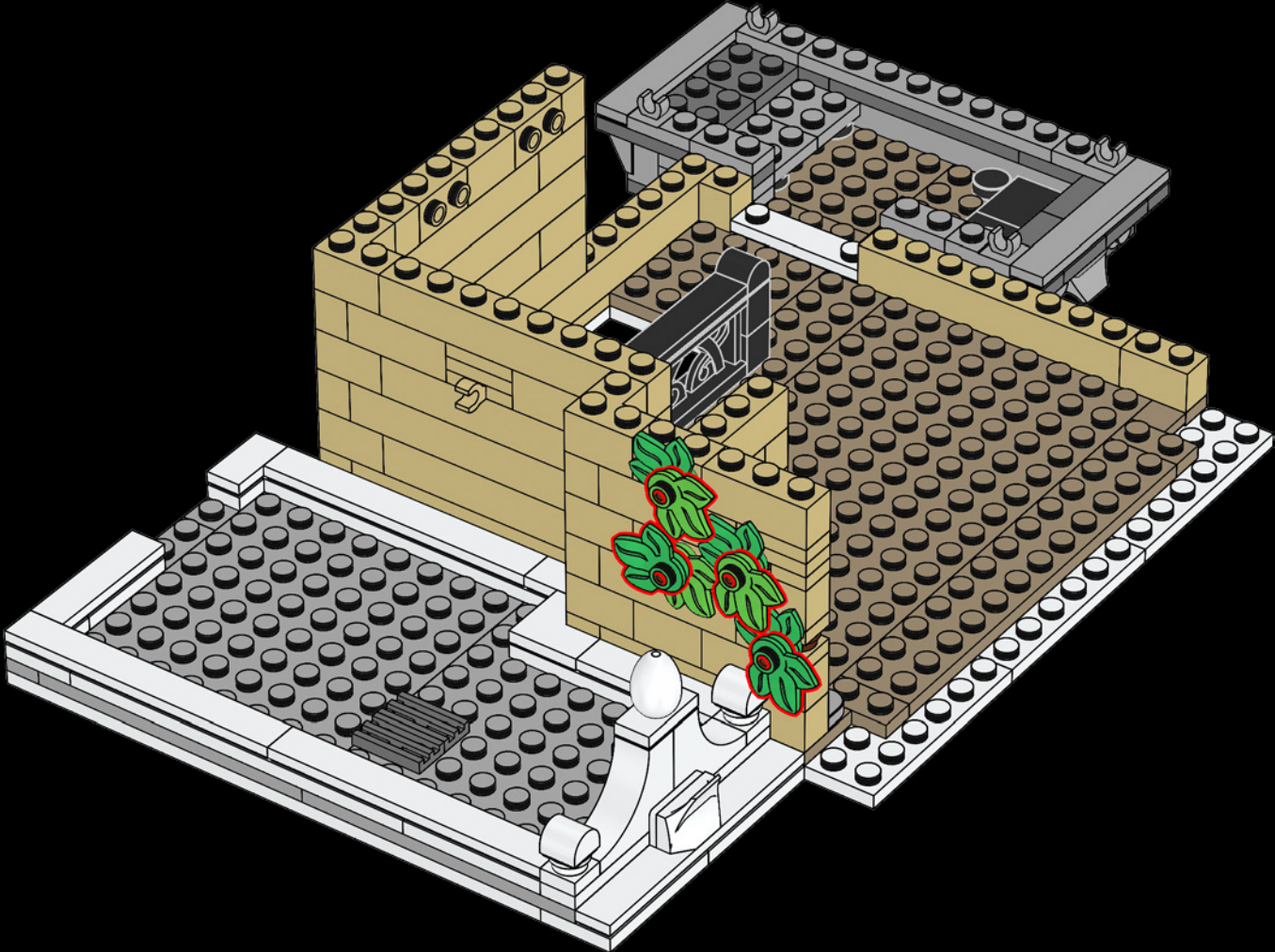

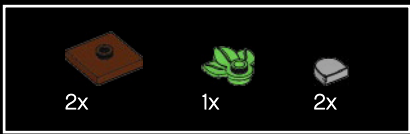

321

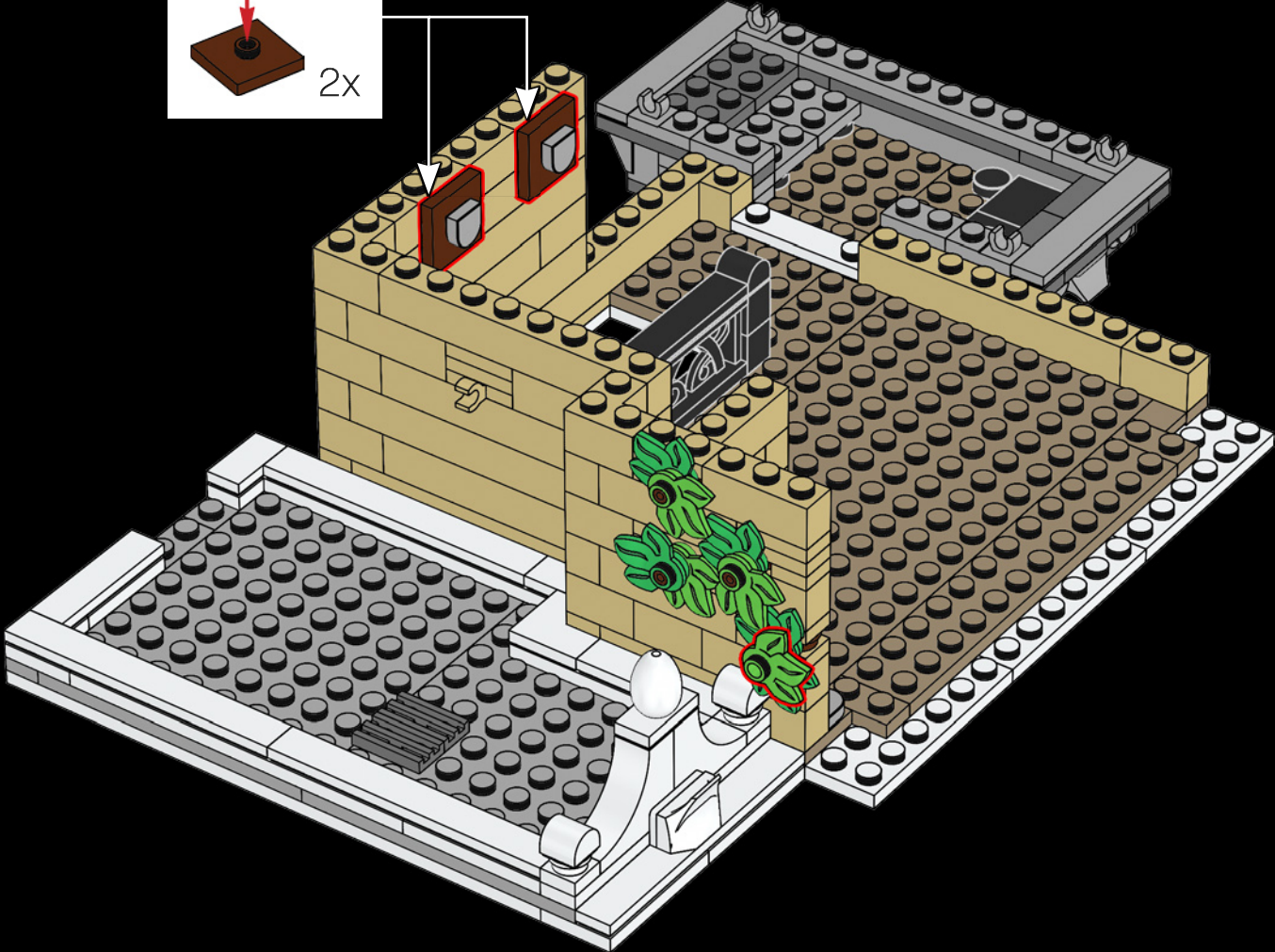
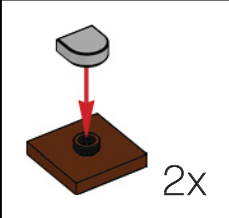







- The captain knows every brick of the police station and wants to take a bite out of crime.
- La capitaine connaît toutes les briques du poste de police et veut réduire la criminalité.
- El capitán conoce cada brick de la Estación de Policía y quiere darle un buen golpe al crimen.

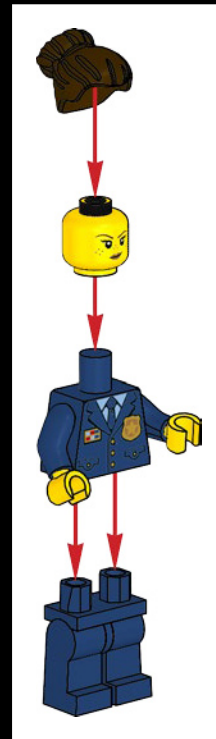



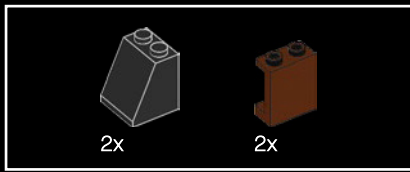

323

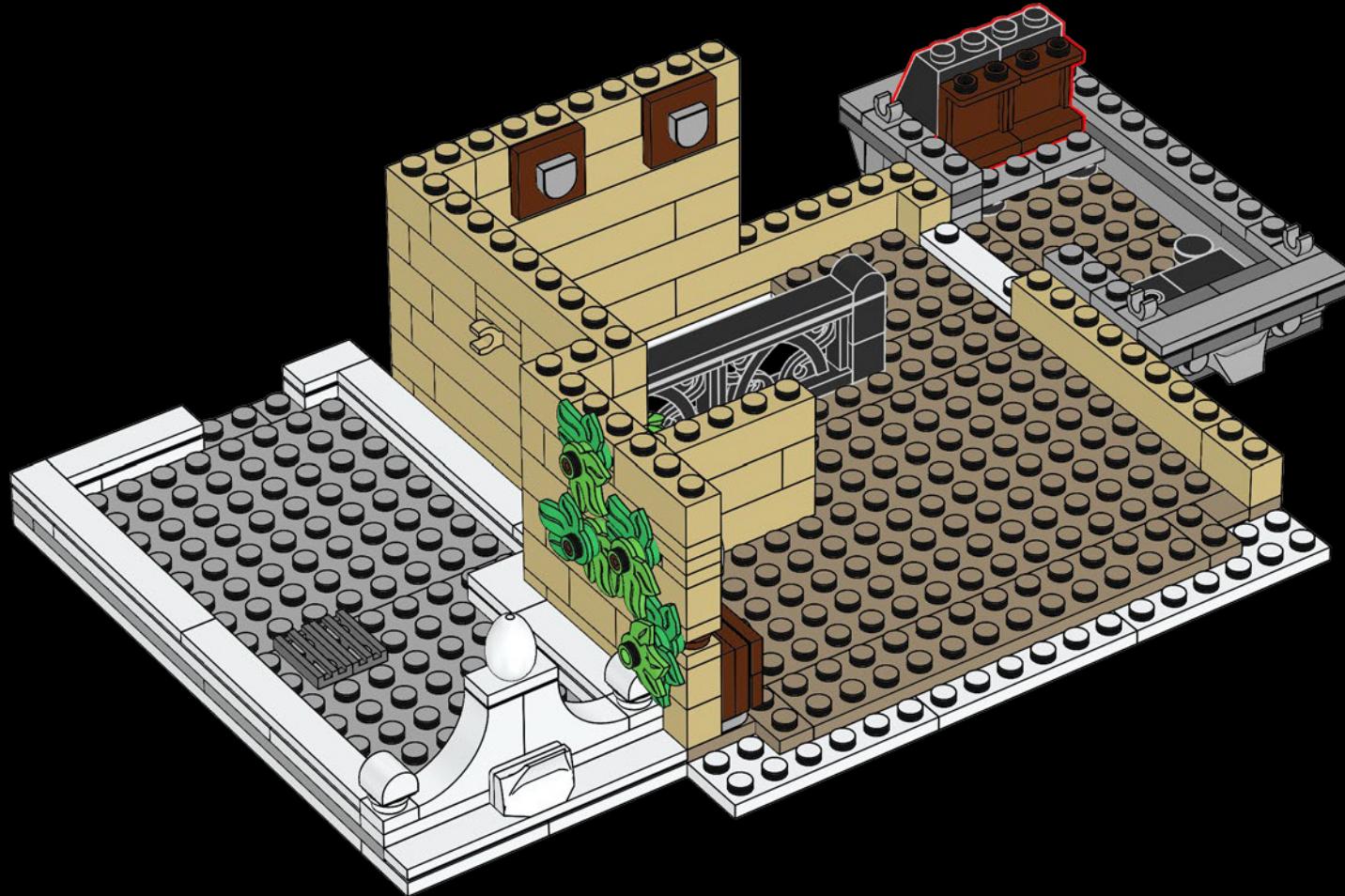



324

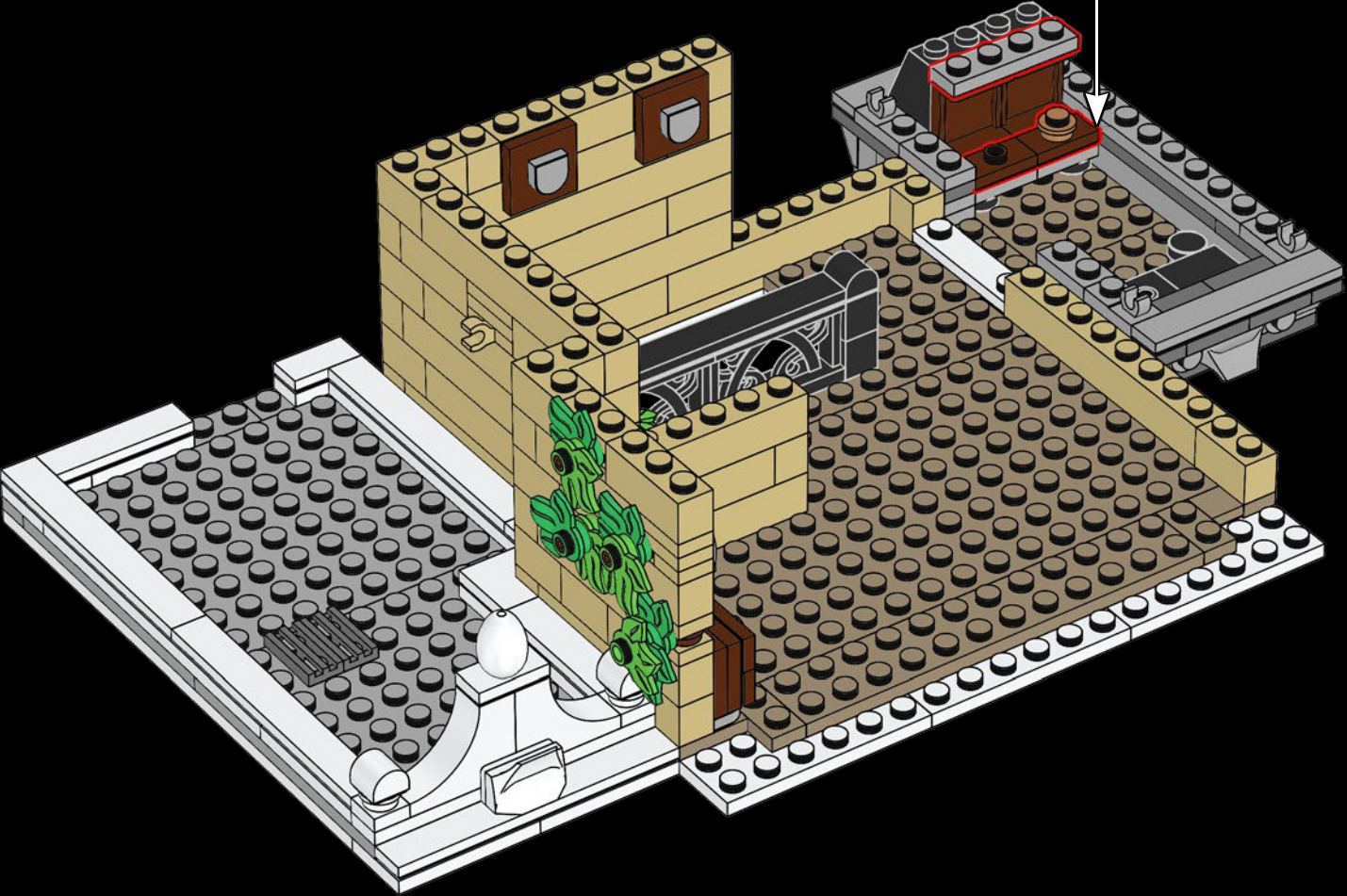
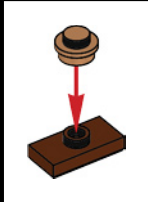





325

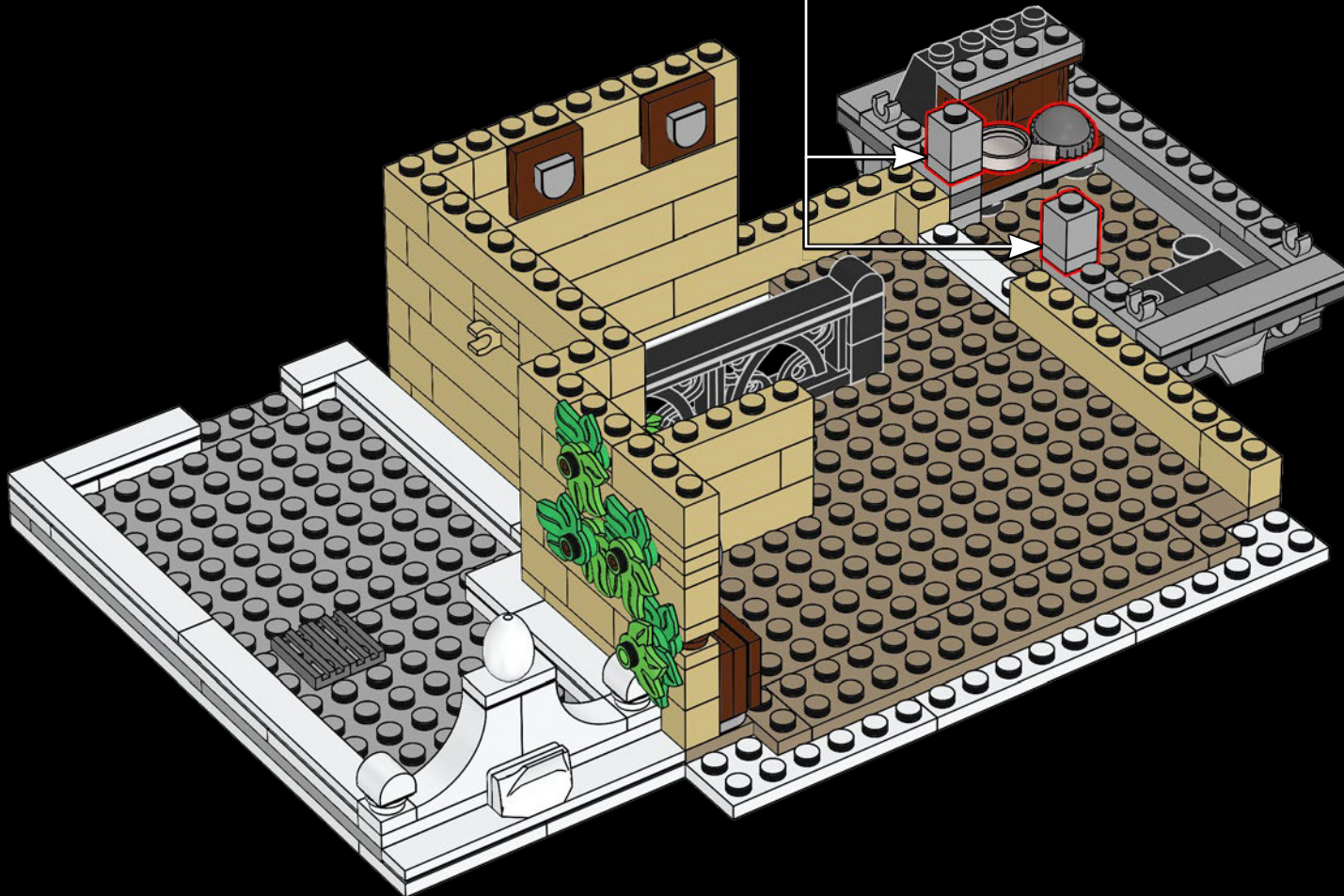
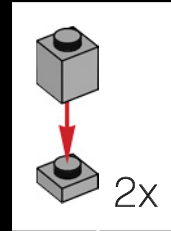

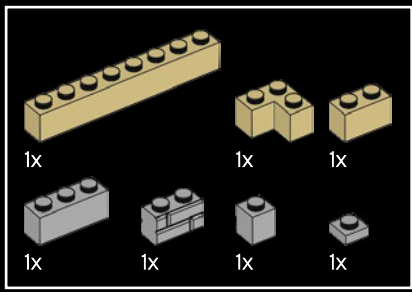

326

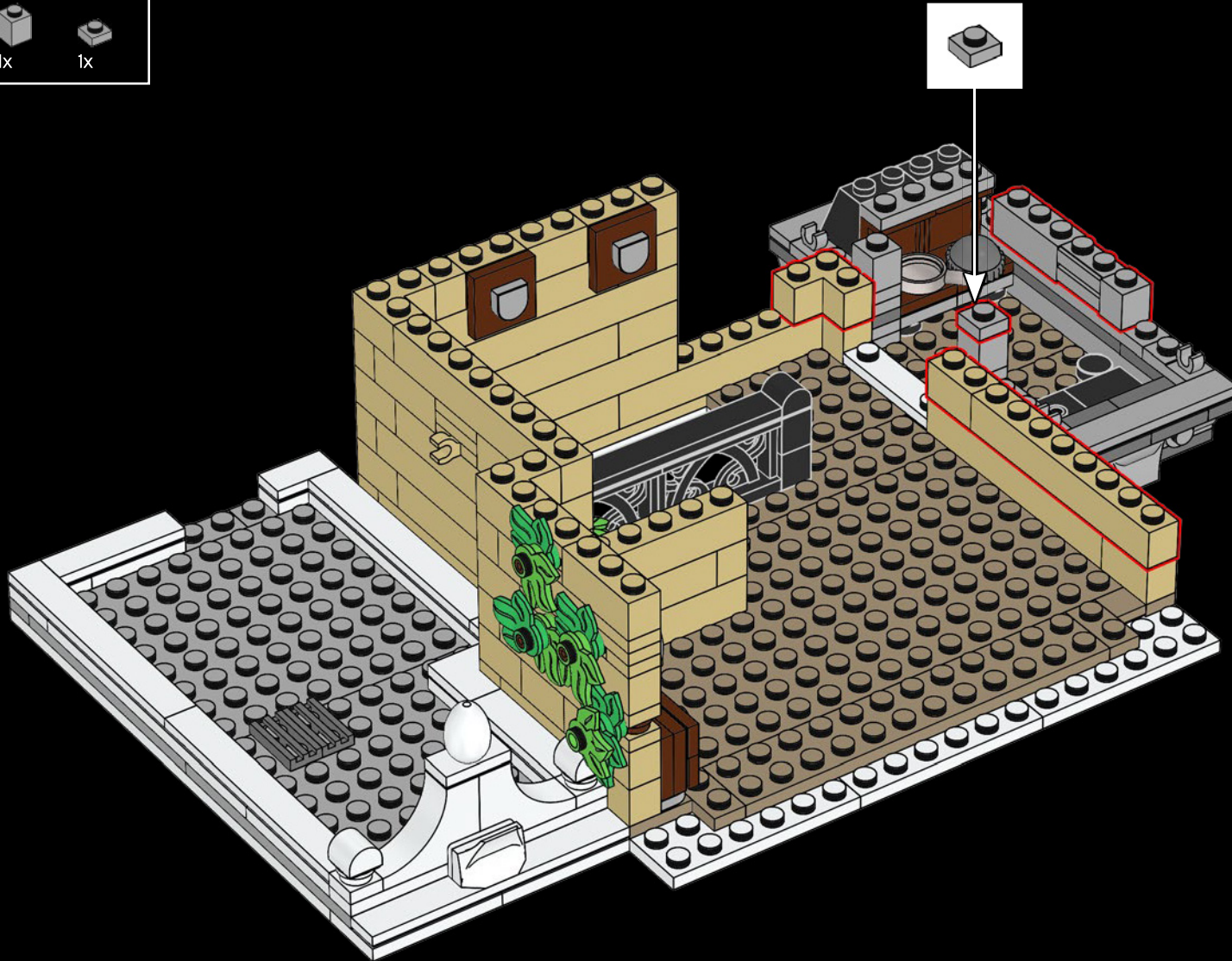



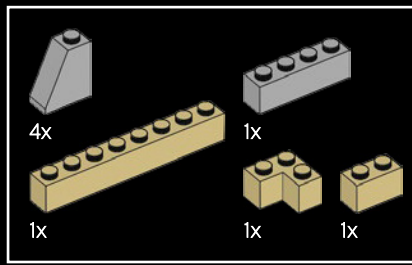

327

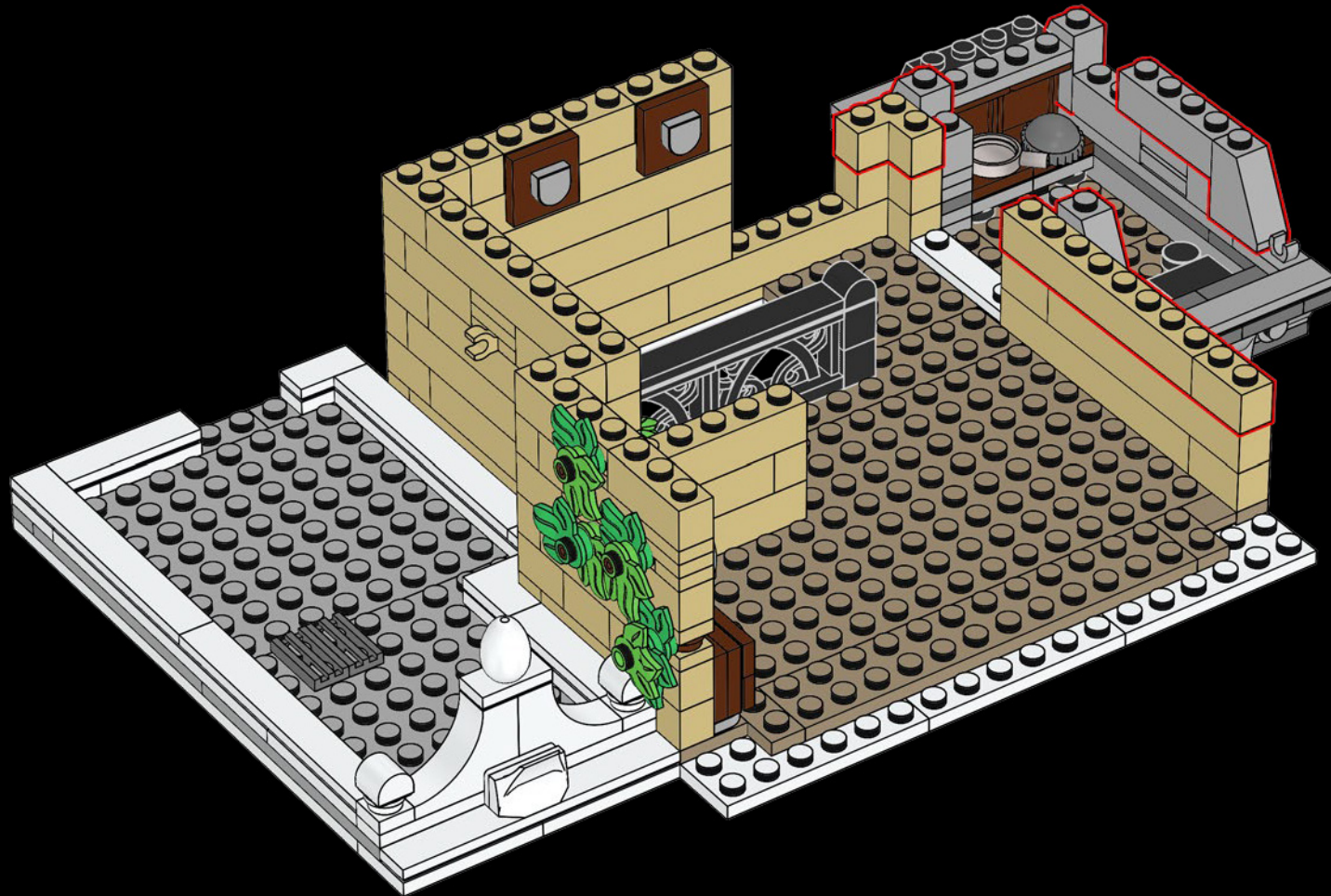

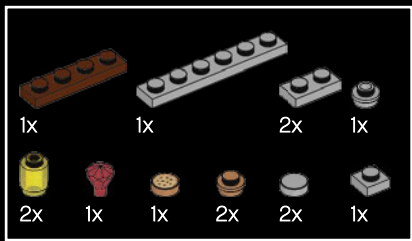

328

1

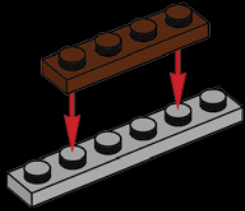

2

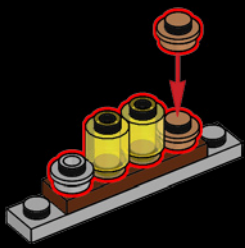

3



4



5

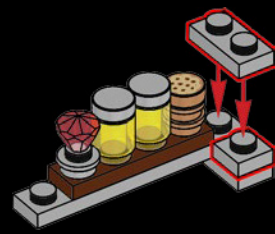



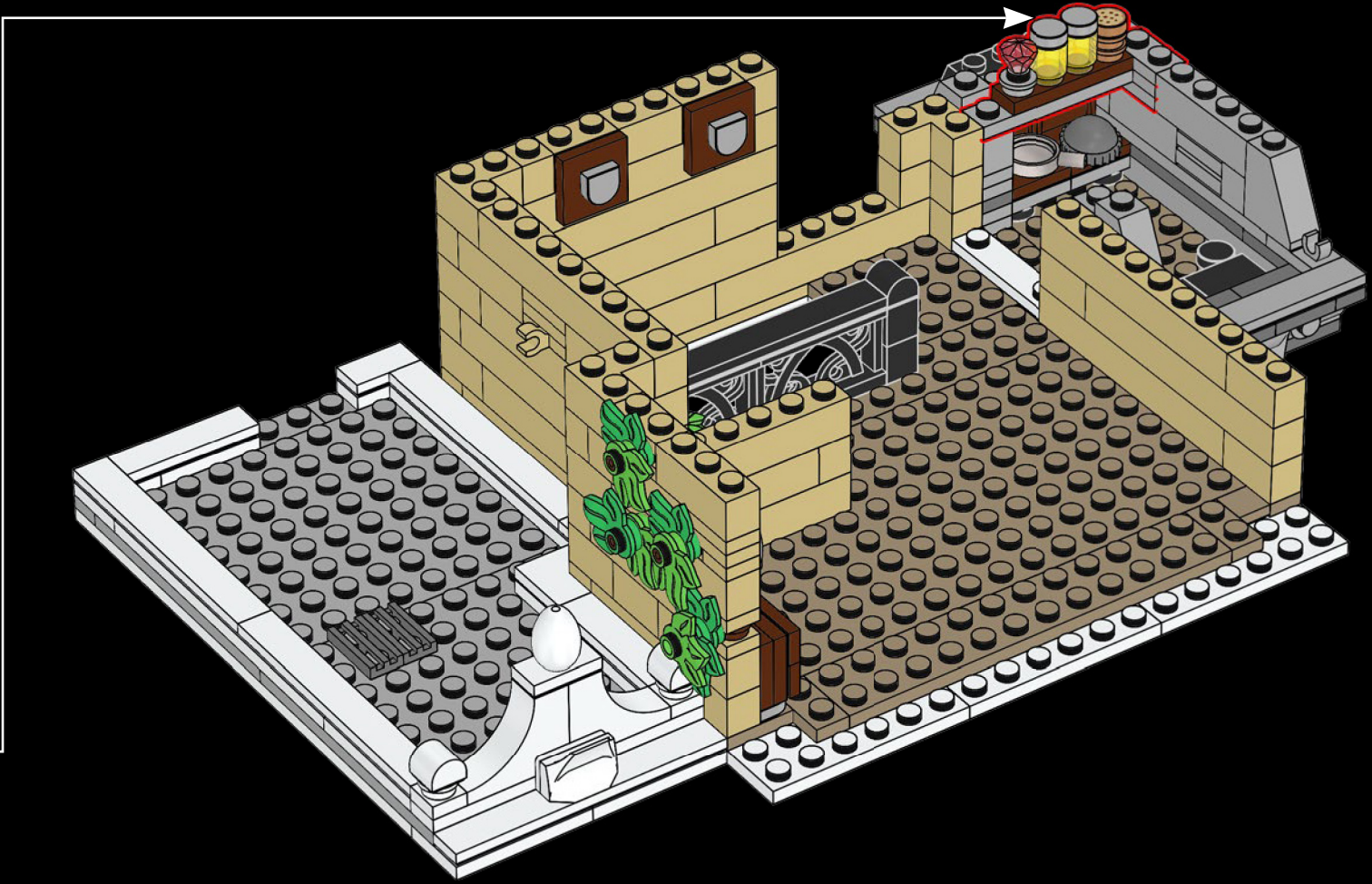

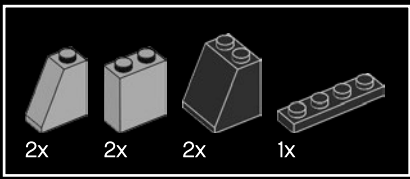

329

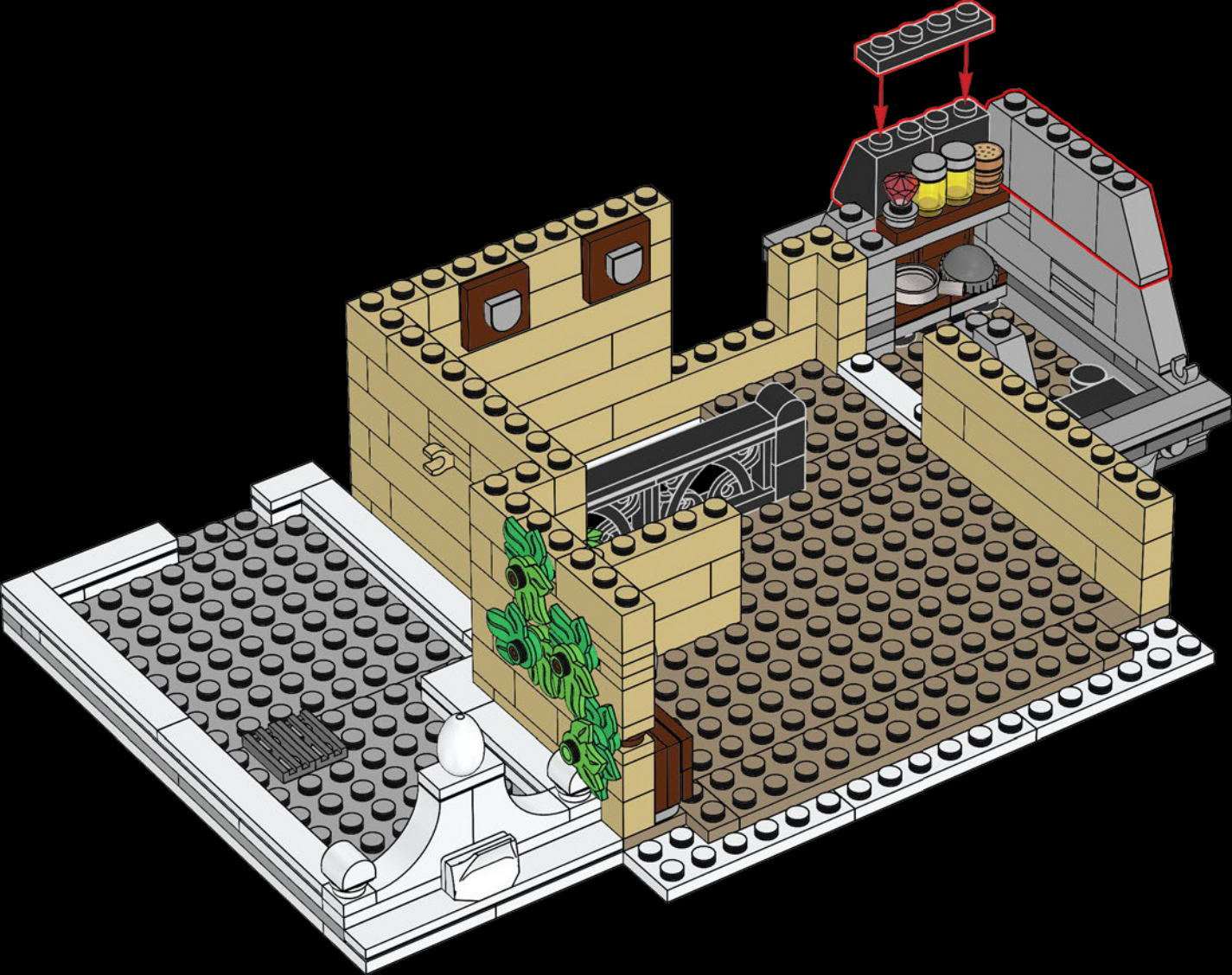



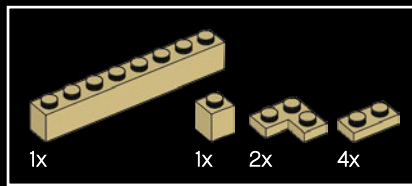

330

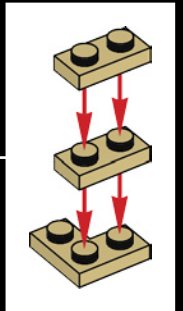
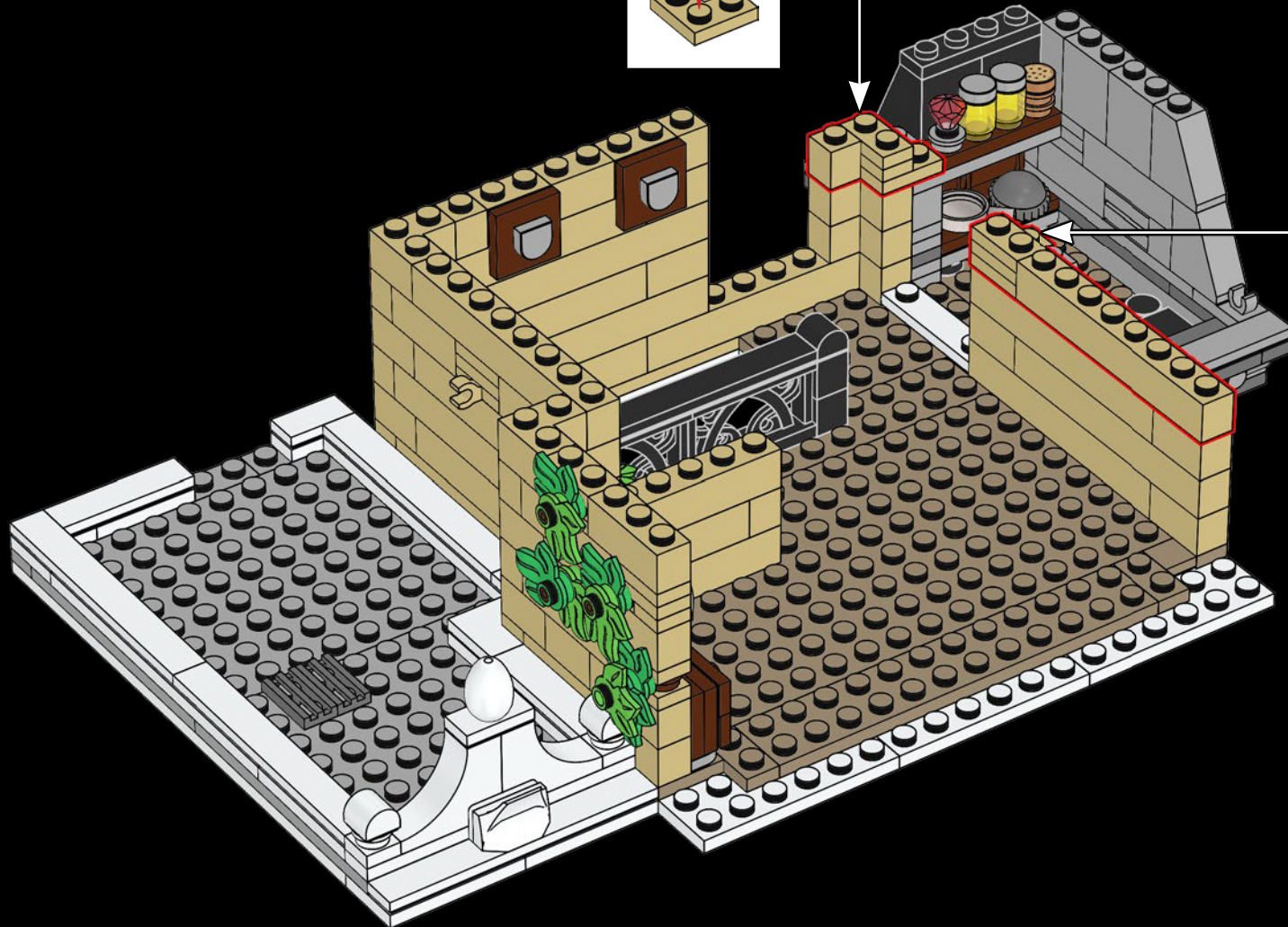
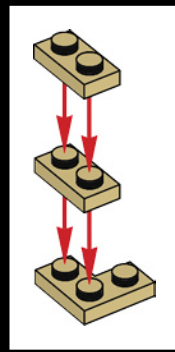

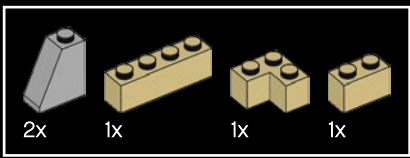

331

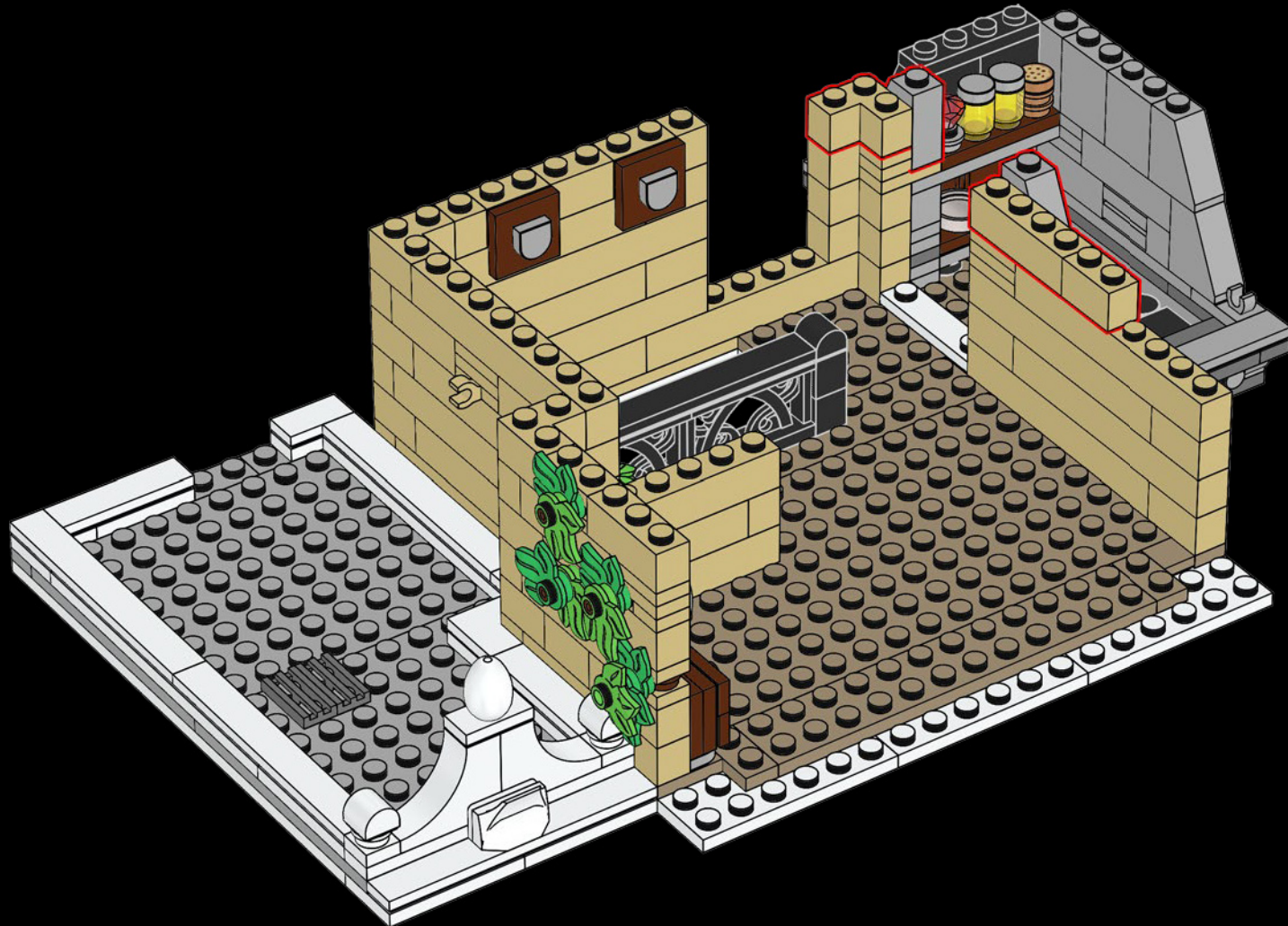



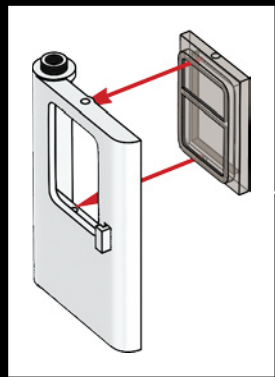
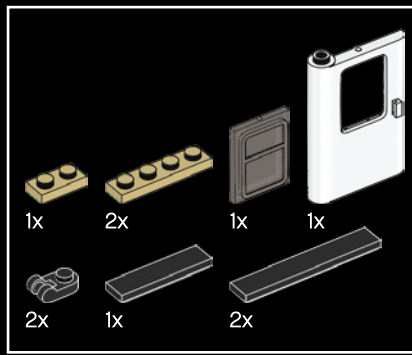

332

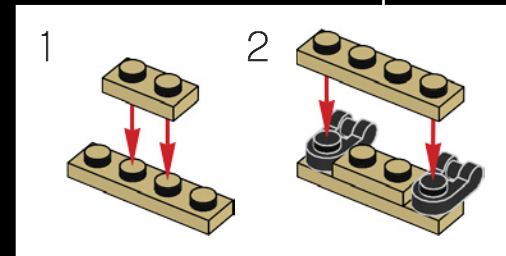
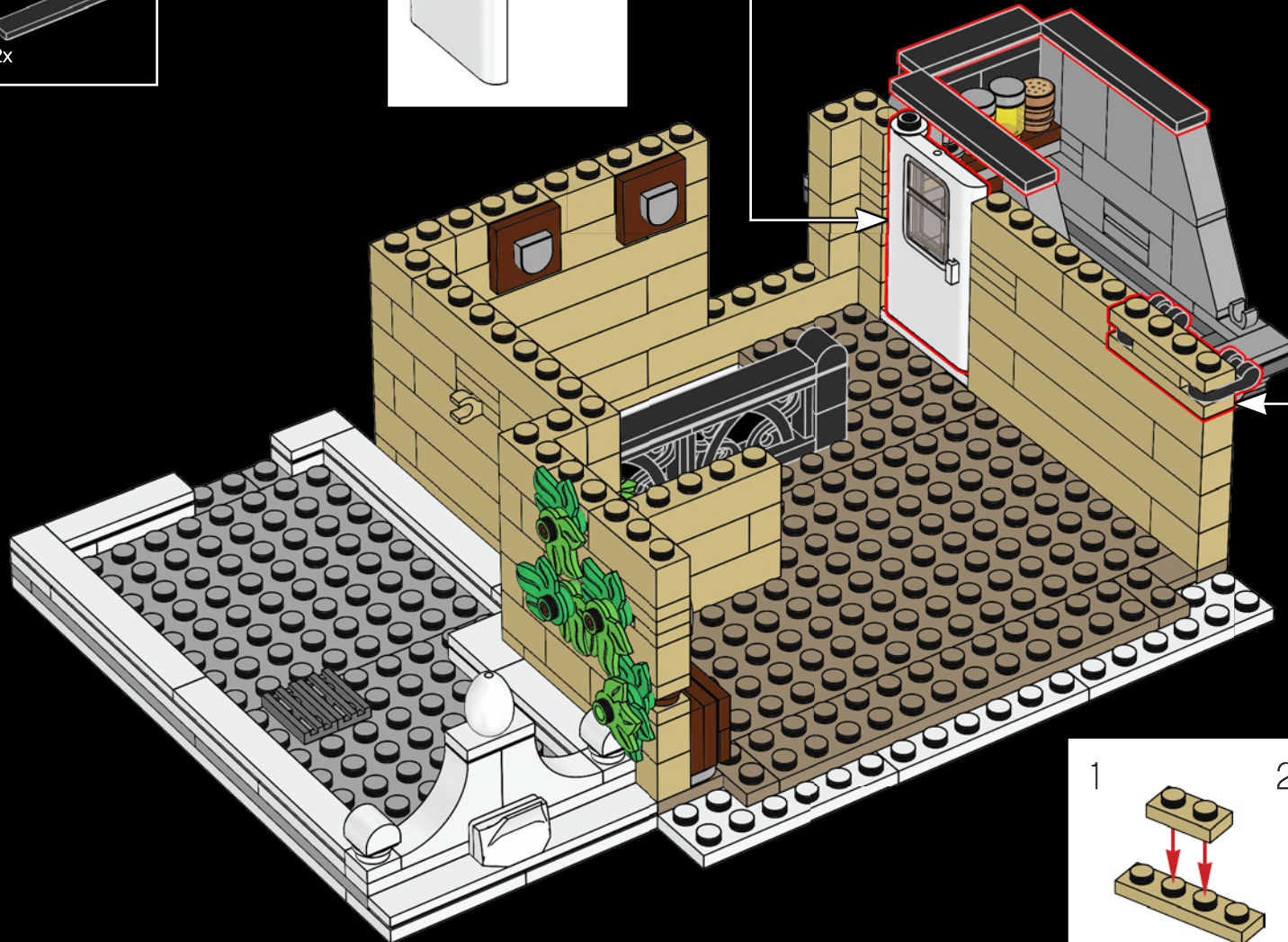

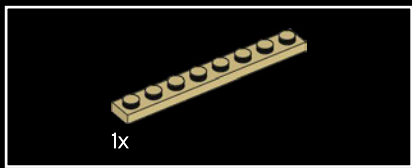

333

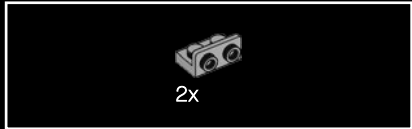
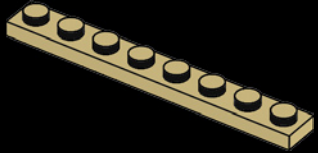

334

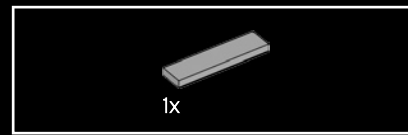
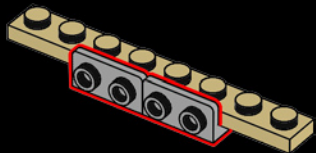

335

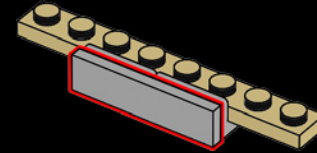

336

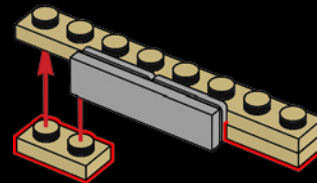

337

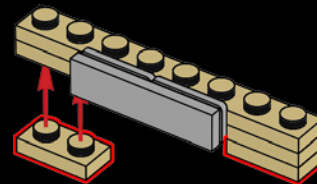



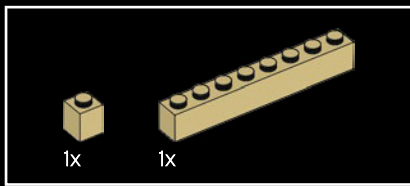

338

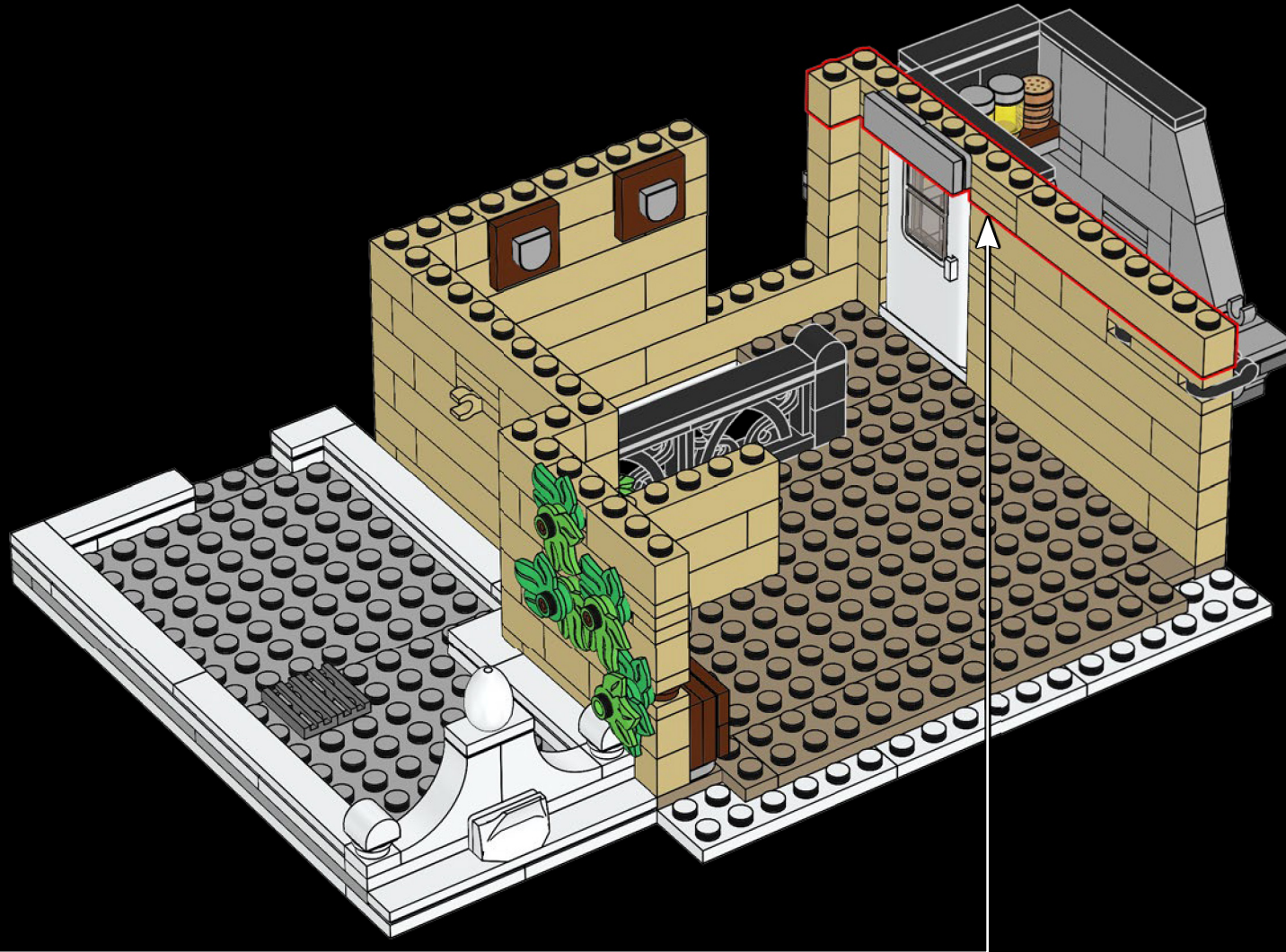

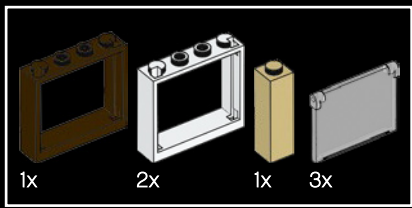

339

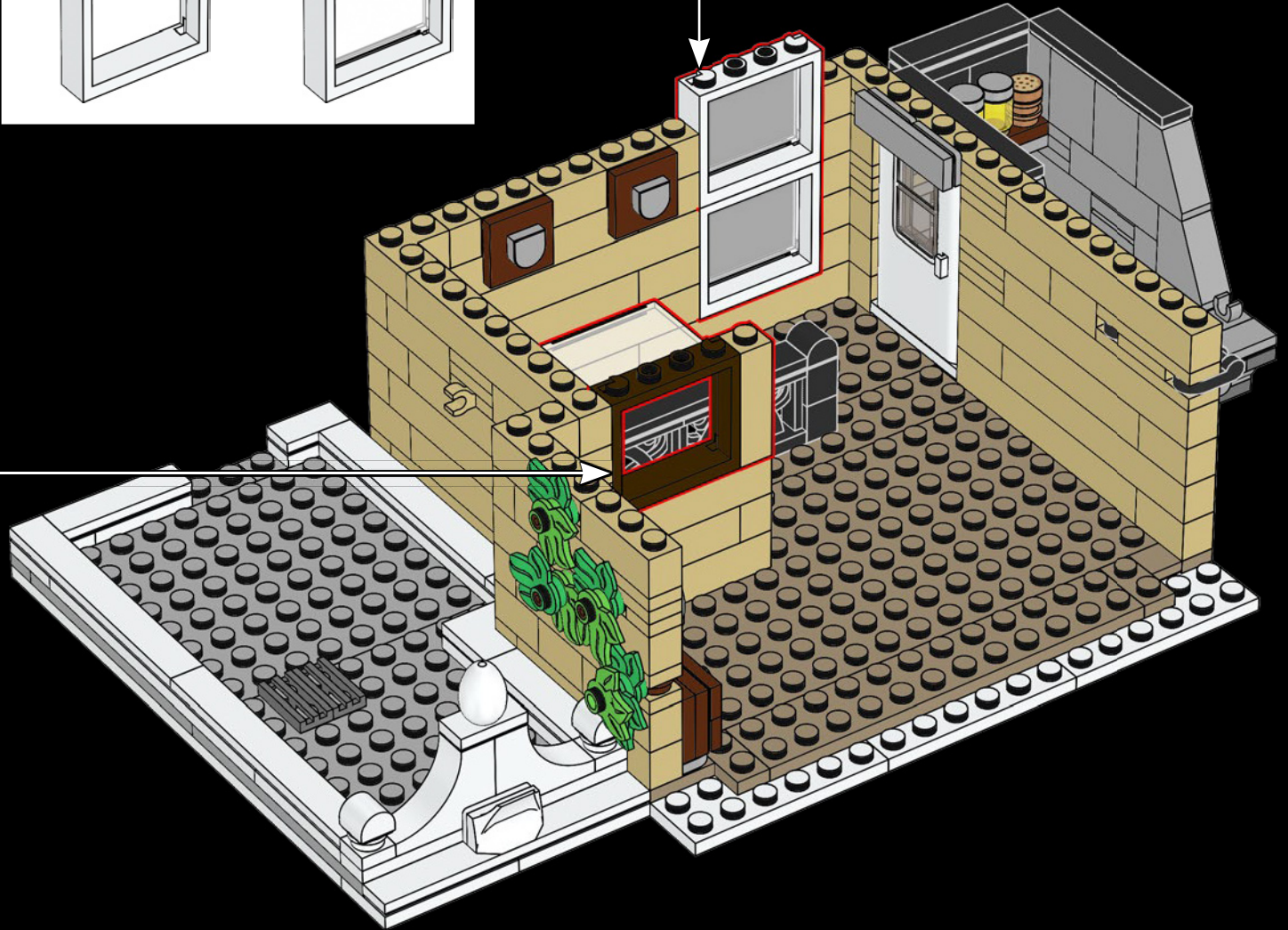
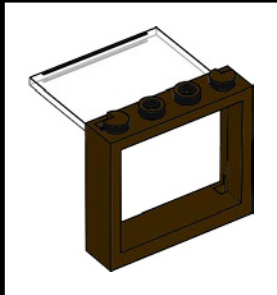
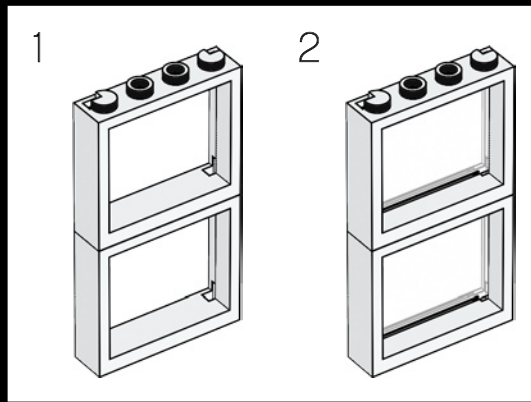



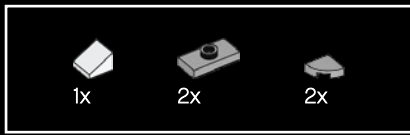

340

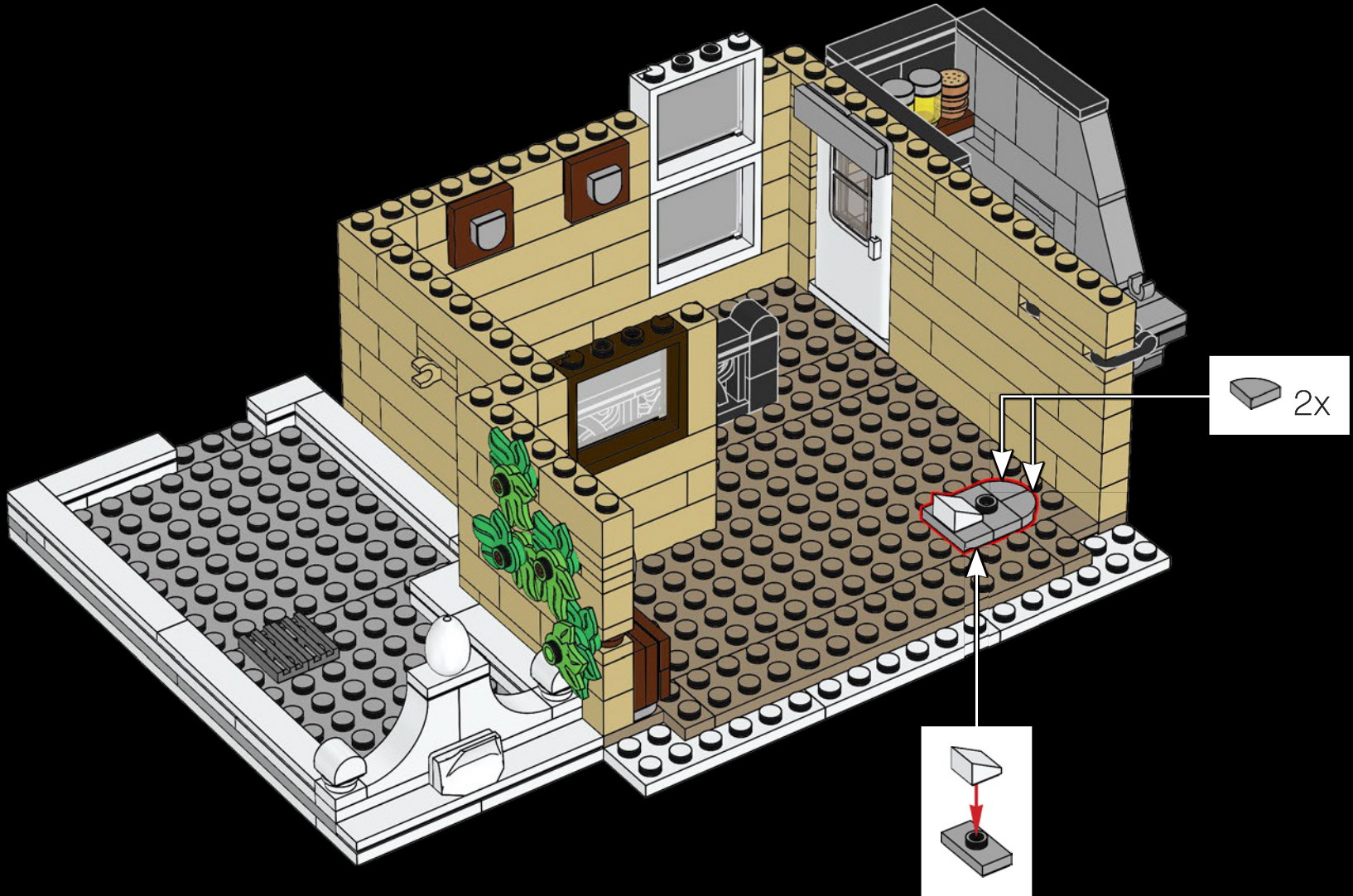

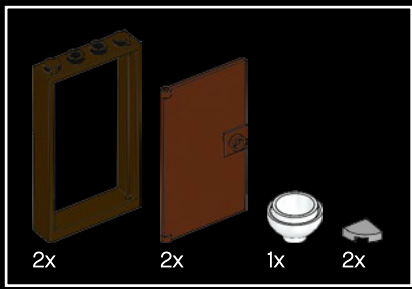

341

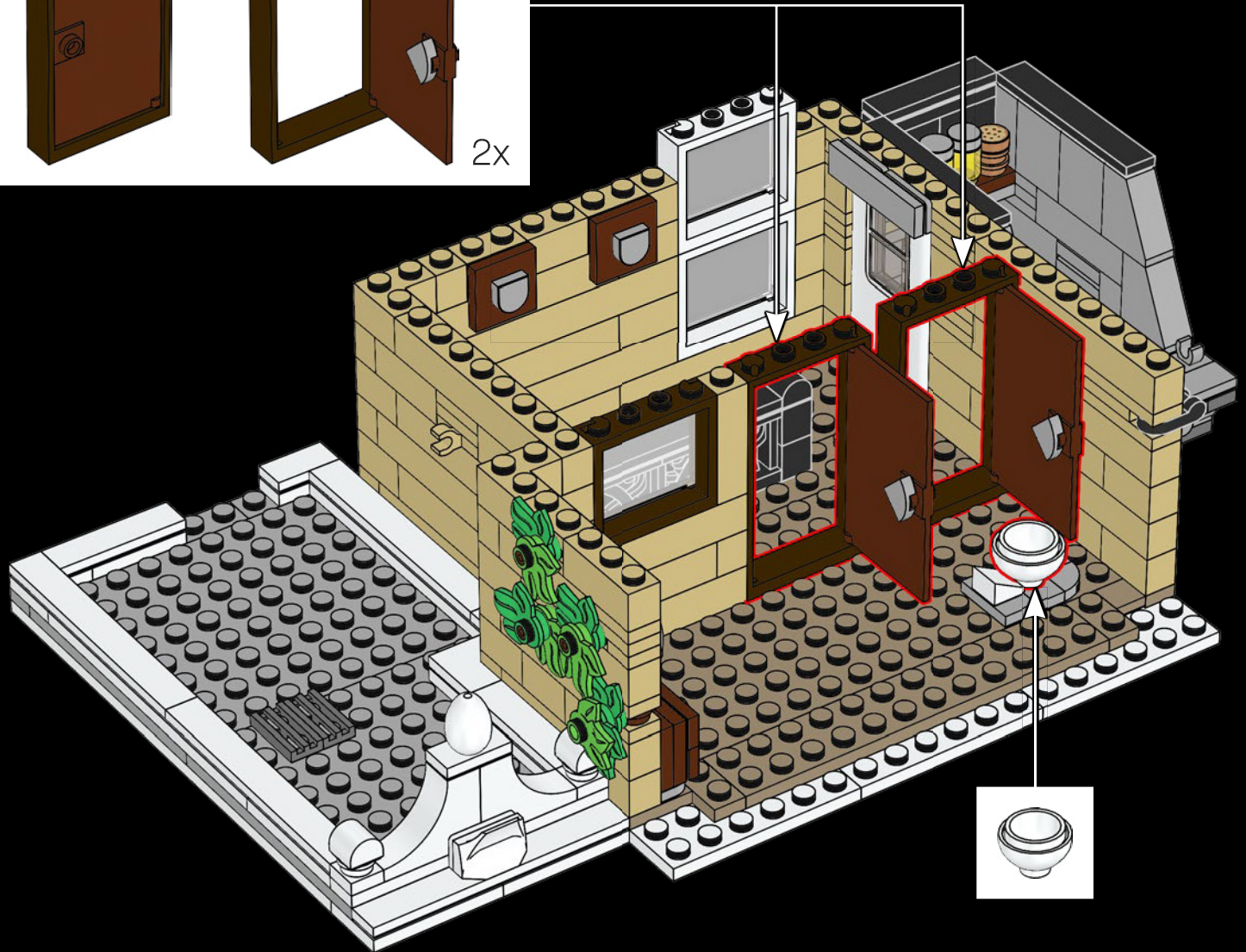
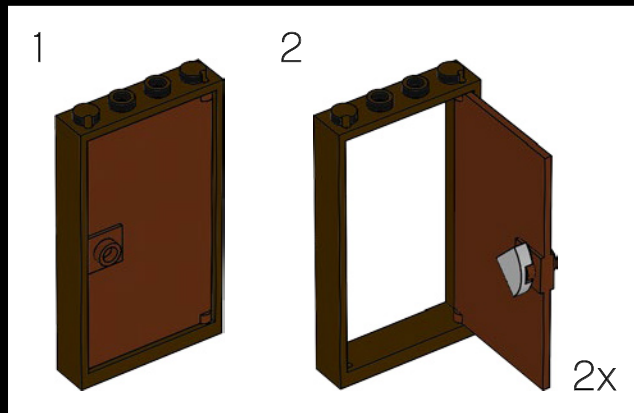



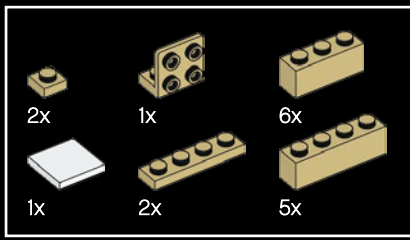

342

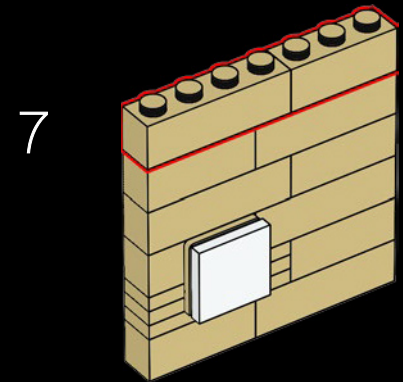
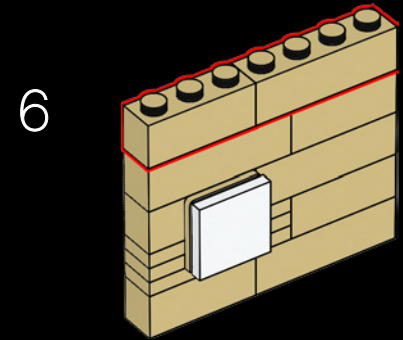
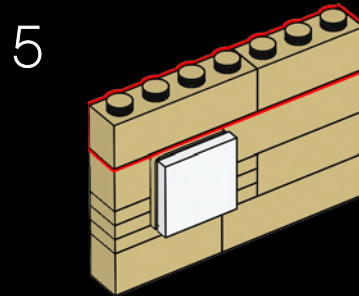
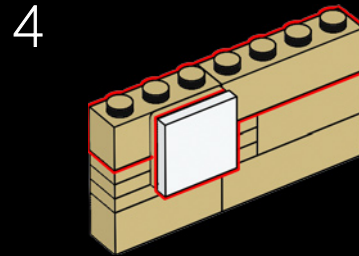
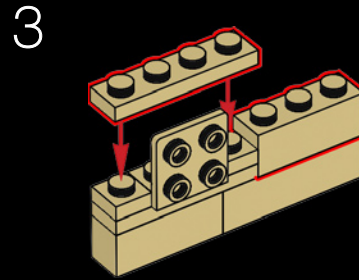
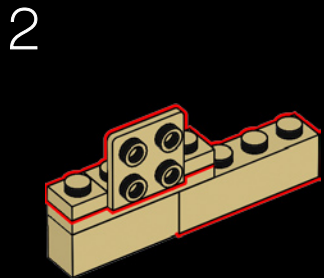
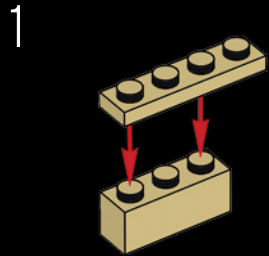

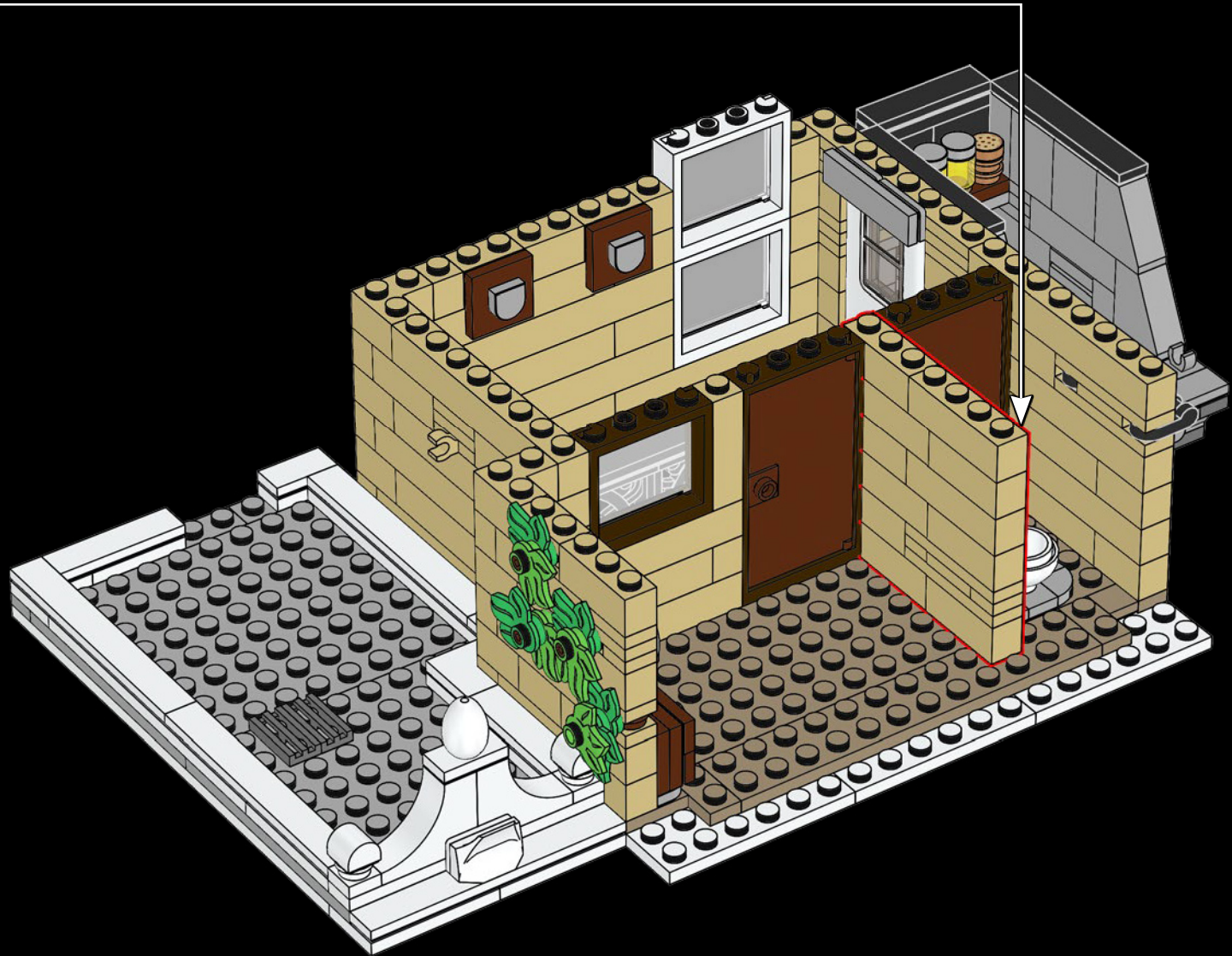



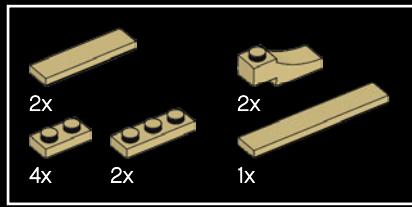

343

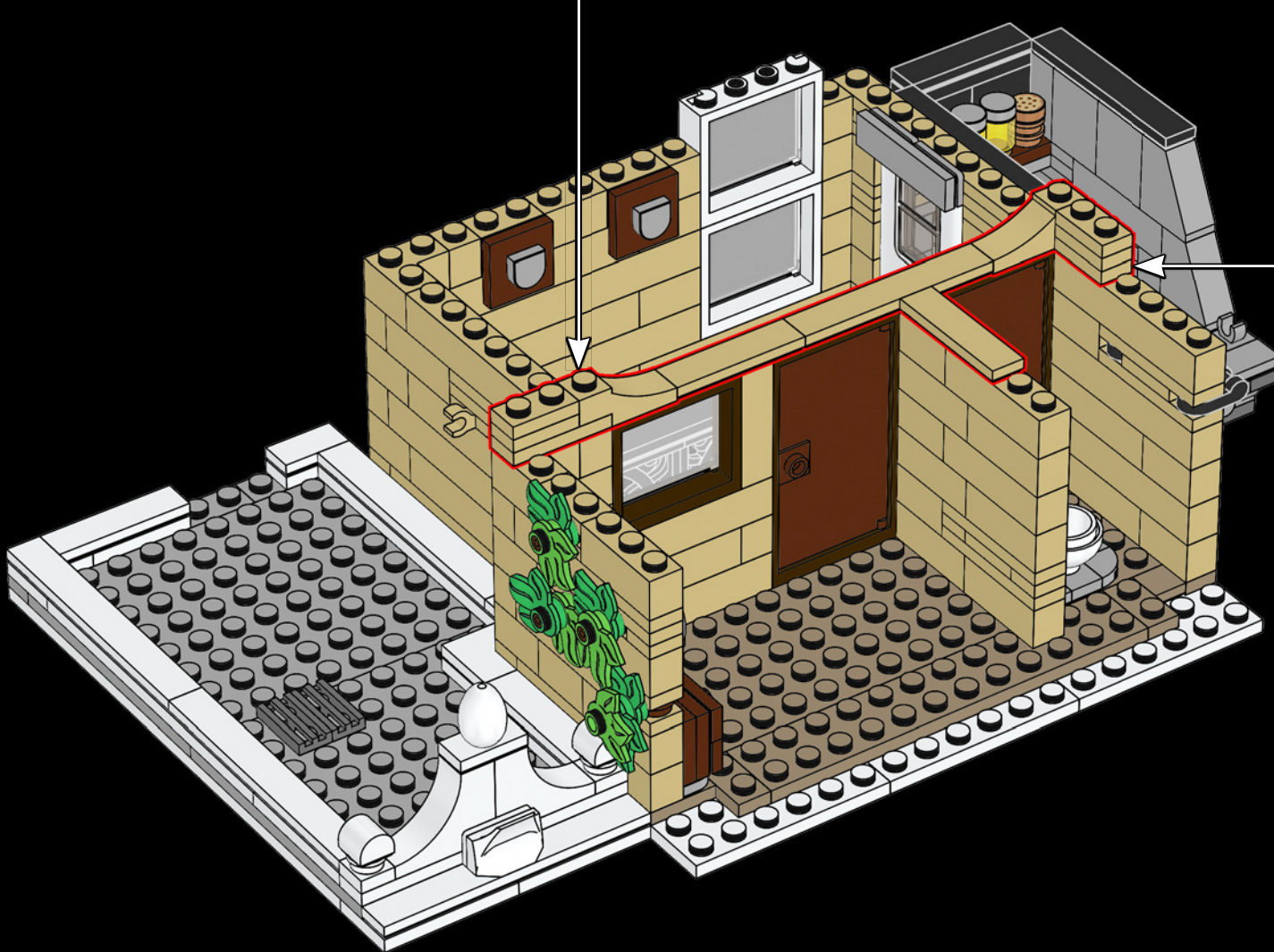
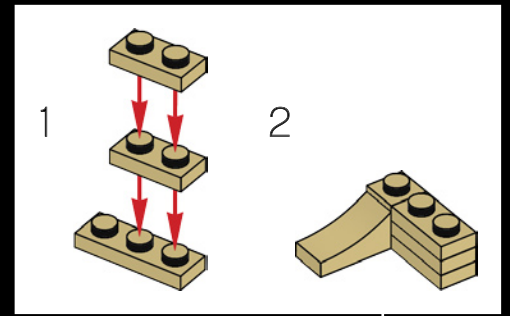
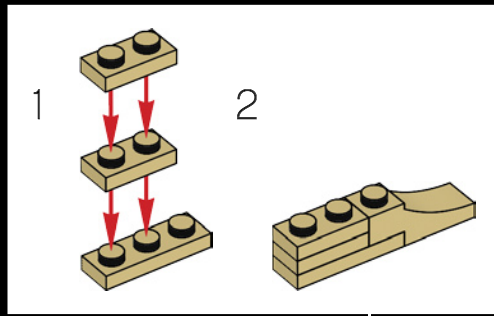

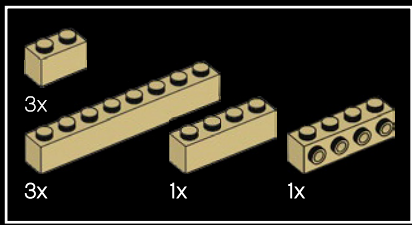

344

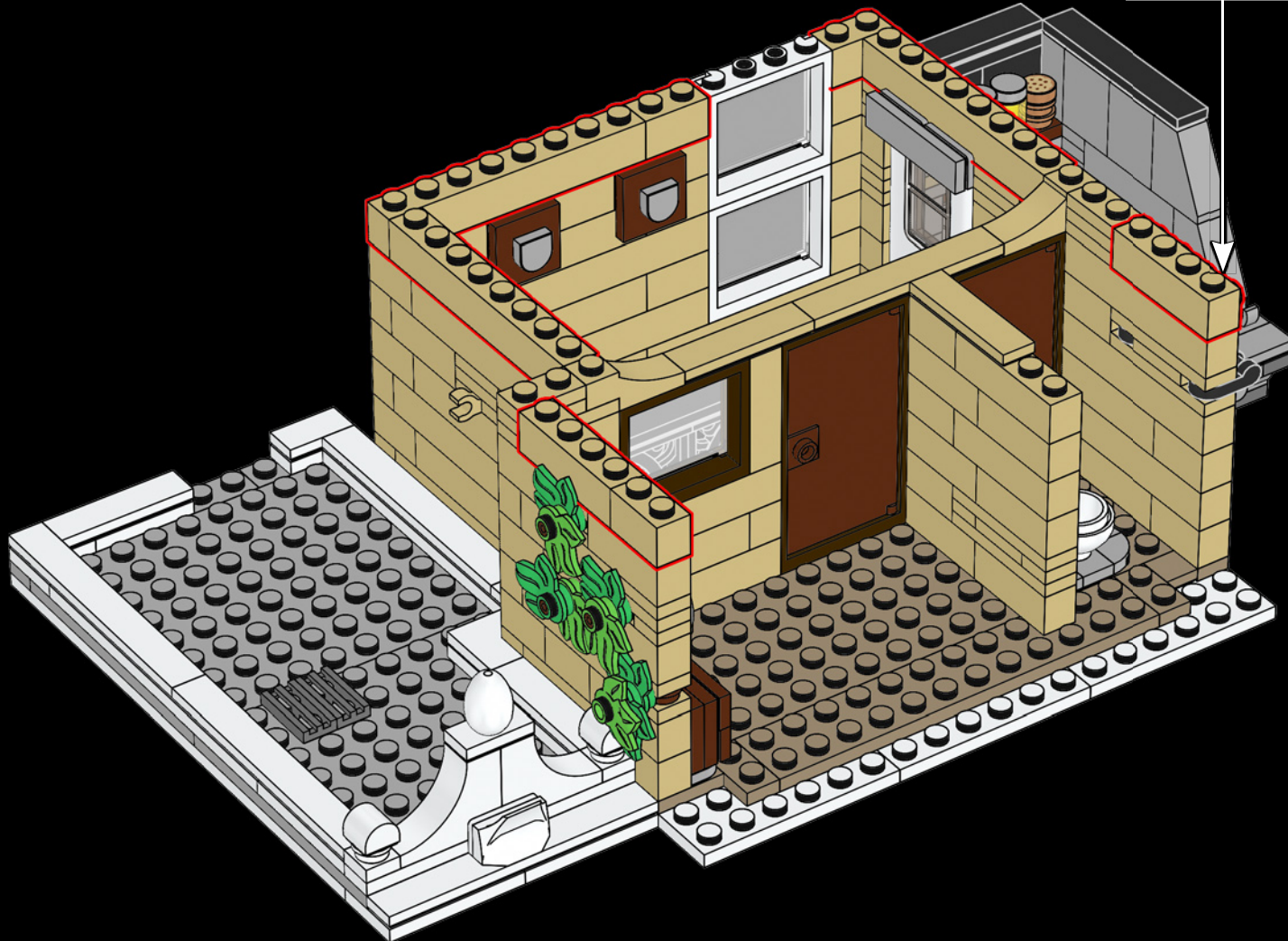
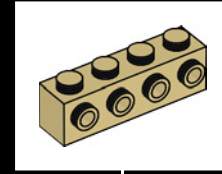



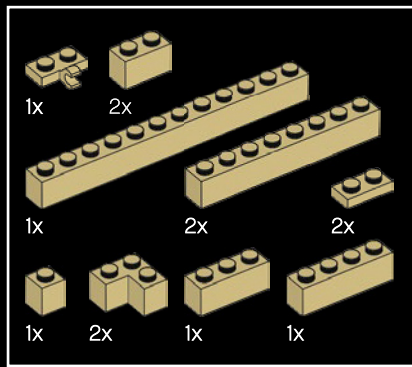

345

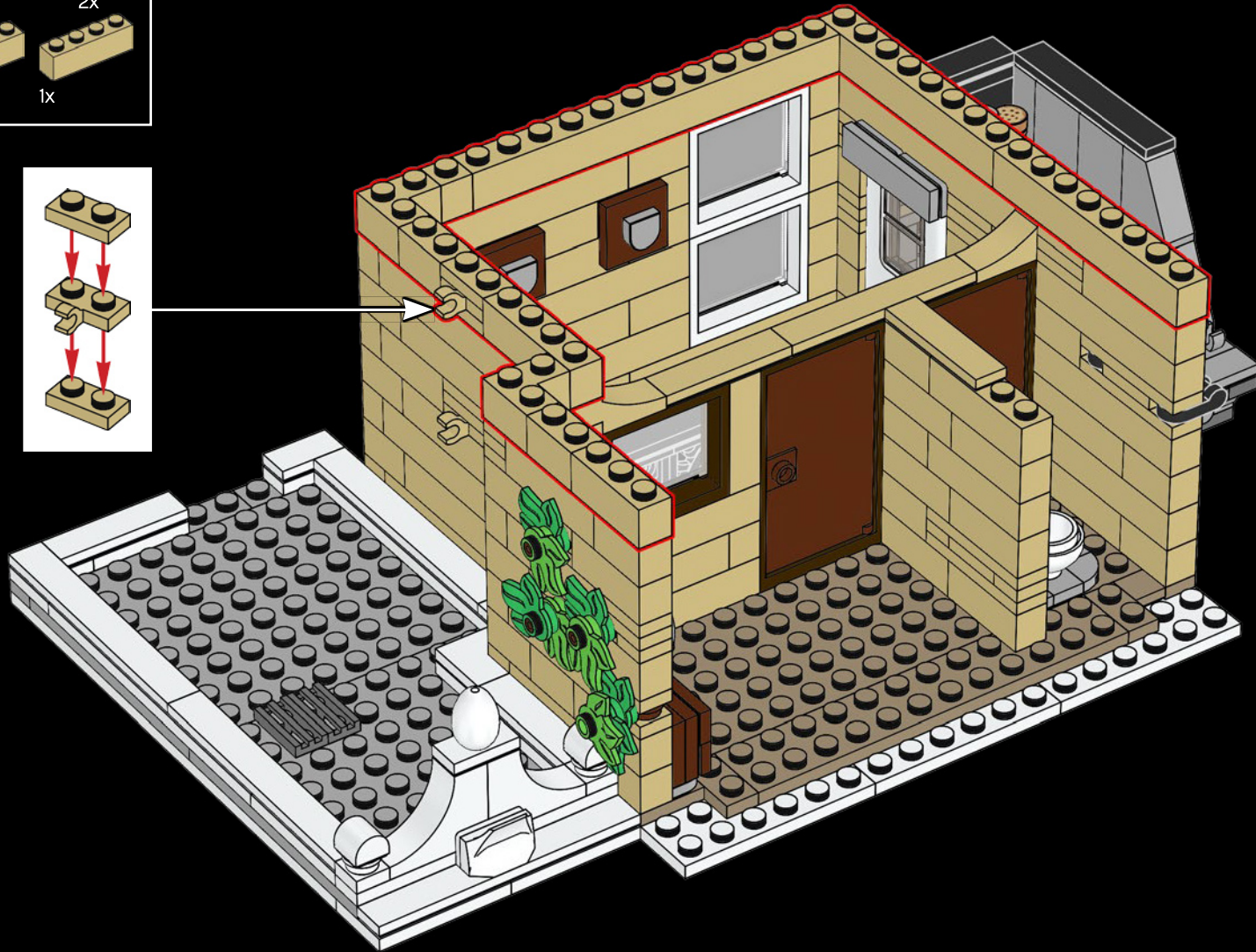
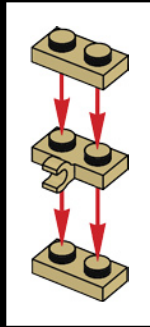

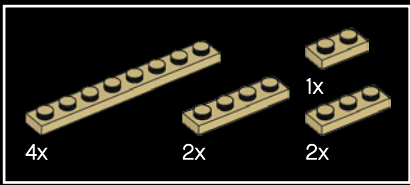

346

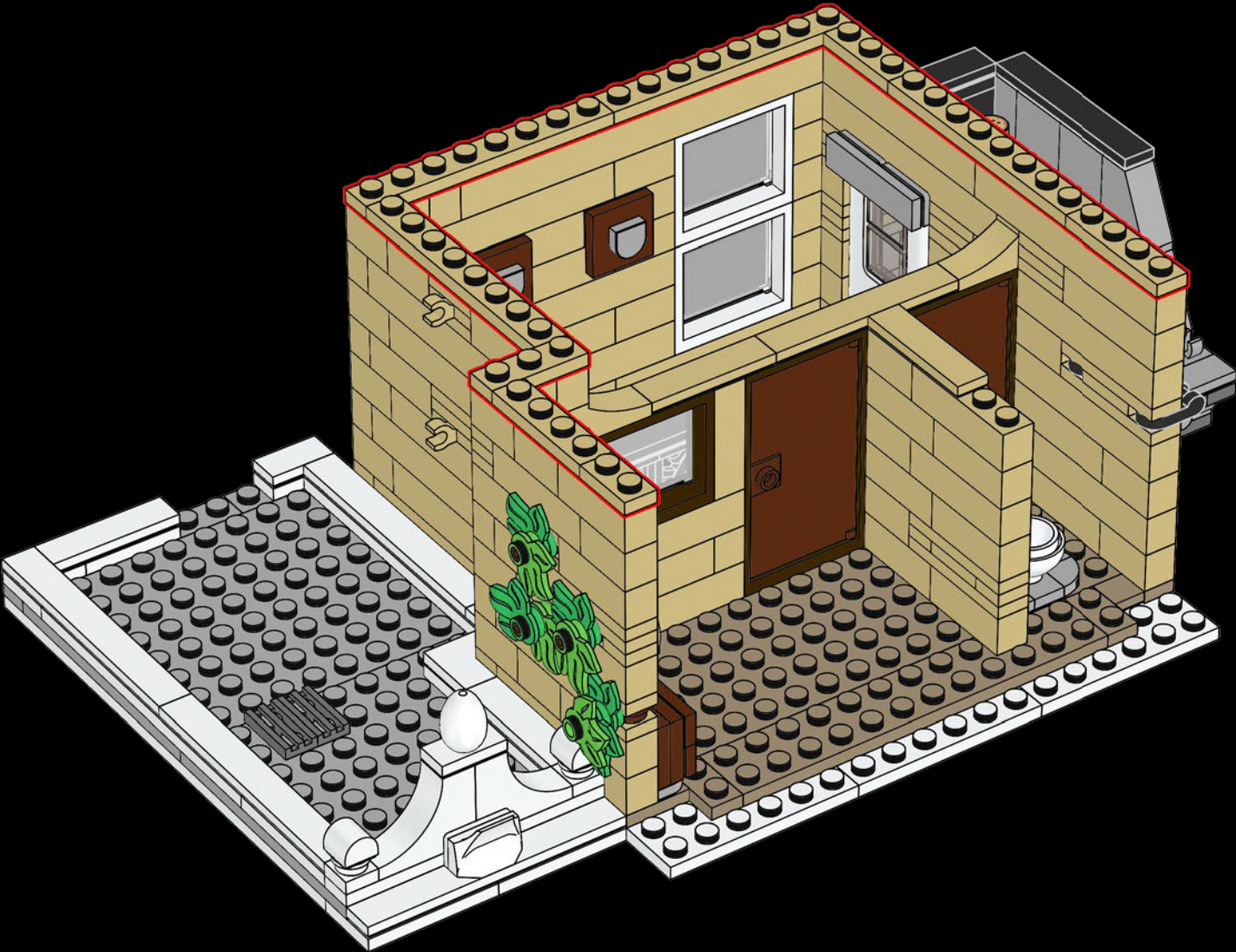



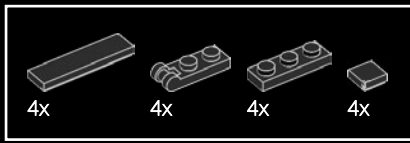

347

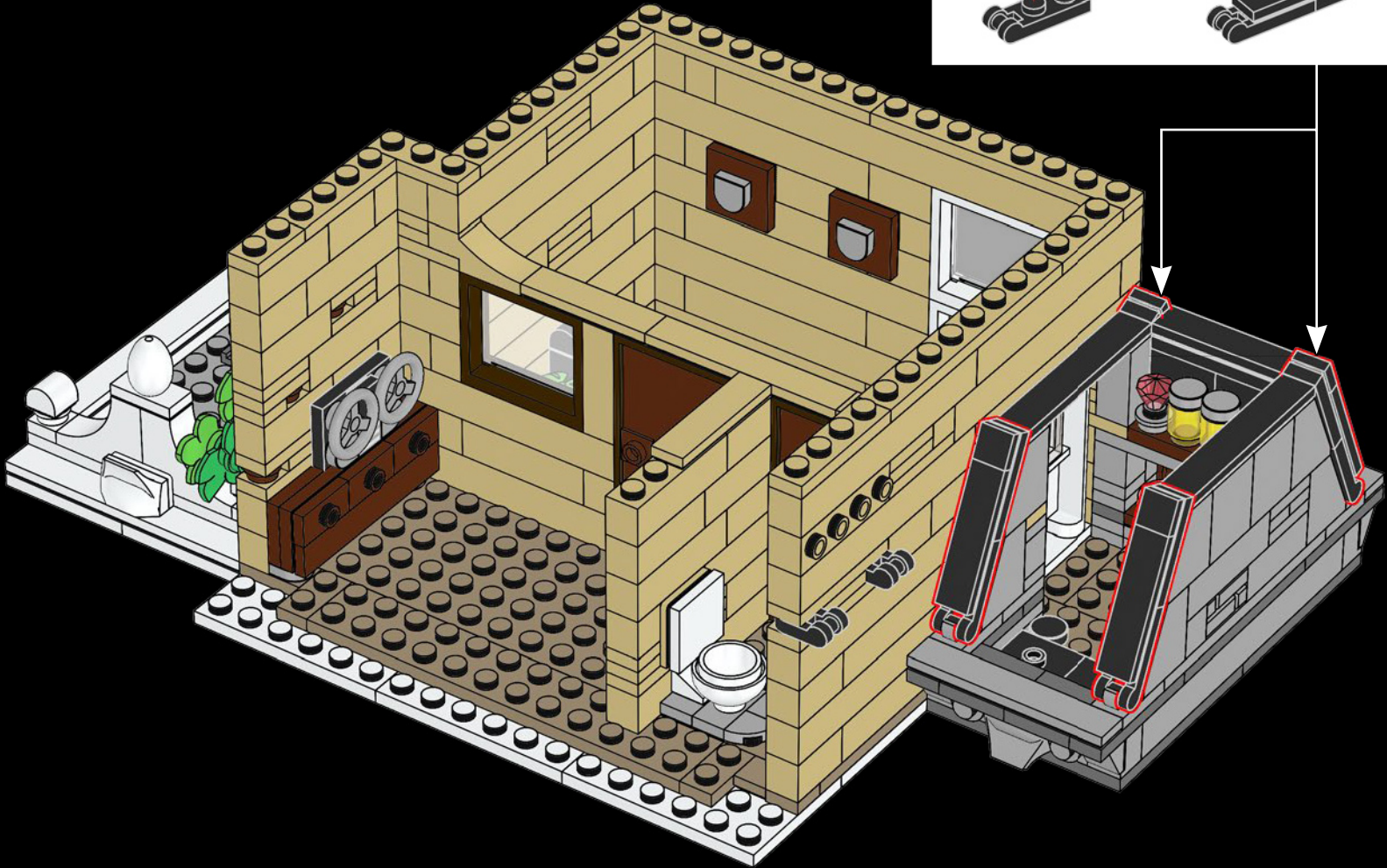
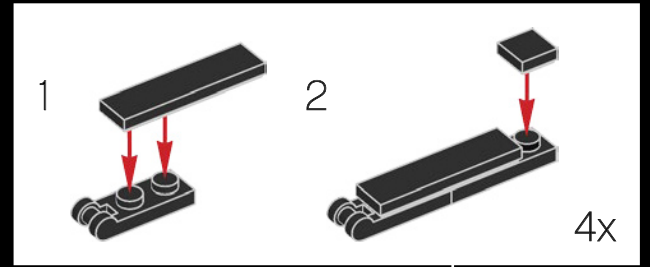

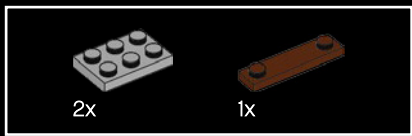

348

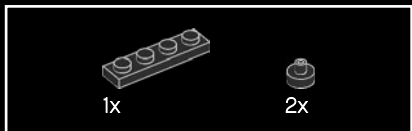
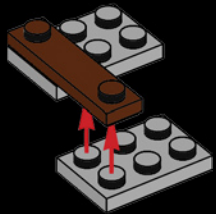

349

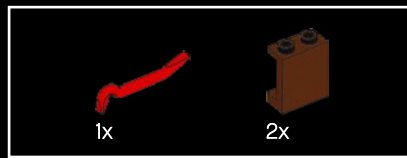
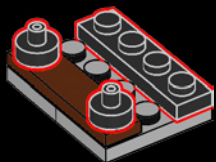

350

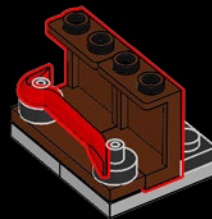

351

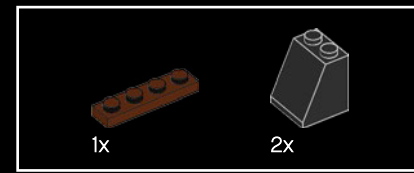

352

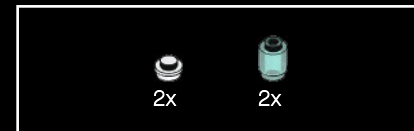
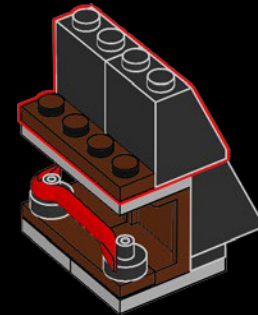

353

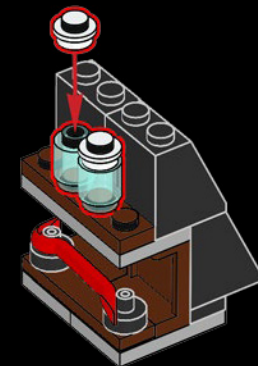



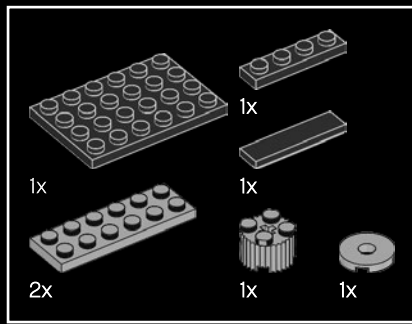

354

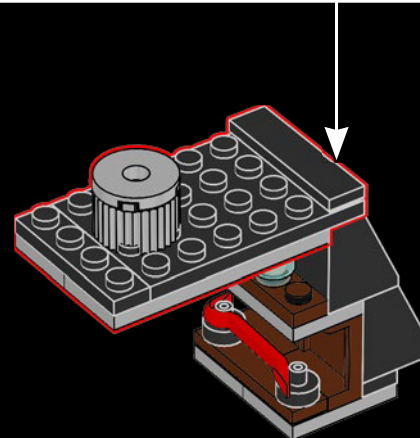
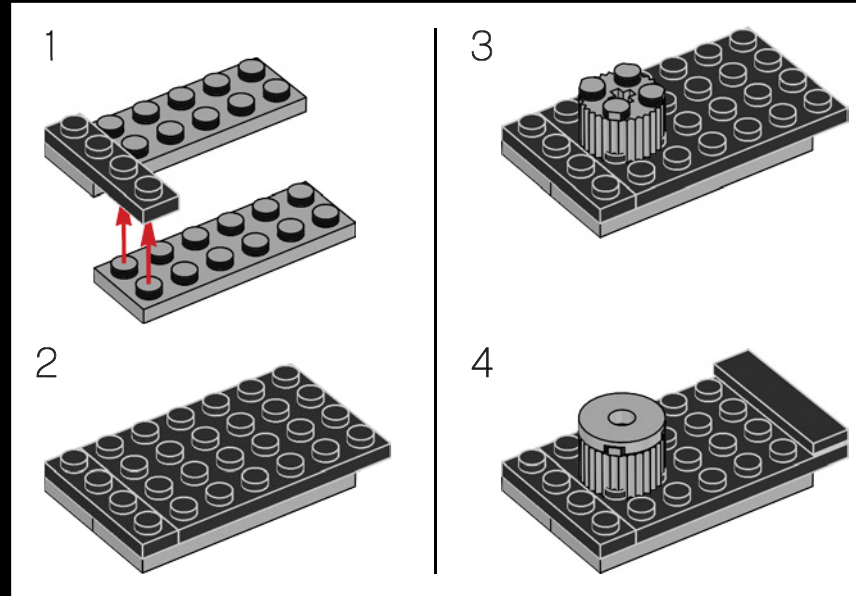

355

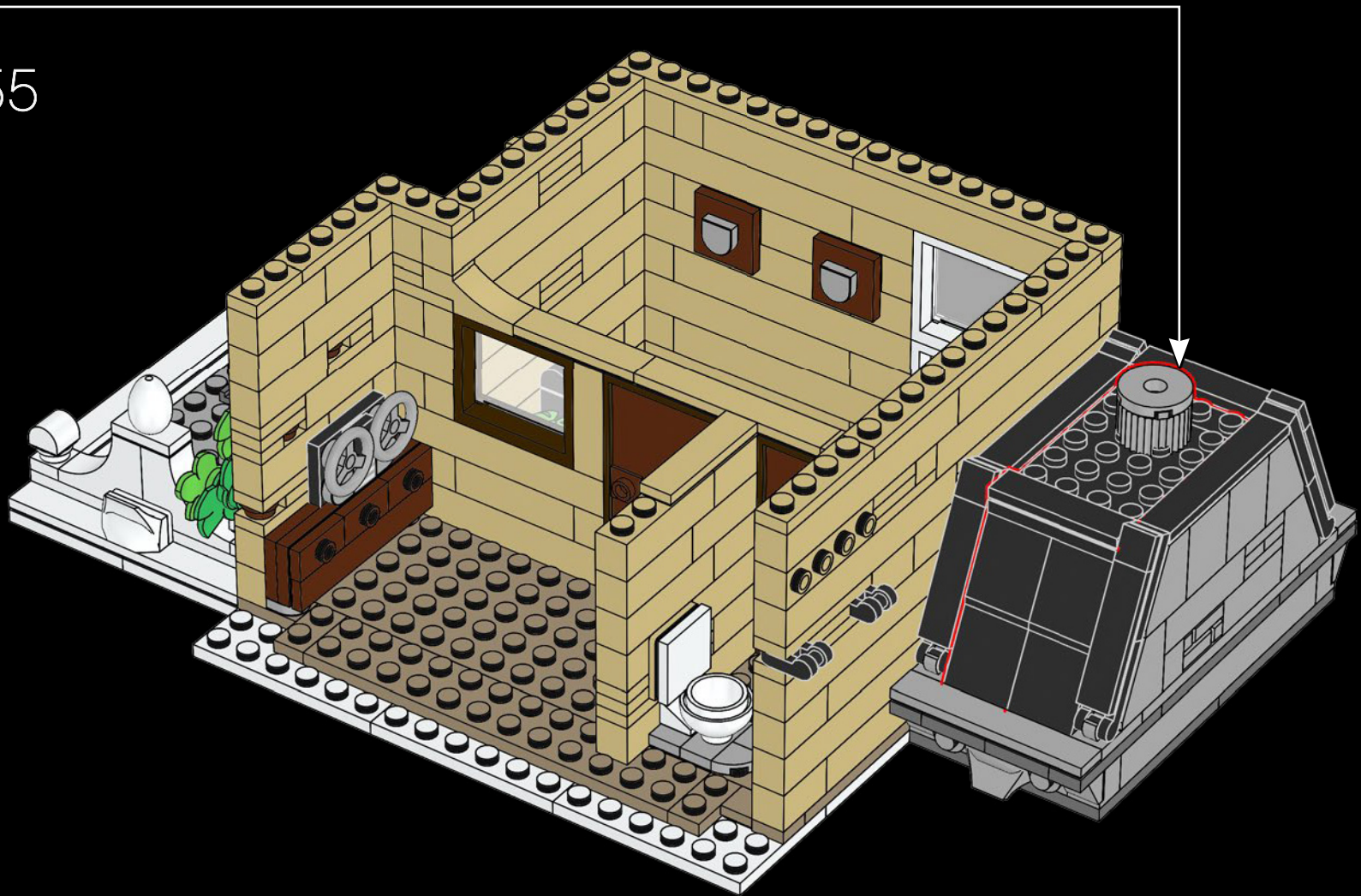





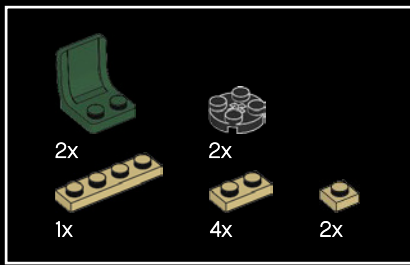

356

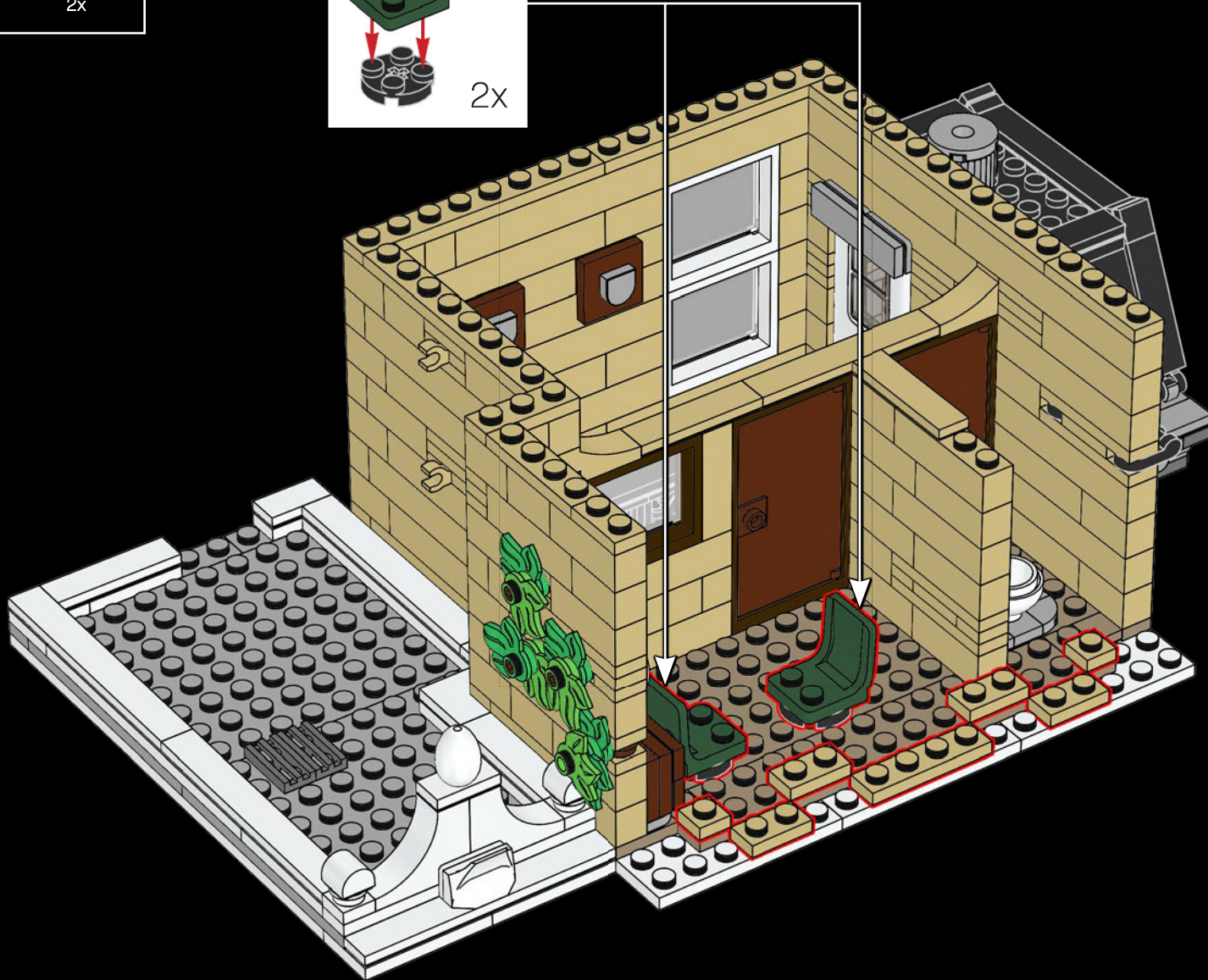
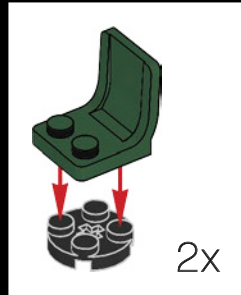





357

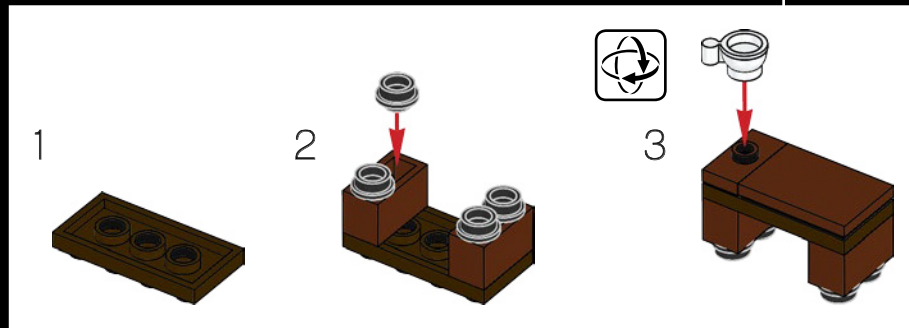
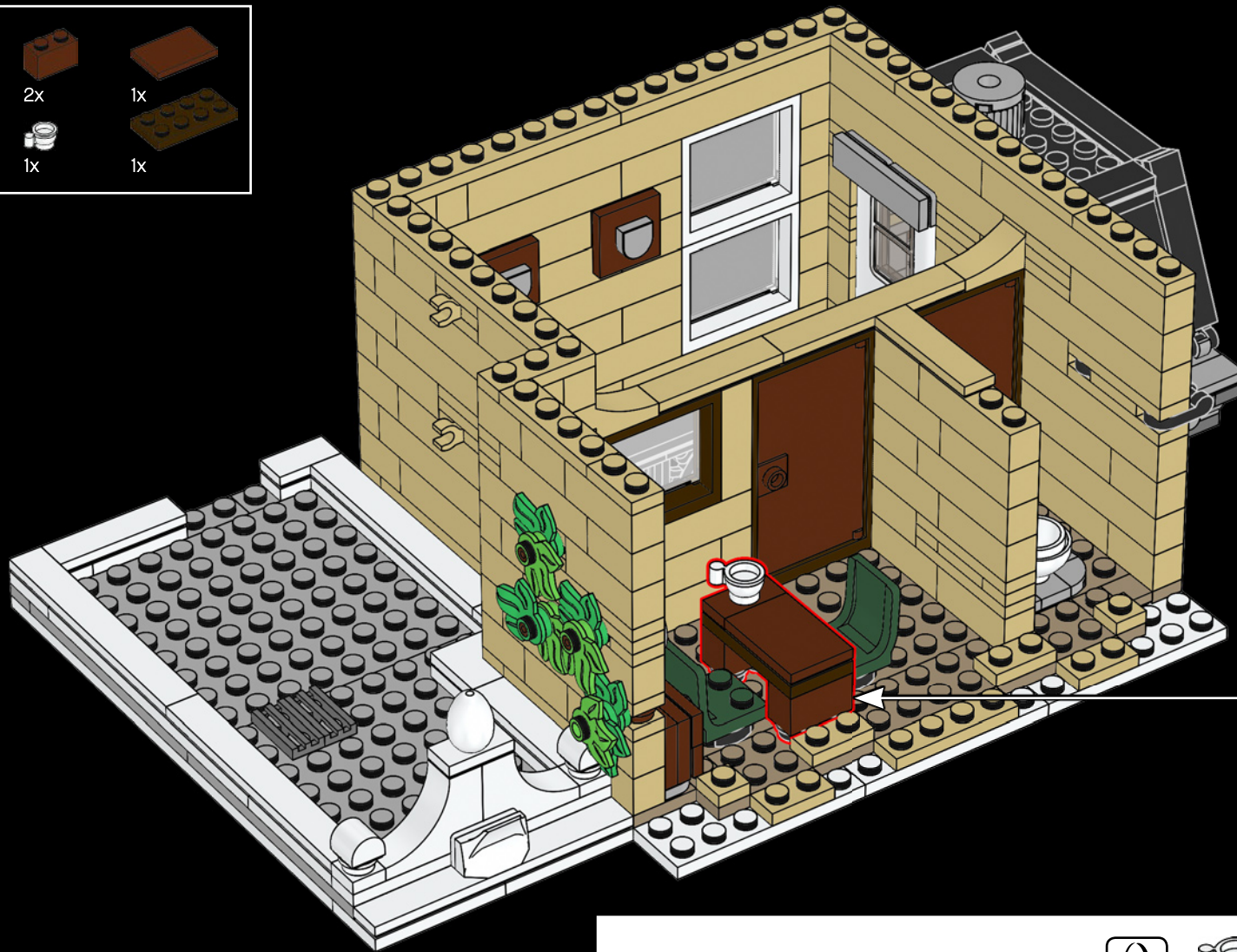

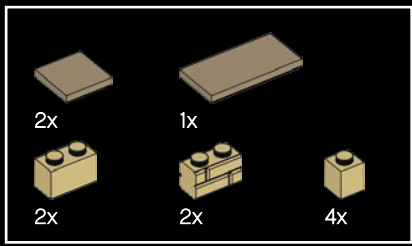

358

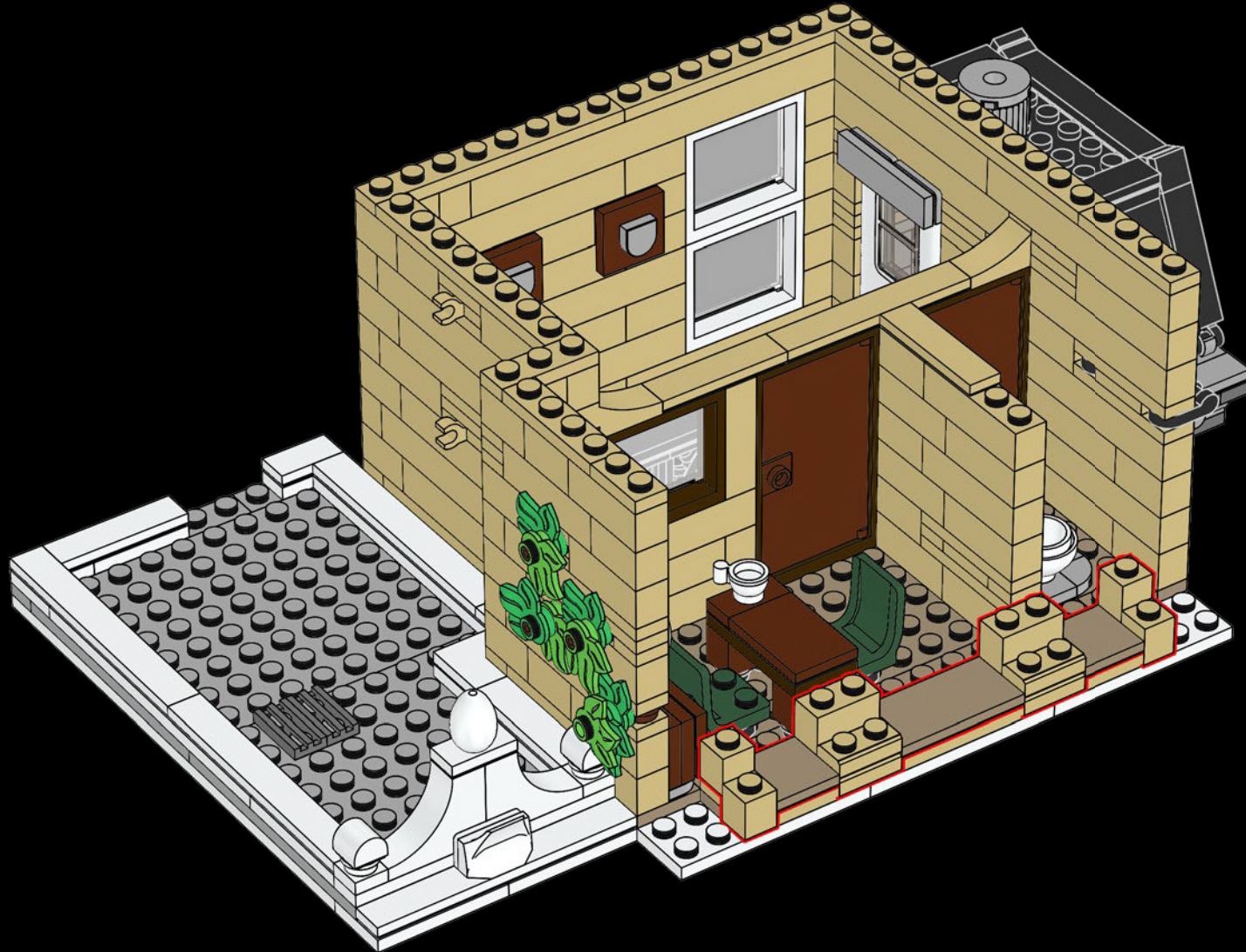



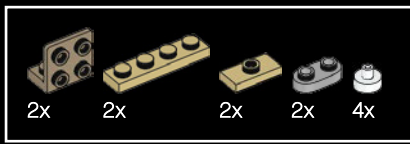

359

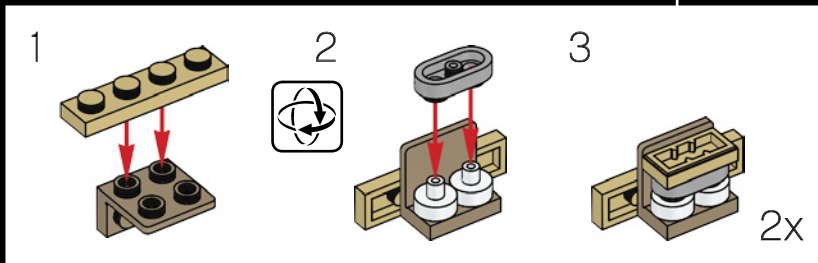
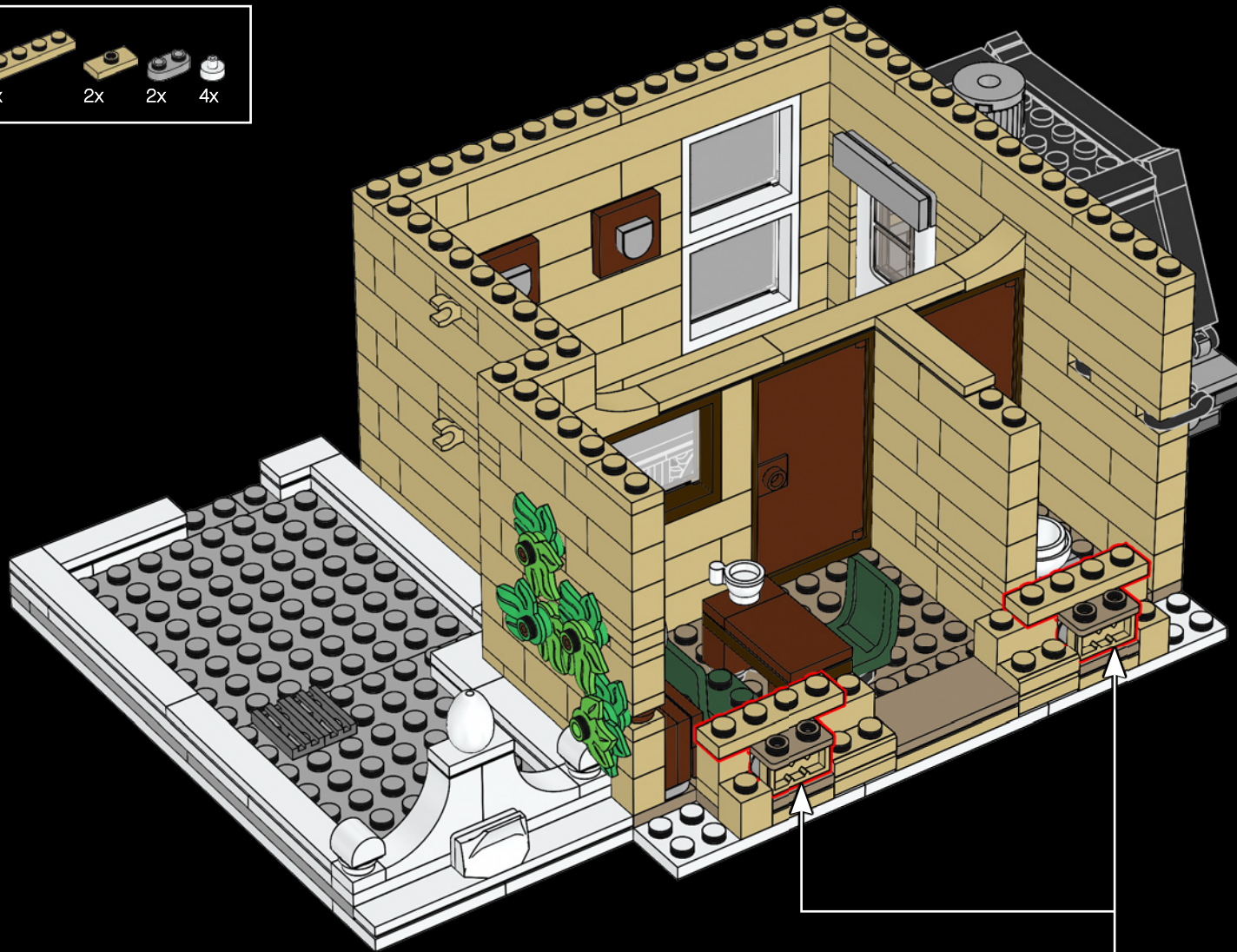

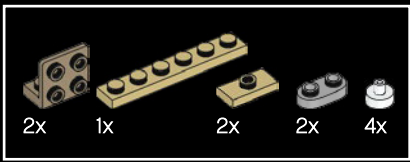

360

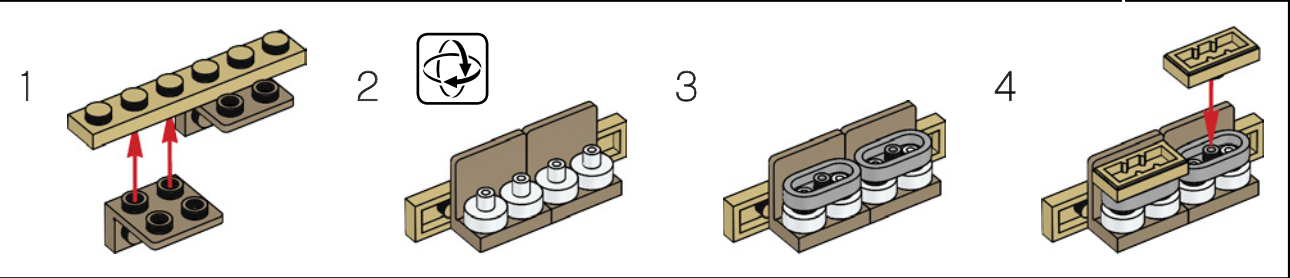
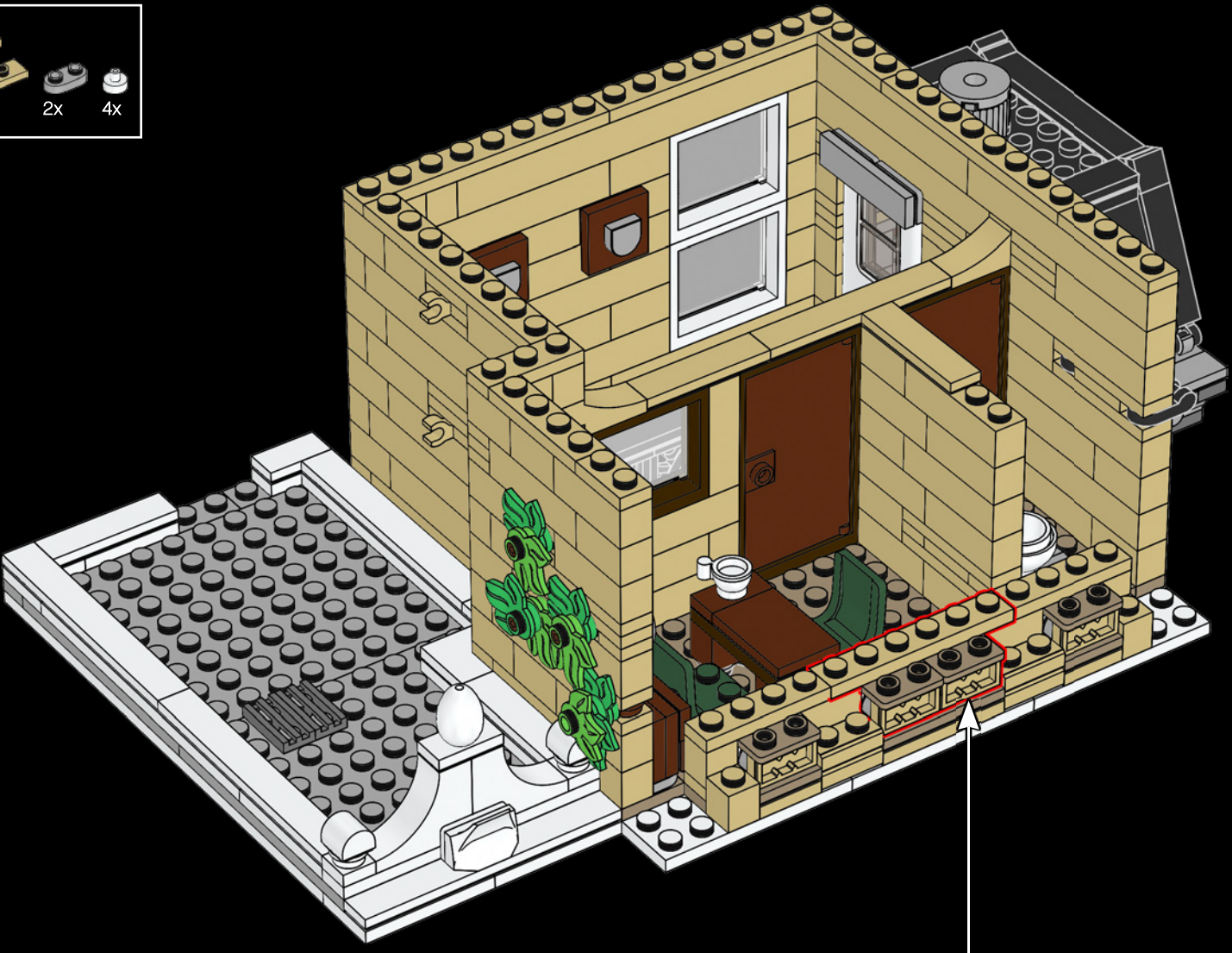



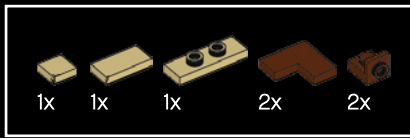

361

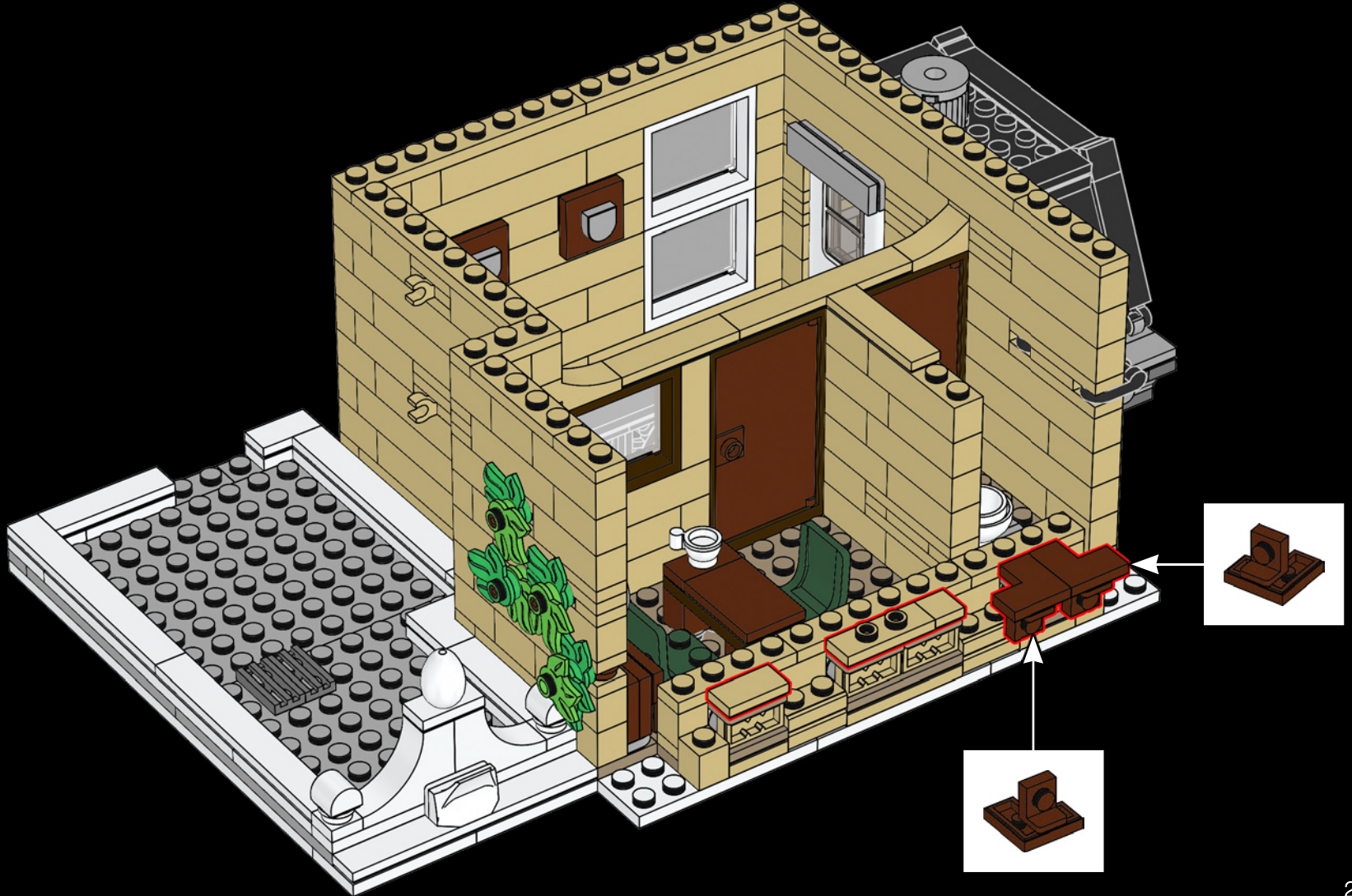

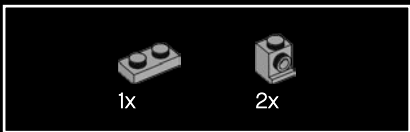

362

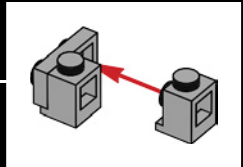
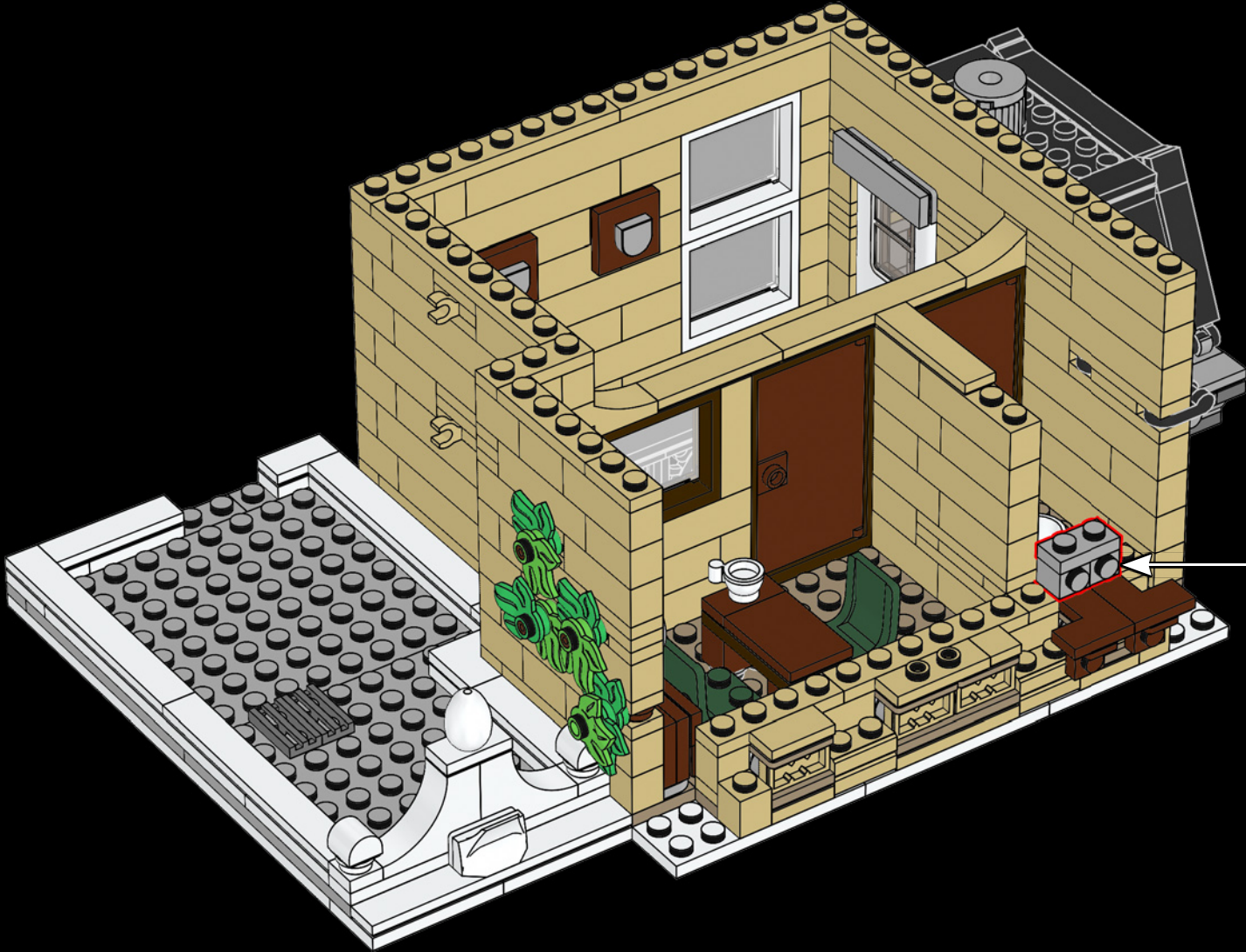



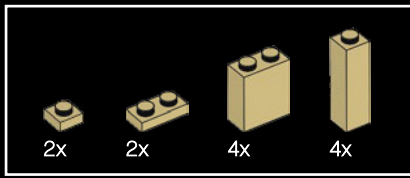

363

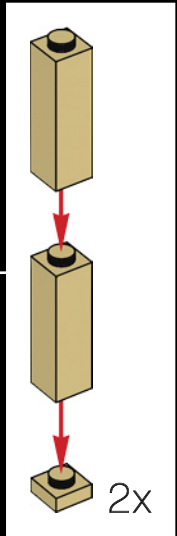
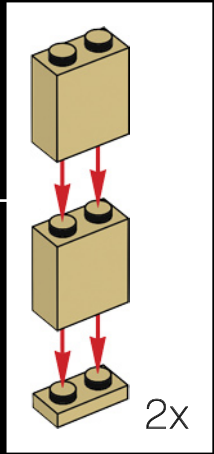
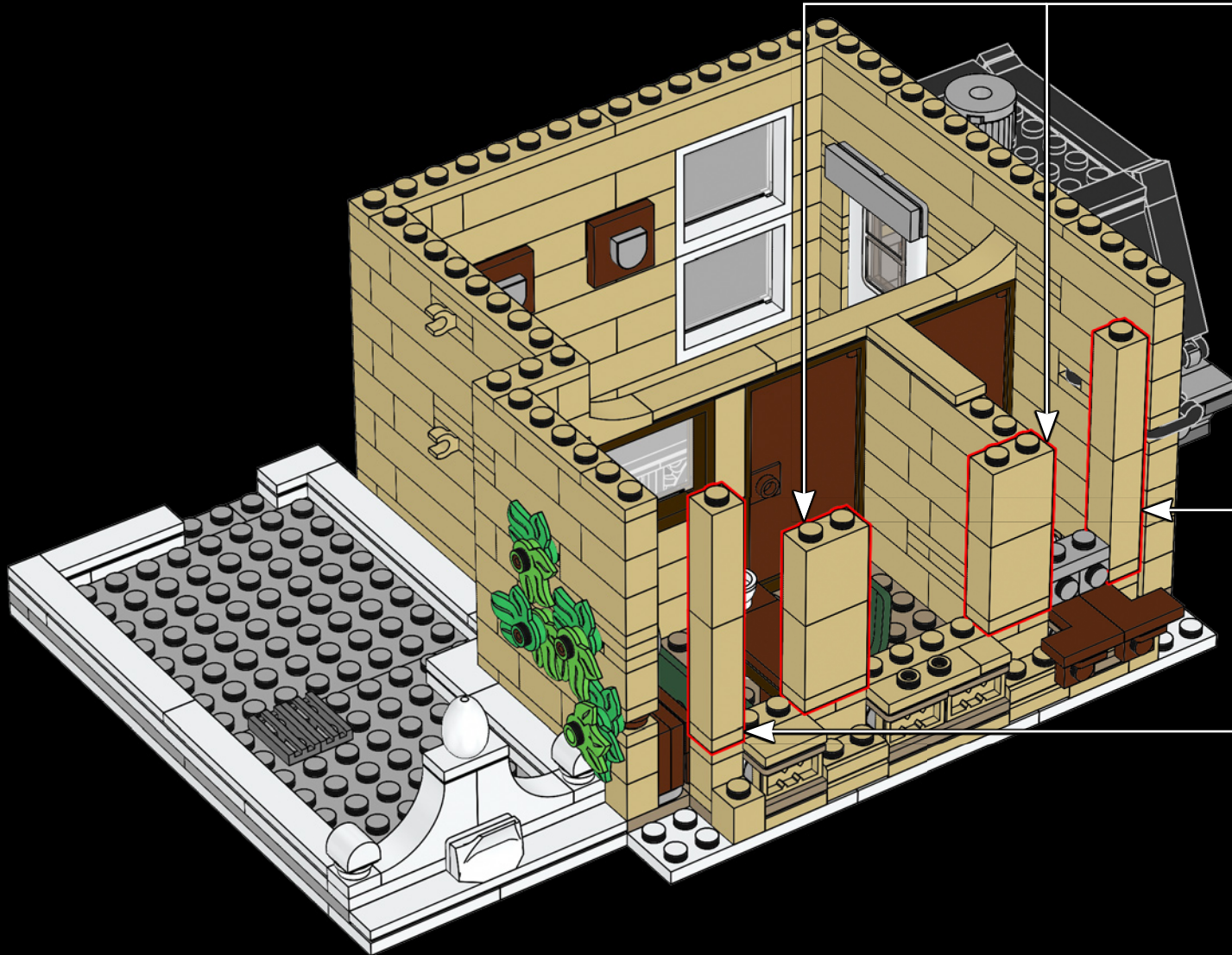

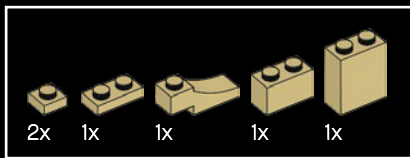

364

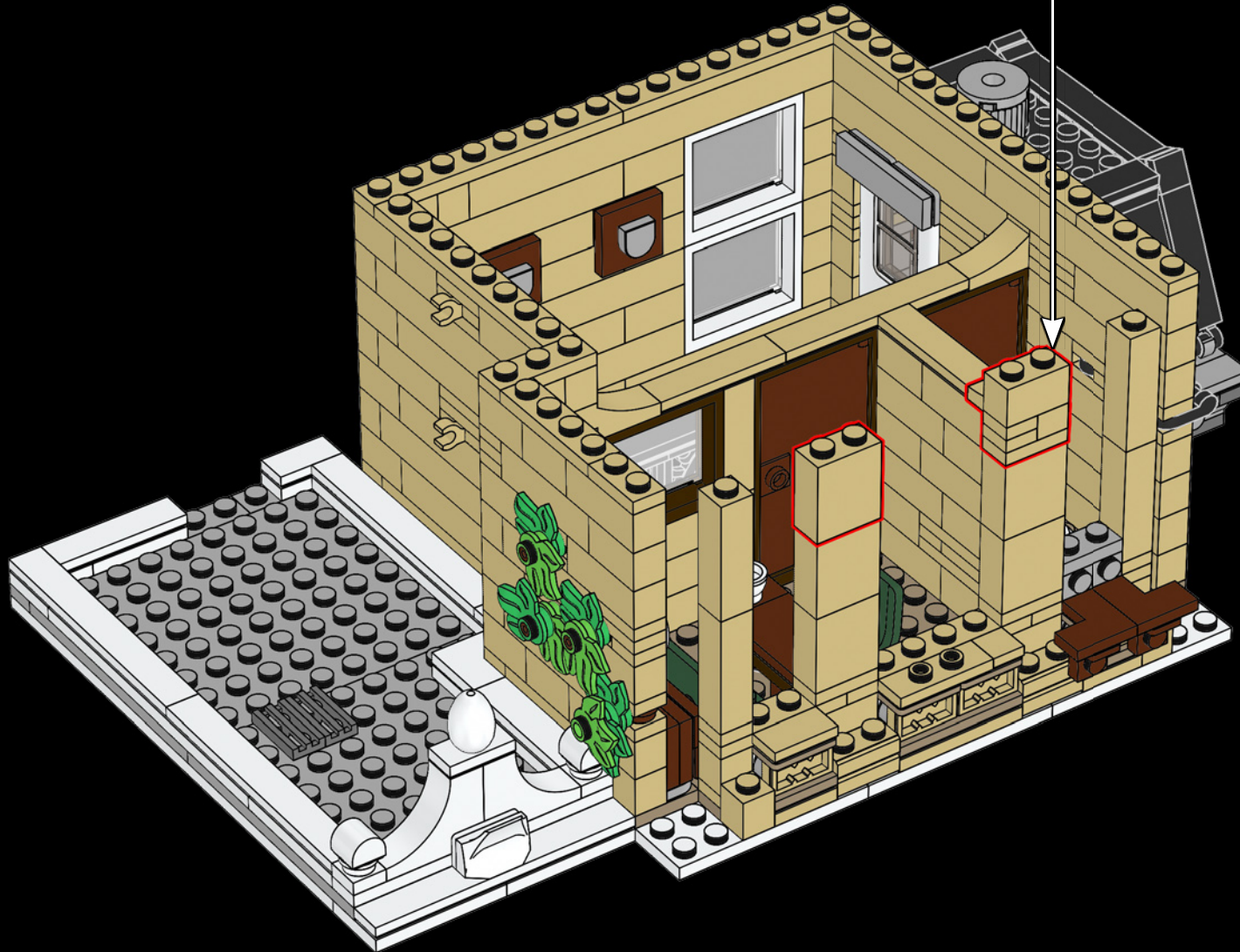
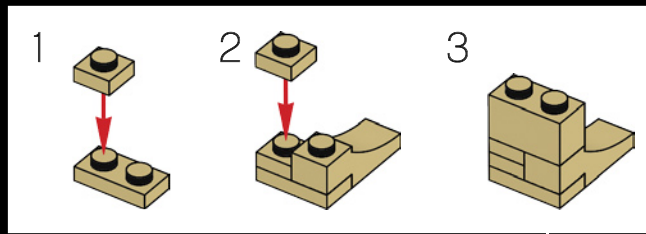



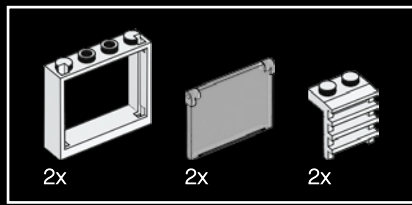

365

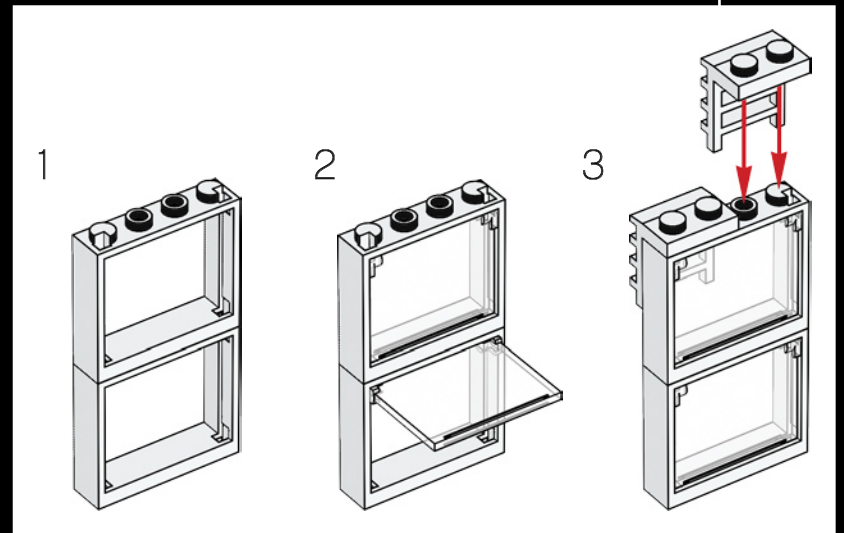
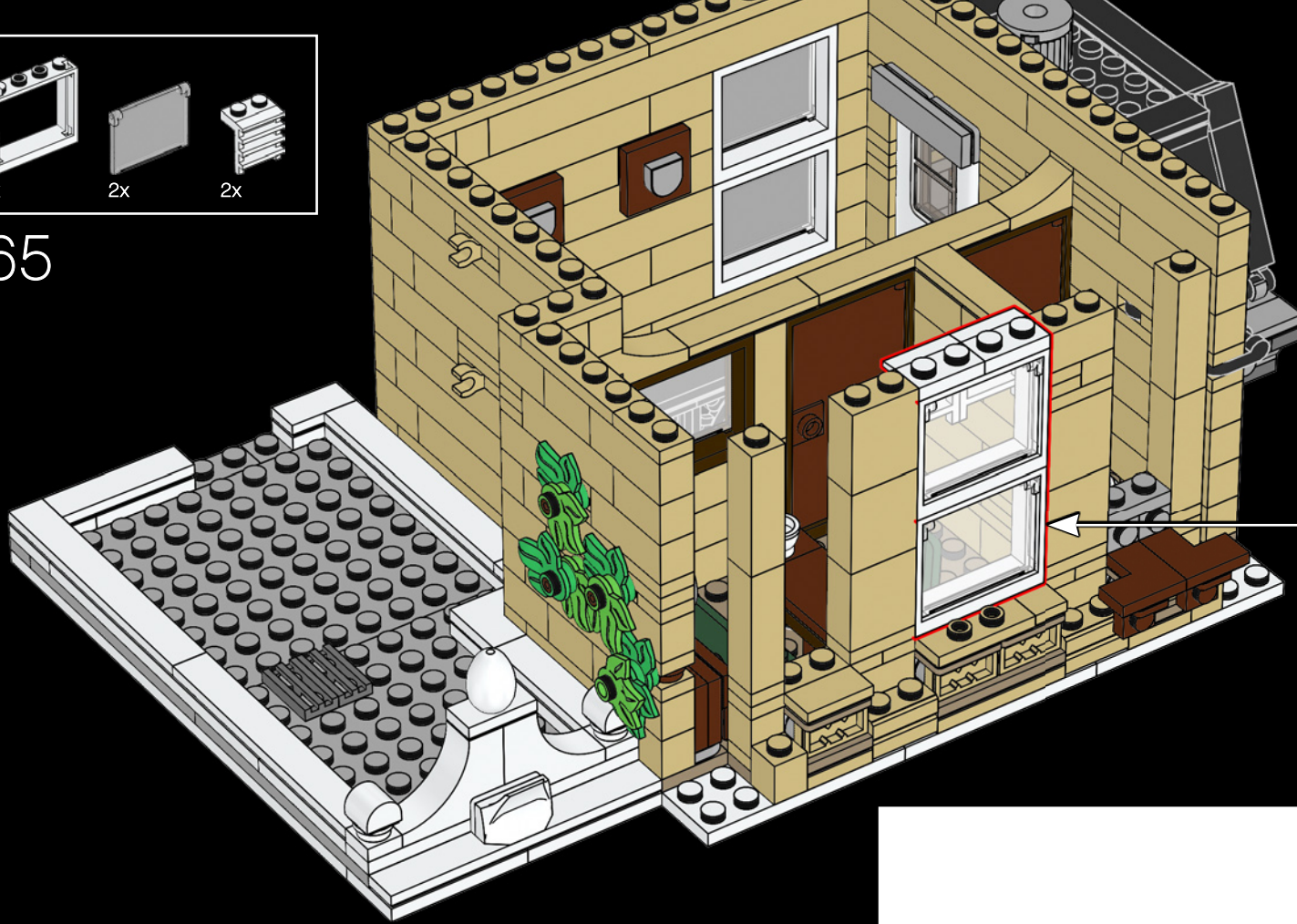

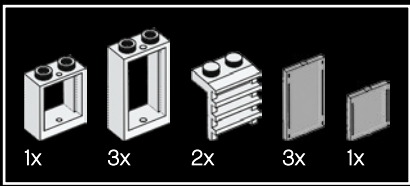

366

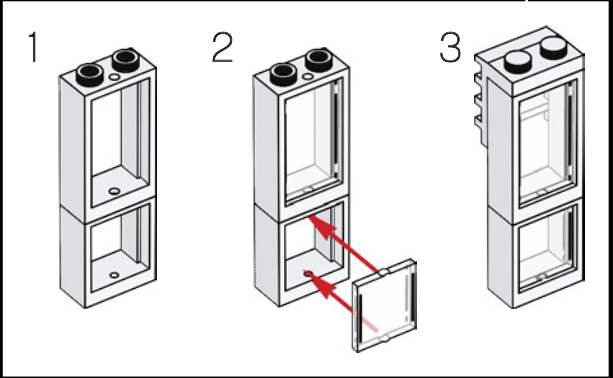
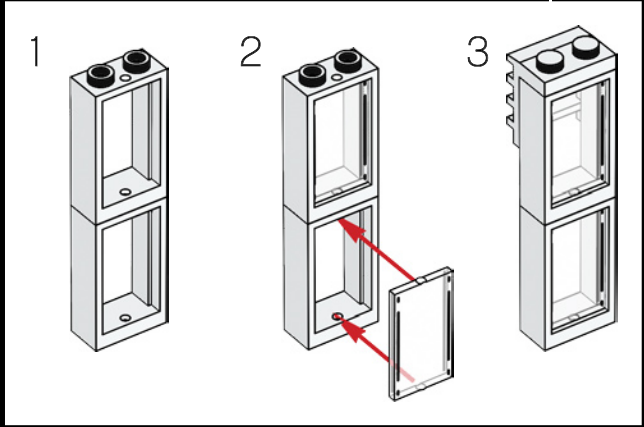
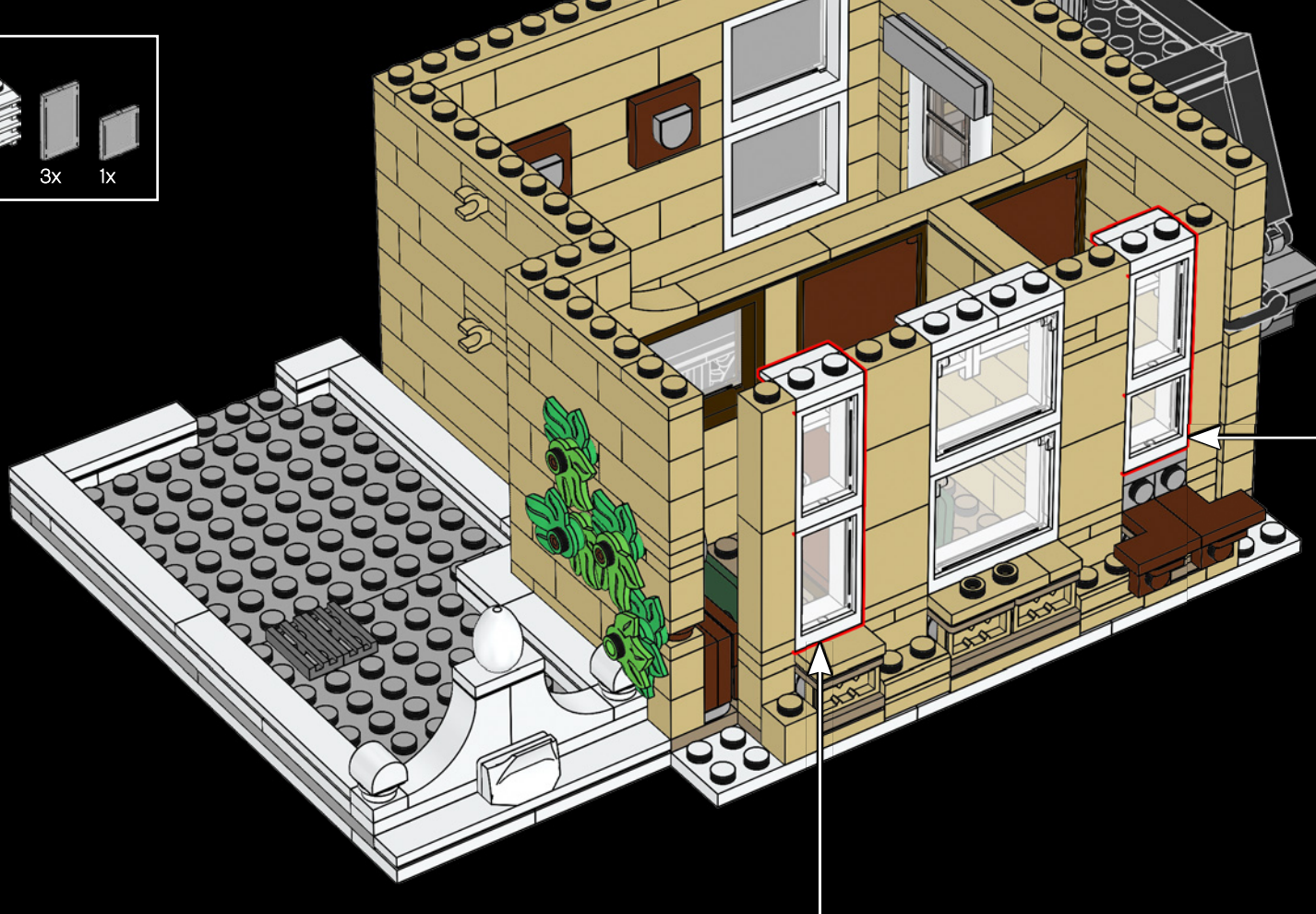



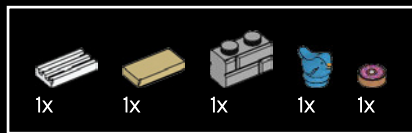

367

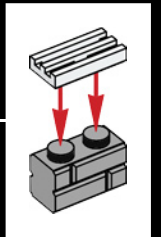
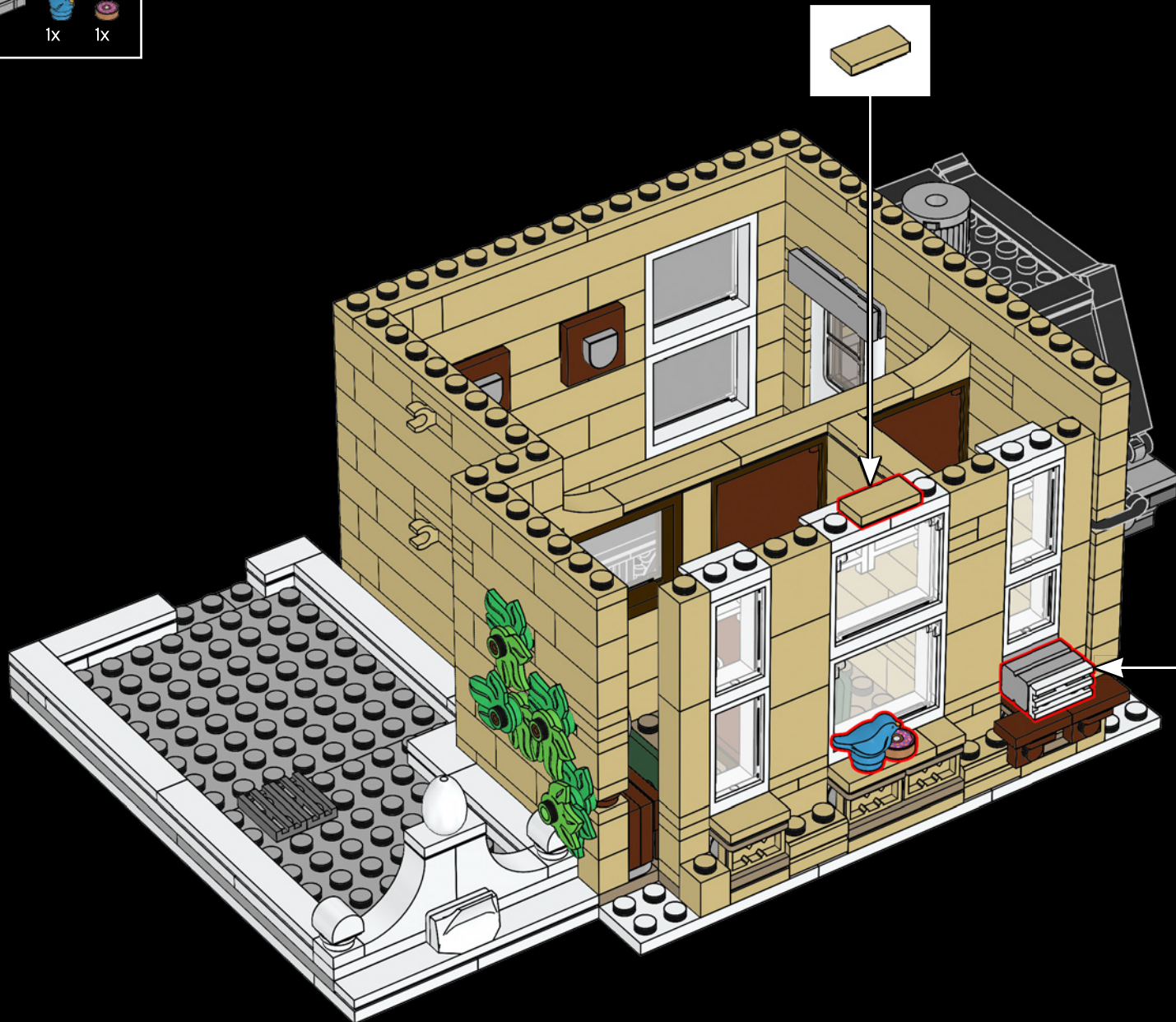

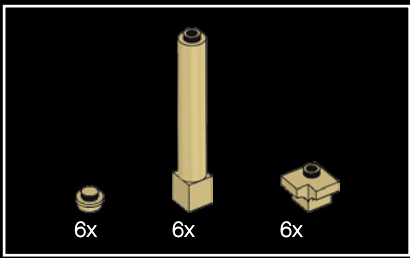

368

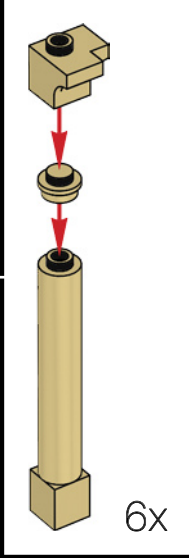
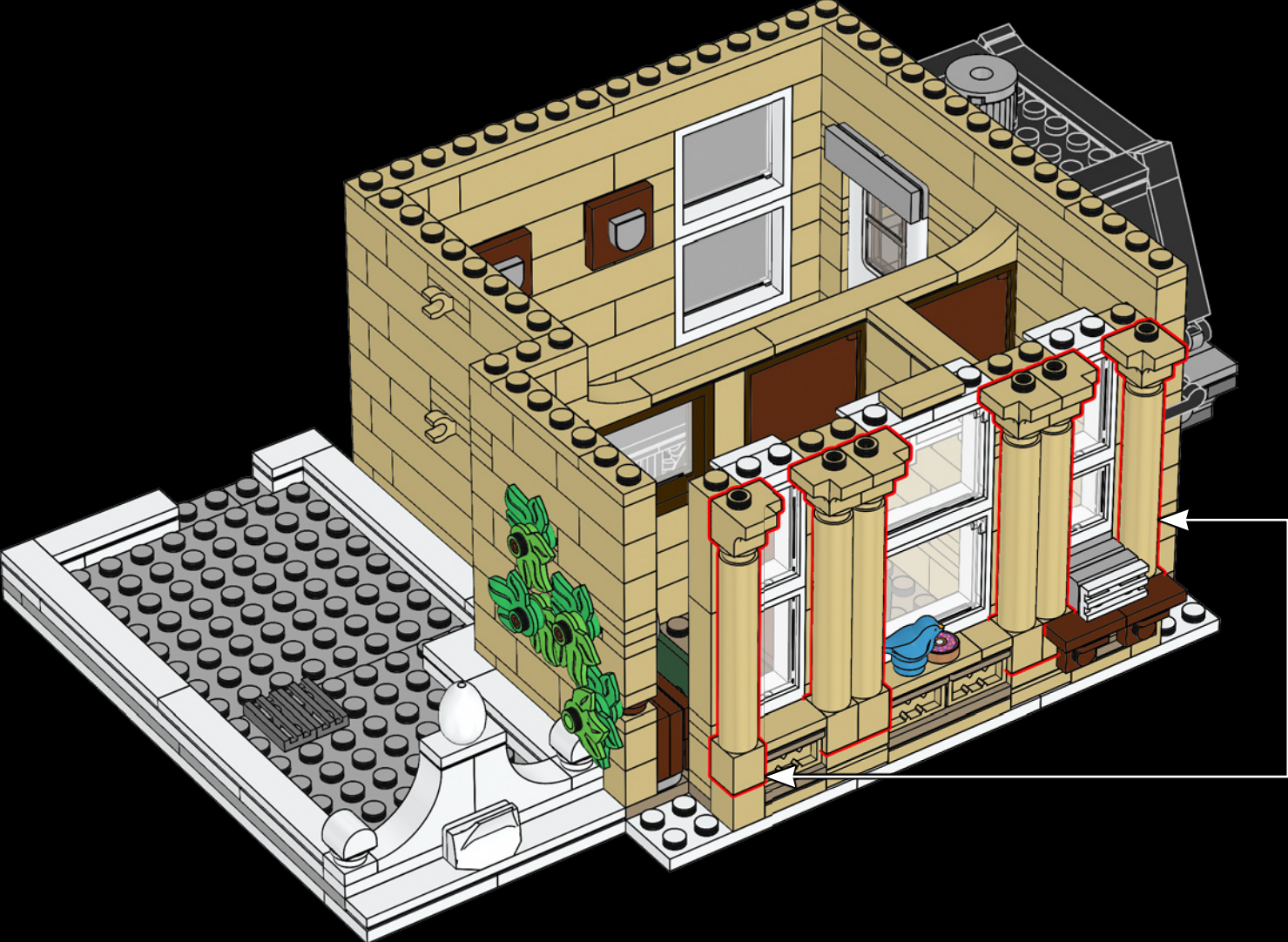



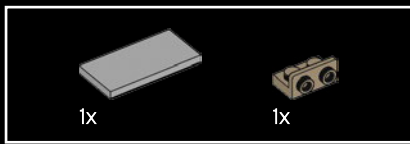

369

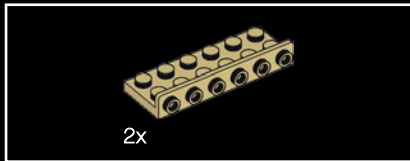
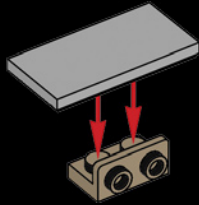

370

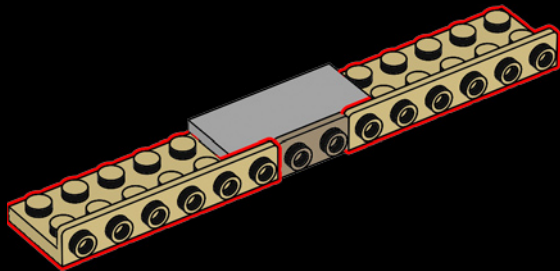

371

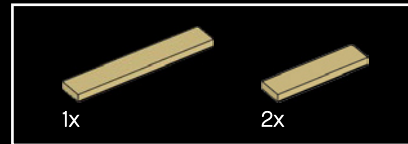
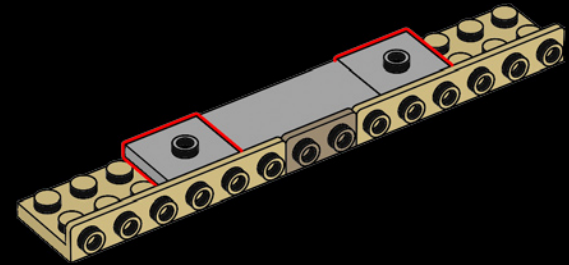

372

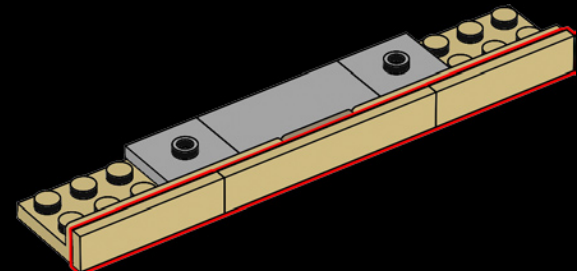

373

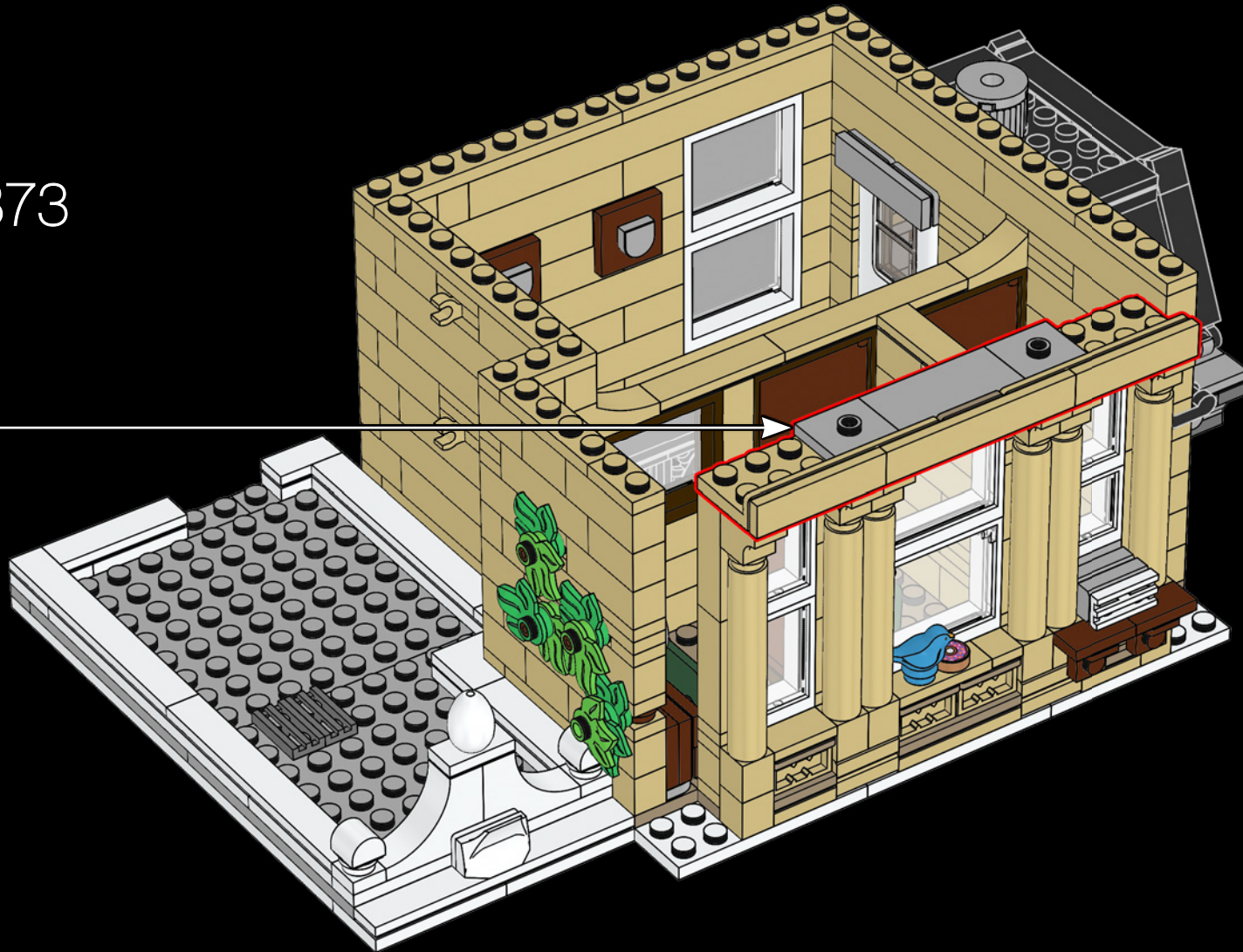



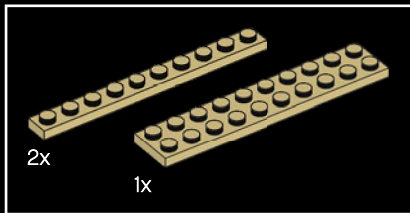
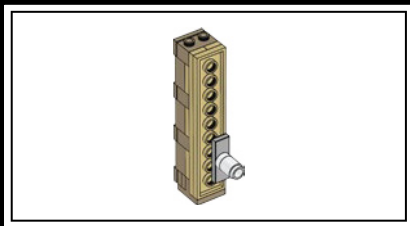

374

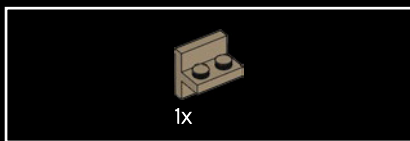
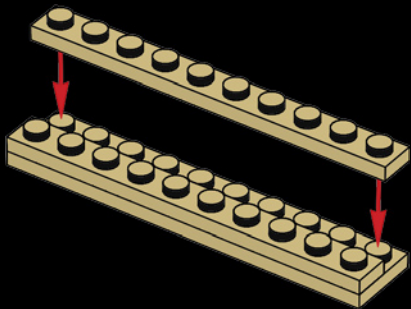

375

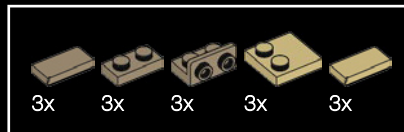
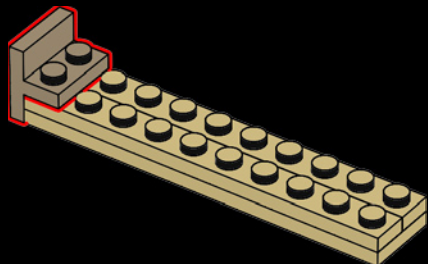

376

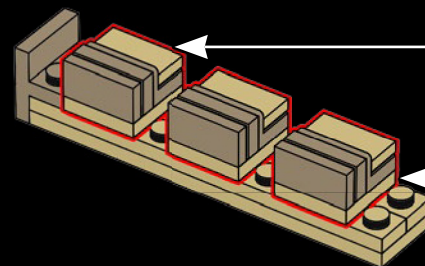
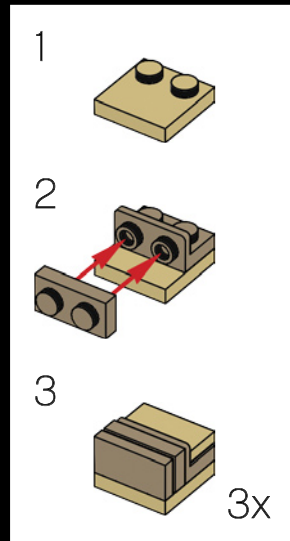



377

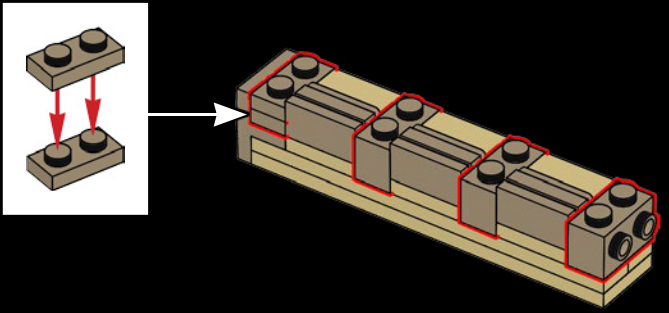

378

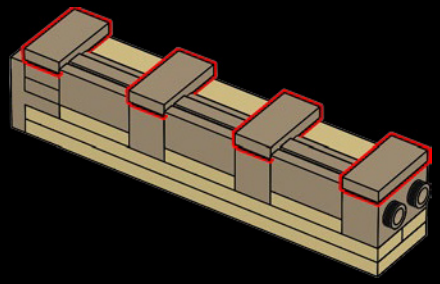

379

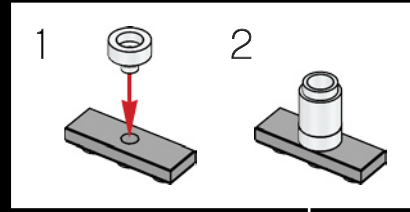
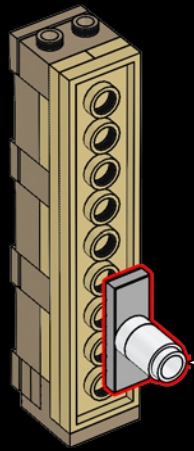



380

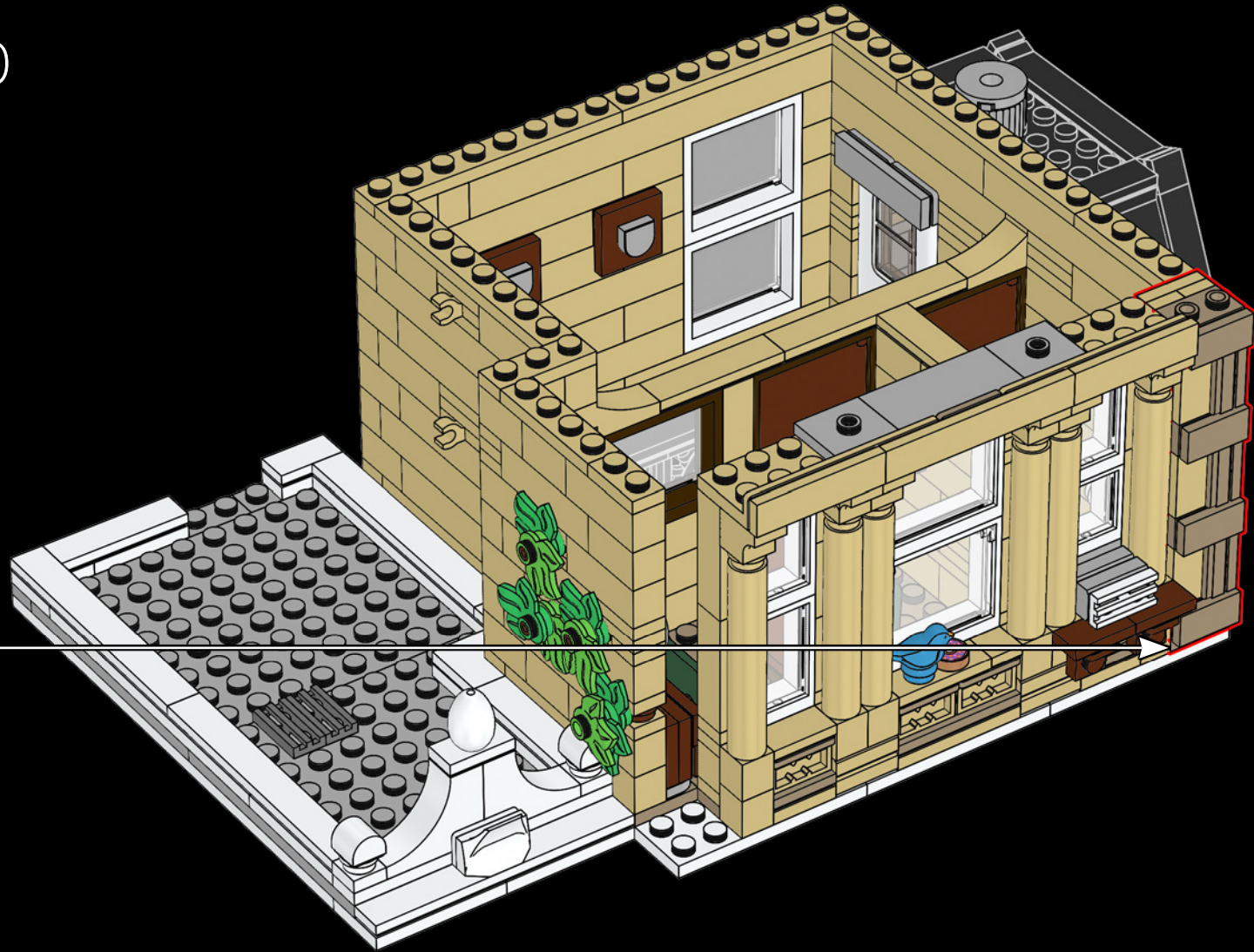

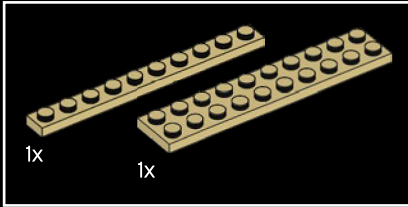
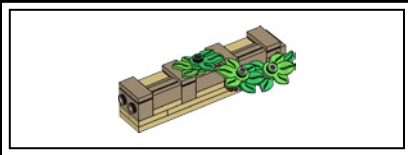

381

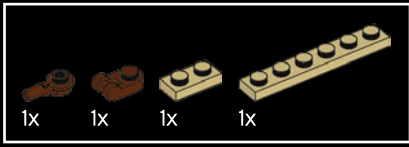
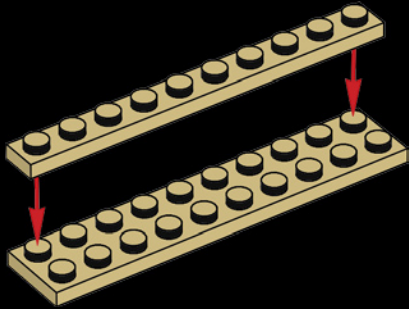

382

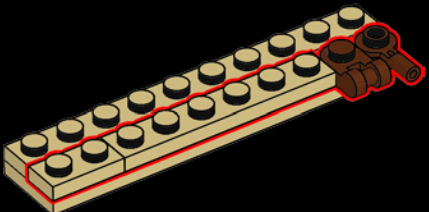

383

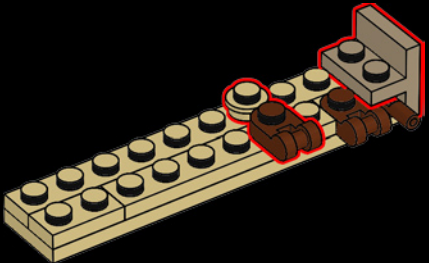



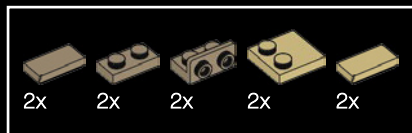

384

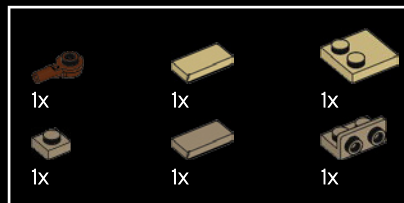
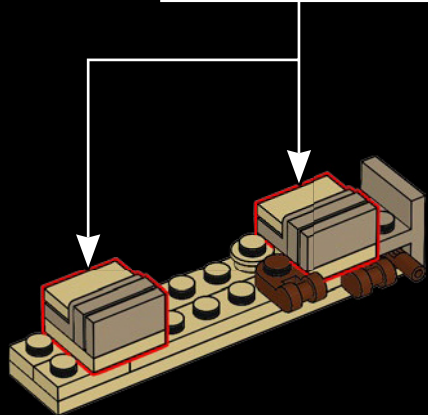
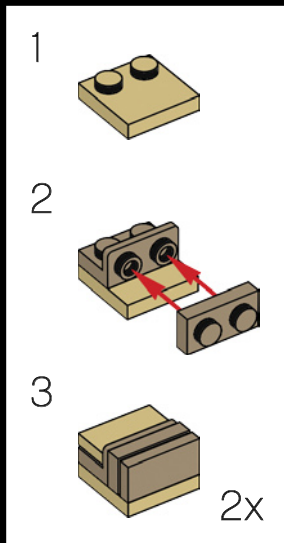

385

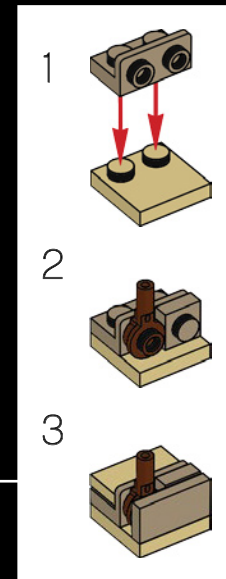
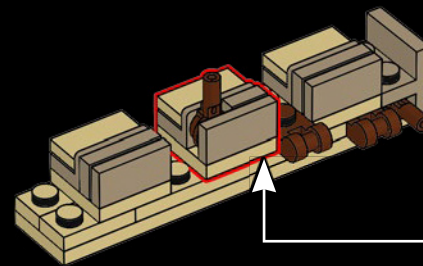

386

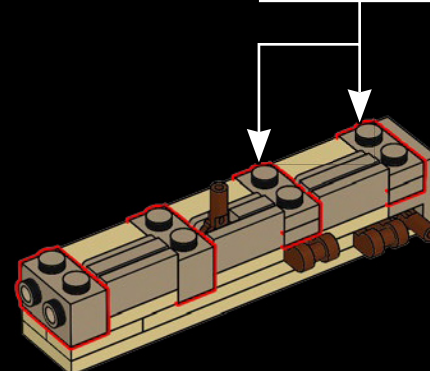
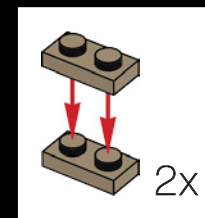



387

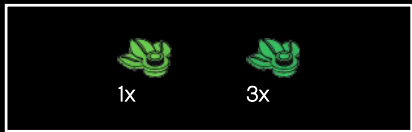
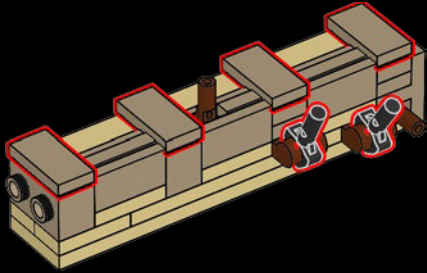

388

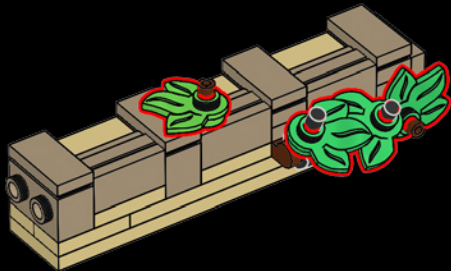

389

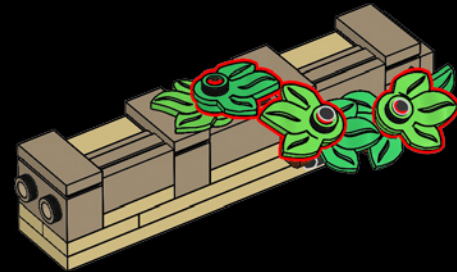



390

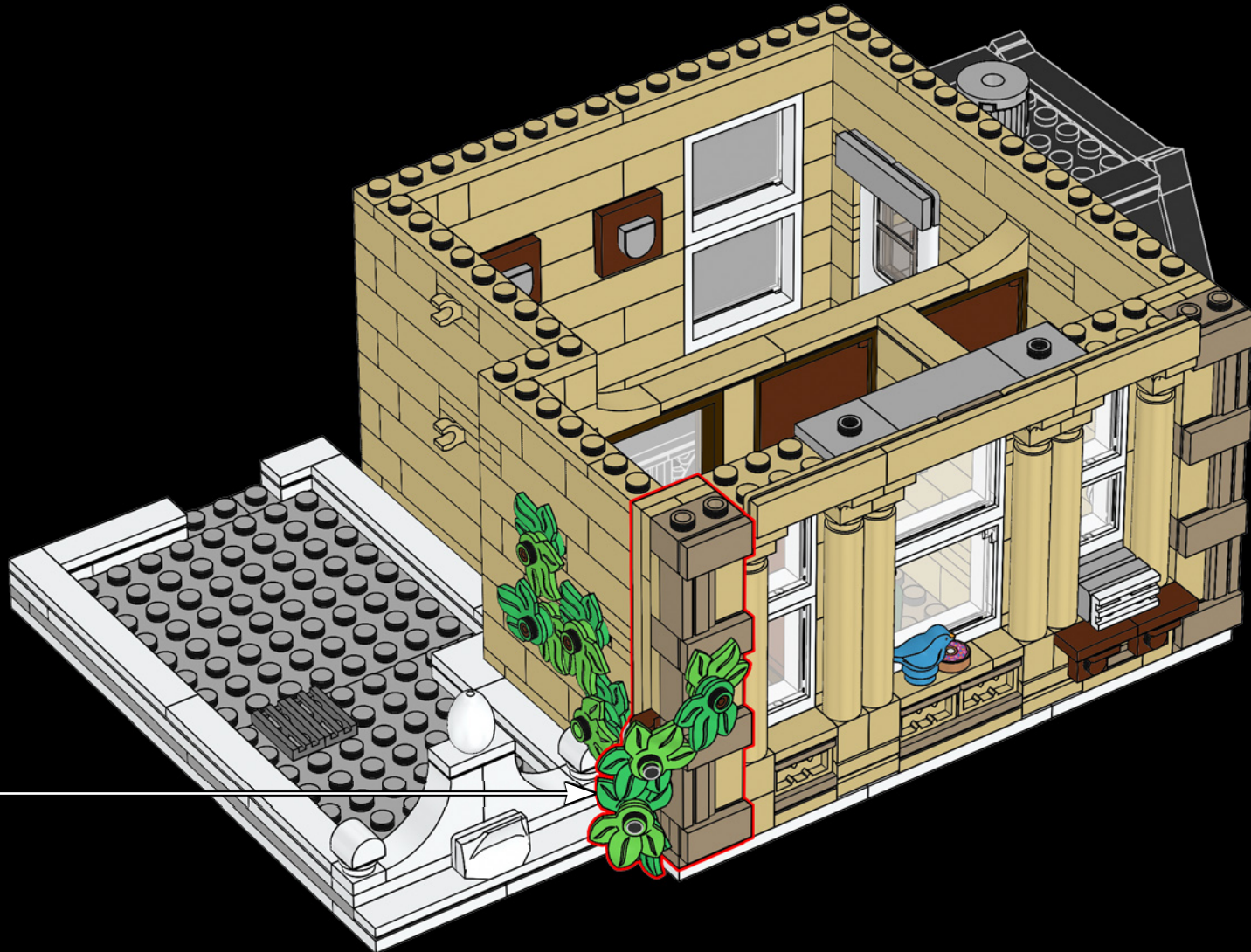

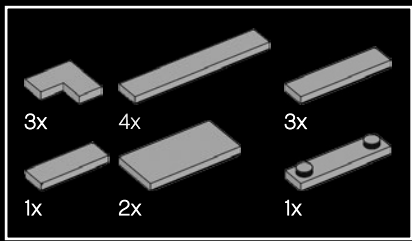

391





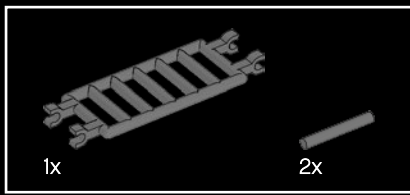

392

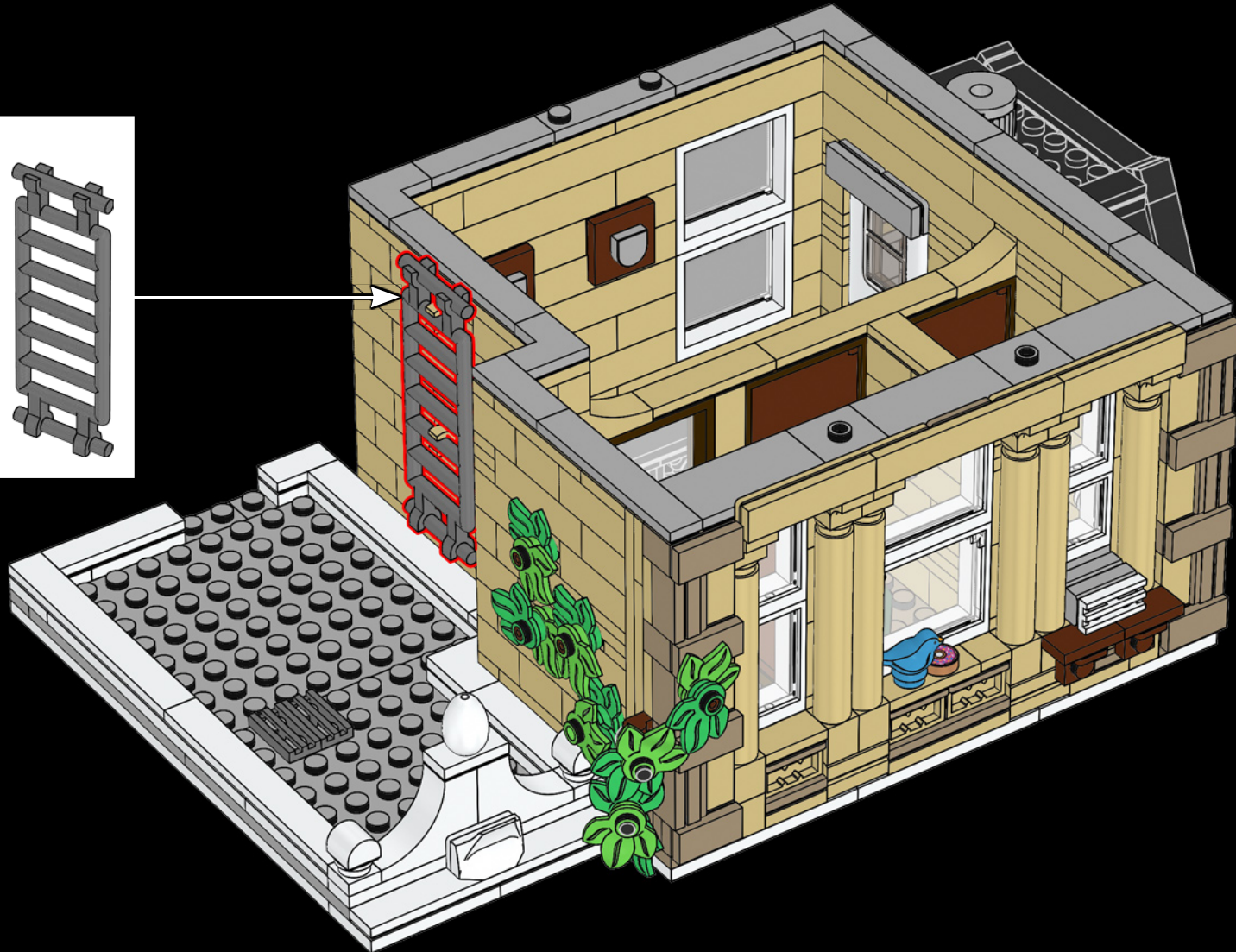
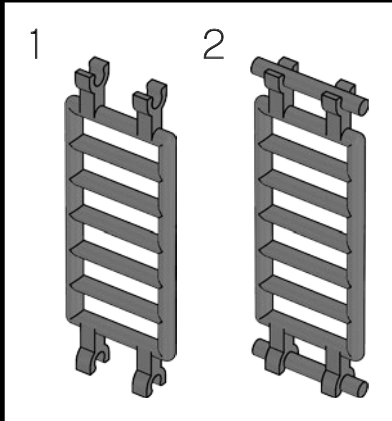

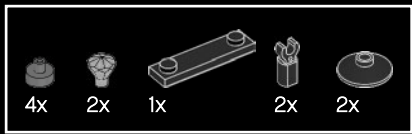

393

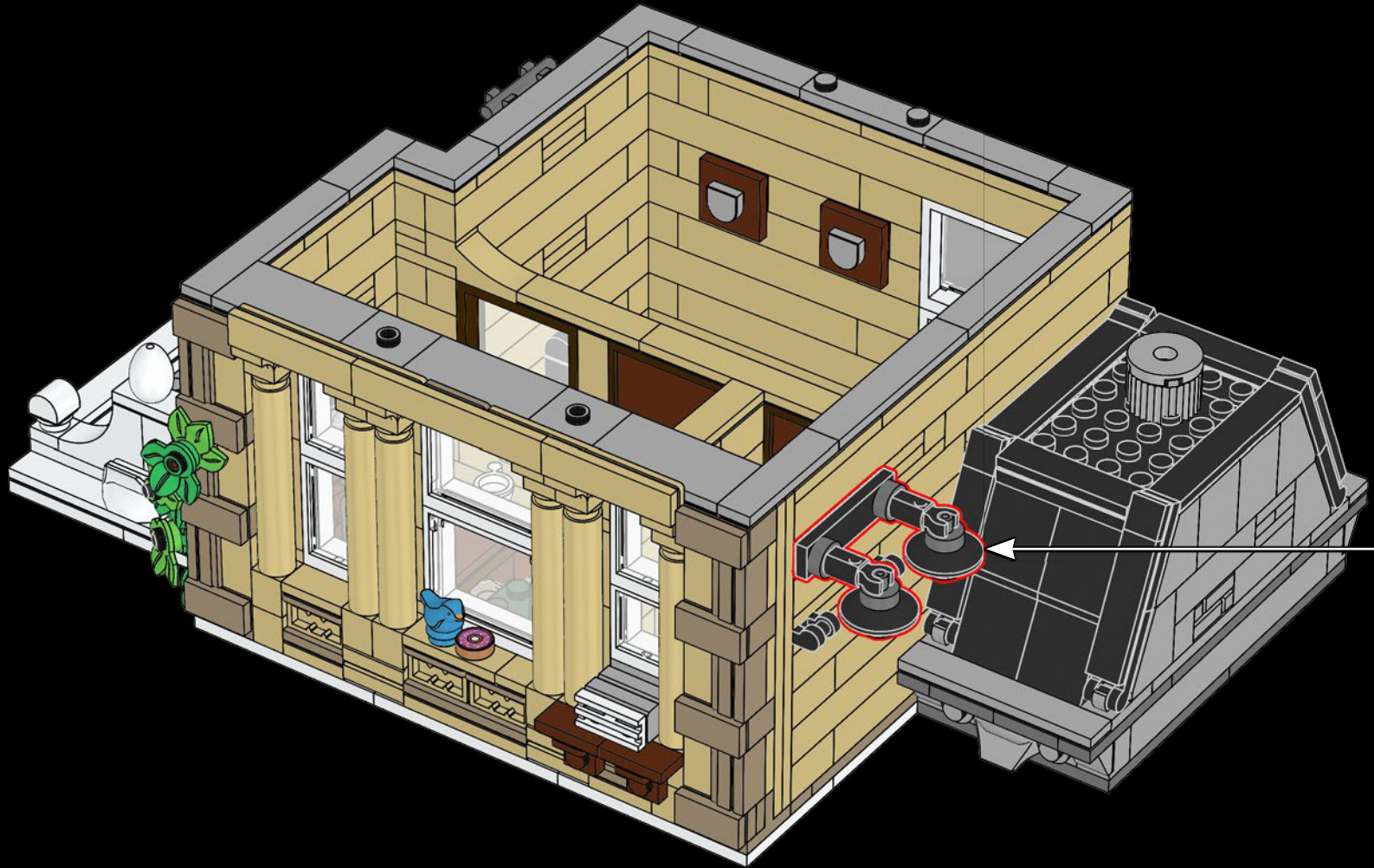
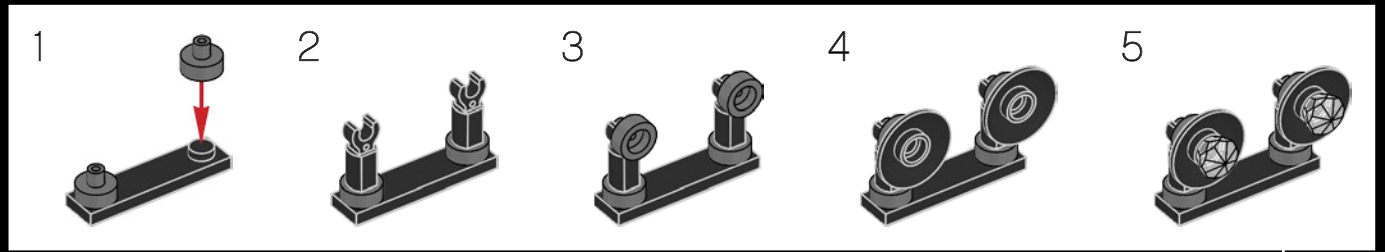



394

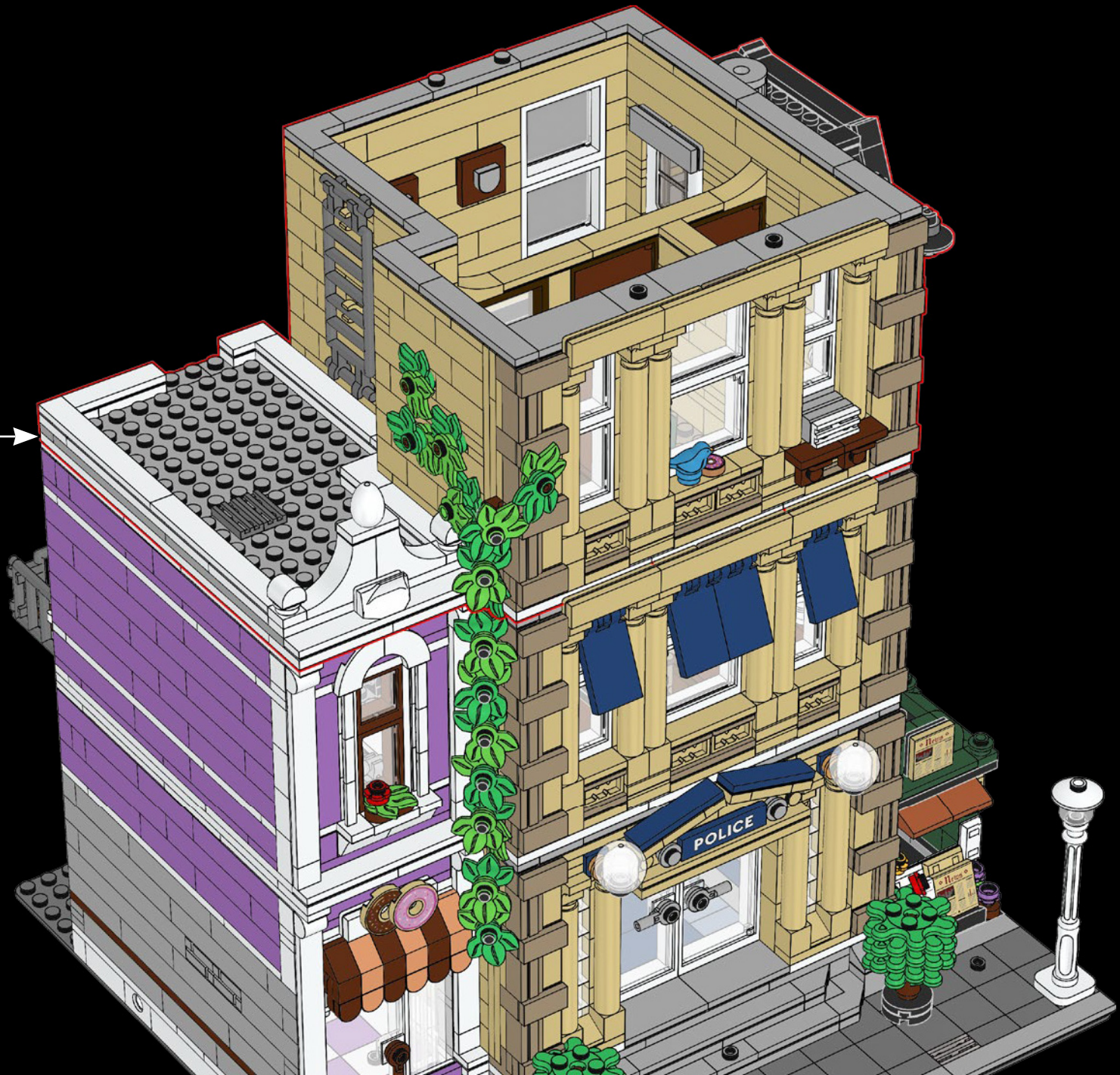

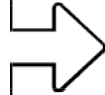



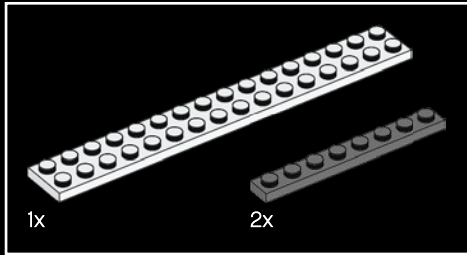
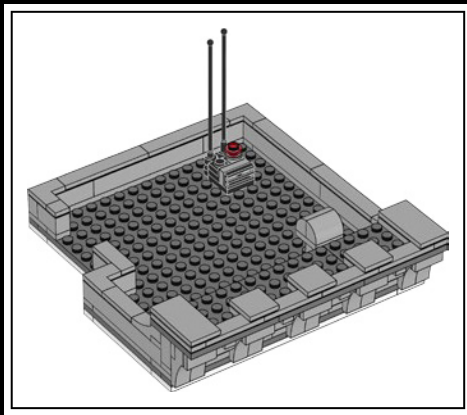

395

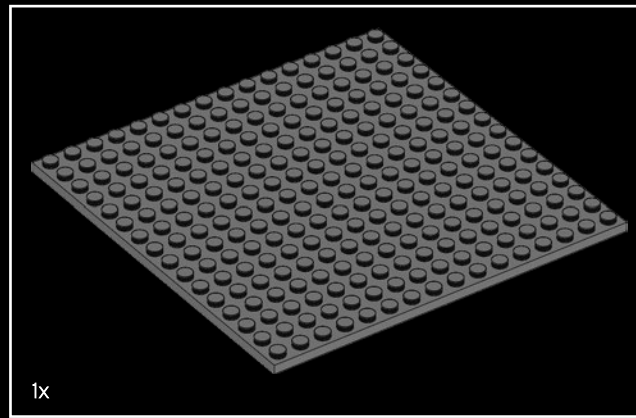
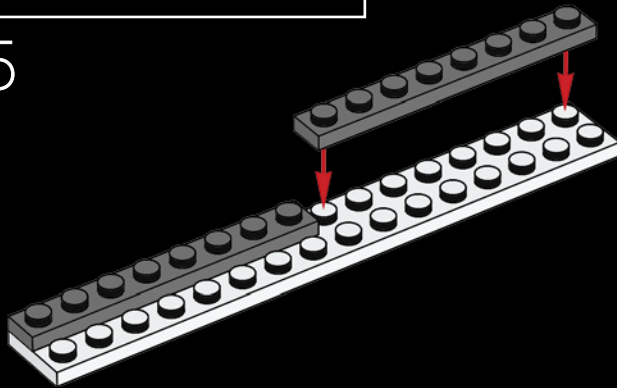

396

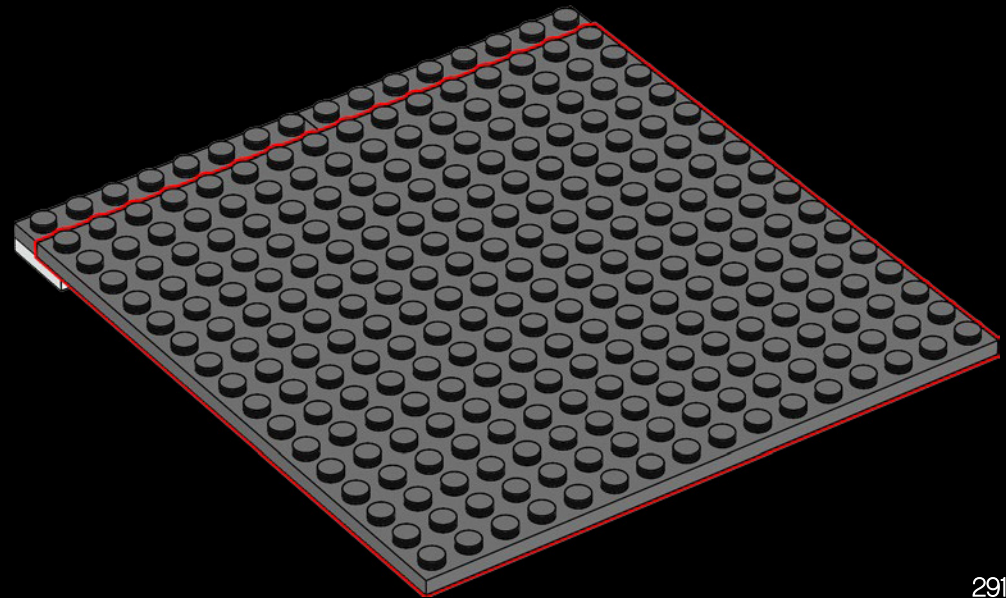

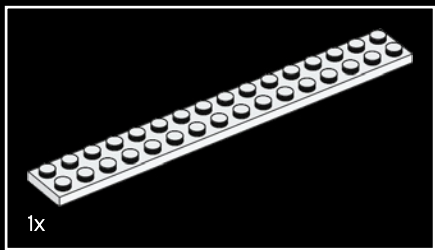

397

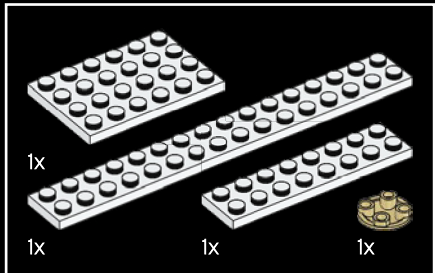
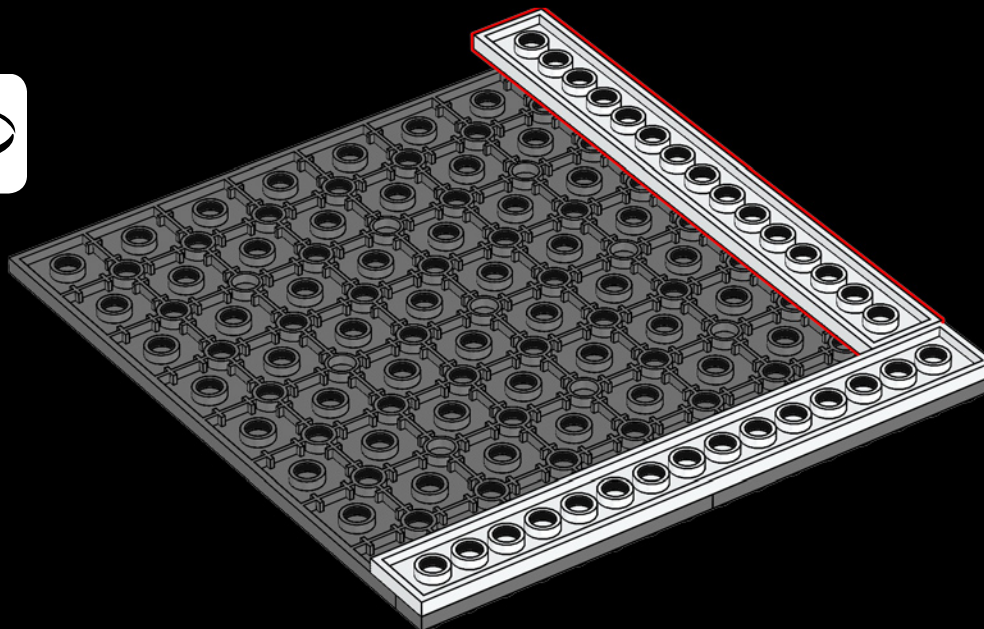

398

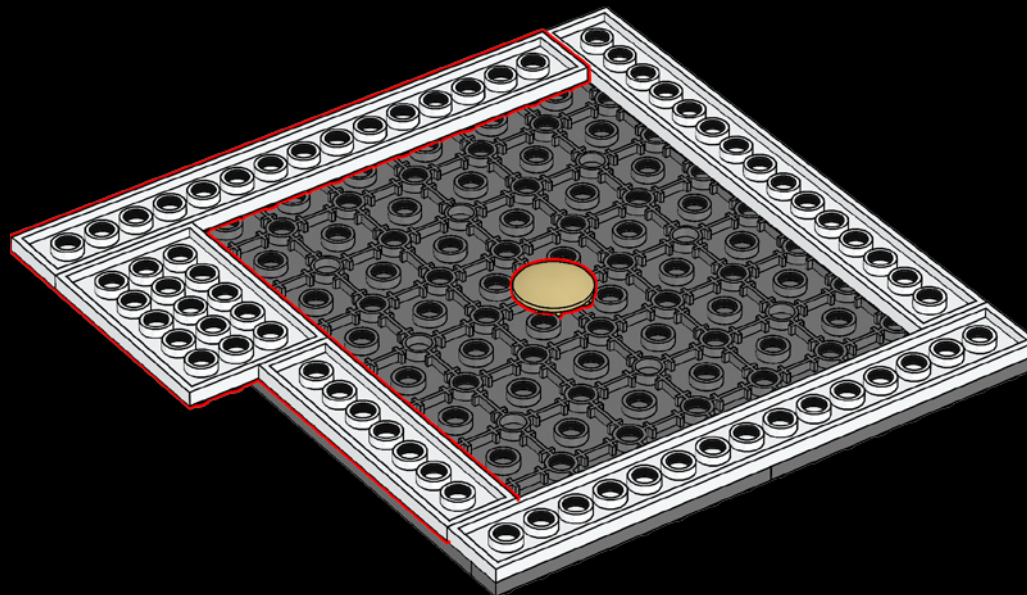



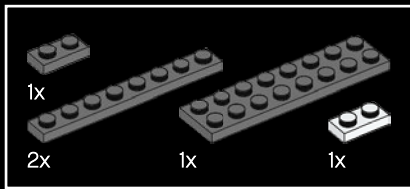

399

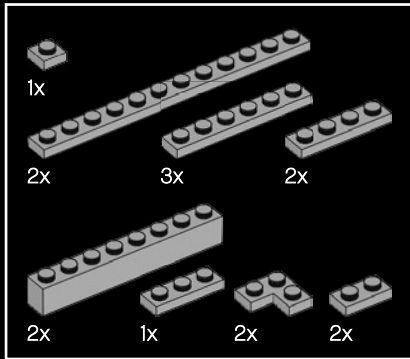
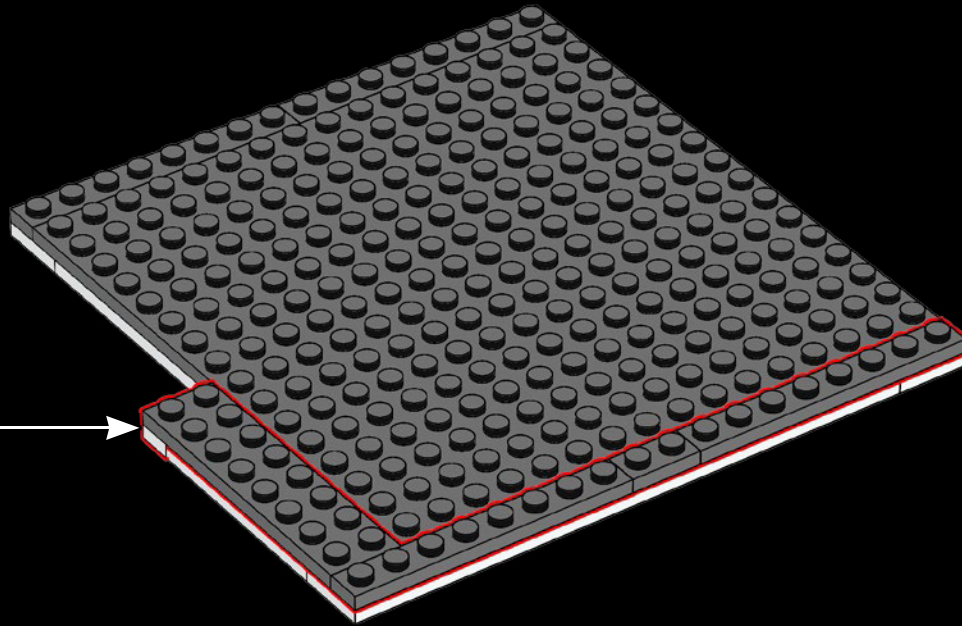
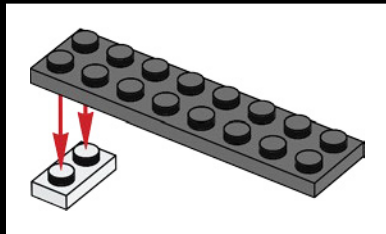

400

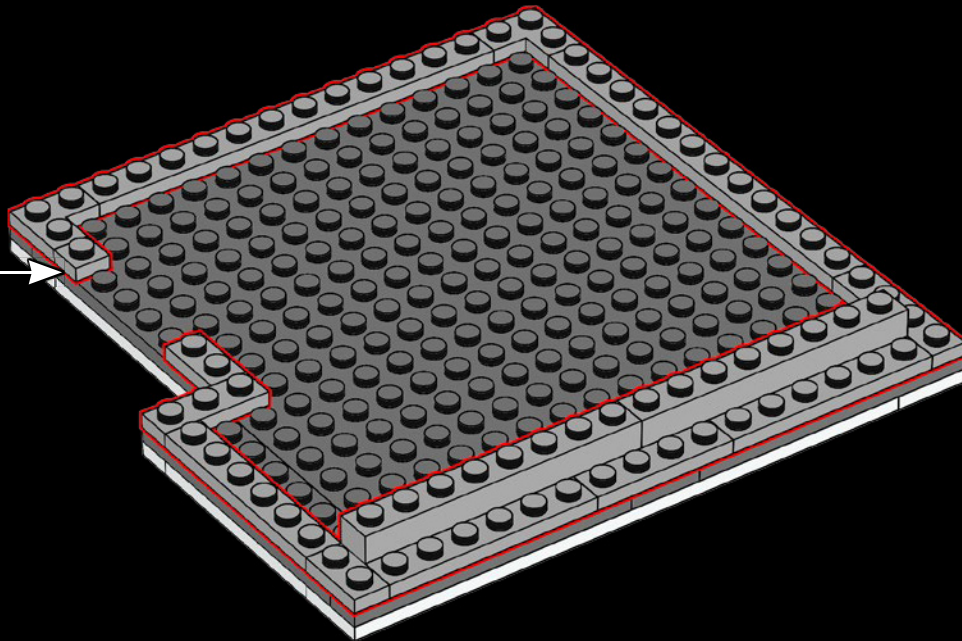

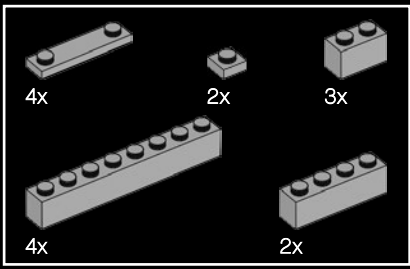

401

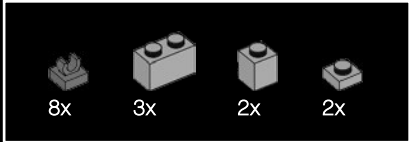
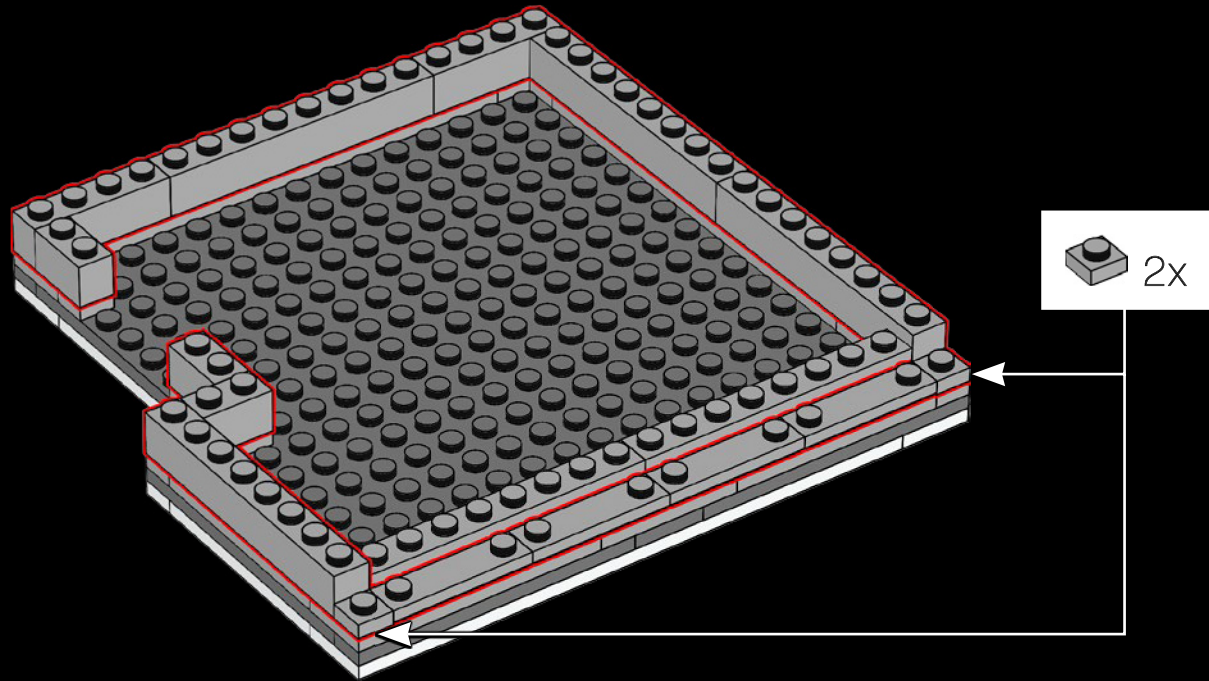

402

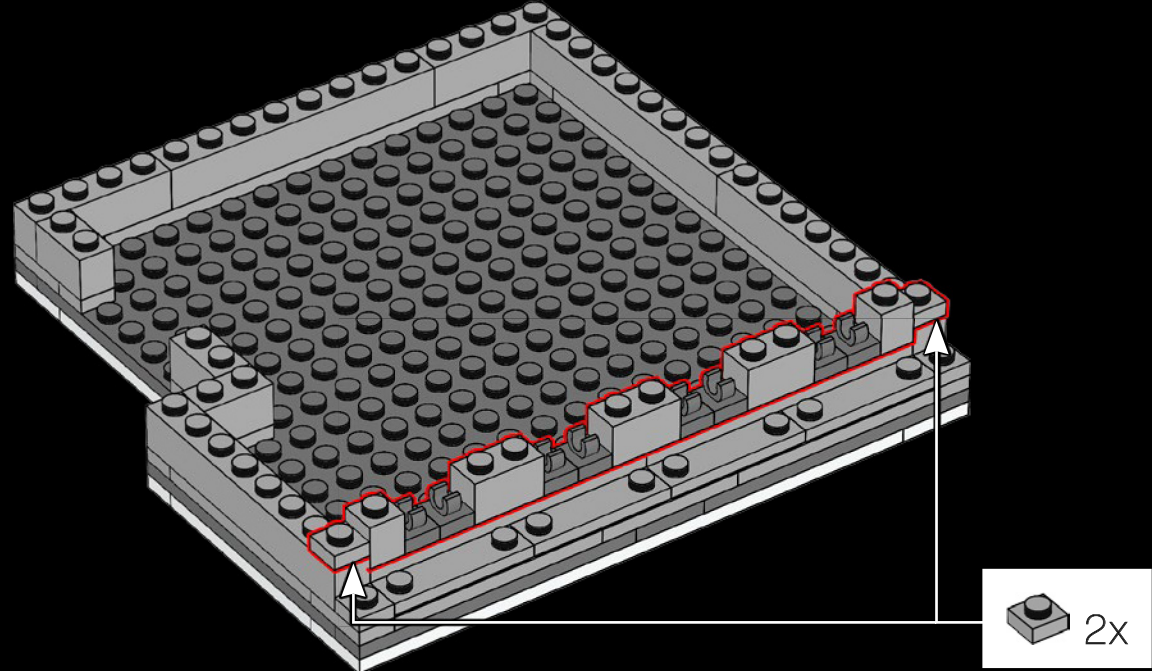



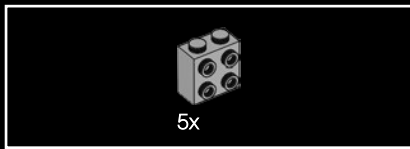

403

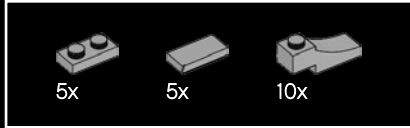
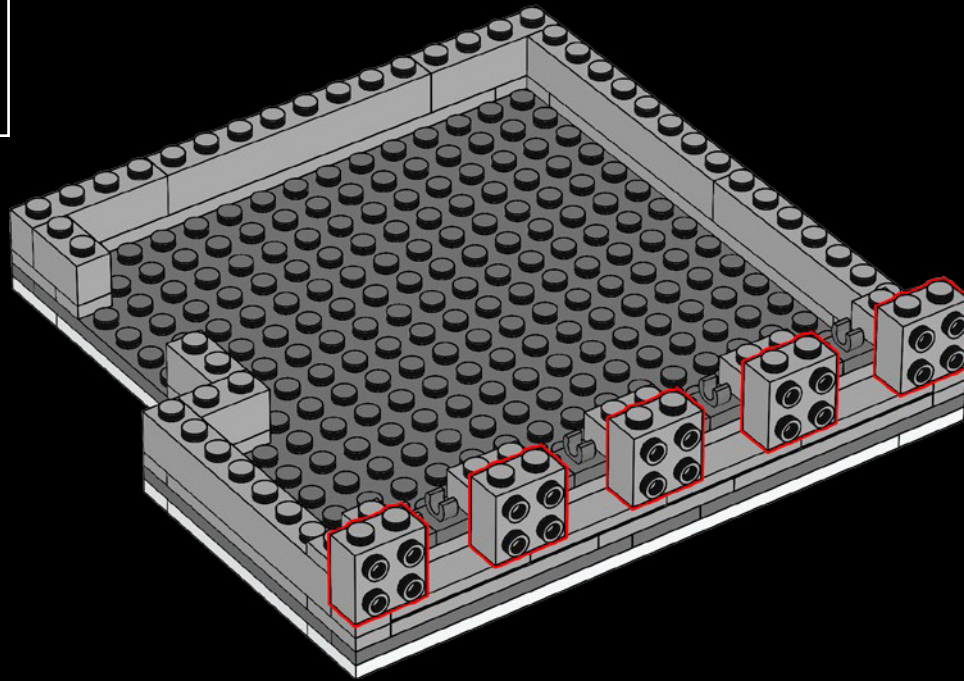

404

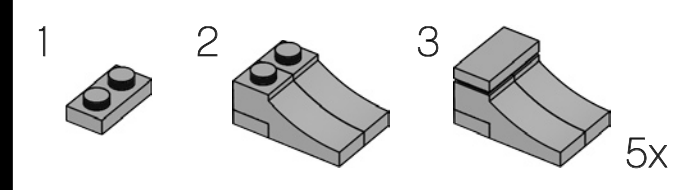
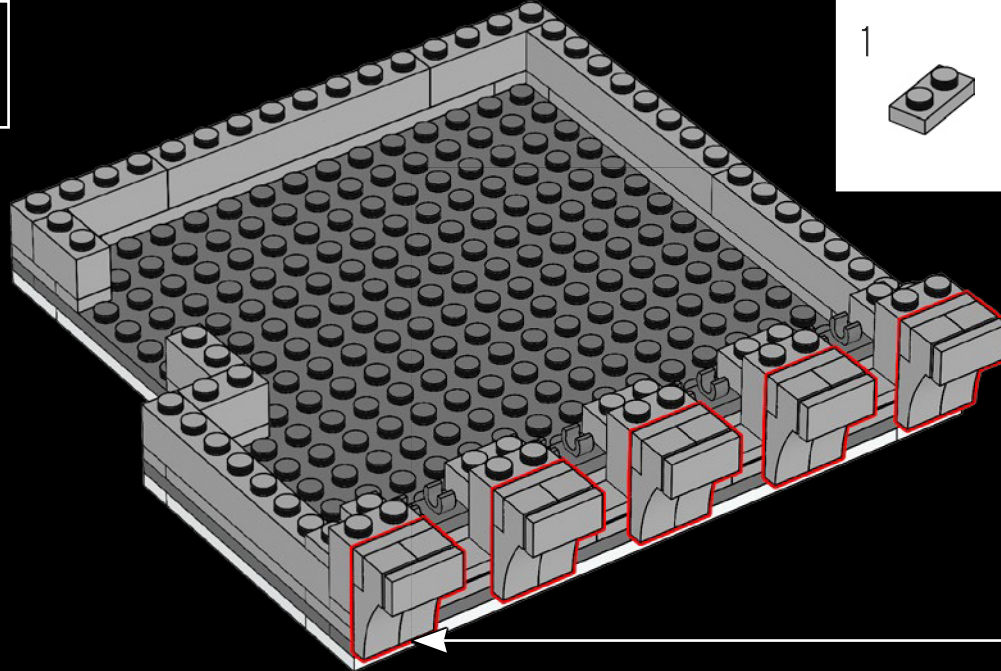

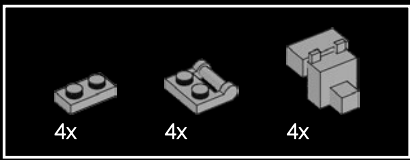

- Did you notice the cornice is crafted using a familiar animal head flipped upside down?
- Avez-vous remarqué que la corniche a été réalisée à l'aide d'une tête d'animal familière placée à l'envers ?
- ¿Te fijaste en que la cornisa está construida a partir de la cabeza de un popular animal puesta al revés?

405

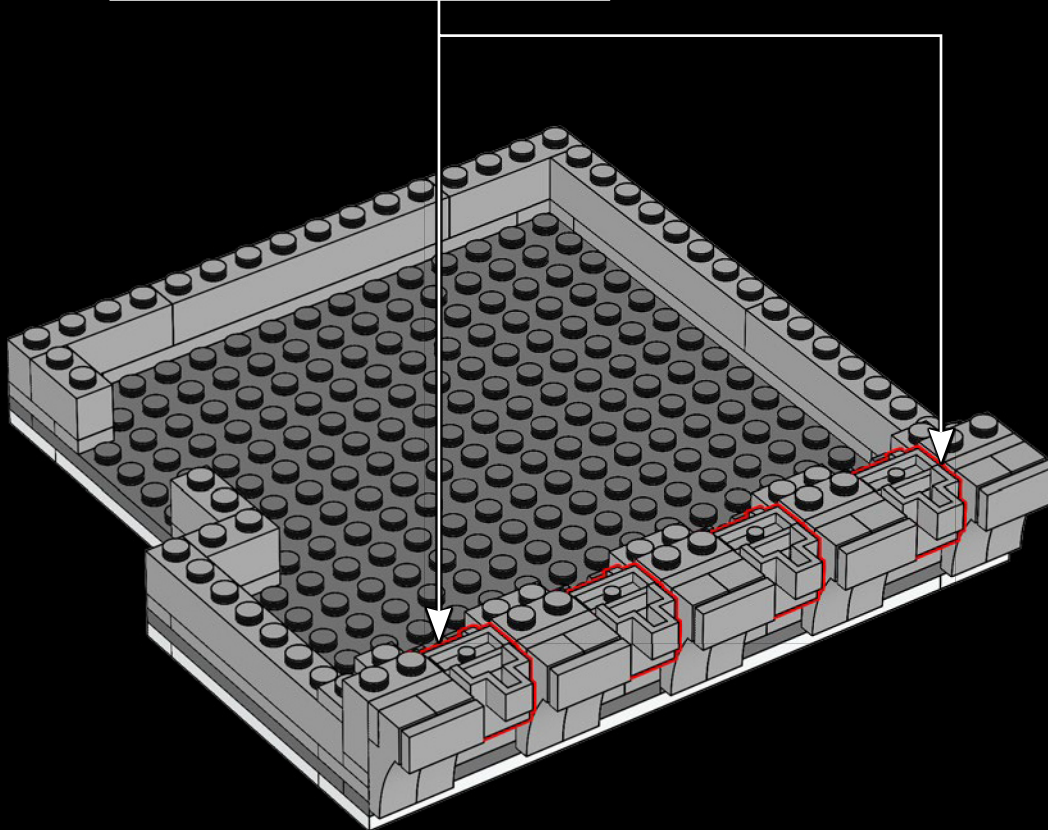
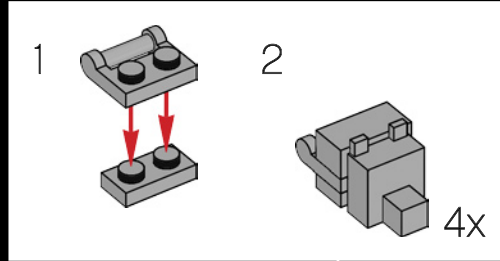



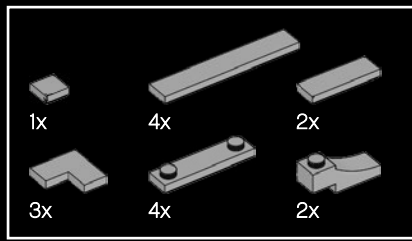

406

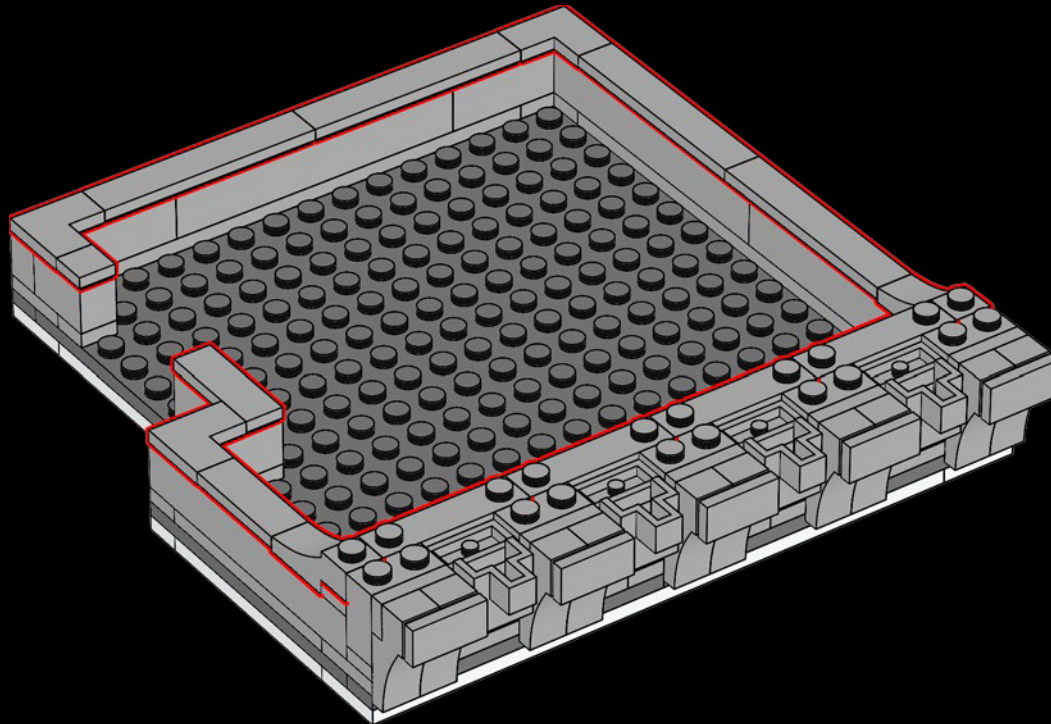

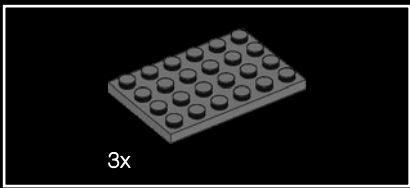

407

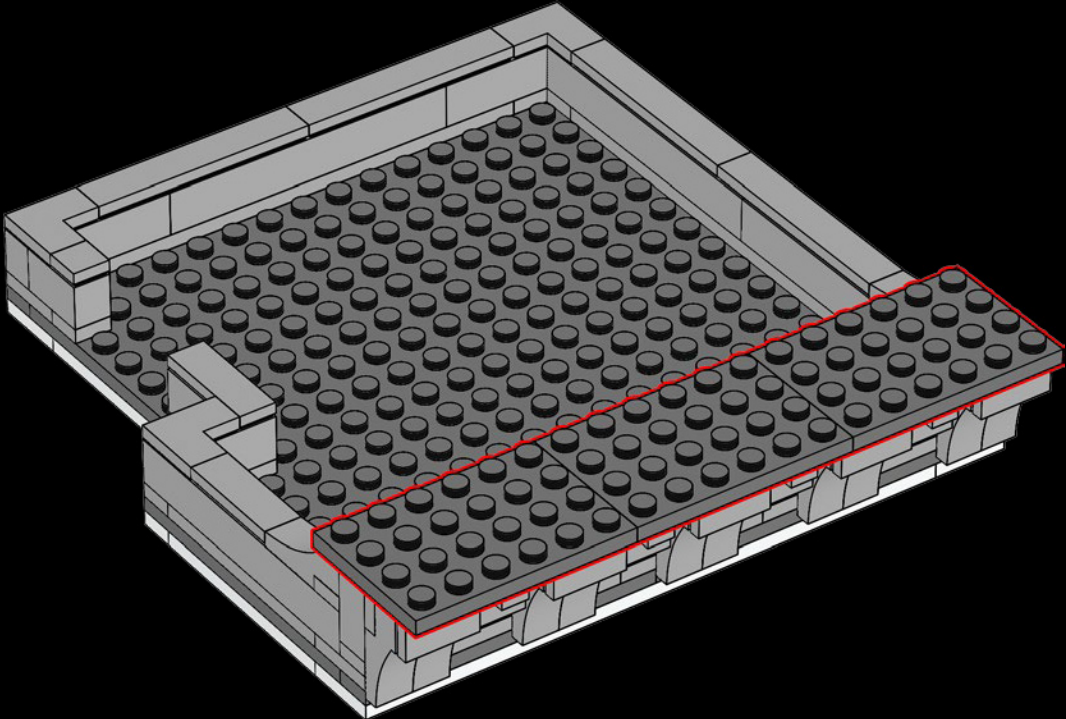



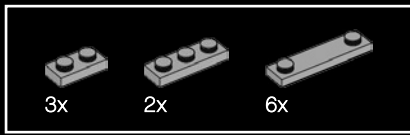

408

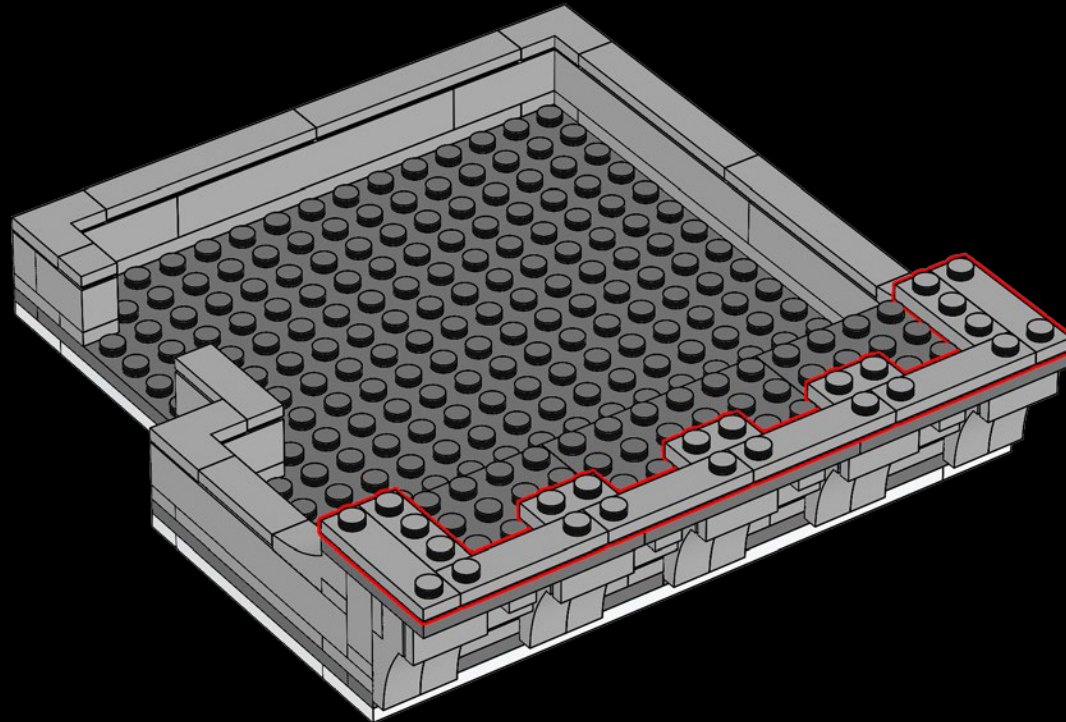

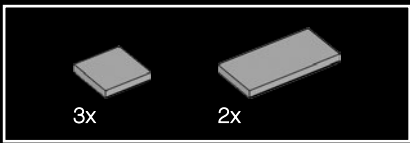

409

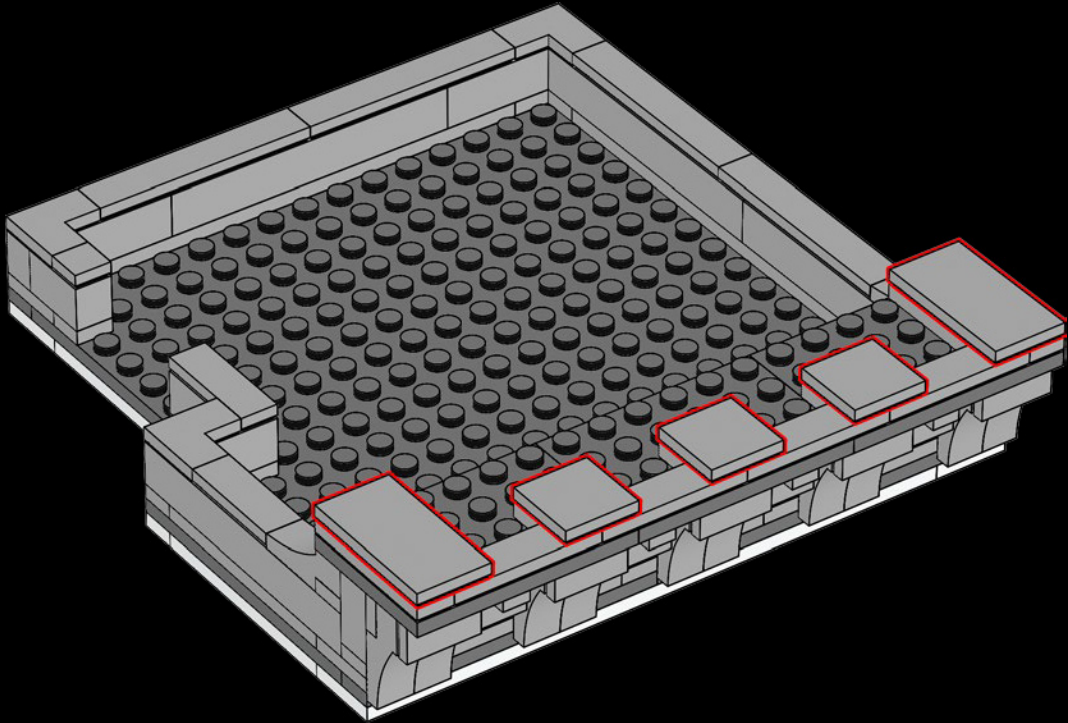



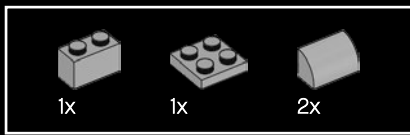

410

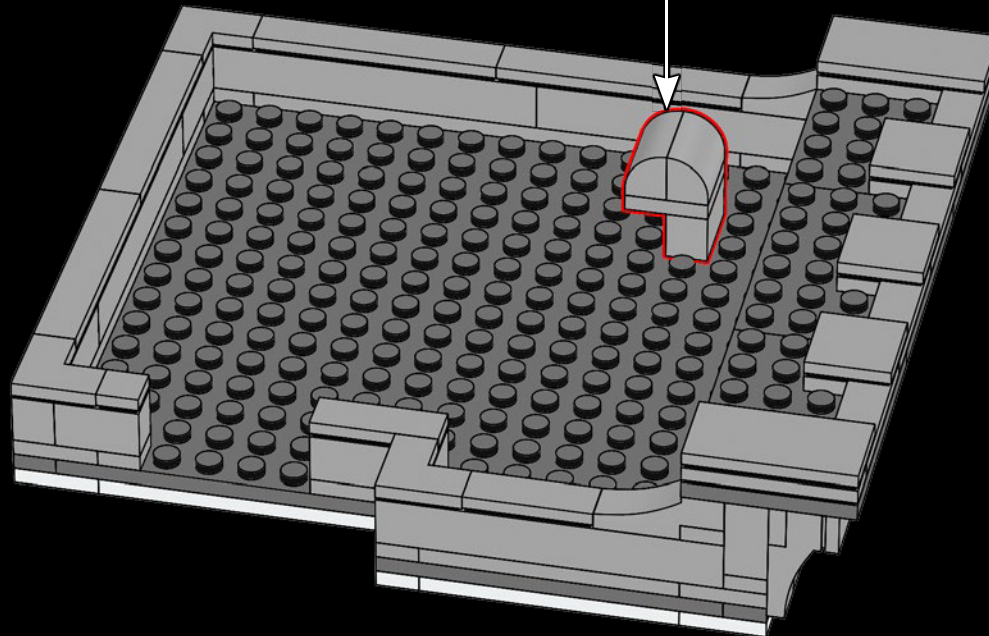
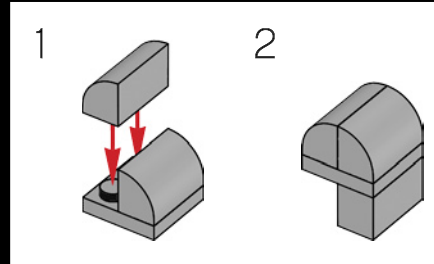

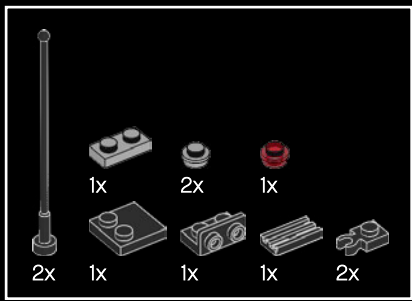

411

1

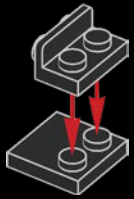

2

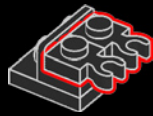

3

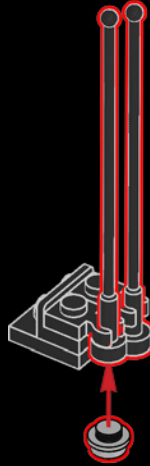

4

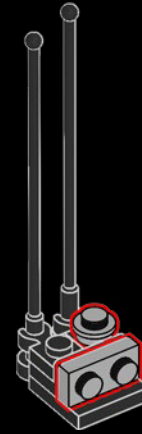

5

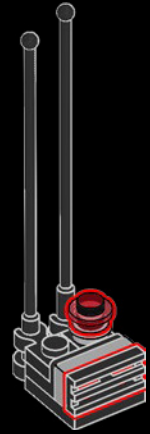



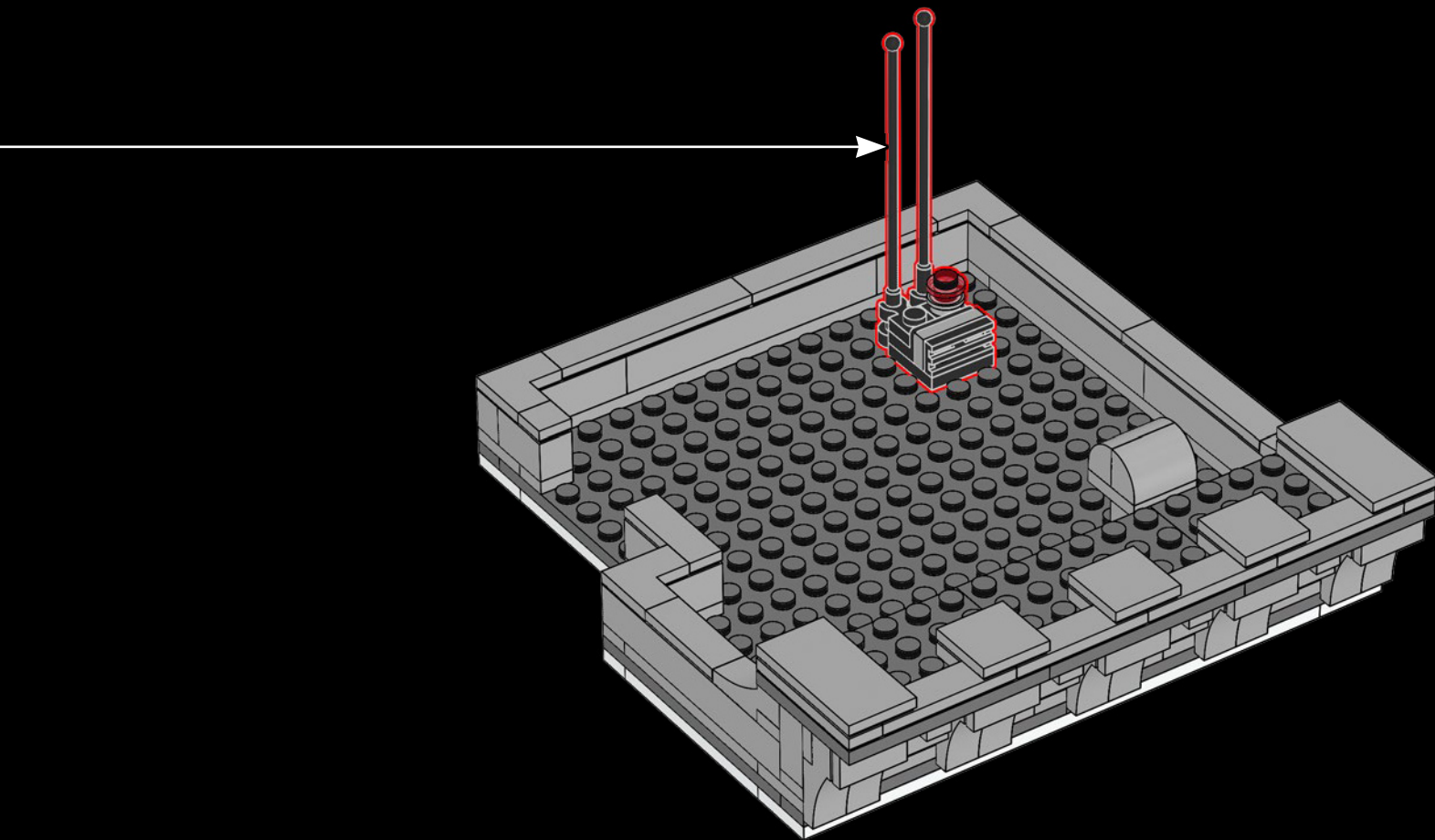

412

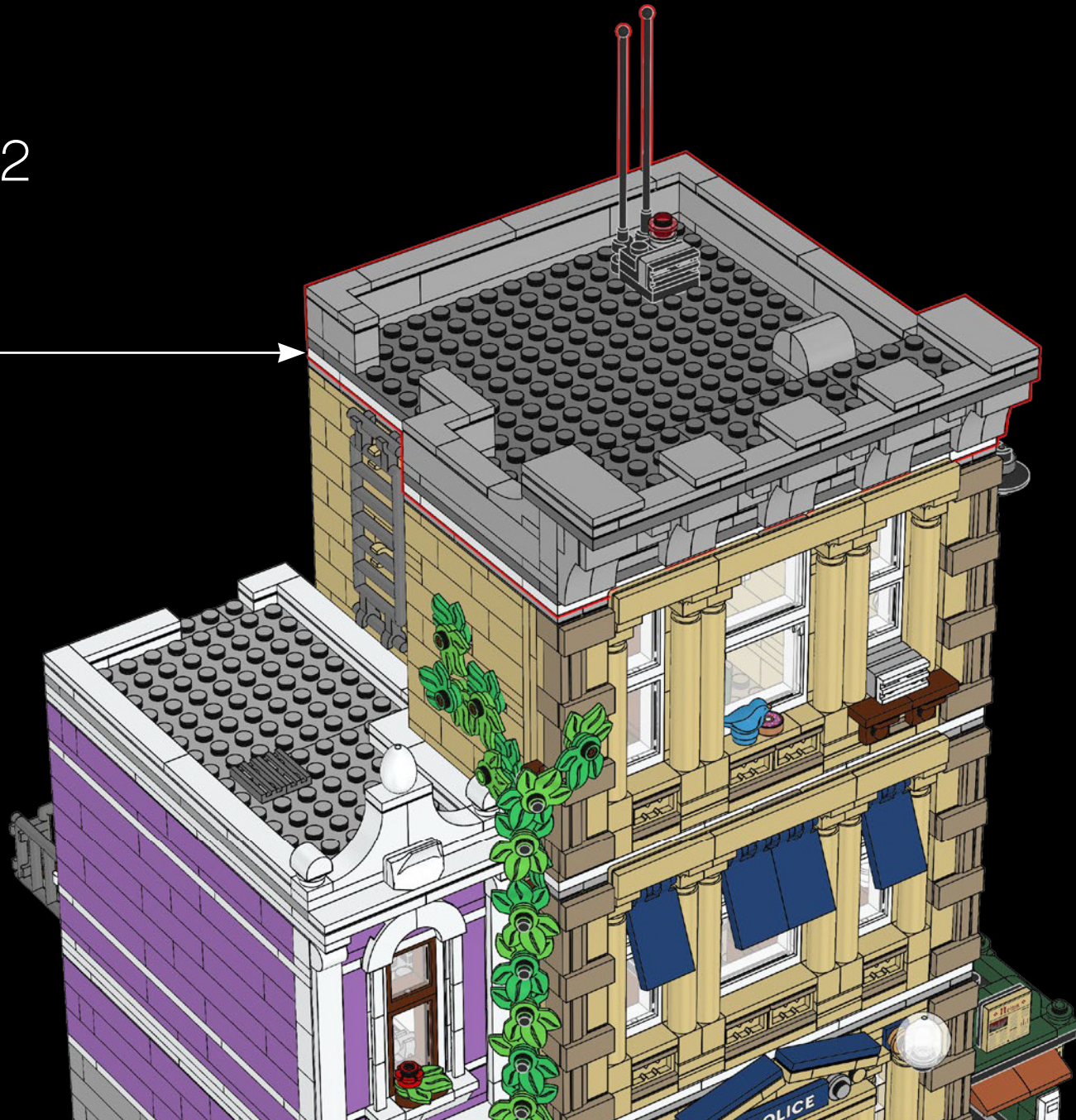



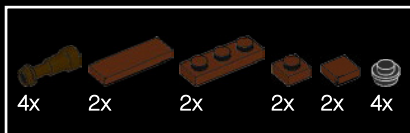

413

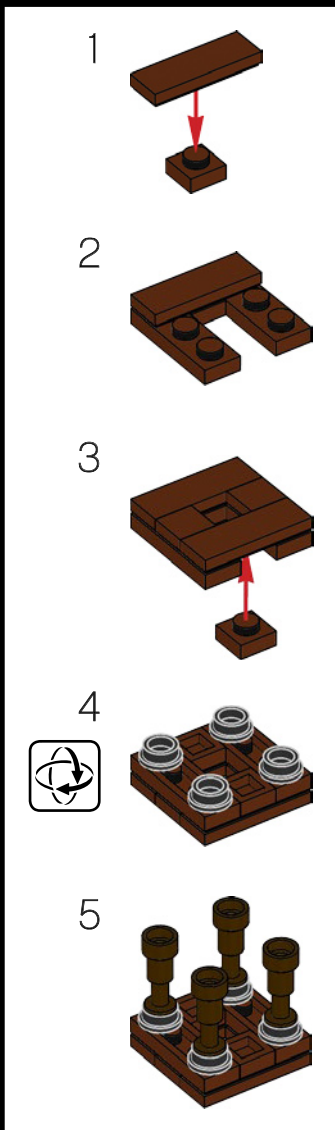

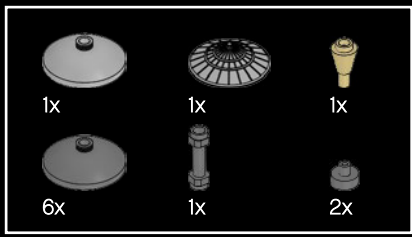

414

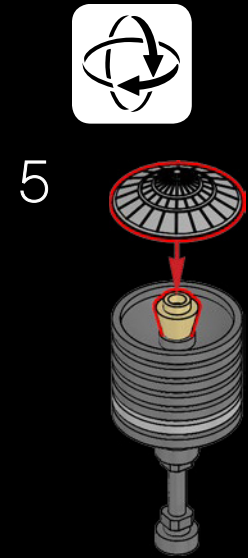
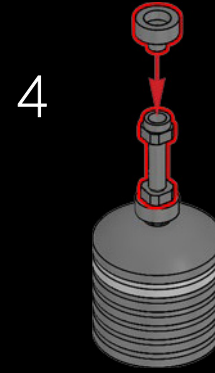
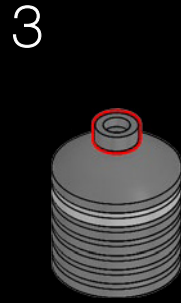
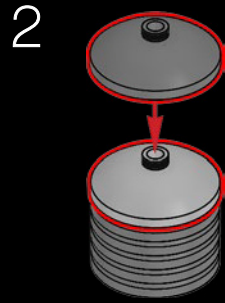
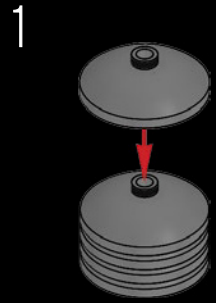





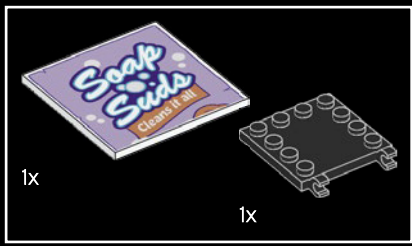

415

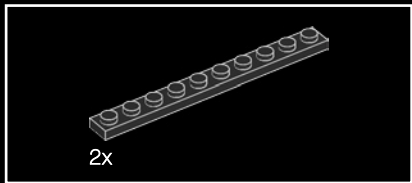
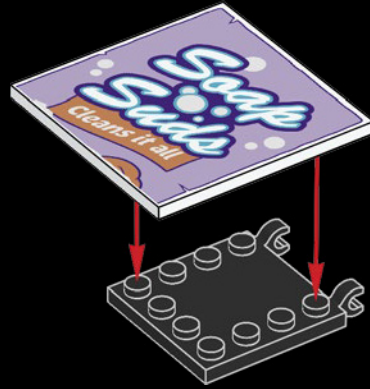

416

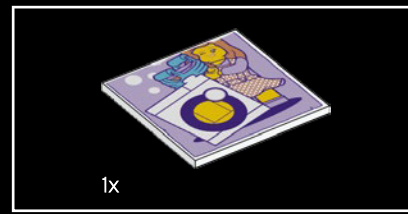
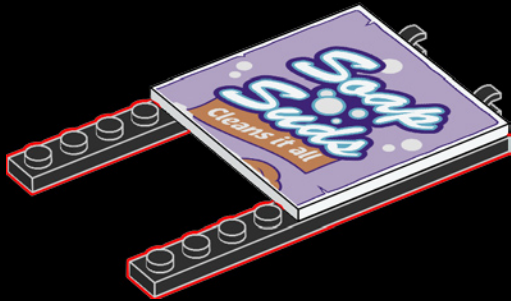

417

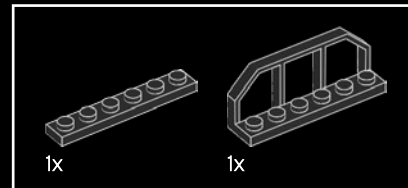

418

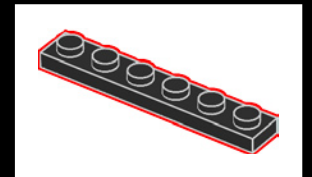



419



● The billboard shows the clever laundromat owner from 10251 Brick Bank, who is convinced the police will never discover her plan to 'clean out' the vault.

● Le panneau d'affichage montre l'astucieuse propriétaire de la buanderie de la Banque Brique (10251), qui est convaincue que la police ne découvrira jamais son plan pour « nettoyer » la chambre forte.

● El cartel muestra a la astuta propietaria de la lavandería del set Brick Bank (10251), que está convencida de que la Policía nunca descubrirá su plan para dejar la bóveda "bien limpia".

- 1x 306201
- 3x 4518400
- 17x 6186681
- 10x 614101
- 1x 6143595
- 2x 6235083
- 11x 302401
- 10x 307001
- 2x 4504369
- 6x 6258135
- 4x 4558952
- 10x 6218841
- 1x 300501
- 1x 6210272
- 2x 6330191
- 2x 4547489
- 4x 6050914
- 1x 6052201
- 1x 474001
- 1x 9327
- 1x 6295301
- 1x 4113261
- 3x 6210076
- 1x 241201
- 4x 6051511
- 5x 4536521
- 2x 370001
- 10x 302301
- 1x 300401
- 1x 6176240
- 12x 306901
- 5x 4521210
- 3x 6117940
- 3x 6070698
- 1x 6097637
- 1x 6014274
- 1x 6011794
- 2x 6250019
- 6x 4249563
- 1x 303401
- 1x 6323426
- 1x 6323425
- 2x 611101
- 2x 6172674
- 5x 242001
- 7x 6058329
- 2x 4612342
- 1x 362201
- 2x 6110019
- 1x 4521943
- 1x 6248223
- 14x 447701
- 3x 346001
- 7x 4119227
- 3x 243101
- 5x 371001
- 9x 4530590
- 3x 6262945
- 1x 4560178
- 10x 302001
- 8x 366601
- 6x 663601
- 2x 379501
- 11x 416201
- 10x 303201
- 2x 6323424
- 3x 6218822
- 6x 6126046
- 5x 306801
- 6x 302201
- 6x 362301
- 4x 6317345
- 2x 302101
- 3x 6156667
- 4x 6249091
- 1x 6017003
- 17x 4161734
- 34x 4159553
- 2x 4579260
- 2x 4516055
- 16x 6178916
- 2x 4125253
- 33x 4113915
- 9x 6057517
- 4x 6232135
- 2x 6012980
- 1x 6177890
- 1x 6177891
- 5x 4278422
- 1x 6323422
- 1x 6323423
- 1x 4125220
- 2x 6326425
- 9x 6092587
- 2x 6313119
- 4x 6148262
- 1x 6146221
- 19x 4159279
- 15x 6024495
- 2x 6063943
- 37x 4109995
- 25x 4114026
- 2x 6271228
- 59x 4113917
- 2x 4114064
- 2x 6249809
- 7x 4550324
- 1x 4201062
- 21x 4113233
- 34x 4113916
- 14x 4124067
- 18x 4112982
- 7x 4157277
- 6x 4181134
- 6x 6288331
- 1x 4544139
- 6x 4114324
- 31x 4159774



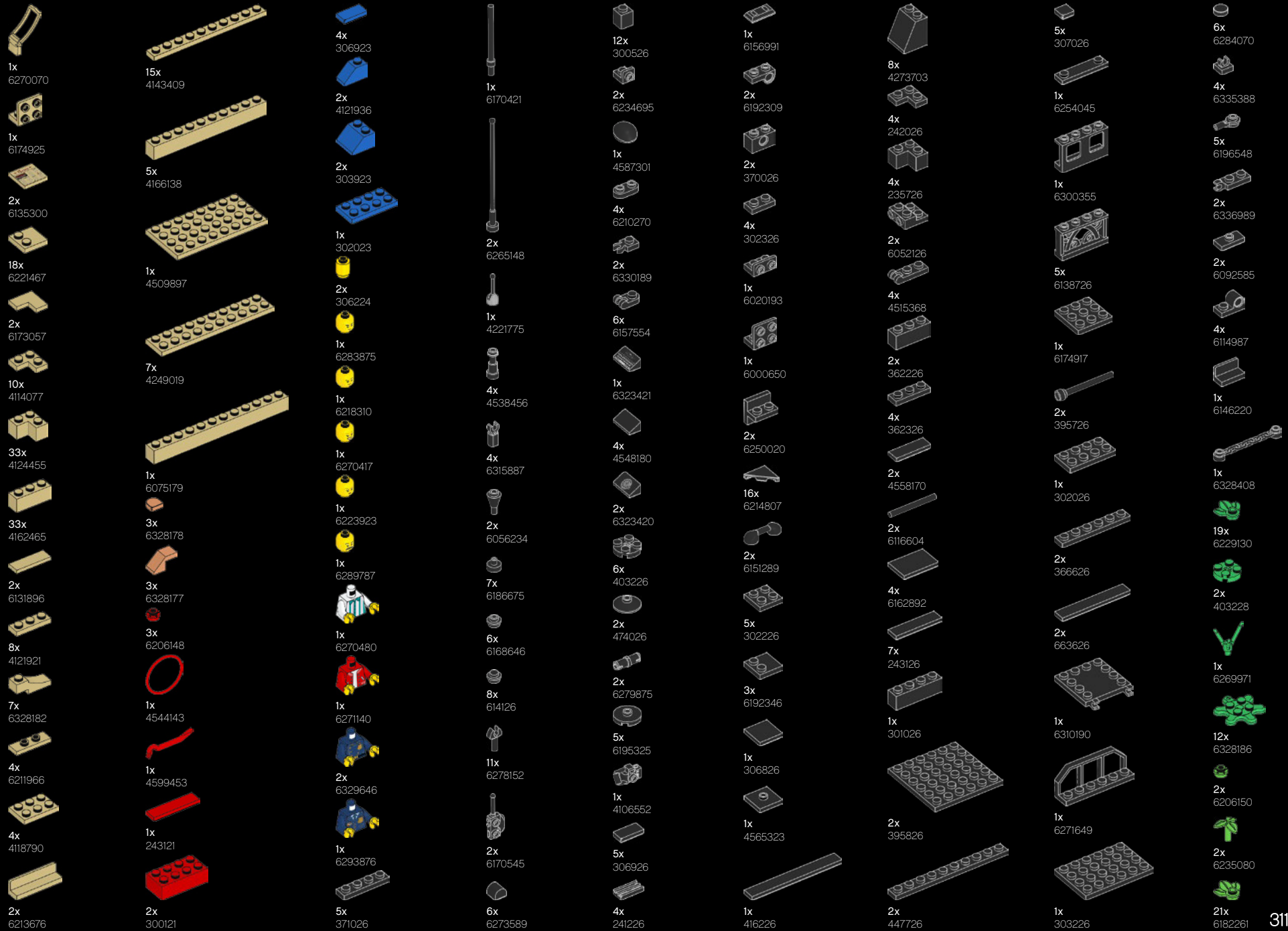

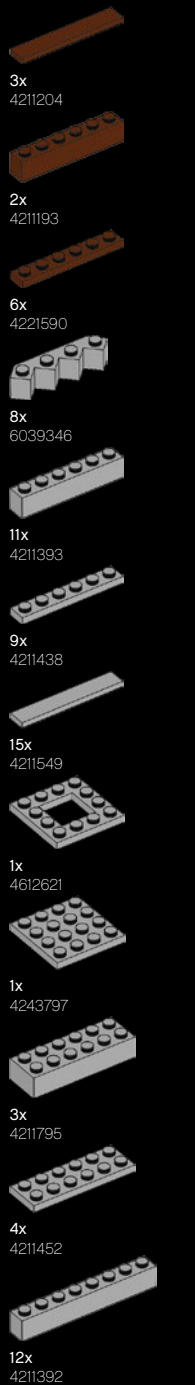
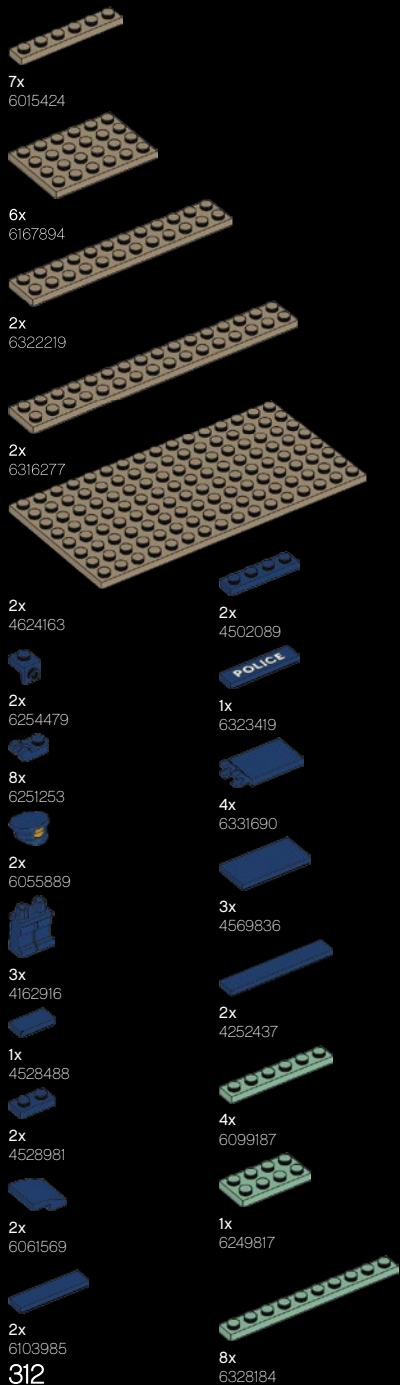



2x 6313114	18x 4211389	1x 4641048	7x 4211349	6x 4211396	1x 6335378	1x 4210934	27x 4211055	1x 6296951
4x 6186657	3x 6225242	4x 6131700	2x 4654577	2x 6171894	1x 6337268	1x 4210872	2x 4211054	3x 6284596
16x 4211388	1x 6186013	5x 4244627	1x 6187170	2x 6315580	3x 4211425	1x 4210869	2x 6177079	6x 6271752
35x 4211398	1x 4211508	2x 6319336	1x 6070564	2x 6315580	10x 4211481	2x 6092572	2x 4210635	9x 6344022
15x 4211414	1x 6281998	6x 6126082	1x 6070564	1x 4211421	1x 4211481	2x 4210631	1x 4210702	2x 4210719
1x 4211440	9x 6248890	3x 4211397	1x 6251044	23x 4211394	1x 4251149	5x 4211063	6x 4210865	3x 4211056
4x 6326078	2x 6227897	5x 4211413	10x 4211428	8x 4211445	1x 4211521	17x 4211052	1x 4211333	9x 4211002
1x 6254402	1x 4211735	1x 6102357	11x 4211429	20x 4211356	1x 4211462	2x 4211066	4x 4210998	1x 4211008
2x 4211564	2x 4568637	2x 6212077	12x 6329117	3x 4211636	2x 4514846	1x 4211335	5x 4521886	1x 4211008
2x 6227184	2x 6179186	5x 4211353	4x 4558169	21x 6257593	1x 4211402	1x 6250018	2x 4211043	6x 4211115
9x 6066097	1x 4650645	18x 6065824	1x 6248917	2x 6315579	1x 4211402	1x 4543086	4x 4211001	1x 4210997
5x 6000066	2x 6092956	5x 4211387	2x 6315579	3x 4211395	3x 4166618	5x 6310596	1x 6262942	4x 4667977
7x 6123809	1x 6125569	2x 4211436	2x 4211773	1x 6168615	2x 4210794	3x 6126083	1x 4211065	4x 4211134
5x 6004990	1x 6248492	1x 6034676	1x 6170385	18x 4560183	1x 6133611	1x 4211094		
14x 4211568	8x 4515374	4x 6177078				8x 6309059		



- 9x 6315329
- 5x 6287854
- 9x 6167641
- 4x 6296061
- 1x 6257433

- 1x 6287960
- 2x 6335307
- 2x 6104344
- 2x 6186007
- 2x 4535928

- 4x 6209681
- 2x 6215387
- 4x 6060795
- 1x 6096589
- 1x 6195266
- 2x 6336971
- 2x 6238674

- 2x 6240030
- 1x 6247785
- 1x 6208450
- 2x 6238677
- 3x 6274739
- 1x 4529672
- 4x 6328188
- 4x 4538950
- 4x 6252667
- 5x 6328181
- 1x 6226792
- 2x 4518687
- 2x 6337282

- 2x 6209684
- 8x 4619521
- 1x 6097301
- 8x 6125776
- 11x 4651903
- 3x 6347299
- 1x 6152645
- 21x 4623598
- 15x 4619512
- 8x 6173813
- 3x 4619524
- 14x 6107188
- 2x 6265058
- 26x 6251908
- 9x 4649745

- 1x 6055172
- 2x 4549436
- 42x 4496699
- 42x 4528604
- 6x 6310835
- 11x 4521914
- 8x 6330148
- 20x 6250168
- 6x 6328183
- 2x 6126075
- 5x 4507045
- 3x 4550168
- 1x 6132768
- 2x 6164288
- 2x 4267874

- 1x 6244882
- 1x 6251292
- 15x 6142505
- 7x 6057880
- 1x 6062089
- 1x 6248957
- 3x 6124349
- 1x 6240515
- 1x 6251285
- 3x 6247362
- 12x 6253734

- 4x 6285587
- 2x 6247798
- 1x 6274738
- 6x 6168665
- 14x 6220959
- 10x 6254552
- 8x 6252258
- 1x 6238856
- 2x 6266626
- 1x 6163901
- 1x 6286876
- 1x 6240204
- 1x 6251294

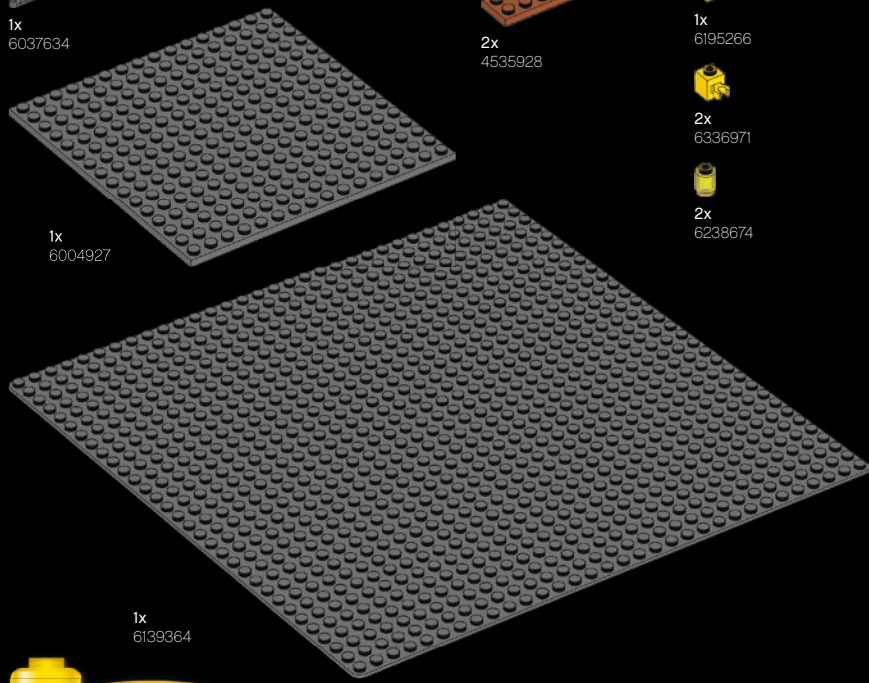

**Customer Service**  
**Kundenservice**  
**Service Consommateurs**  
**Servicio Al Consumidor**

LEGO.com/service or dial

00800 5346 5555 :

1-800-422-5346 :





# FEEDBACK AND WIN



## FEEDBACK AND WIN

Your feedback will help shape the future development of this product series.

Please visit:

## FEEDBACK UND GEWINNEN

Dein Feedback trägt zur Weiterentwicklung dieser Produktreihe bei.

Geh auf:

## COMMENTEZ ET GAGNEZ

Vos commentaires nous aideront à concevoir les futurs produits de cette gamme.

Rendez-vous sur :

## COMENTA Y GANA

Tu opinión nos ayudará a dar forma al desarrollo de esta serie de productos en el futuro.

Visita:

## 反馈有奖

您的反馈将有助于我们在今后改进本系列产品。

请访问：

[LEGO.com/productfeedback](https://www.lego.com/productfeedback)

By completing, you will automatically enter a drawing to win a LEGO® set.

Terms & Conditions apply.

Durch Ausfüllen nimmst du automatisch an der Verlosung eines LEGO® Preises teil.

Es gelten die Teilnahmebedingungen.

En envoyant vos commentaires, vous serez automatiquement inscrit(e) à un tirage au sort qui vous permettra de remporter un prix LEGO®.

Offre soumise à conditions.

Al contestar, participarás automáticamente en el sorteo y podrás ganar un set LEGO®.

Sujeto a Términos y Condiciones.

完成我们的反馈调查，即可自动进入抽奖环节，赢取乐高®套装。

适用《条款和条件》。

