

S.P.Q.R.

COLOSSEUM

S.P.Q.R.

LE COLISÉE

S.P.Q.R.

COLISEO

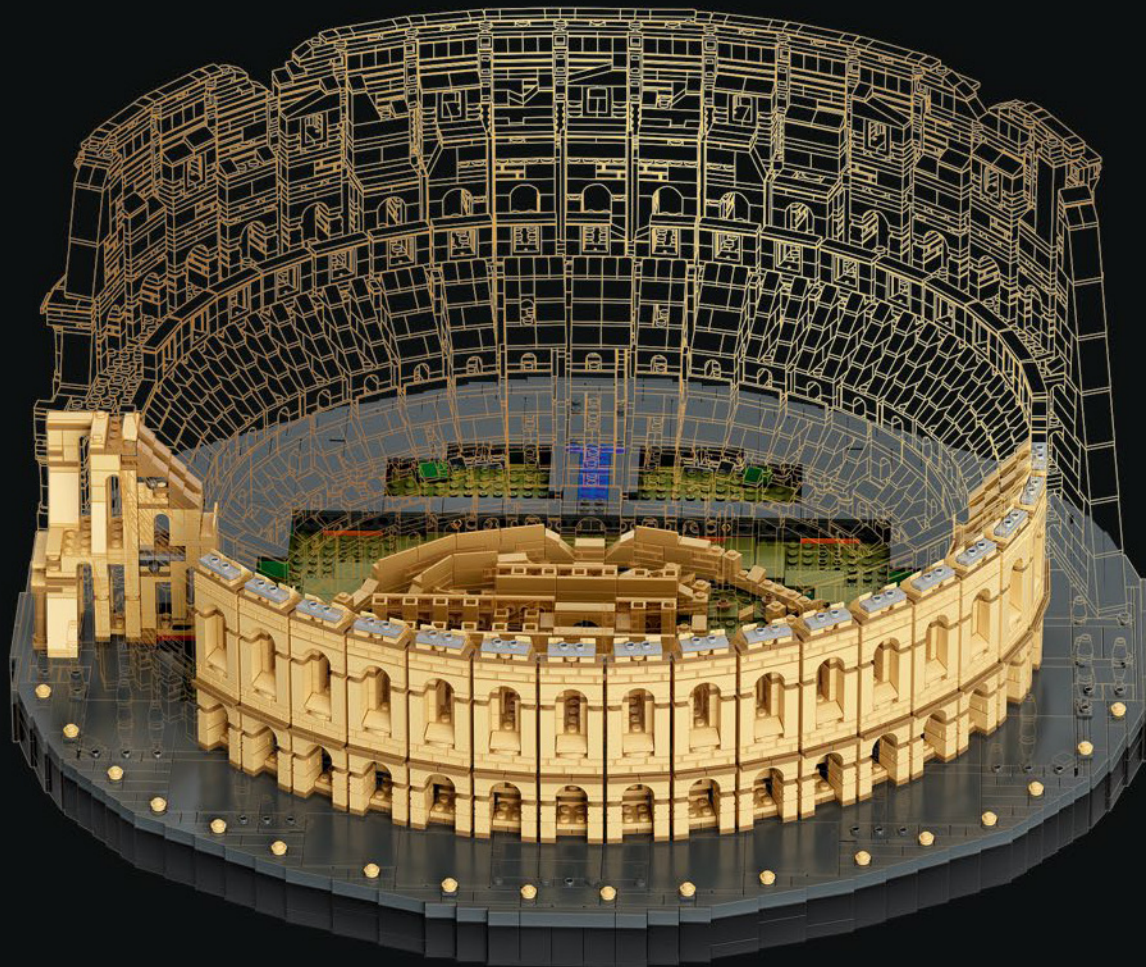

II

HISTORY

In 64 CE the Great Fire of Rome devastated the city and Emperor Nero seized much of the area where the Colosseum now stands for himself. Construction began under Emperor Vespasian in CE 72 and was completed by his successor and heir, Titus, in CE 80. Further modifications were carried out during the reign of Domitian, the 3rd emperor in the Flavian dynasty, including the building of the hypogeum underneath the arena.

HISTOIRE

En 64 apr. J.-C., le grand incendie de Rome dévaste la ville, et l'empereur Néron s'empare d'une grande partie de la zone où le Colisée se tient aujourd'hui. La construction a commencé sous l'empereur Vespasien en 72 apr. J.-C. et s'est achevée sous son successeur et héritier, Titus, en 80 apr. J.-C. D'autres modifications, dont la construction de l'hypogée sous l'arène, ont été effectuées durant le règne de Domitien, le 3^e empereur de la dynastie flavienne.

HISTORIA

En el año 64 d. C., el gran incendio de Roma devastó la ciudad y el emperador Nerón se apoderó de gran parte del área donde ahora se encuentra el Coliseo. La construcción comenzó en el año 72 d. C., bajo el mandato del emperador Vespasiano, y fue completada por su sucesor y heredero, Tito, en el año 80 d. C. Durante el reinado de Domiciano, el tercer emperador de la dinastía flavia, se llevaron a cabo más modificaciones, entre ellas la construcción del hipogeo, situado debajo de la arena.





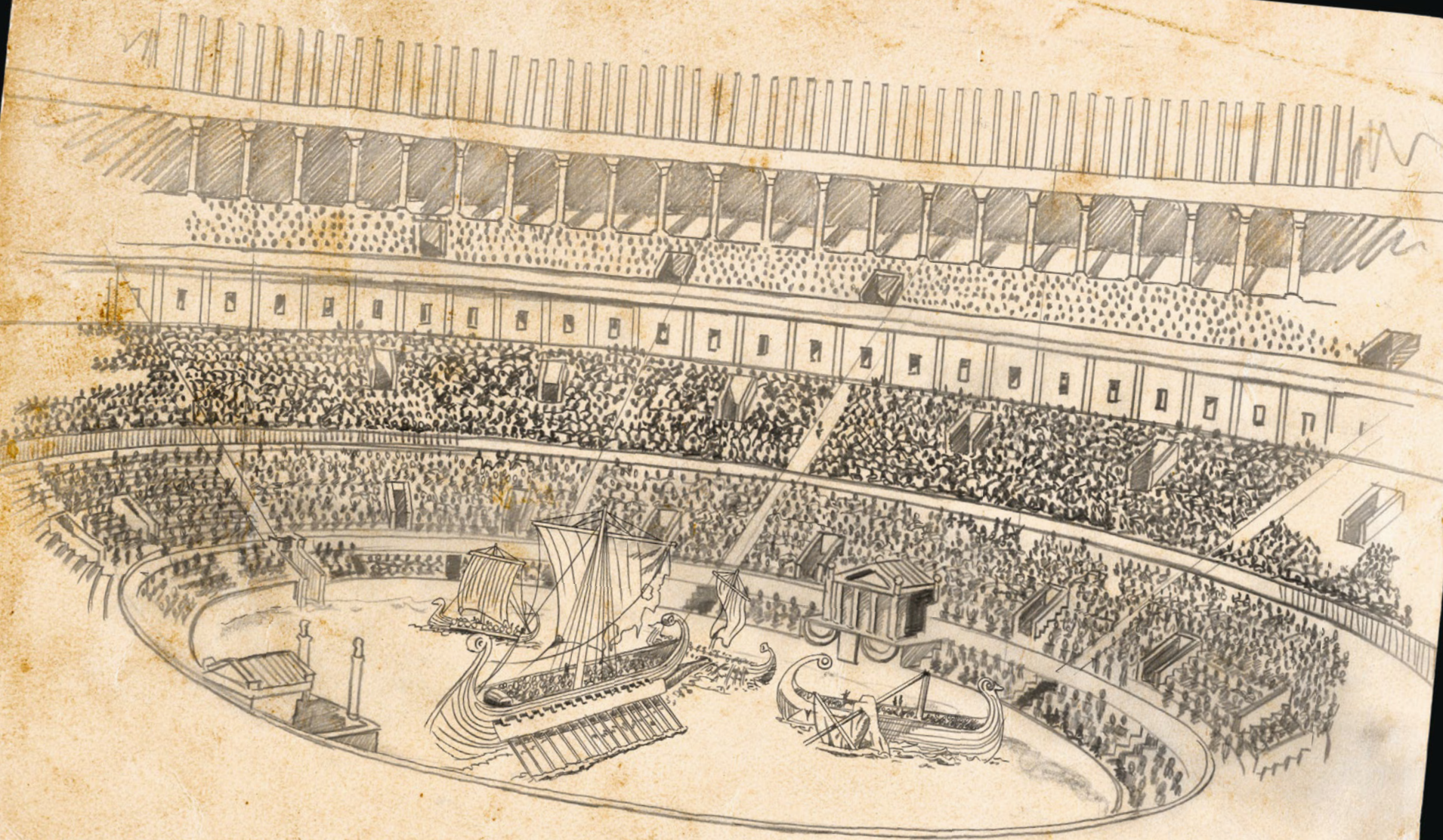

Crowds would flock to see the dramatic re-enactment of historic sea battles.

Les foules affluaient pour voir les reconstitutions dramatiques de batailles maritimes historiques.

Hasta entonces, las multitudes se reunían allí para presenciar dramáticas recreaciones de batallas navales históricas.

THE SPECTACLE

Some of the most popular events in the Colosseum were the reconstruction of epic naval battles. The first one was staged in AD 80, when the arena was flooded and specially constructed flat-bottomed ships replicated the battle between Athens and Syracuse. It is still unclear how the arena could be filled with water and drained again so quickly, but many ancient writers describe these spectacular shows that were called *naumachiae*.

LE SPECTACLE

Les reconstitutions de batailles navales épiques figuraient parmi les événements les plus populaires au Colisée. La première s'est tenue en 80 apr. J.-C., lorsque l'arène a été inondée pour permettre à des navires à fond plat spécialement construits de reproduire la bataille entre Athènes et Syracuse. On ne sait toujours pas comment l'arène pouvait être remplie d'eau puis drainée aussi rapidement, mais de nombreux écrivains antiques décrivent ces spectacles impressionnants appelés *naumachies*.

ESPECTÁCULO

Uno de los eventos de mayor popularidad de entre los que se celebraban en el Coliseo era la recreación de épicas batallas navales. El primero tuvo lugar en el año 80 d. C., cuando se inundó la arena y una serie de barcos de fondo plano contruidos especialmente para la ocasión replicaron la batalla entre Atenas y Siracusa. No se sabe con seguridad cómo era posible inundar la arena y vaciarla con tanta rapidez, pero son muchos los antiguos historiadores que describen estos espectaculares montajes, denominados *naumachiae*.

Each tier was divided into sections and further subdivided into *cunei*, or wedges, by the steps and aisles from the vomitoria. Each row (*gradus*) of seats was numbered, permitting each individual seat to be exactly designated by its *gradus*, *cuneus*, and number.

Chaque niveau était divisé en sections et subdivisé en *cunei*, ou coins, par les marches et les allées des vomitoria. Chaque rangée (*gradus*) de sièges était numérotée, permettant à chaque siège individuel d'être désigné exactement par son *gradus*, son *cuneus* et son numéro.

Los niveles estaban divididos en secciones, y estas, a su vez, en cuñas (*cunei*) mediante las escaleras y pasillos de los vomitoria. Cada fila (*gradus*) estaba numerada, lo que permitía identificar con exactitud cualquier asiento por su *gradus*, *cuneus* y número.

THE SPECTATORS

With estimated crowds of up to 80,000, the composition of the Colosseum's audience mirrored the rigid class structure of Roman society. Special boxes at the north and south ends of the arena offered the best views and were reserved for the emperor. These were surrounded by the senatorial class, while the tier directly above was occupied by the noblemen. Above them sat the wealthy and respected citizens of the city, and at the very top stood the common poor and slaves.

LES SPECTATEURS

Avec une foule pouvant compter jusqu'à 80 000 personnes, l'arrangement du public du Colisée reflétait la structure de classe rigide de la société romaine. Des loges spéciales aux extrémités nord et sud de l'arène offraient les meilleures vues et étaient réservées à l'empereur. Autour d'elles se trouvait la section accueillant la classe sénatoriale, tandis que le niveau directement au-dessus était occupé par les nobles. Les citoyens riches et respectés de la ville prenaient place au niveau suivant, et les pauvres et les esclaves se trouvaient au sommet des gradins.

ESPECTADORES

Con audiencias estimadas de hasta 80.000 personas, la composición del público del Coliseo reflejaba la rígida estructura de clases de la sociedad romana. Los palcos especiales de los extremos norte y sur de la arena ofrecían las mejores vistas y estaban reservados para el emperador. Estos estaban rodeados de áreas para la clase senatorial, mientras que el nivel inmediatamente superior estaba destinado a la nobleza. Sobre ellos se sentaban los ciudadanos más adinerados y respetados de la ciudad. Las gradas más altas eran para los pobres y esclavos comunes.



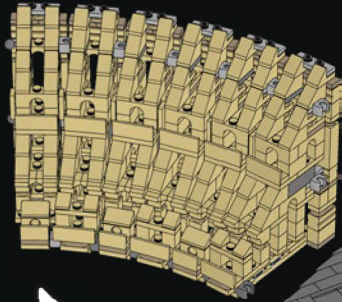
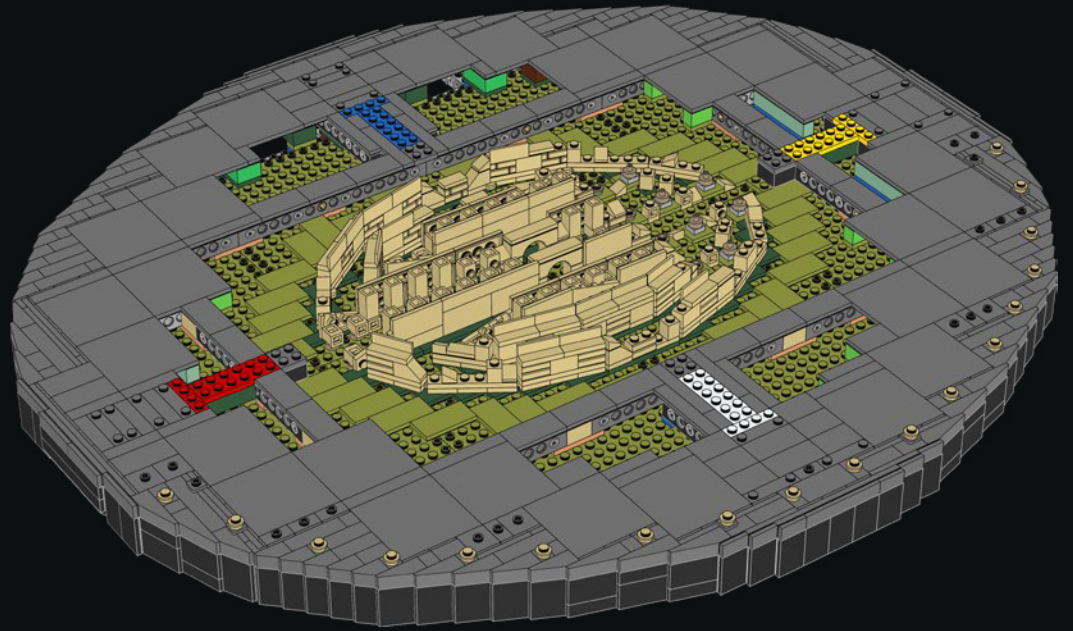

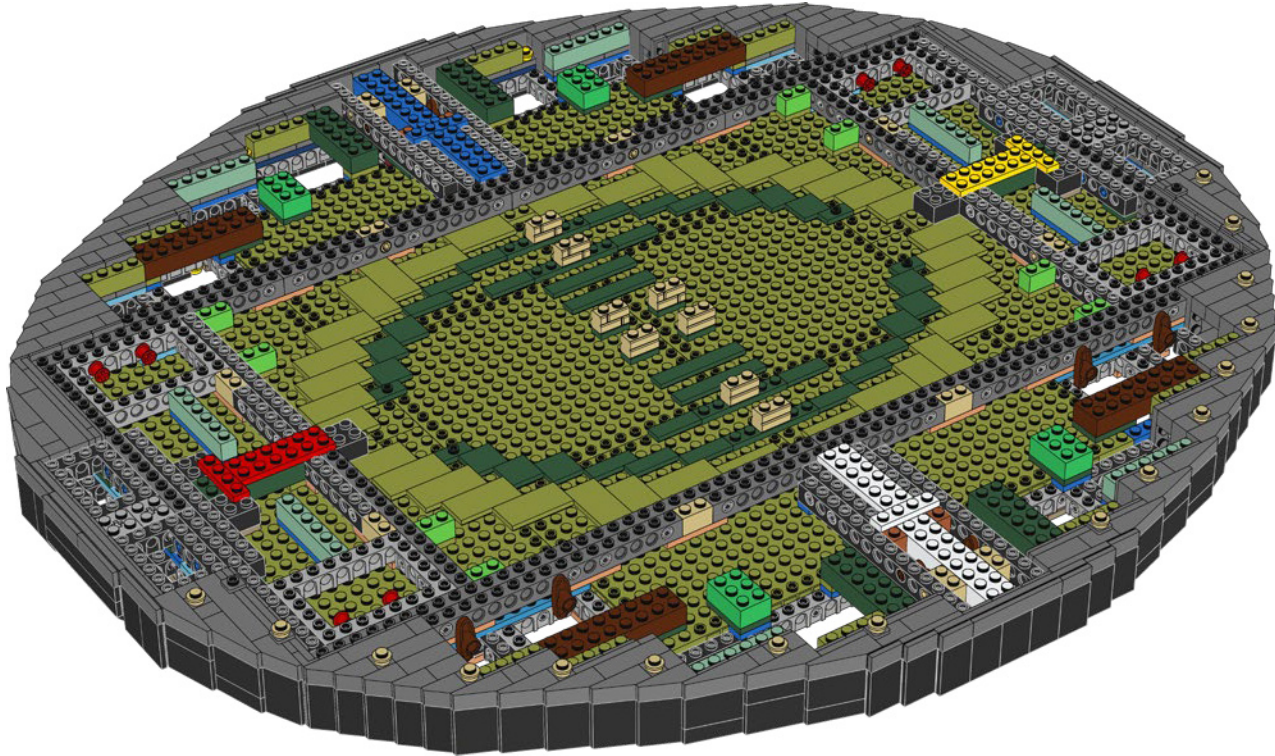
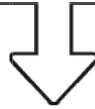

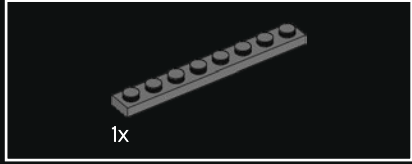
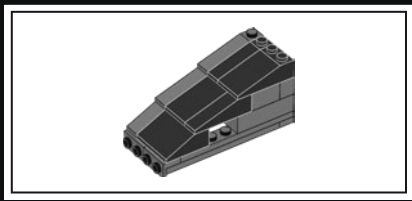

1

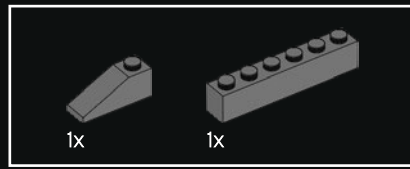
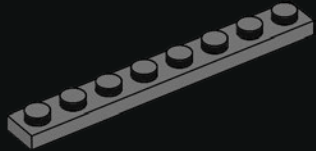

2

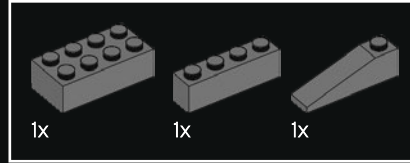
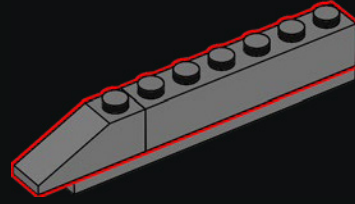

3

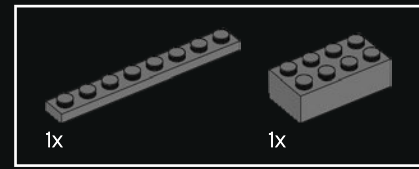
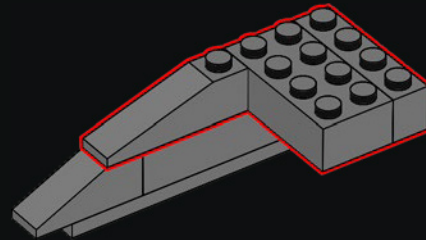

4

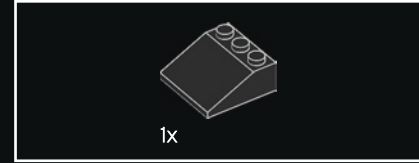
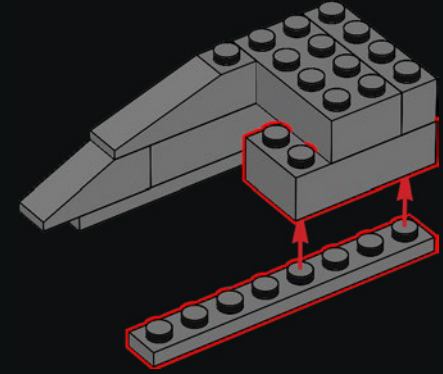

5

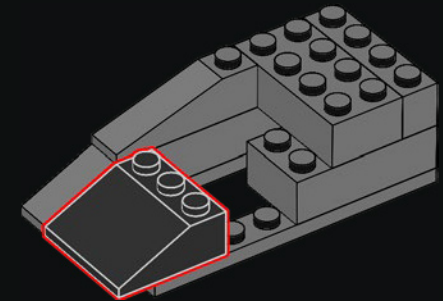

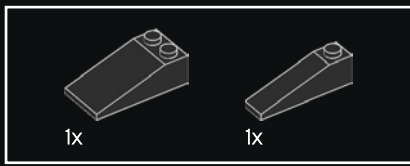

6

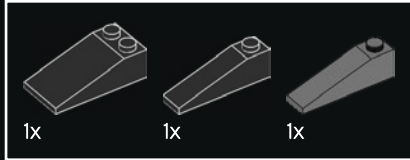
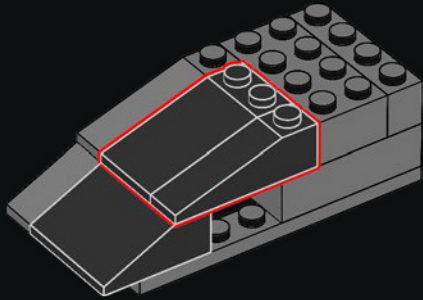

7

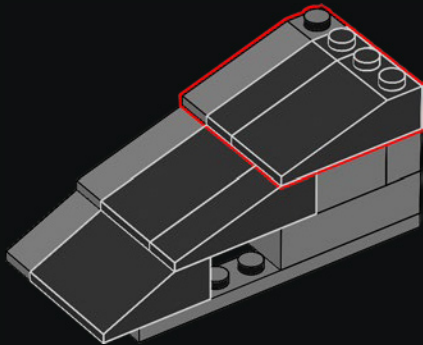

8

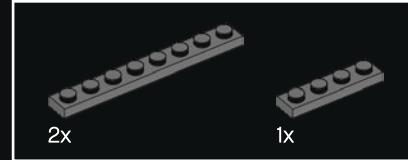
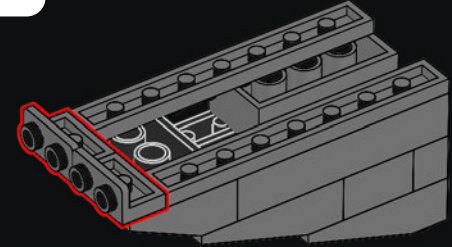

9

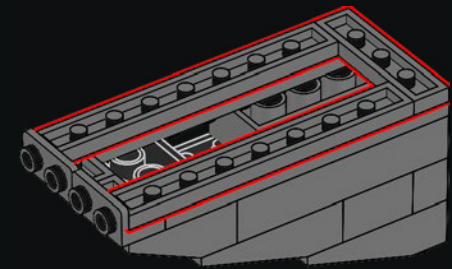

10

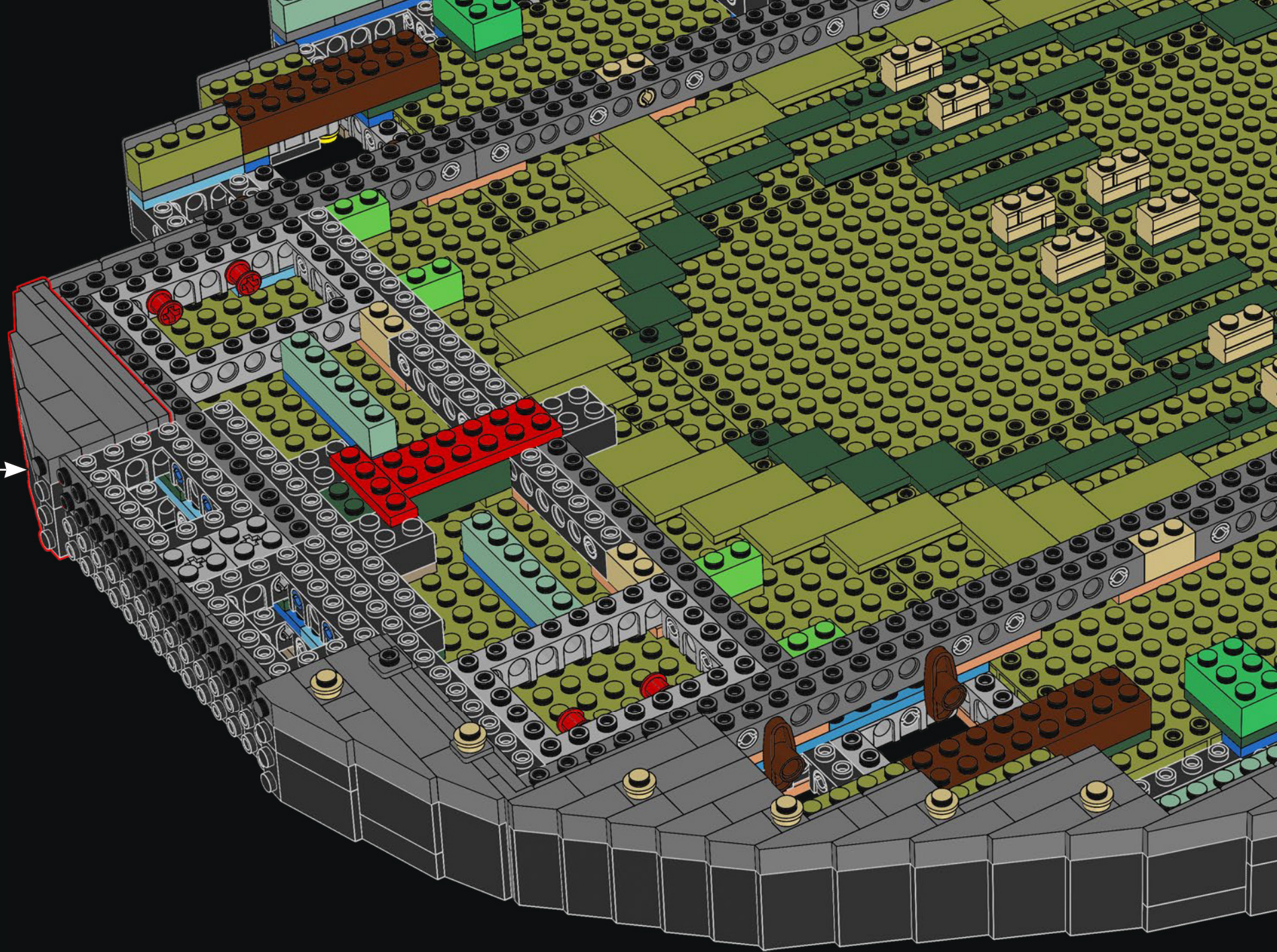

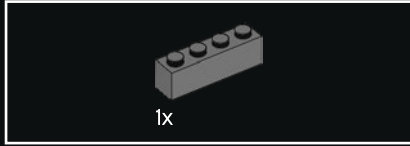
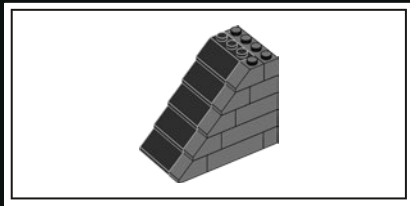

11

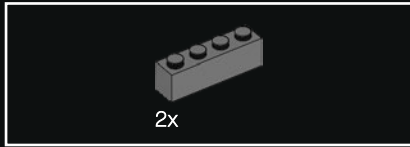
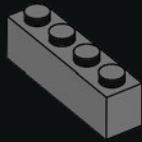

12

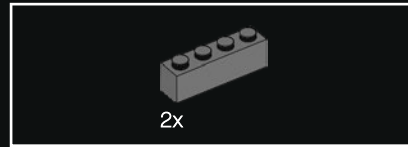
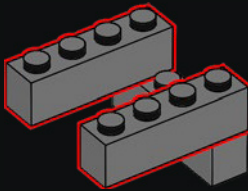

13

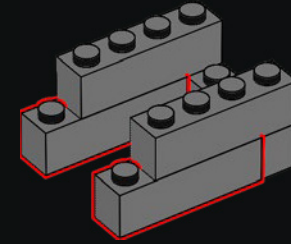

14

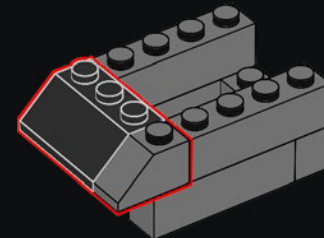

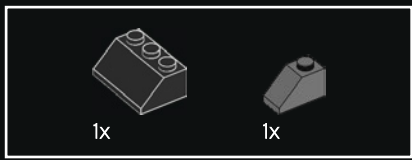

15

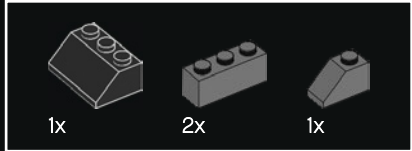
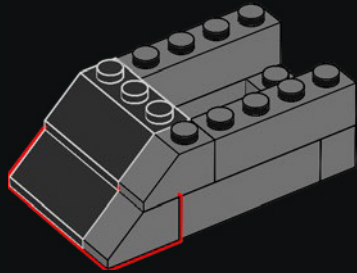

16

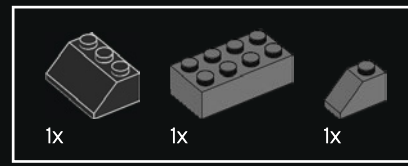
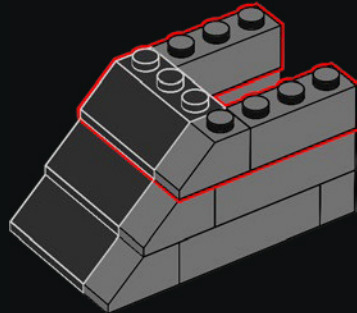

17

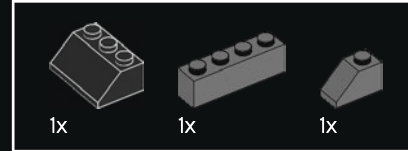
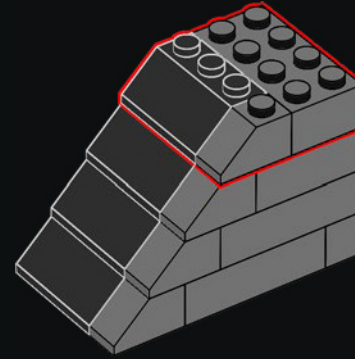

18

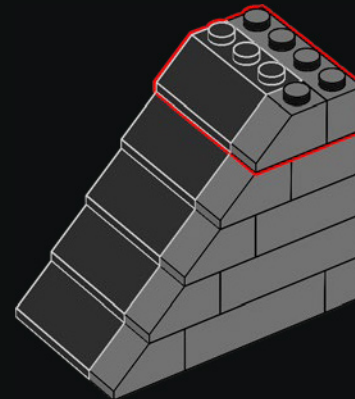

19

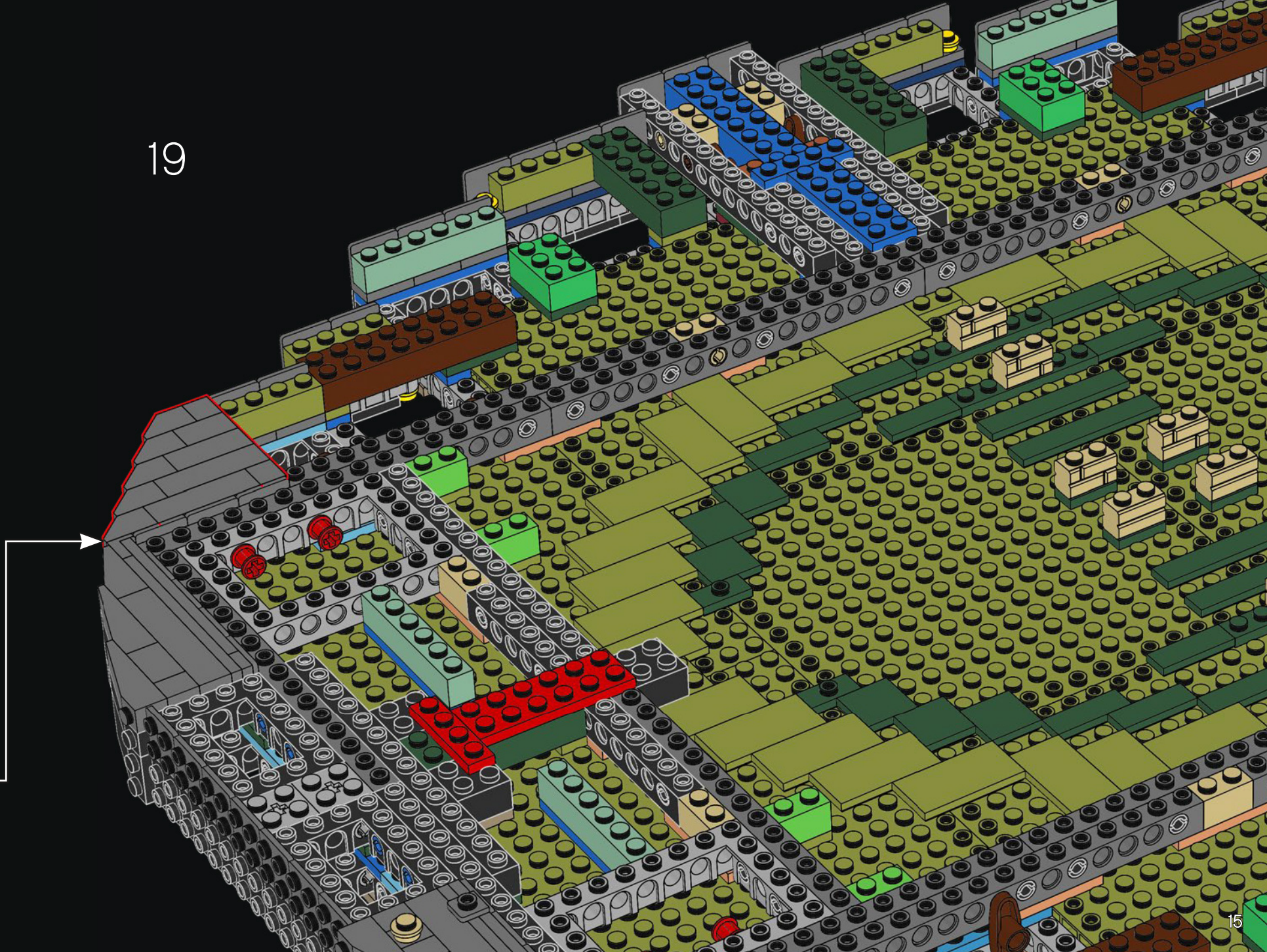

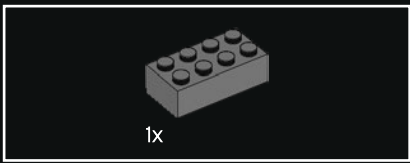

20

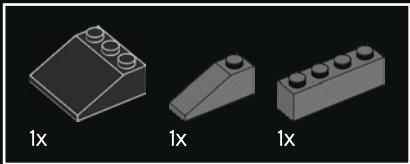
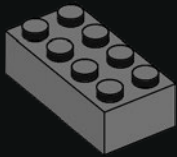

21

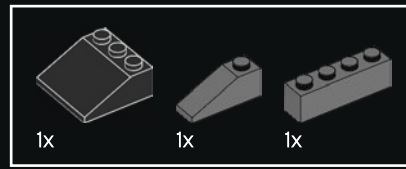
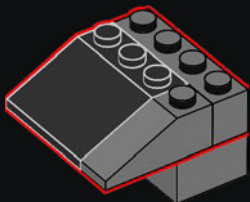

22

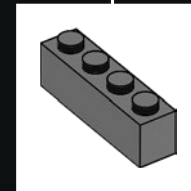
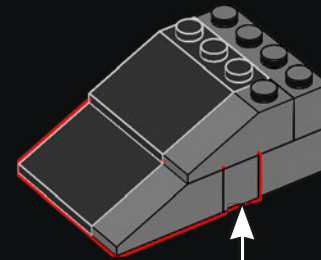

23

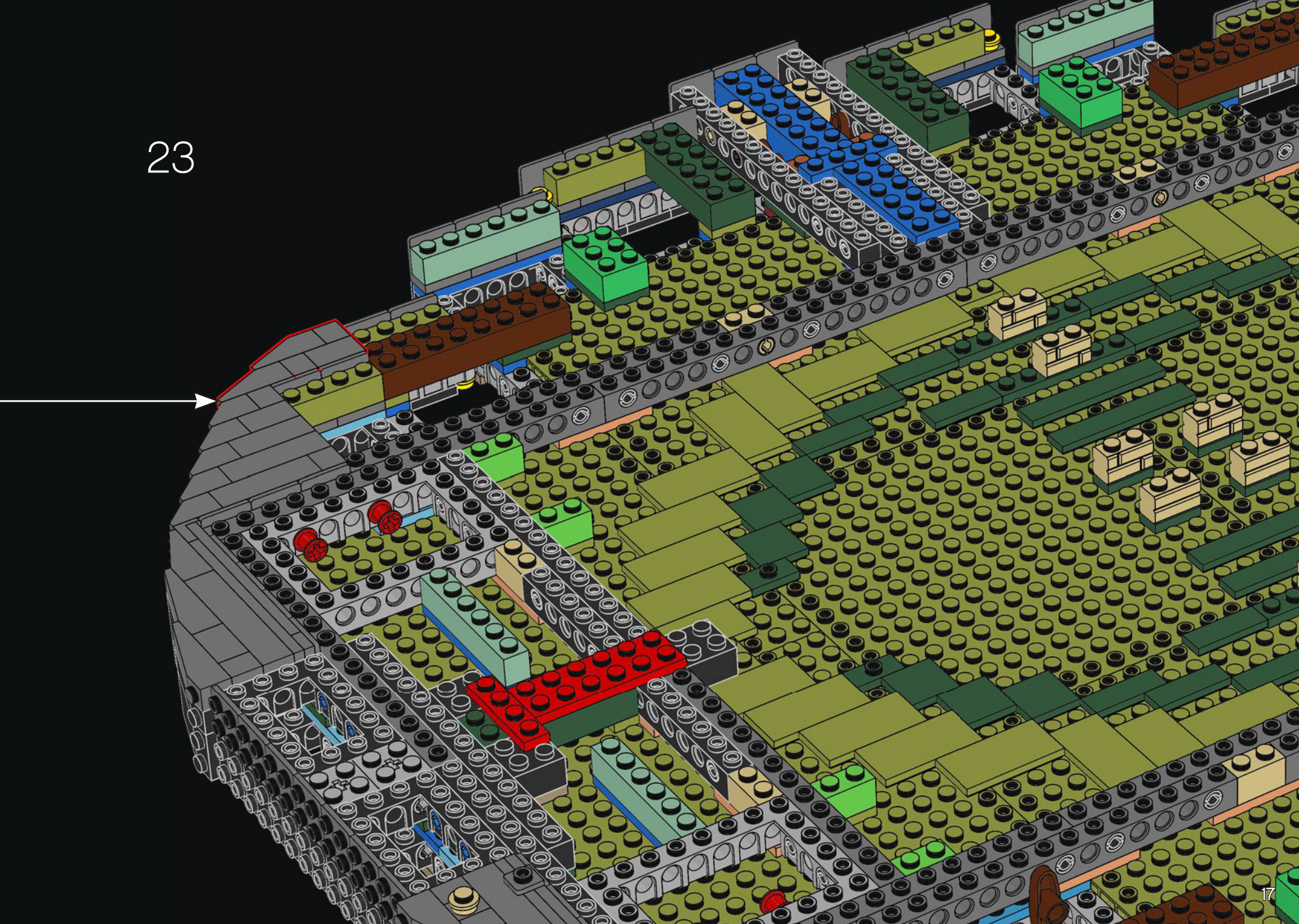

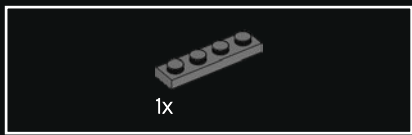

24

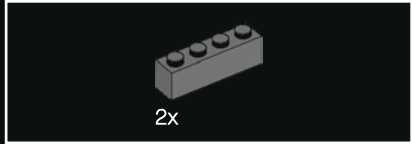
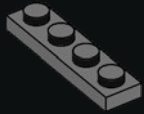

25

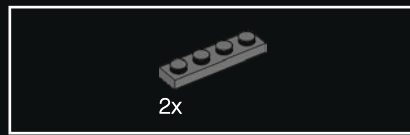
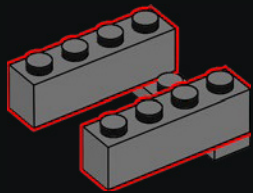

26

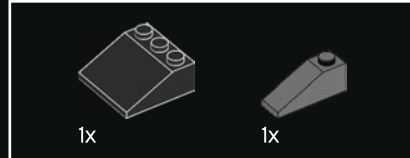
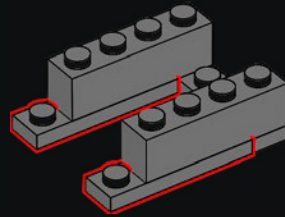

27

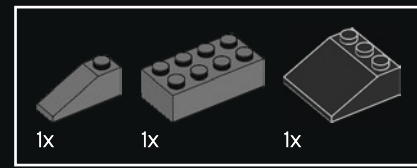
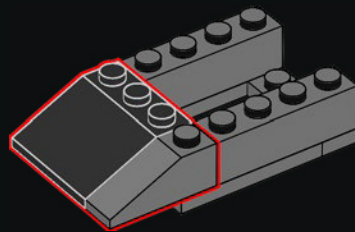

28

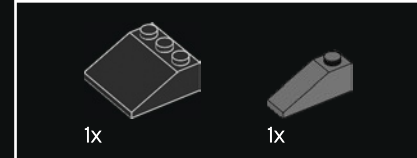
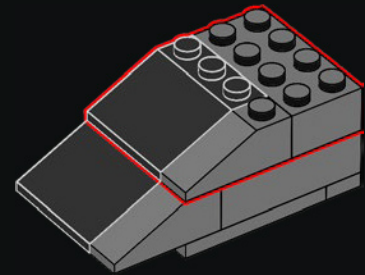

29

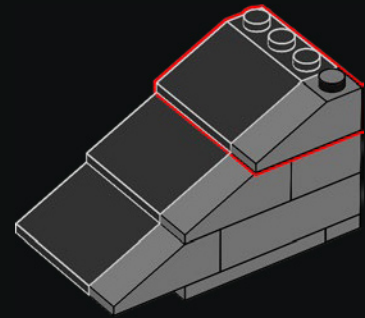

30

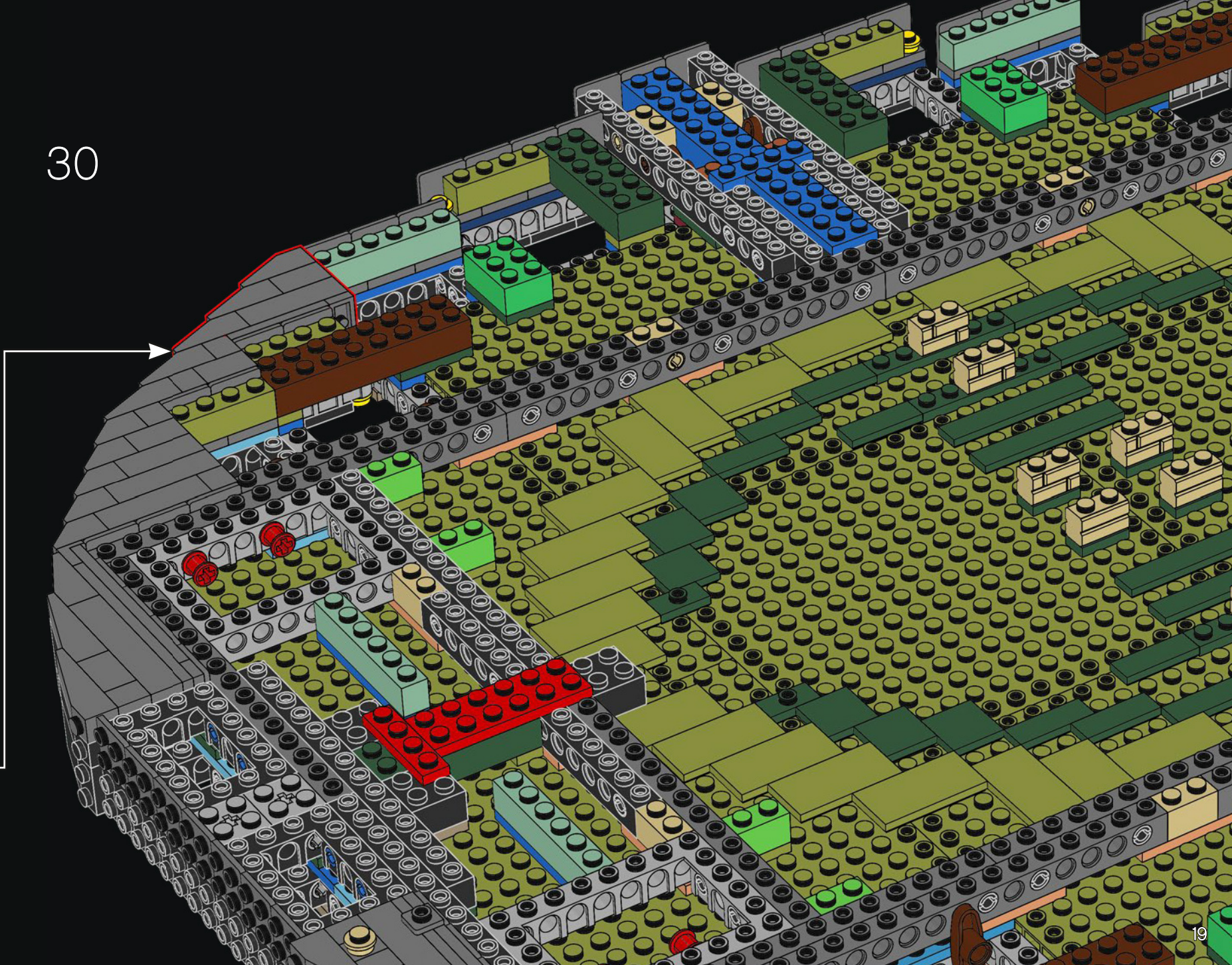

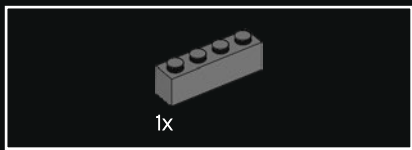

31

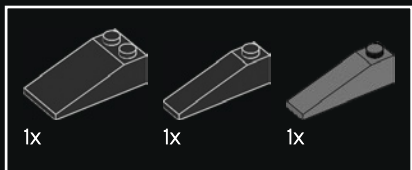
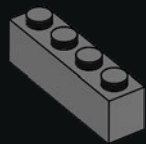

32

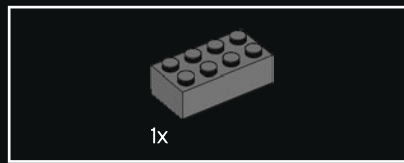
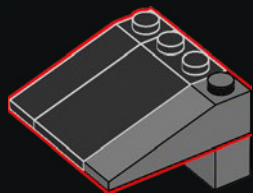

33

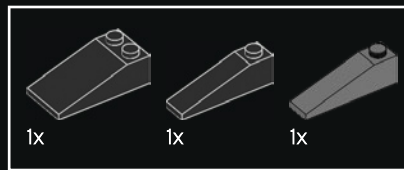
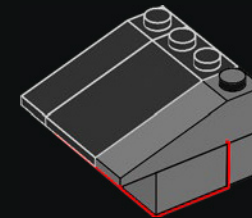

34

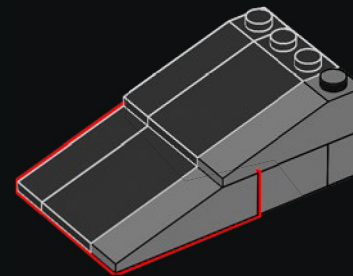

35

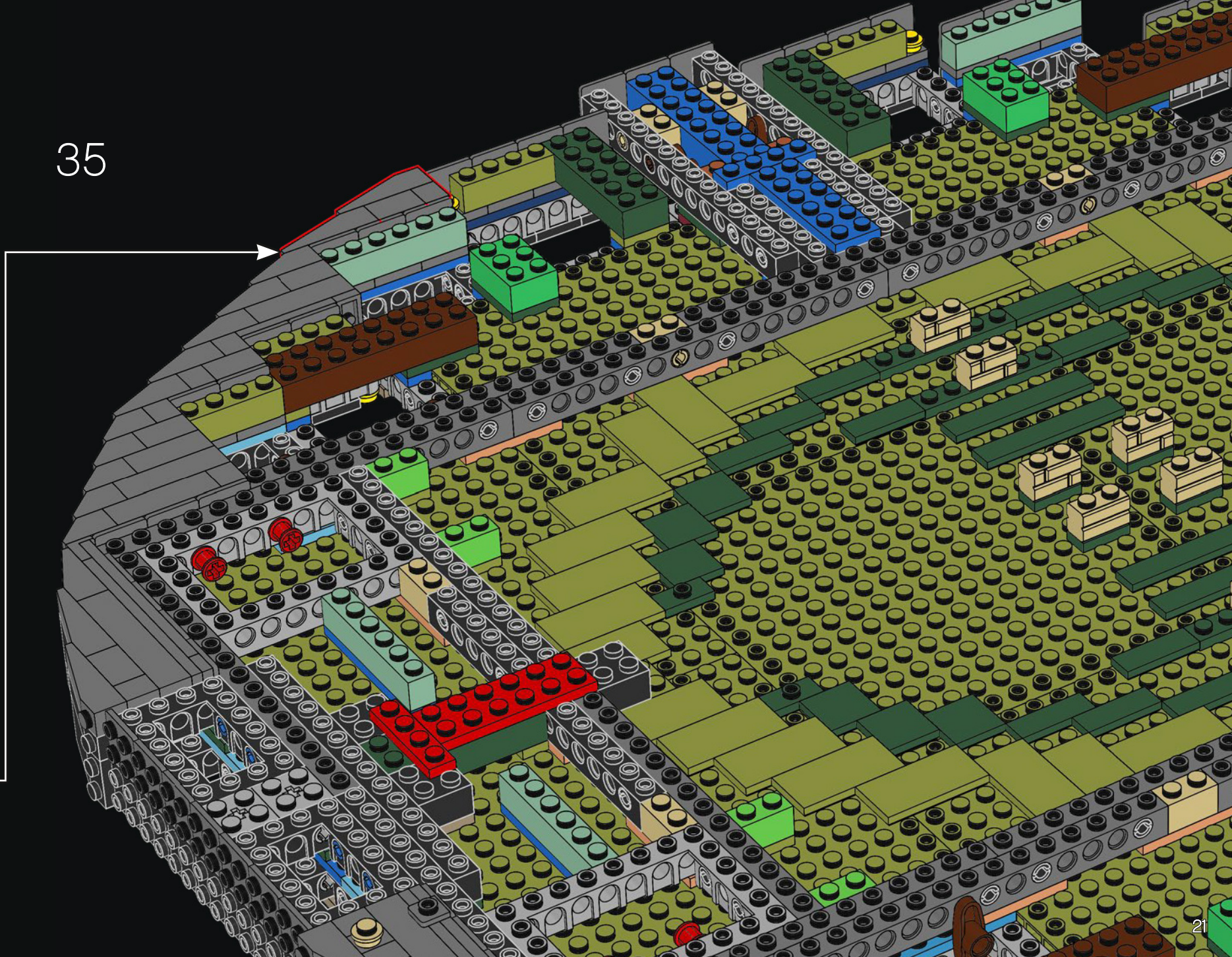

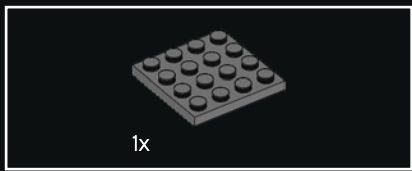

36

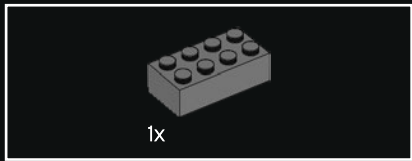

37

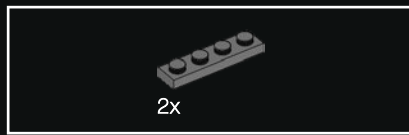
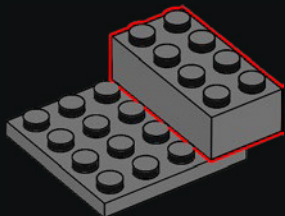

38

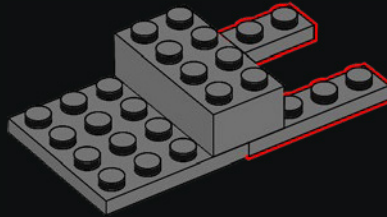

39

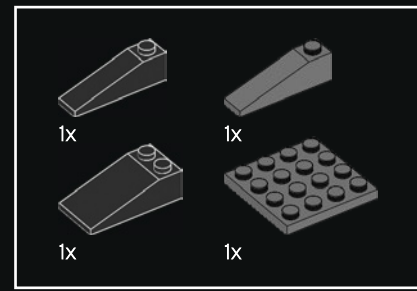
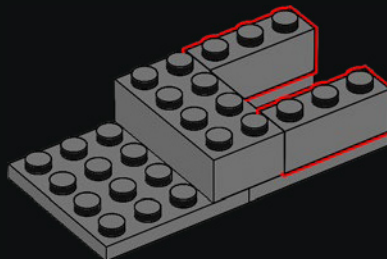

40

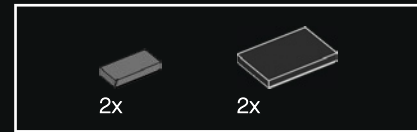
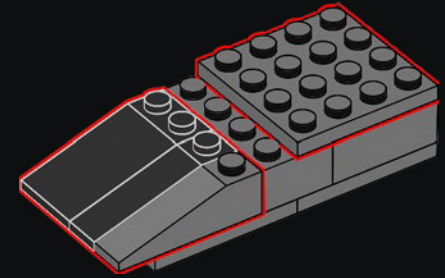

41

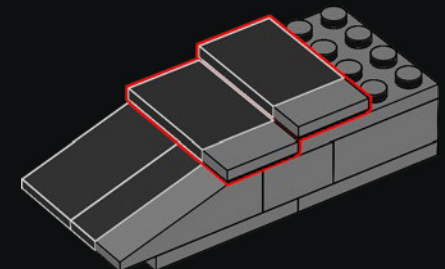

42

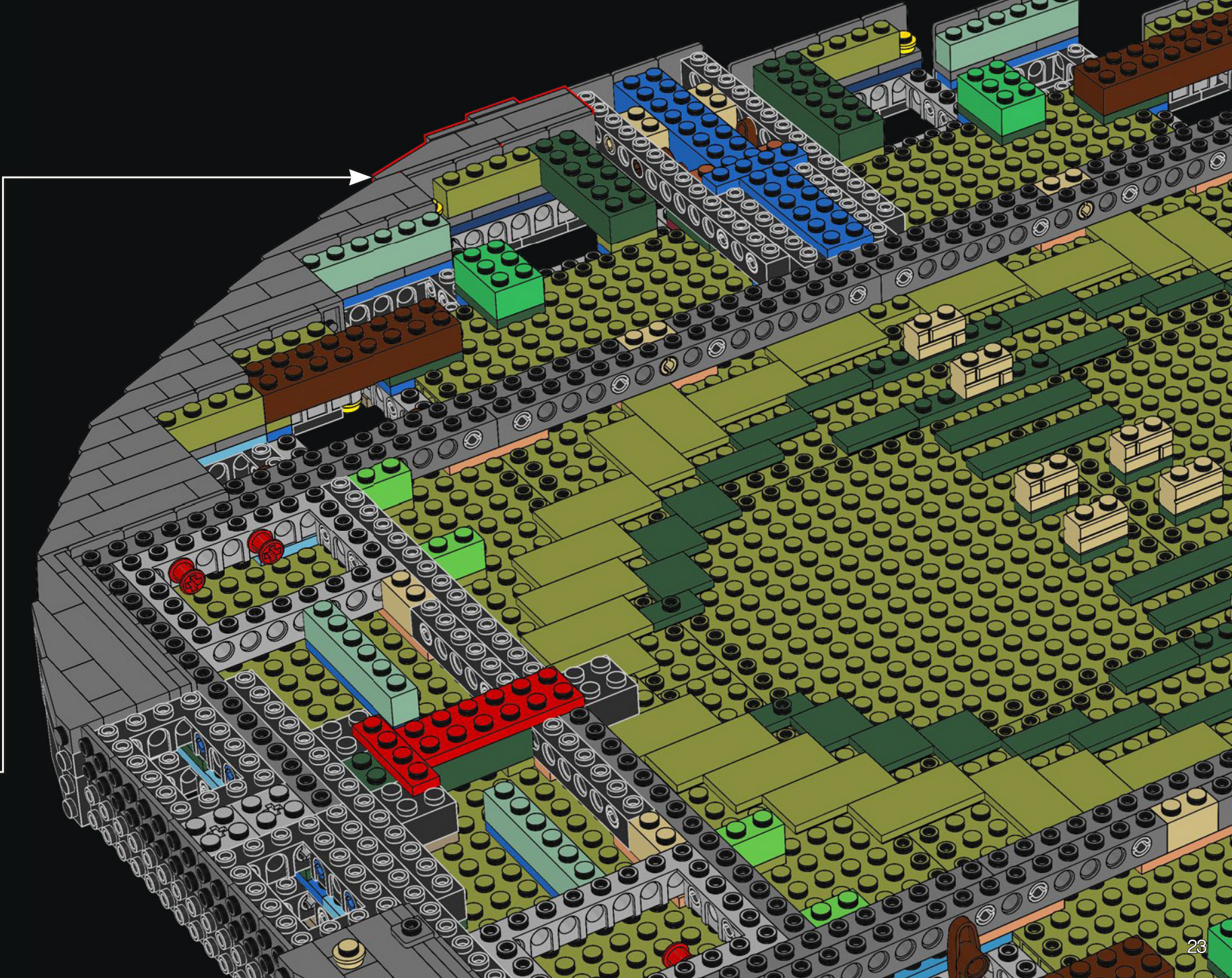

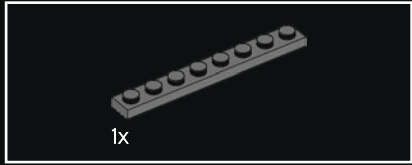
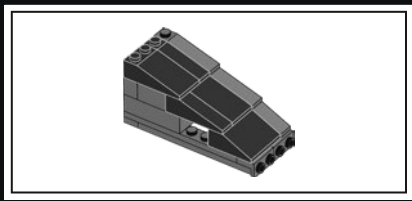

43

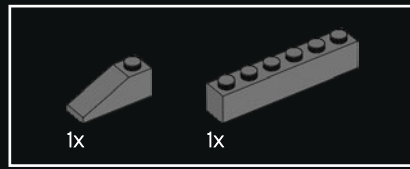
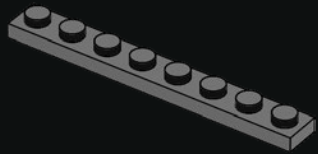

44

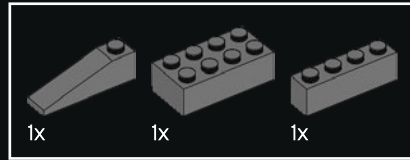
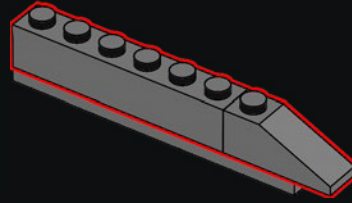

45

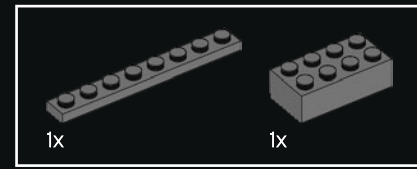
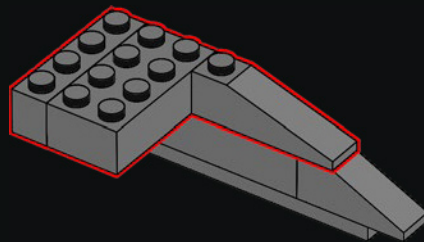

46

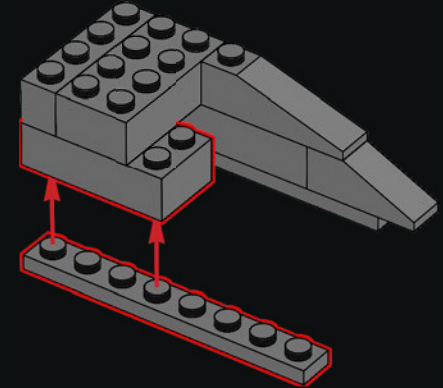

47

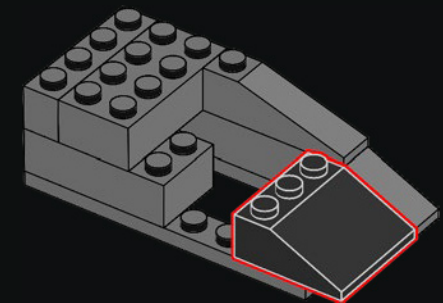

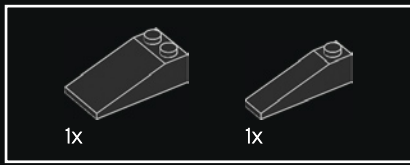

48

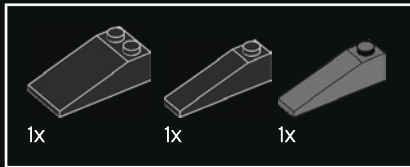
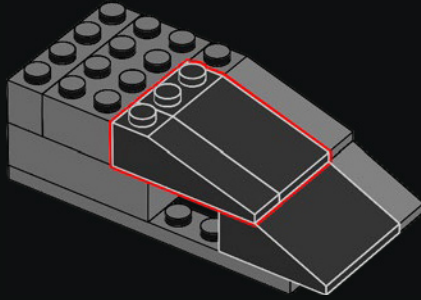

49

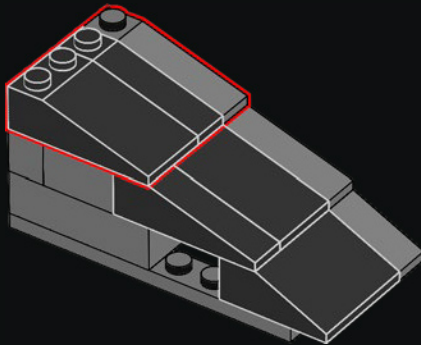

50

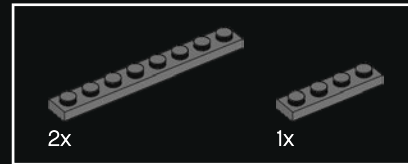
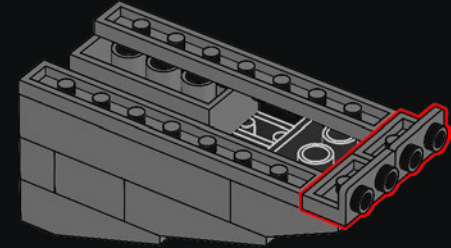

51

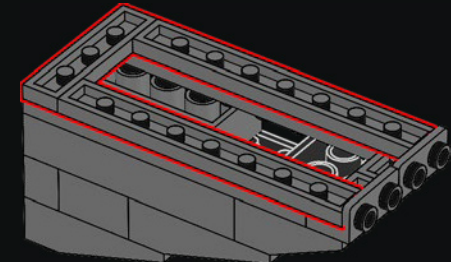

52



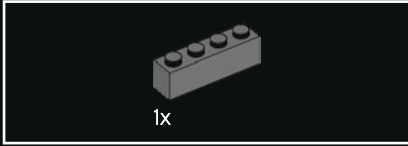
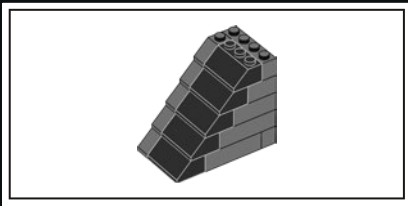

53

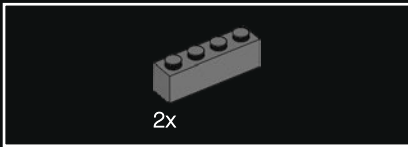
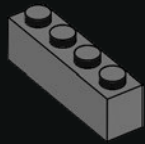

54

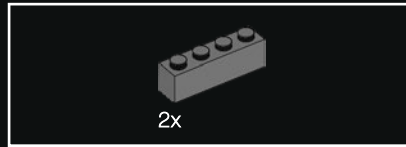
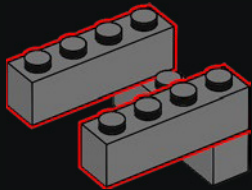

55

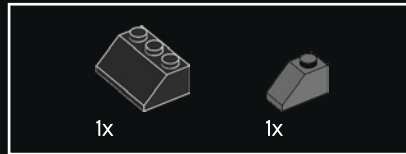
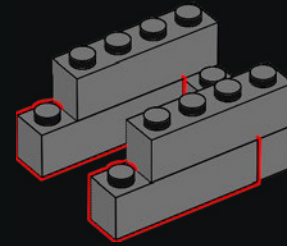

56

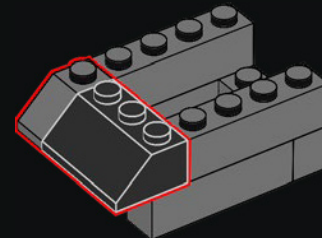

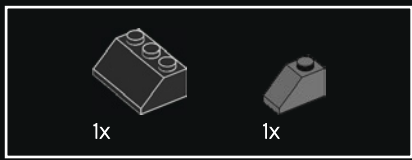

57

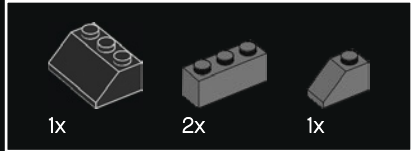
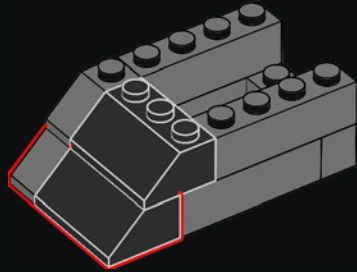

58

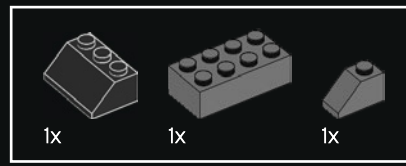
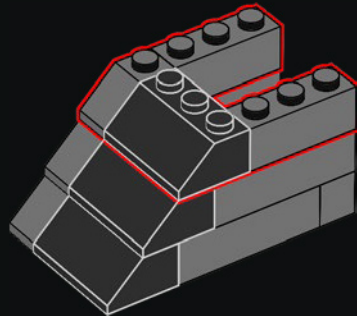

59

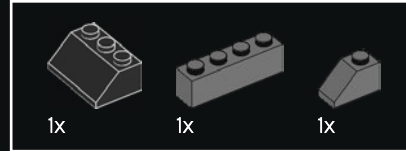
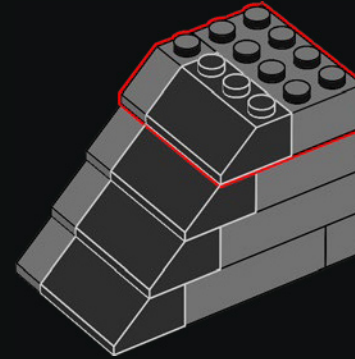

60

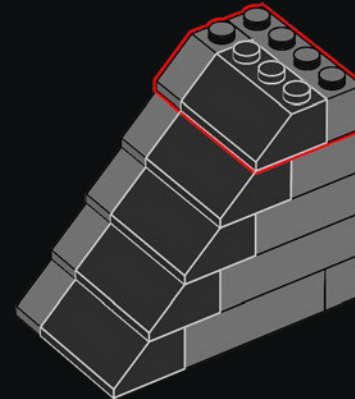

61



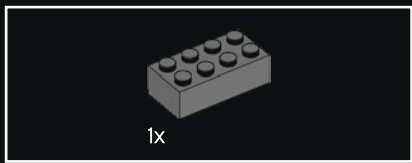

62

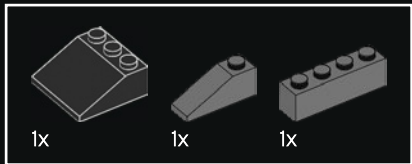
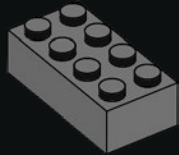

63

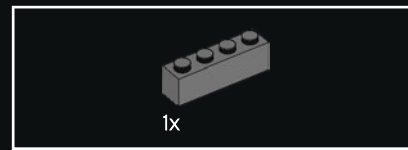
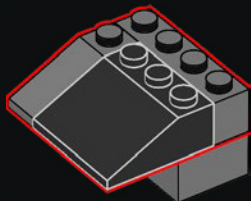

64

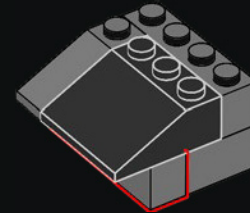

65

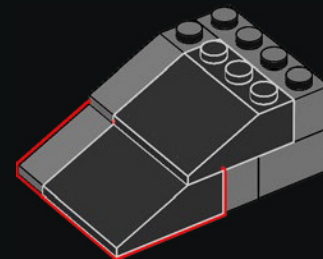

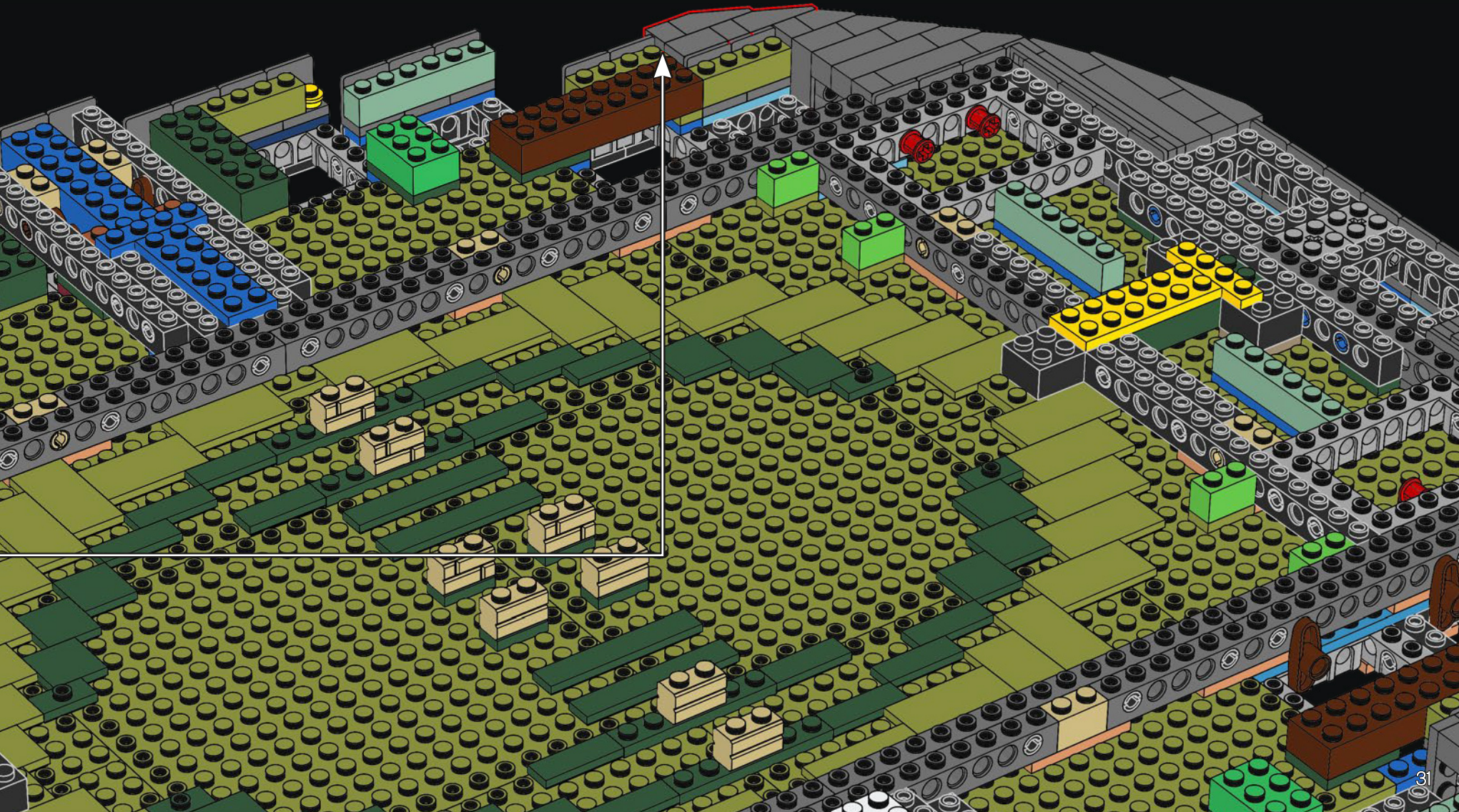

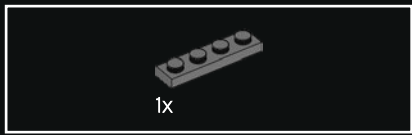

67

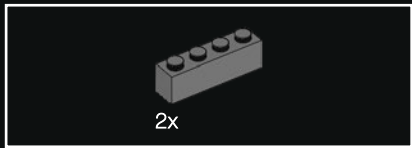
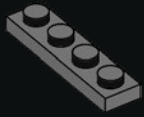

68

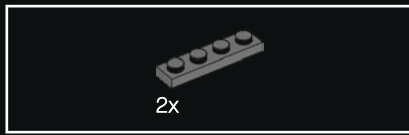
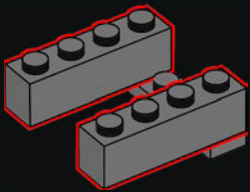

69

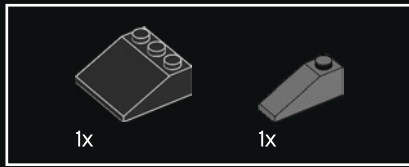
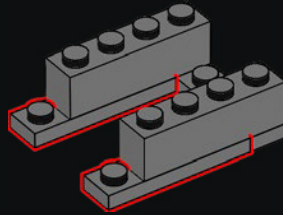

70

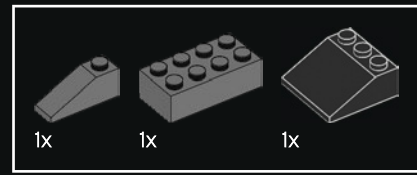
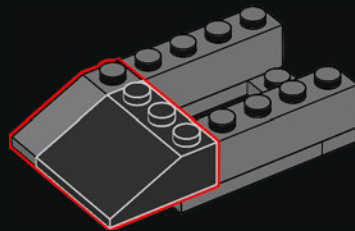

71

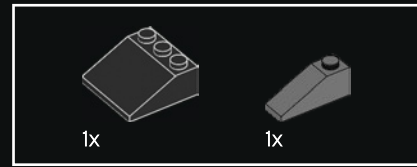
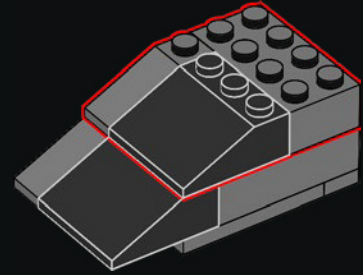

72

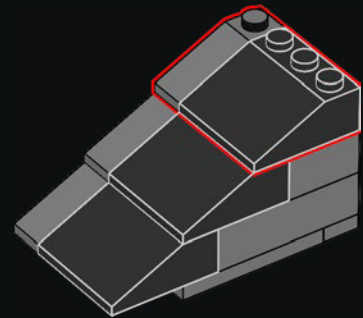

73



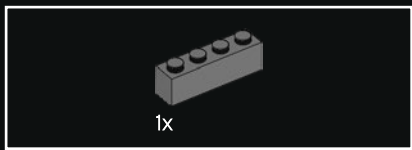

74

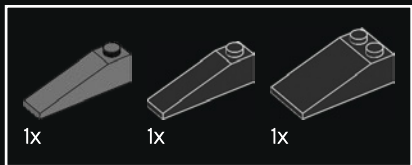
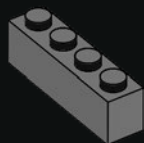

75

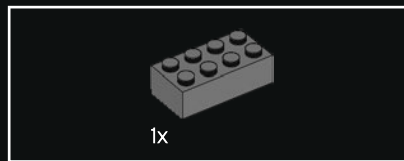
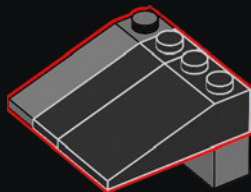

76

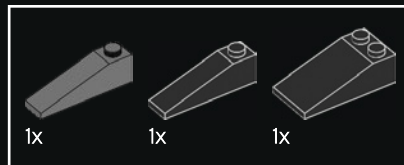
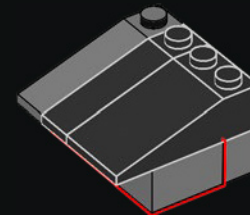

77

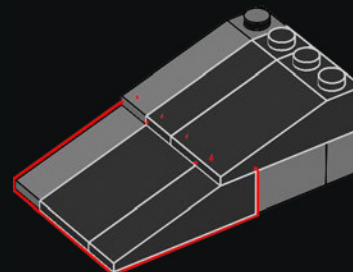



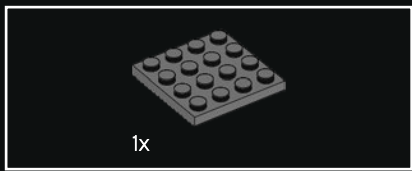

1x

79

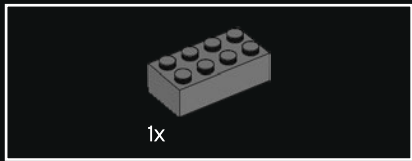
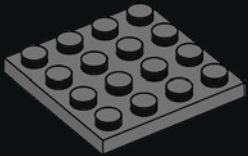

1x

80

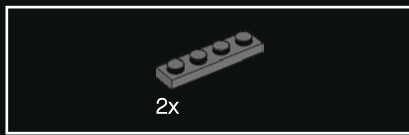
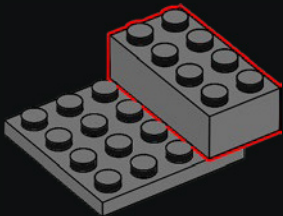

2x

81

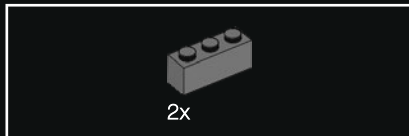
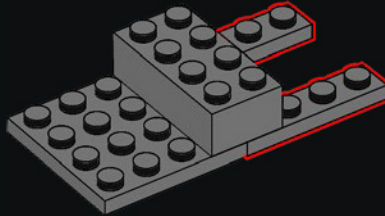

2x

82

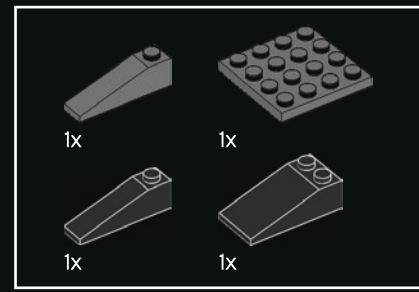
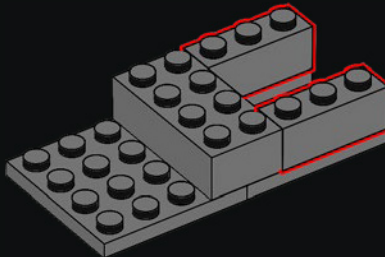

1x

1x

1x

1x

83

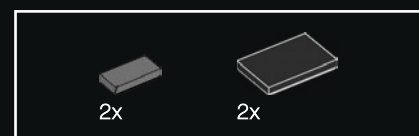
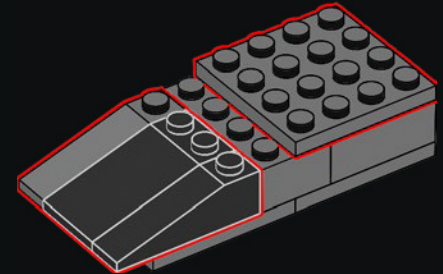

2x

2x

84

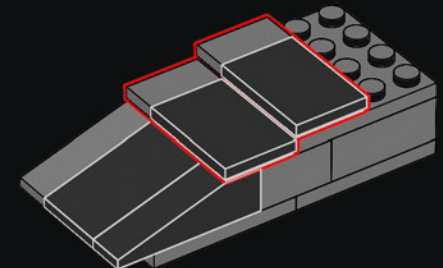

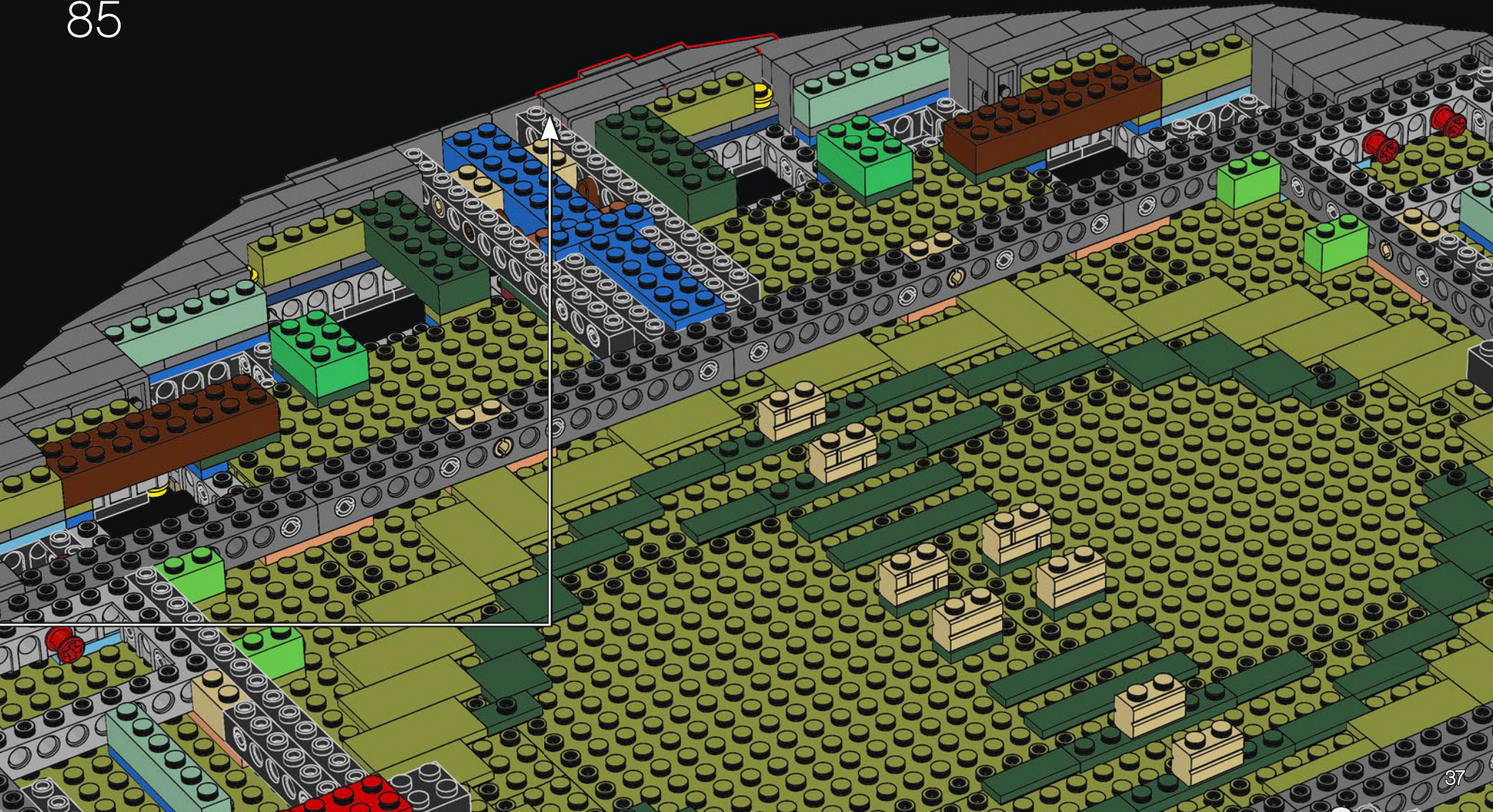

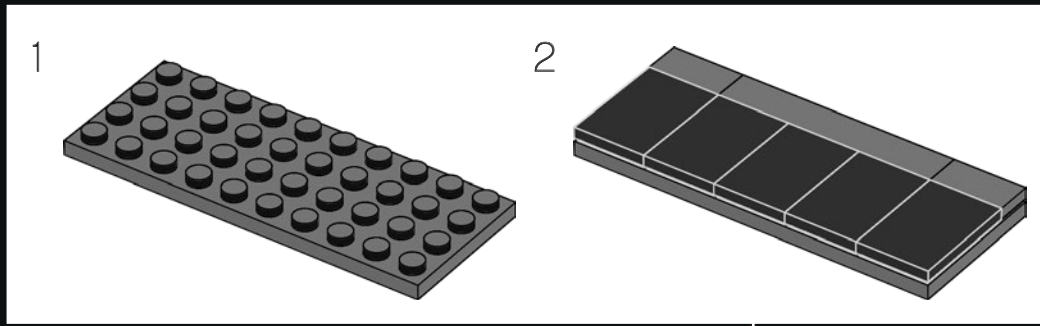
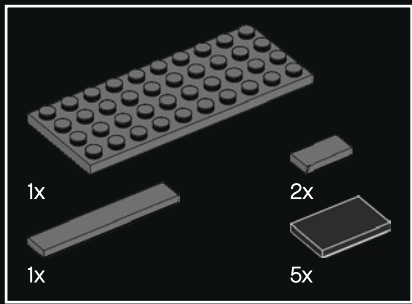

86

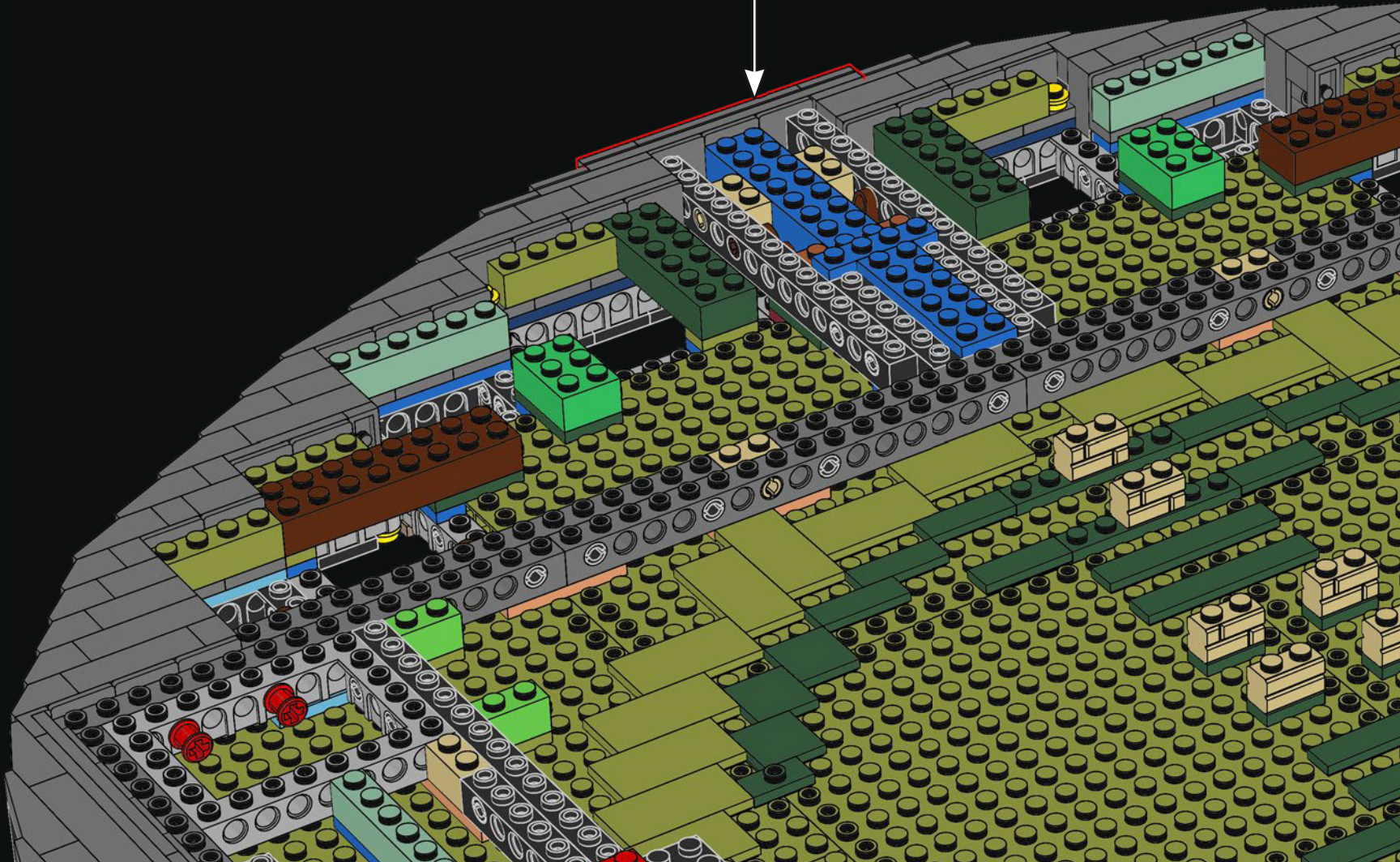

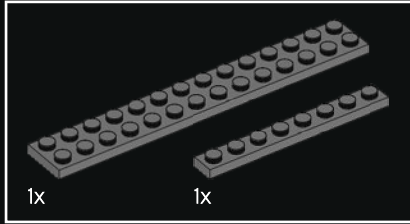
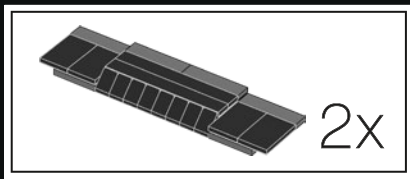

87

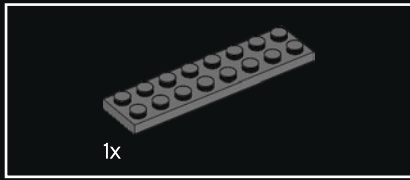
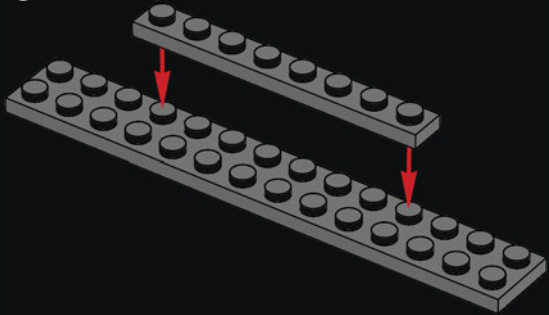

88

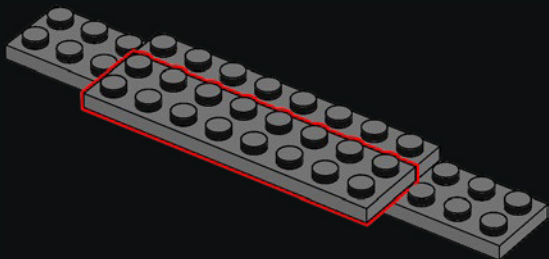

89

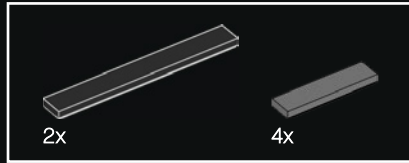
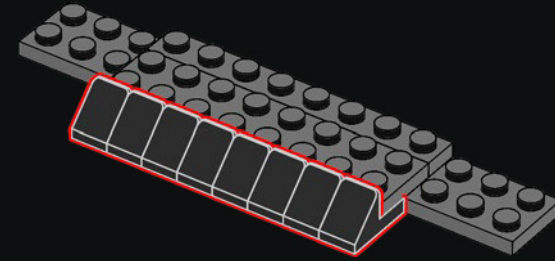

90

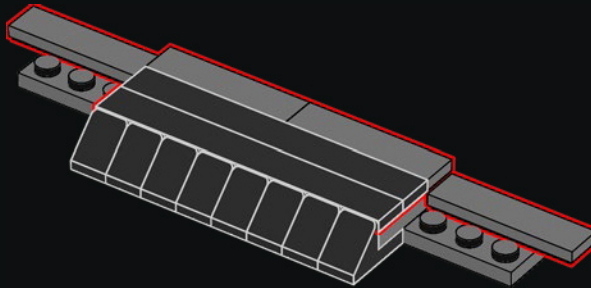

91

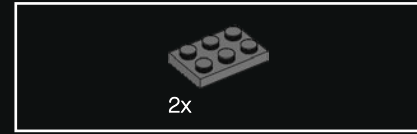
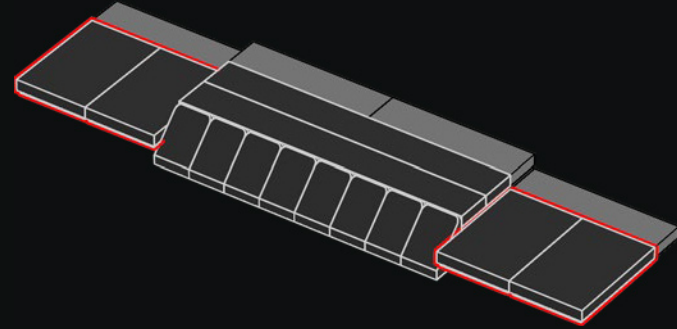

92

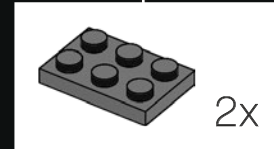
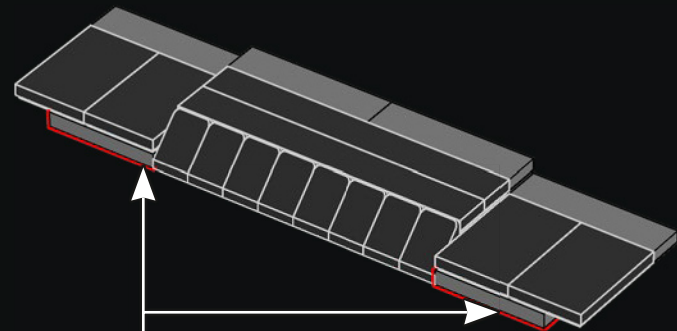

93

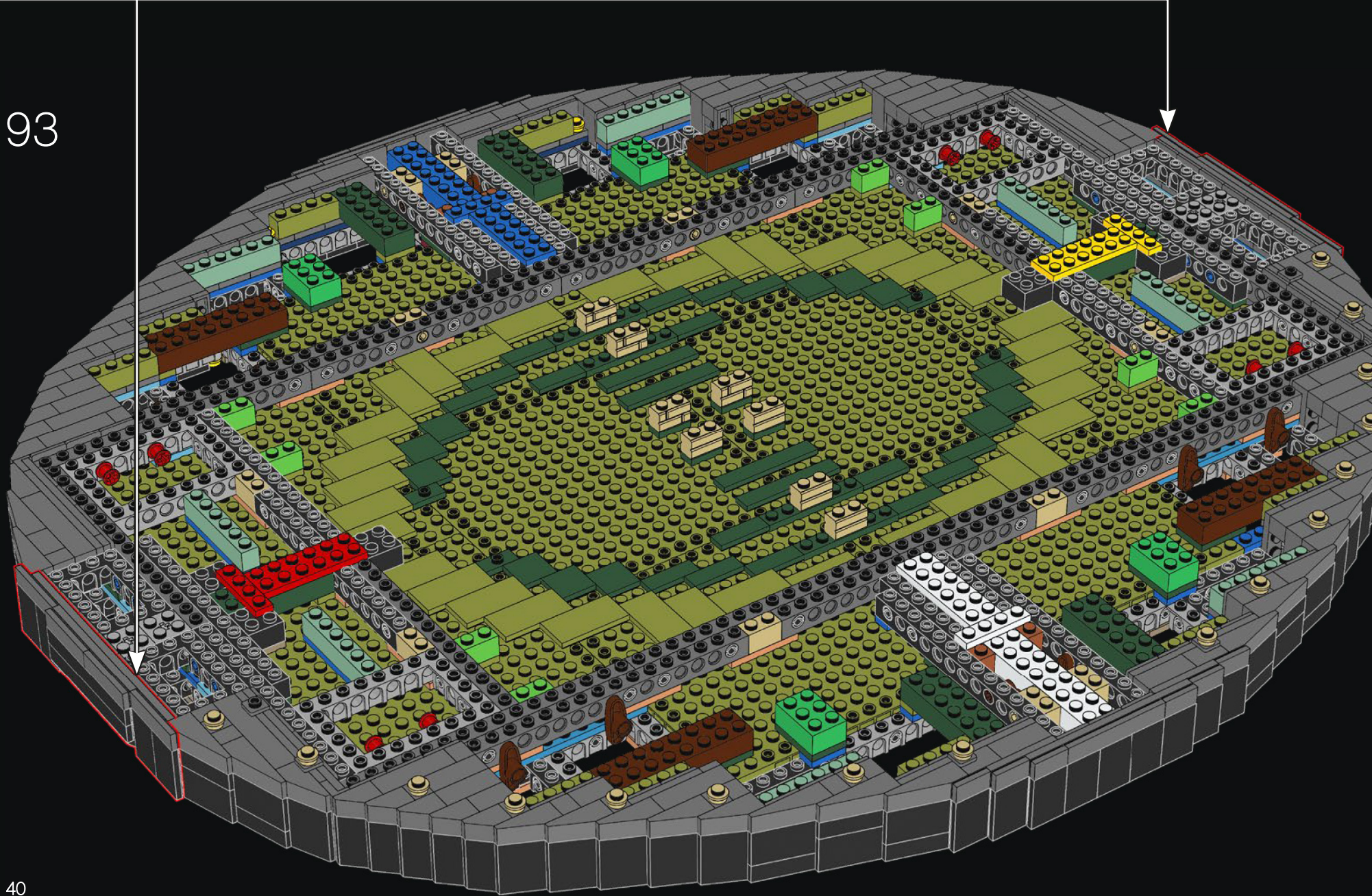

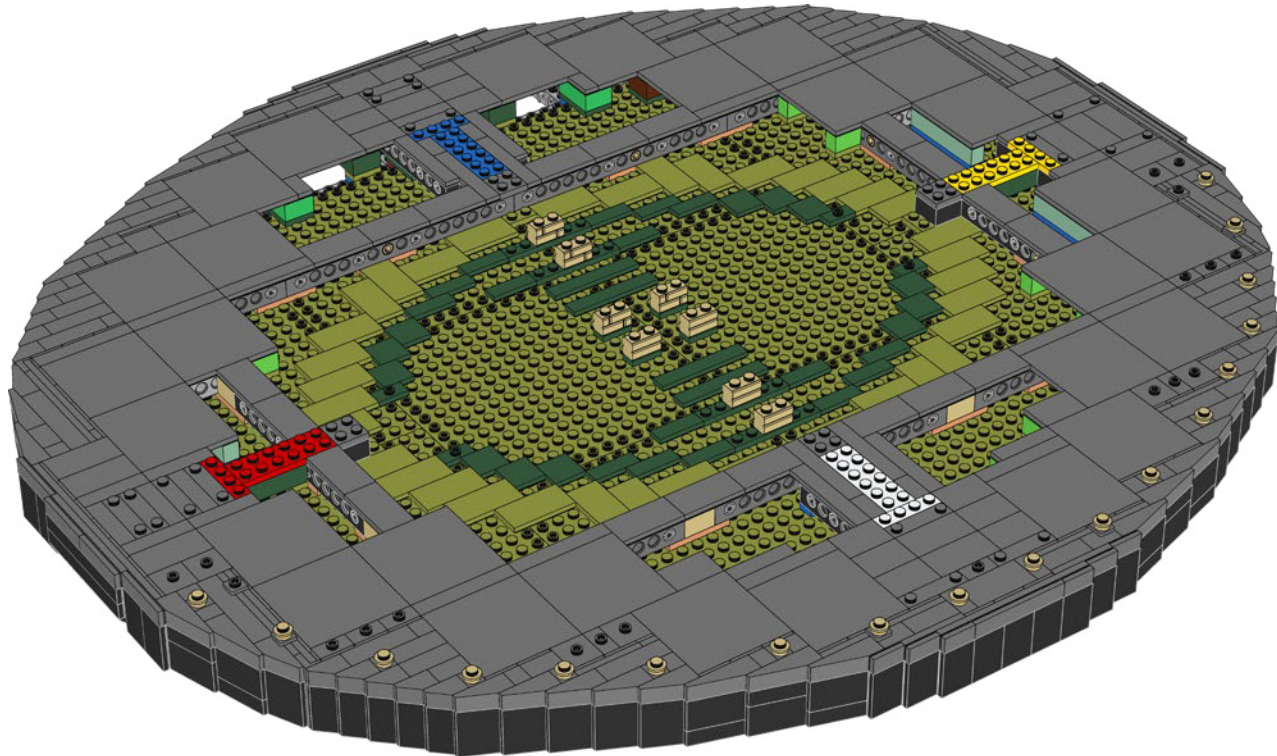
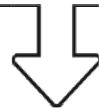

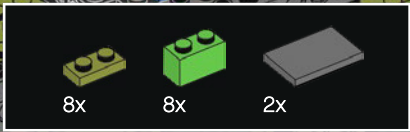

94

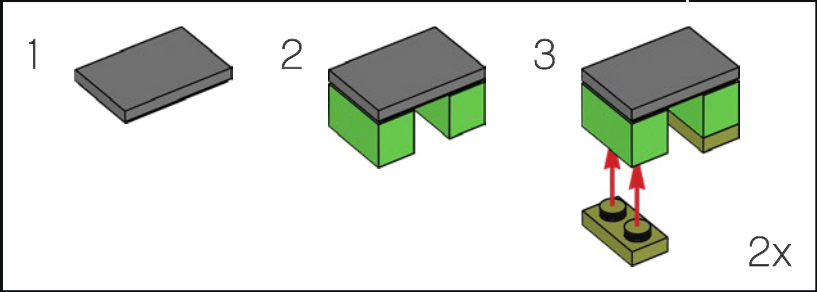
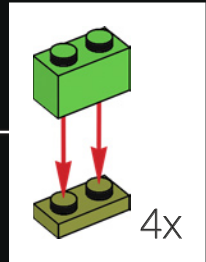

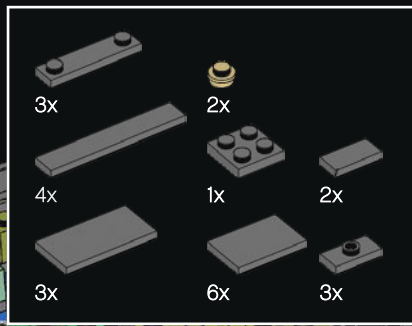

95

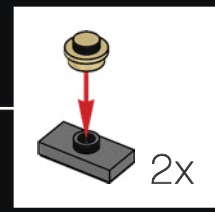

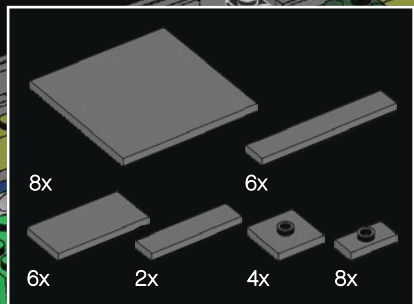

96



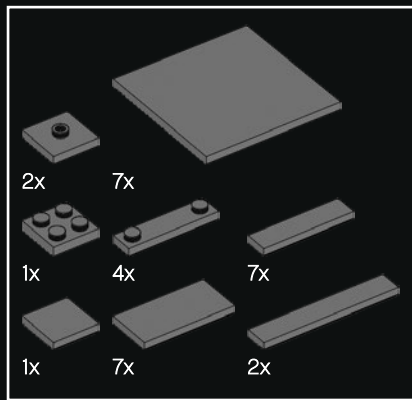

97

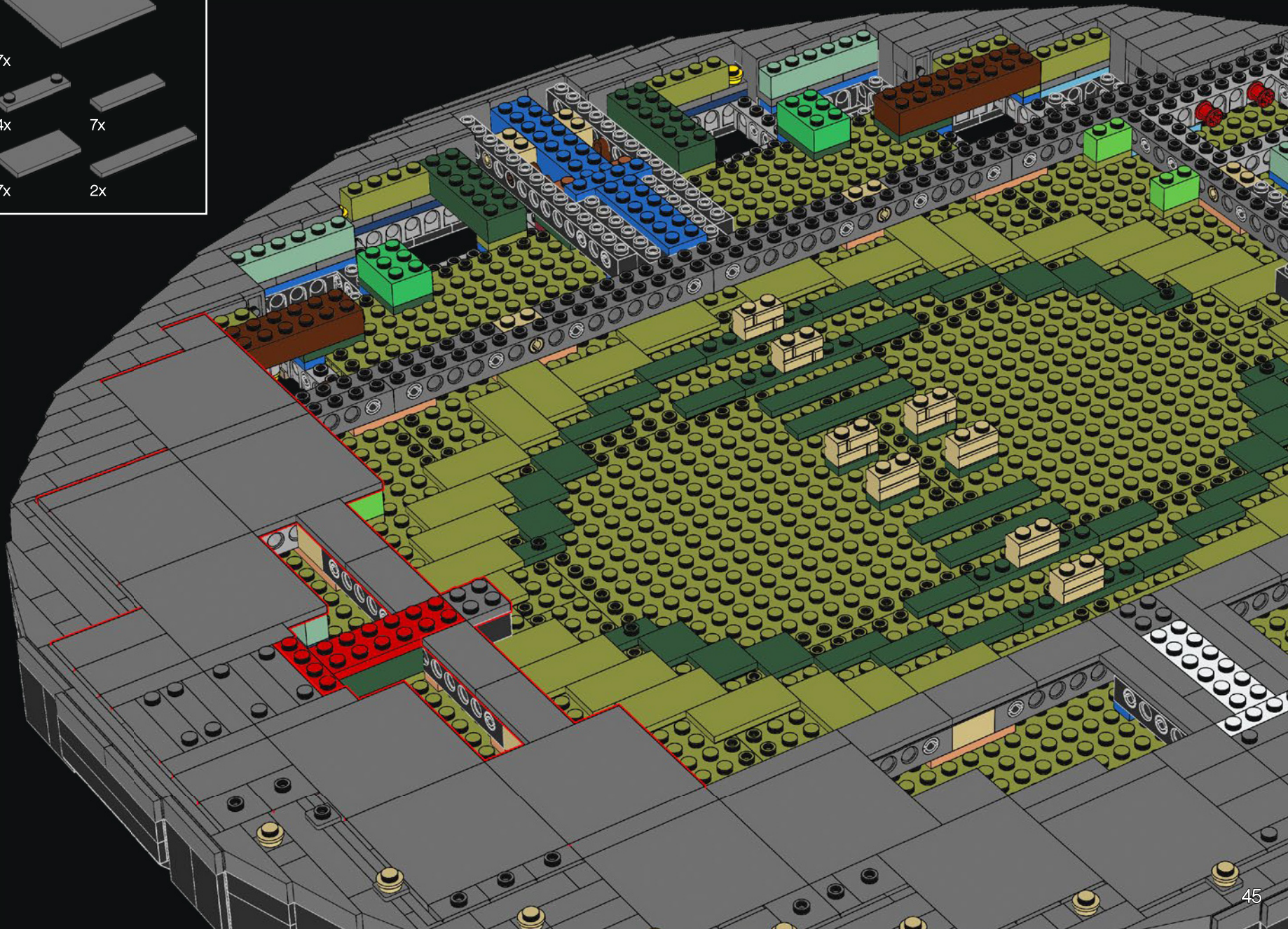

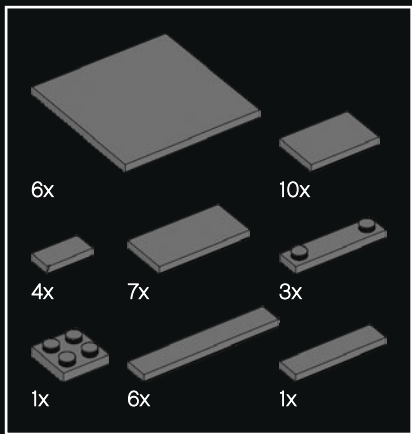

98

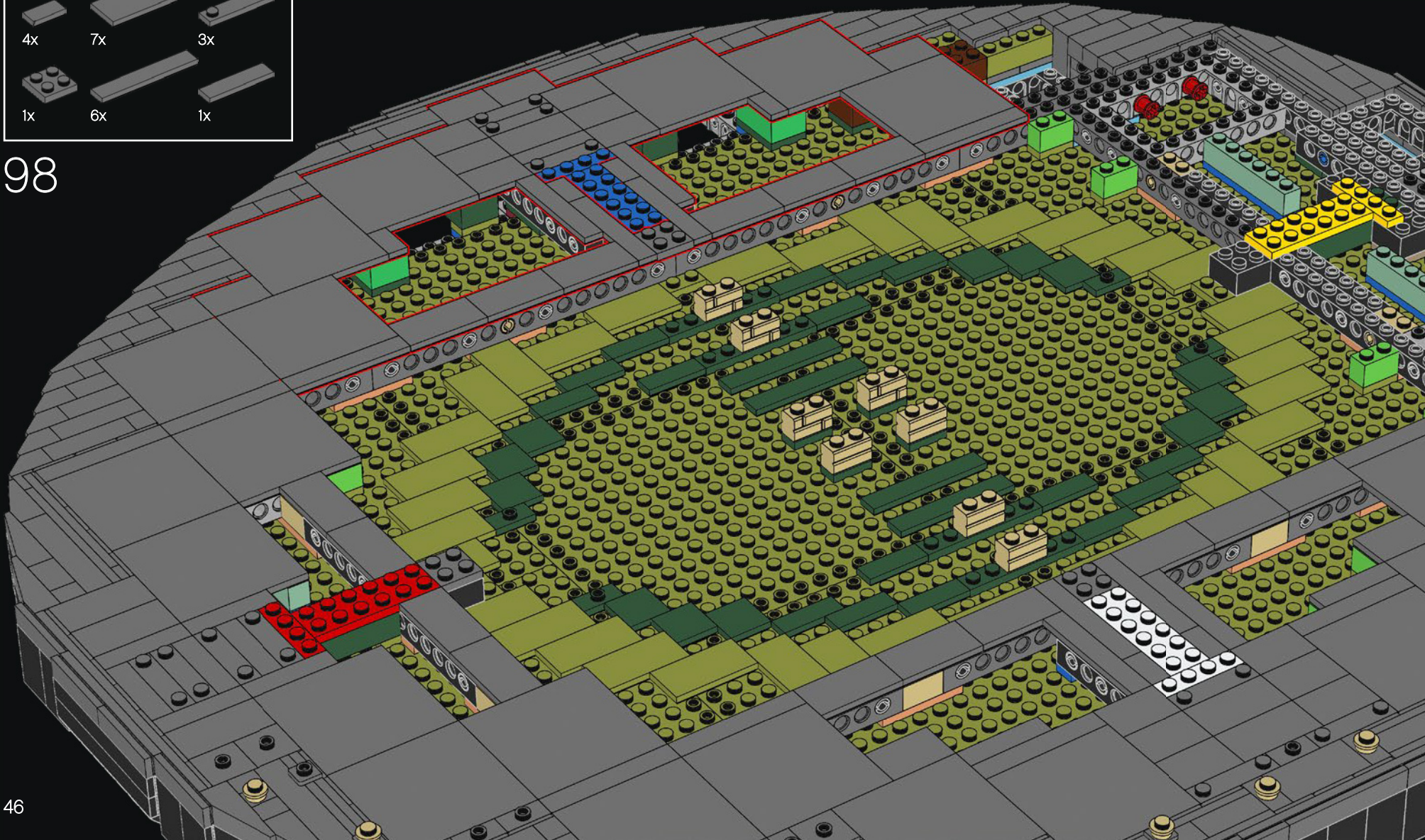

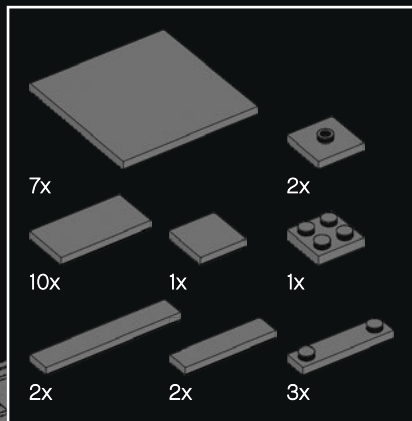

99



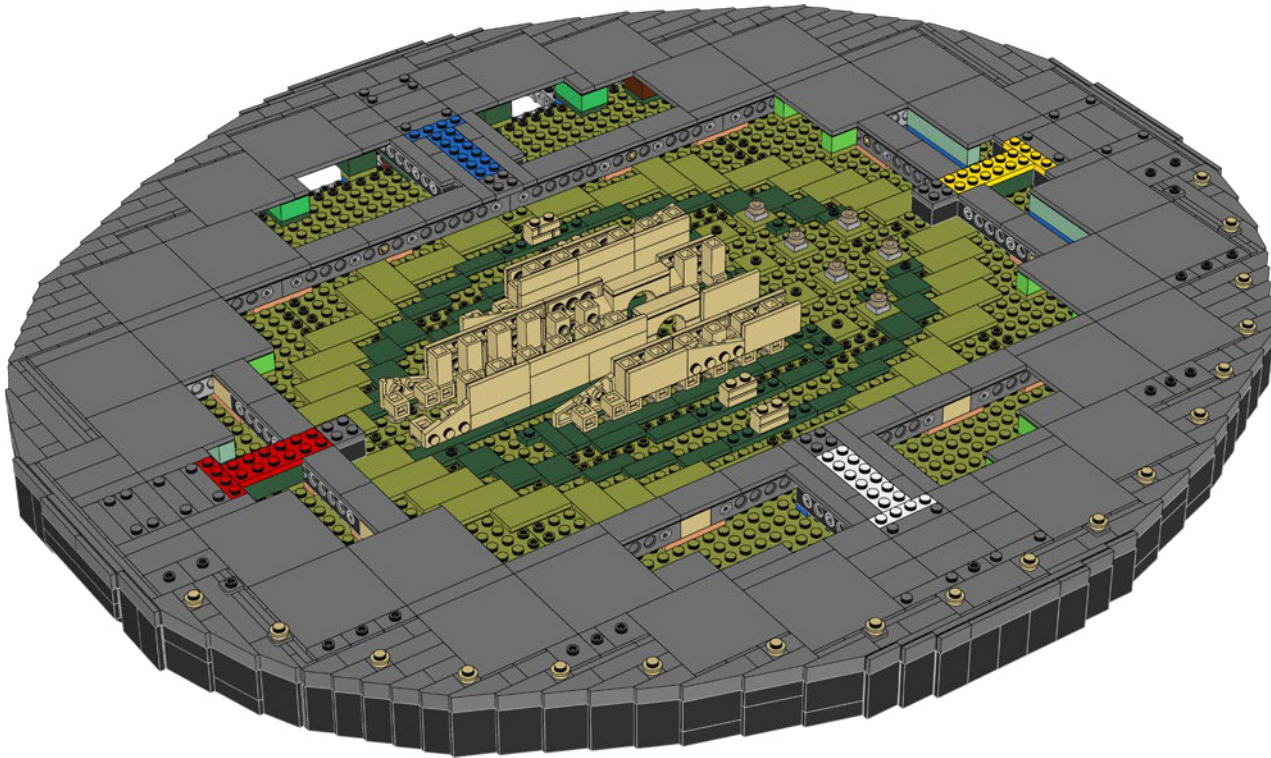
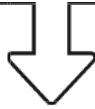



100

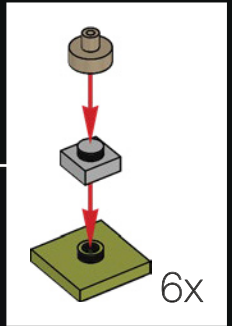

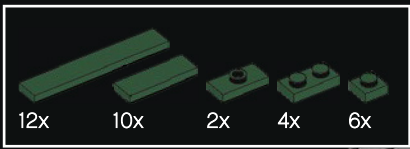

101





102

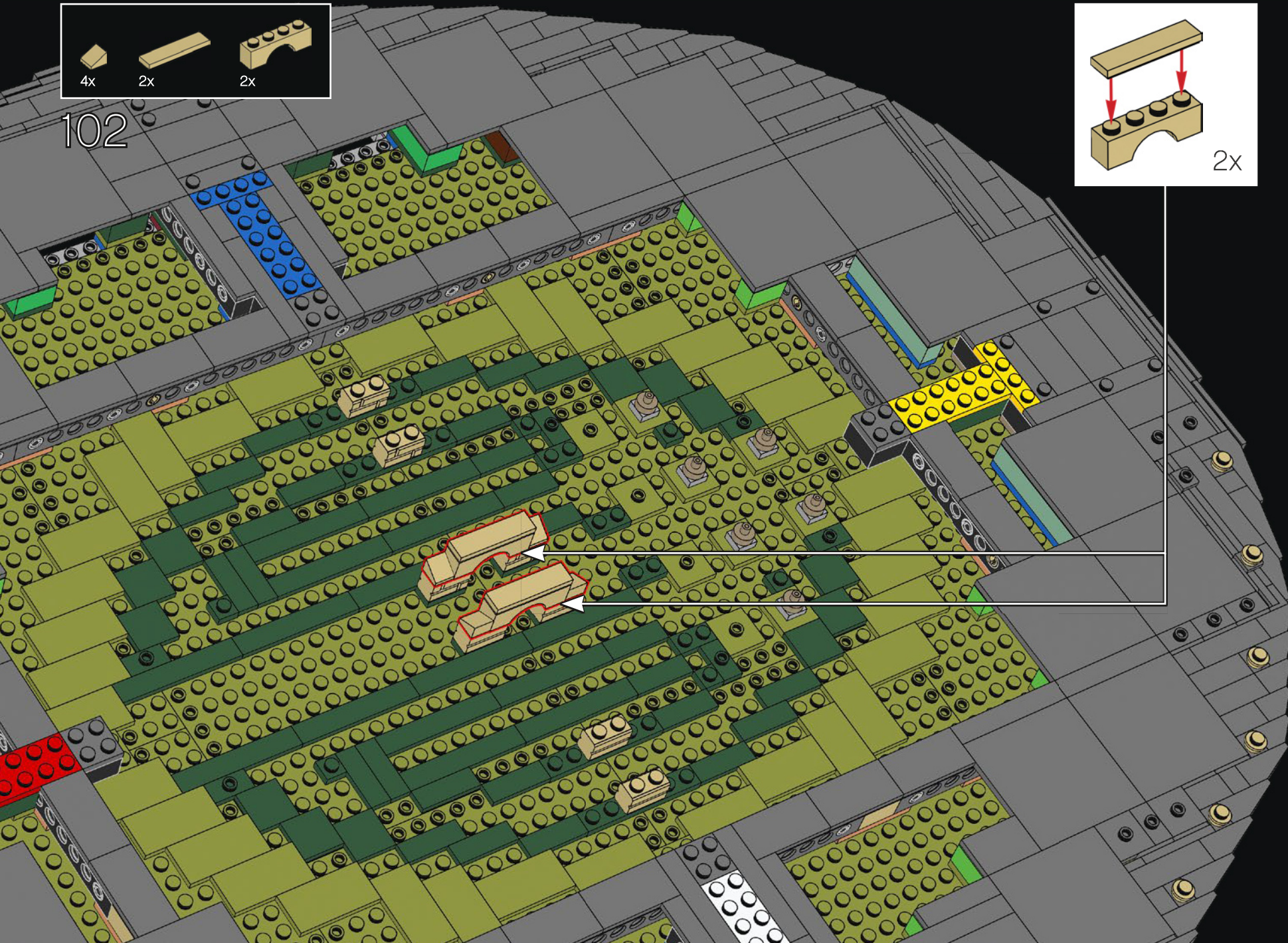
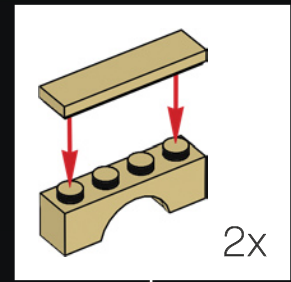

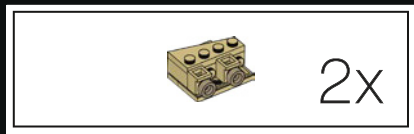

103

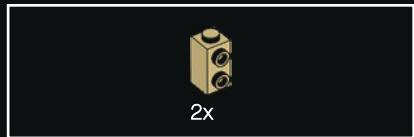

104

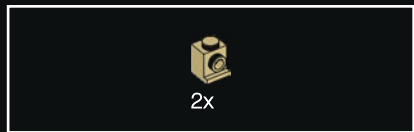
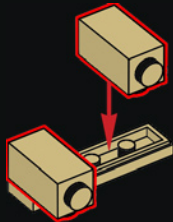

105

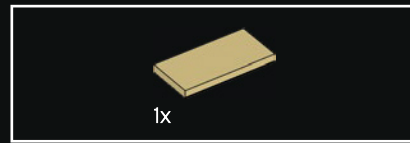
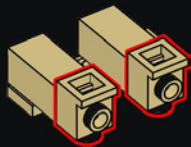

106

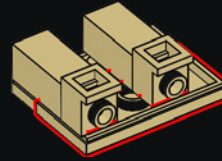

107

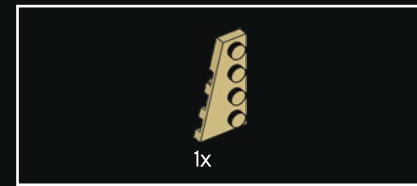
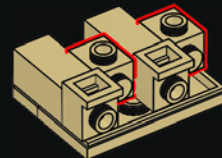

108

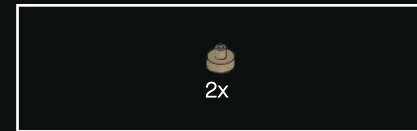
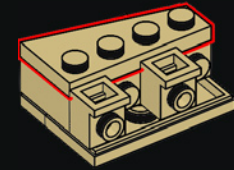

109

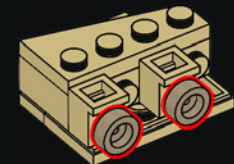

2x

110

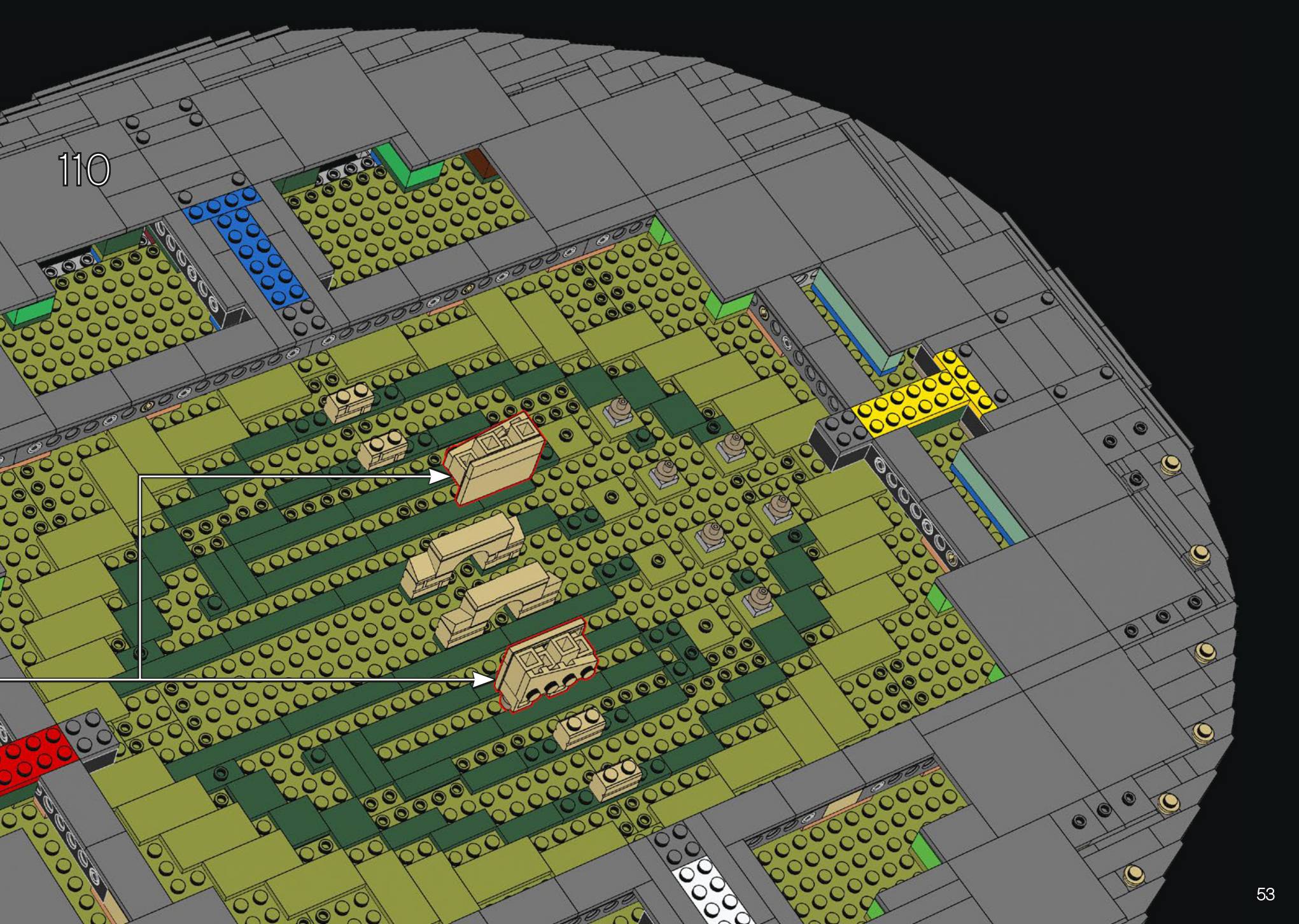

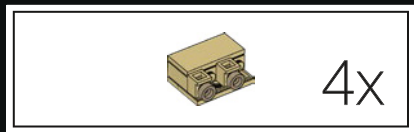

111



112

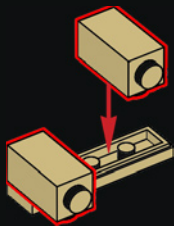

113

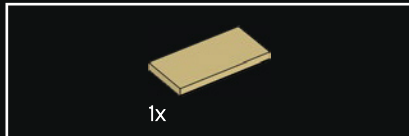
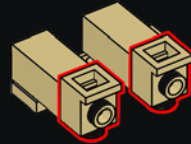

114

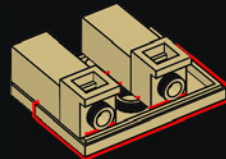

115

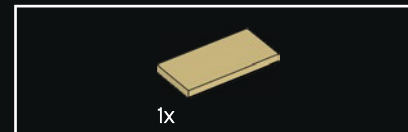
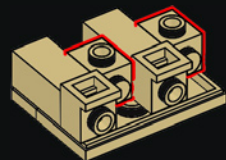

116

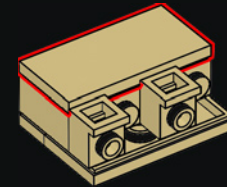

117

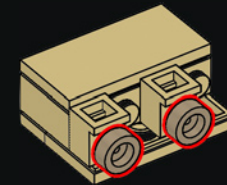

4x

118



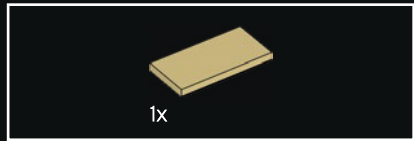
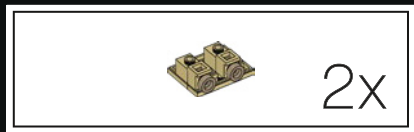

119



120

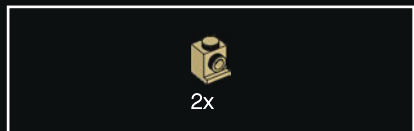
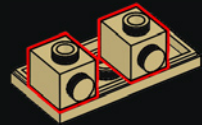

121

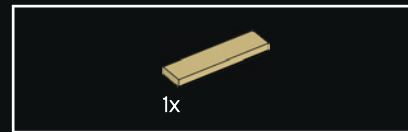
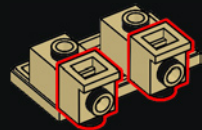

122

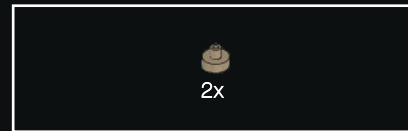
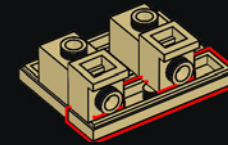

123

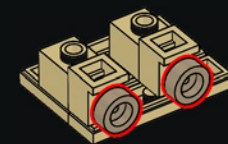

2x



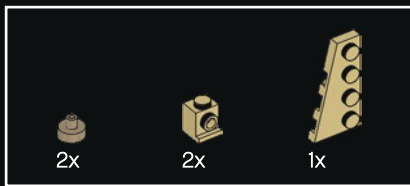

125

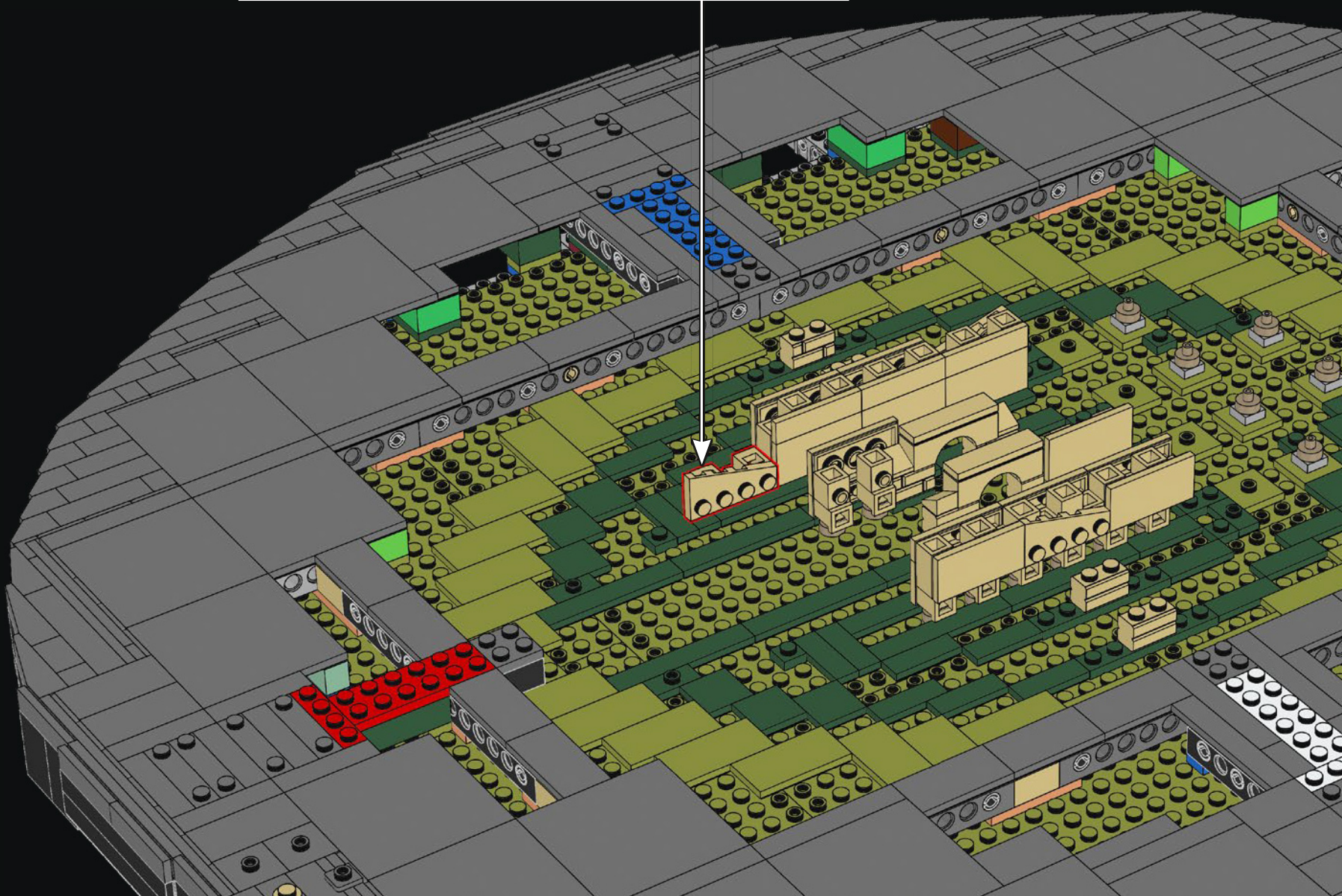
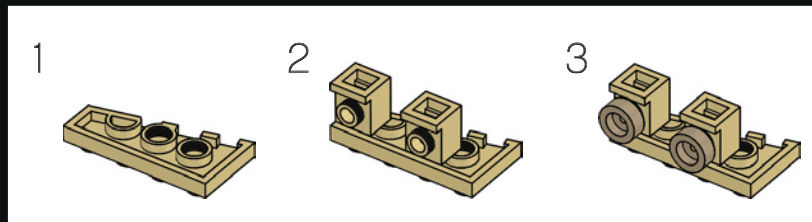

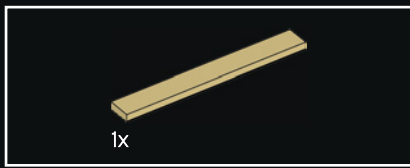

126

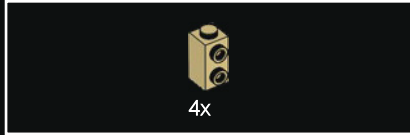
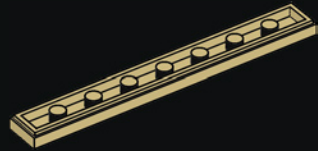

127

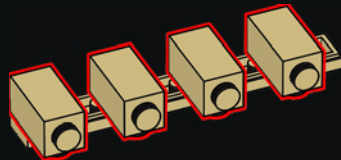

128

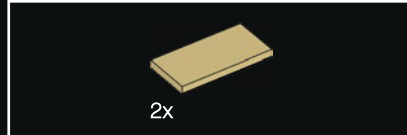
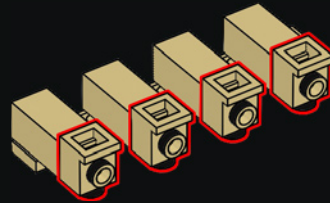

129

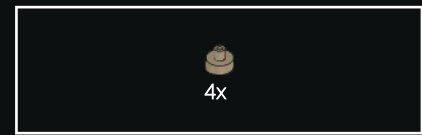
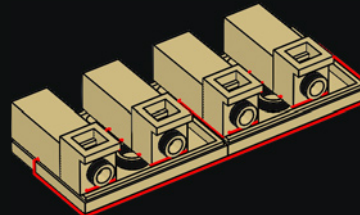

130

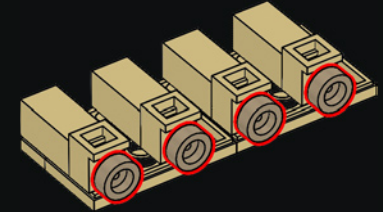

131

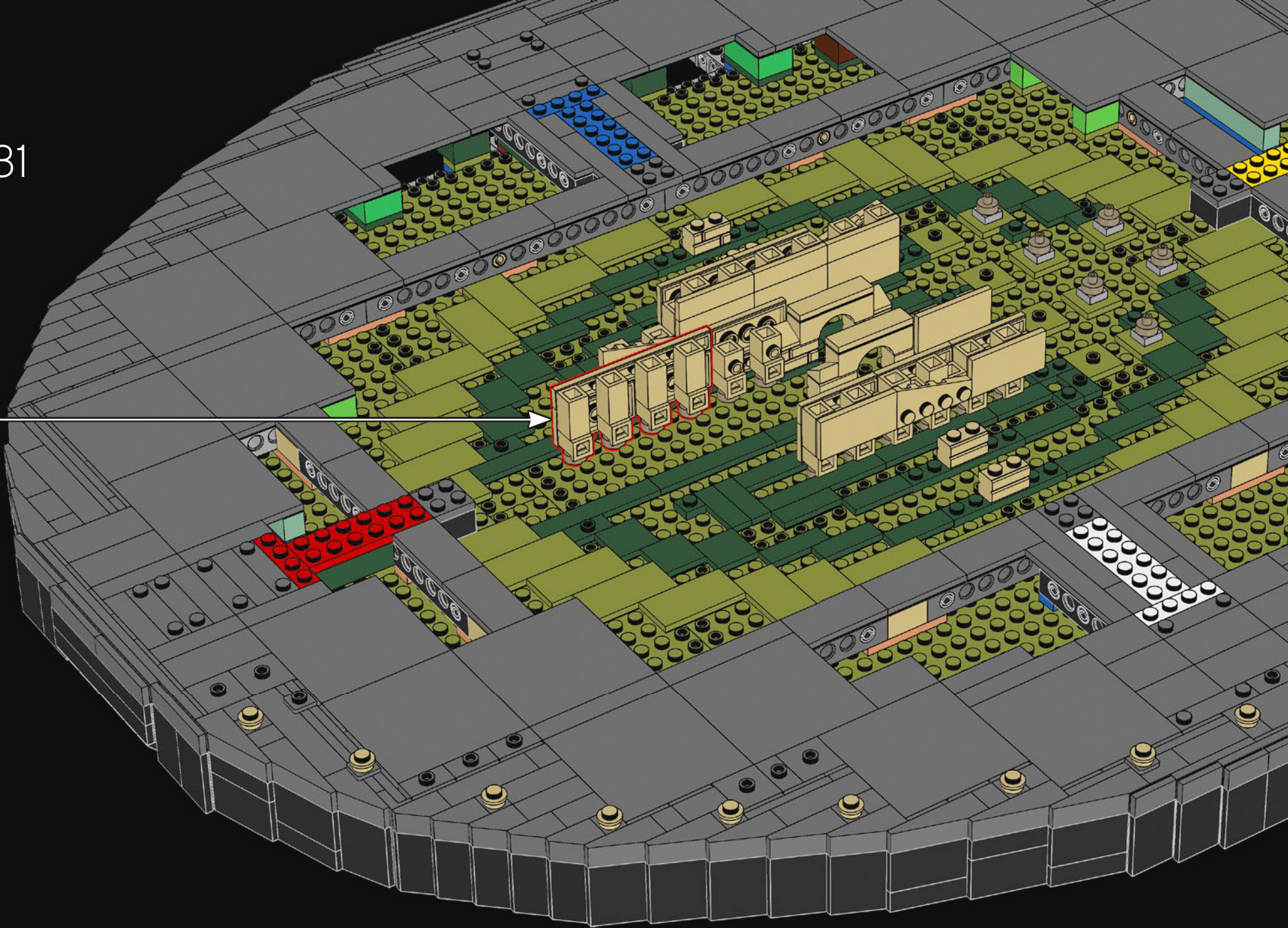

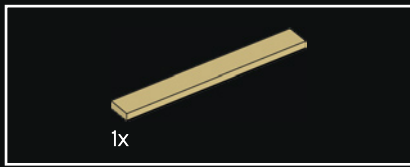

132

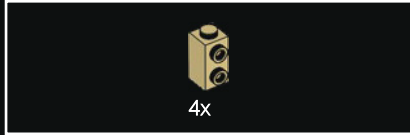

133

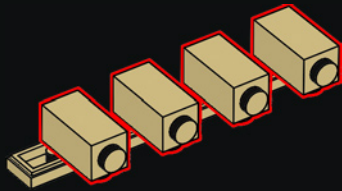

134

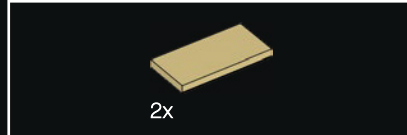
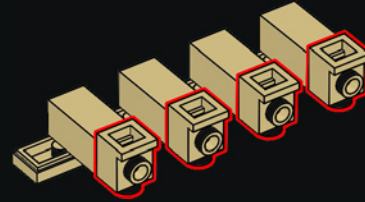

135

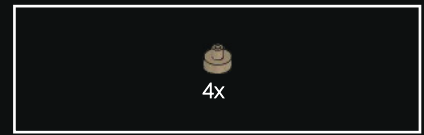
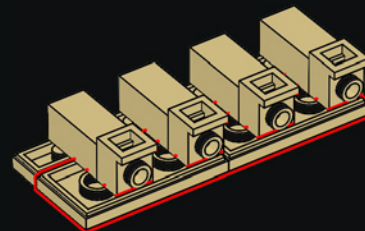

136

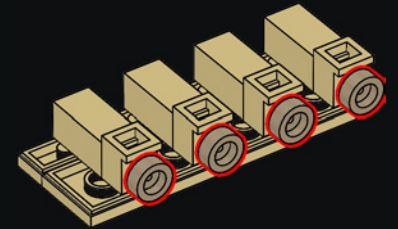

137

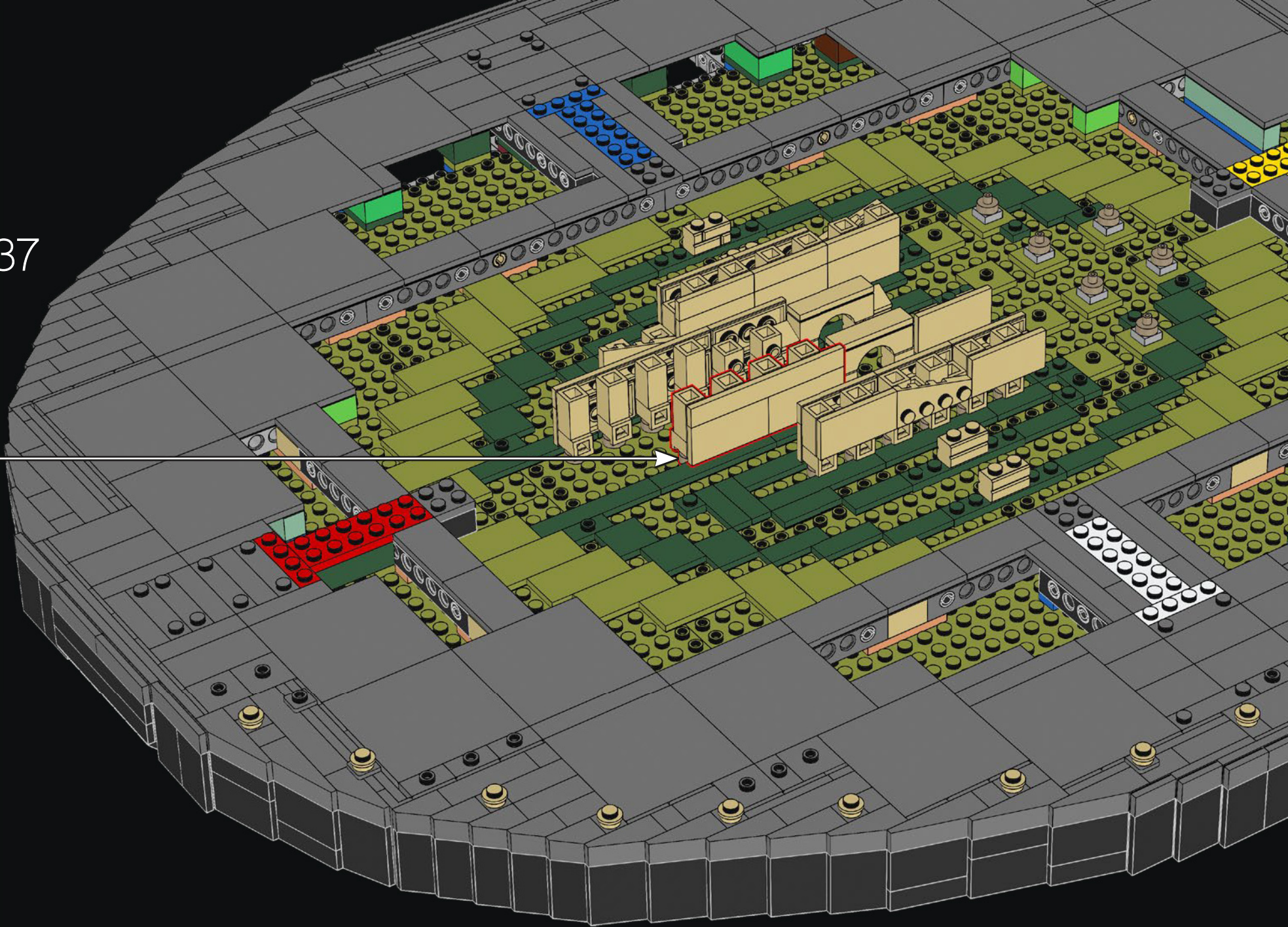

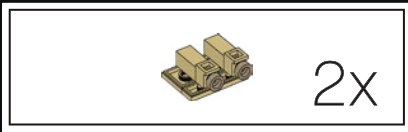

138



139

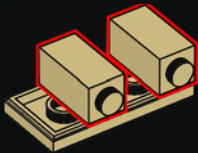

140

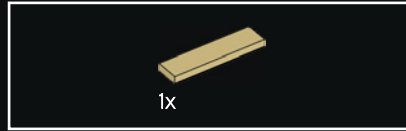

141

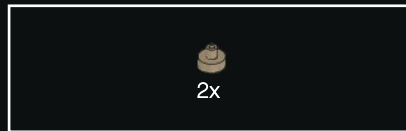
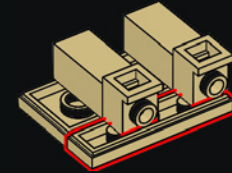

142

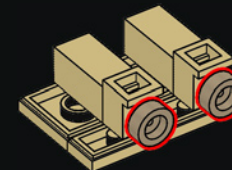

2x

143

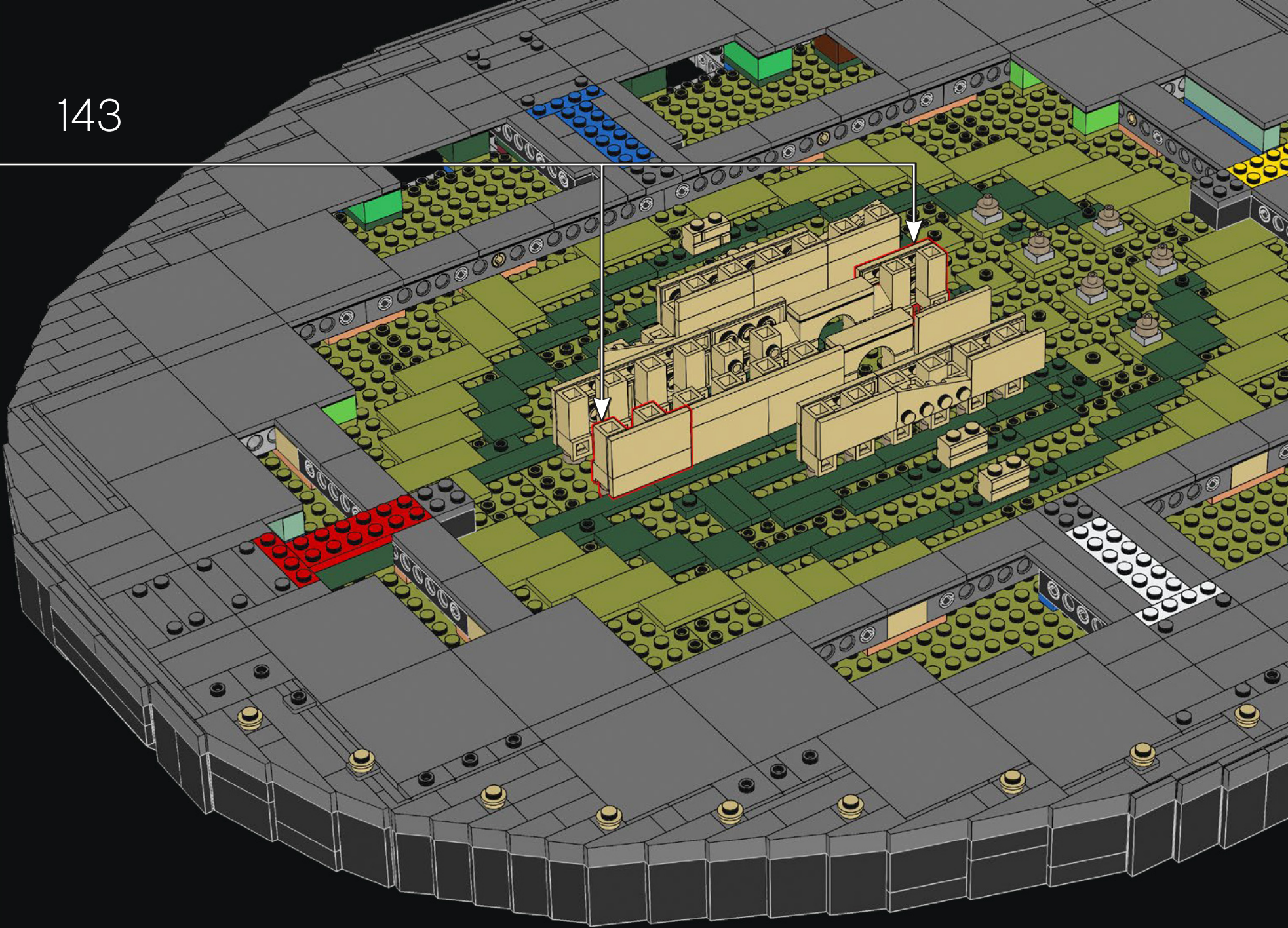

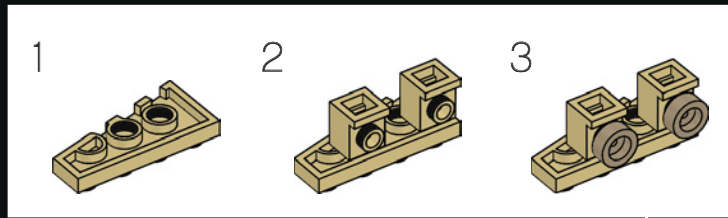
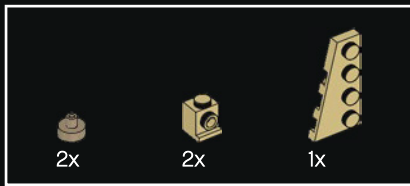

144





145

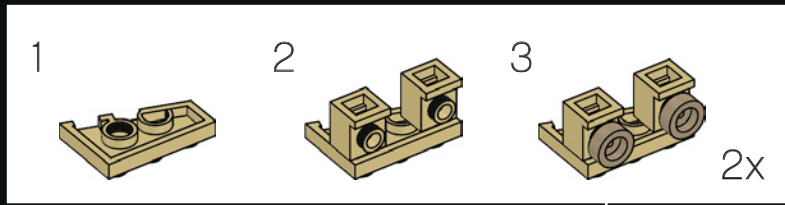

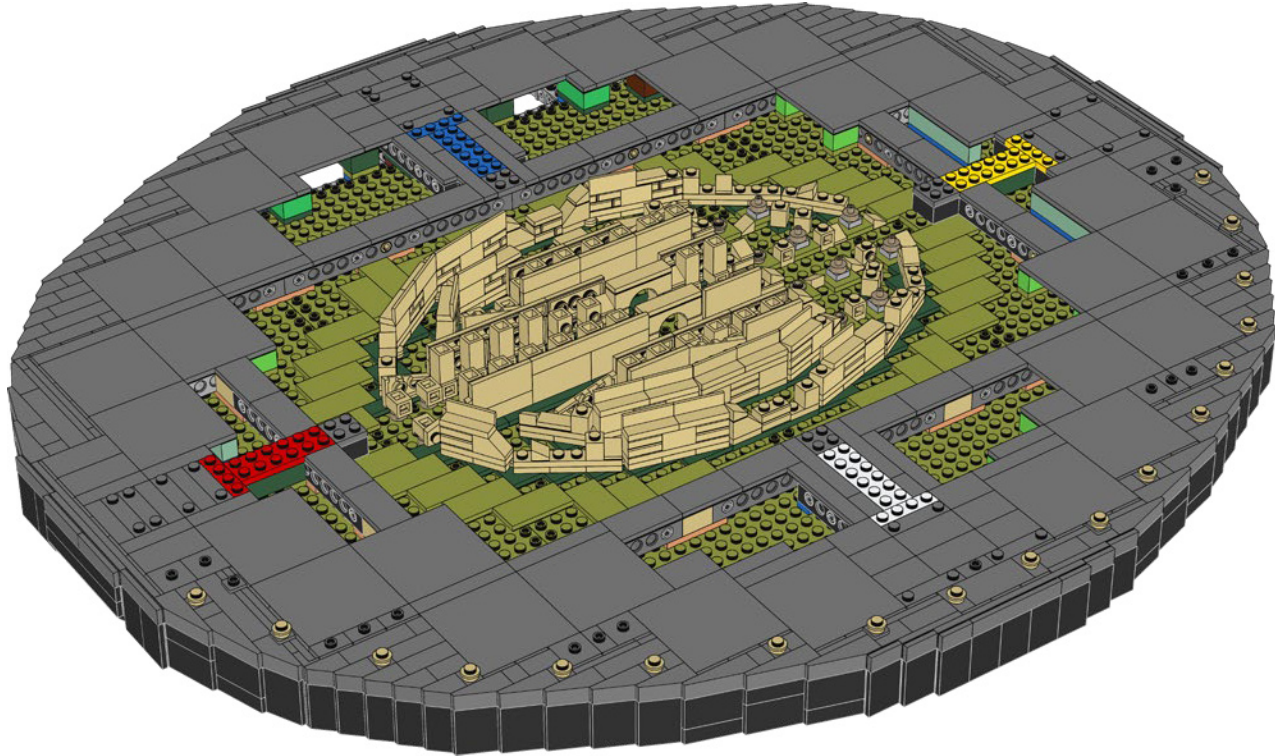
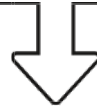

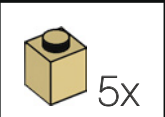
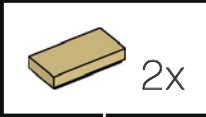

146





147

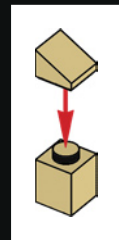
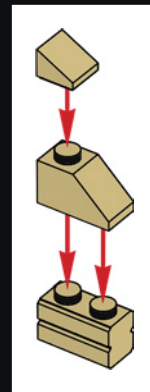
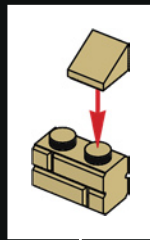
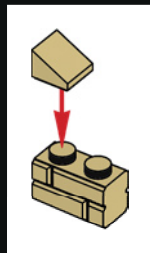
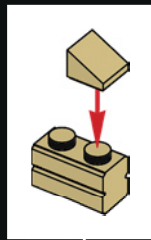

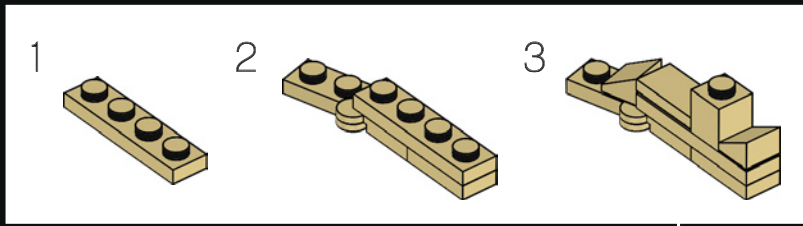
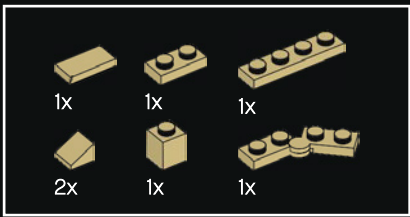

148



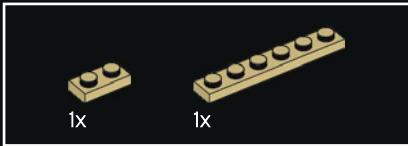
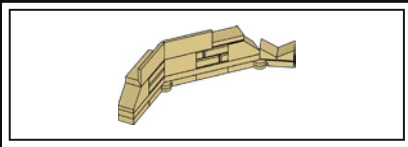

149

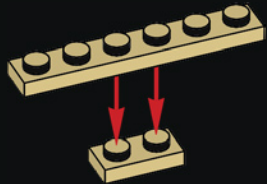

150

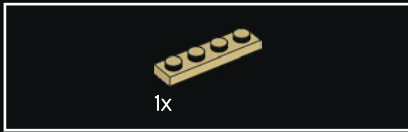
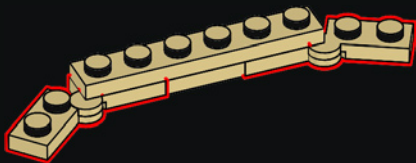

151

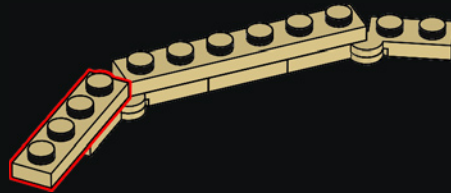

152

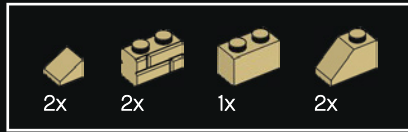
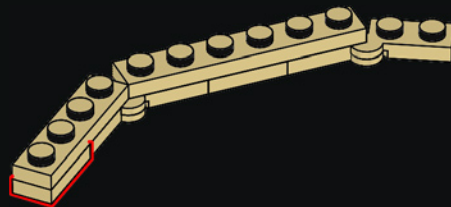

153

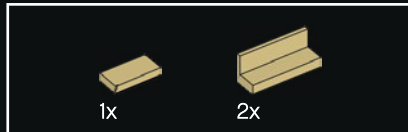
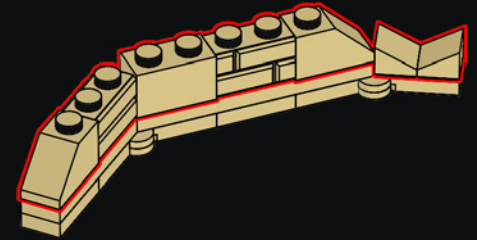

154

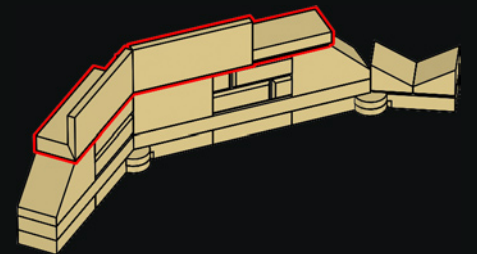

155

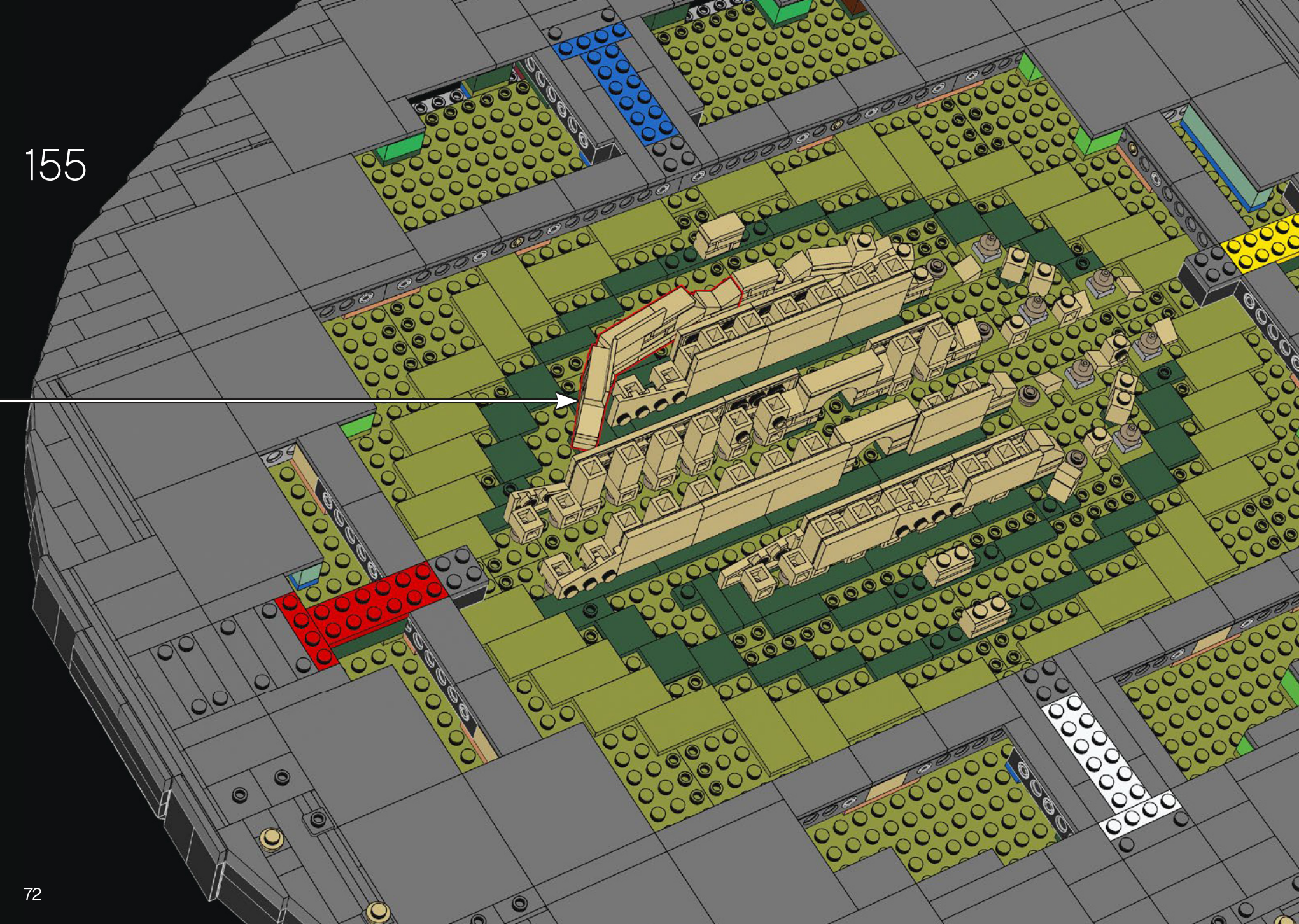

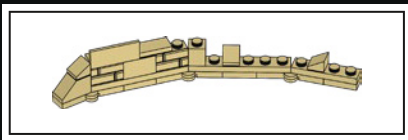

156

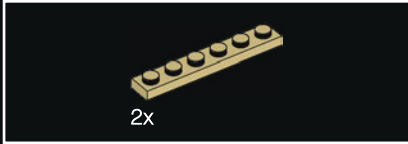

157



158

2x

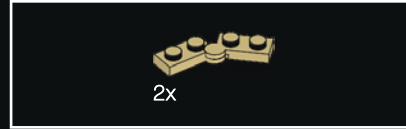

159

2x



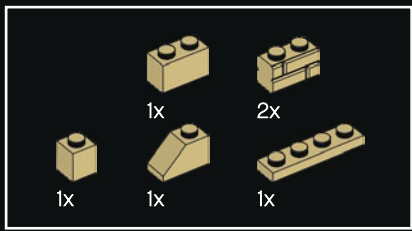

160

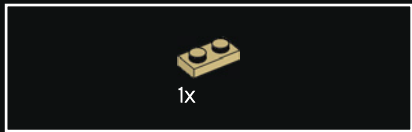
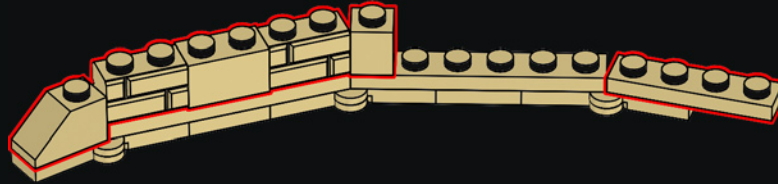

161

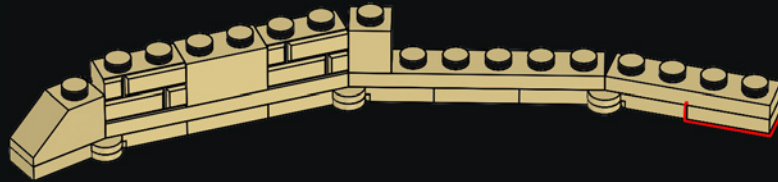

162

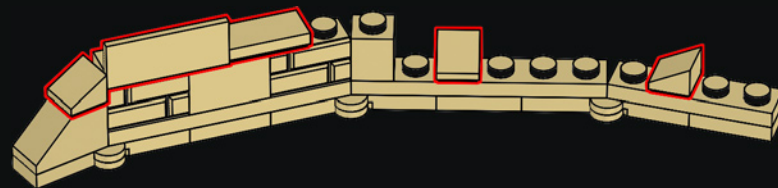

163



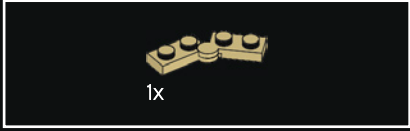
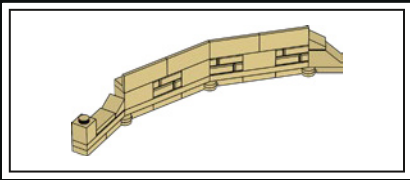

164

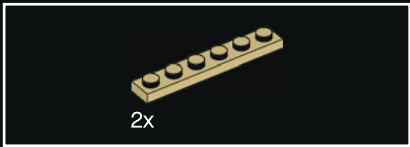

165

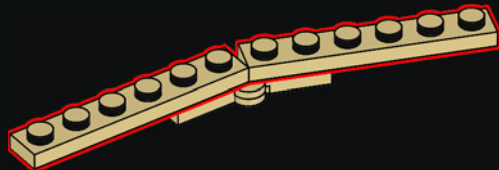

166

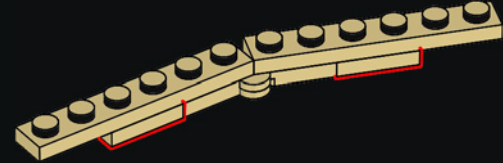

167

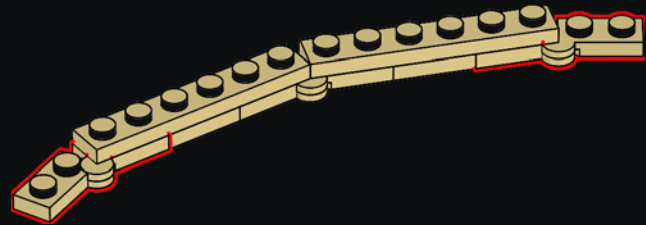

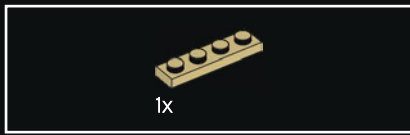

168

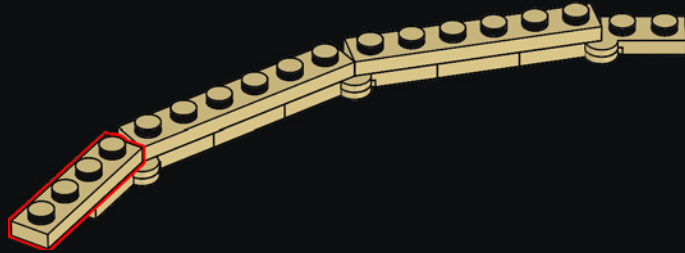

169

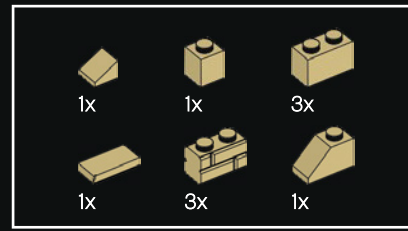
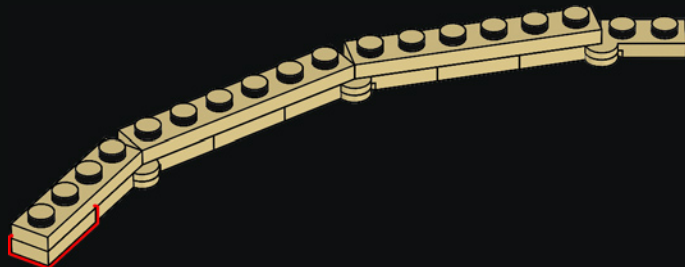

170

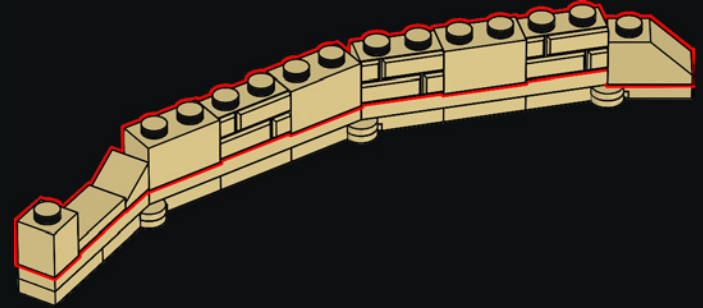

171

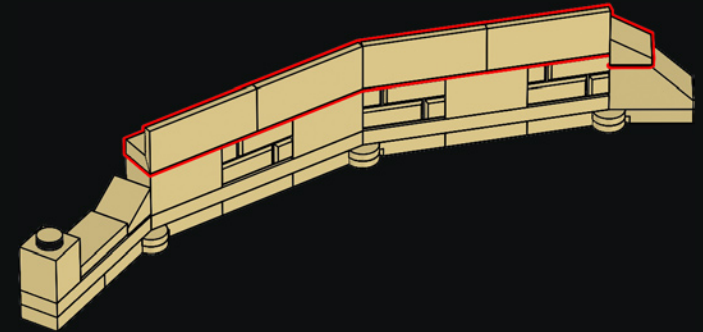

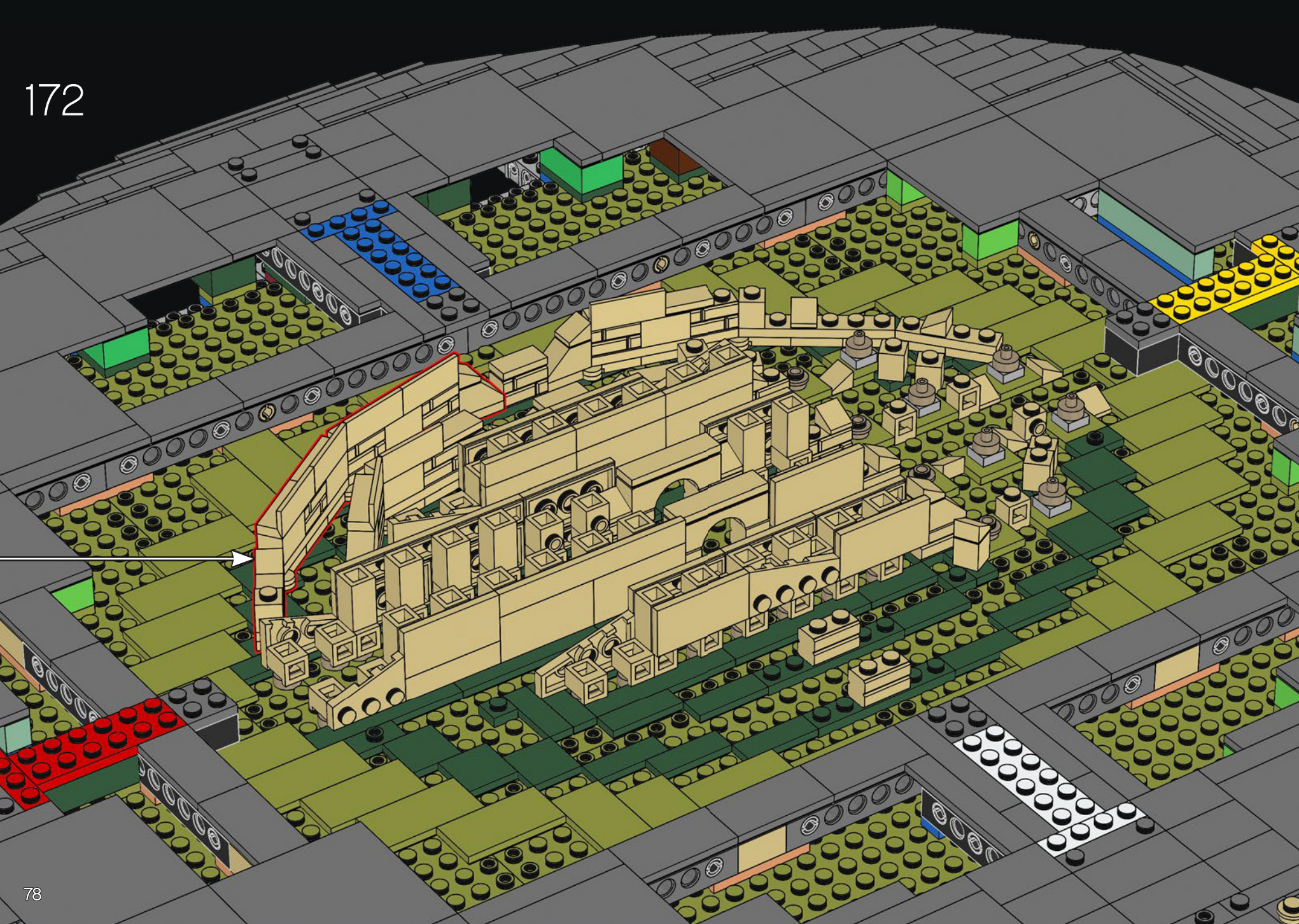

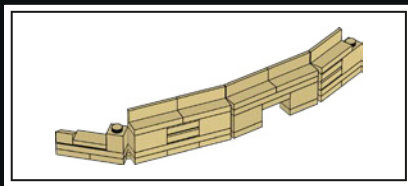

173

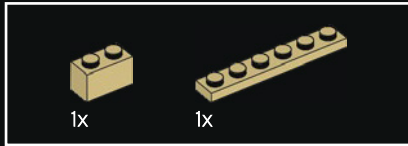

174

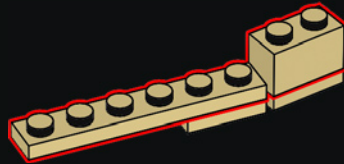

175

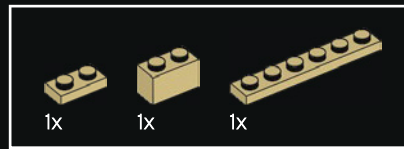
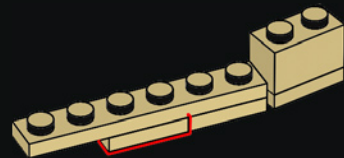

176

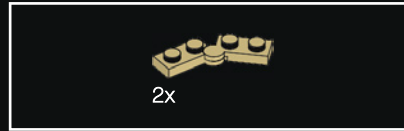
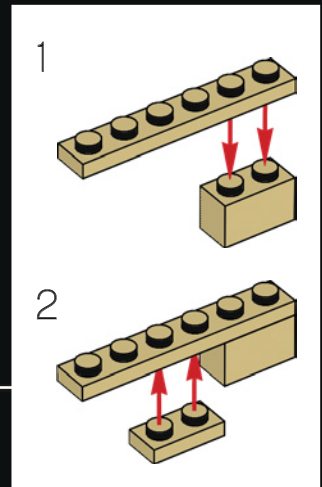
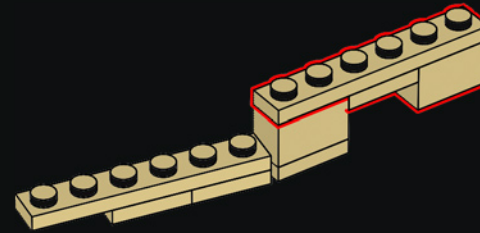

177

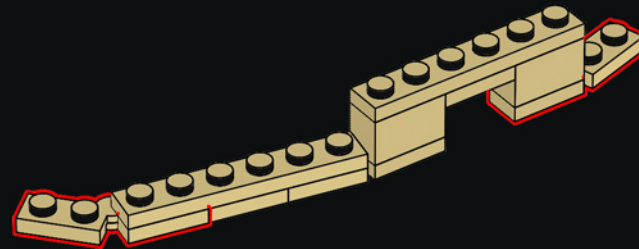



178

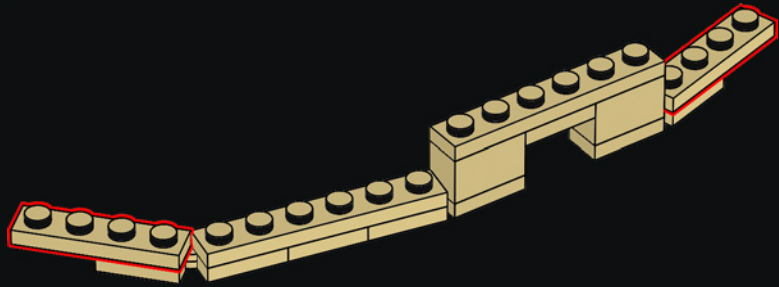

179

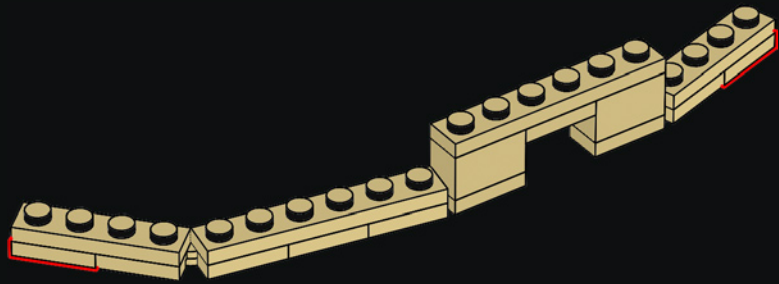

180

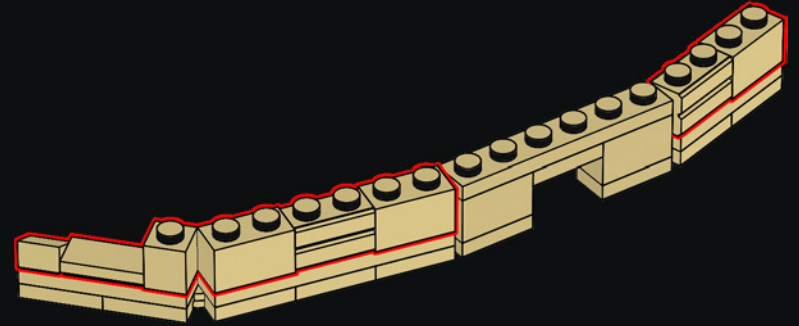

181

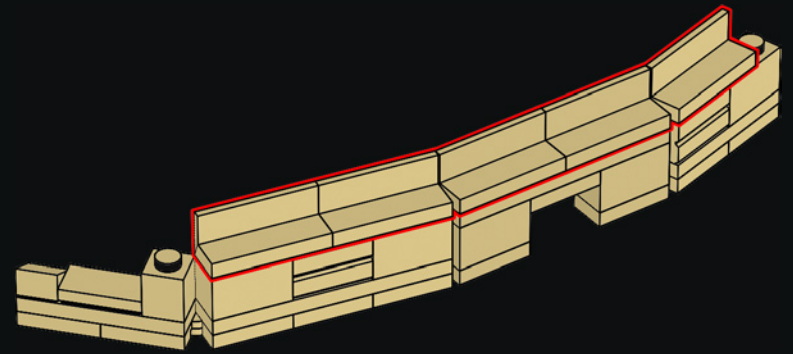

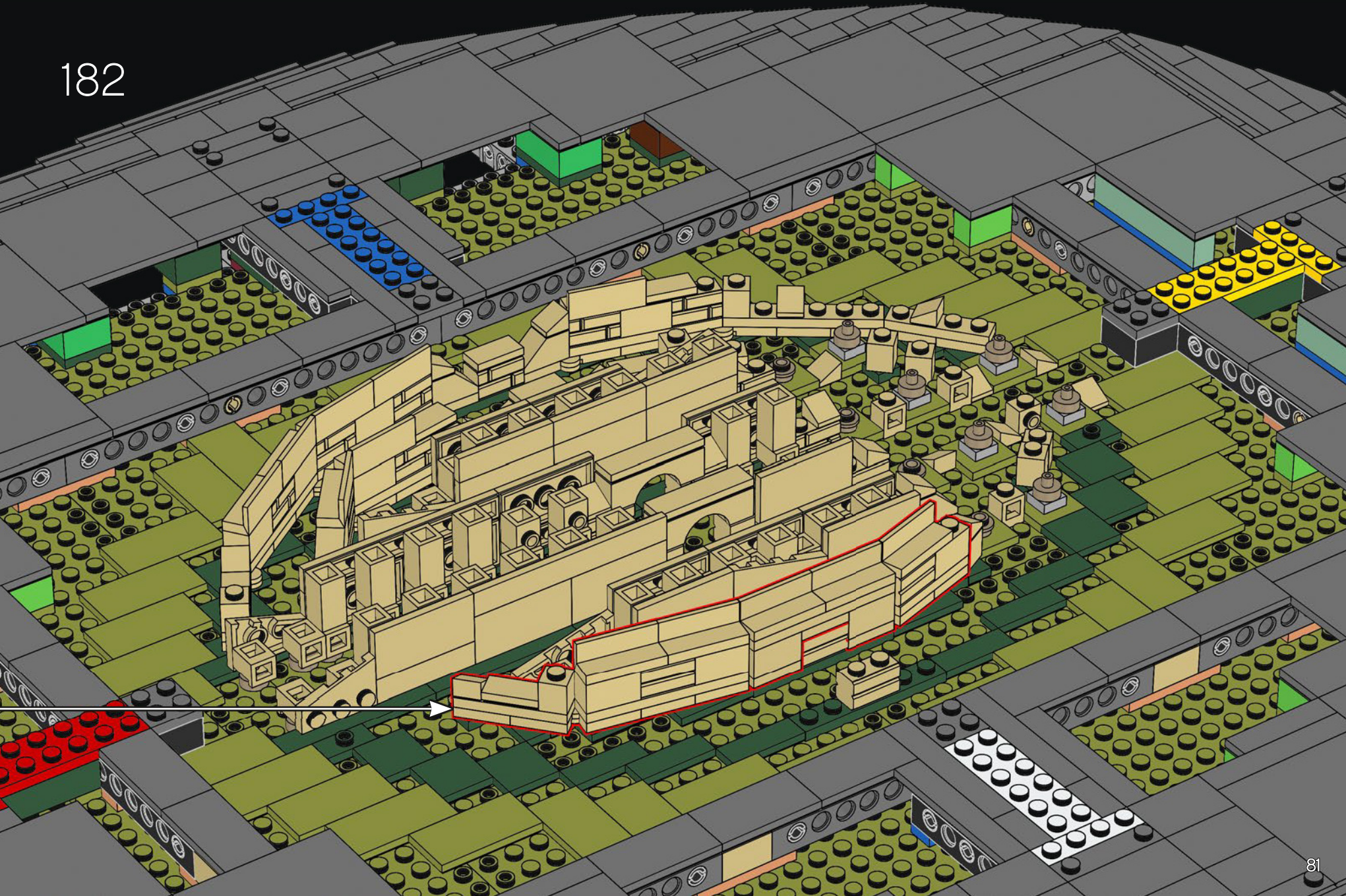

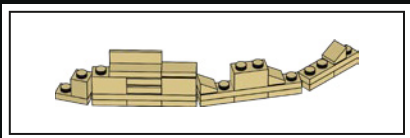

183

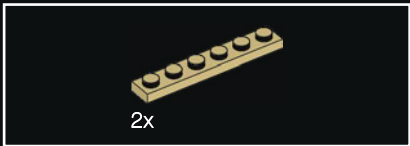

184

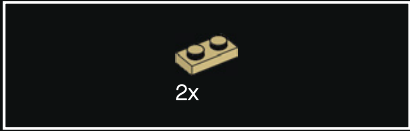

185



186

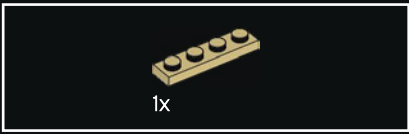

187

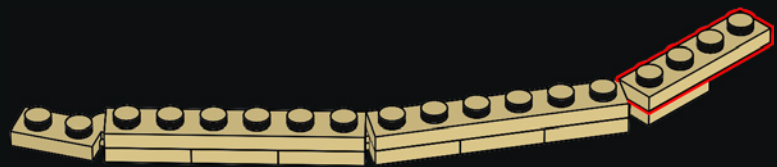



188

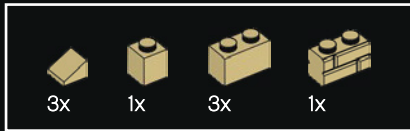

189

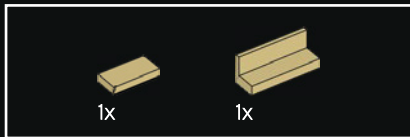
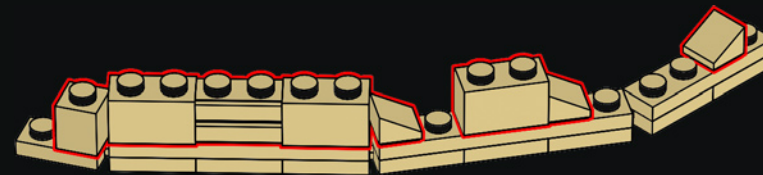

190

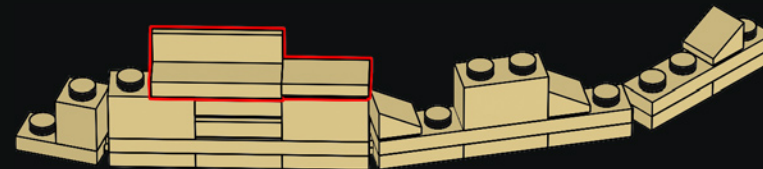

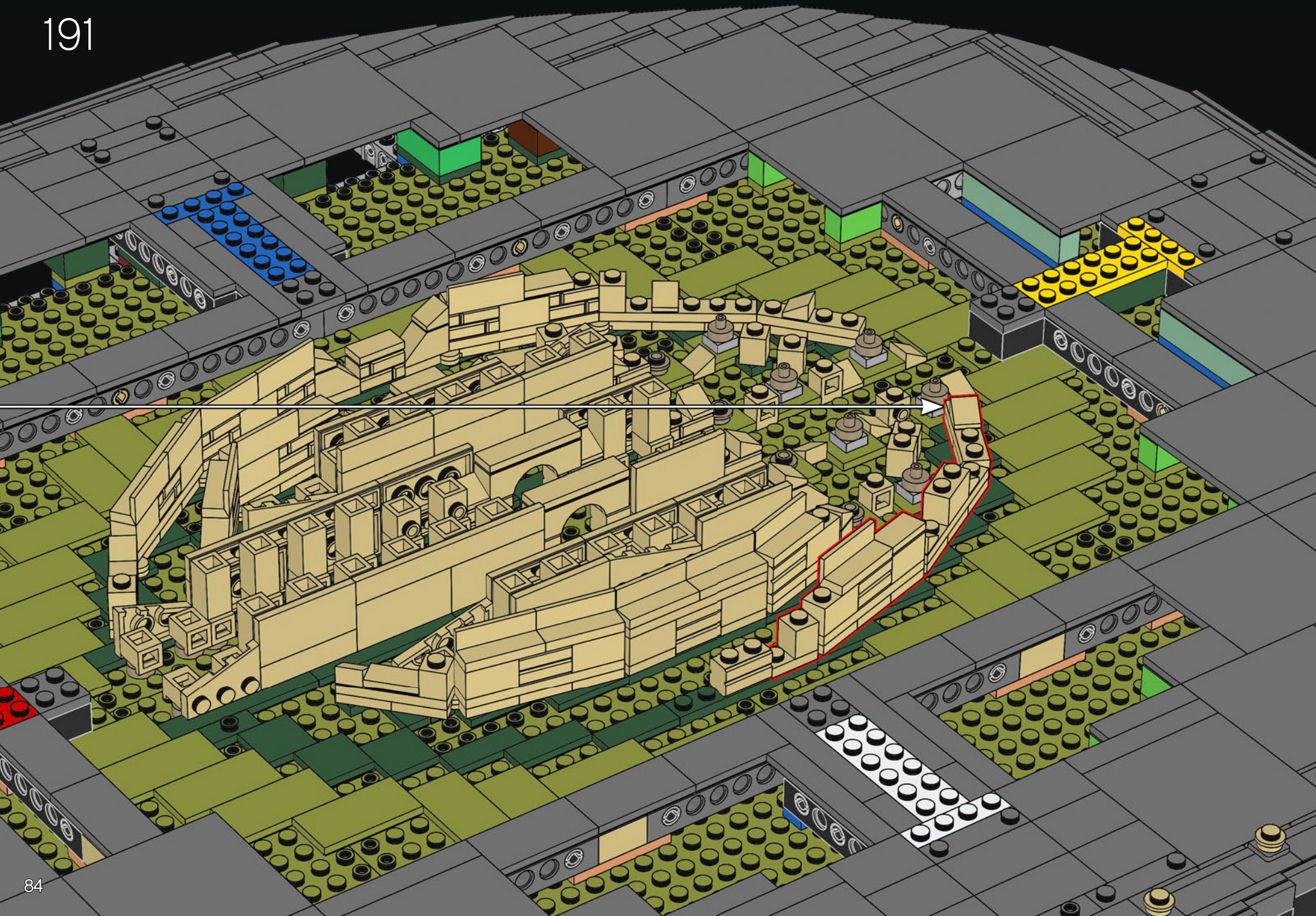

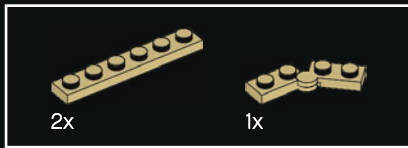
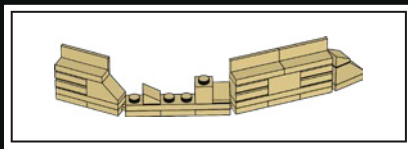

192

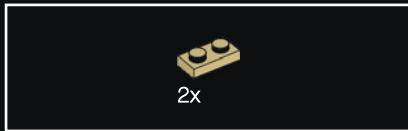
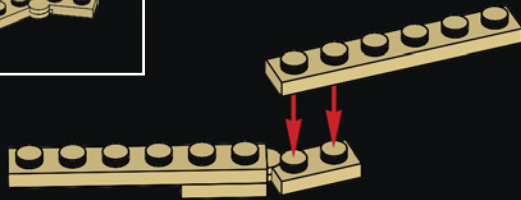

193



194

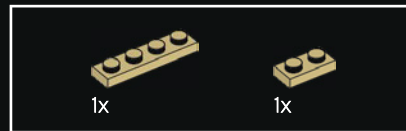

195

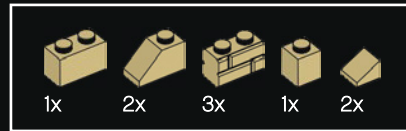
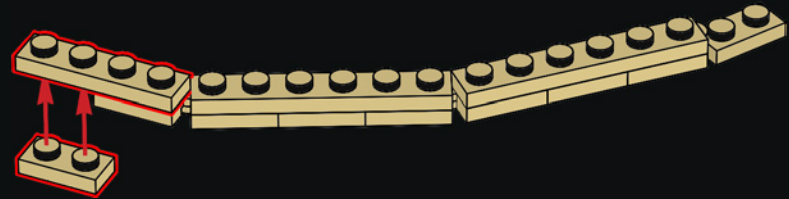

196

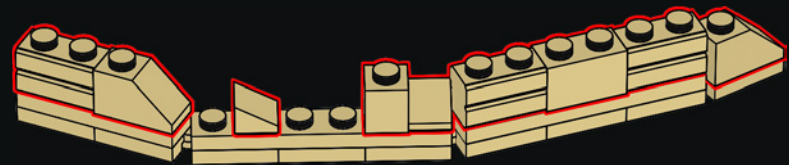

197

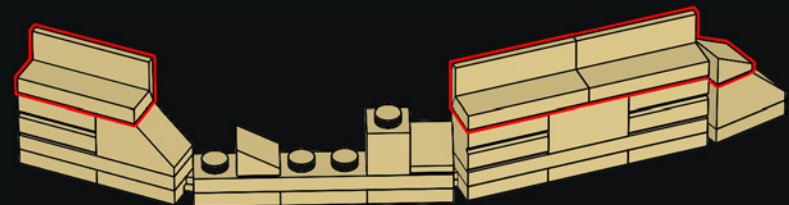

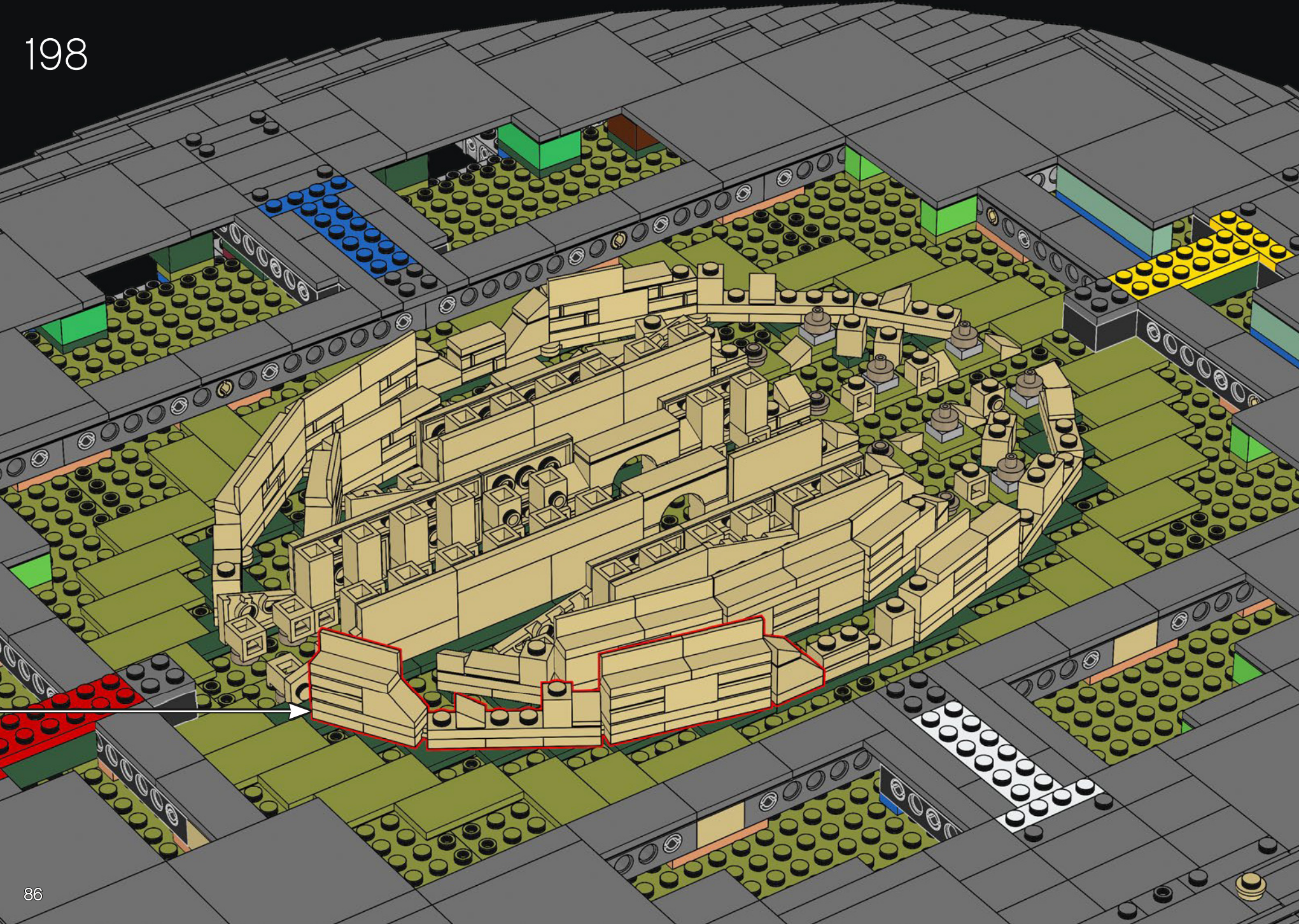

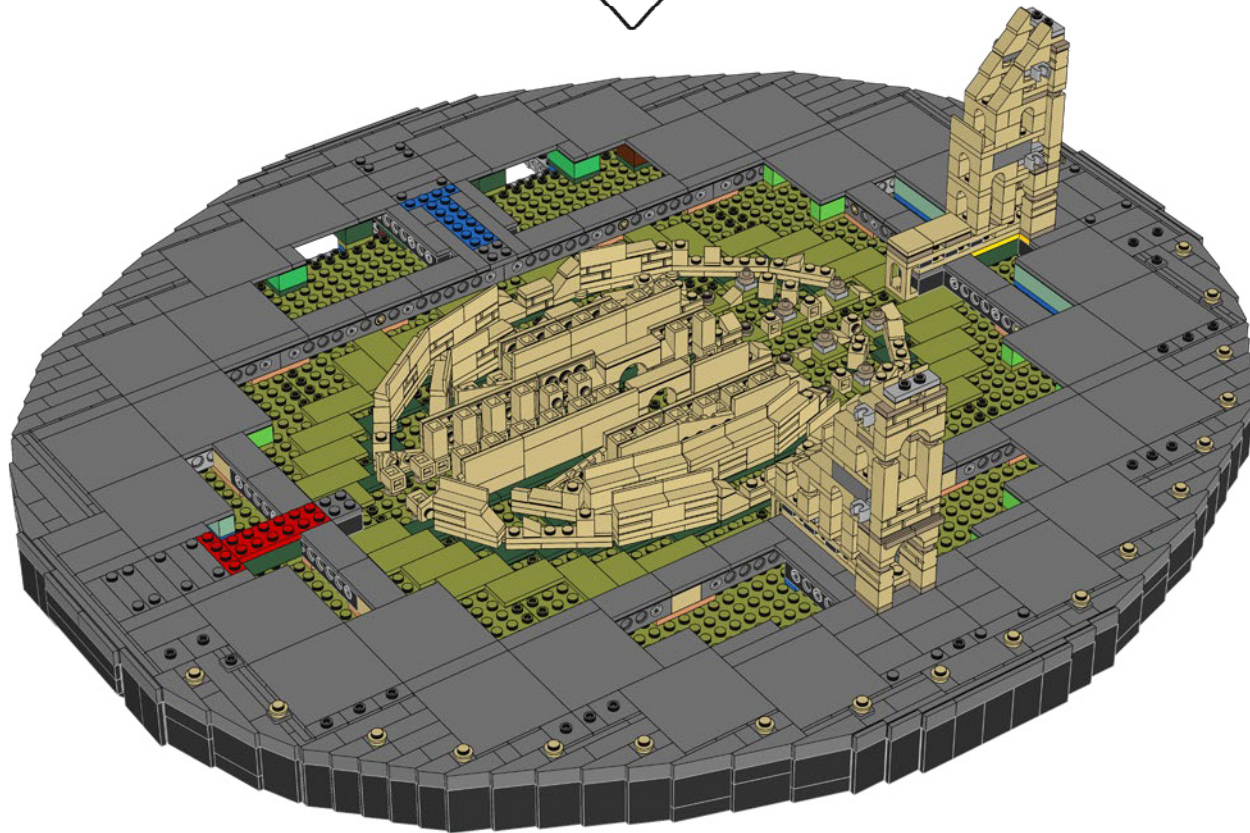

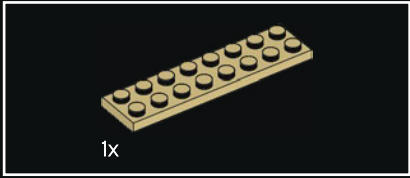
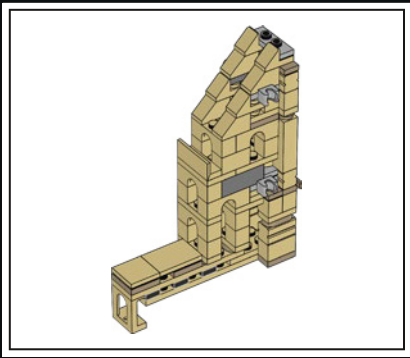

199

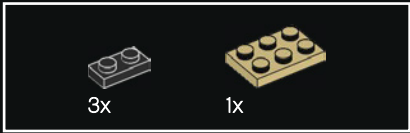
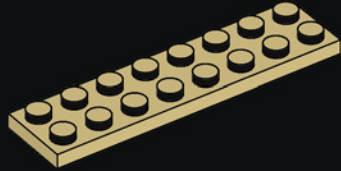

200

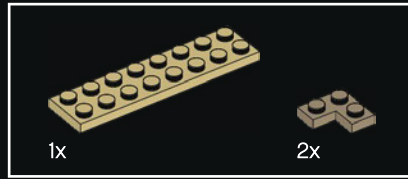
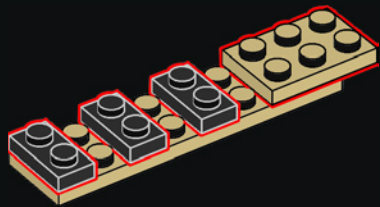

201

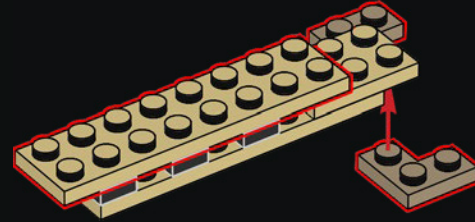

202

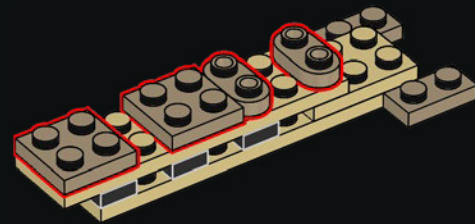

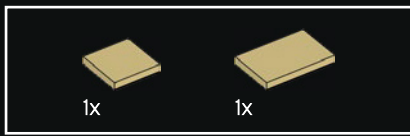

203

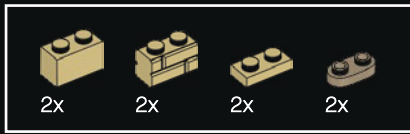
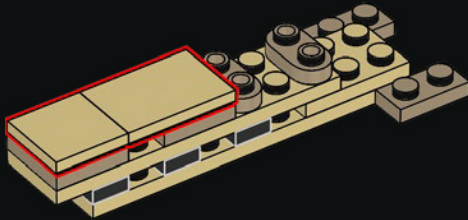

204

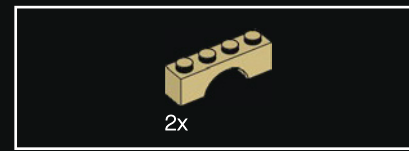
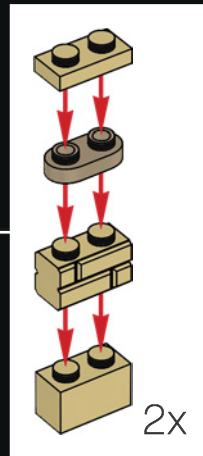
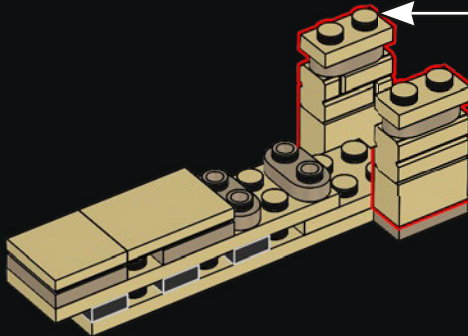

205

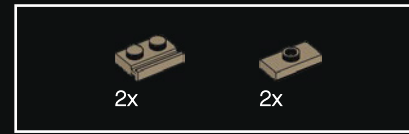
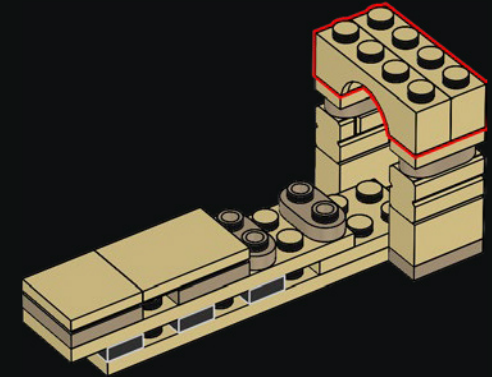

206

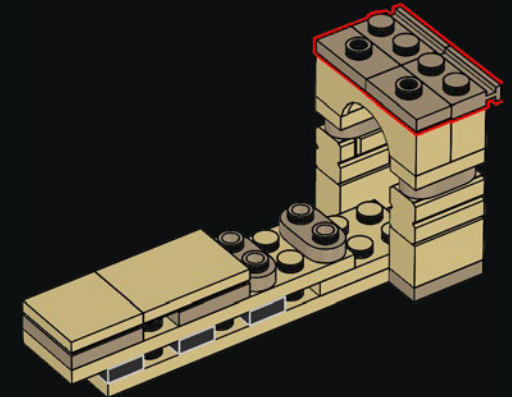

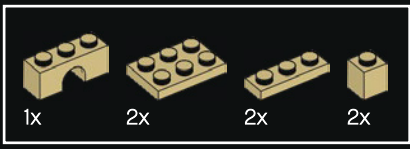

207

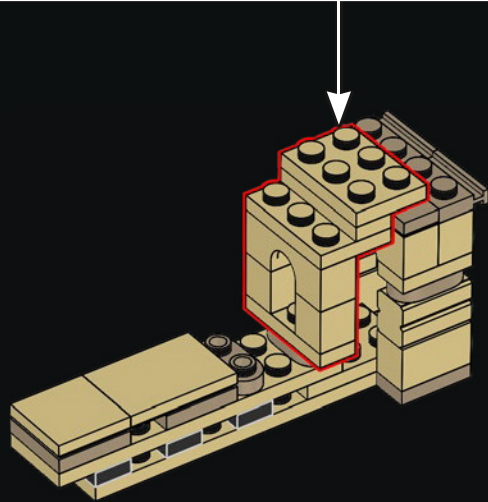
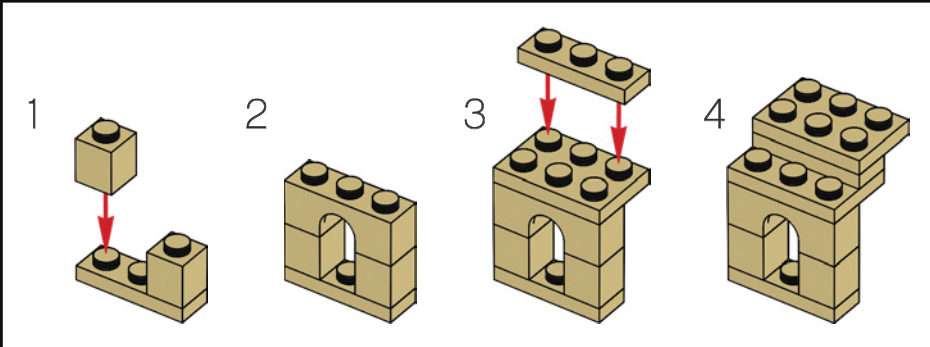

208

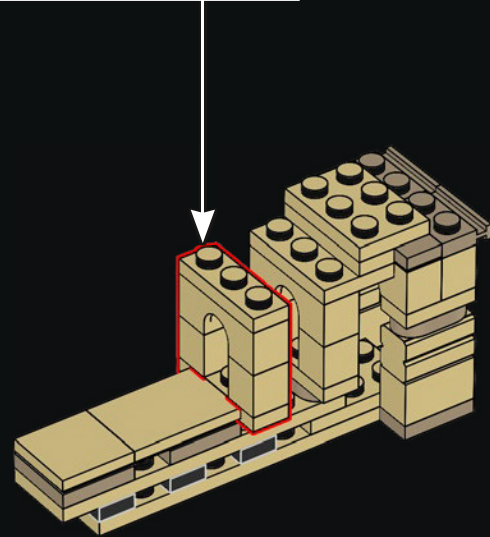
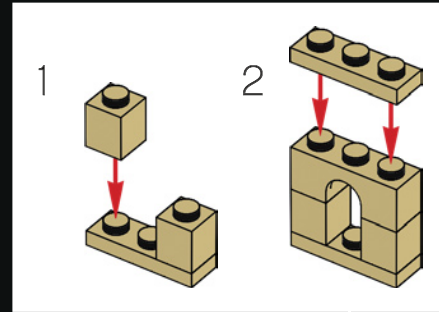

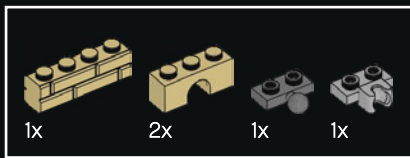

209

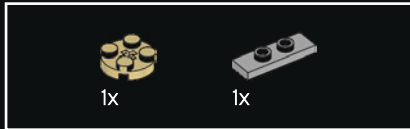
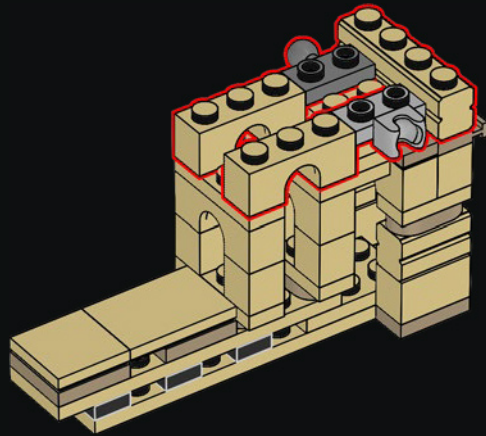

210

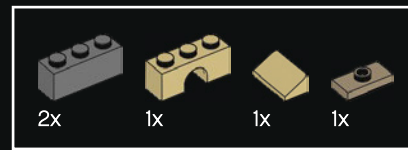
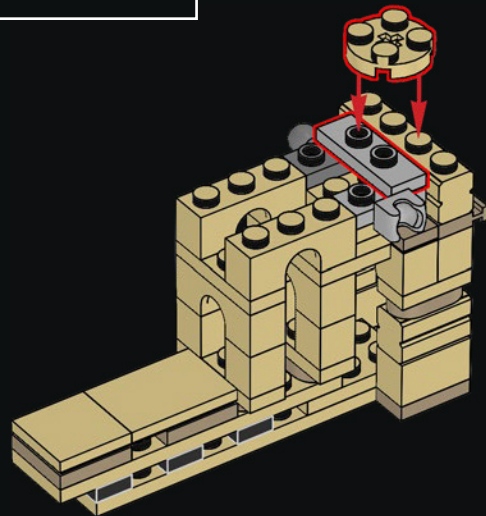

211

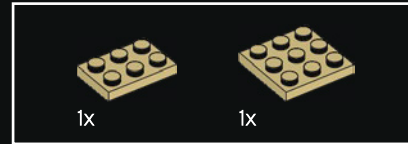
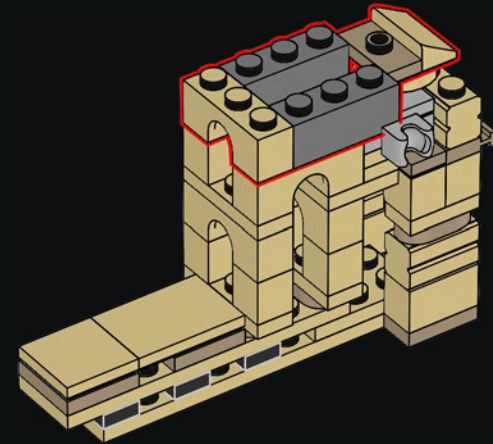

212

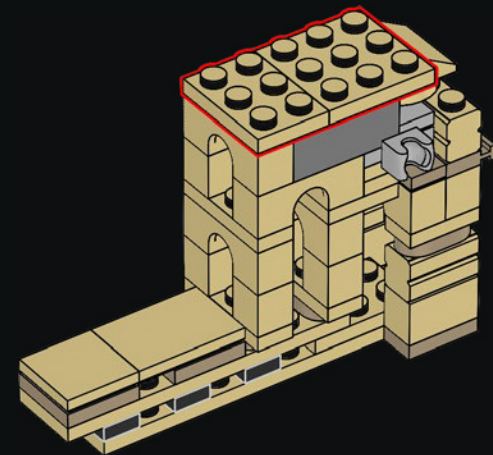



213

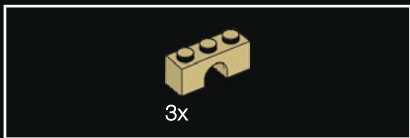
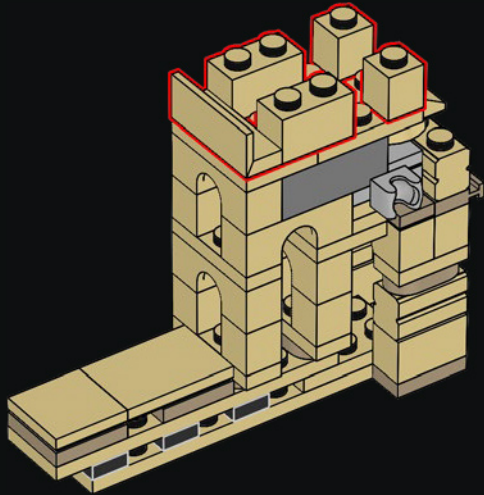

214

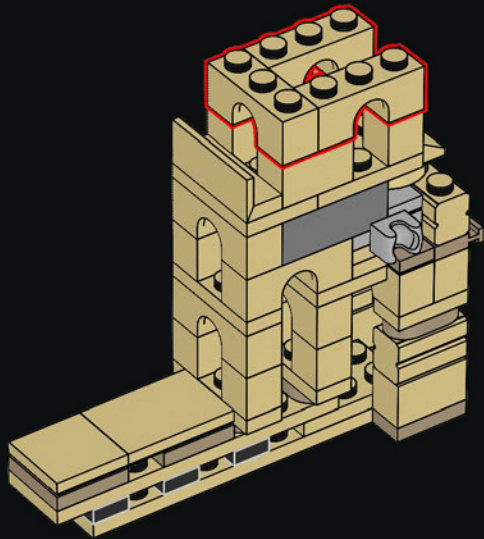

215

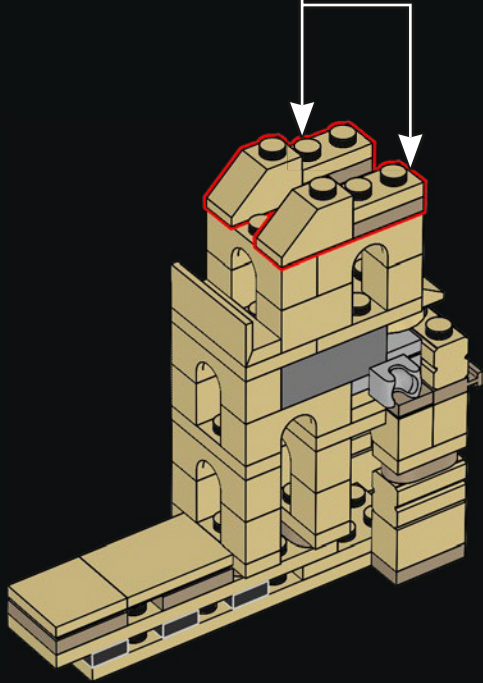
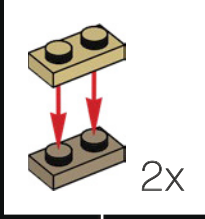

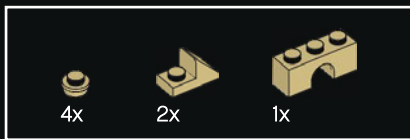

216

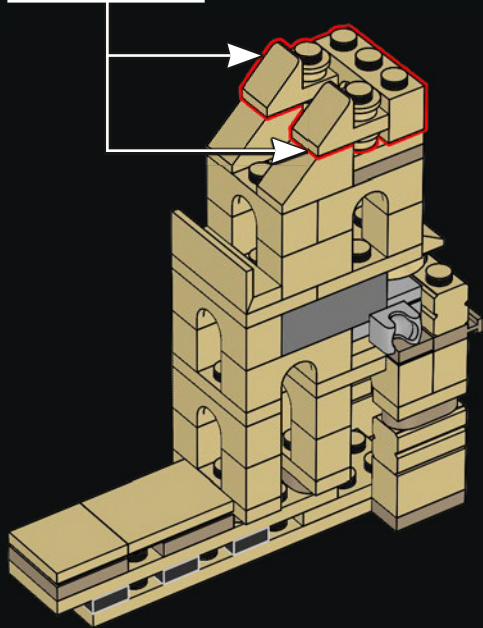
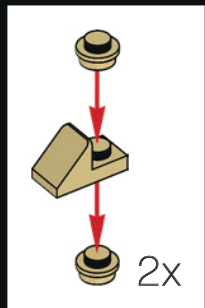

217

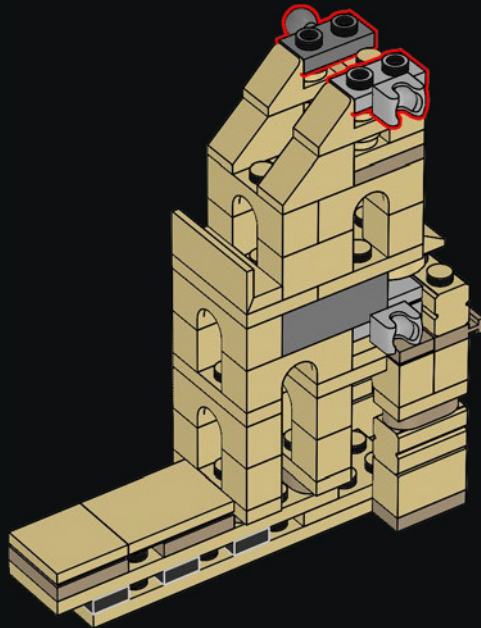

218

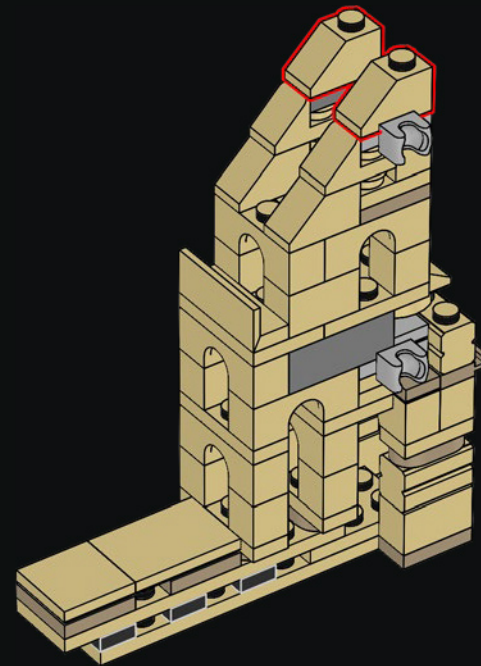

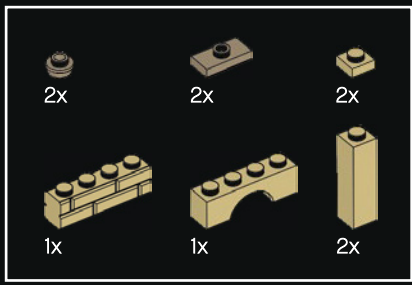

219

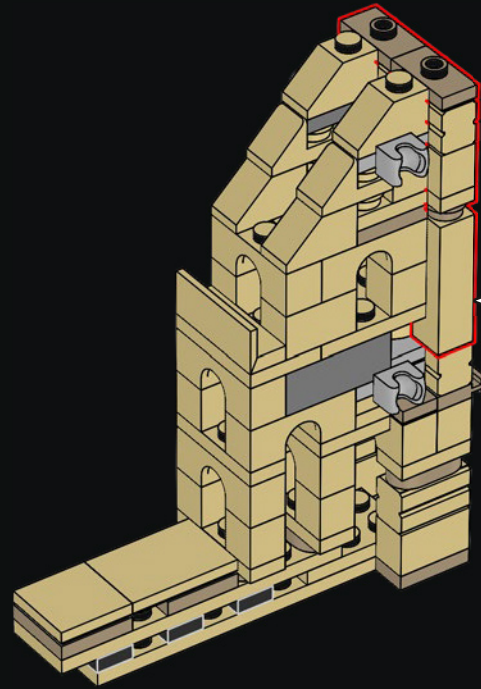
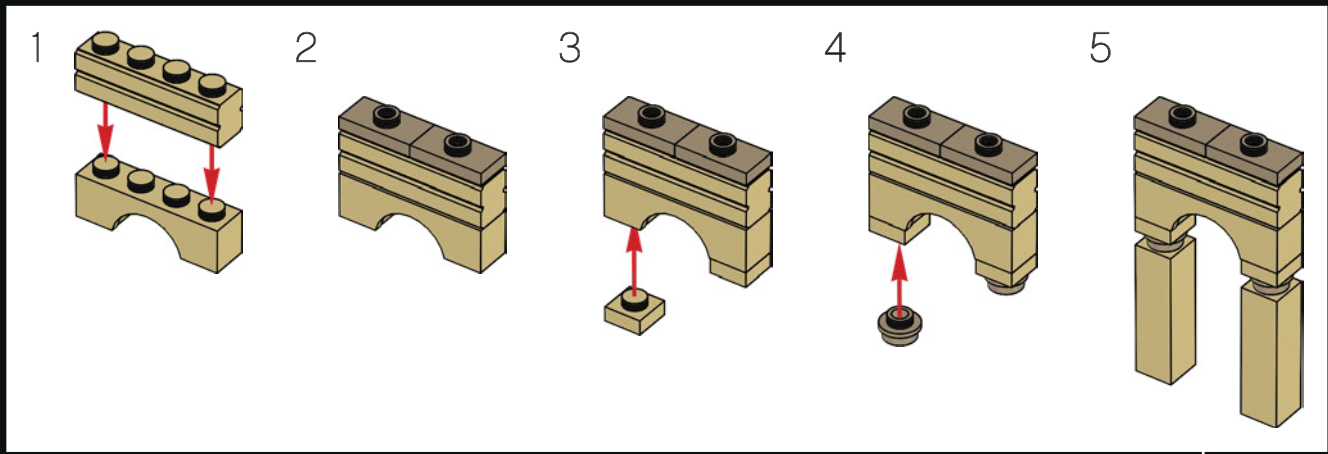



220

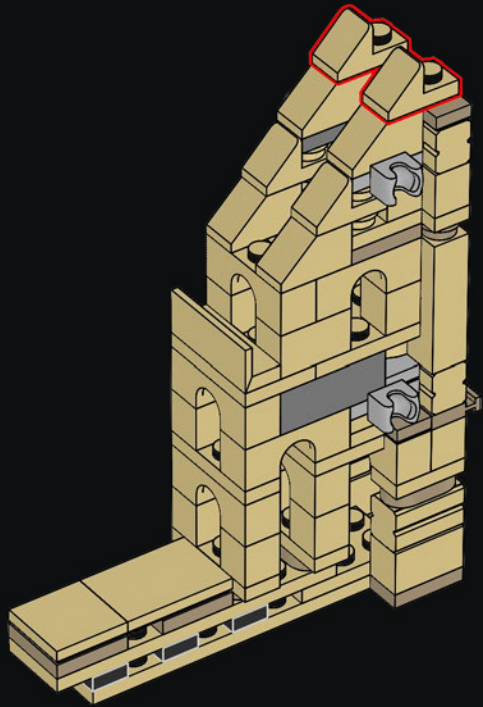

221

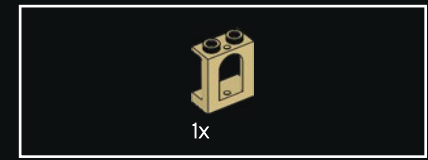
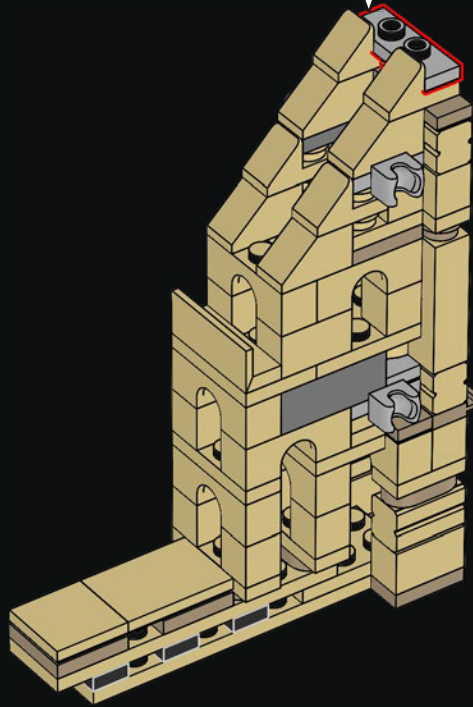
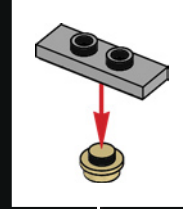

222

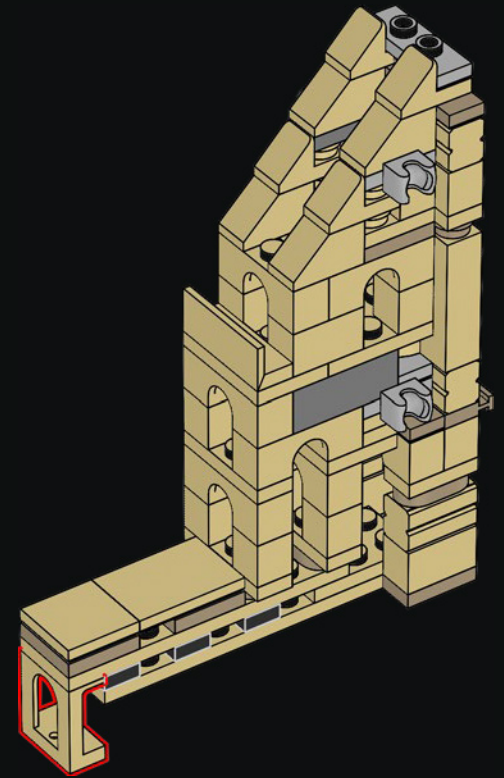

223

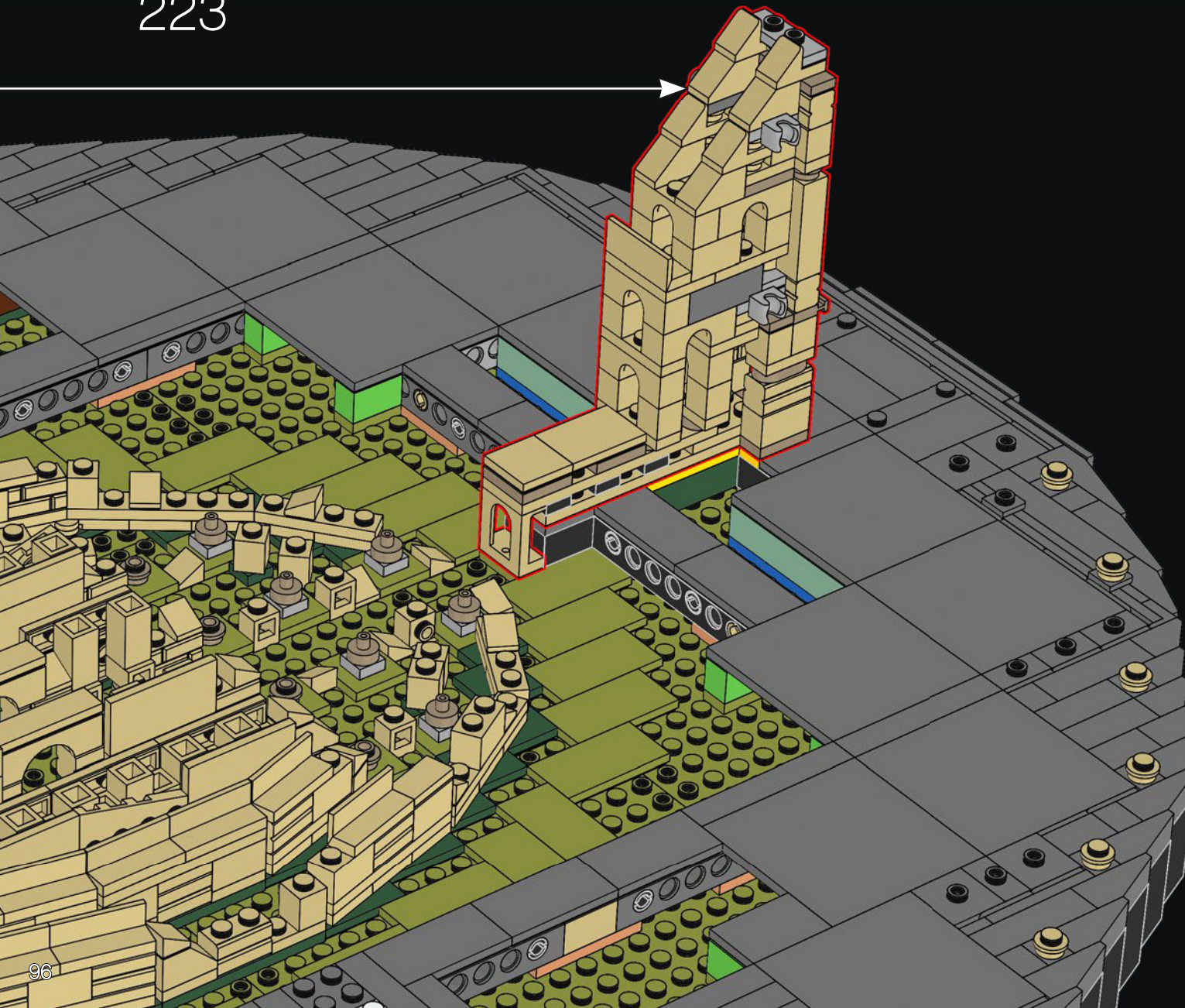

The outer facade was composed of 80 arcades on 3 levels.

La façade extérieure était composée de 80 arcades sur 3 niveaux.

La fachada exterior estaba compuesta por 80 arcadas organizadas en 3 niveles.

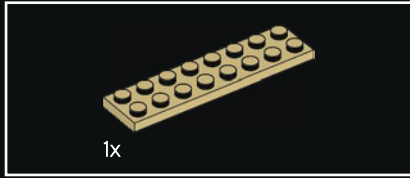
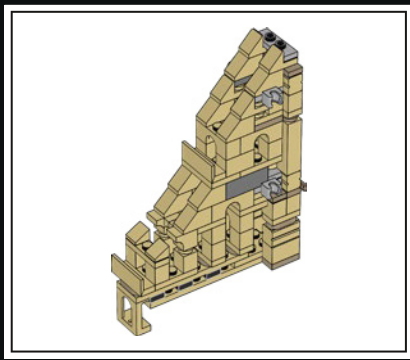

1x

224

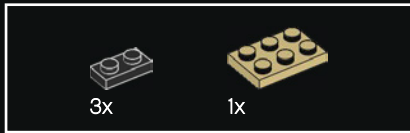
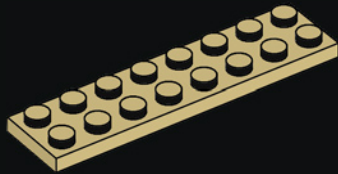

3x

1x

225

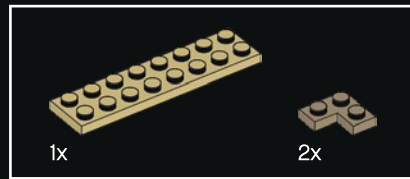
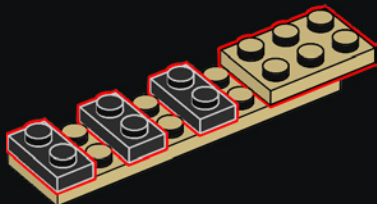

1x

2x

226

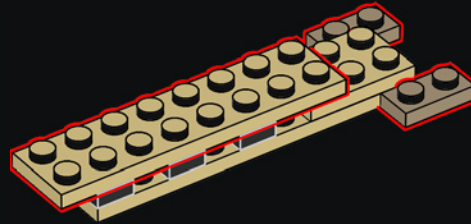

2x

3x

227

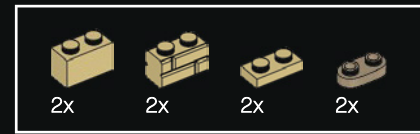
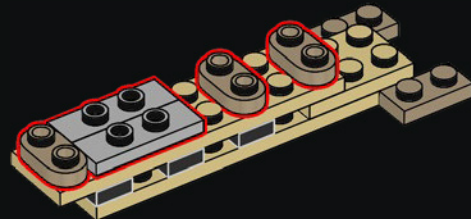

2x

2x

2x

2x

228

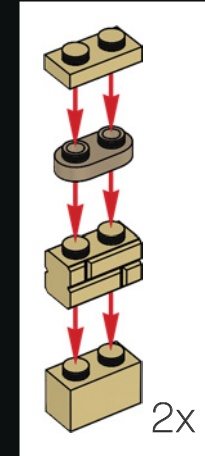

2x

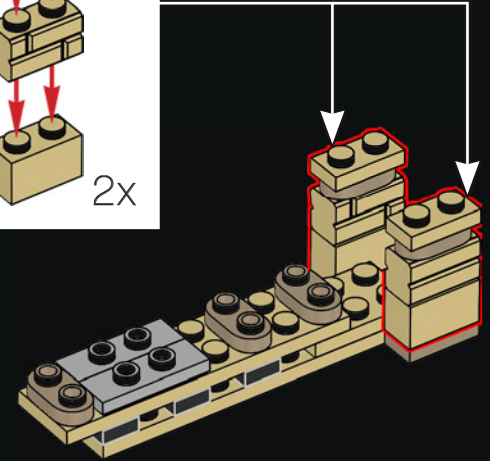



229

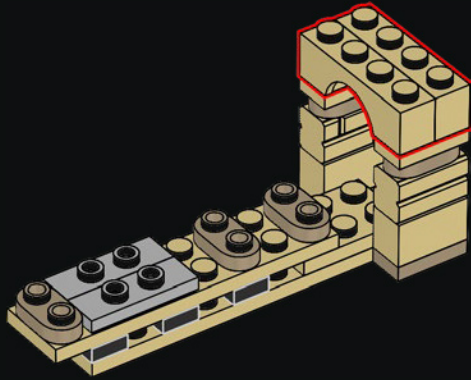

230

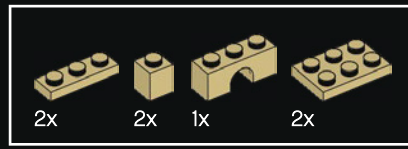
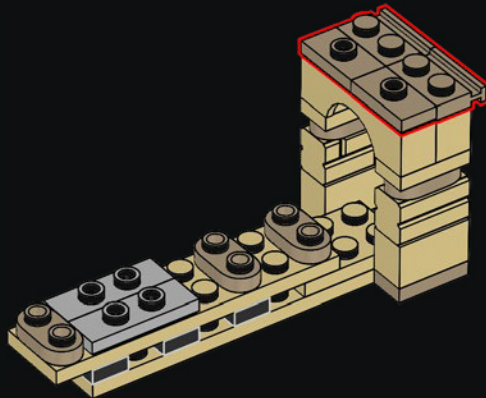

231

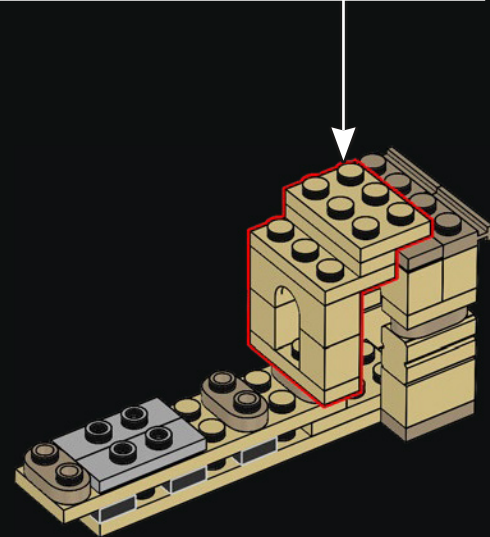
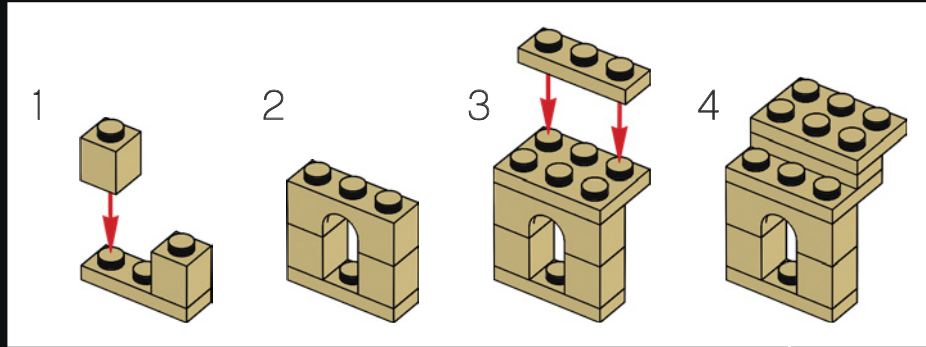

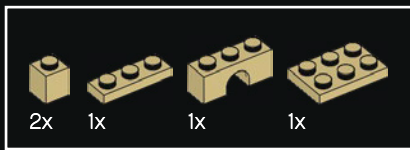

232

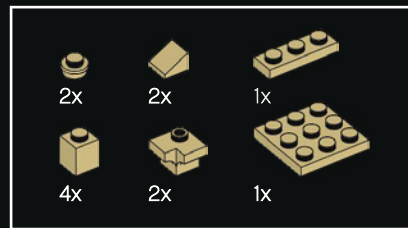
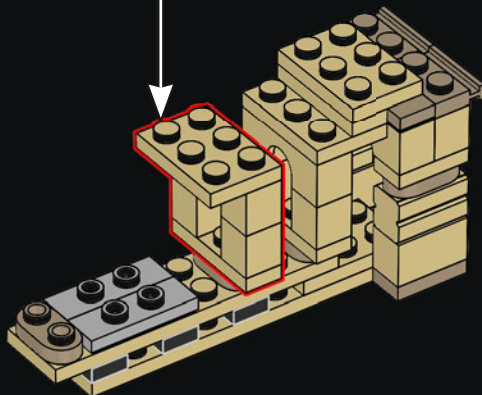
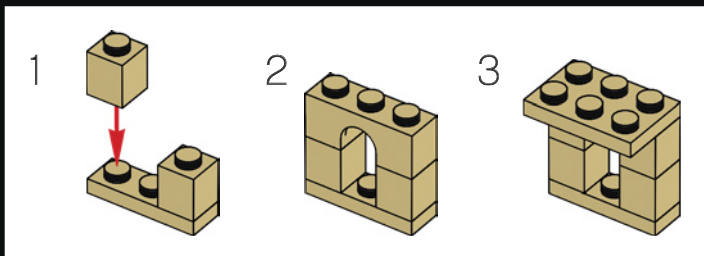

233

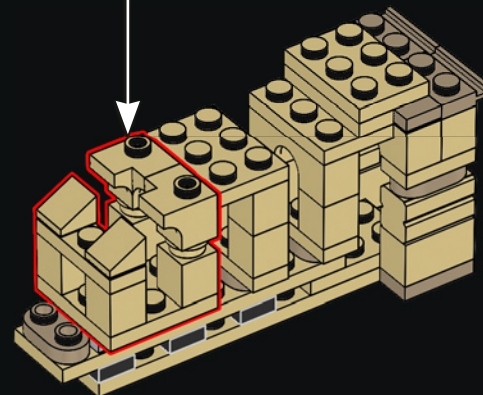
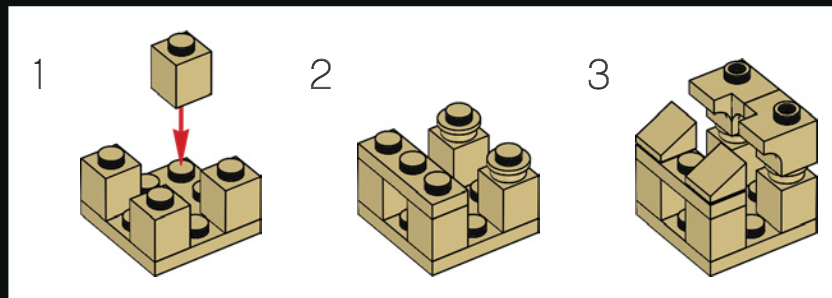

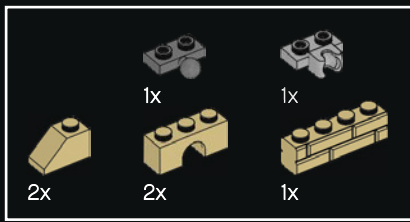

234

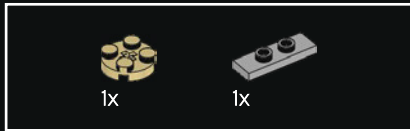
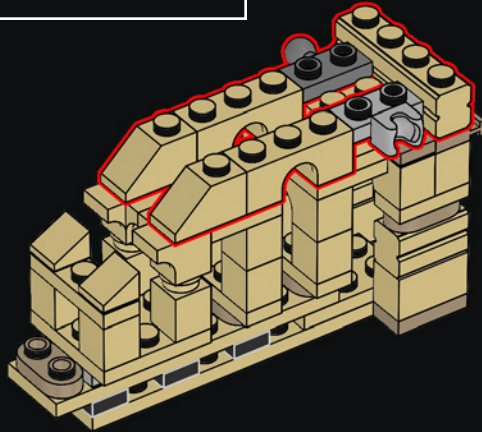

235

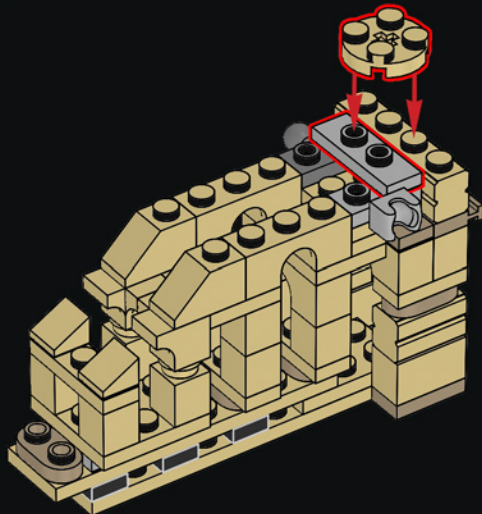

236

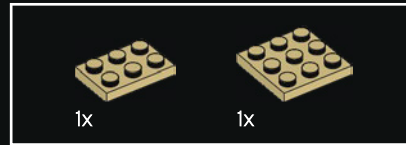
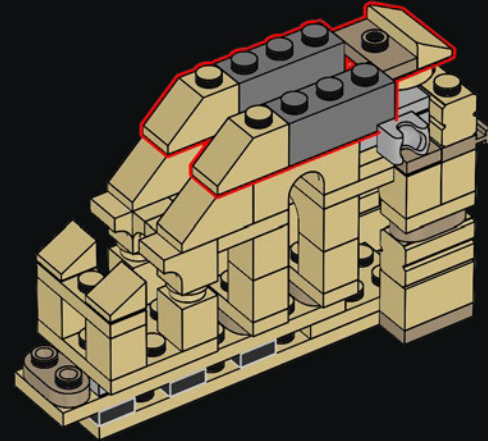

237

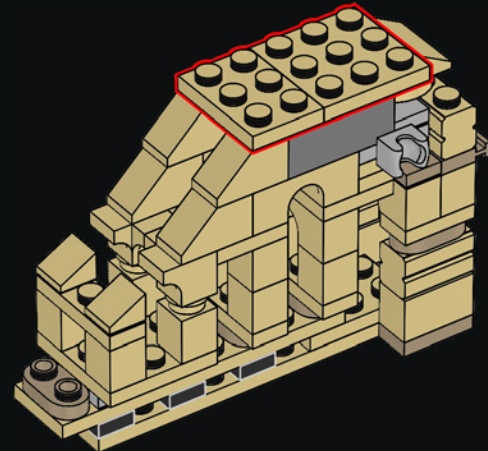



238

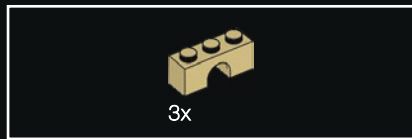
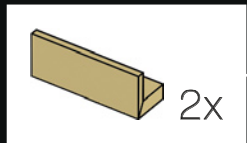
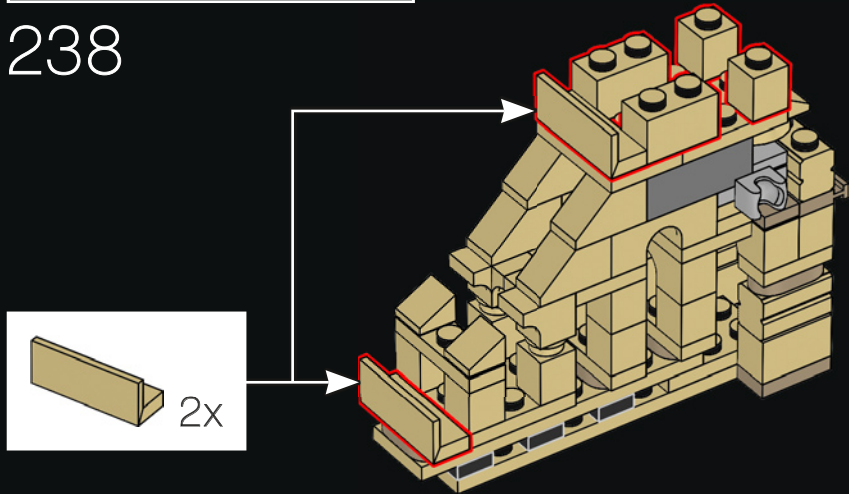

239

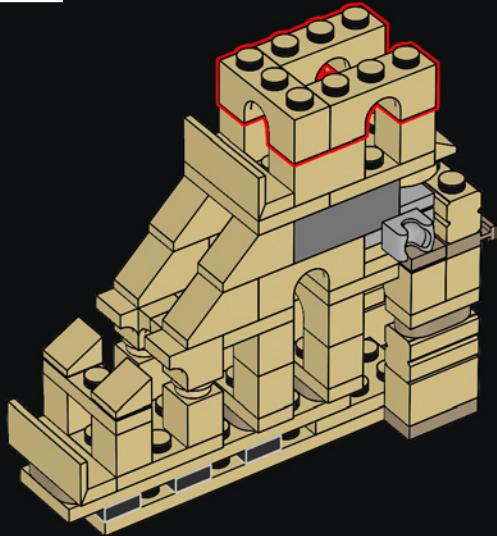

240

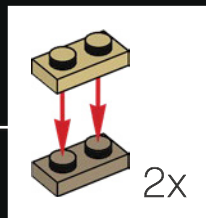
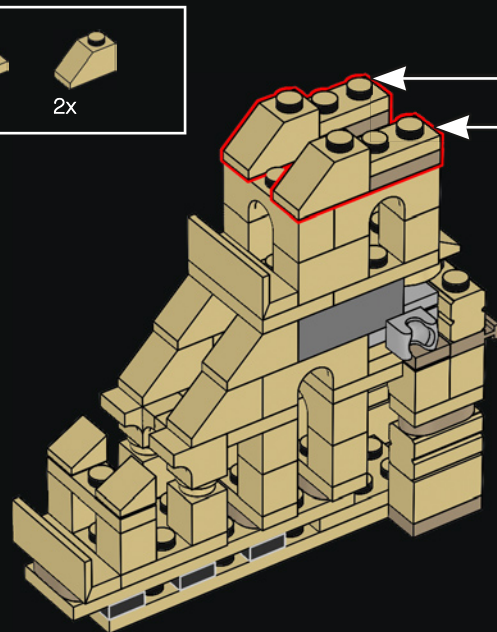

241

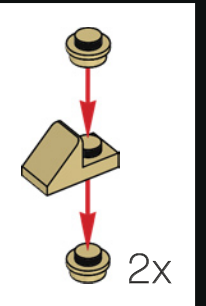
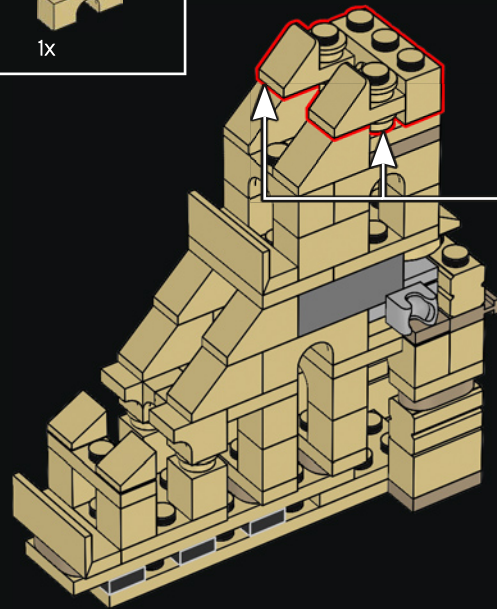



242

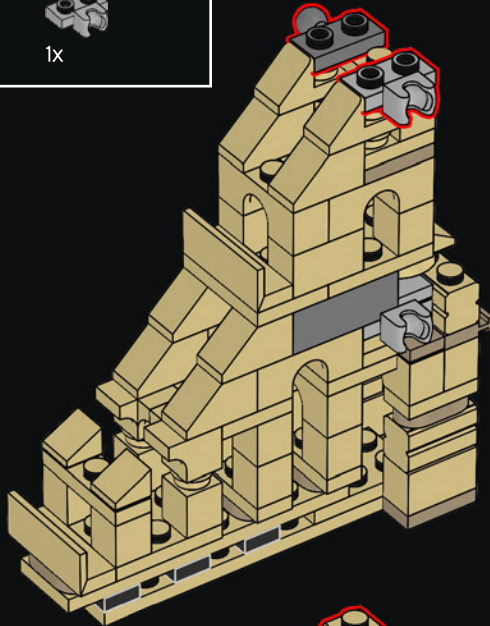

243

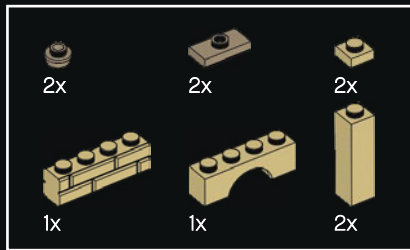
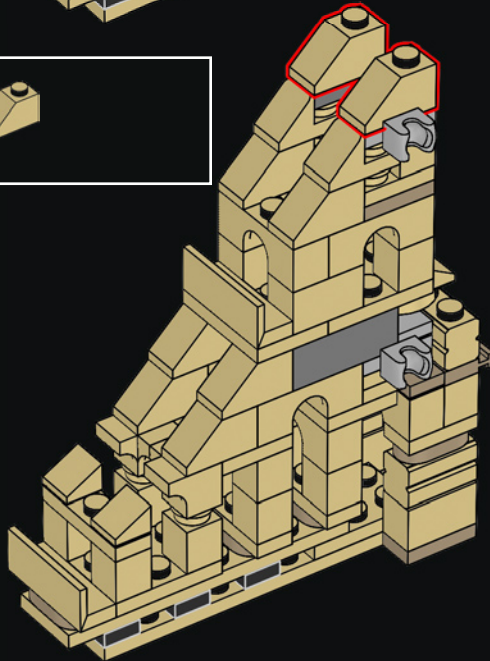

244

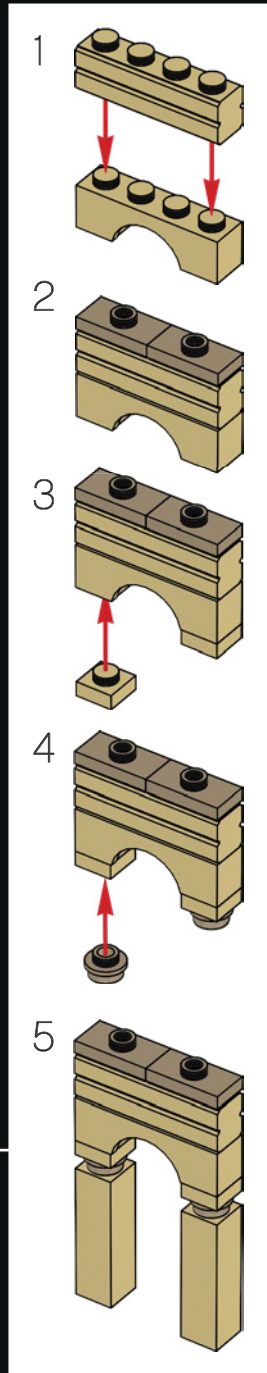
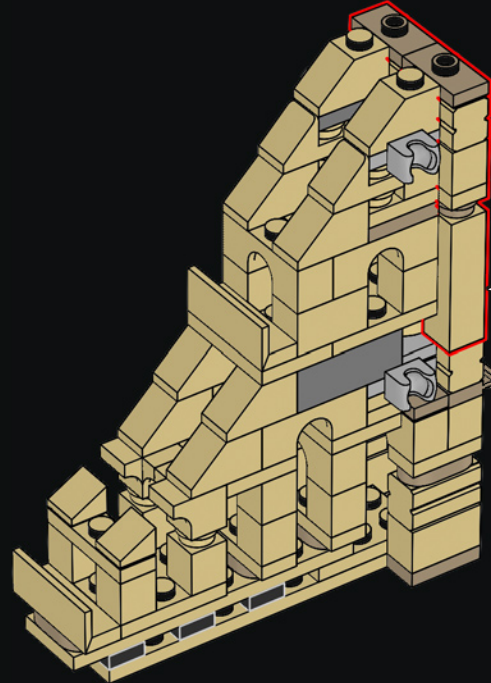



245

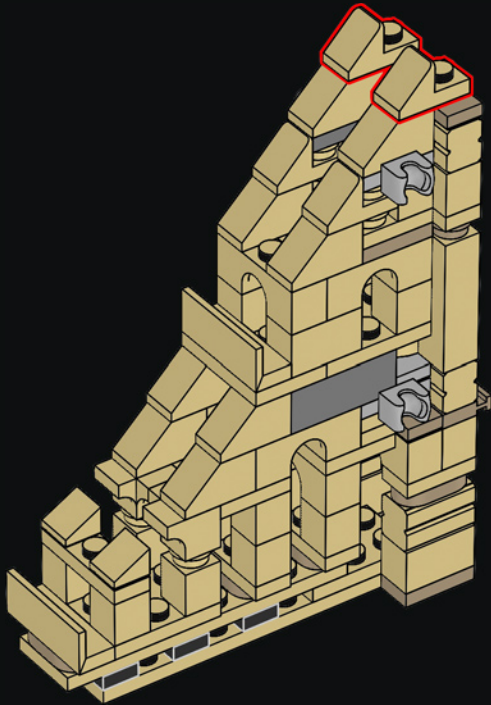

246

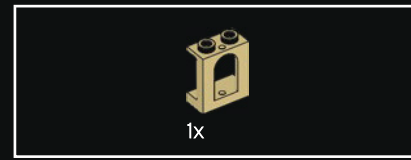
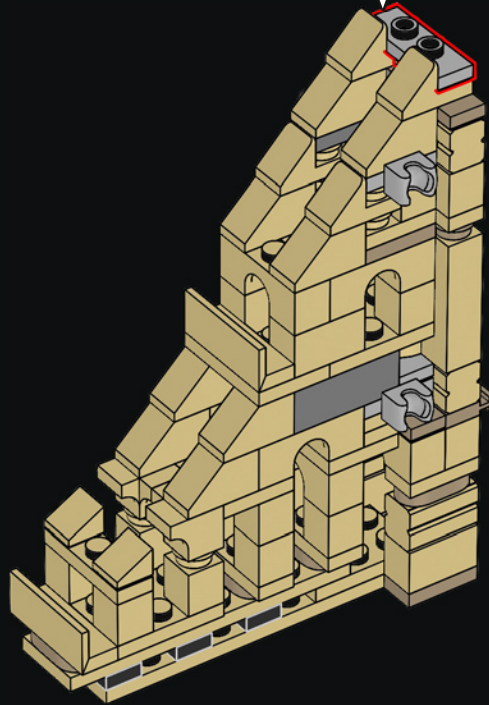
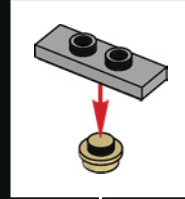

247

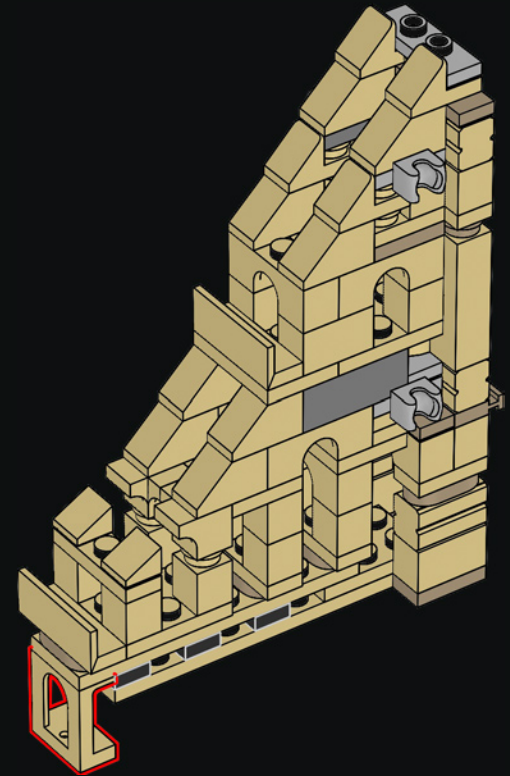

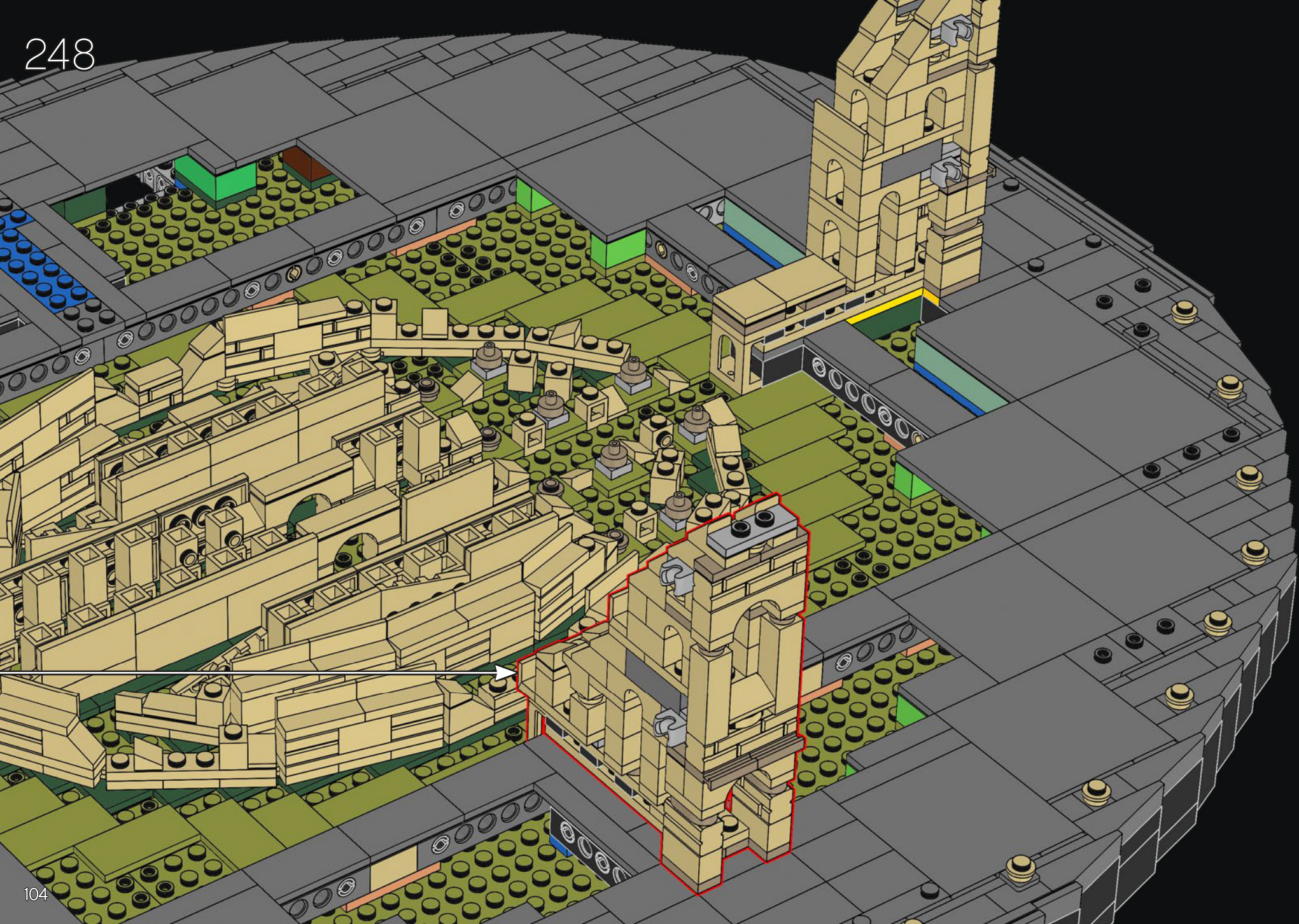

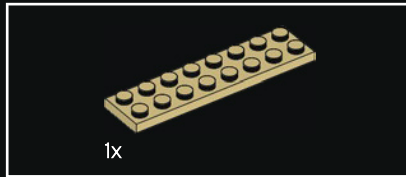
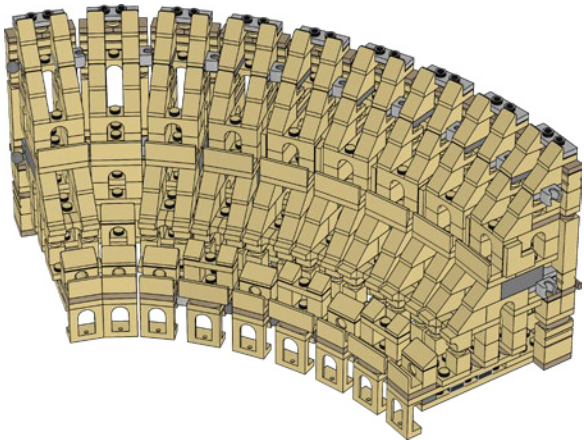
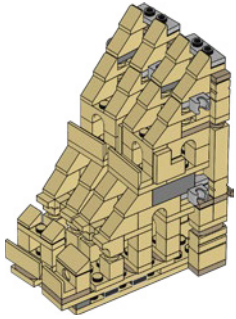
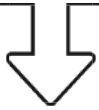

249

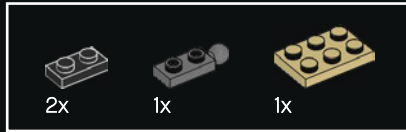
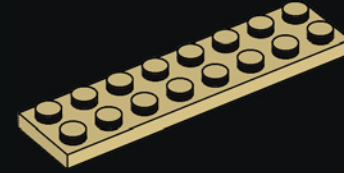

250

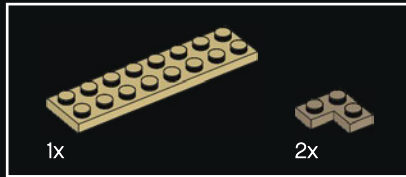
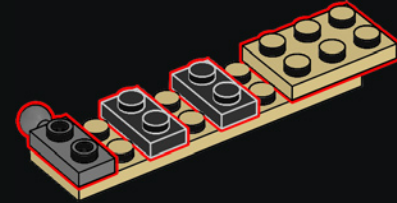

251

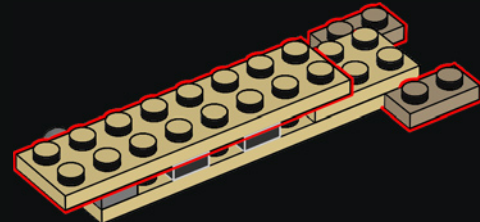



252

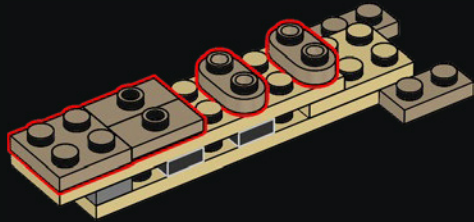

253

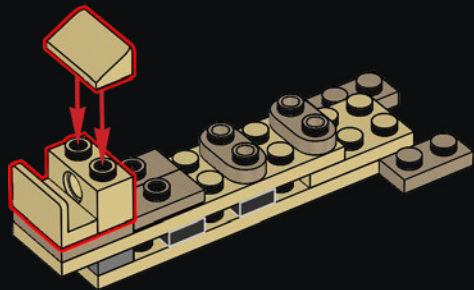

254

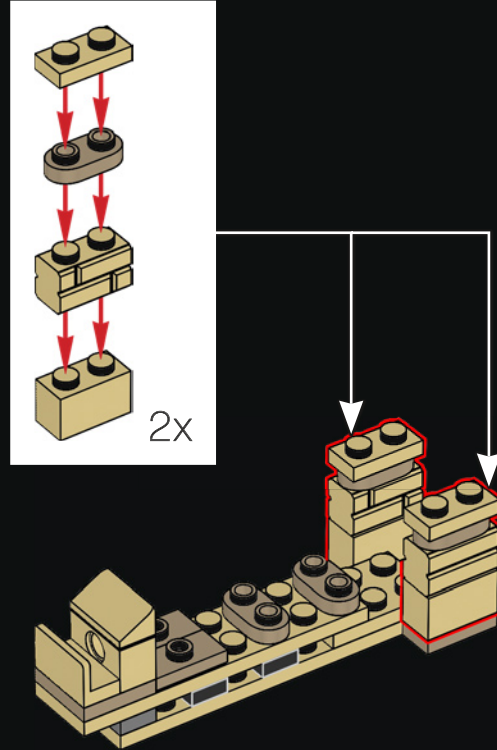



255

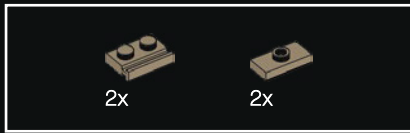
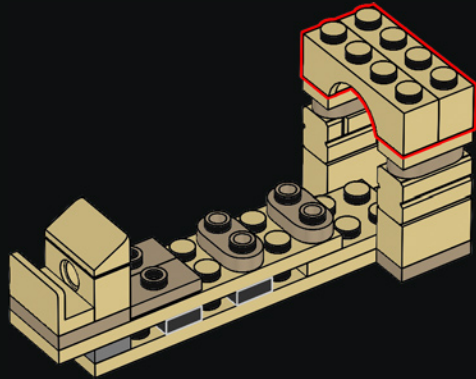

256

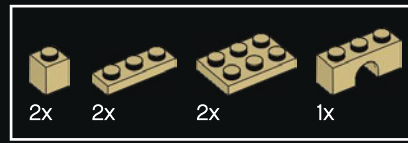
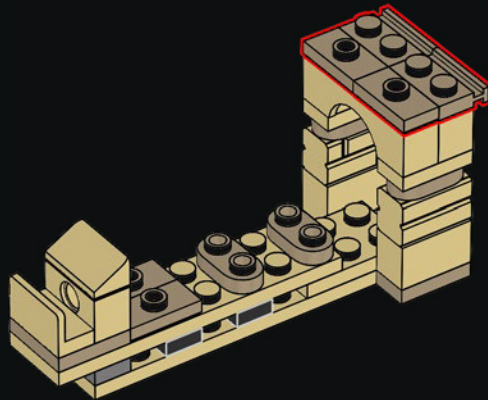

257

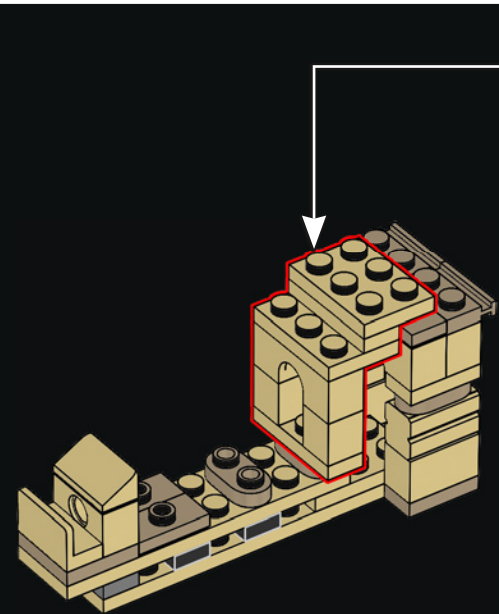
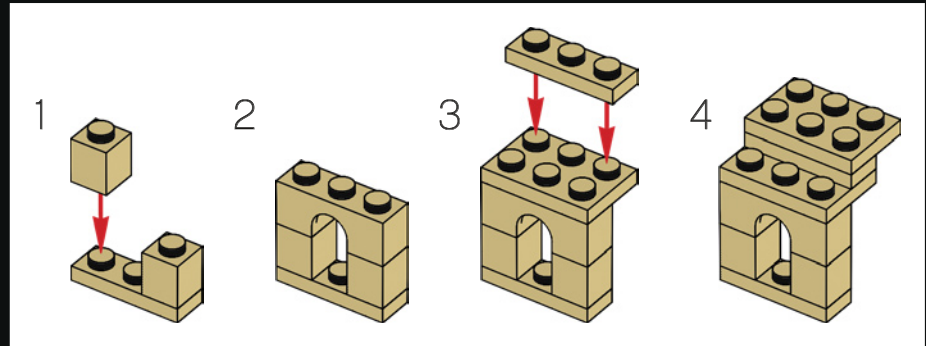

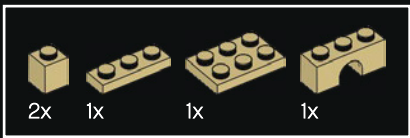

258

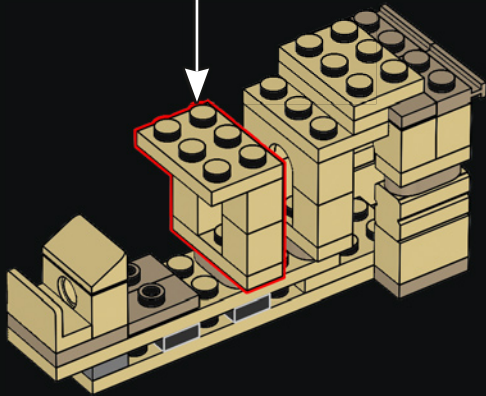
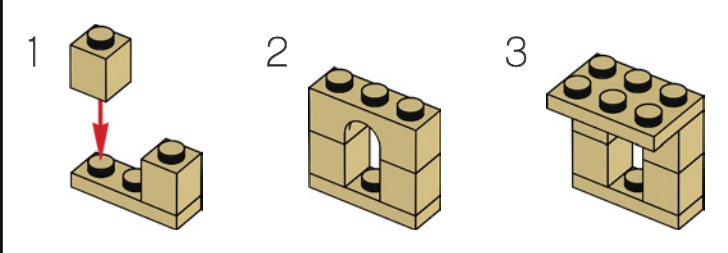

259

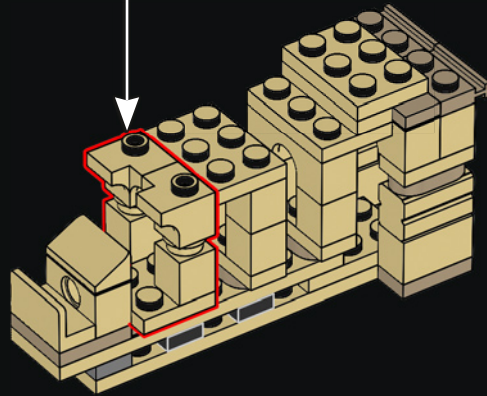
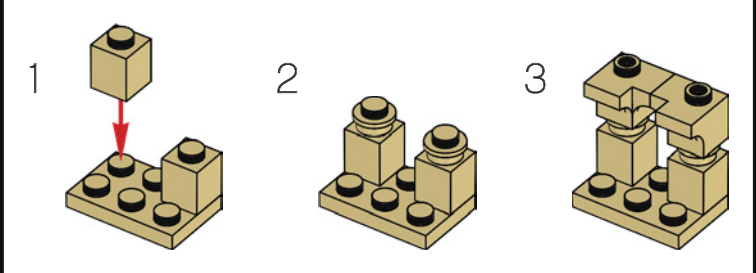

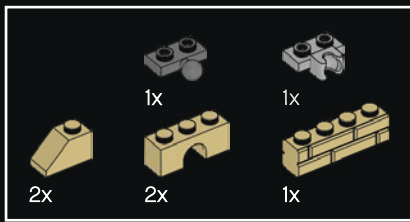

260

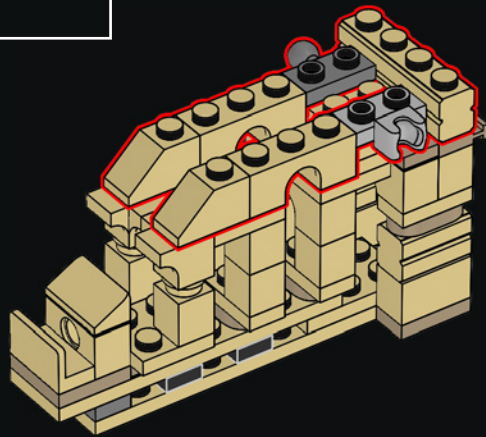

261

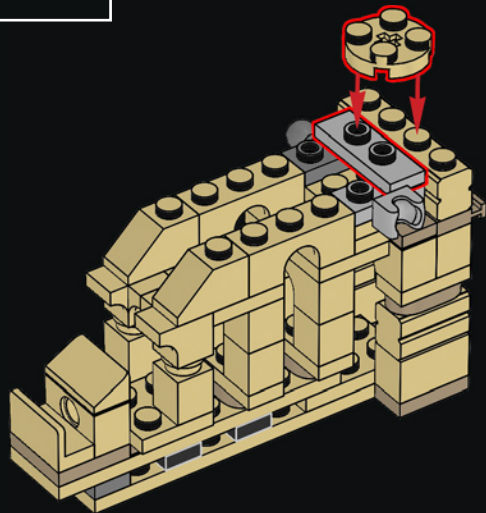

262

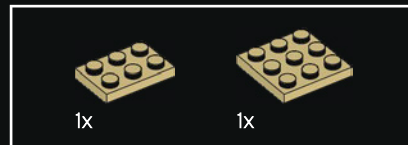
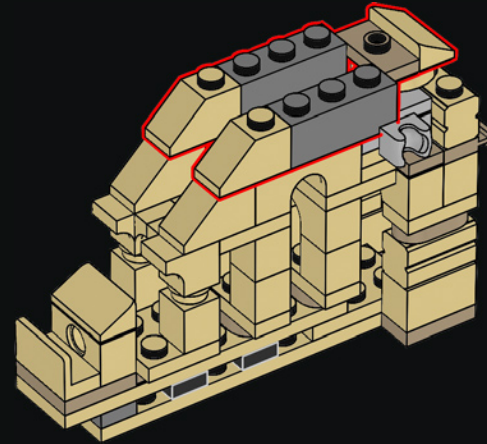

263

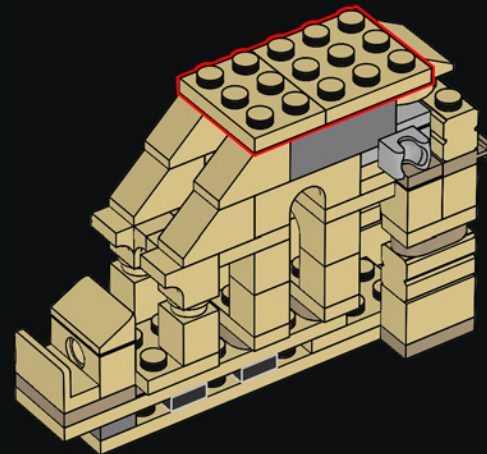



264

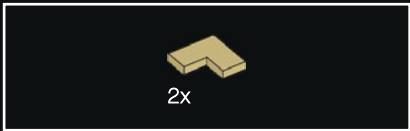
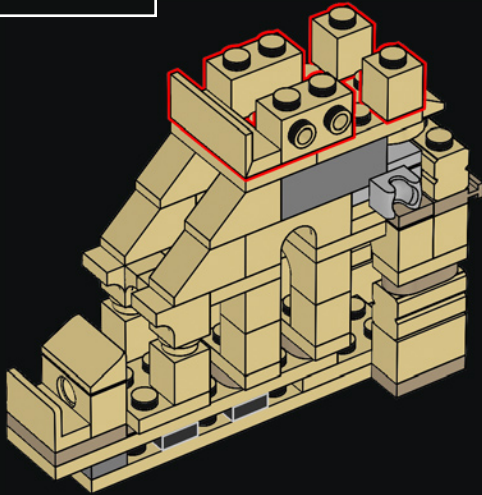

265

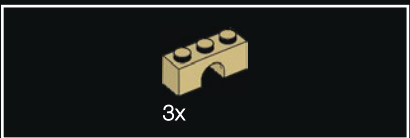
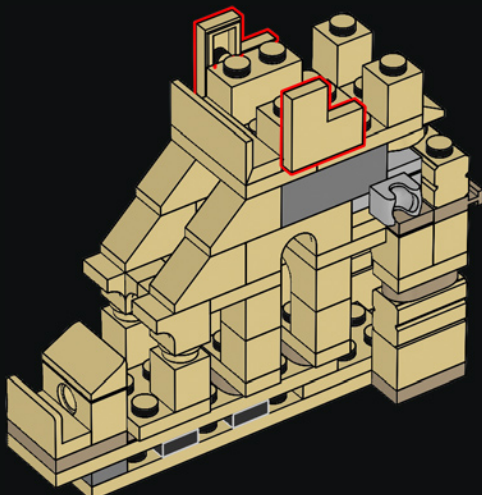

266

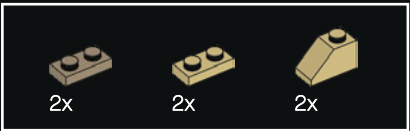
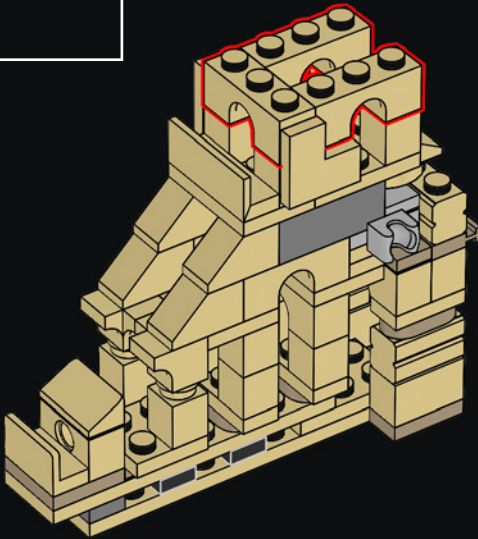

267

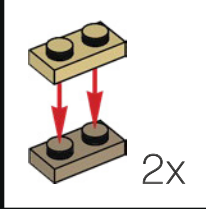
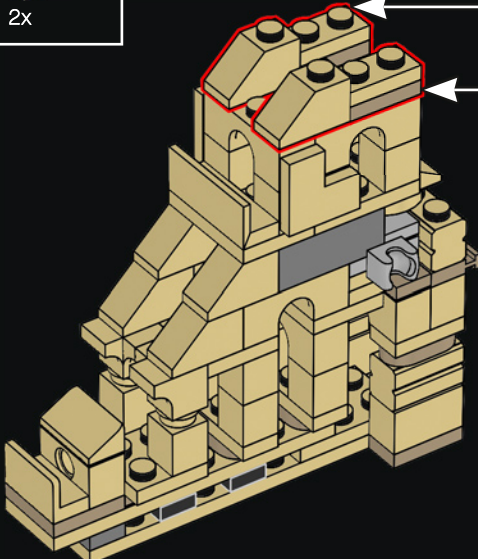

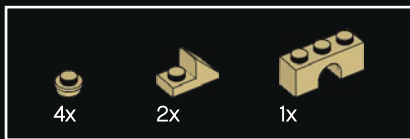

268

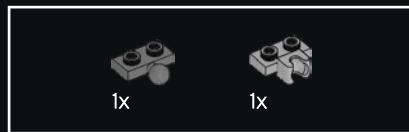
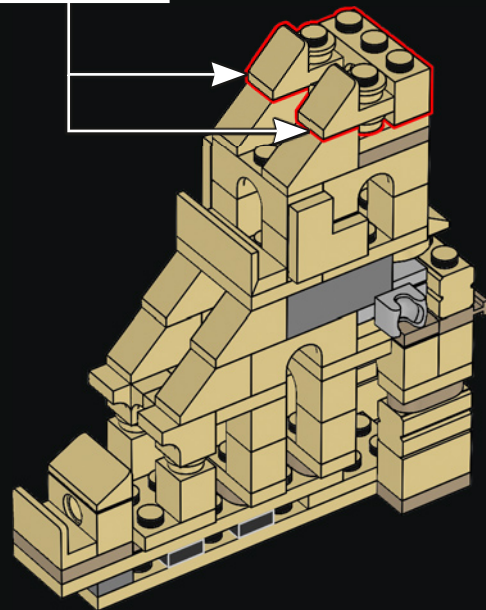
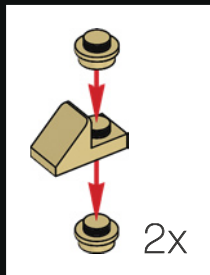

269

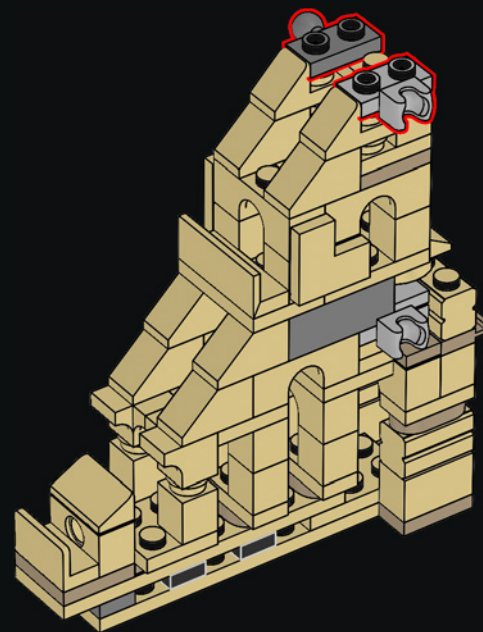



270

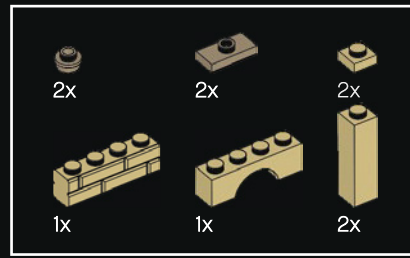
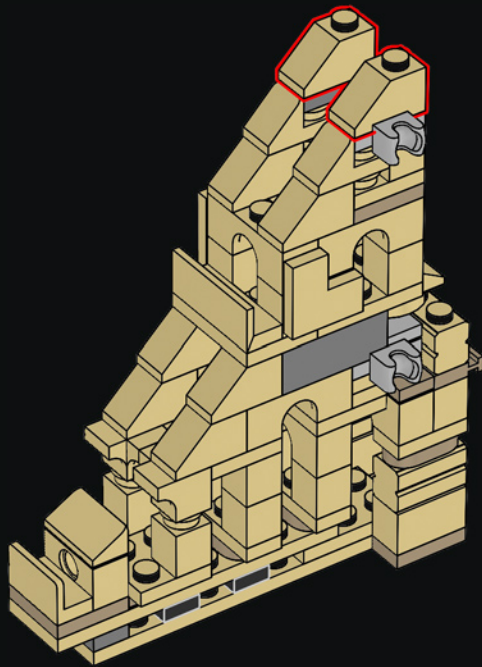

271



- 1
- 2
- 3
- 4
- 5



272

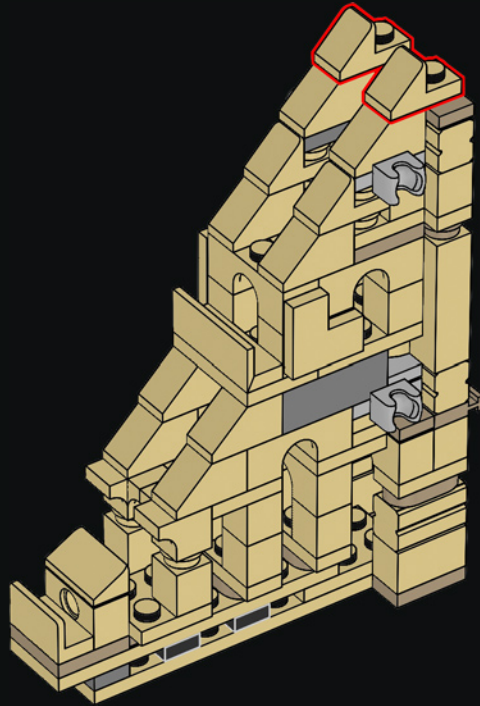

273

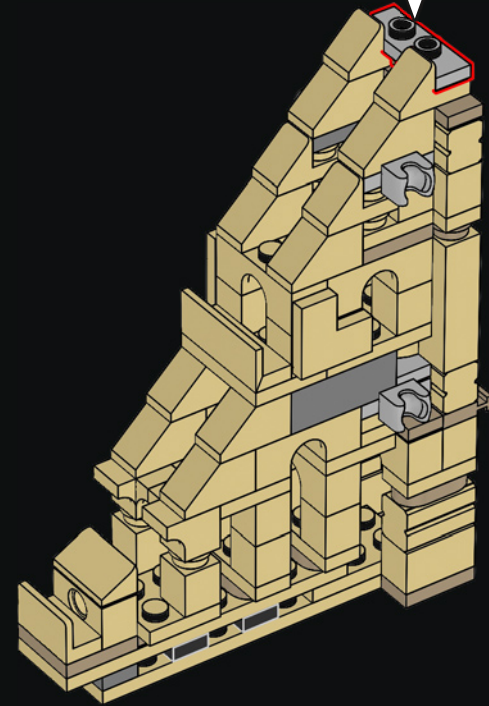
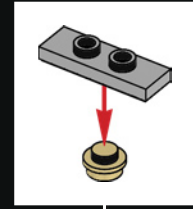

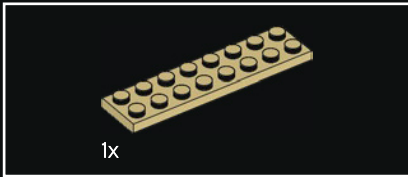
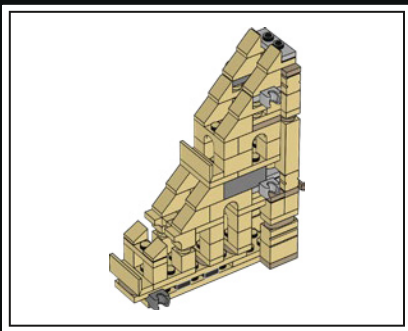

274

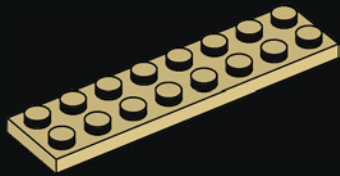

275

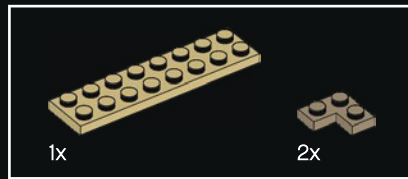
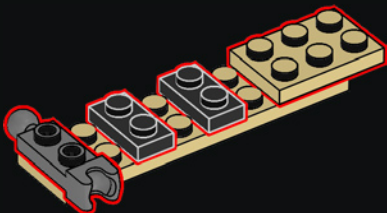

276

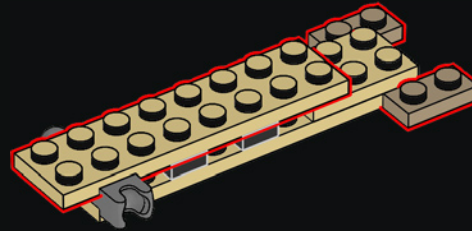

277

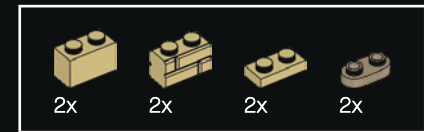
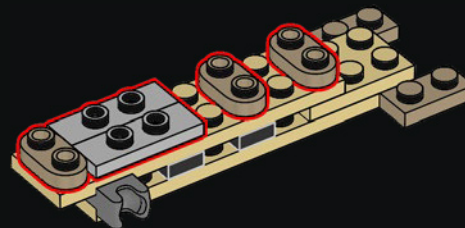

278

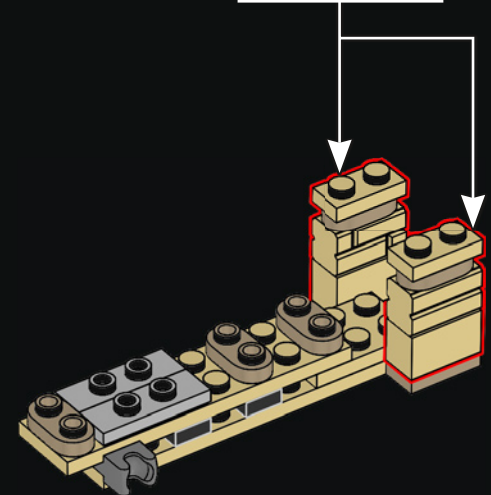
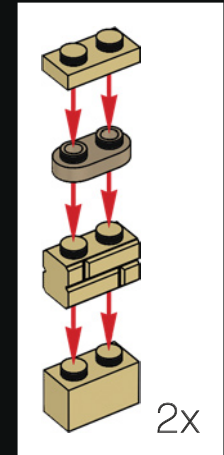

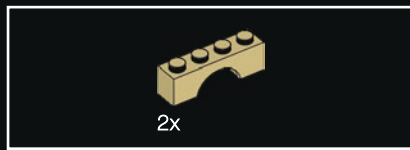

279

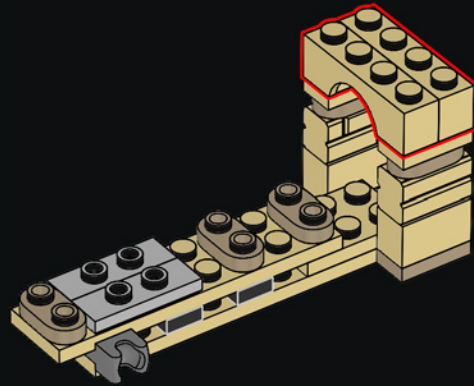

280

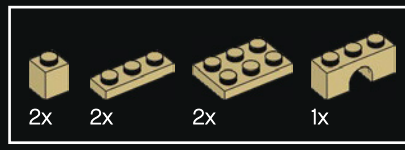
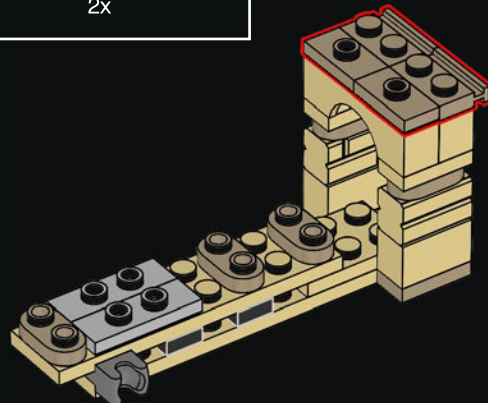

281

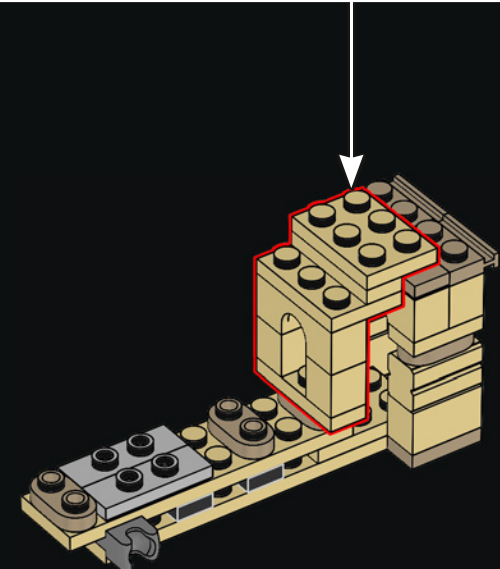
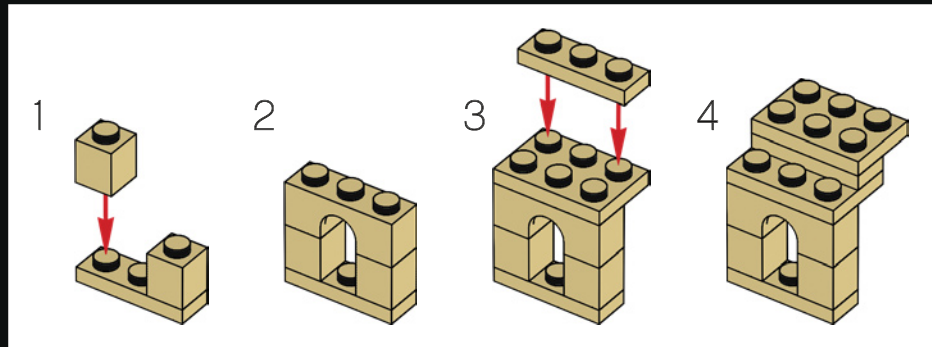

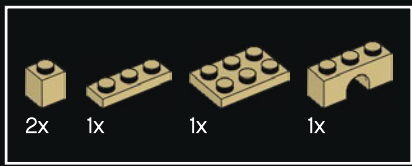

282

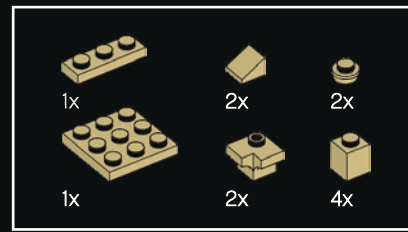
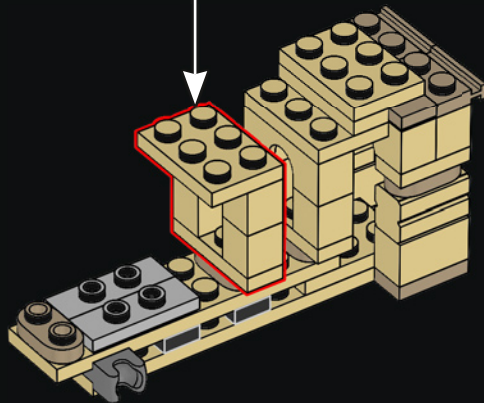
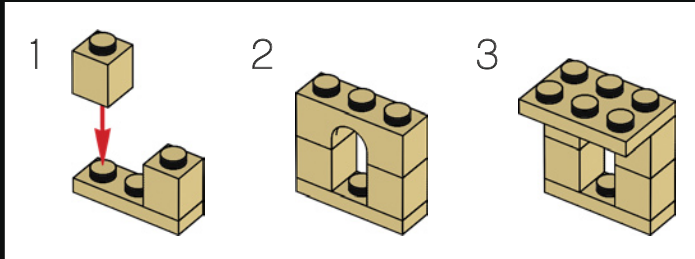

283

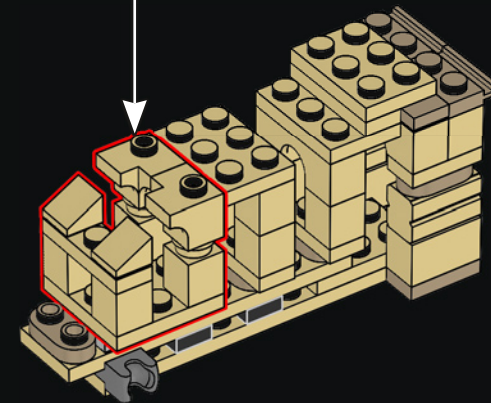
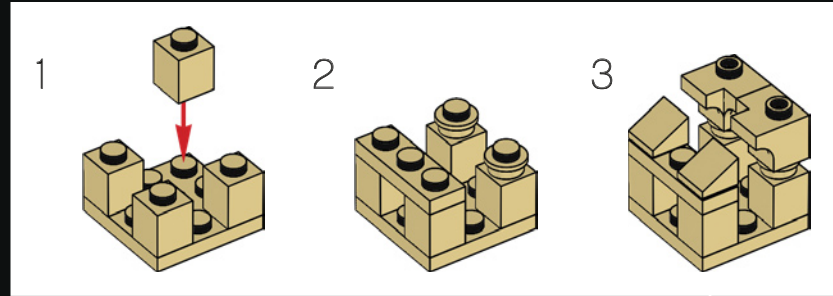

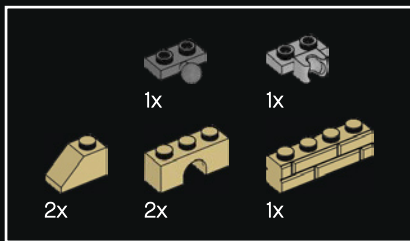

284

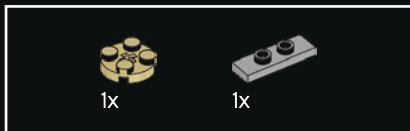
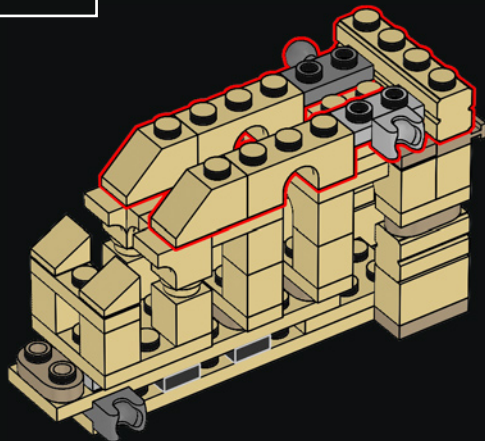

285

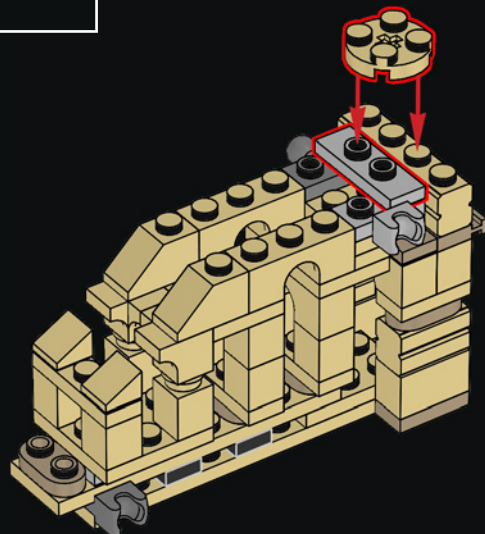

286

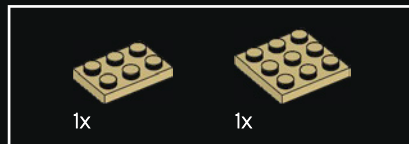
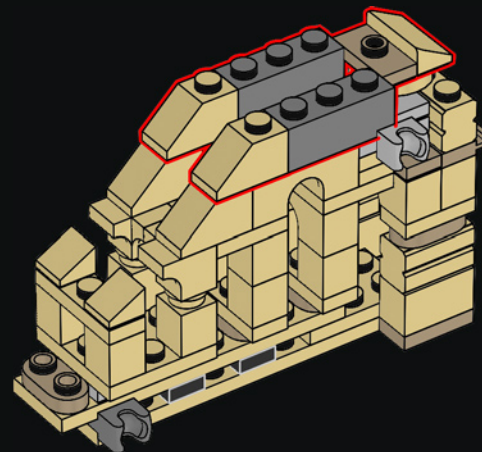

287

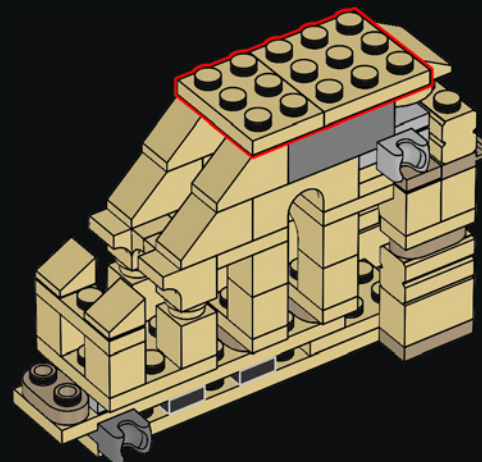



288

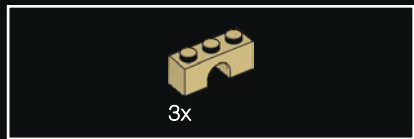
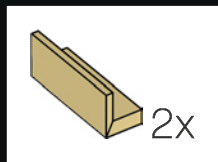
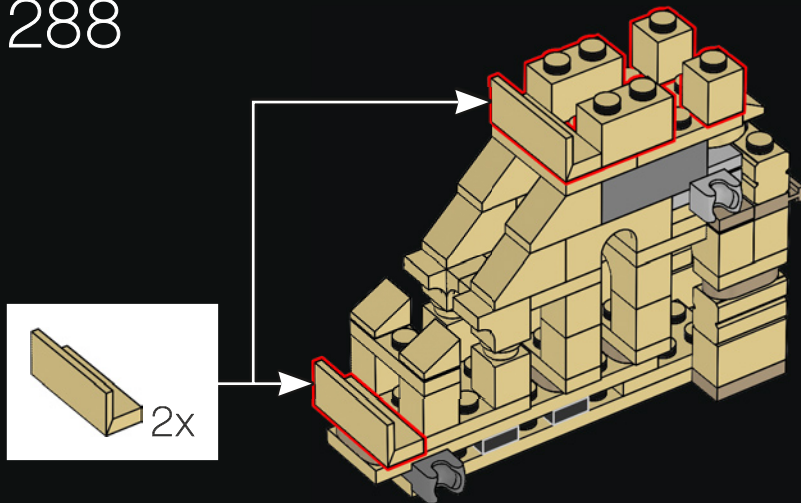

289

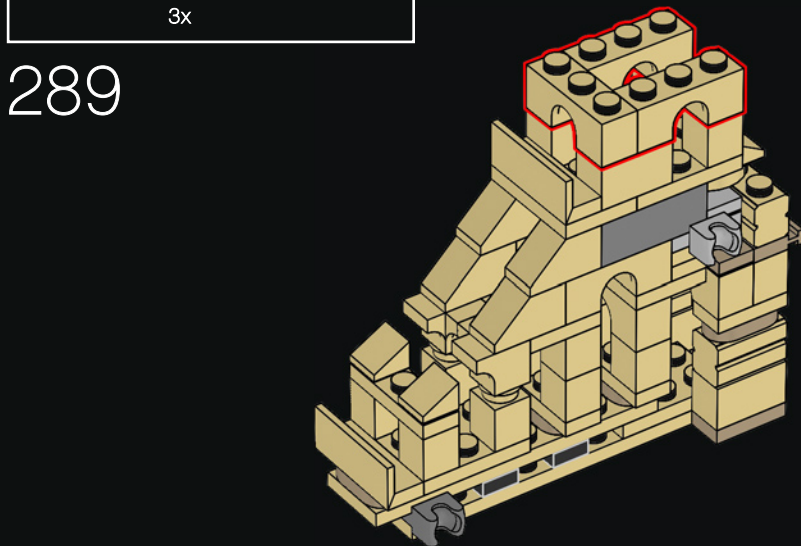

290

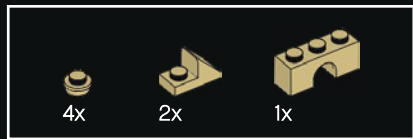
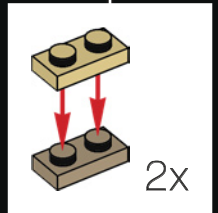
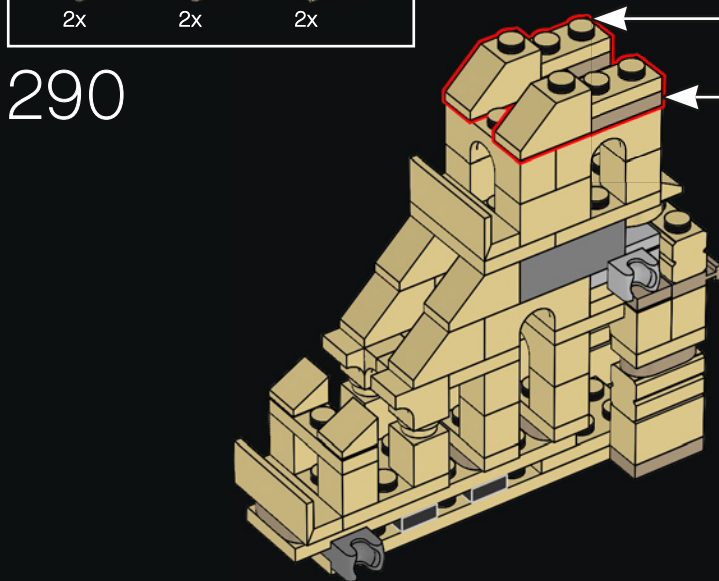

291

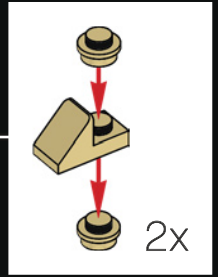
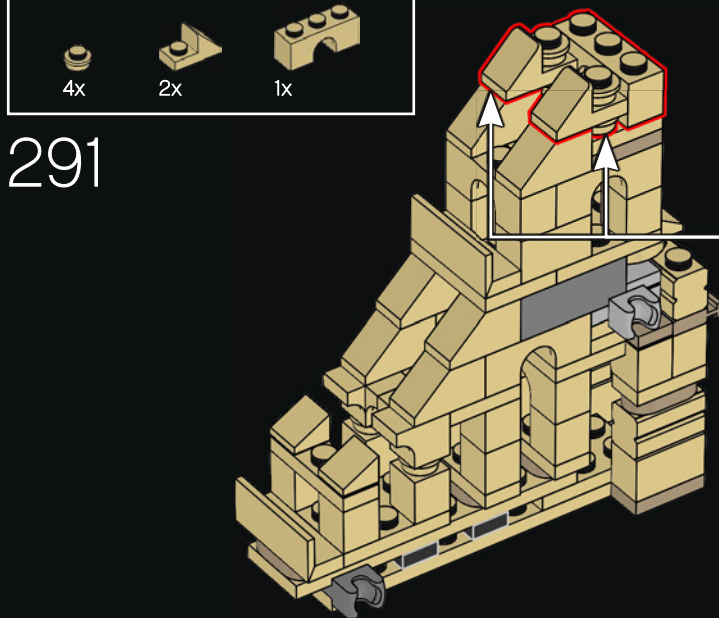



292

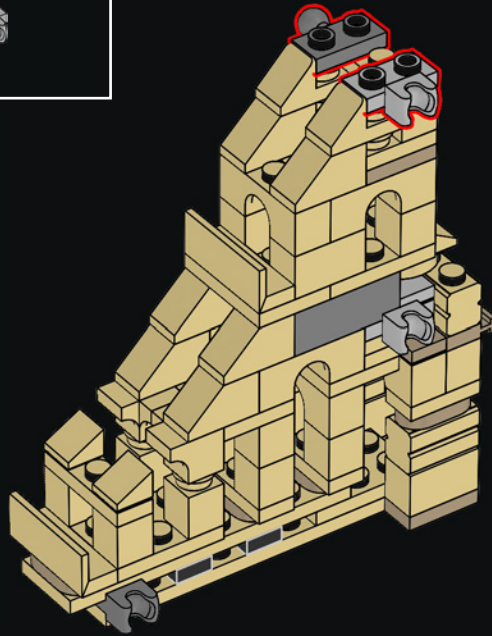

293

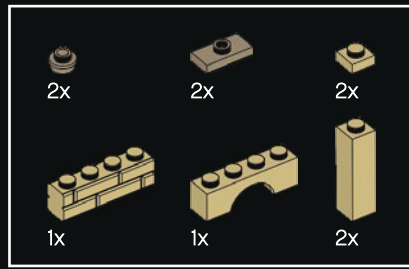
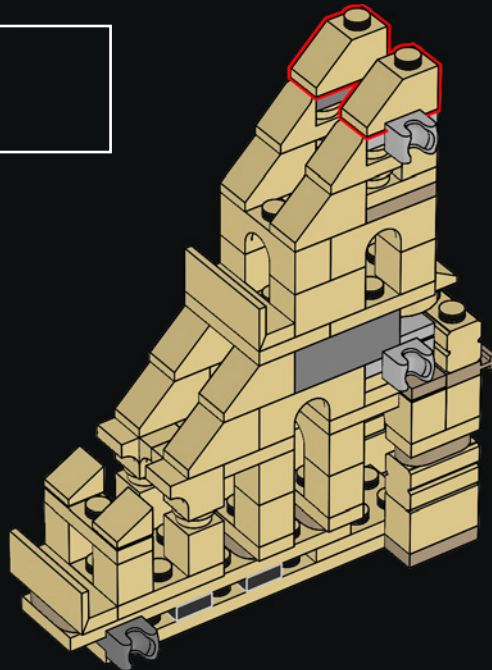

294

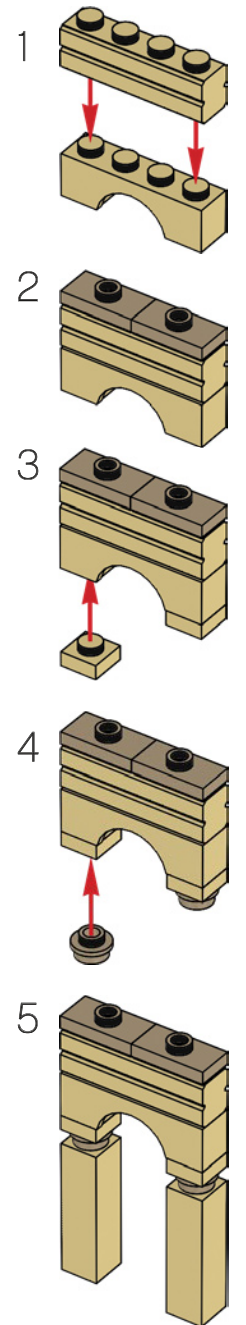
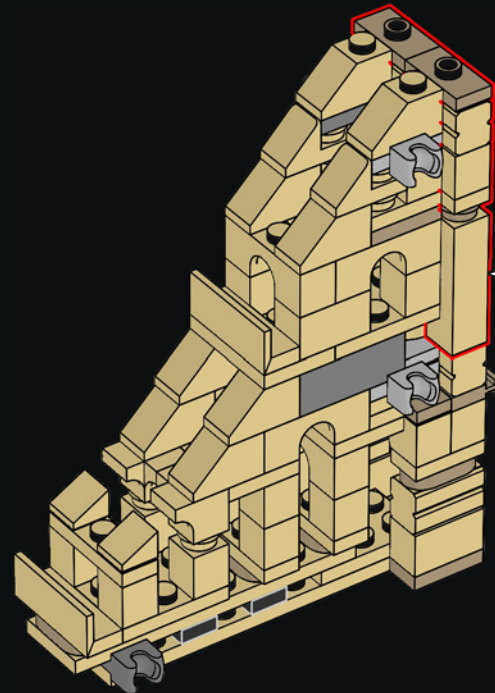



2x

295

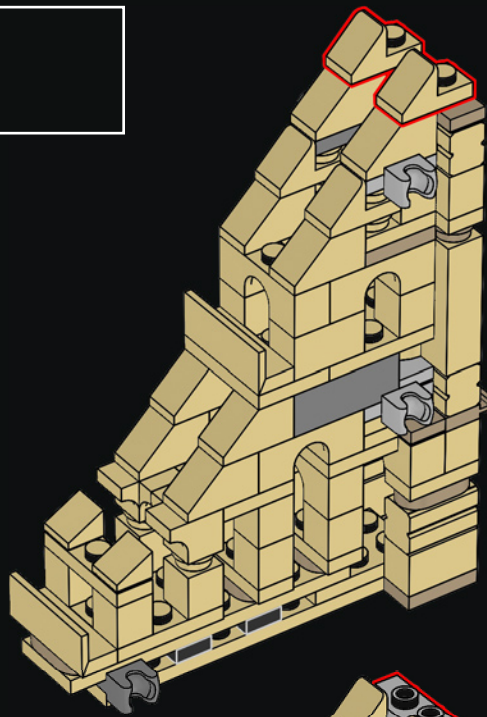

1x

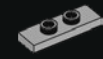

1x

296

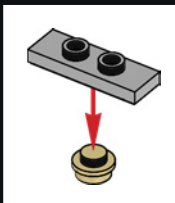
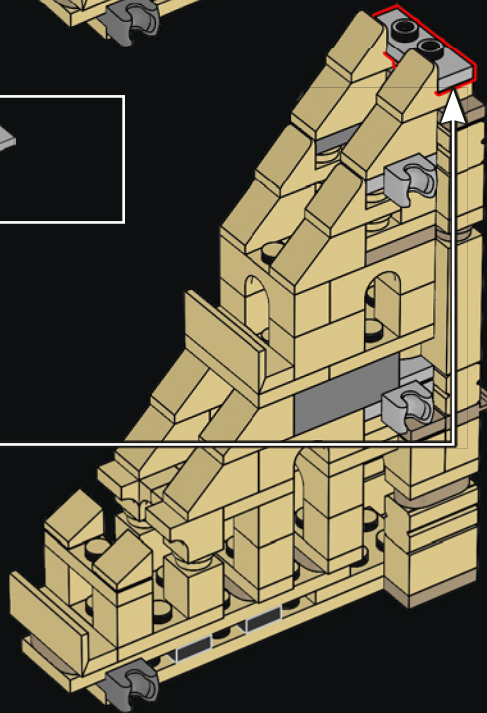

297

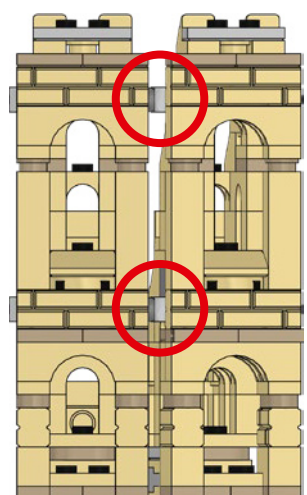
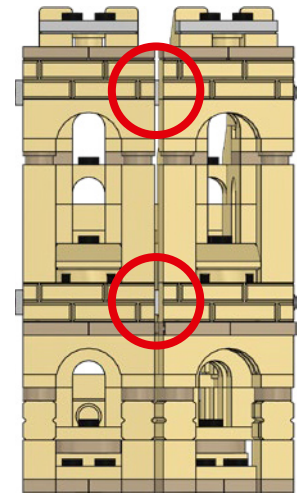
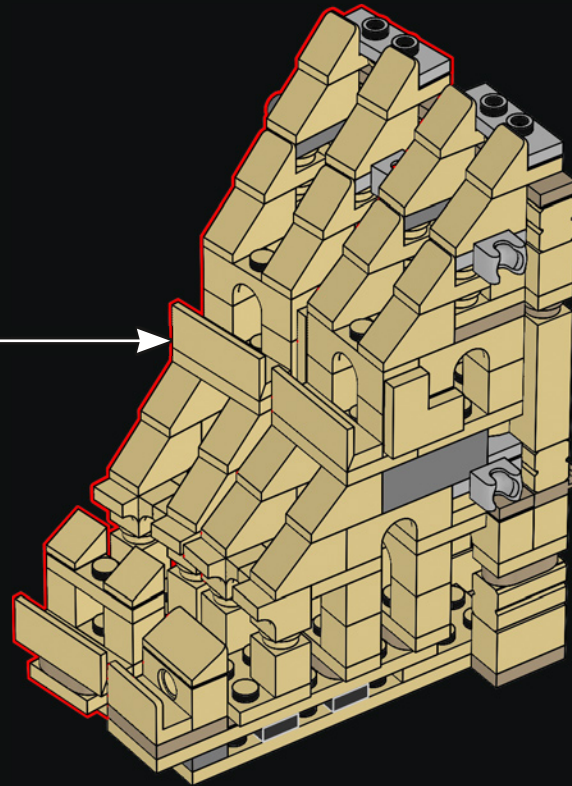

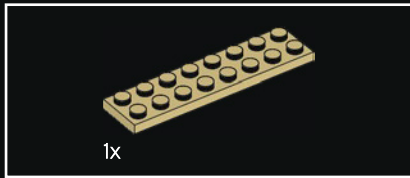
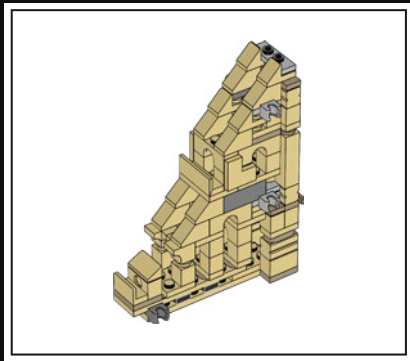
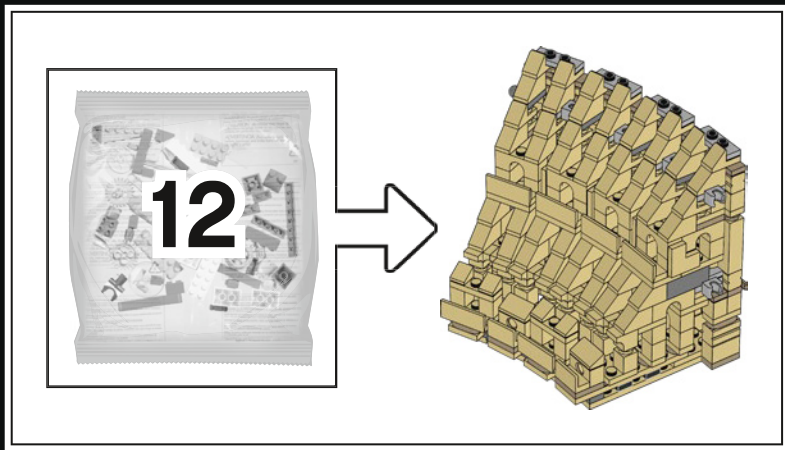

298

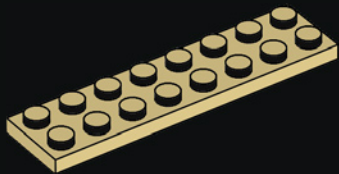

299

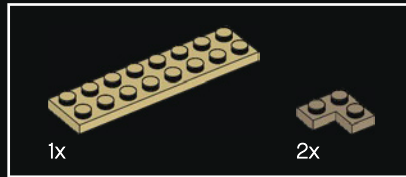
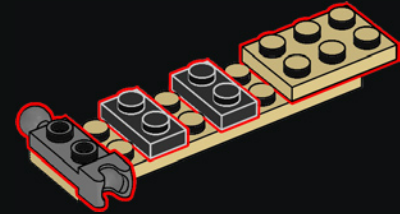

300

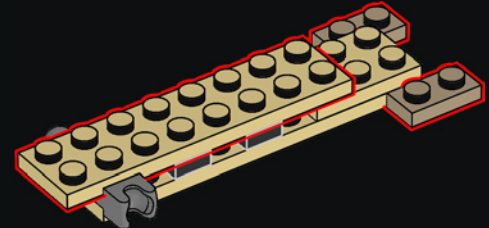

301

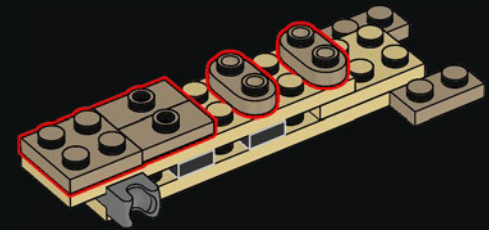



302

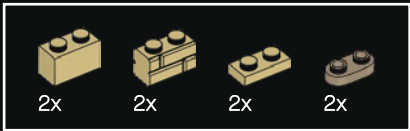
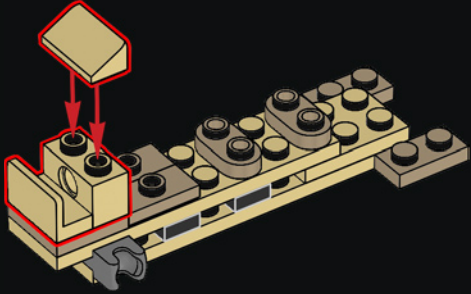

303

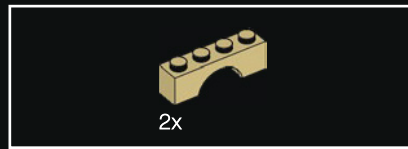
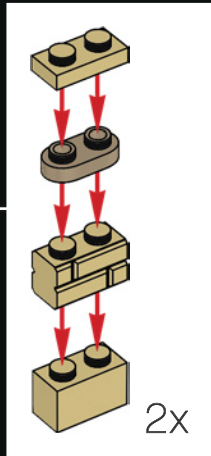
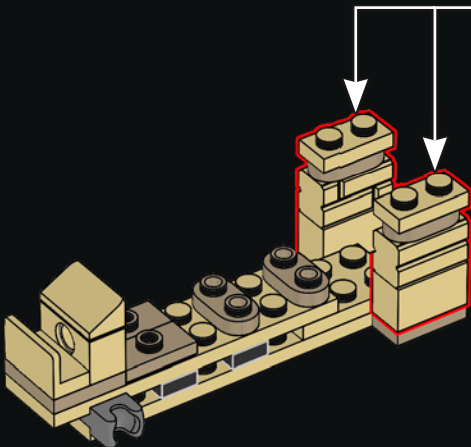

304

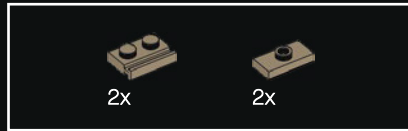
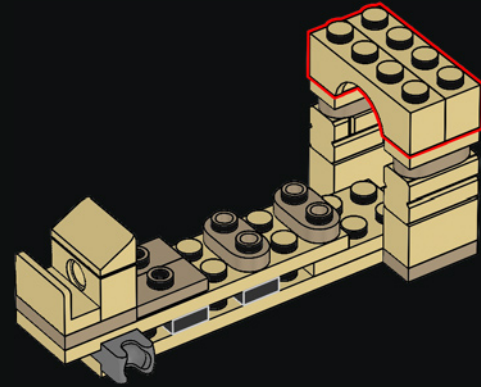

305

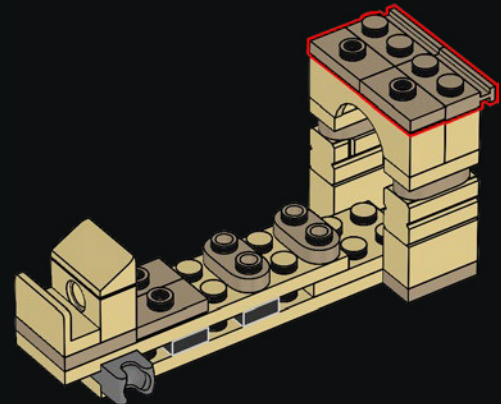

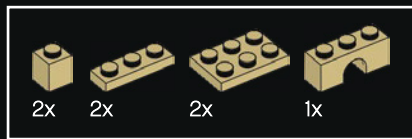

306

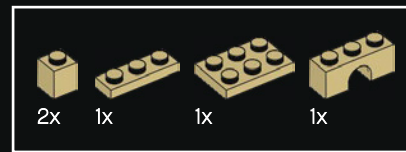
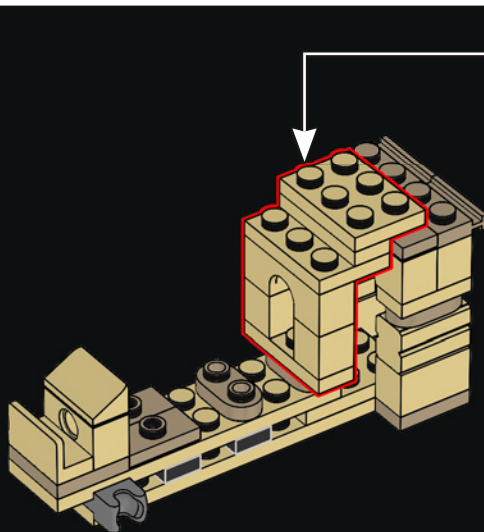
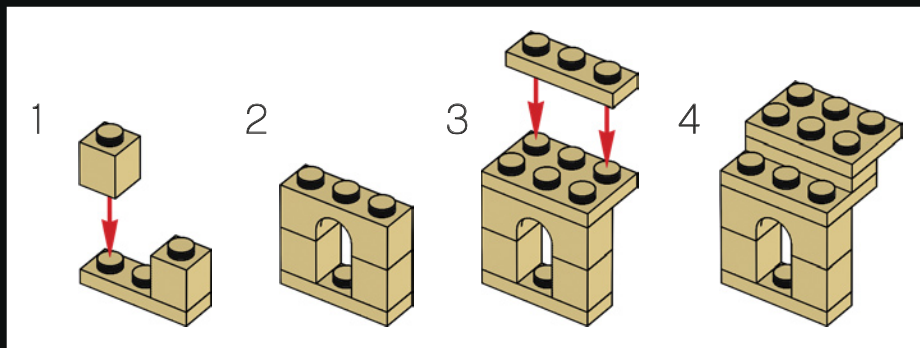

307

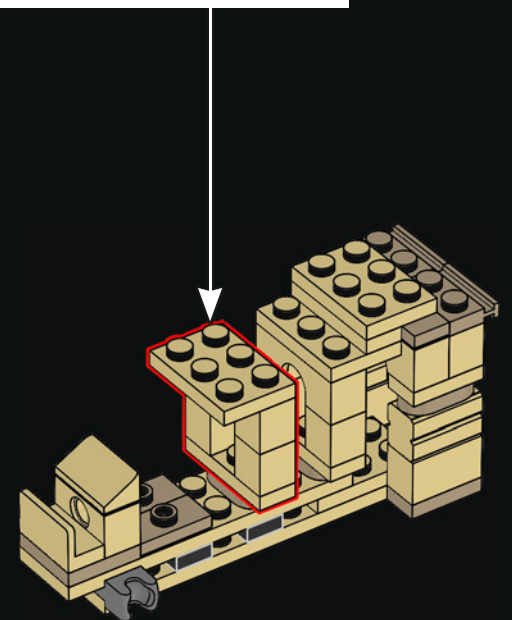
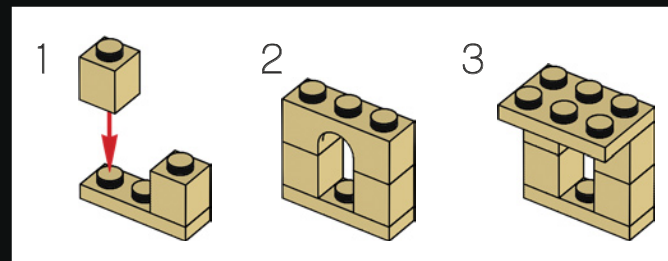



308

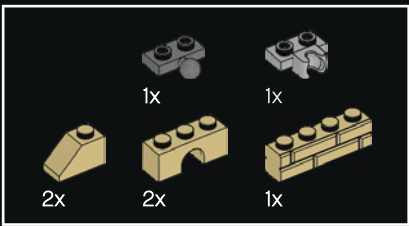
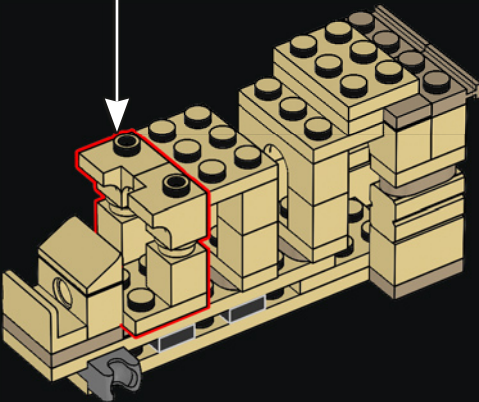
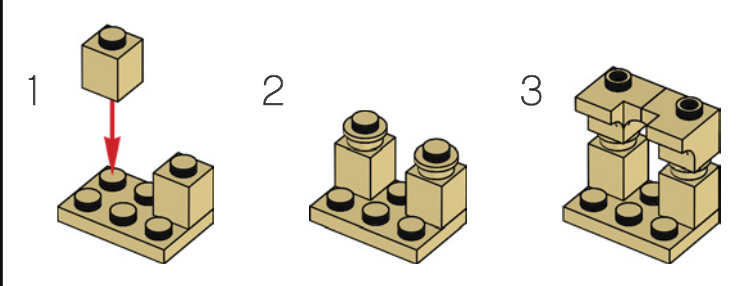

309

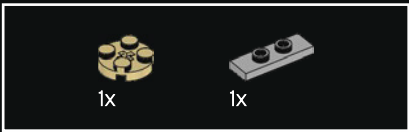
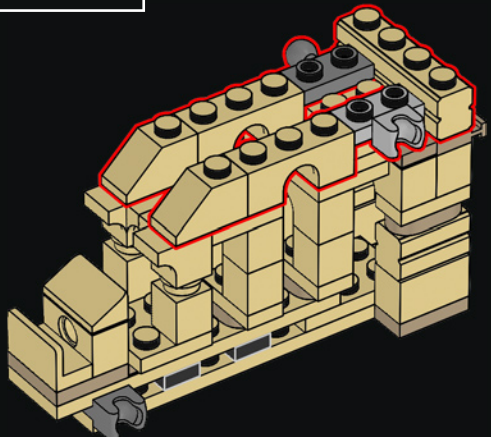

310

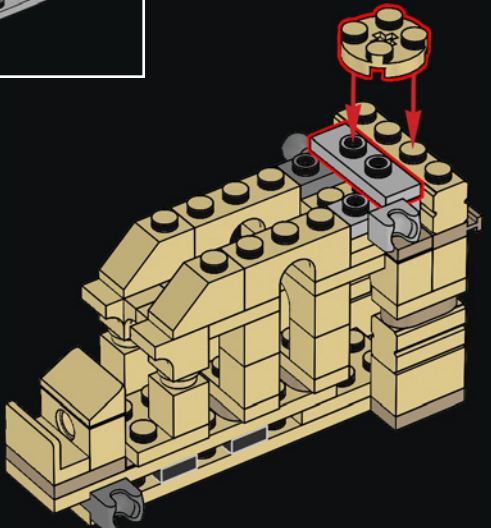



311

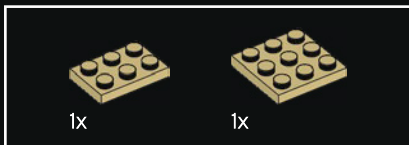
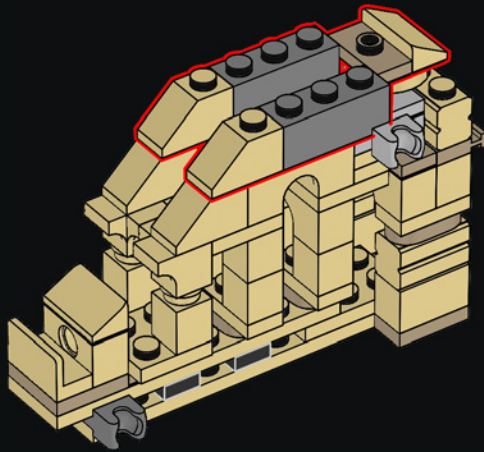

312

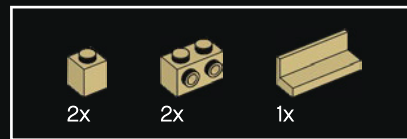
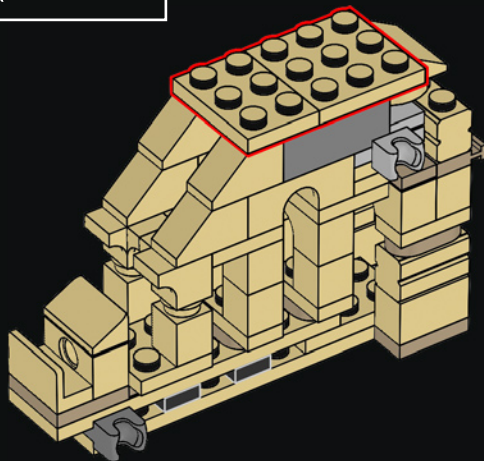

313

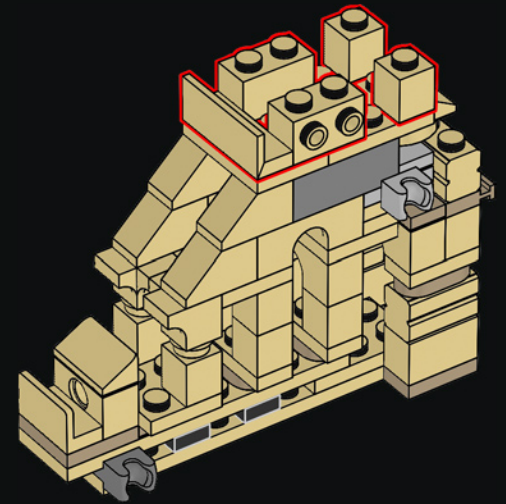

314

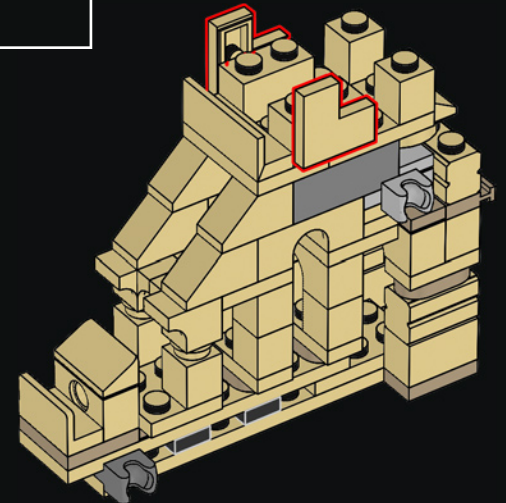

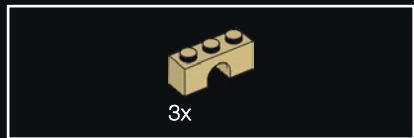

315

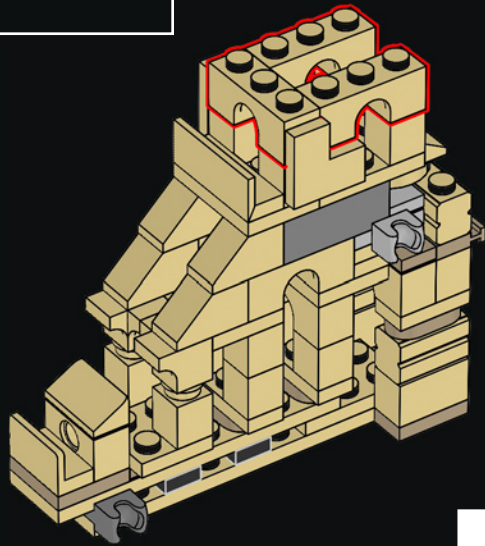

316

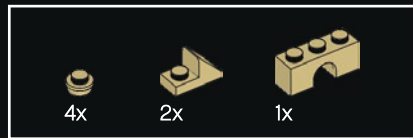
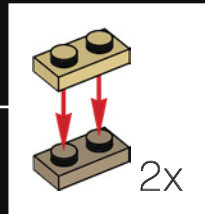
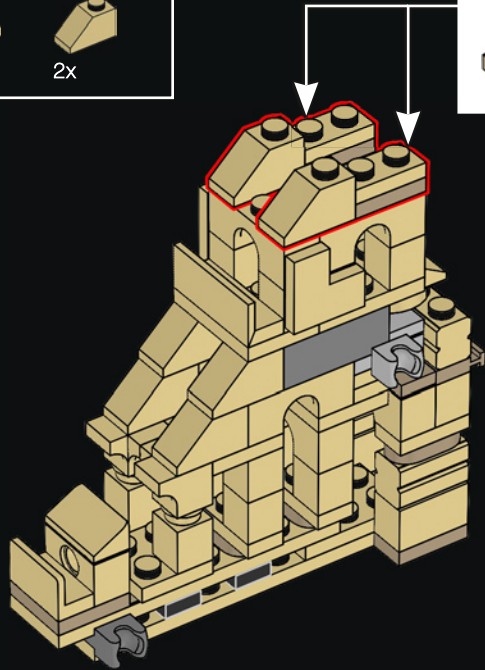

317

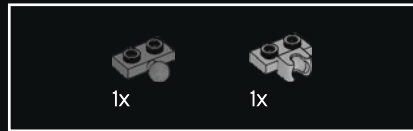
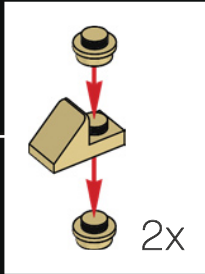
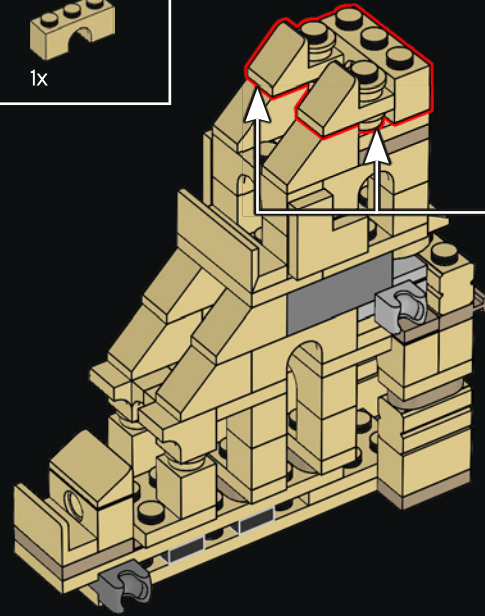

318

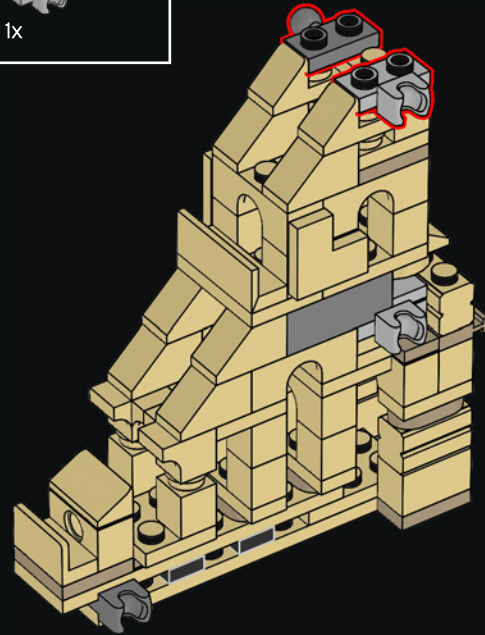



319

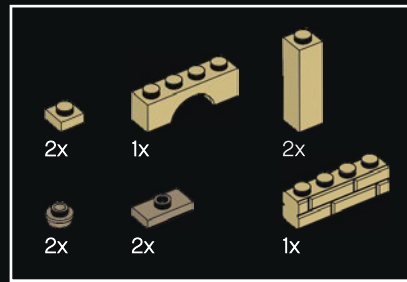
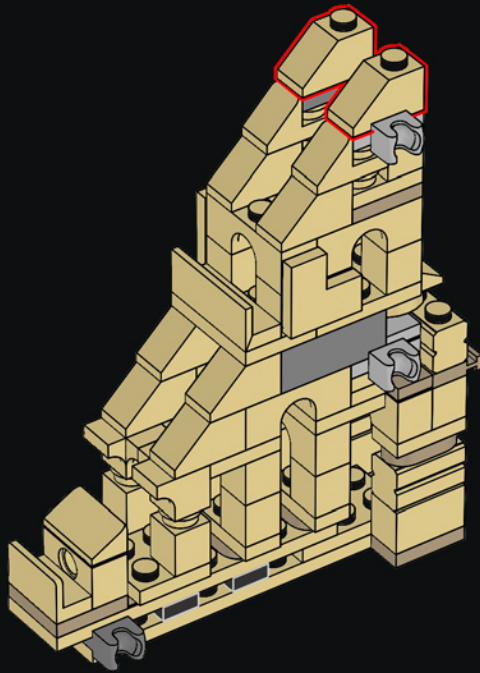

320

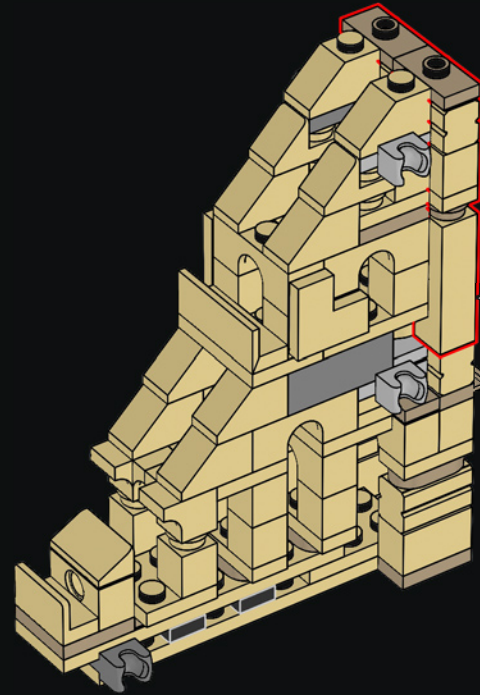

- 1
- 2
- 3
- 4
- 5



321

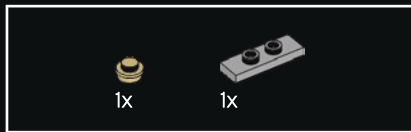
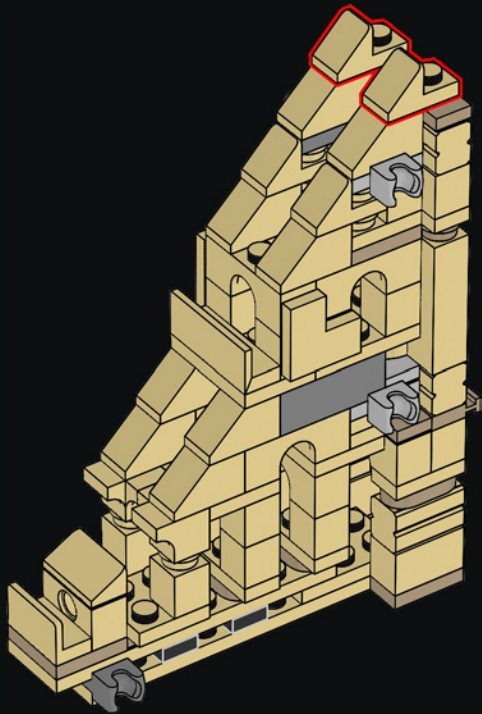

322

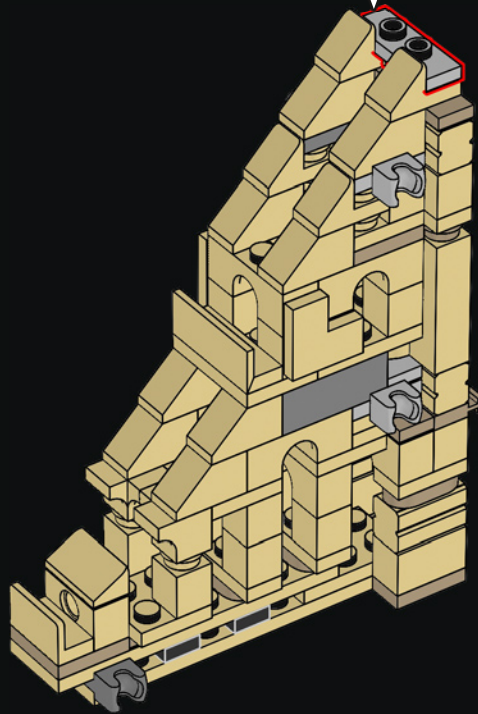
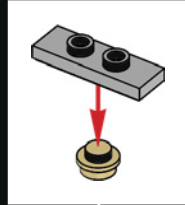

323

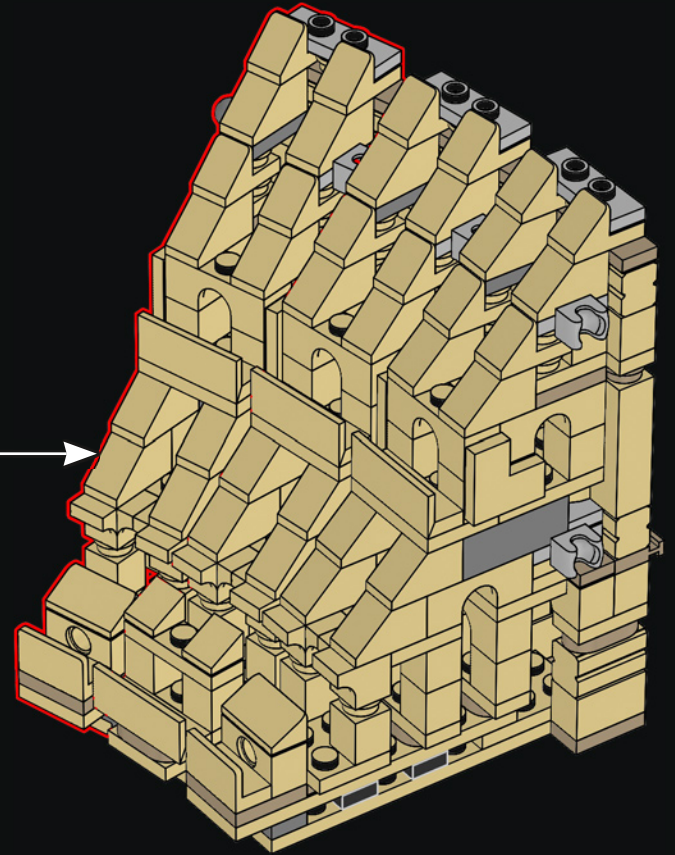

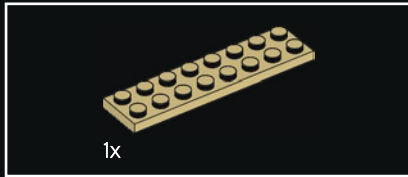
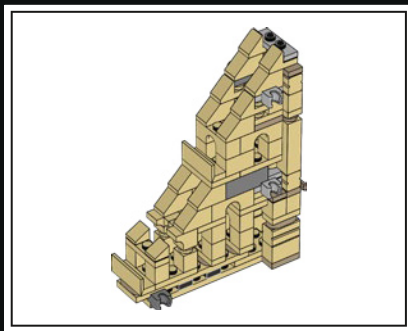

324

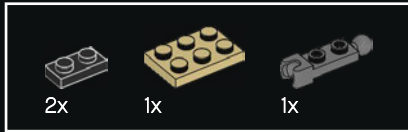
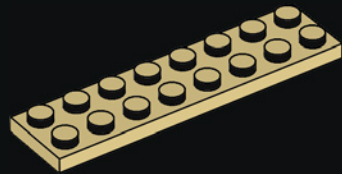

325

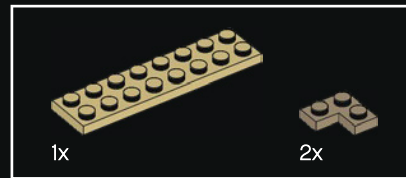
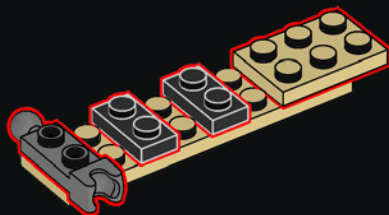

326

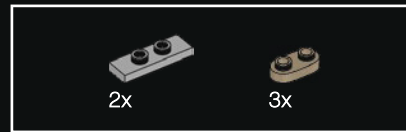
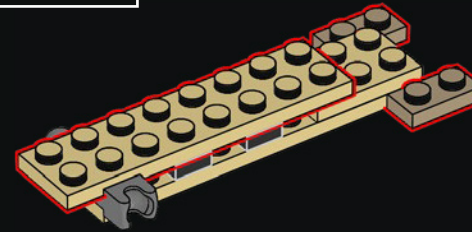

327

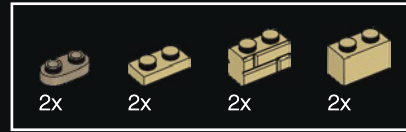
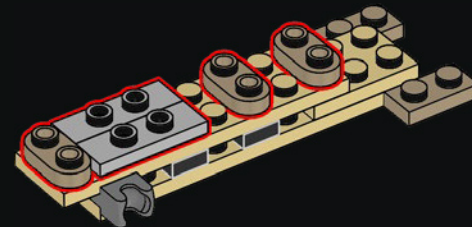

328

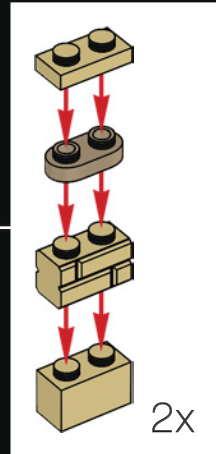
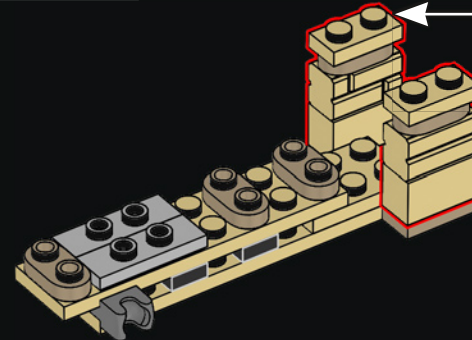

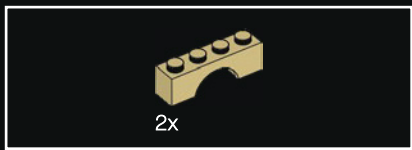

329

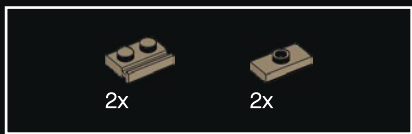
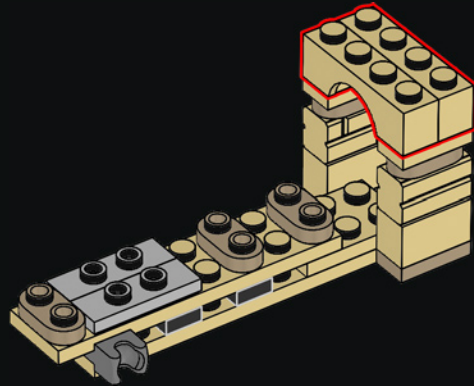

330

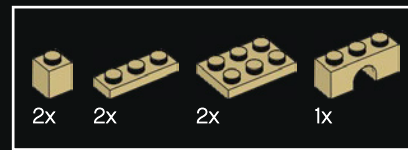
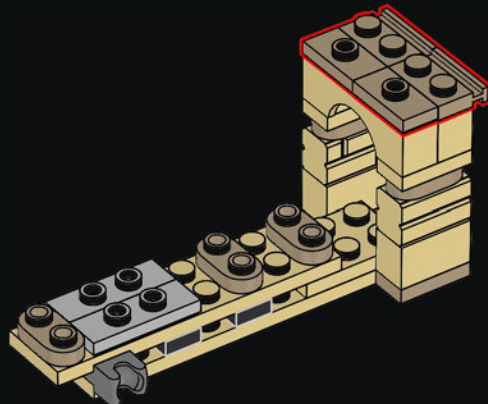

331

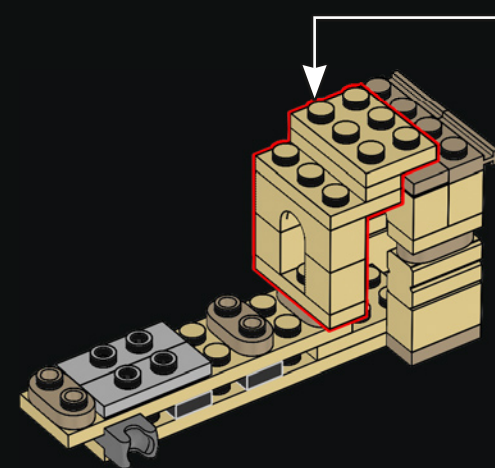
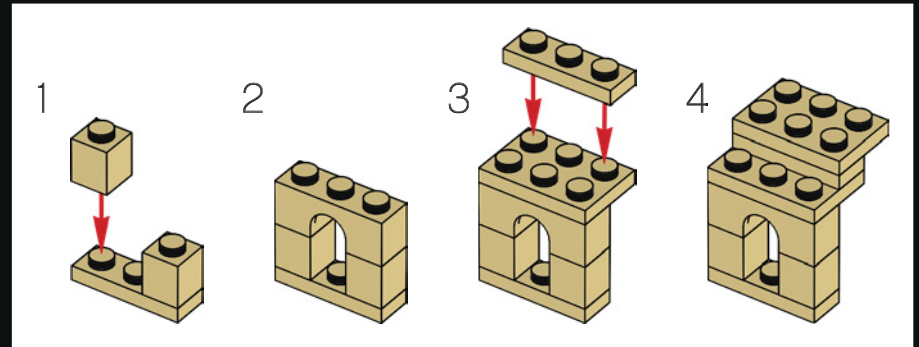

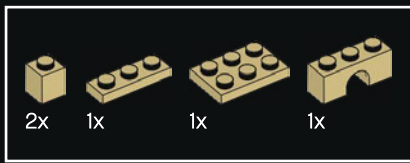

332

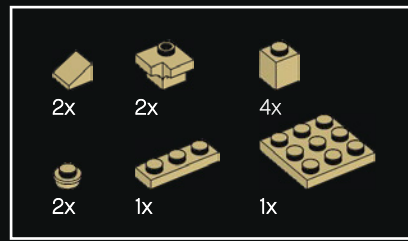
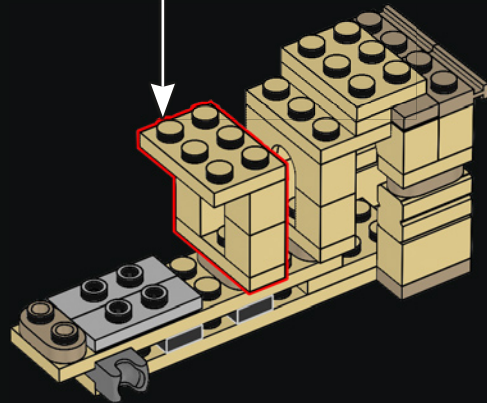
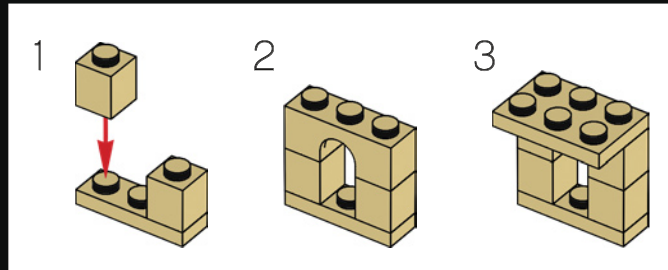

333

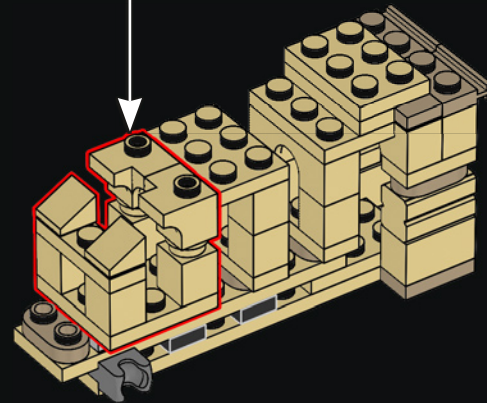
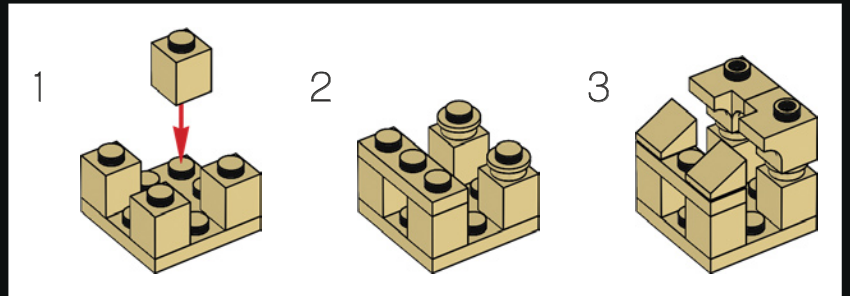

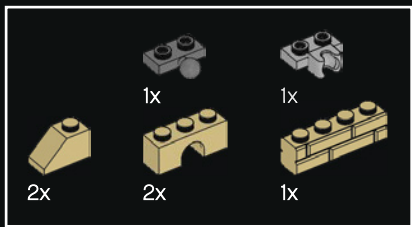

334

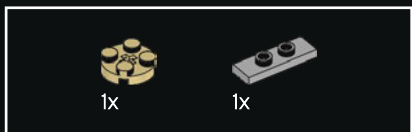
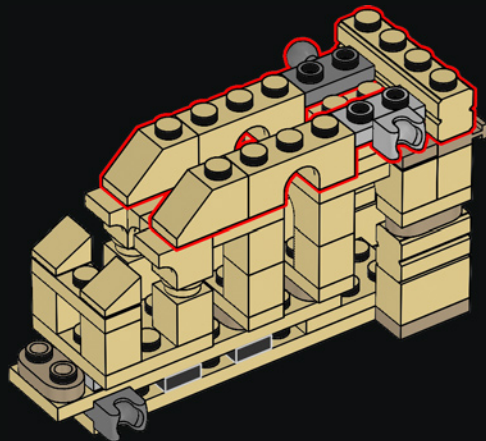

335

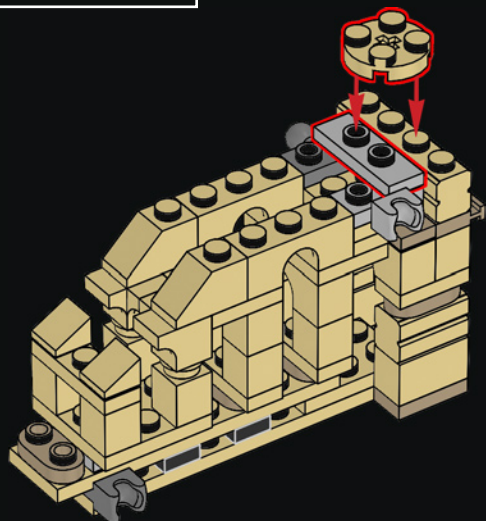

336

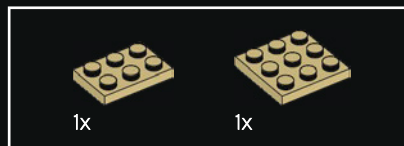
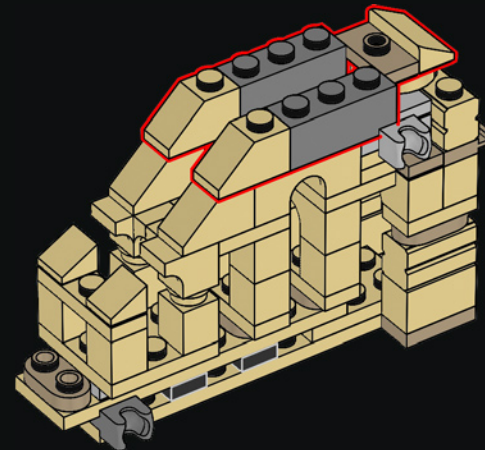

337

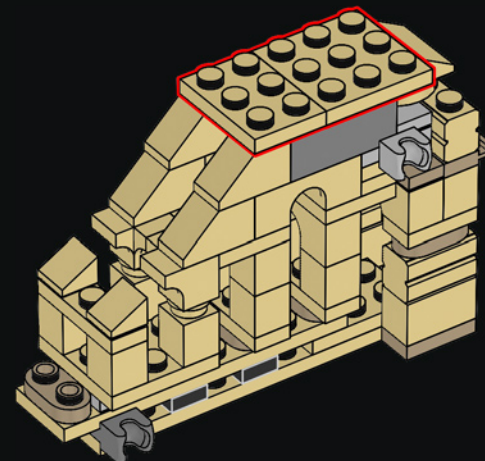

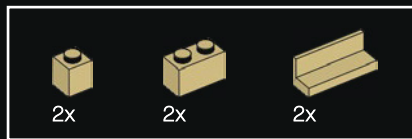

338

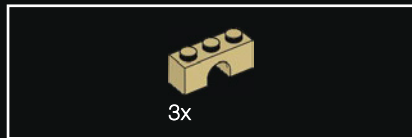
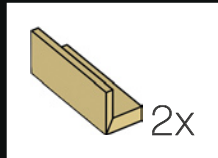
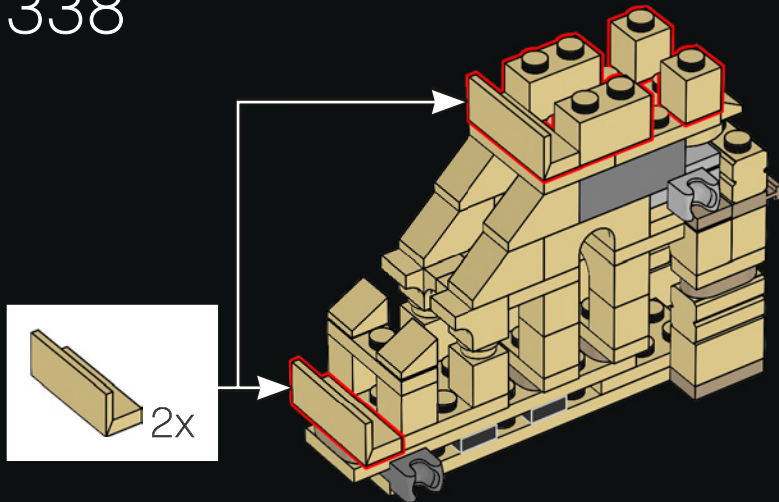

339

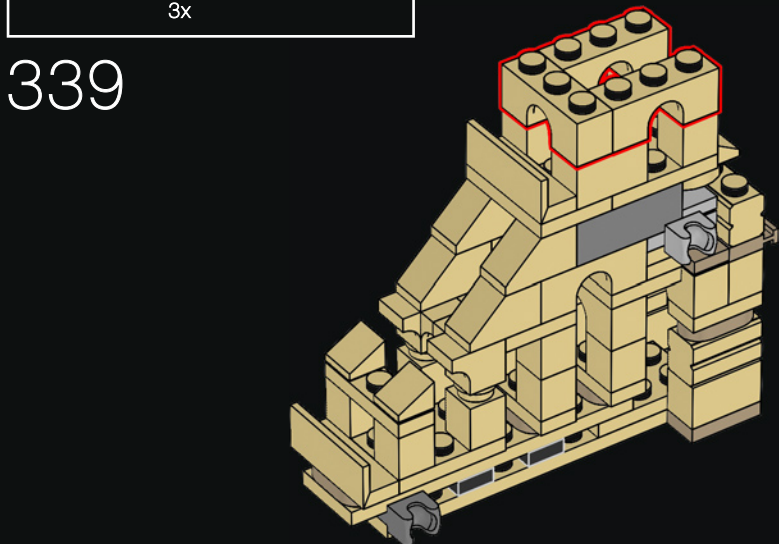

340

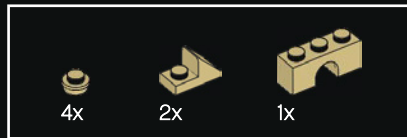
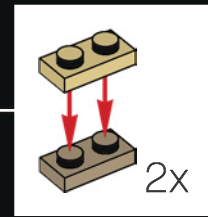
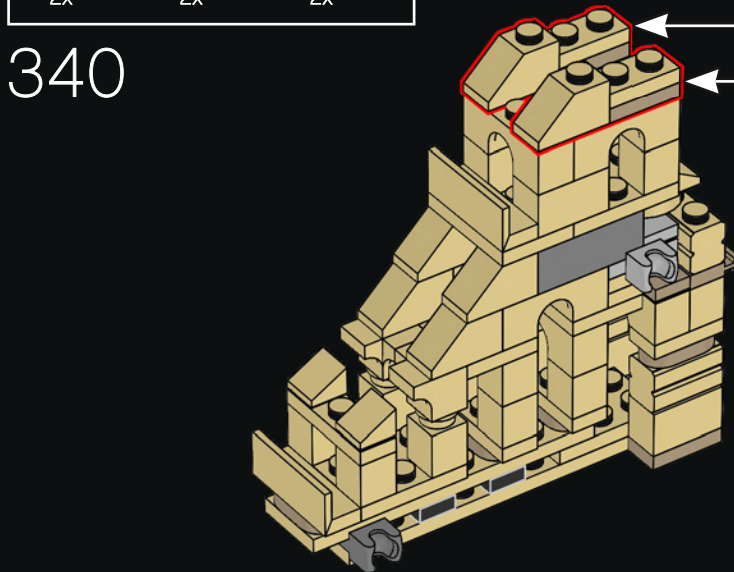

341

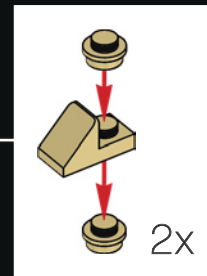
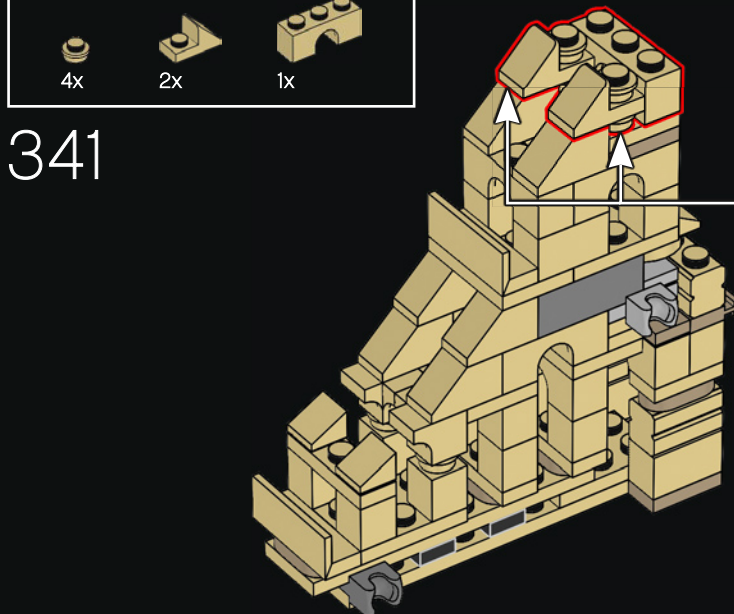



342

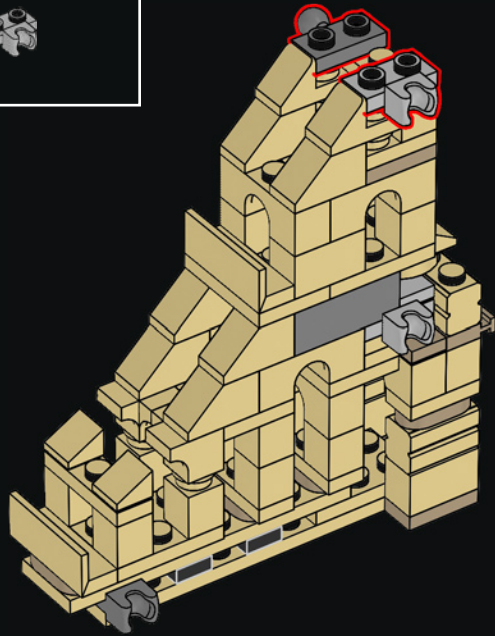

343

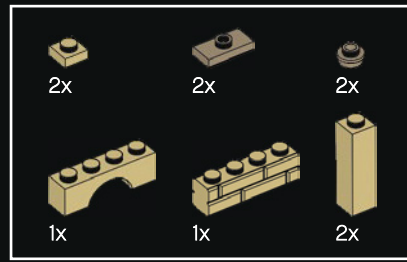
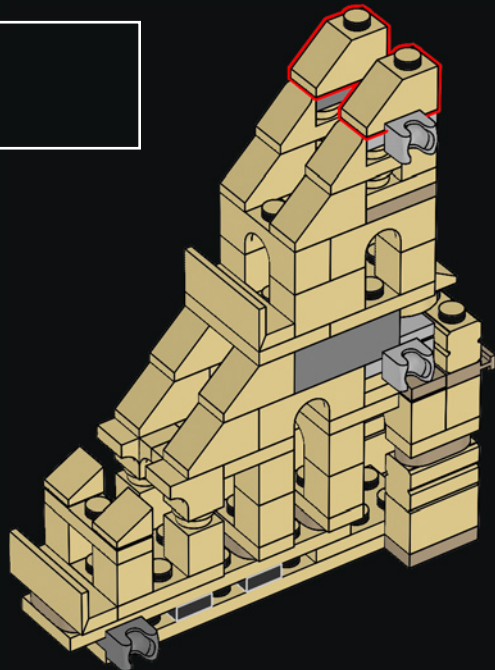

344

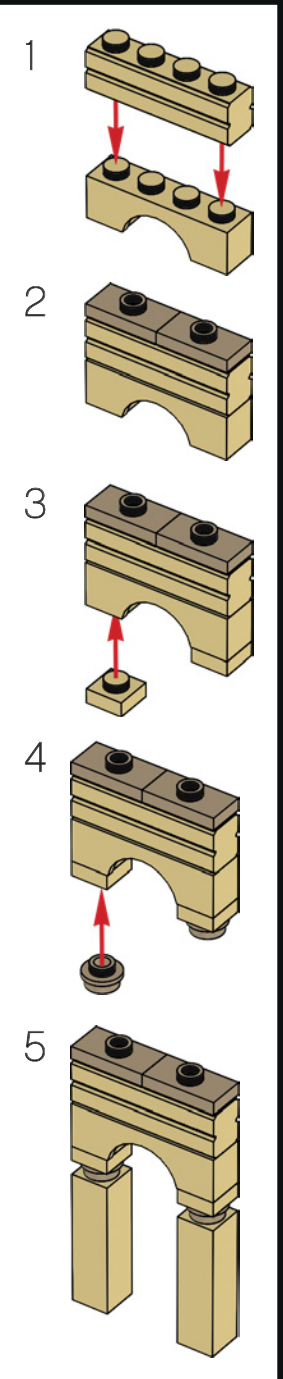
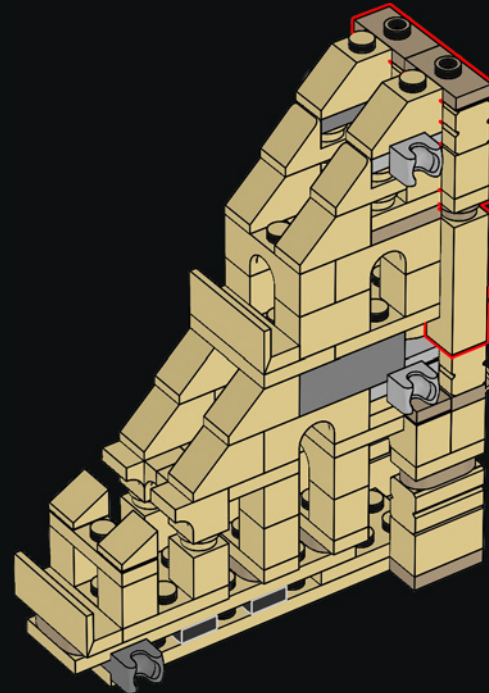



345

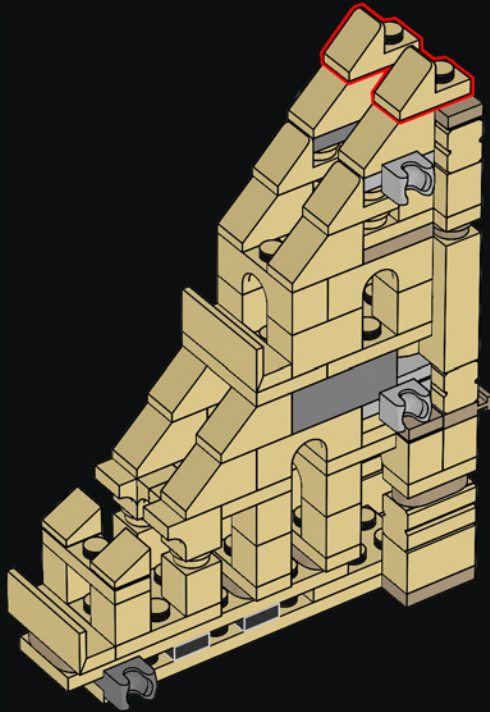

346

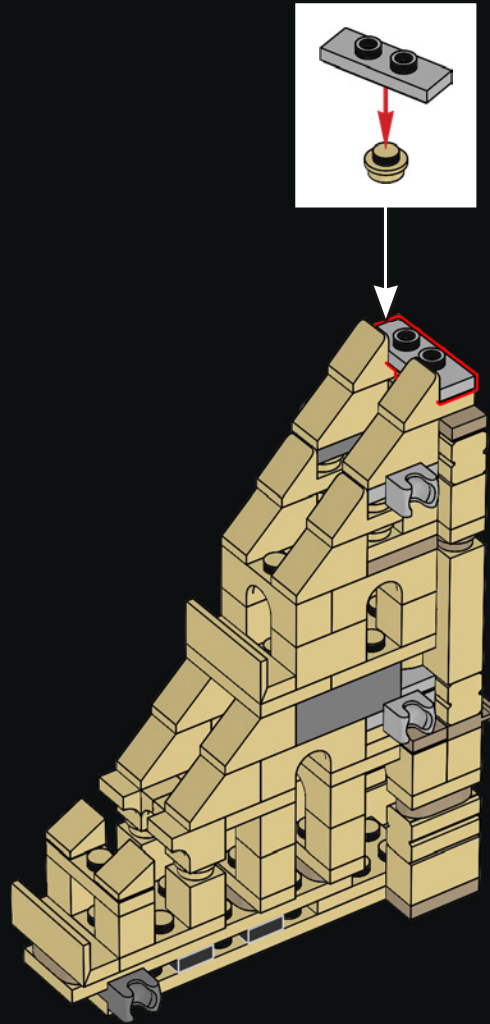

347

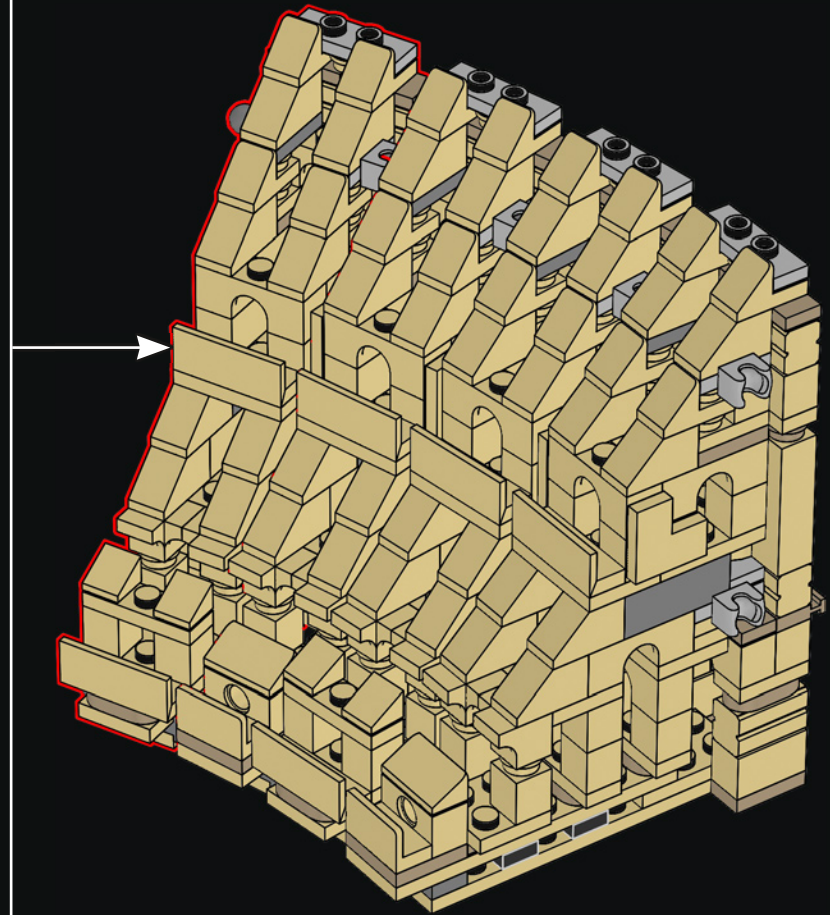

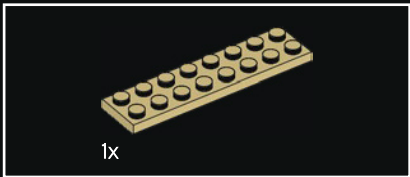
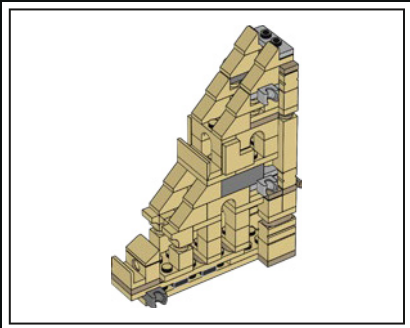
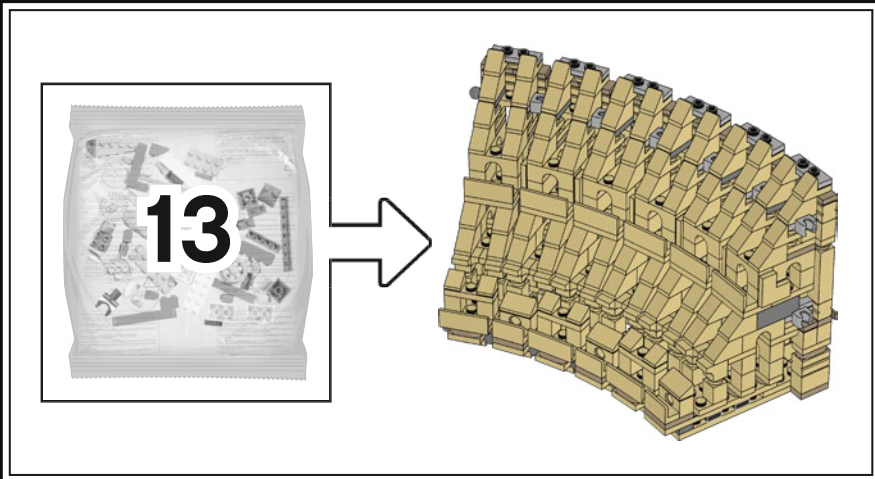

348

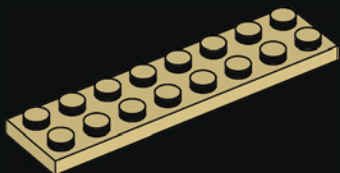

349

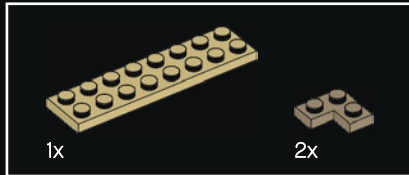
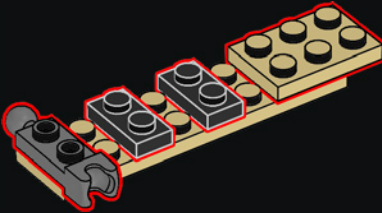

350

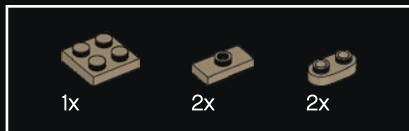
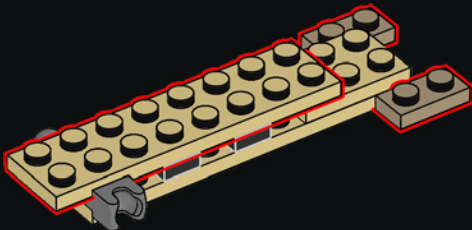

351

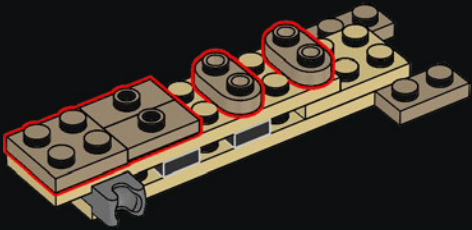



352

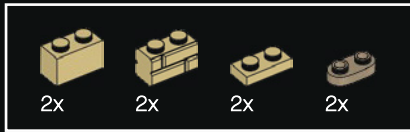
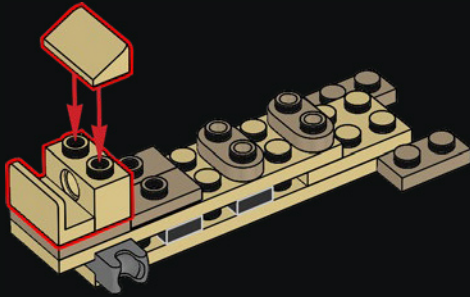

353

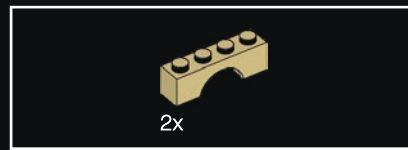
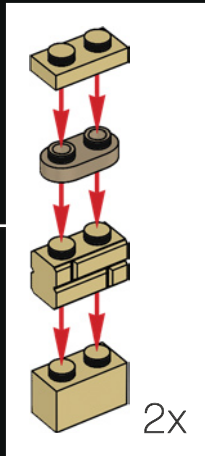
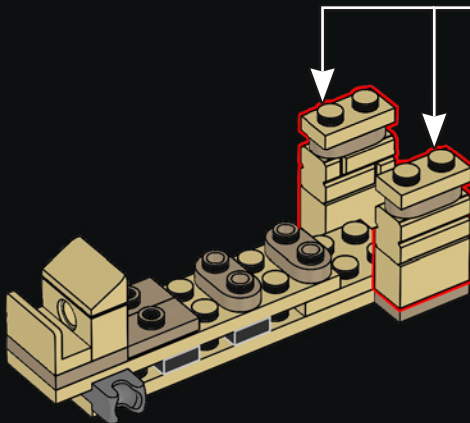

354

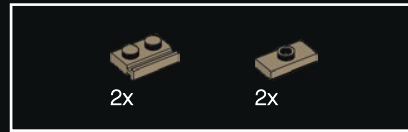
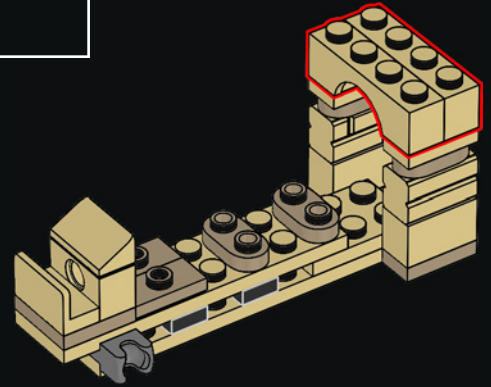

355

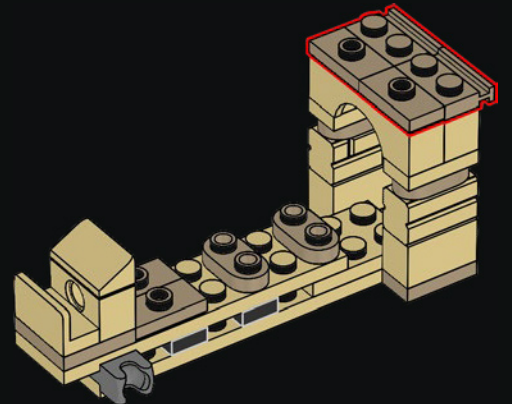

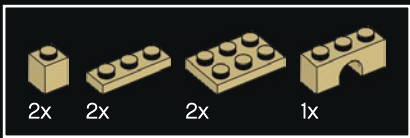

356

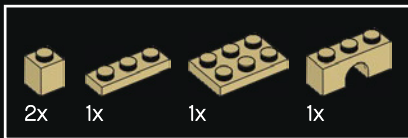
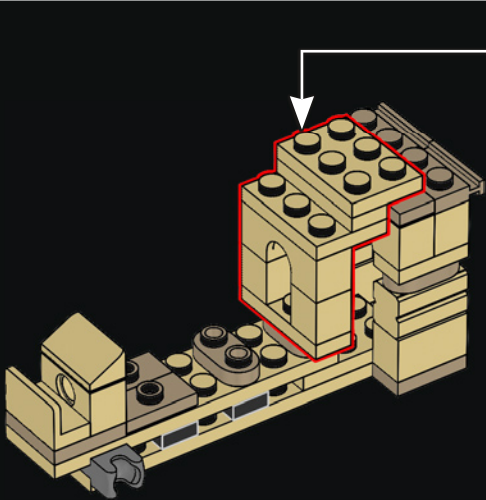
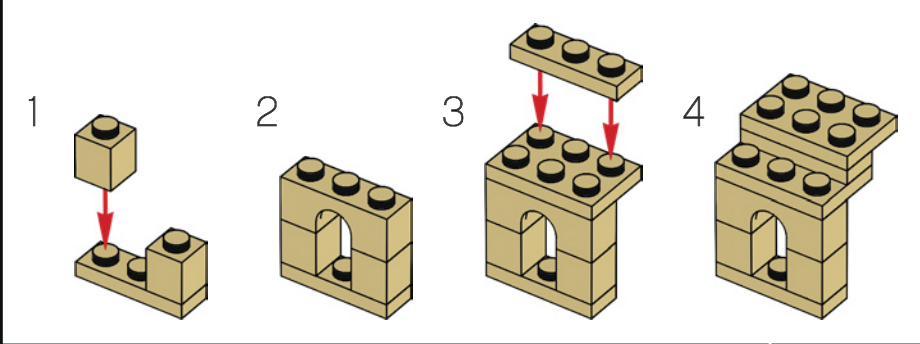

357

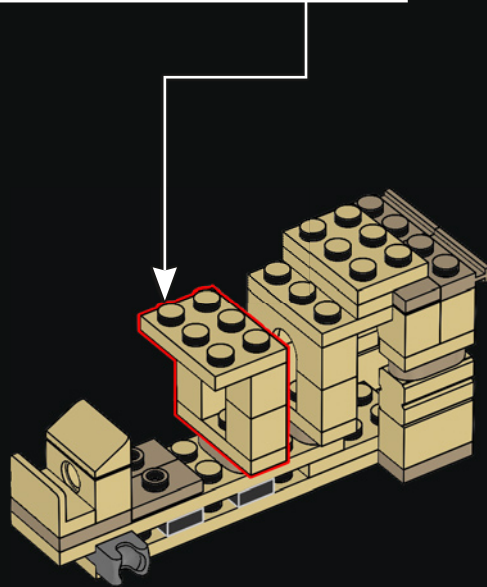
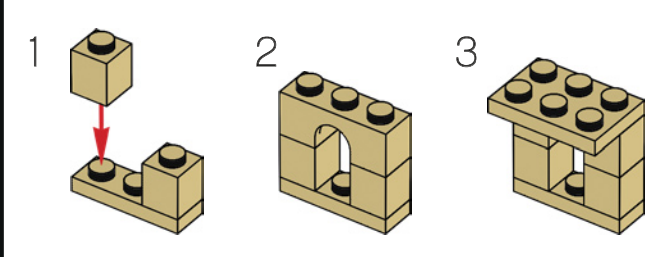

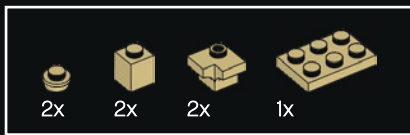

358

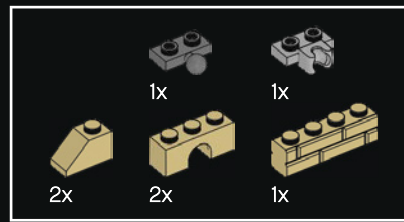
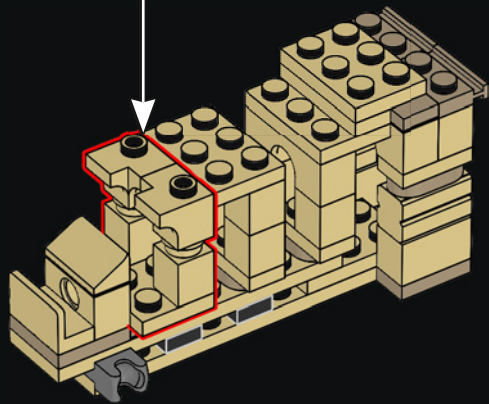
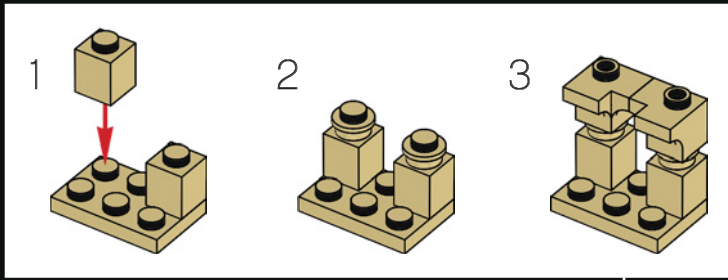

359

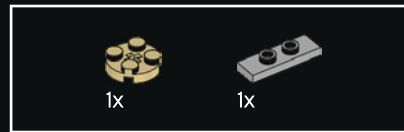
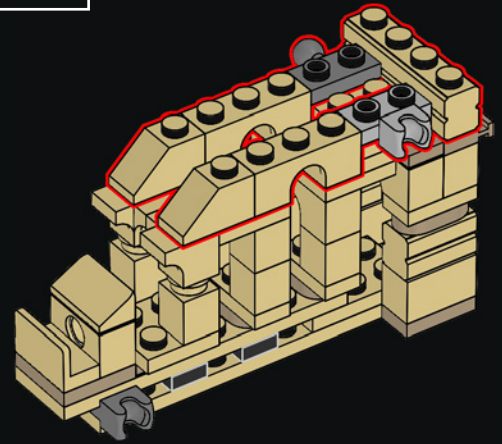

360

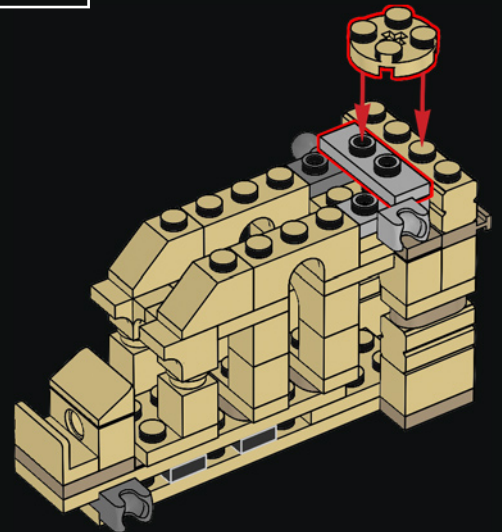



361

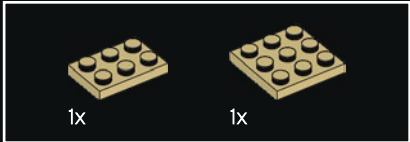
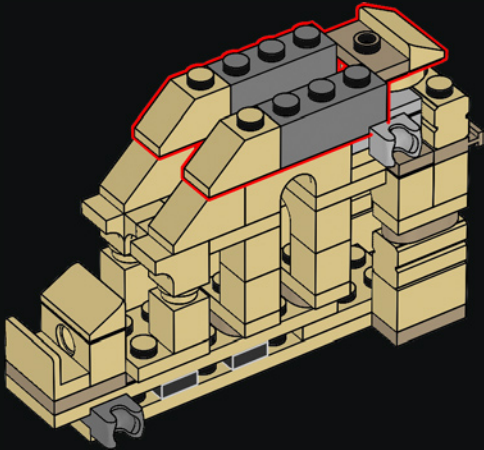

362

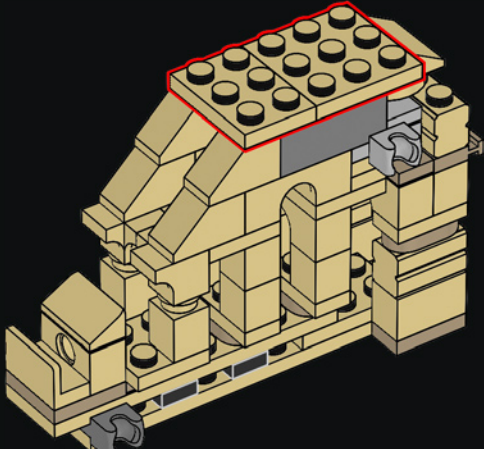

363

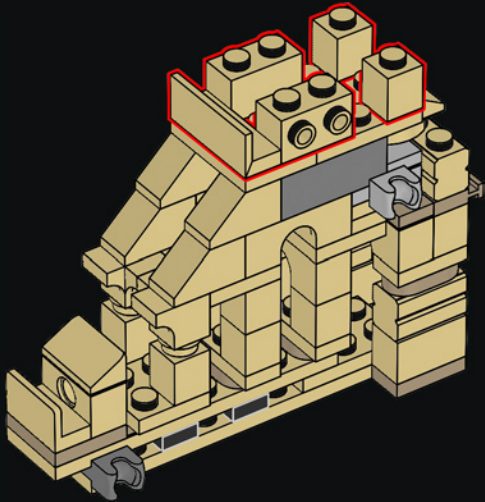

364

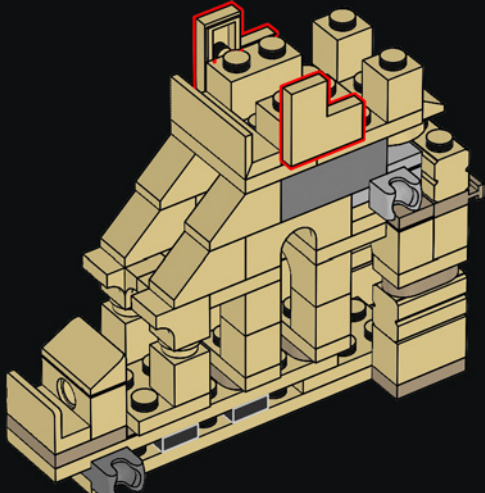

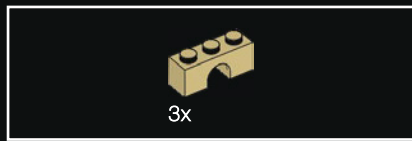

365

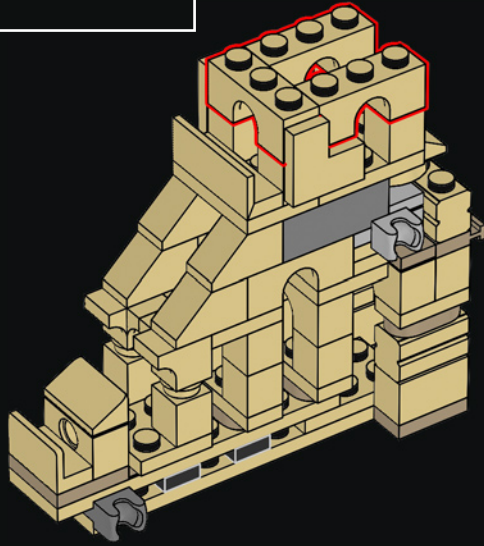

366

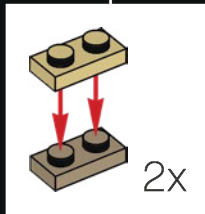
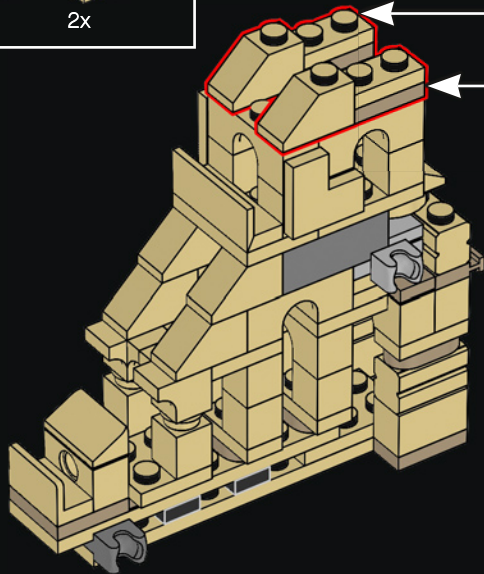

367

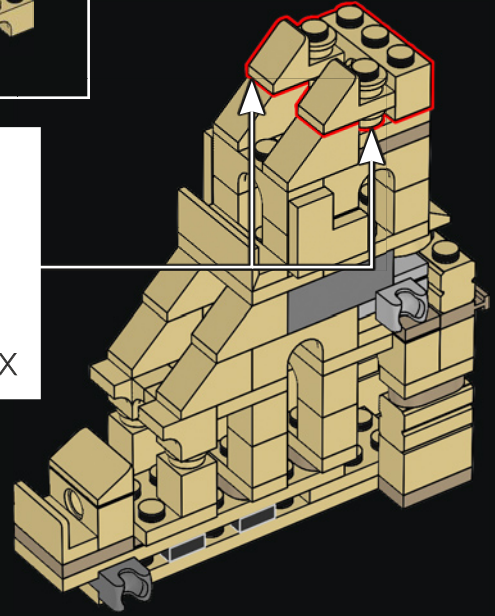
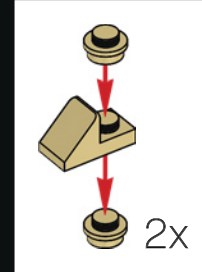

368

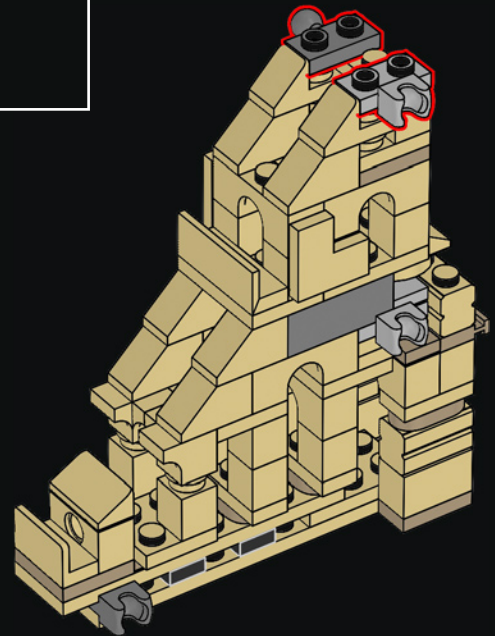



2x

369

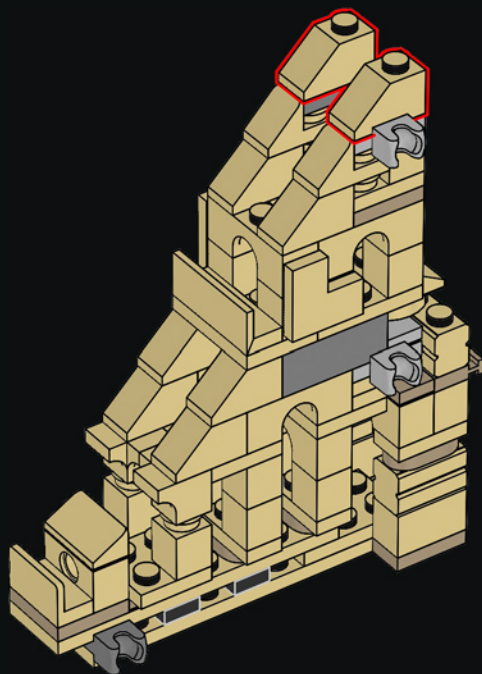

2x



2x



2x



1x



1x



2x

370

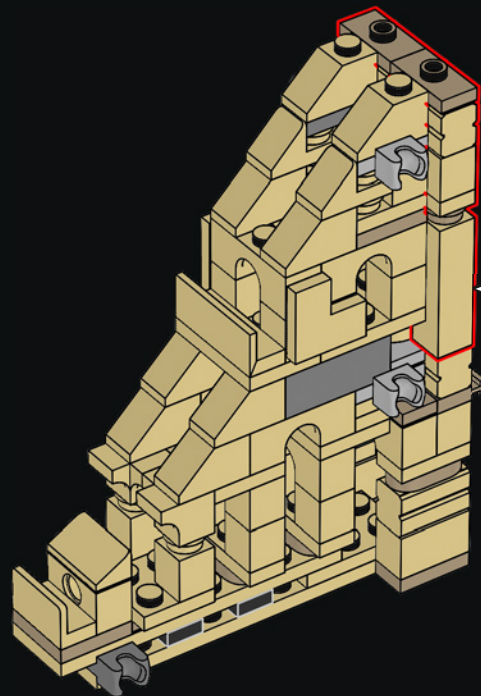

1

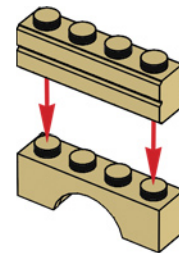

2

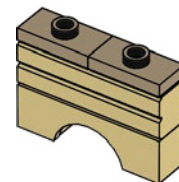

3

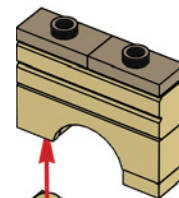

4

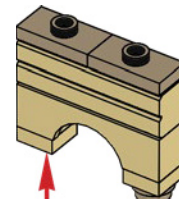

5

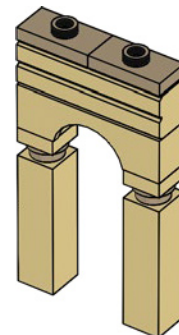



371

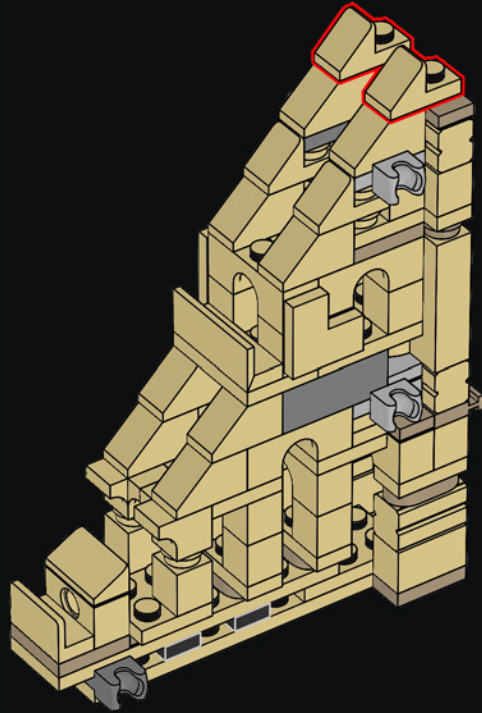

372

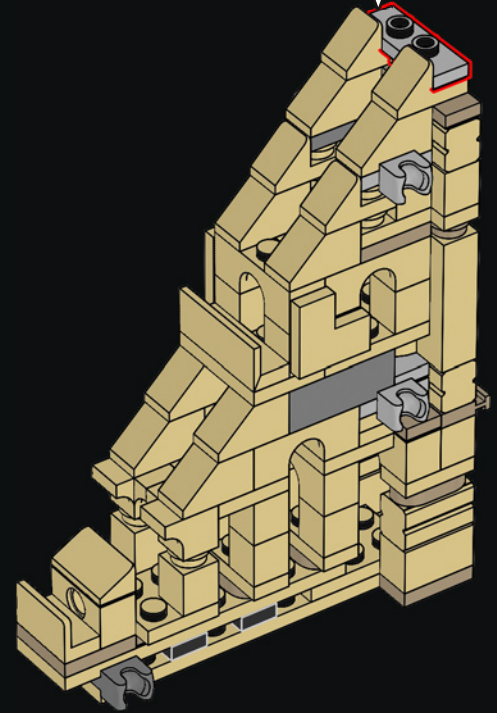
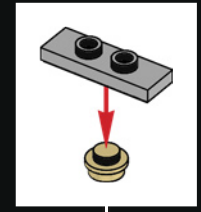

373

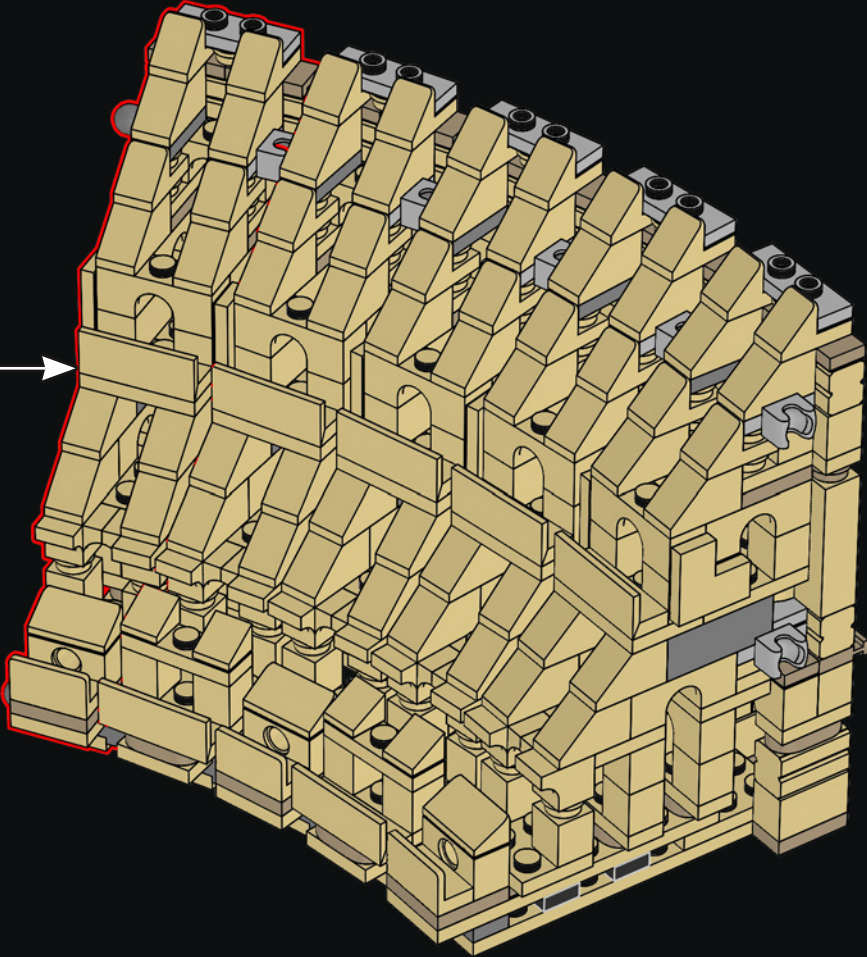

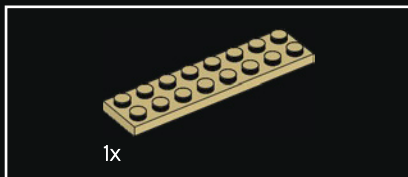
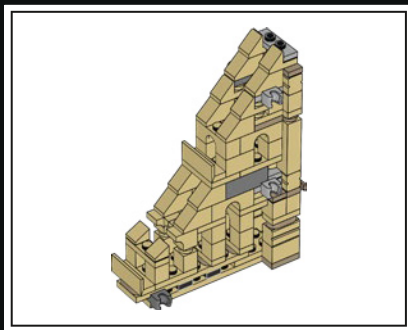

374

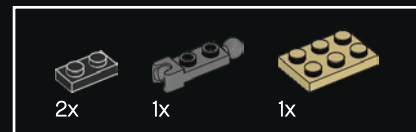
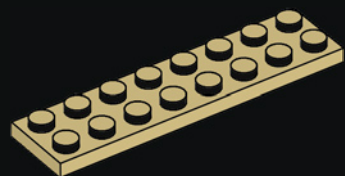

375

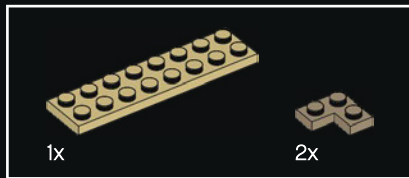
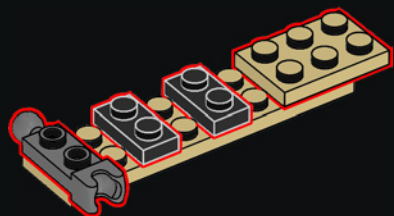

376

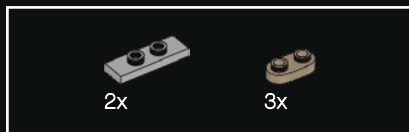
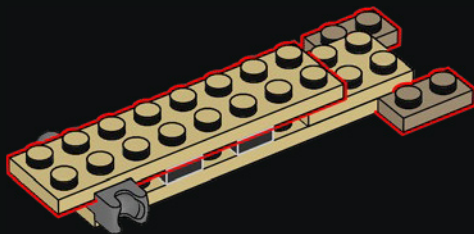

377

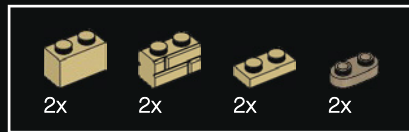
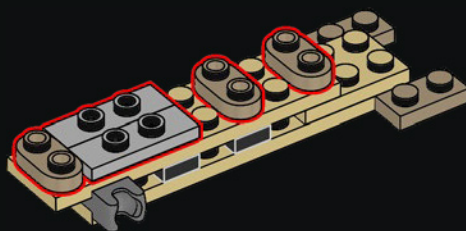

378

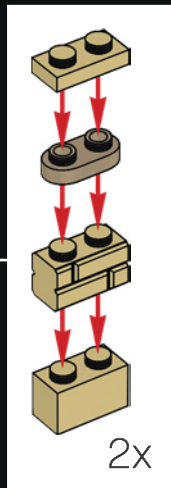
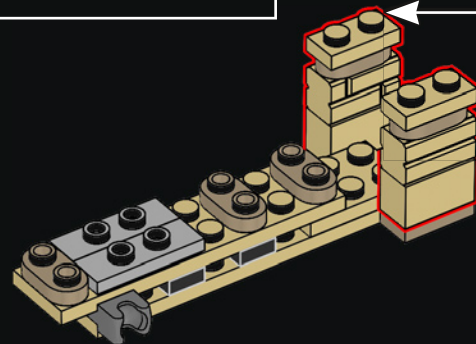

379

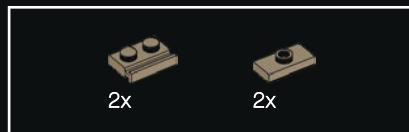
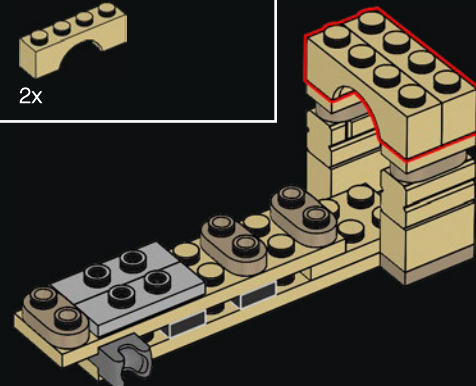

380

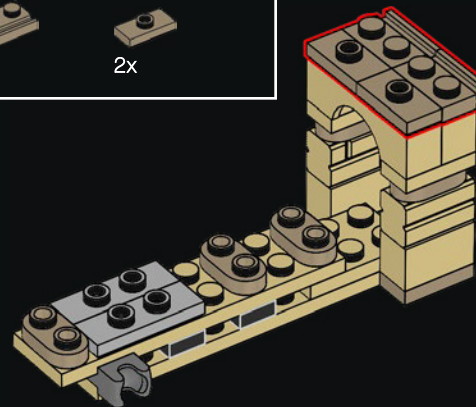

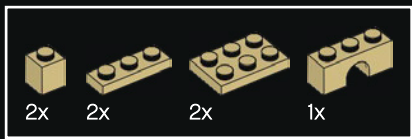

381

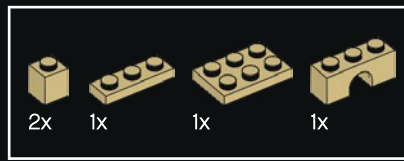
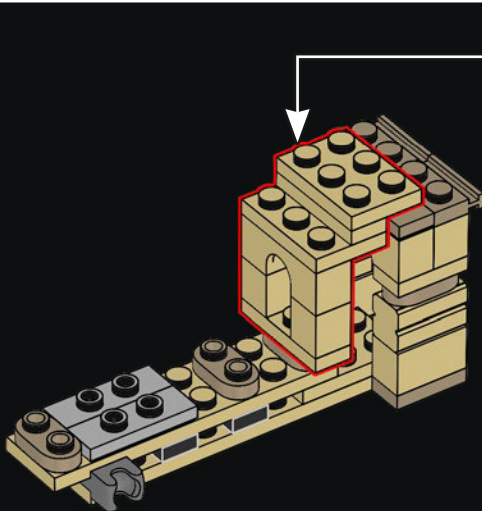
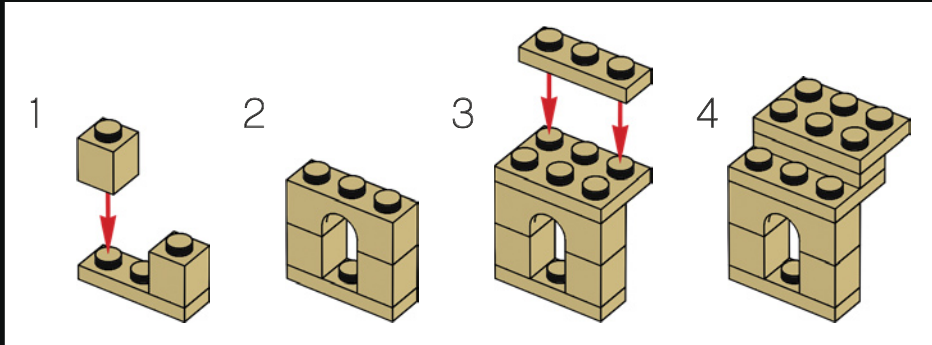

382

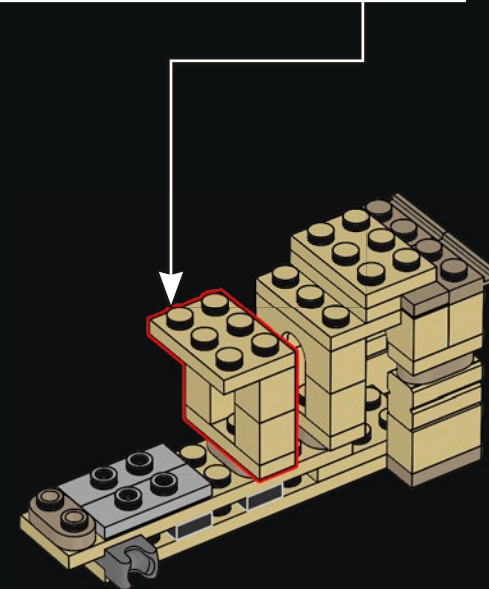
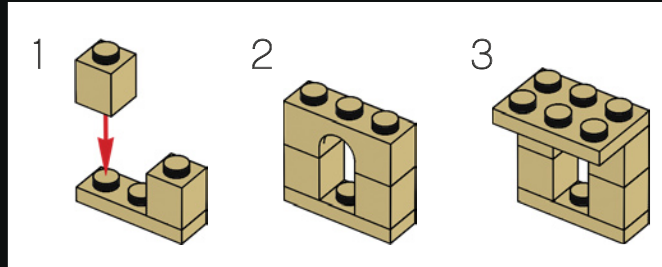

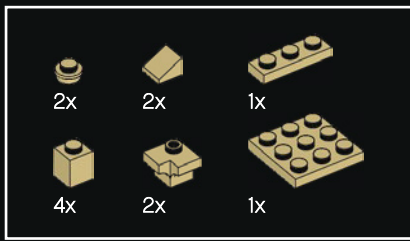

383

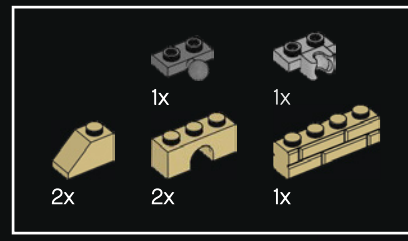
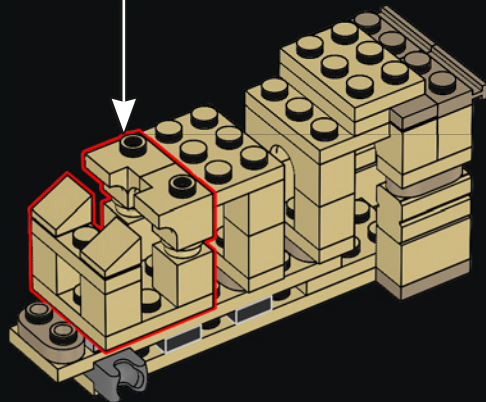
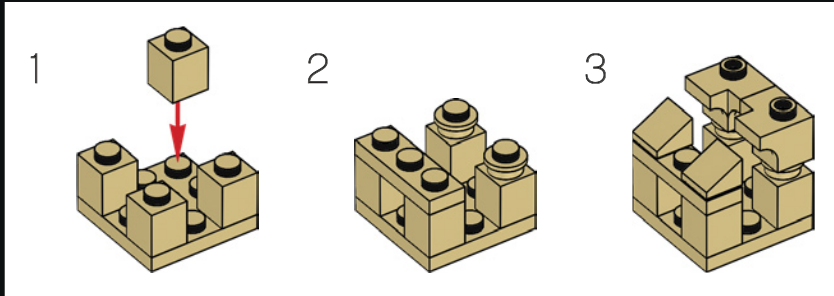

384

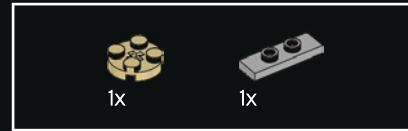
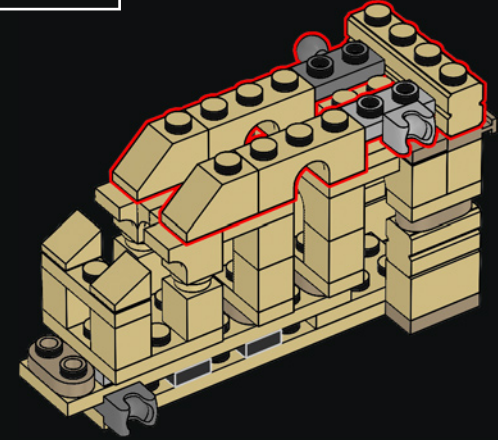

385

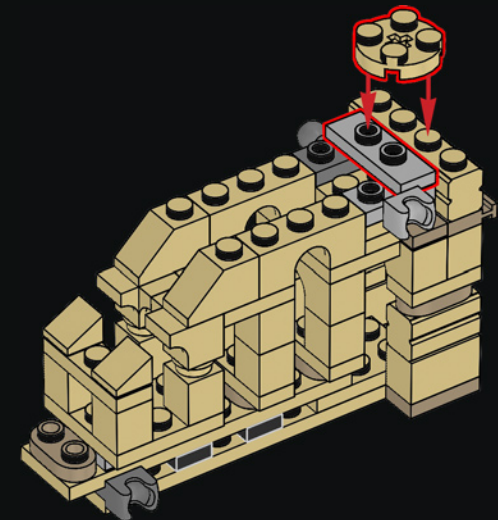



386

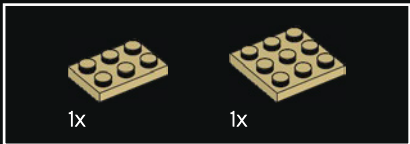
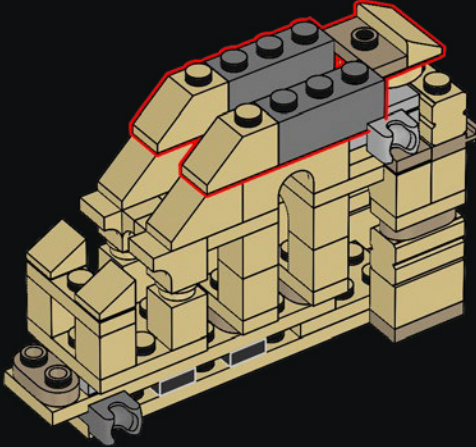

387

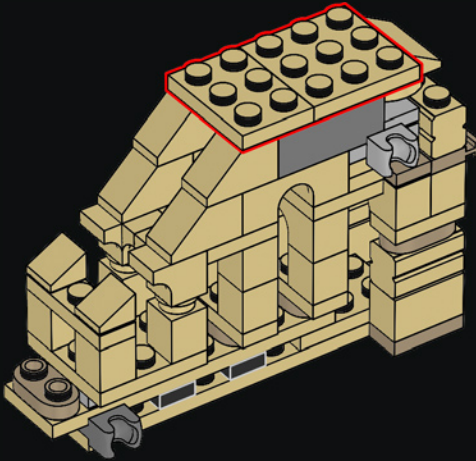

388

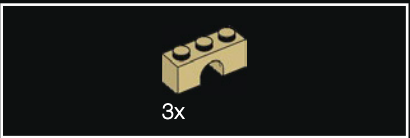
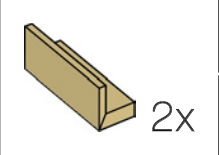
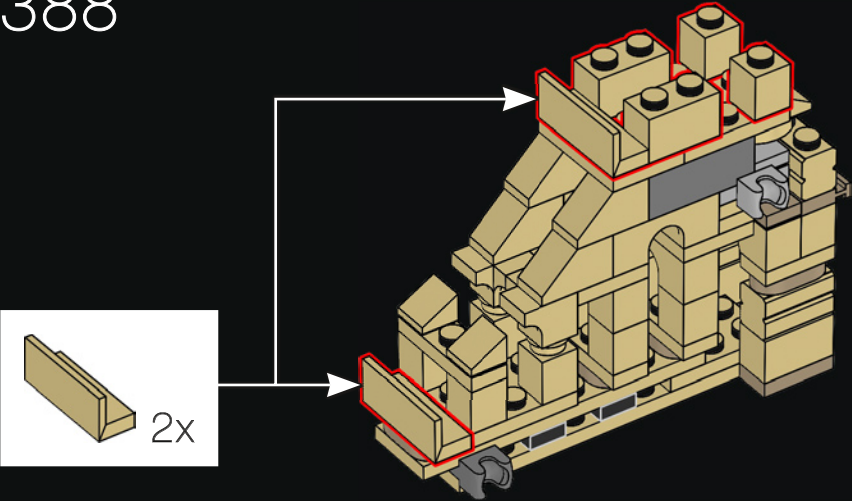

389

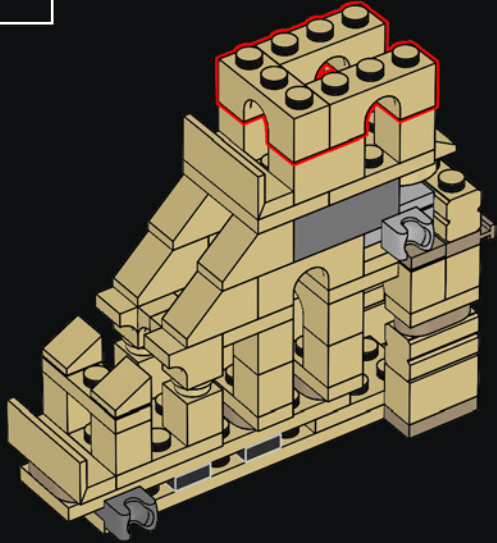



390

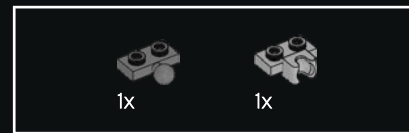
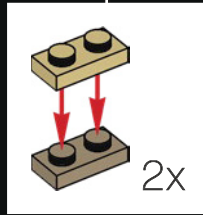
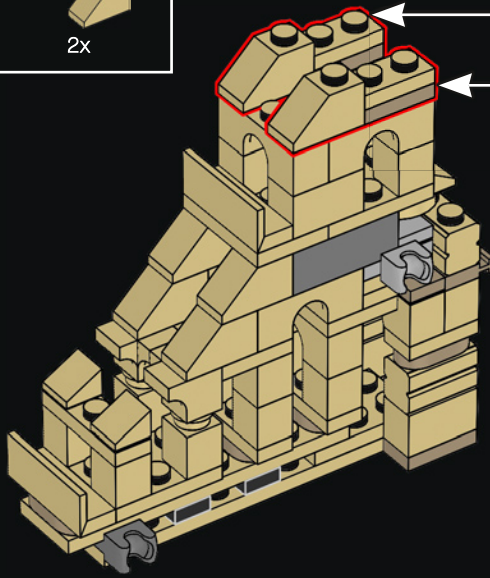

392

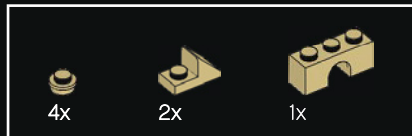
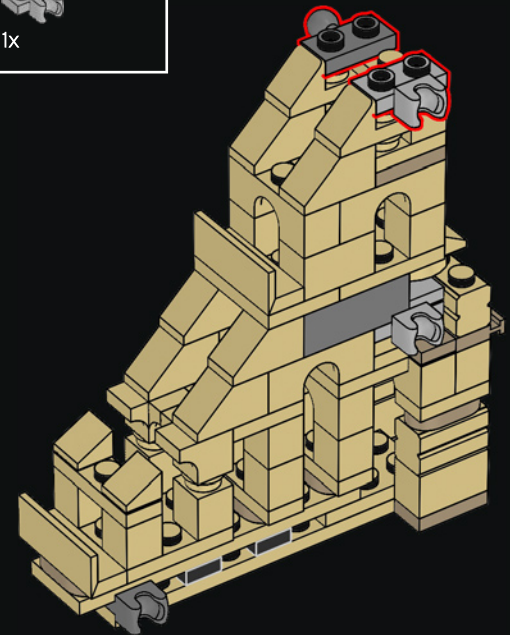

391

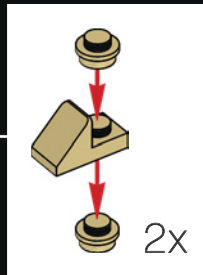
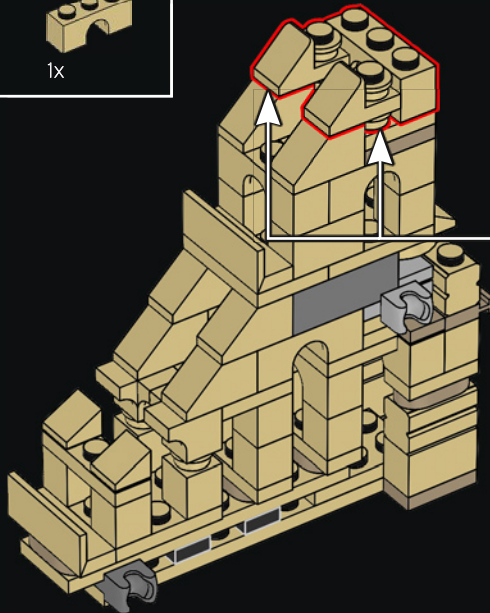

393

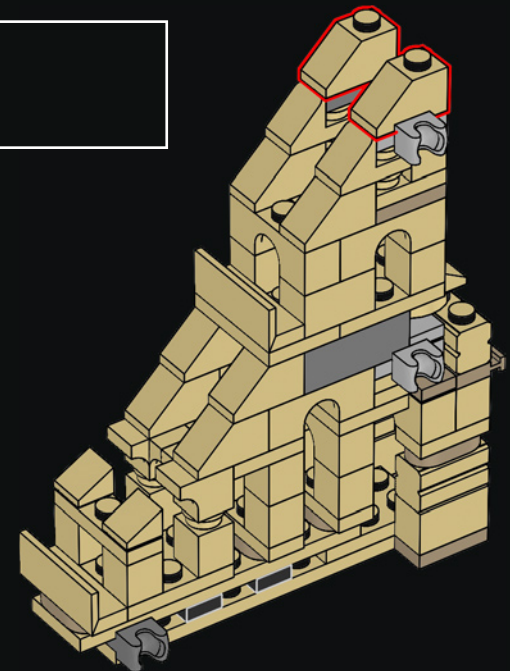

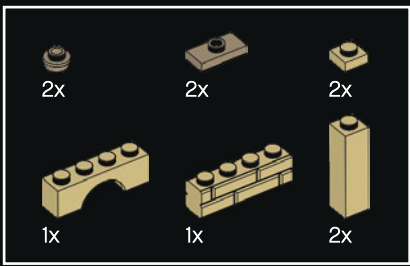

394

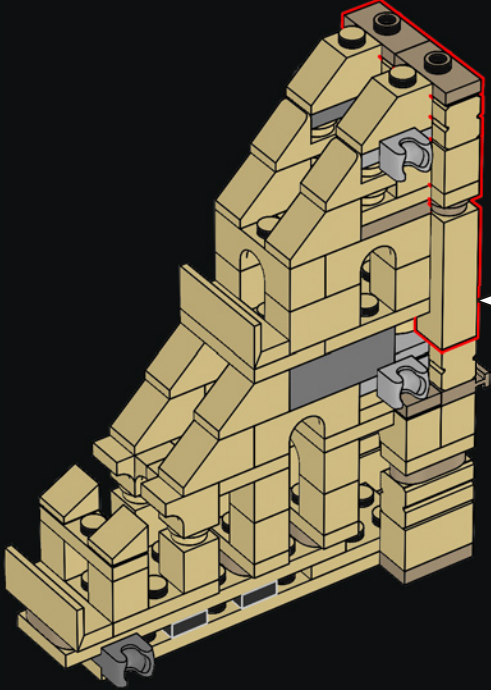

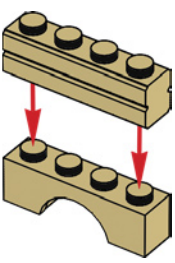
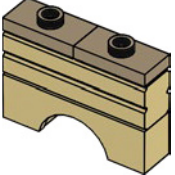
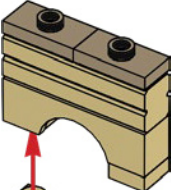
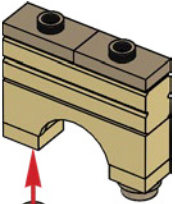
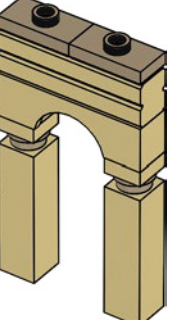
- 1 
- 2 
- 3 
- 4 
- 5 



395

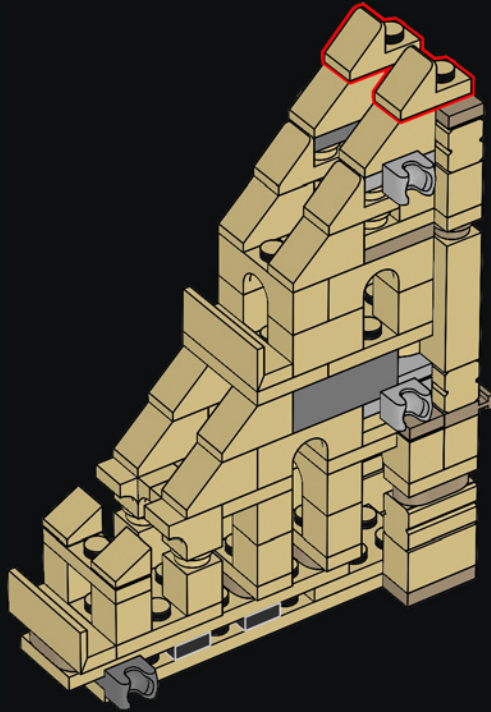



396

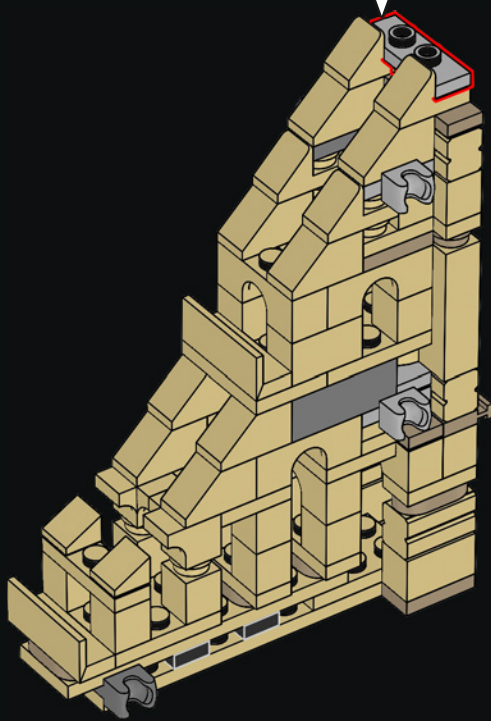
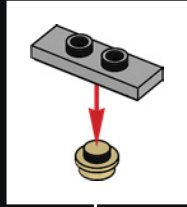

397

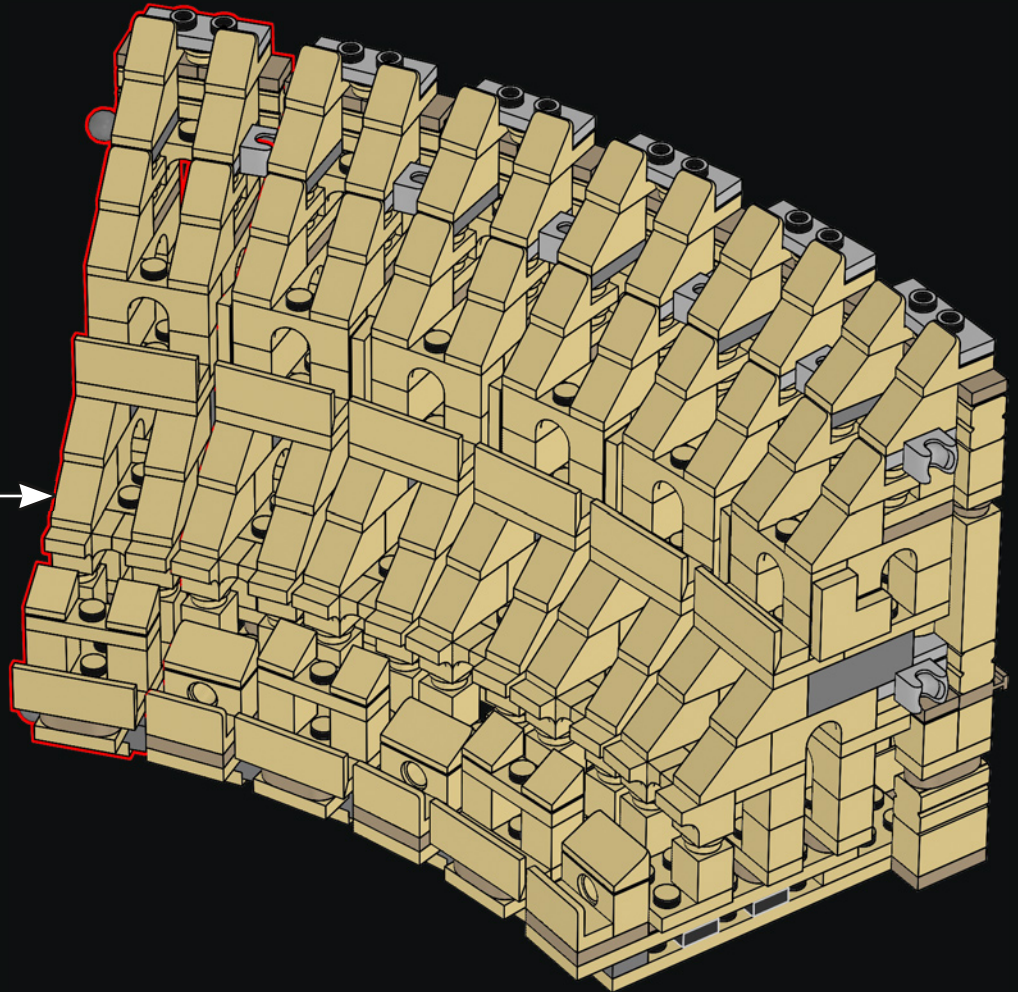

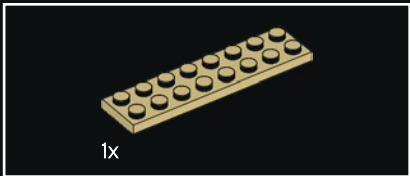
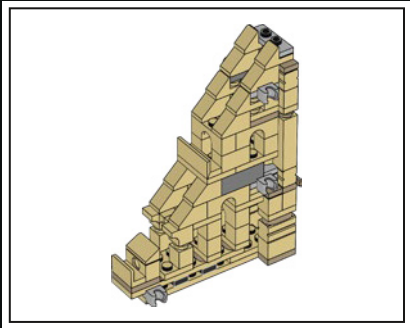
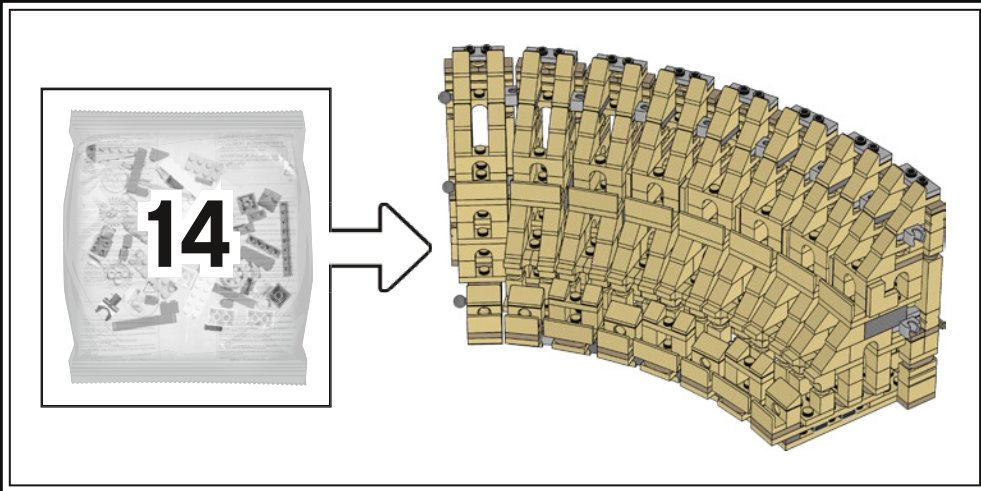

398

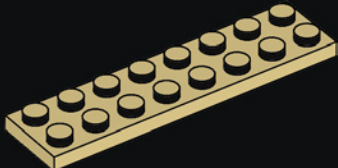

399

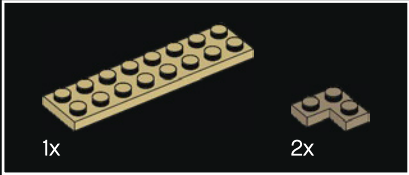
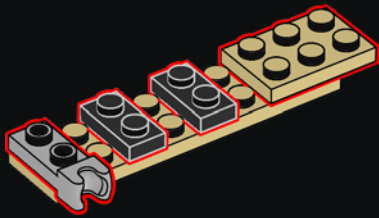

400

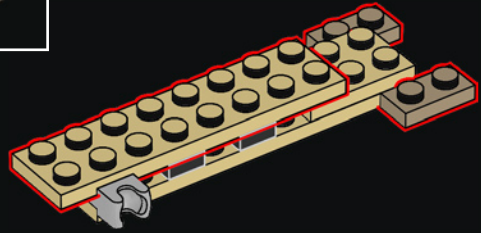

401

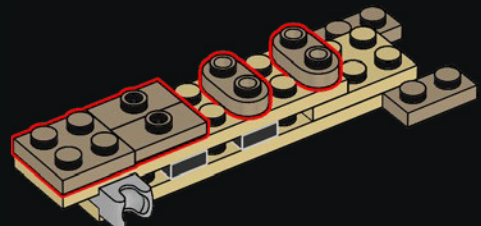



402

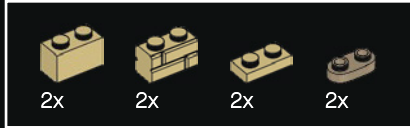
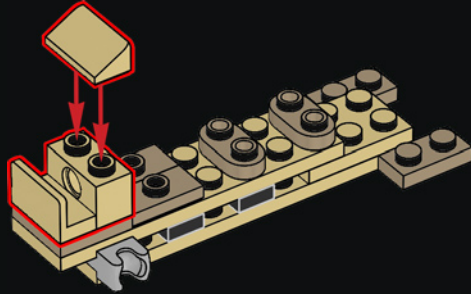

403

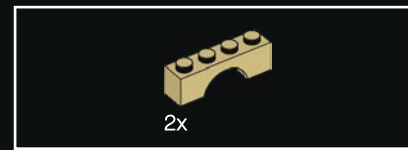
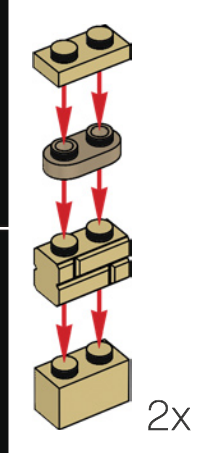
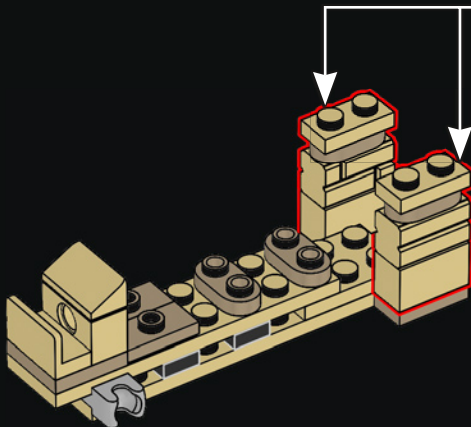

404

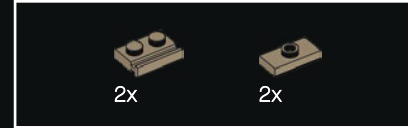
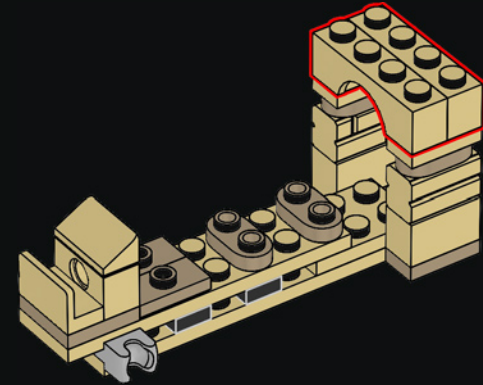

405

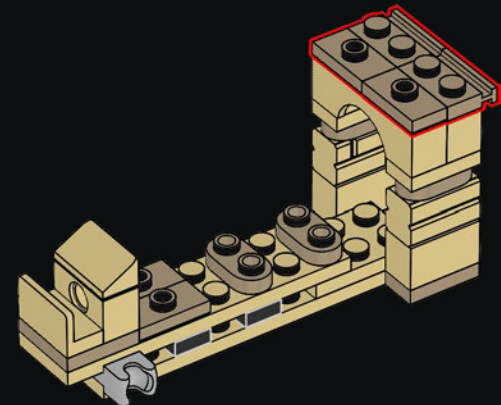

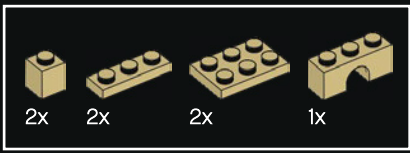

406

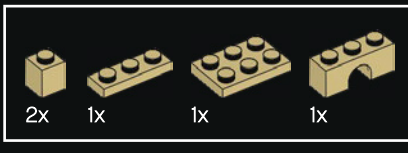
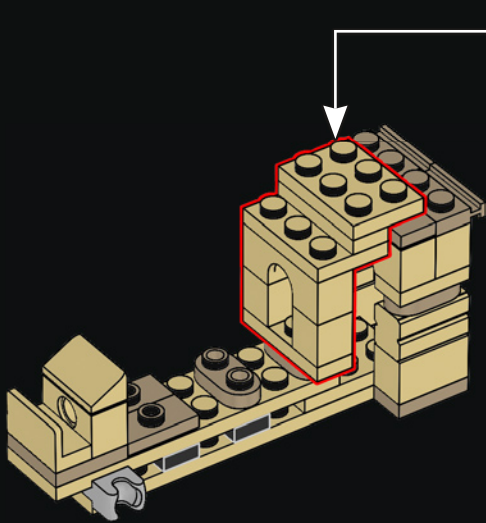
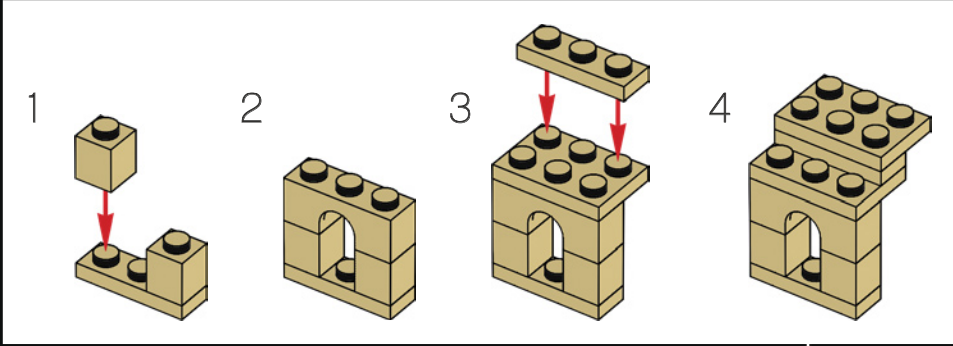

407

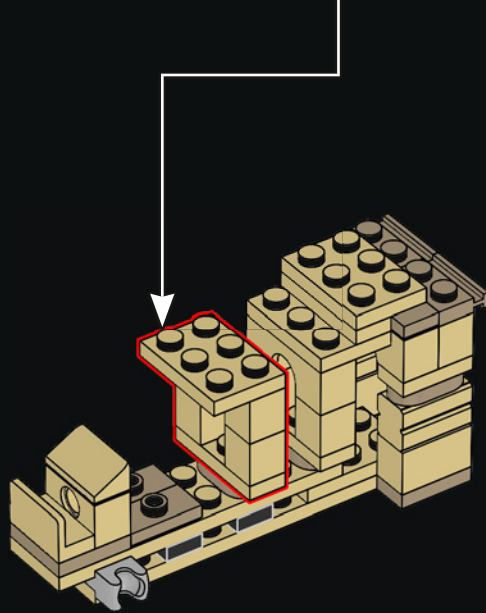
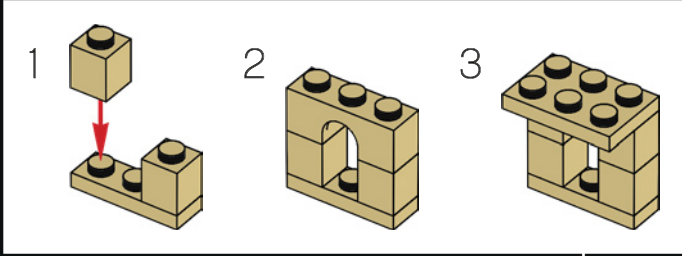

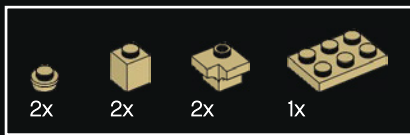

408

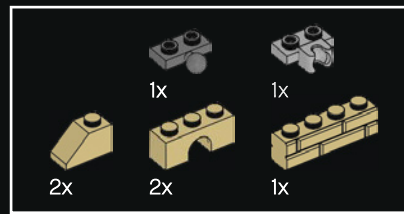
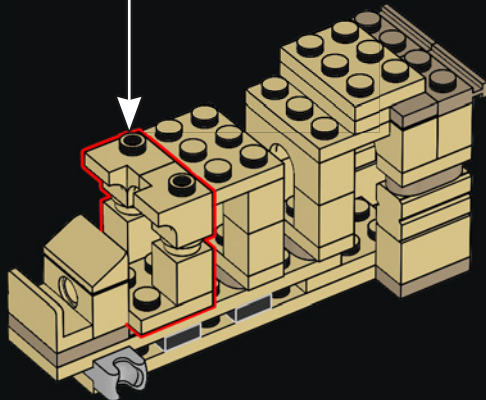
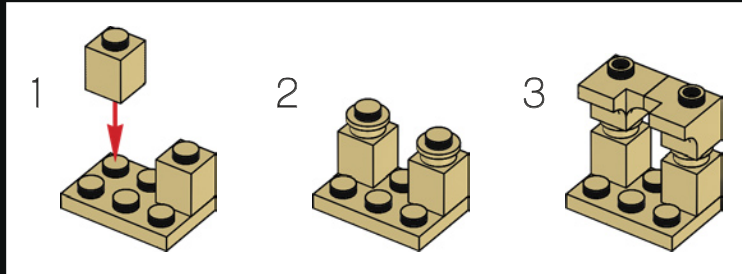

409

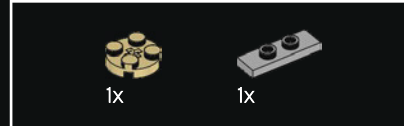
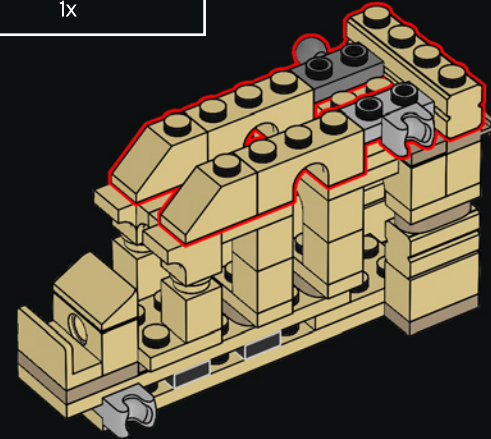

410

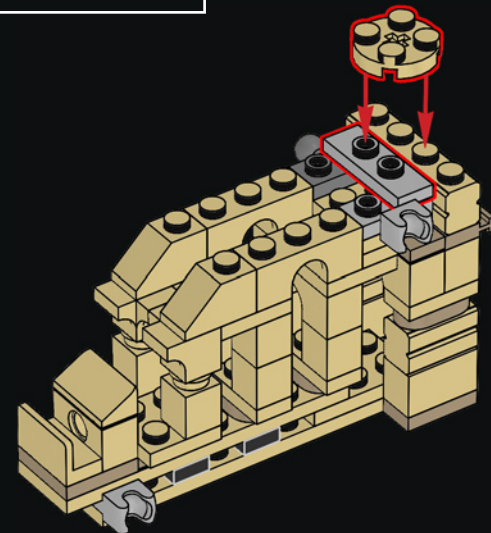



411

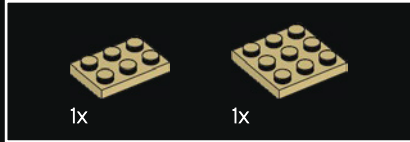
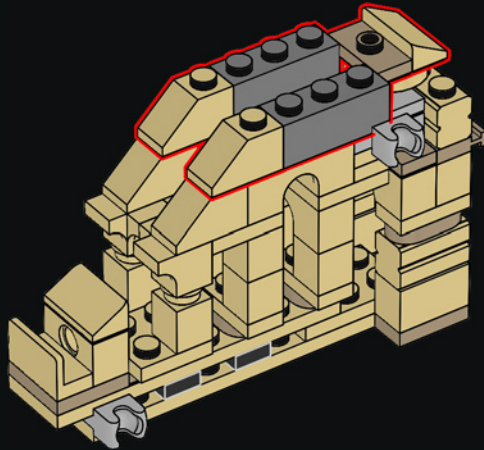

412

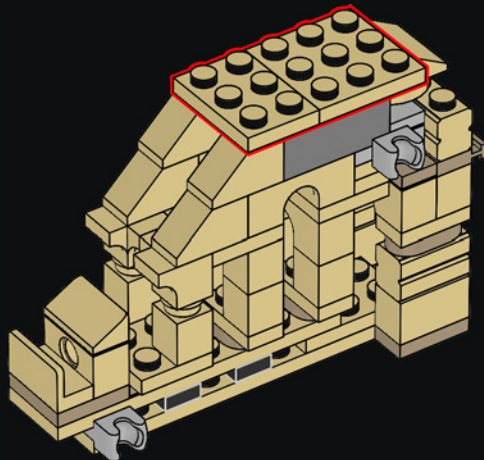

413

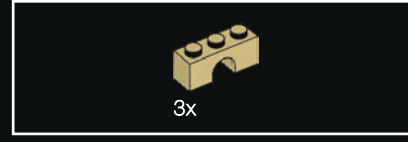
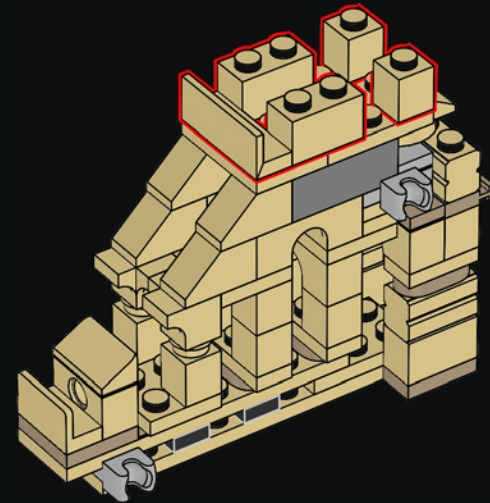

414

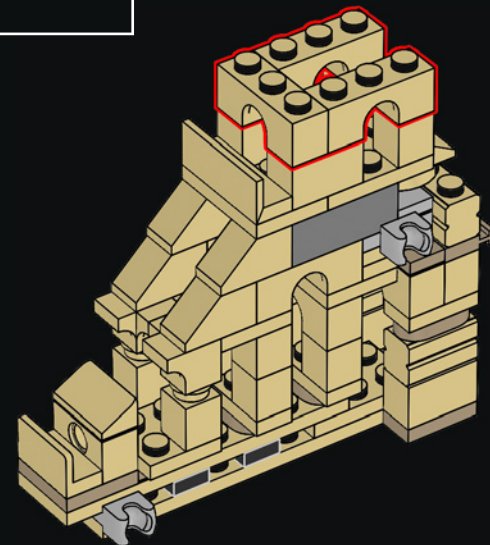



415

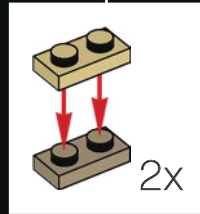
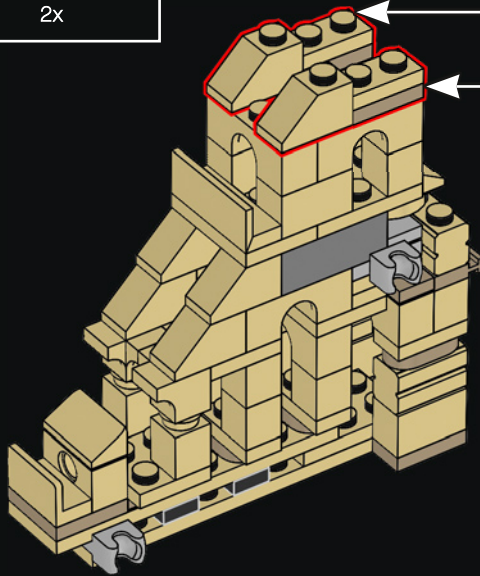

416

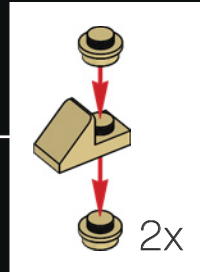
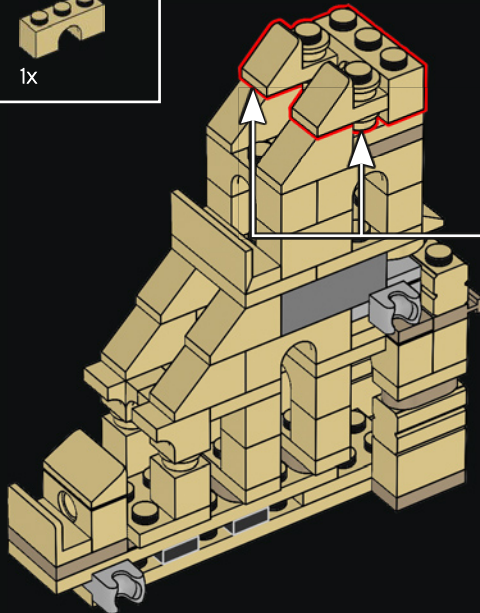

417

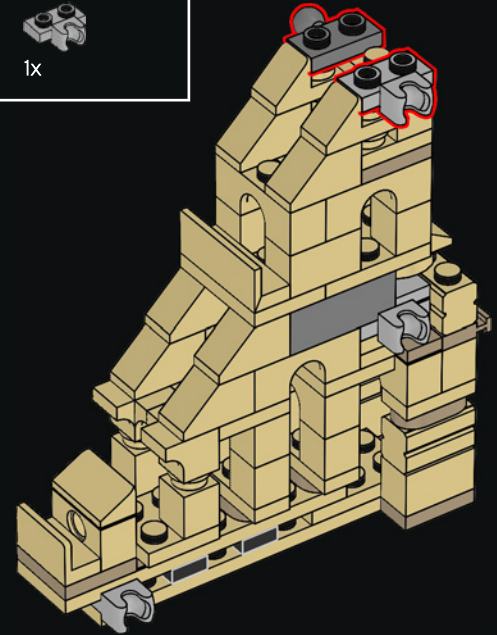

418

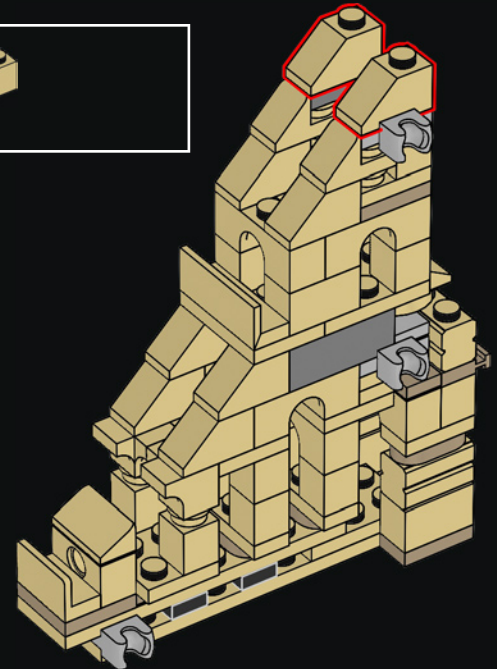

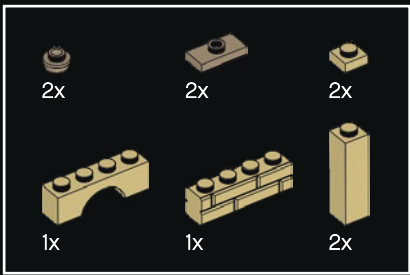

419

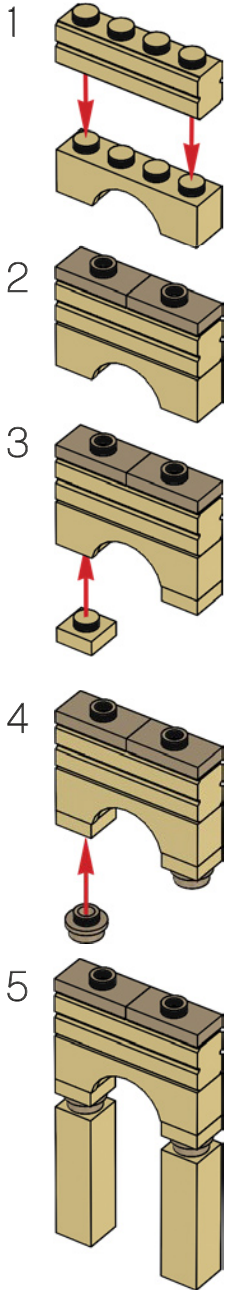
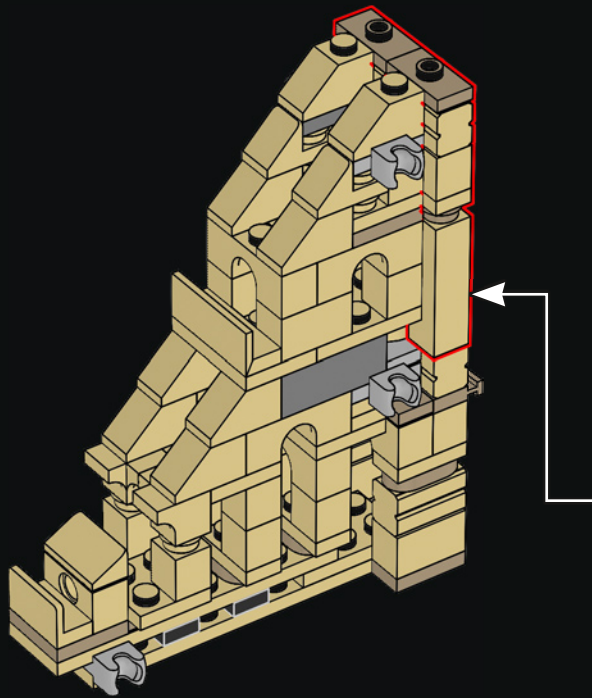

420

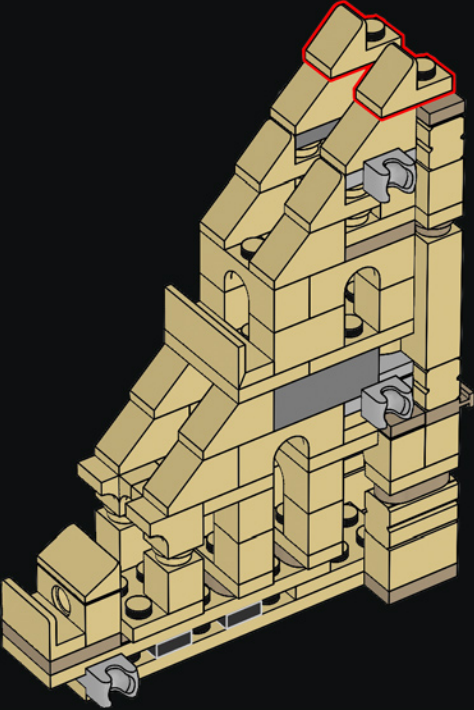



421

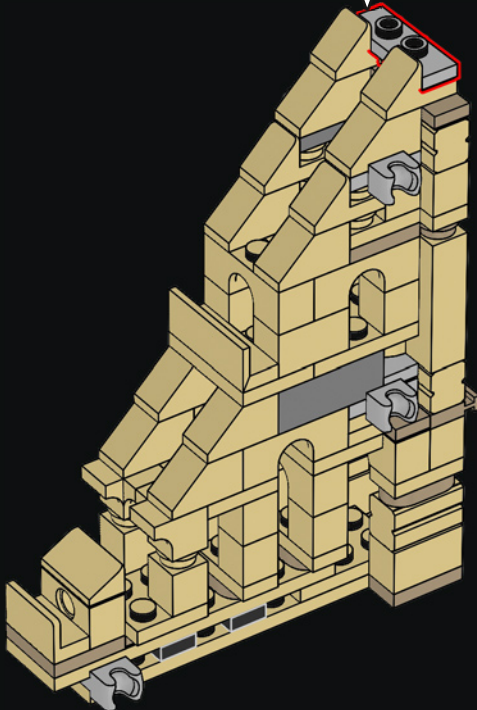
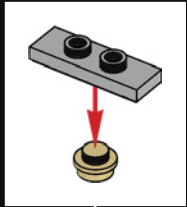

422

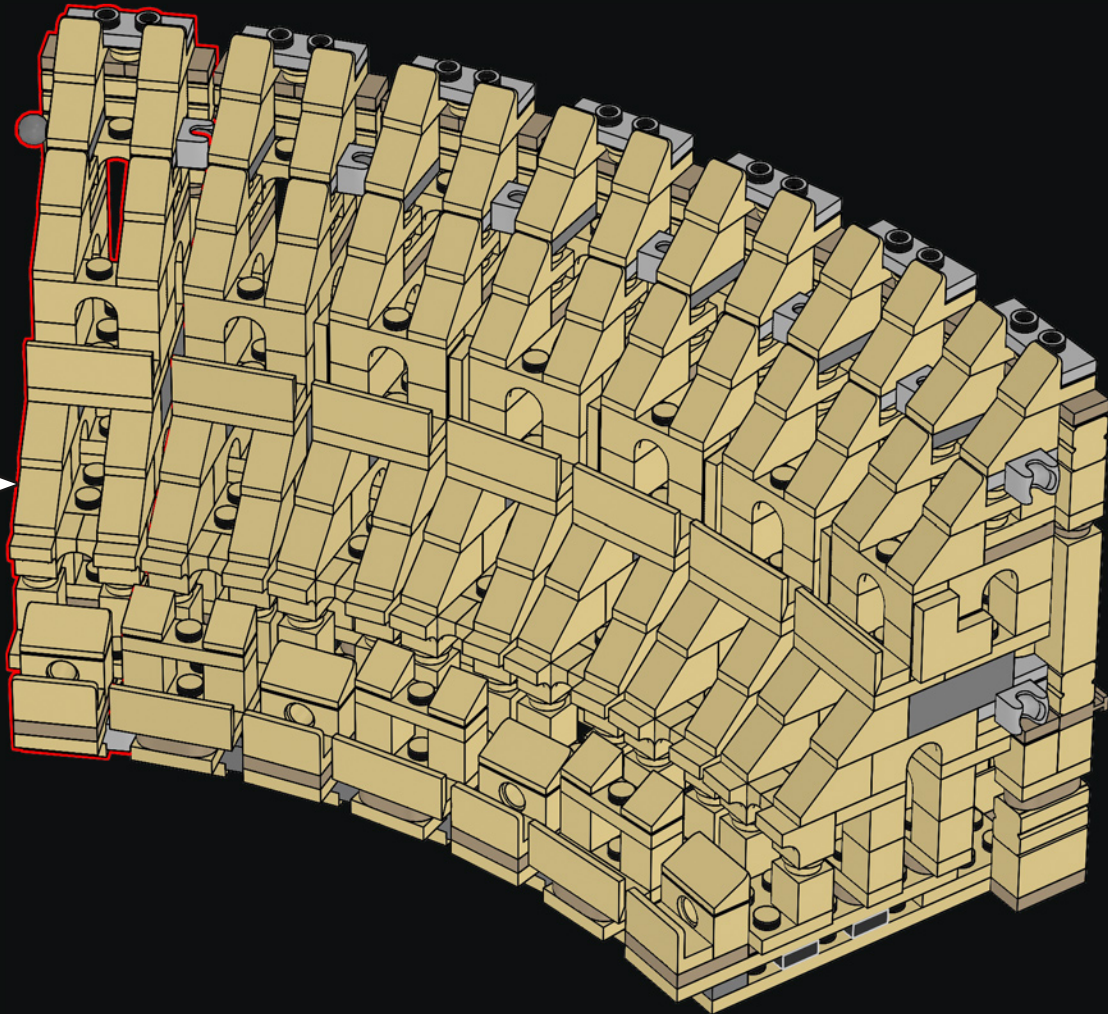

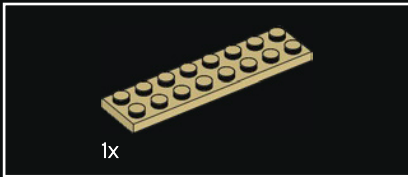
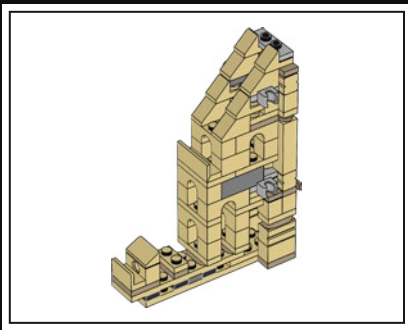

423

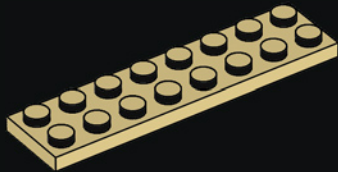

424

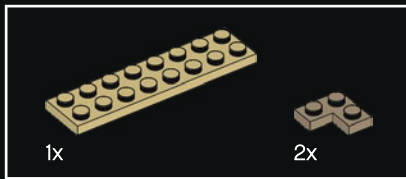
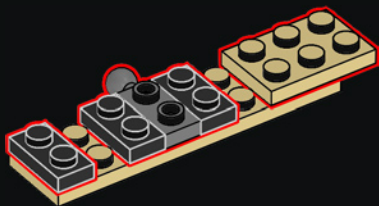

425

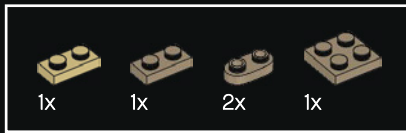
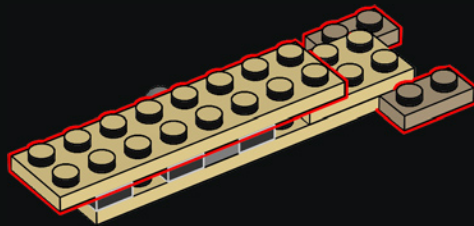

426

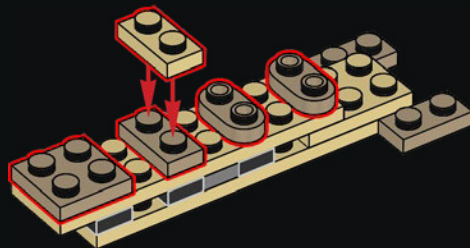

427

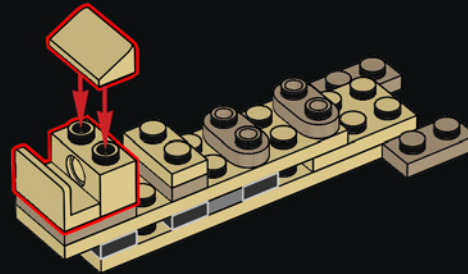

428

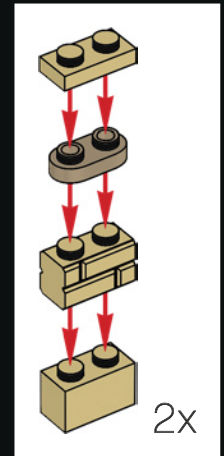
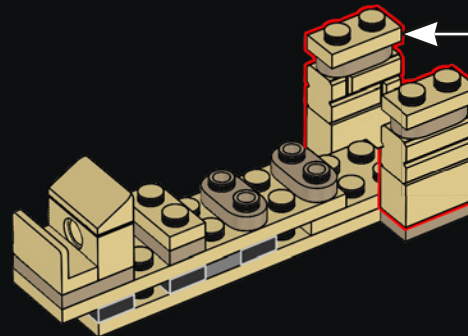

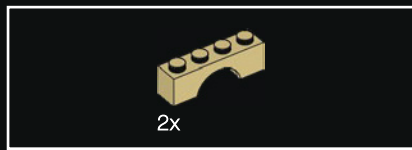

429

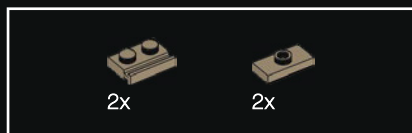
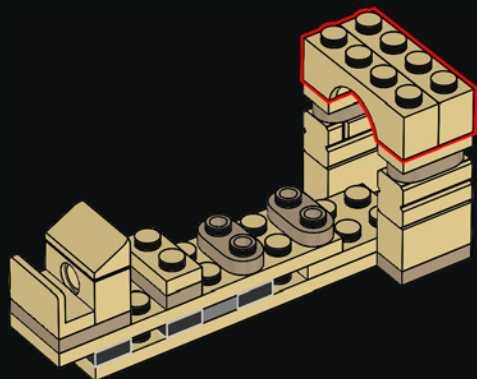

430

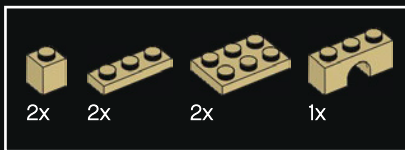
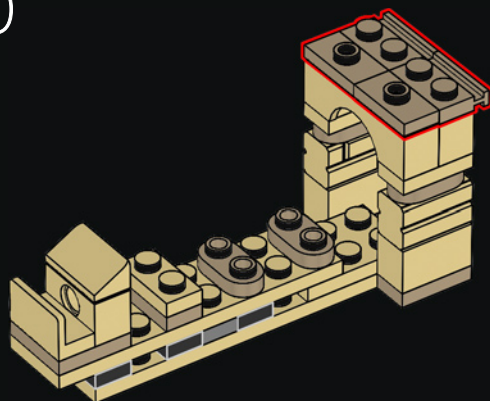

431

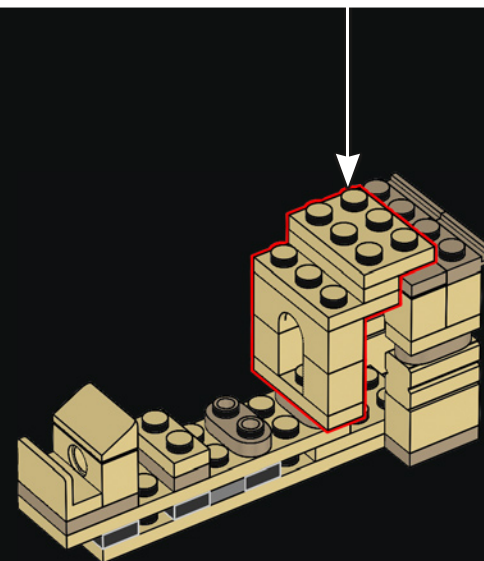
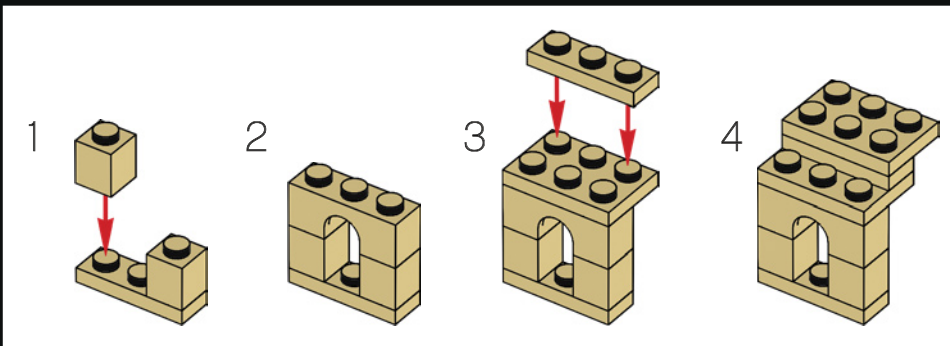

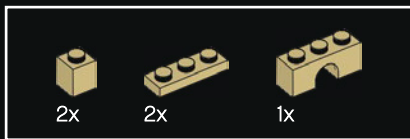

432

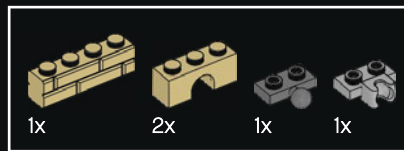
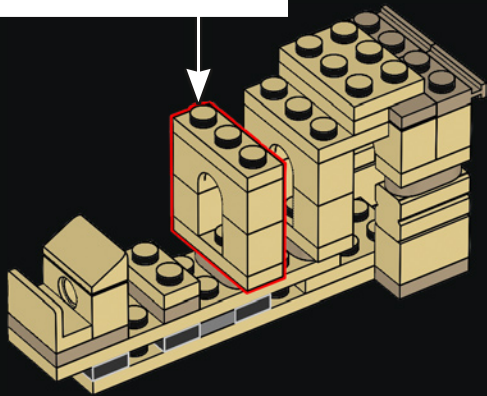
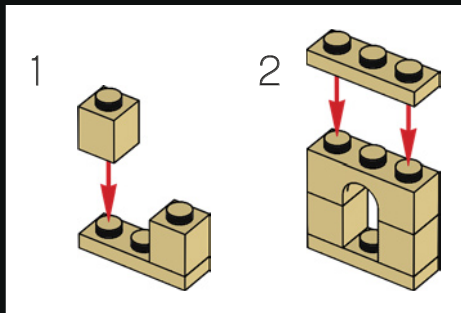

433

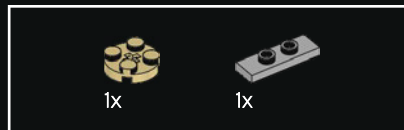
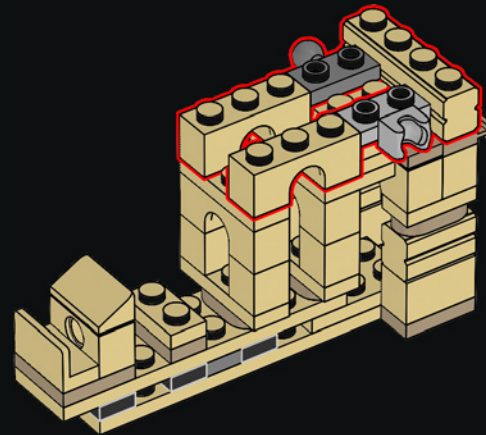

434

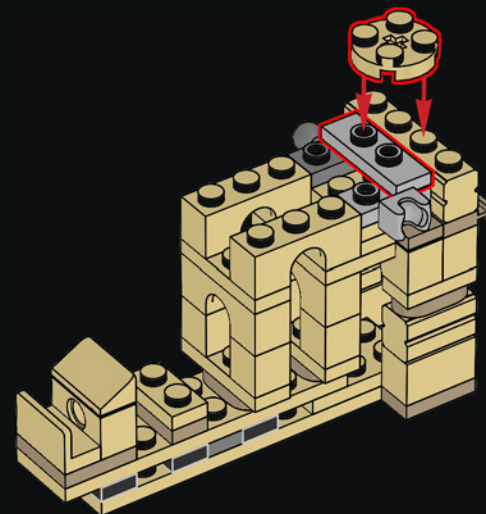

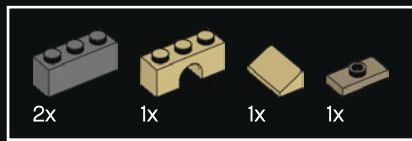

435

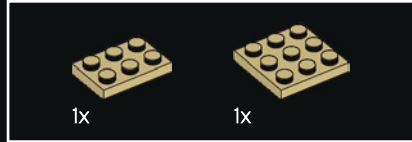
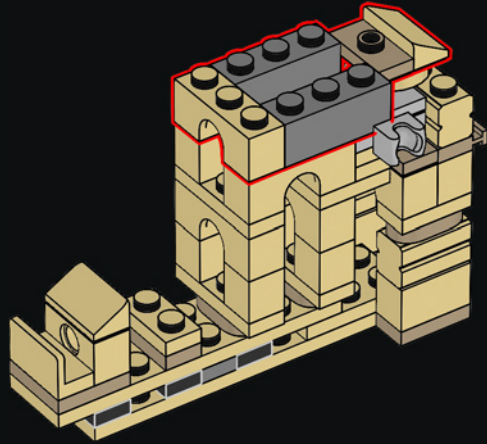

436

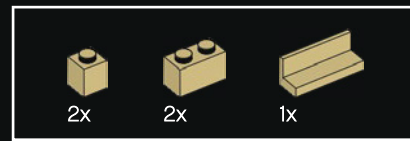
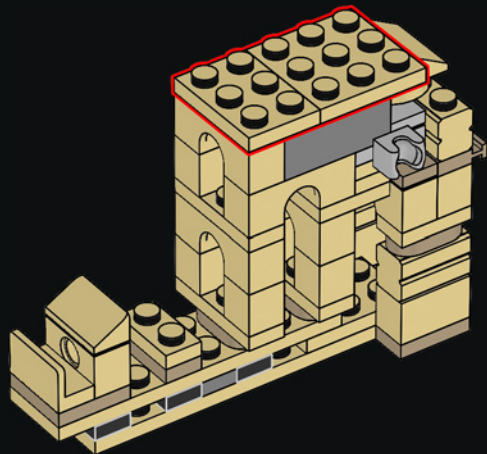

437

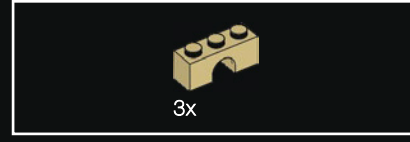
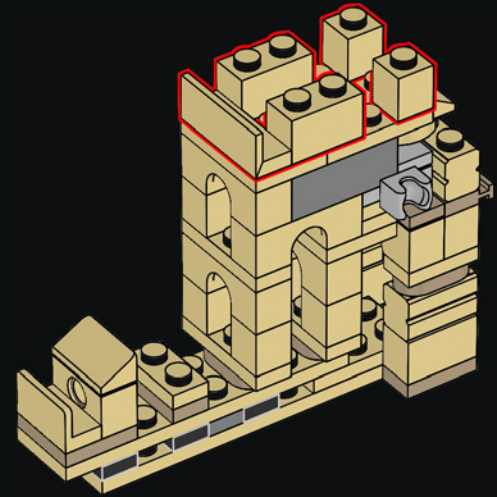

438

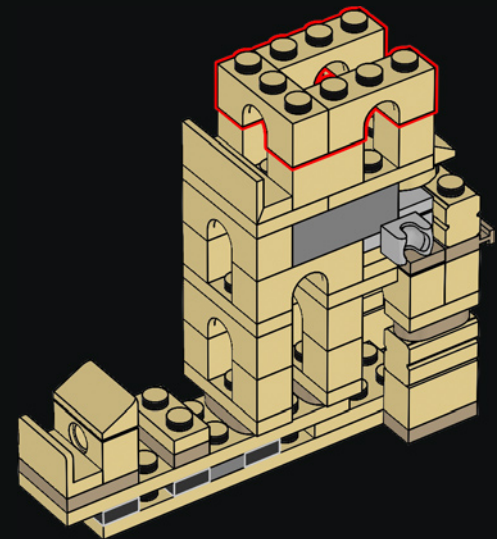



439

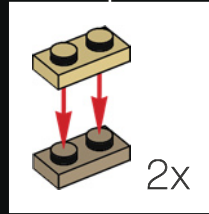
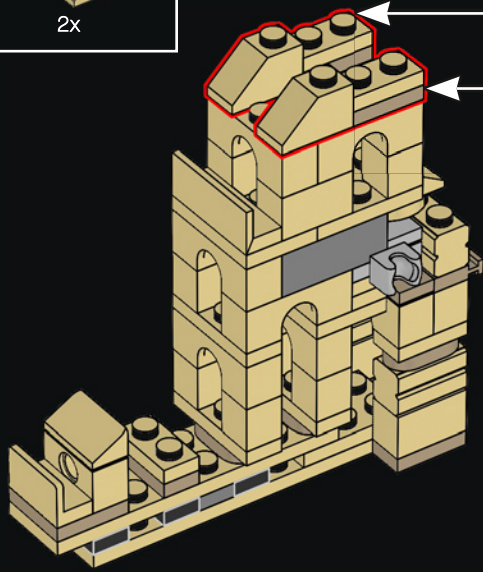

441

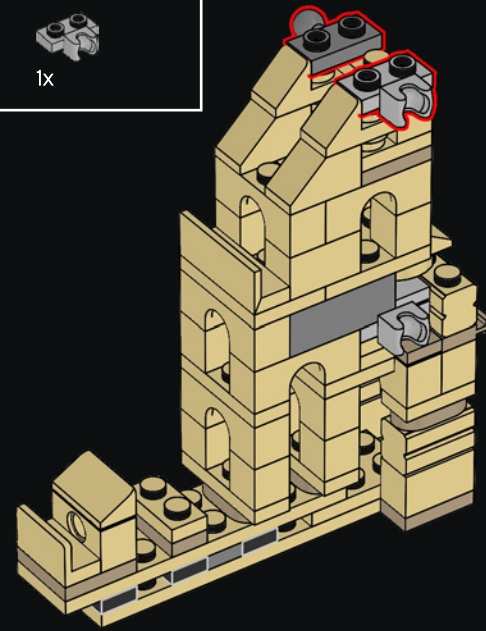

440

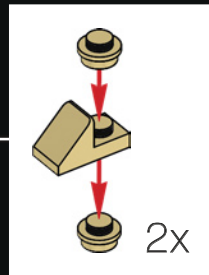
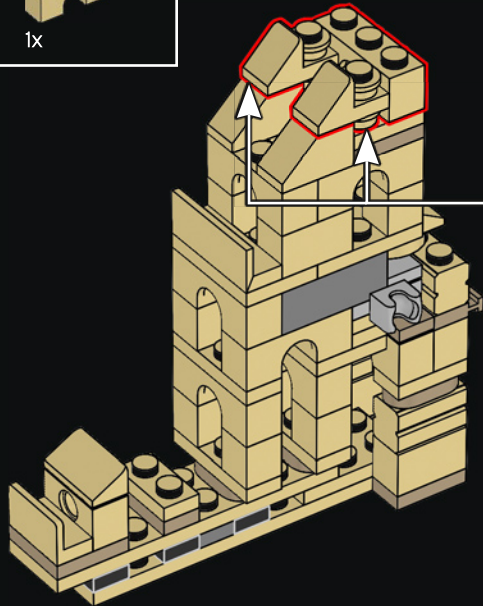

442

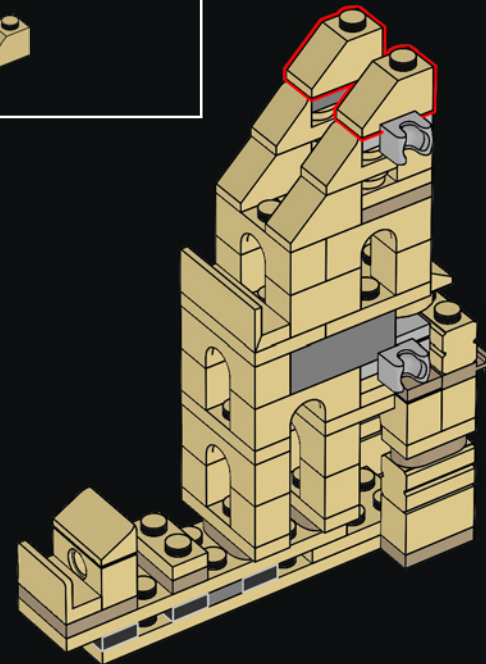

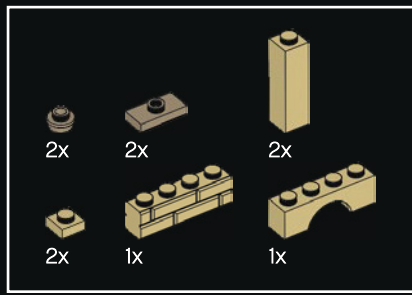

443

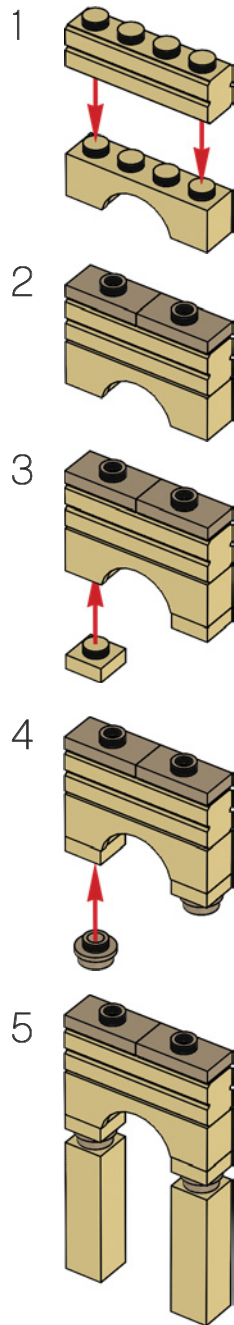
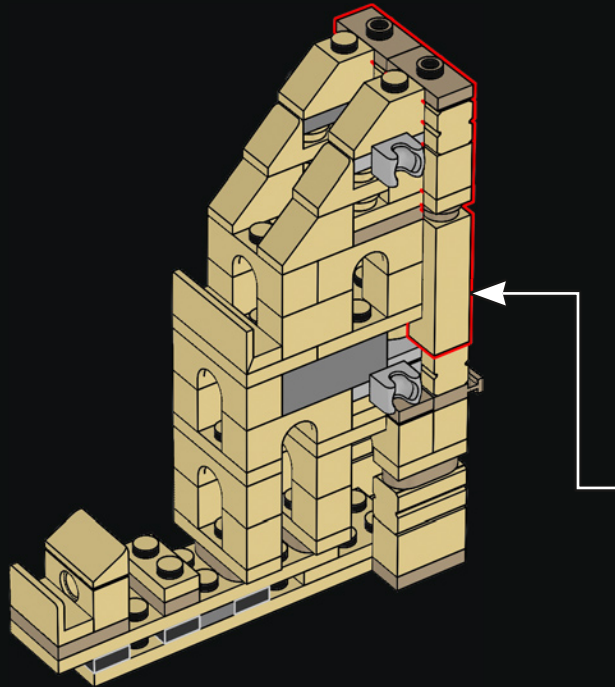

444

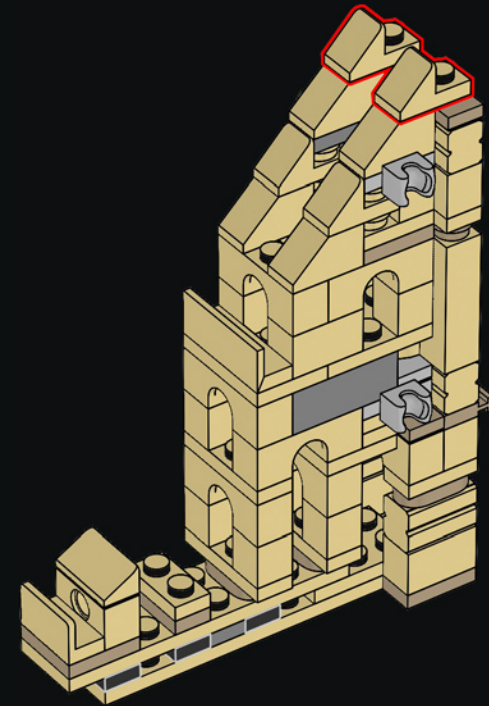



445

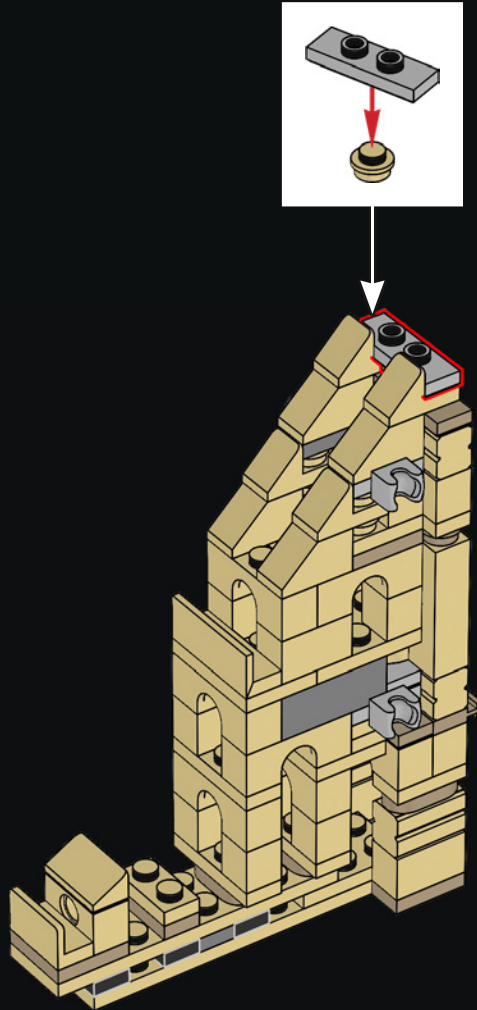

446

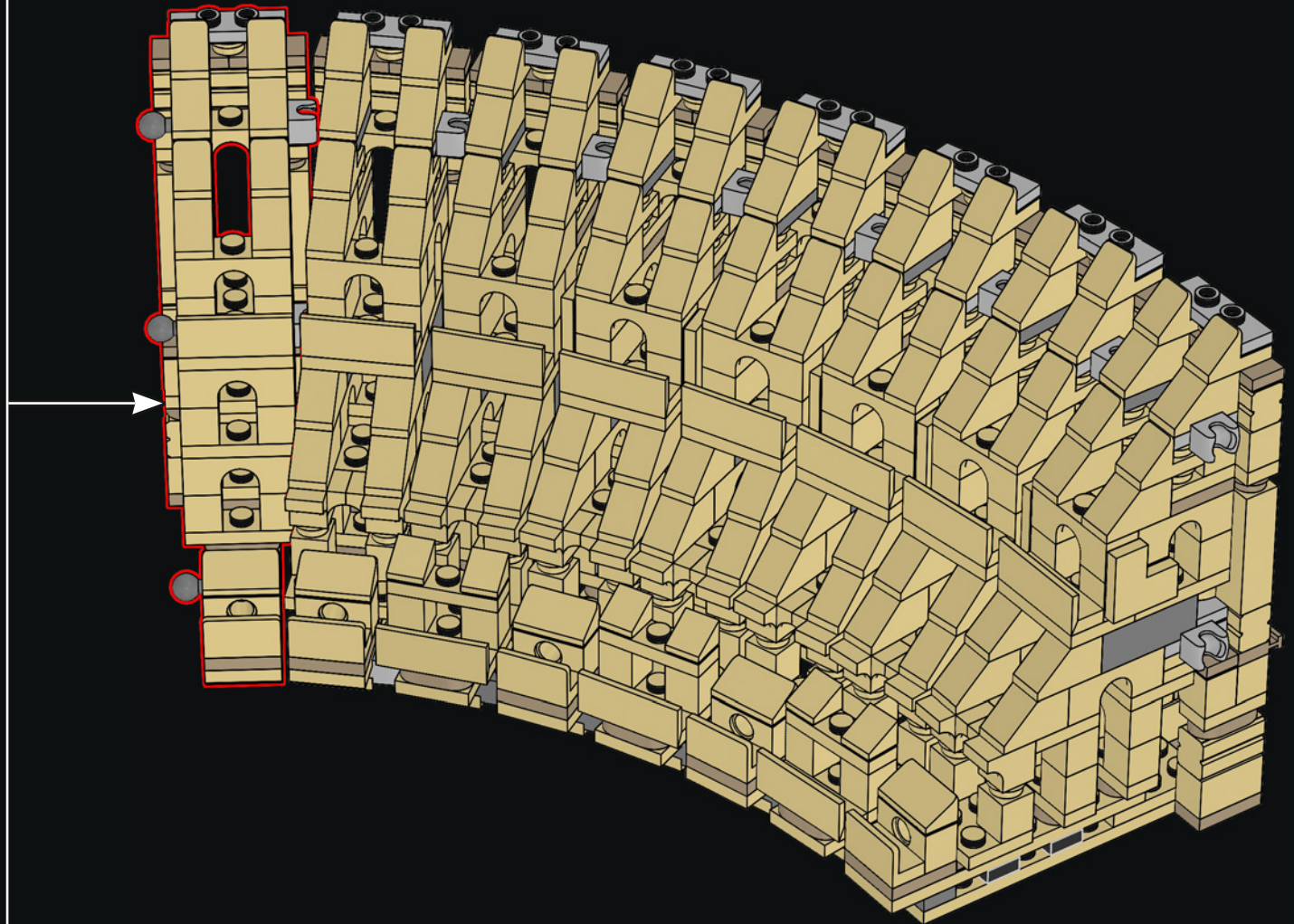

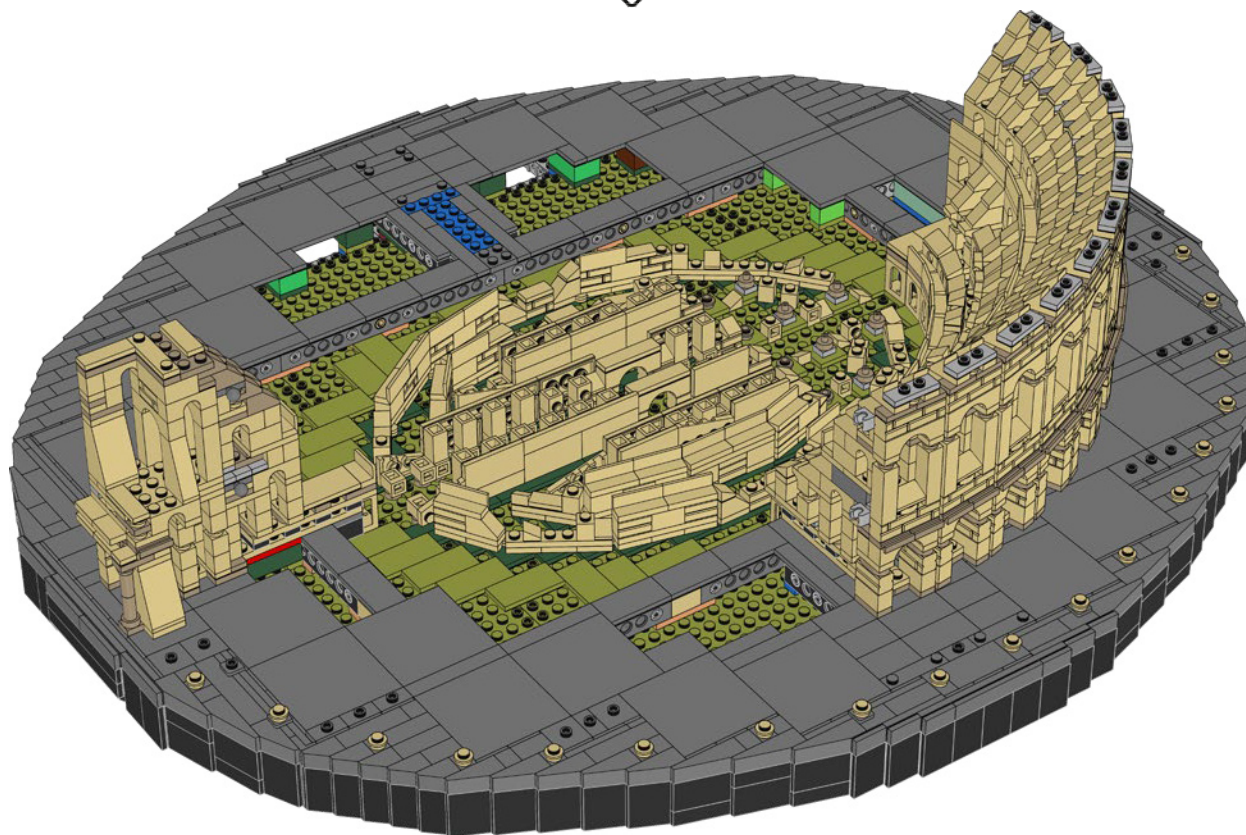

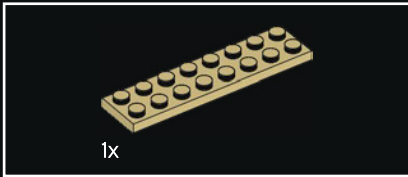
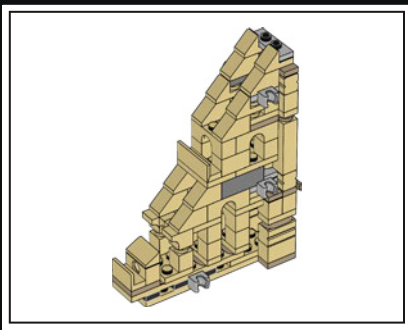

447



448

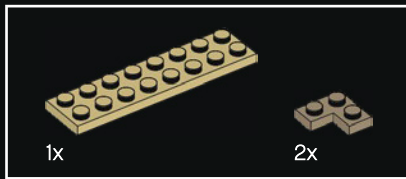
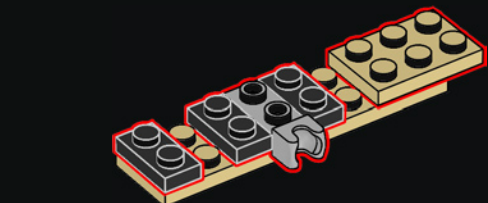

449

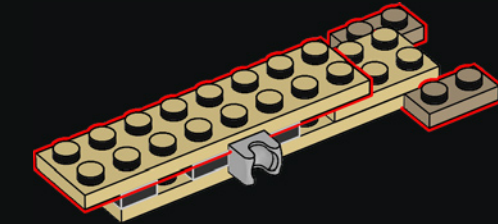

450

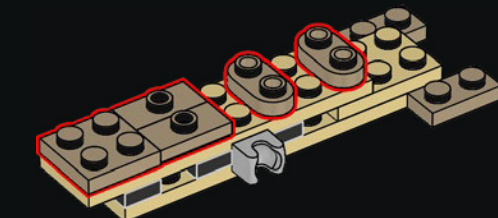

451

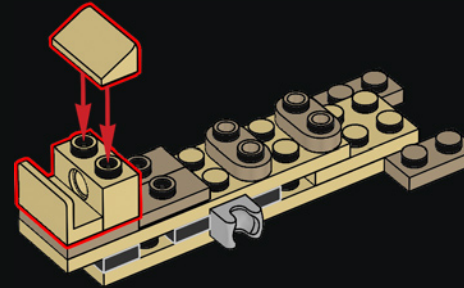

452

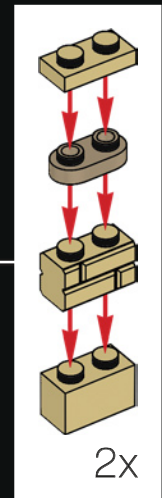
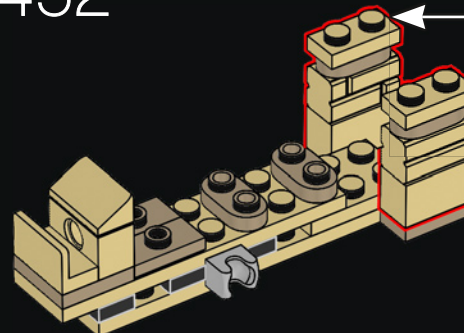

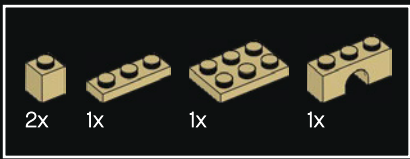

456

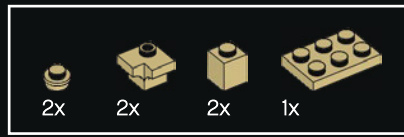
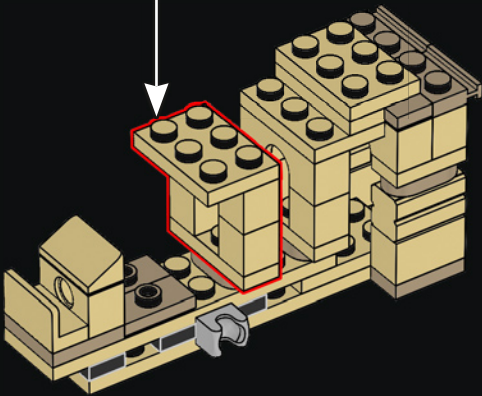
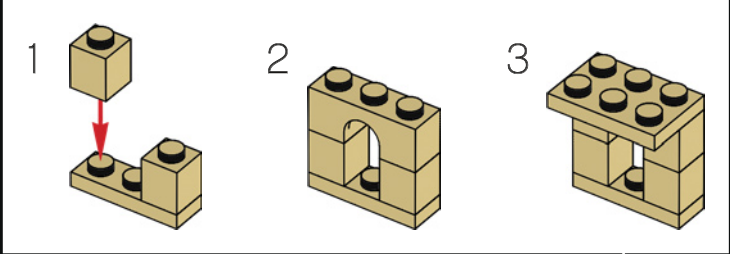

457

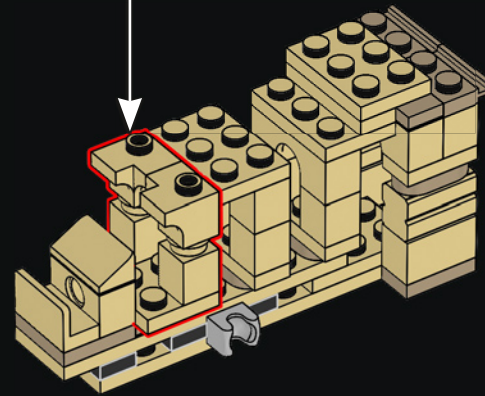
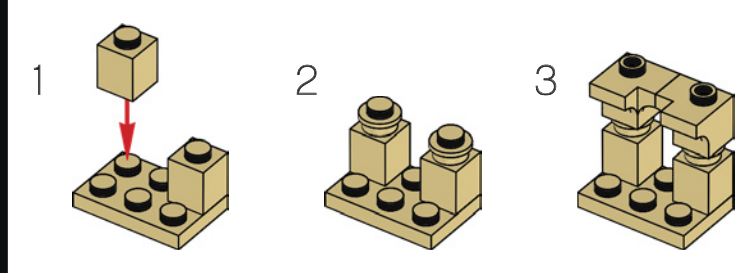

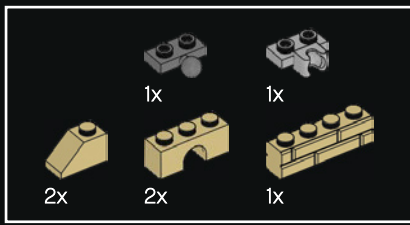

458

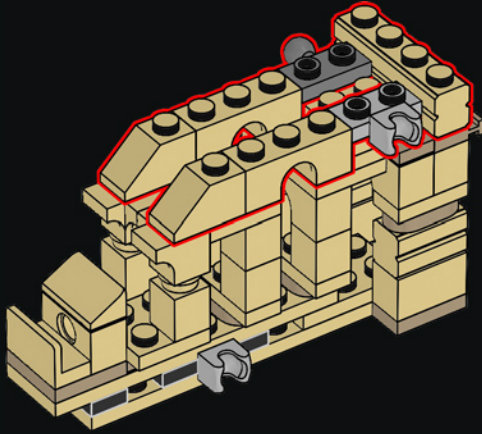

459

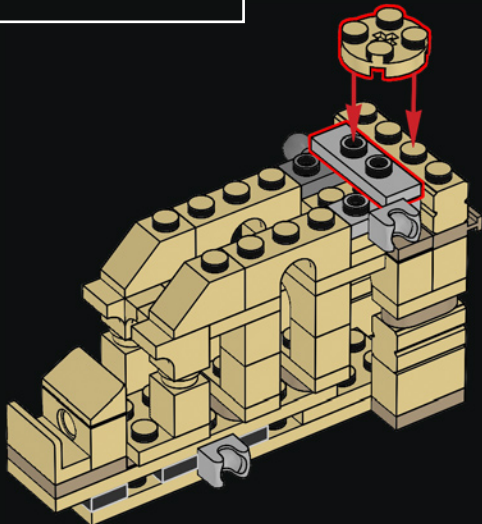

460

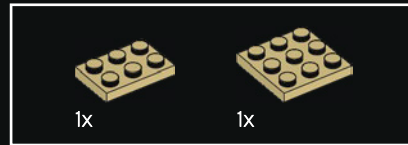
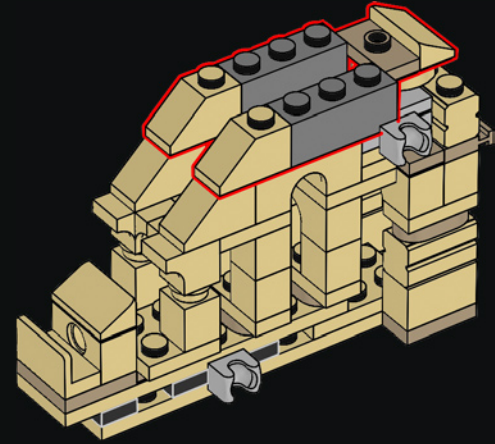

461

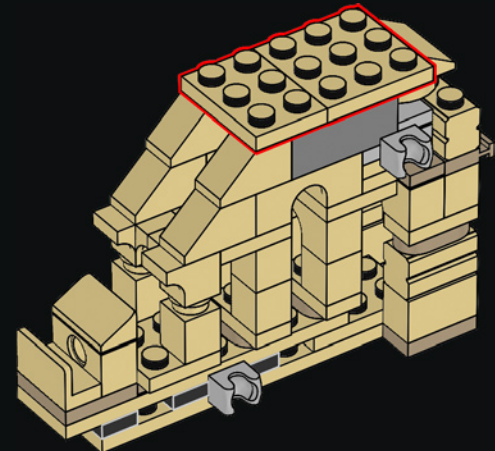



462

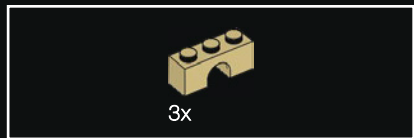
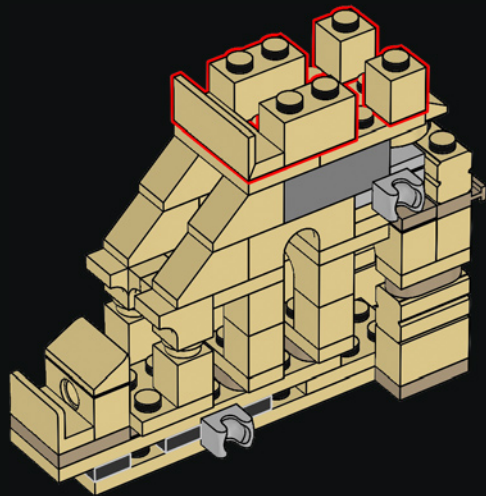

463

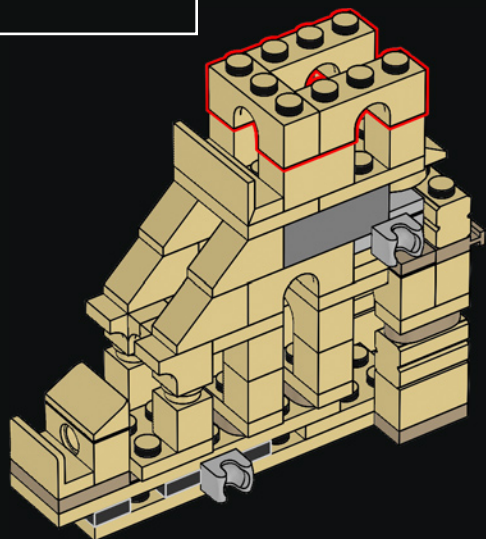

464

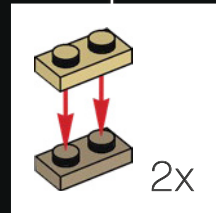
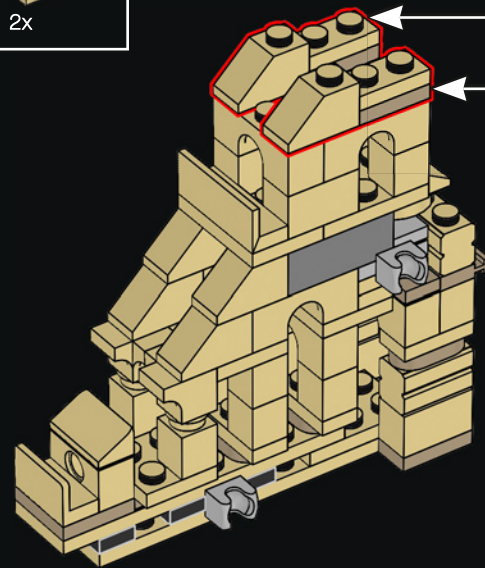

465

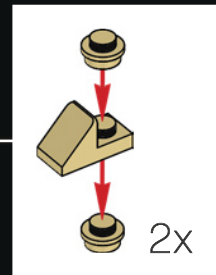
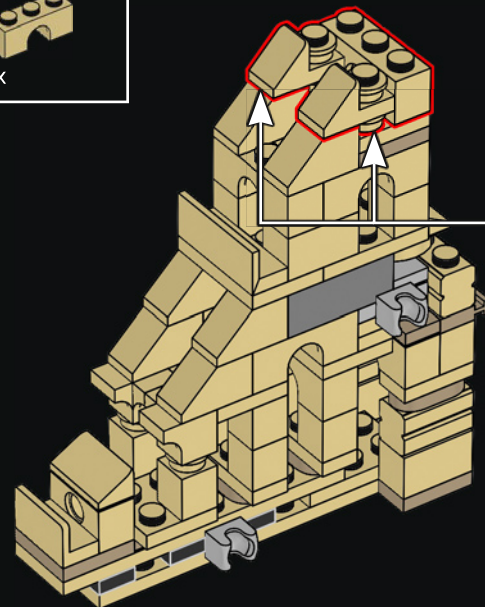



466

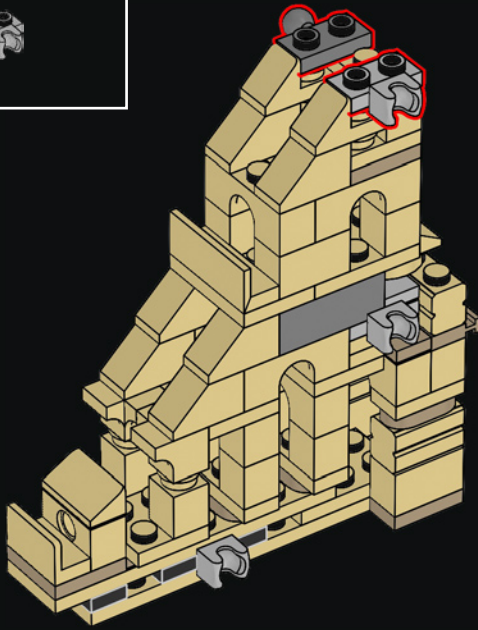

467

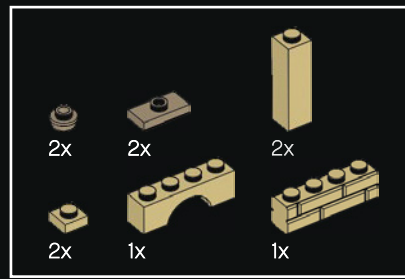
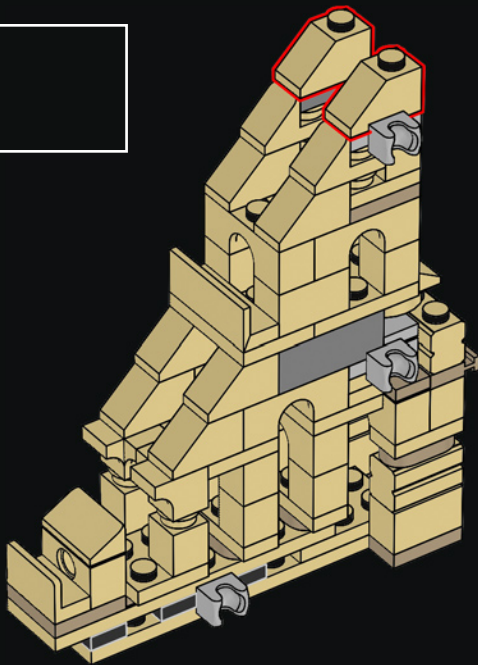

468

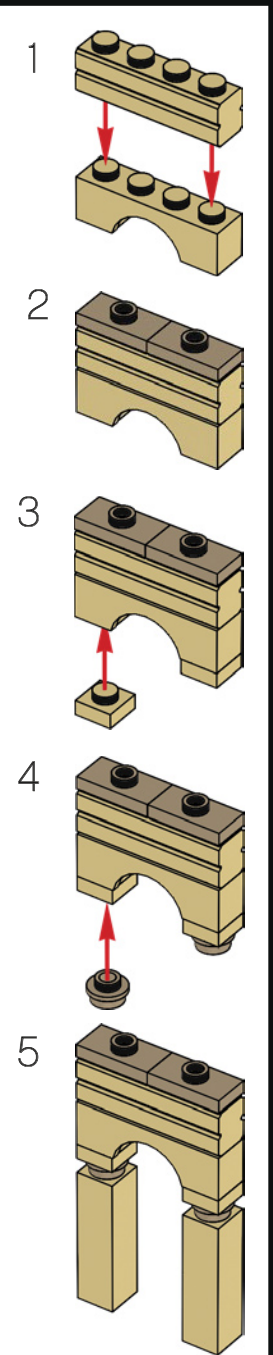
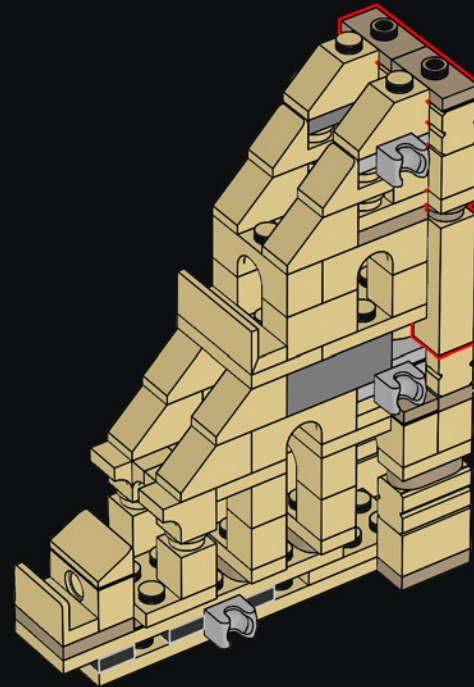



2x

469

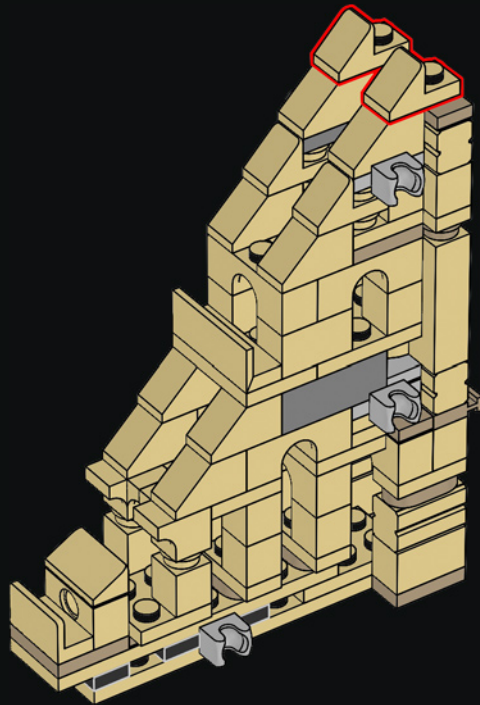

1x

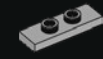

1x

470

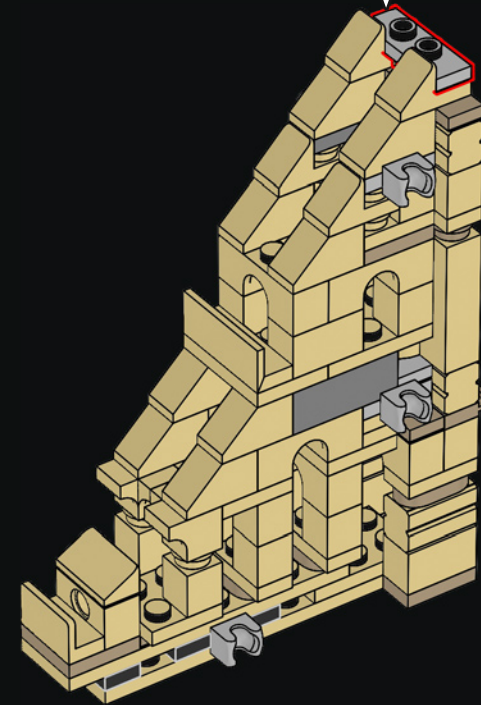
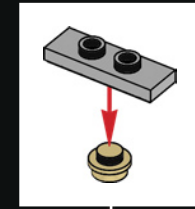

471

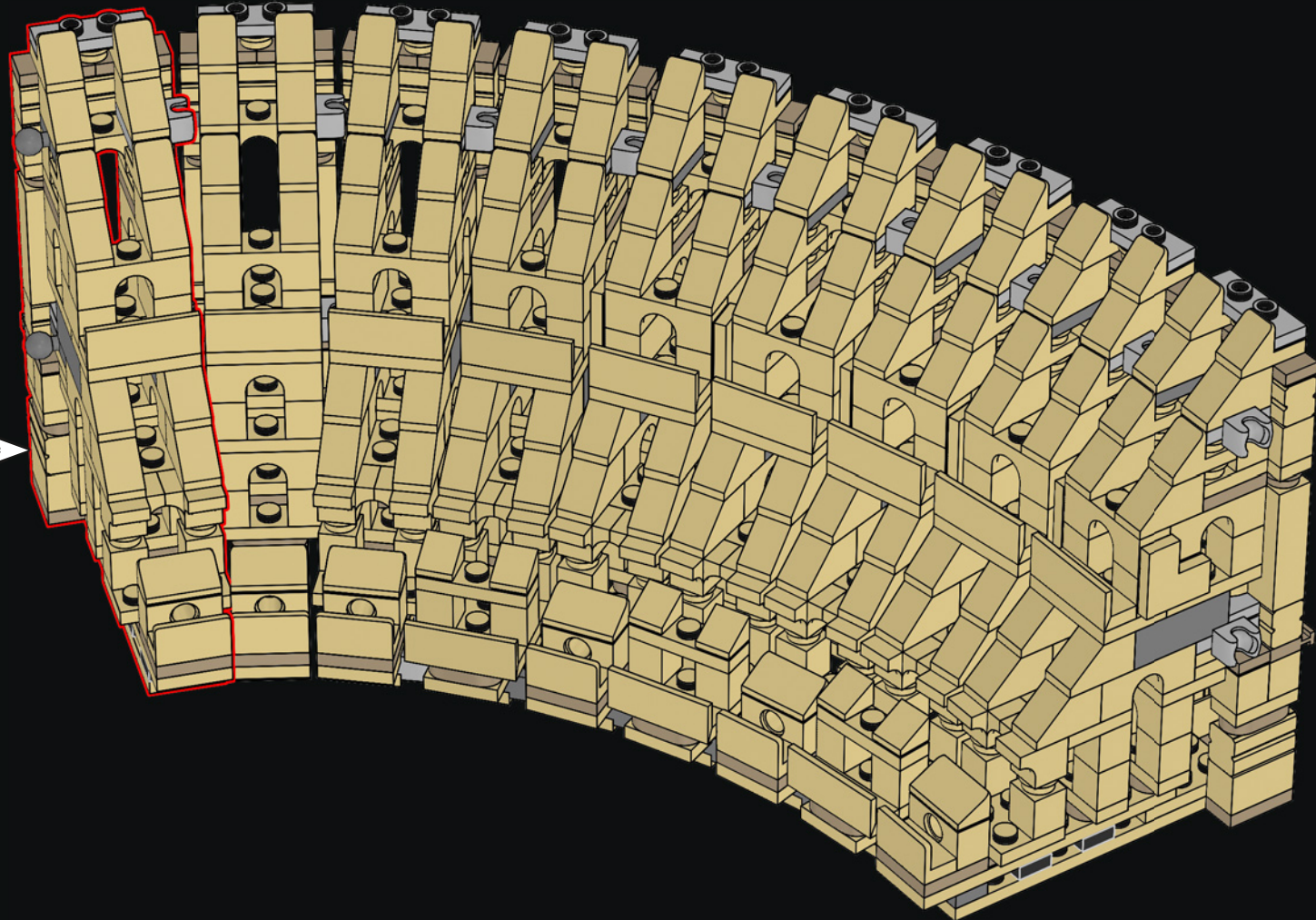

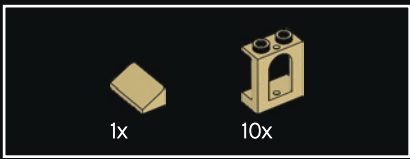

472

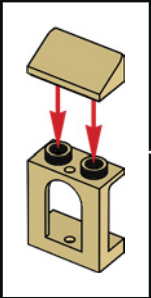
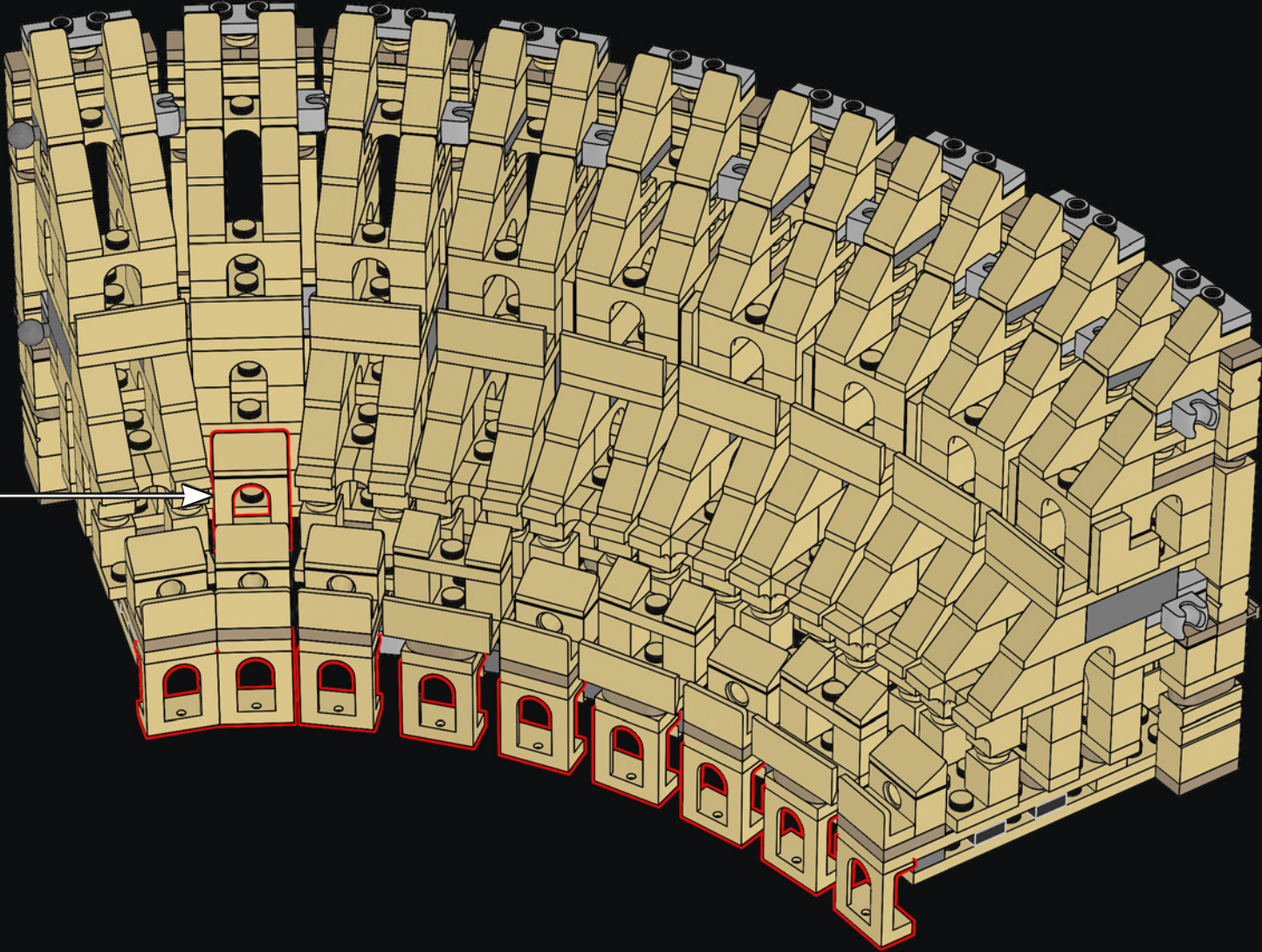

473

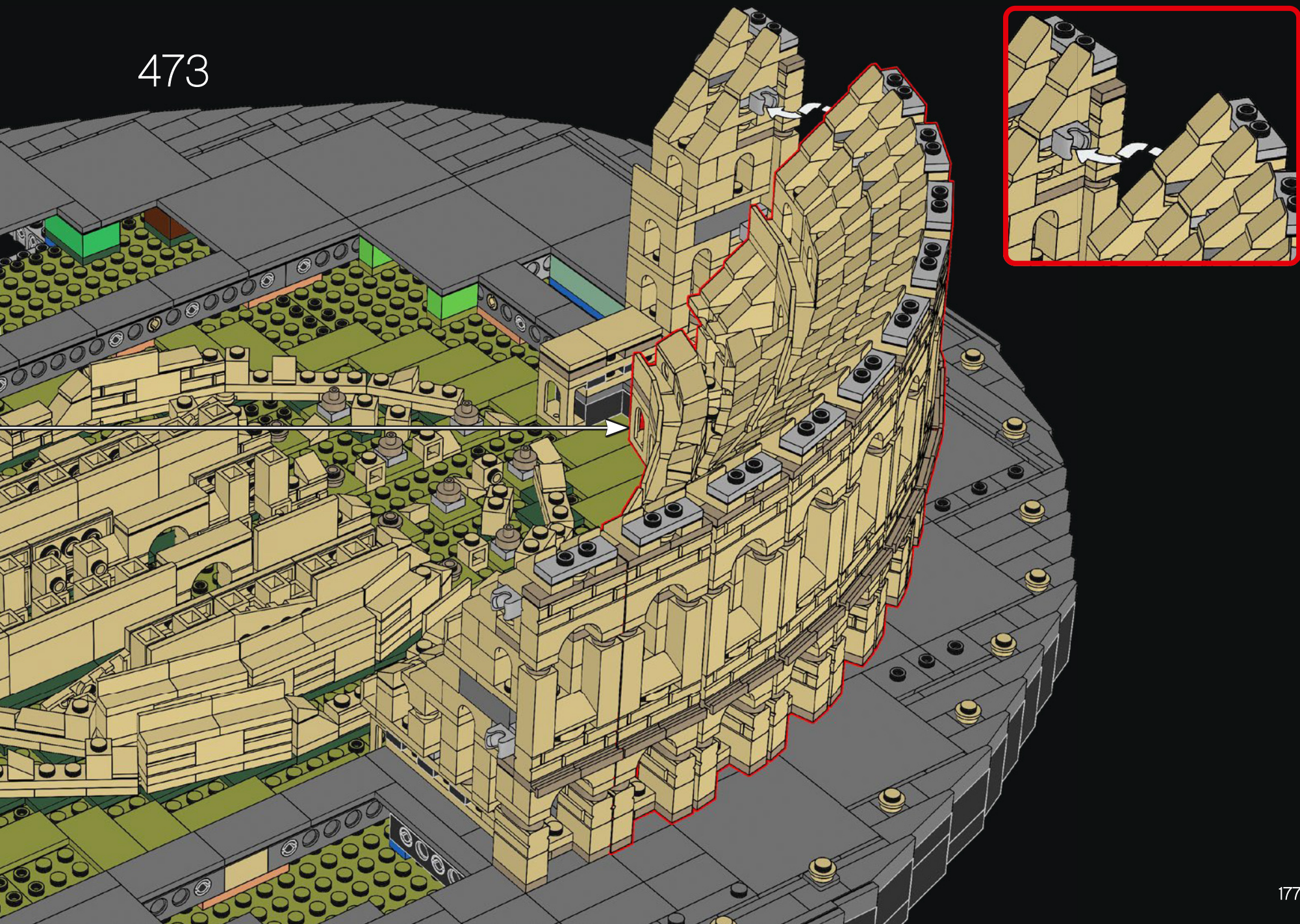

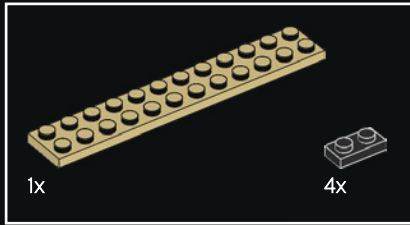
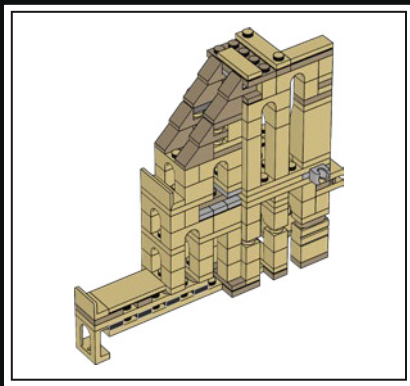

474

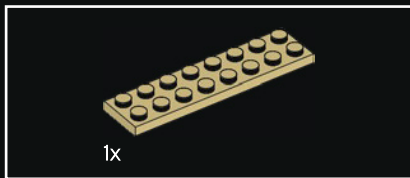
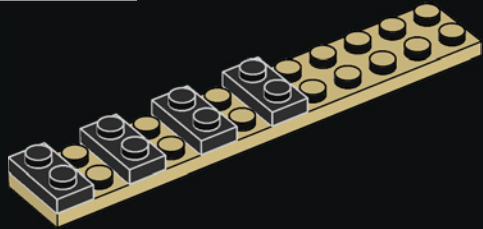

475

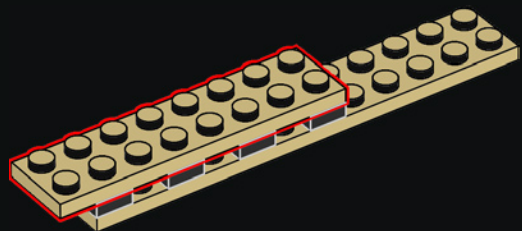

476

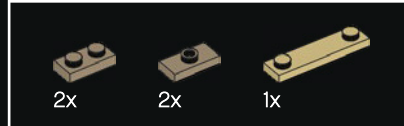
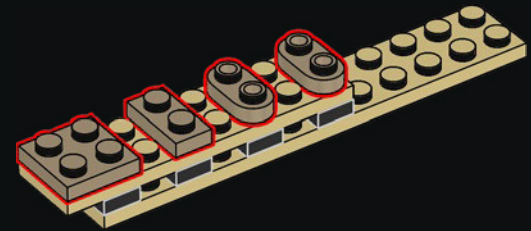

477

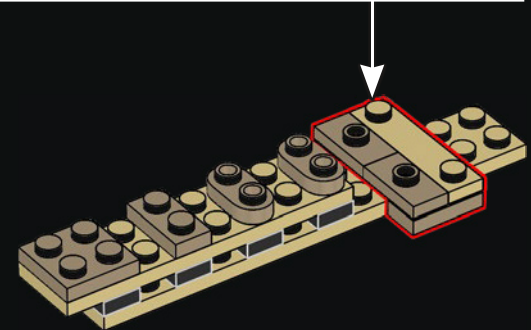
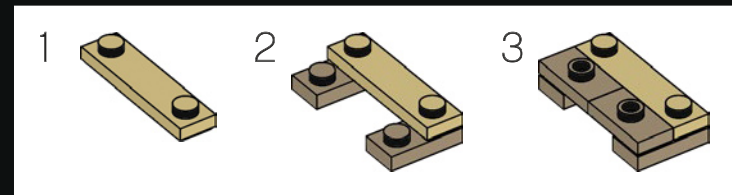



478

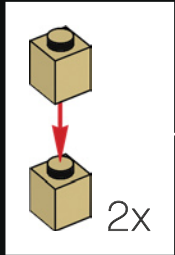

2x

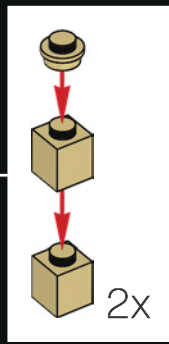
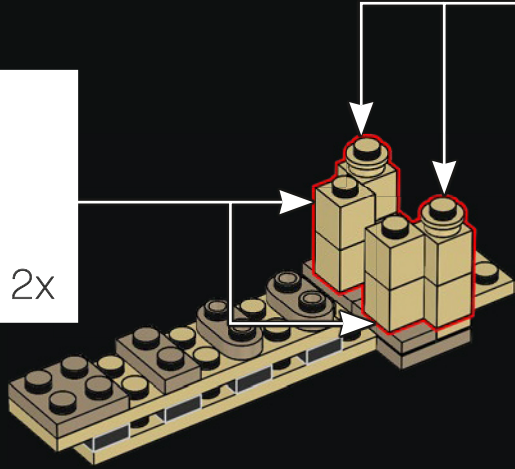

2x

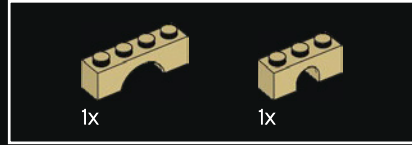

479

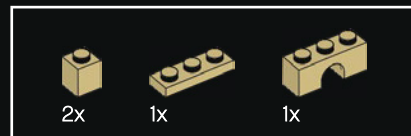
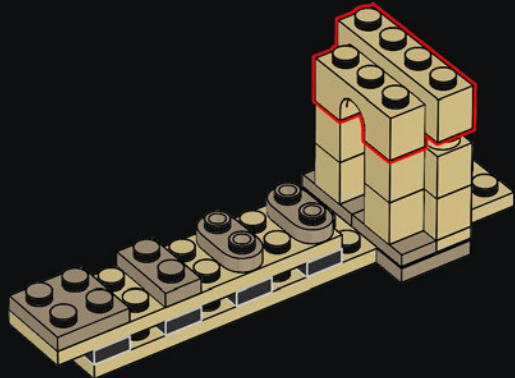

480

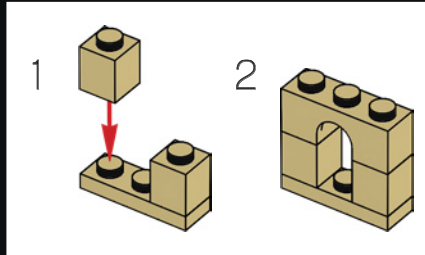

1

2

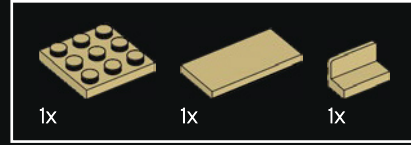
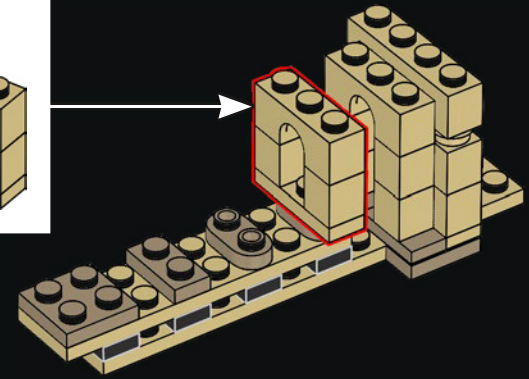

481

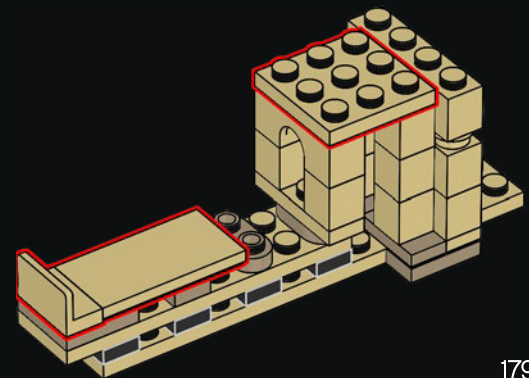

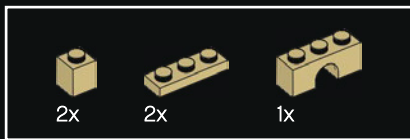

482

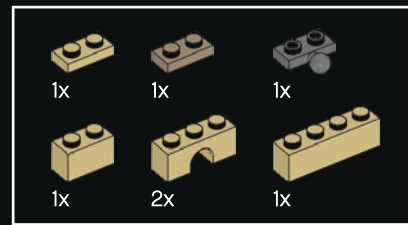
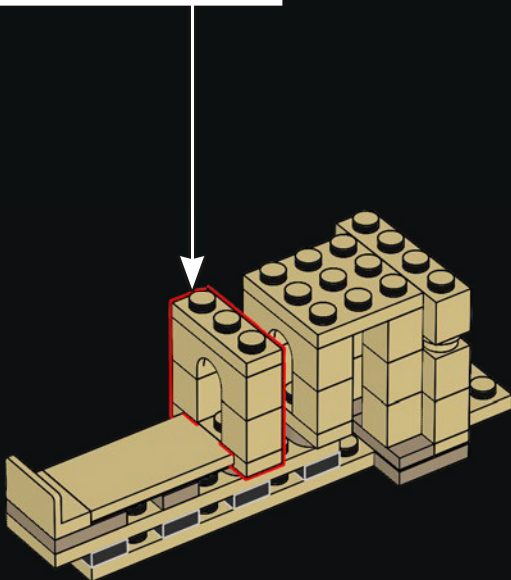
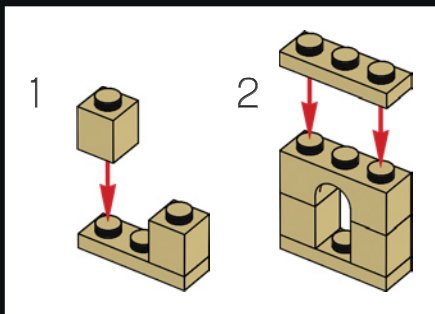

483

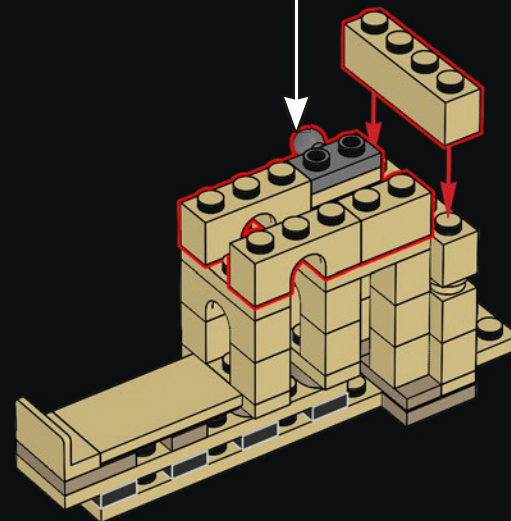
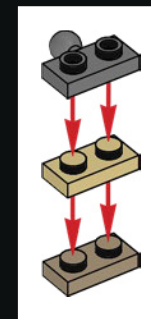

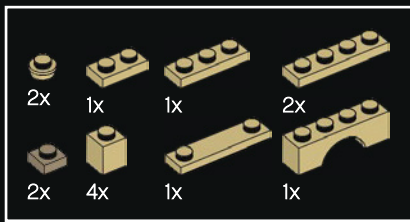

484

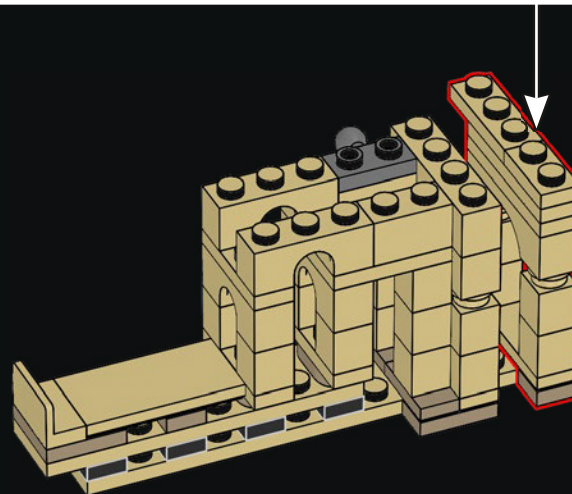
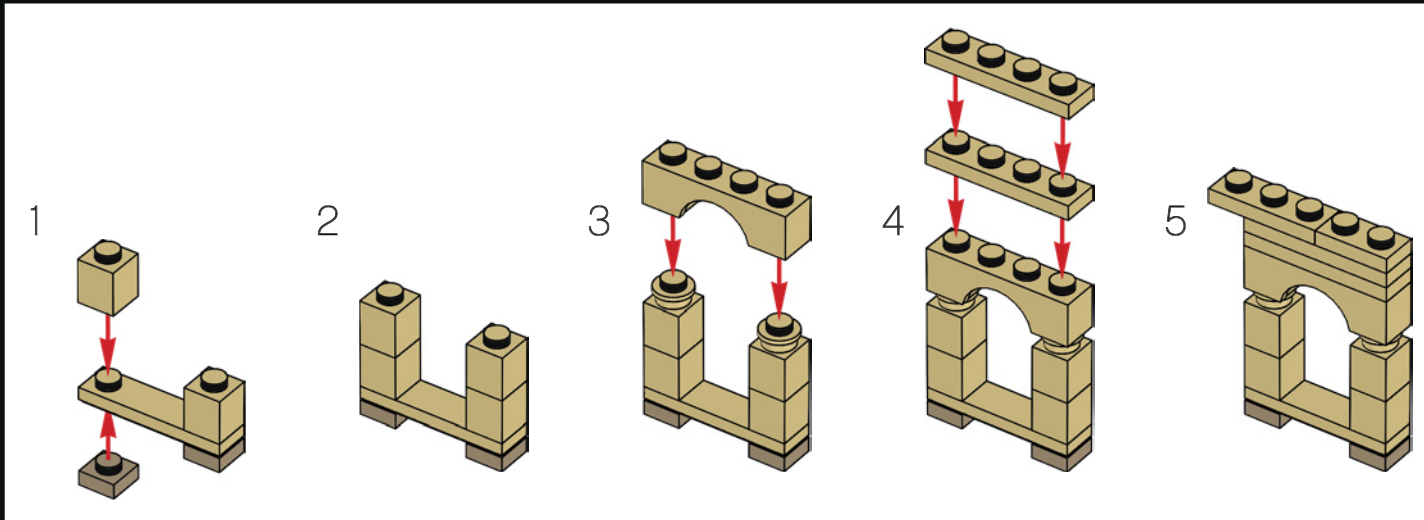

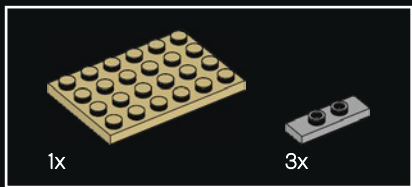

485

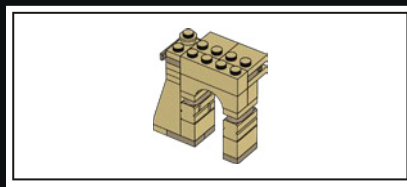
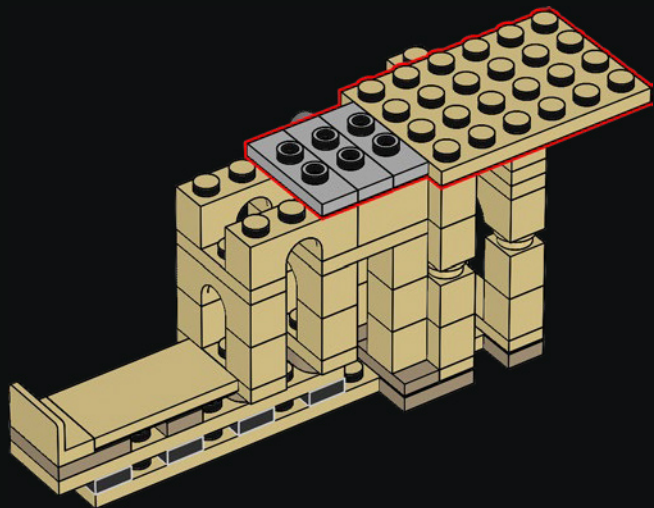

486



487

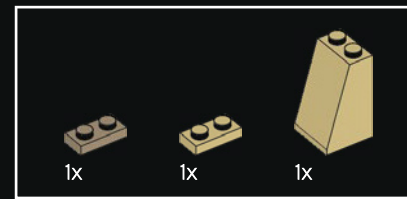

488

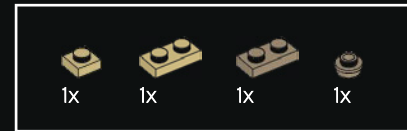
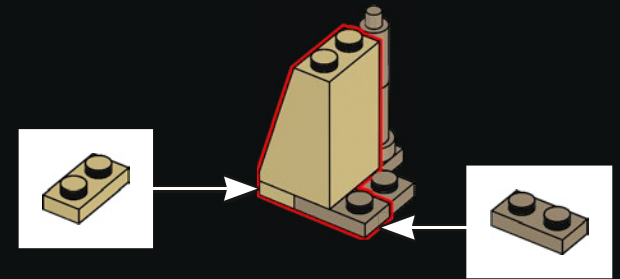

489

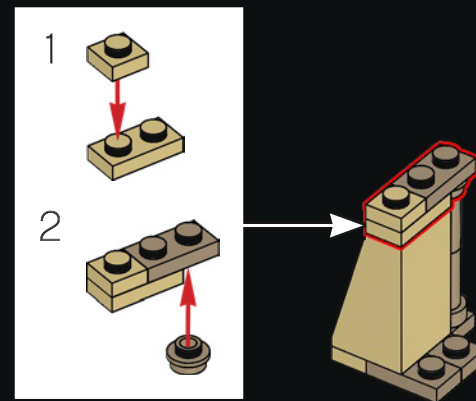

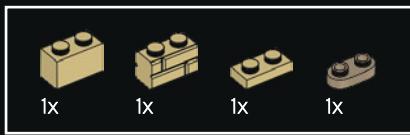

490

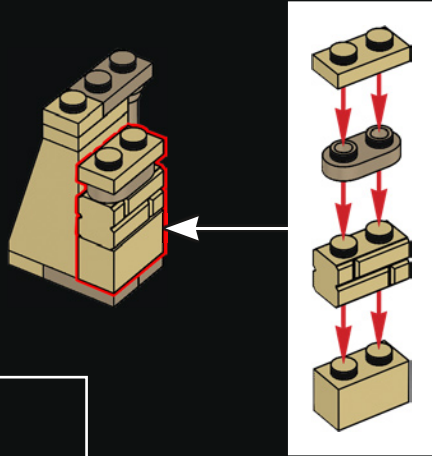

491

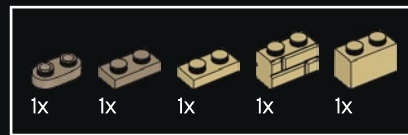
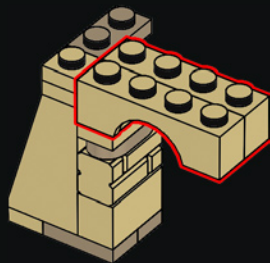

492

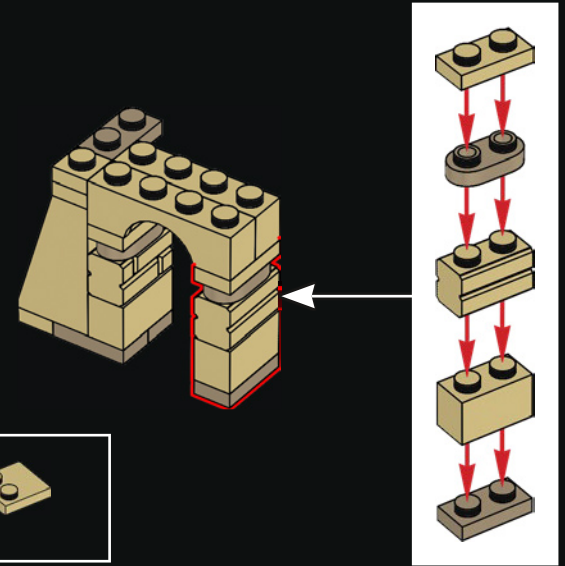

493

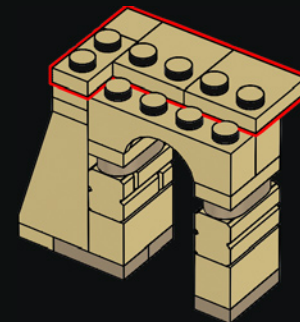

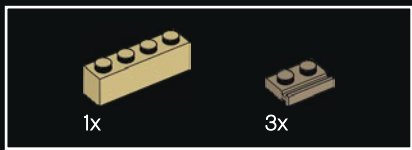

494

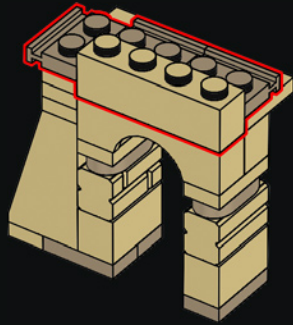

495

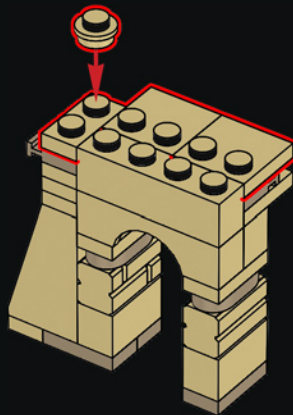

496

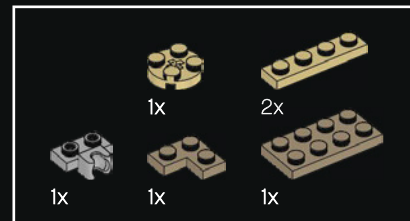
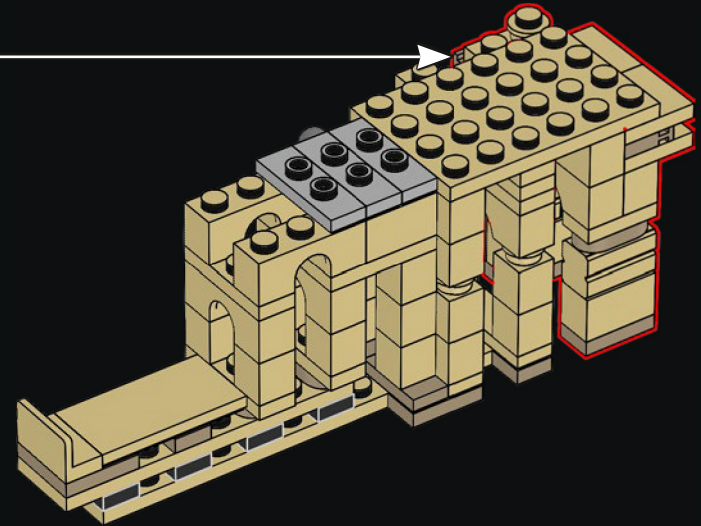

497

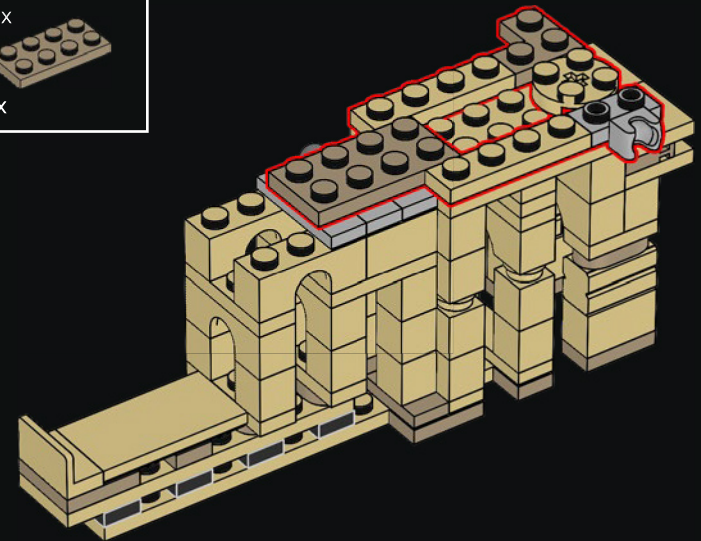

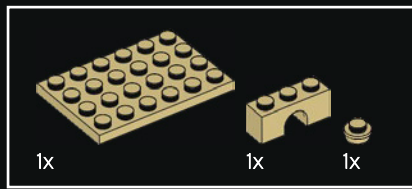

498

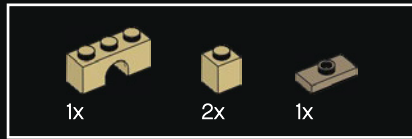
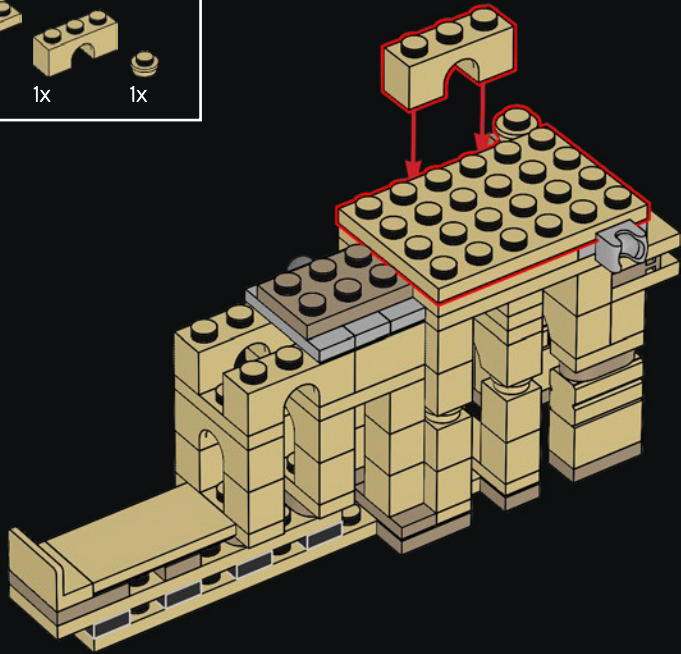

499

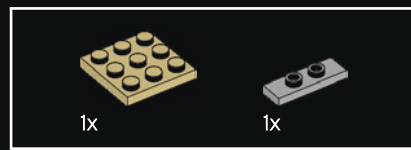
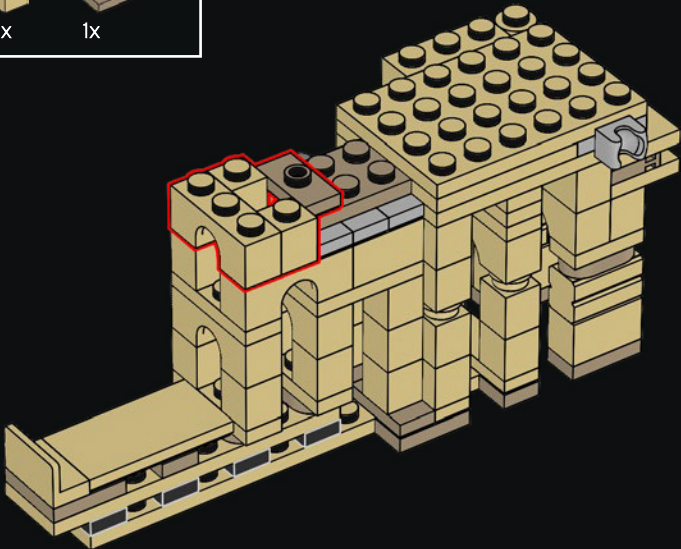

500

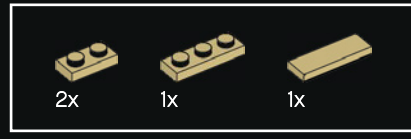
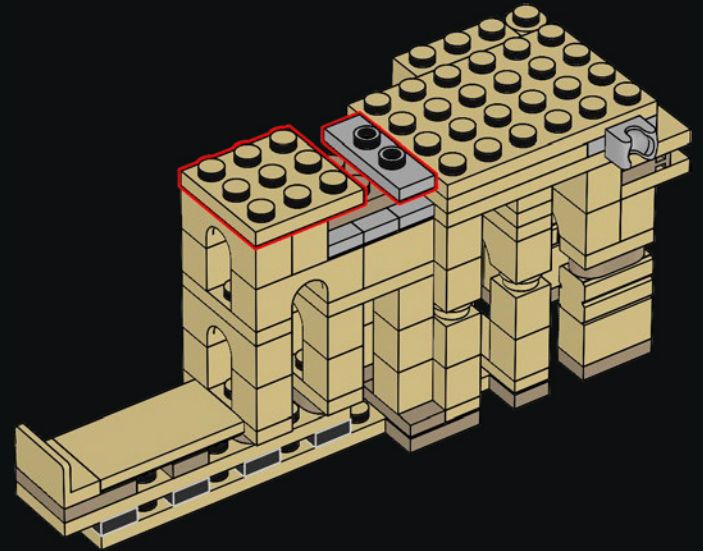

501

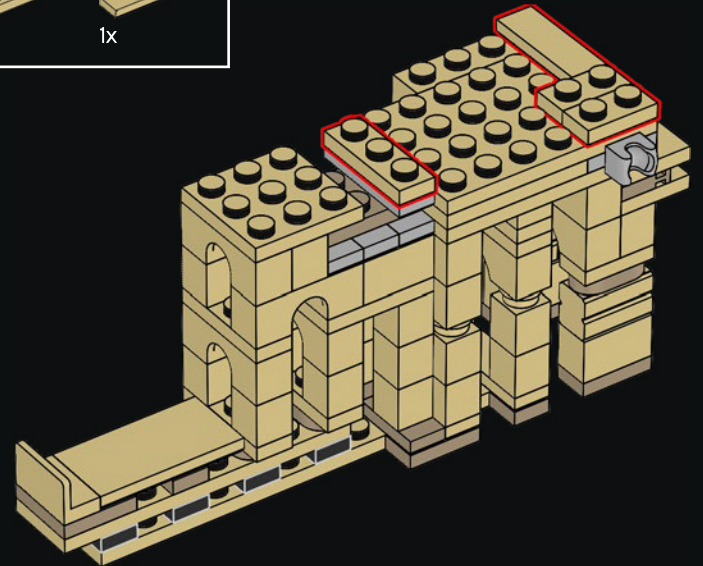

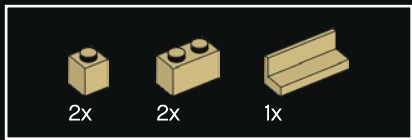

502

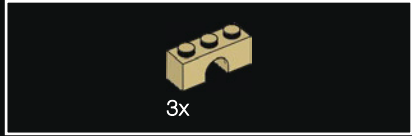
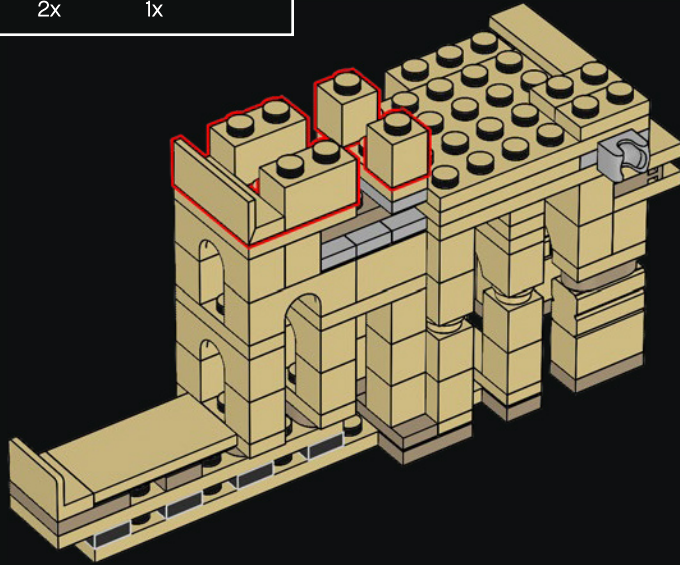

503

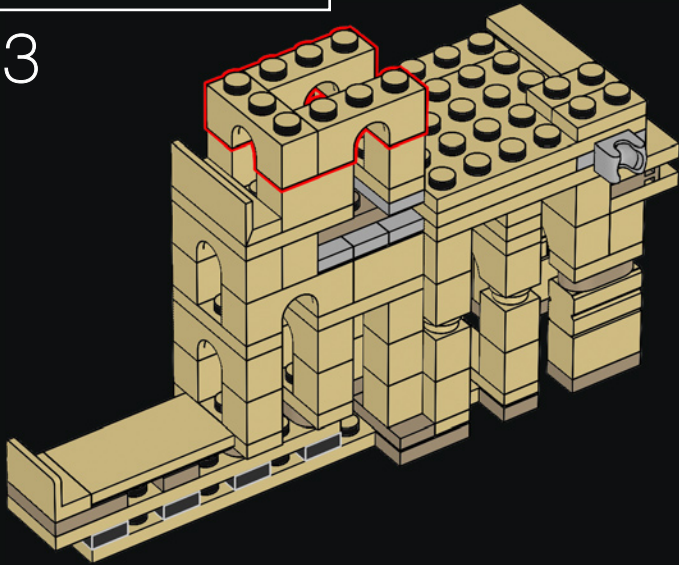

504

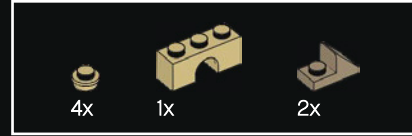
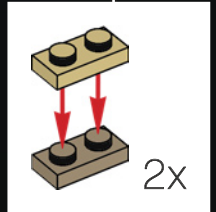
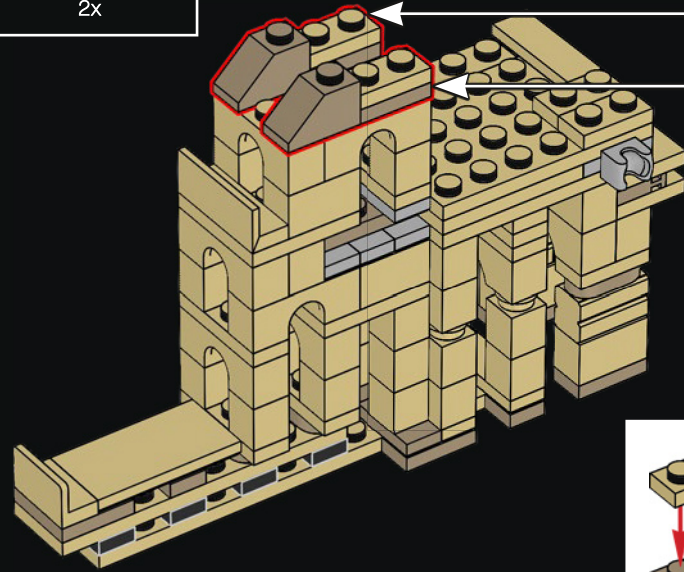

505

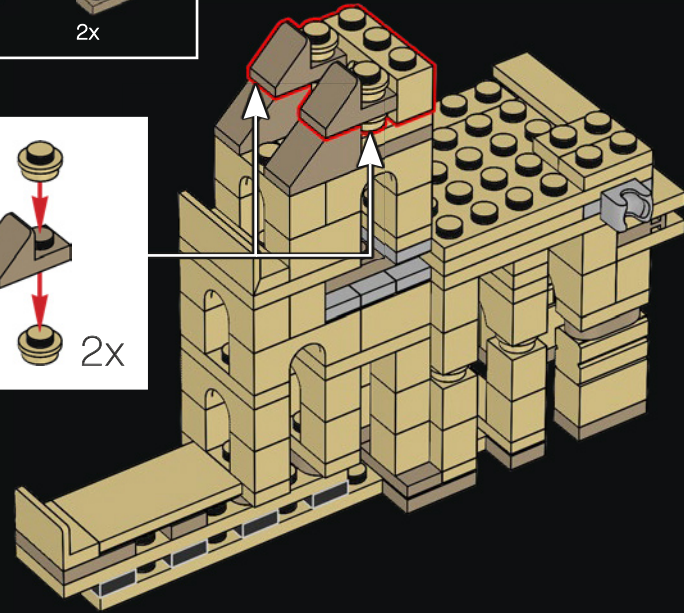
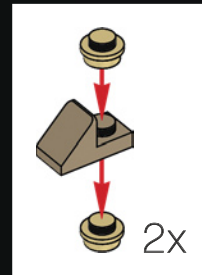

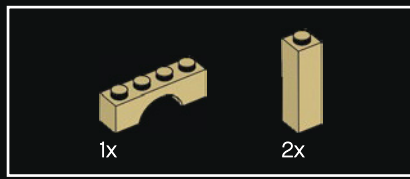

506

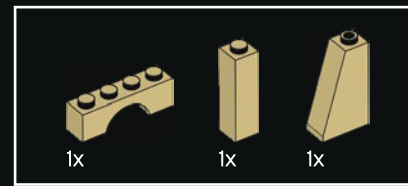
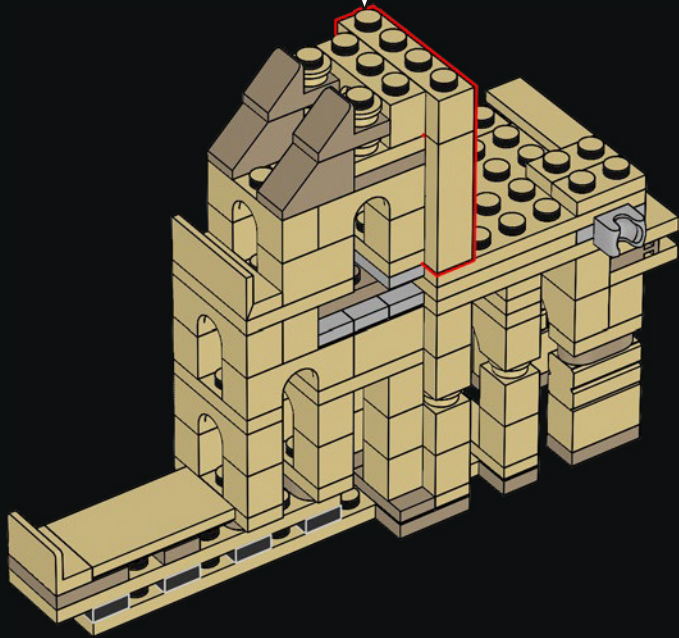
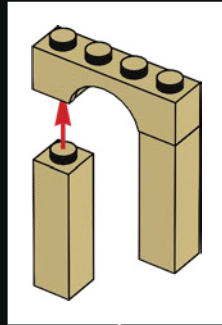

507

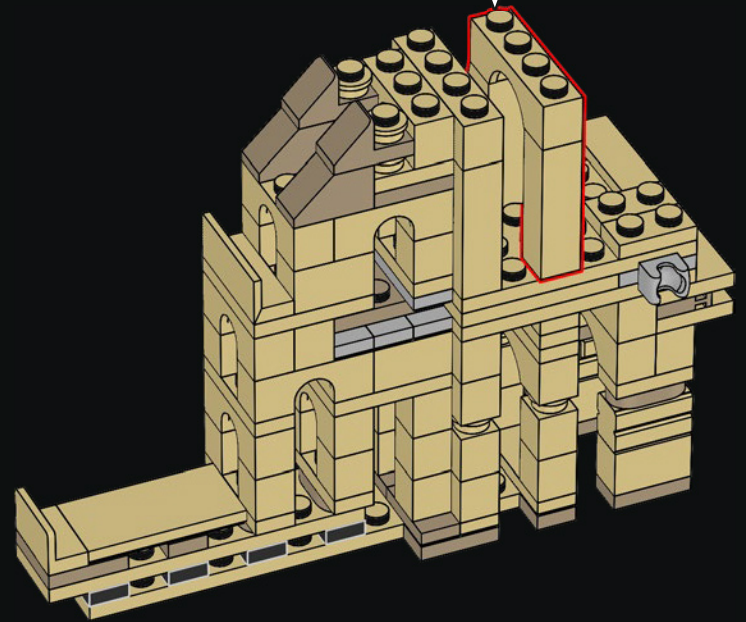
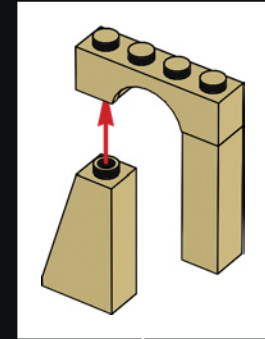

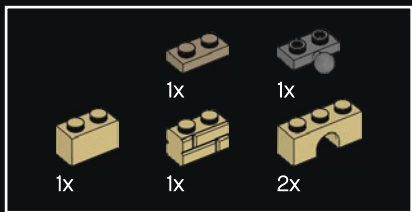

508

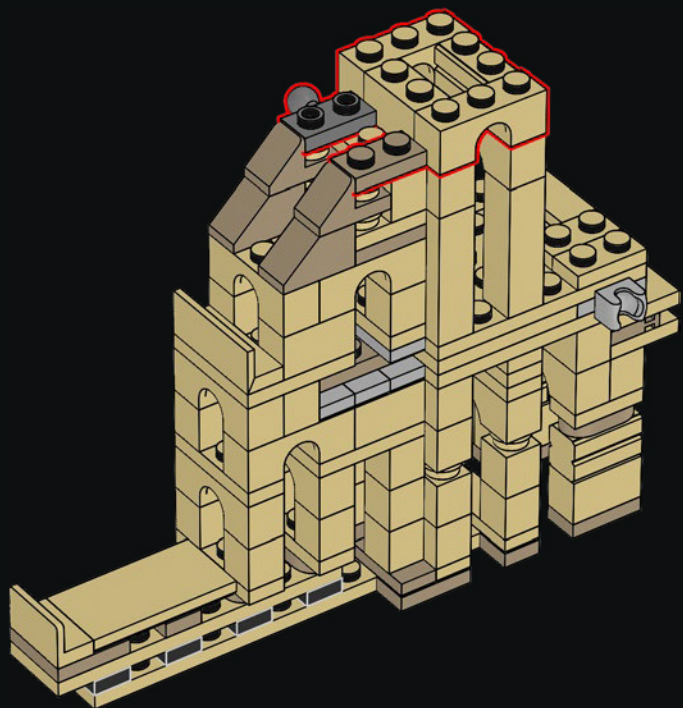

509

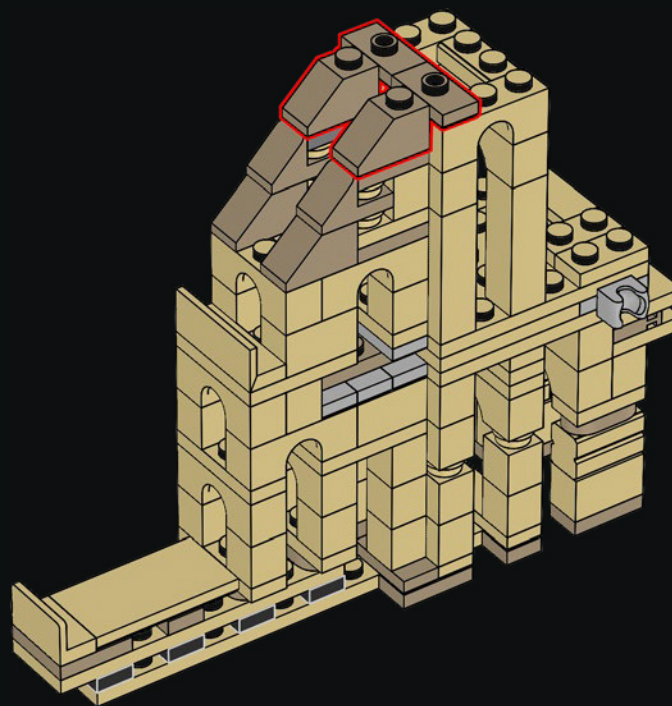



510

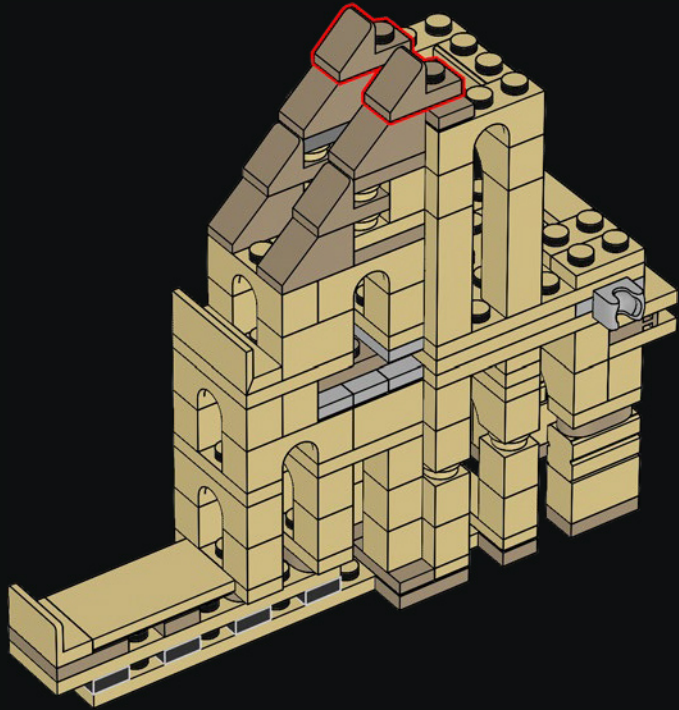

511

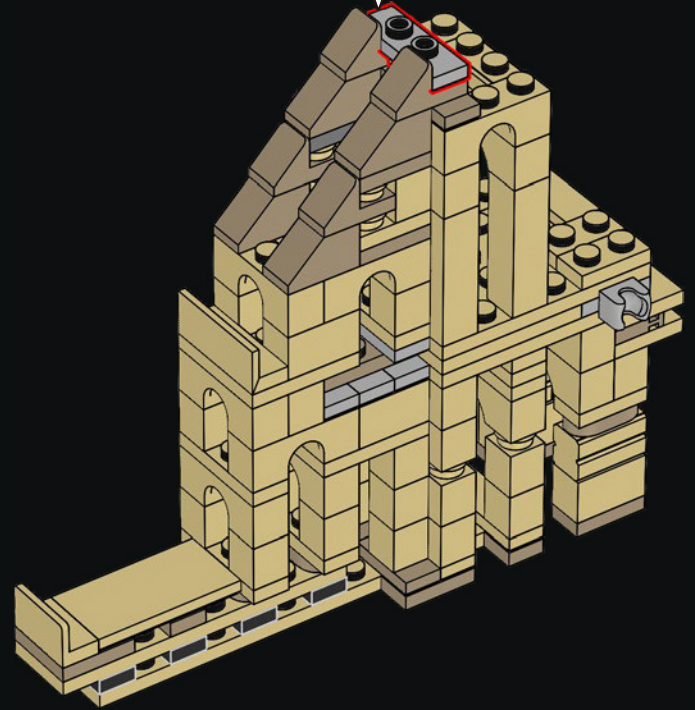
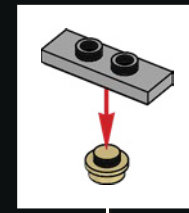

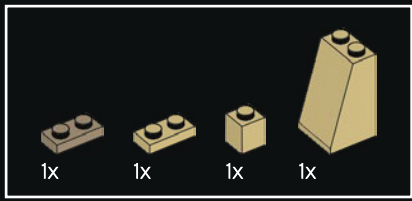

512

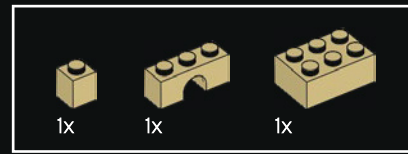
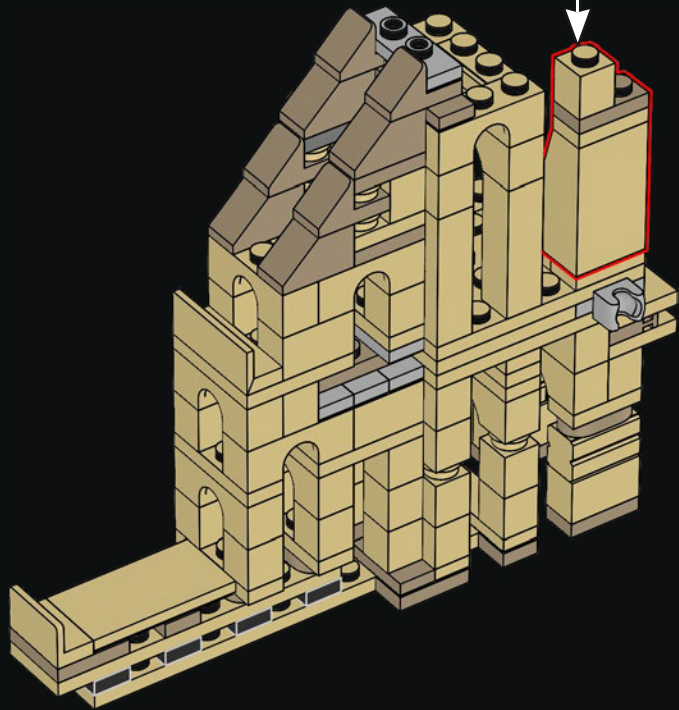
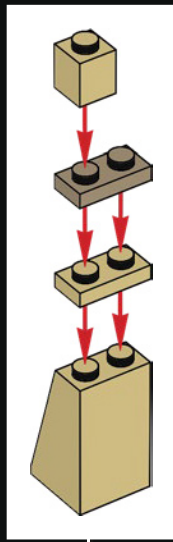

513

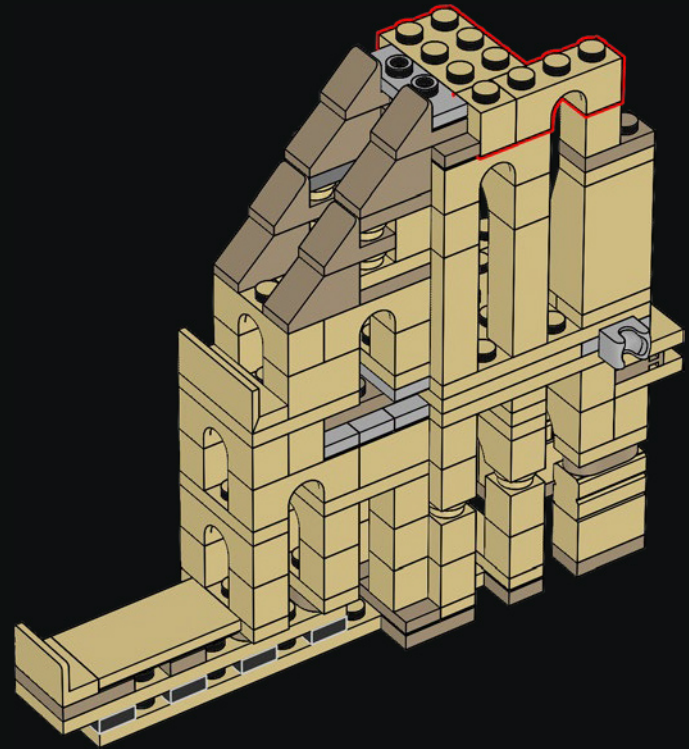



514

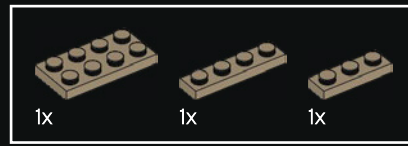
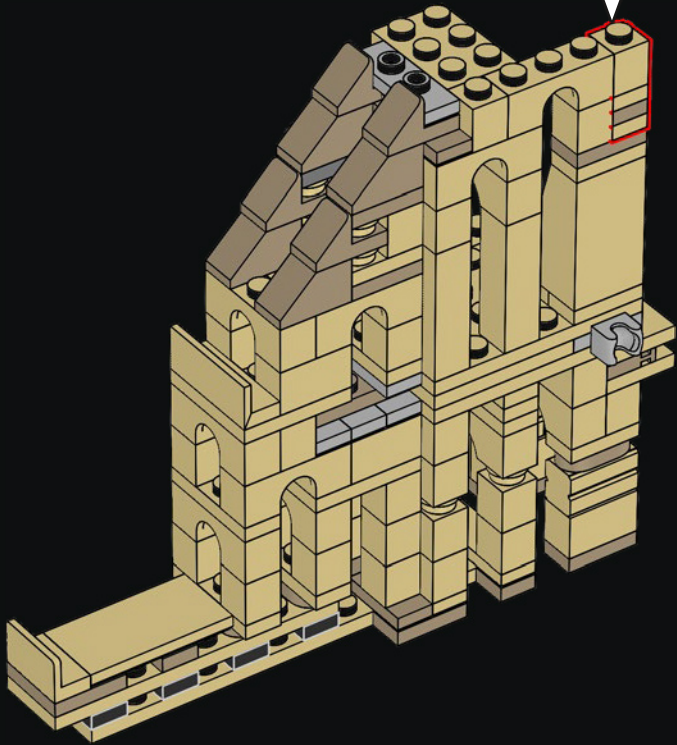
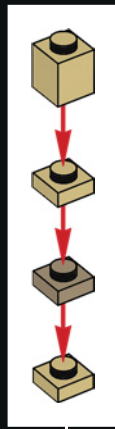

515

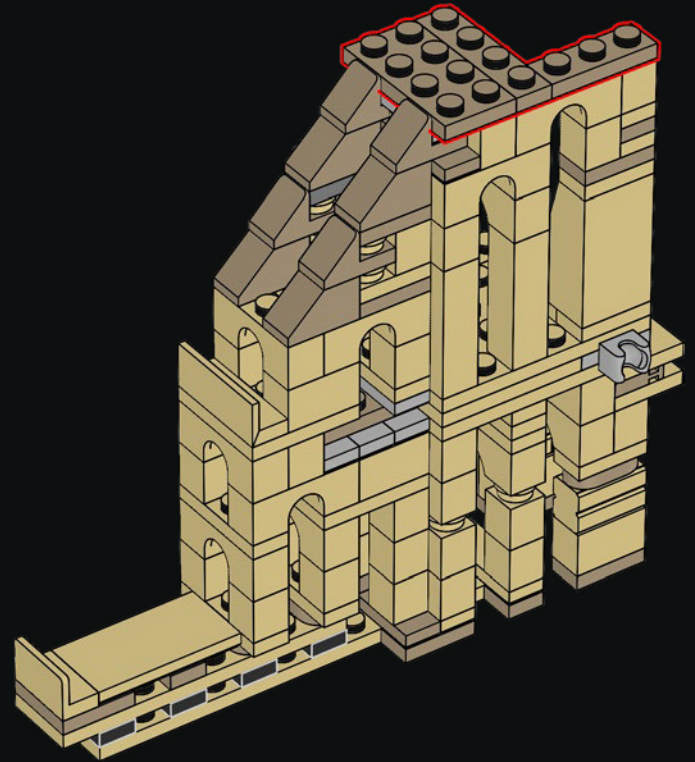

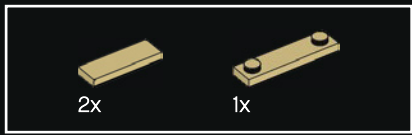

516

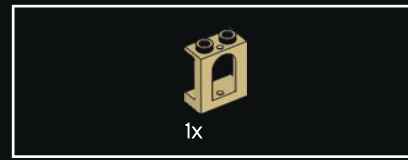
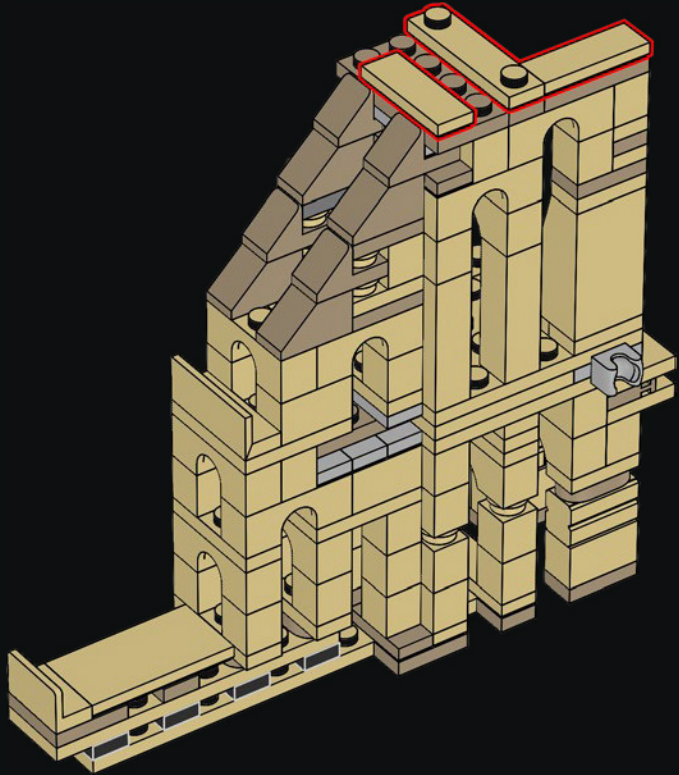

517

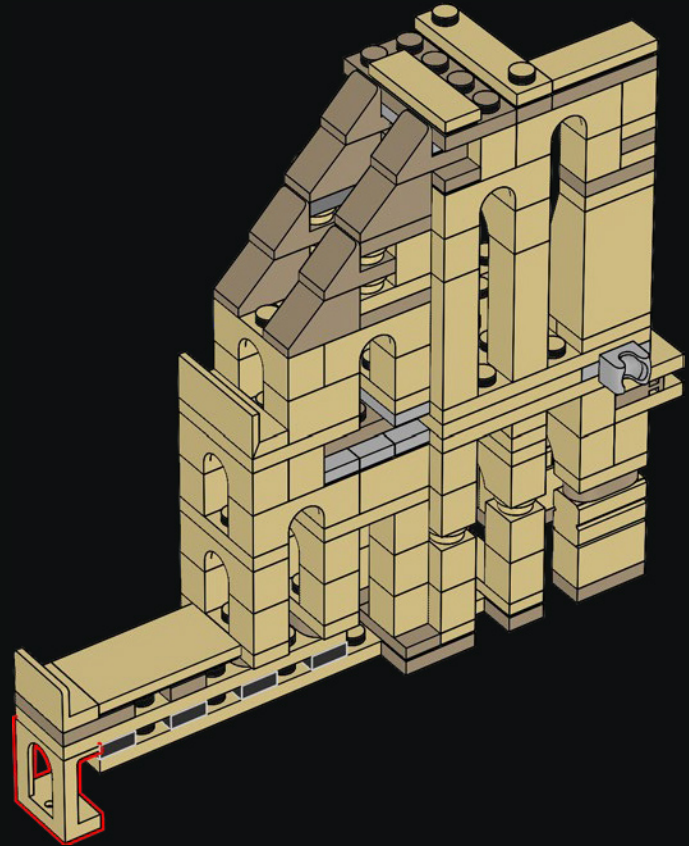

518

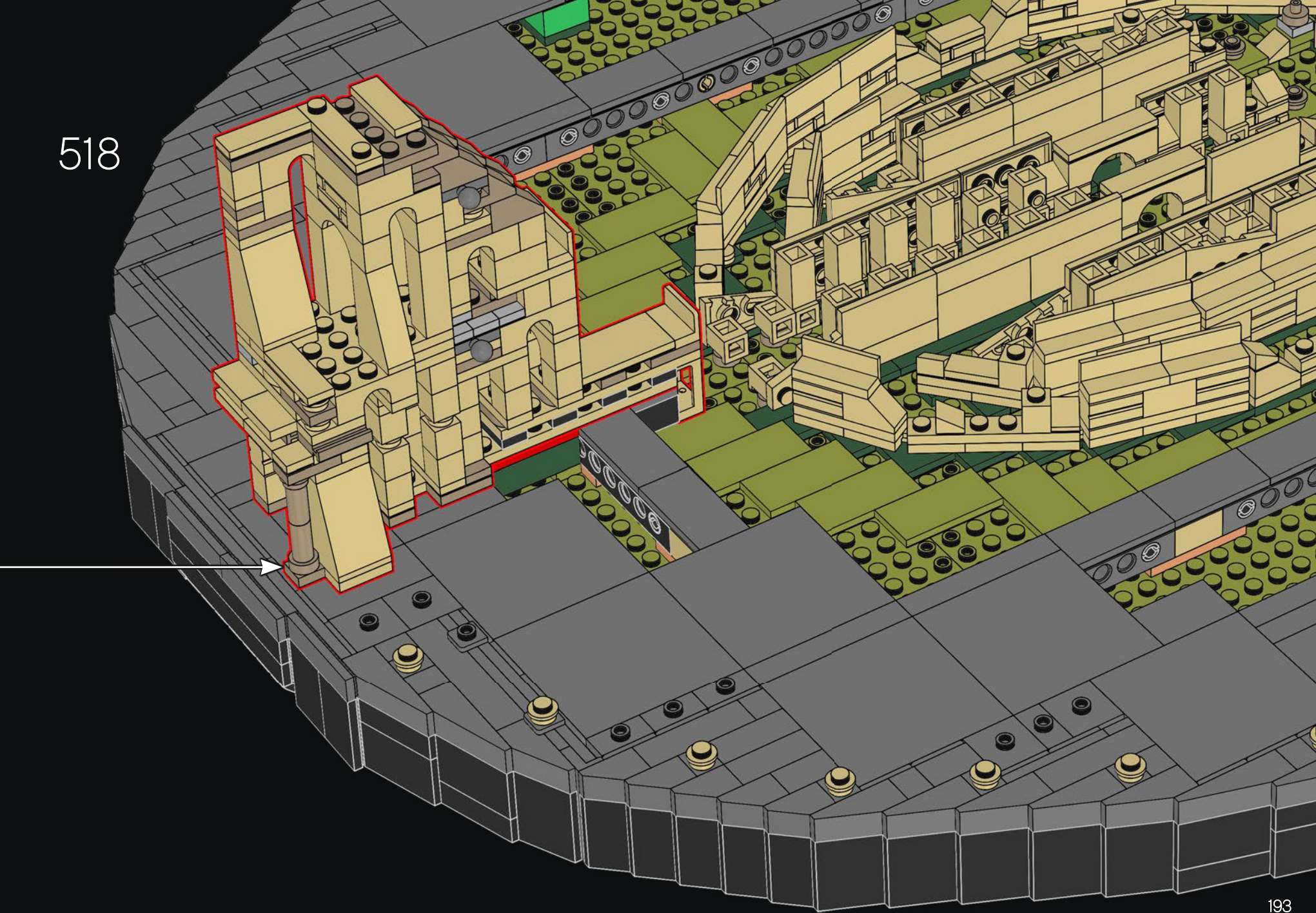

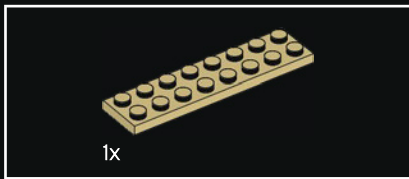
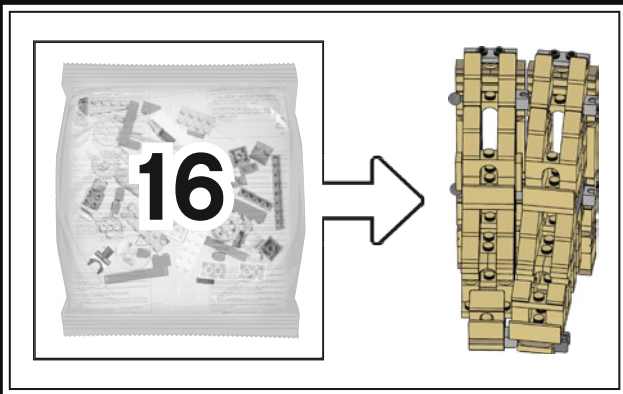

519

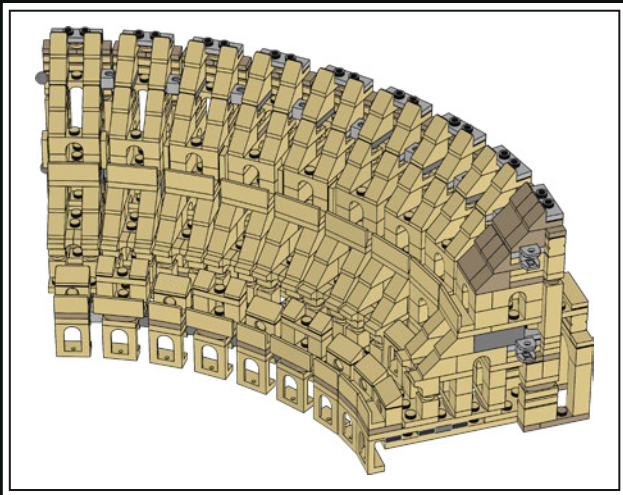
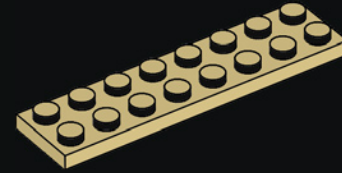

520

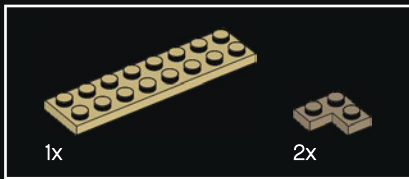
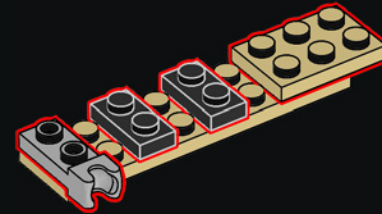

521

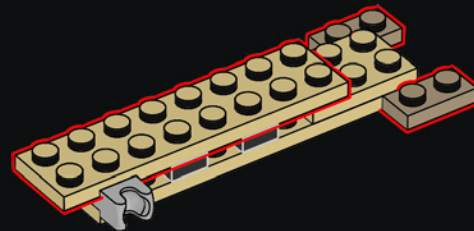

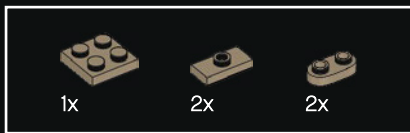

522

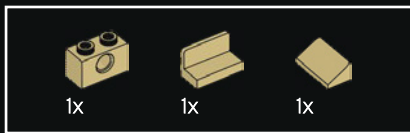
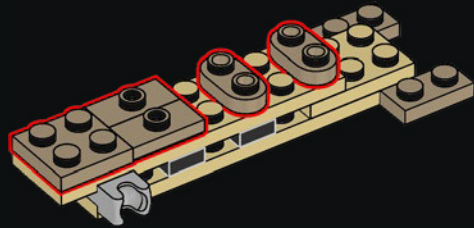

523

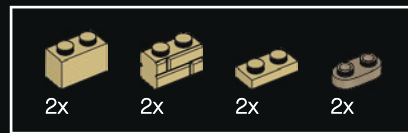
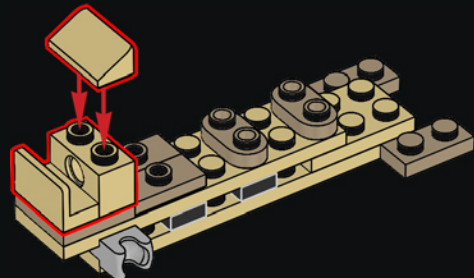

524

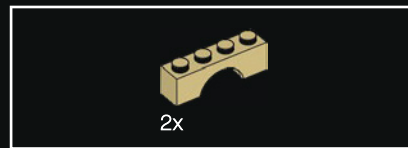
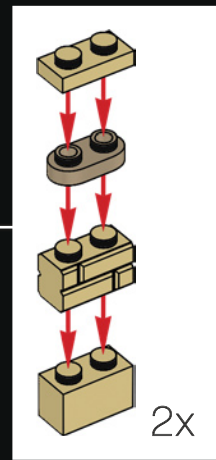
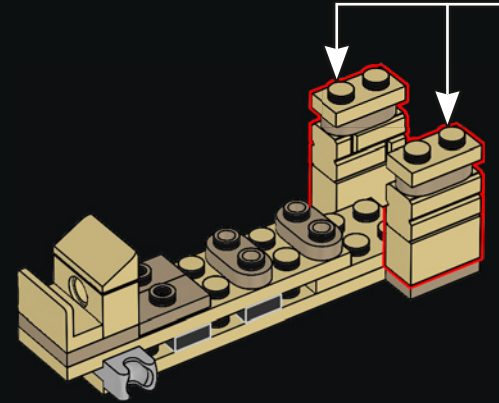

525

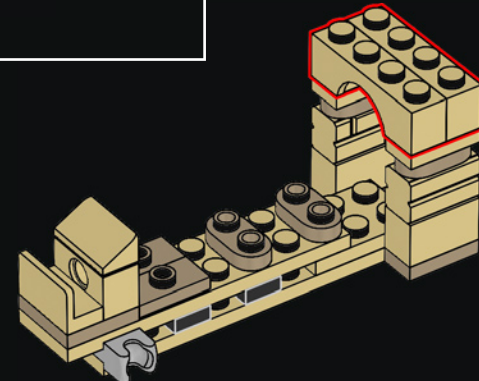



526

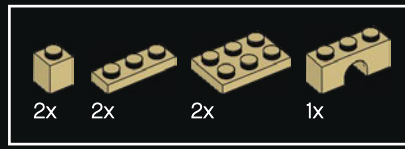
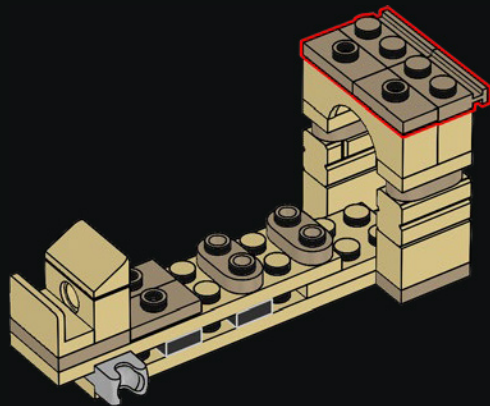

527

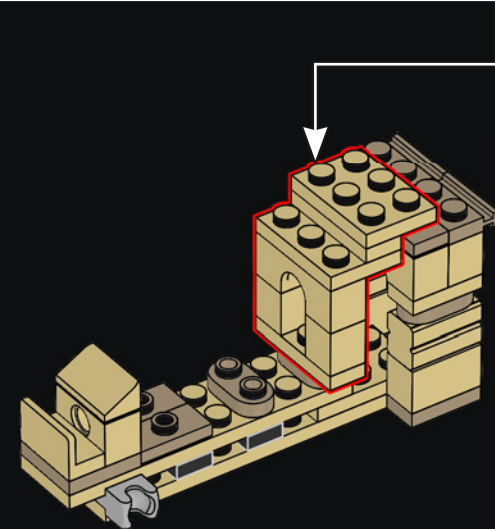
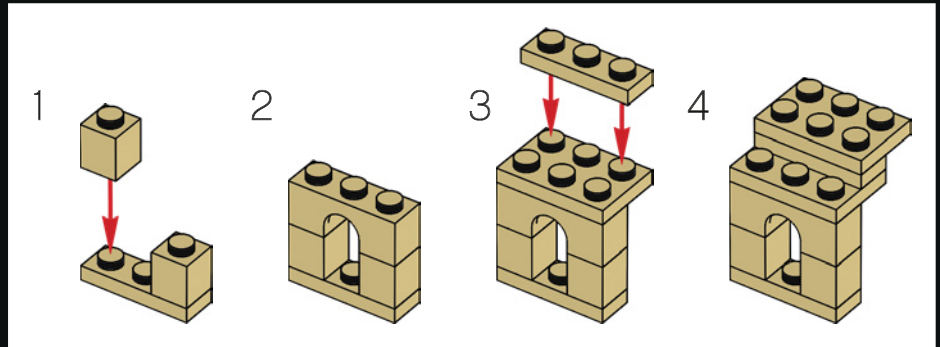

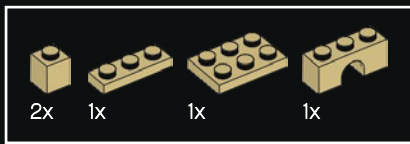

528

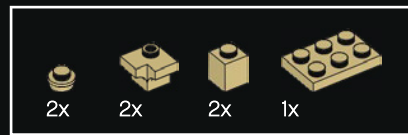
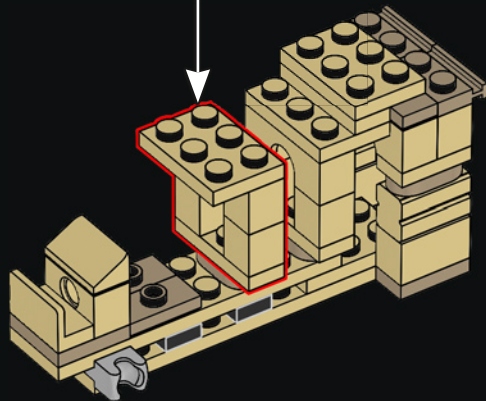
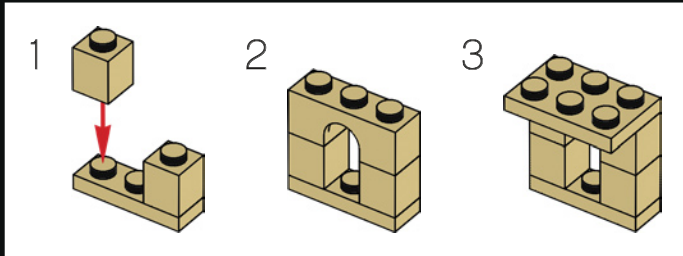

529

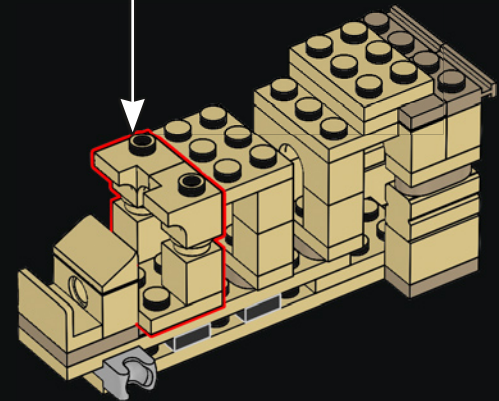
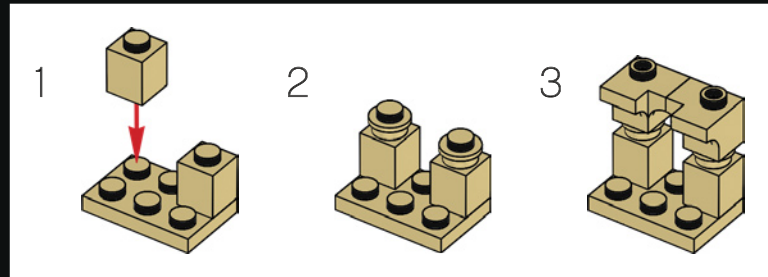

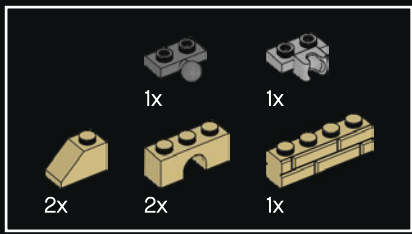

530

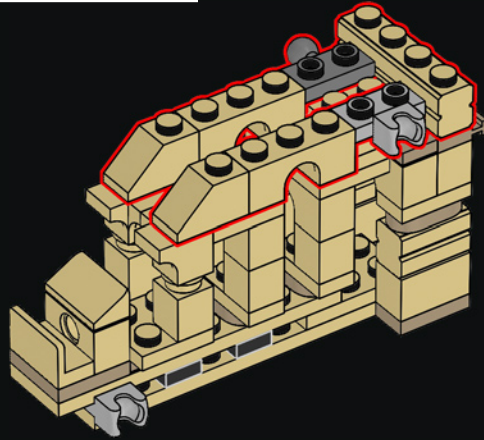

531

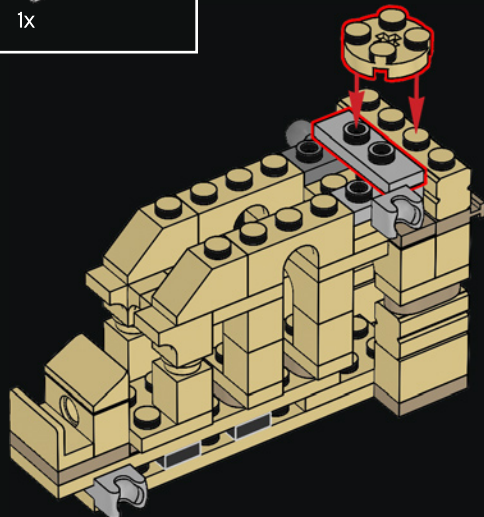

532

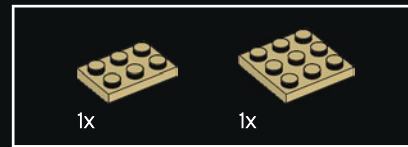
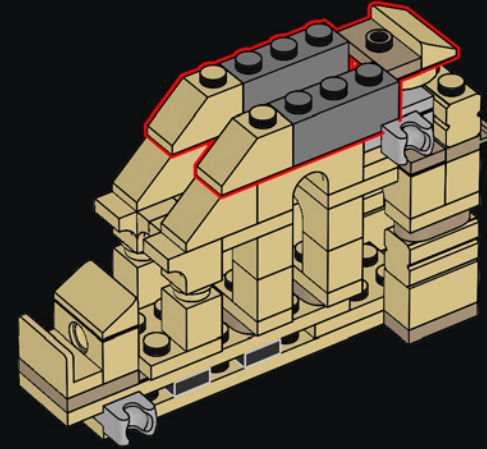

533

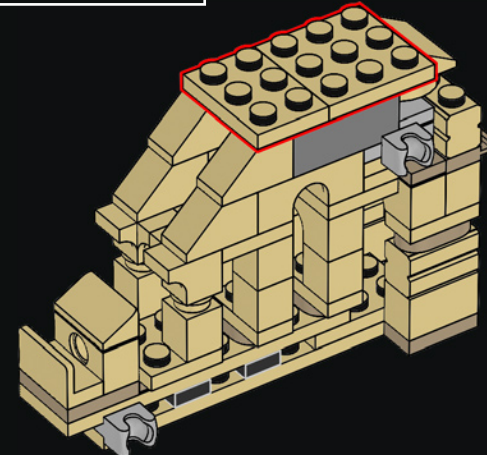



534

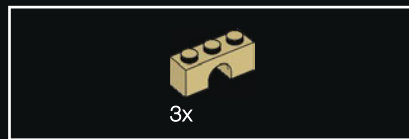
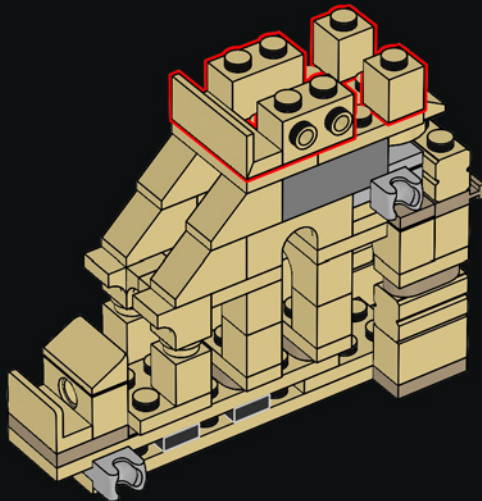

536

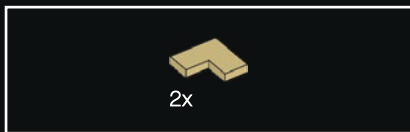
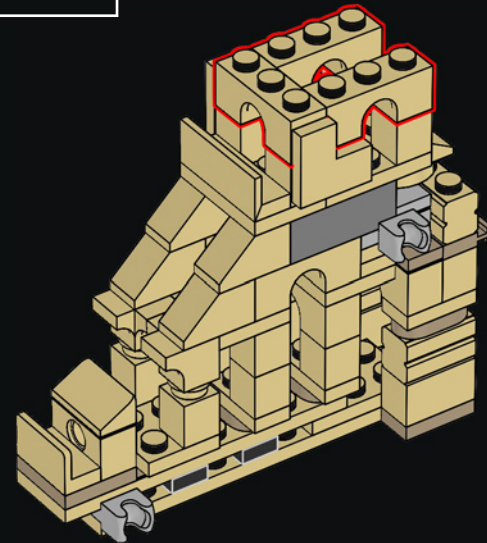

535

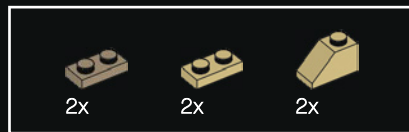
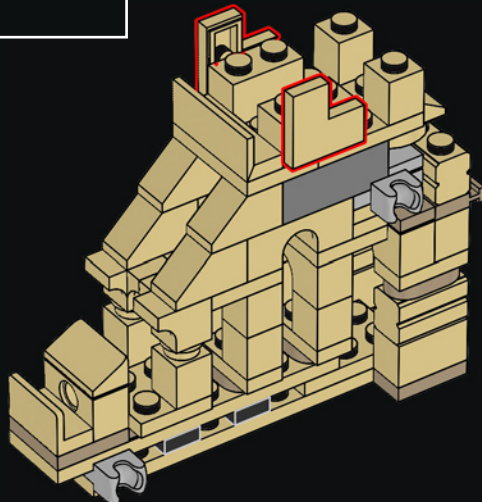

537

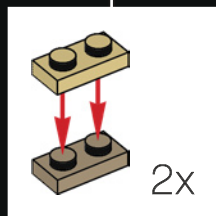
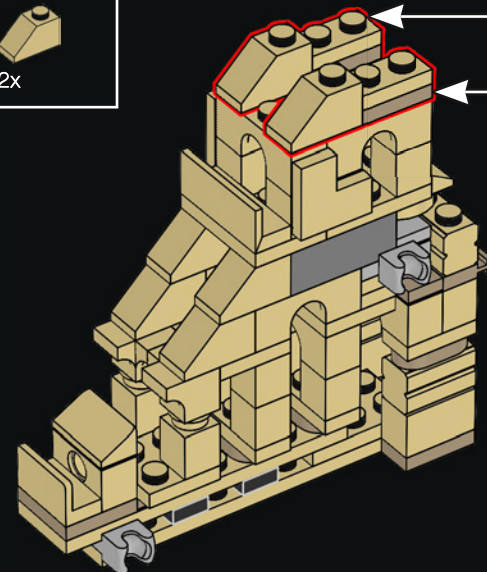

2x

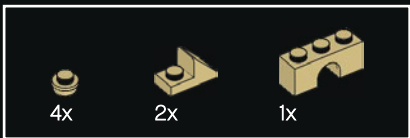

538

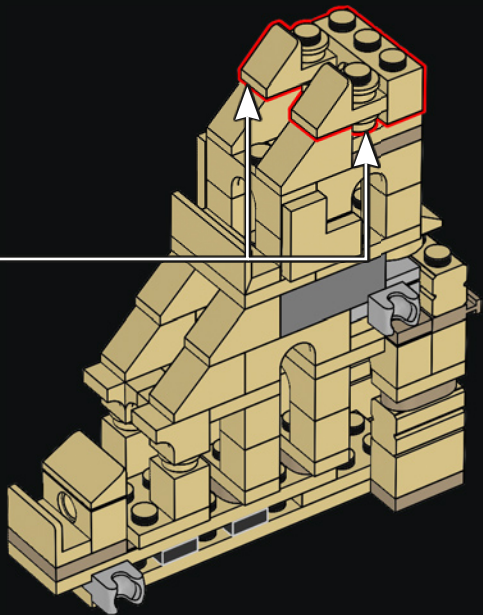
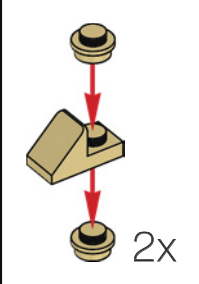

539

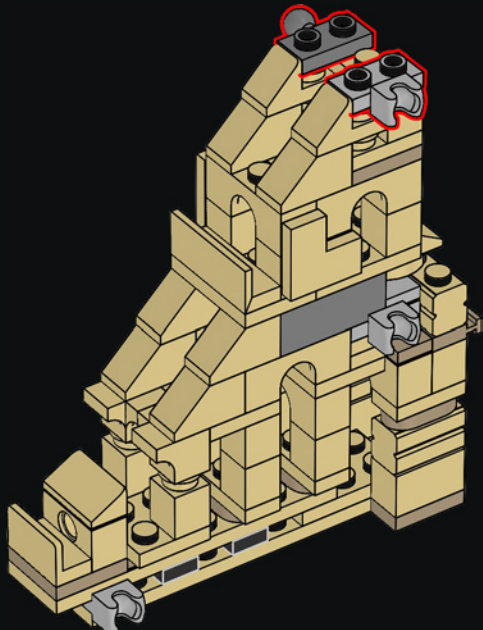

540

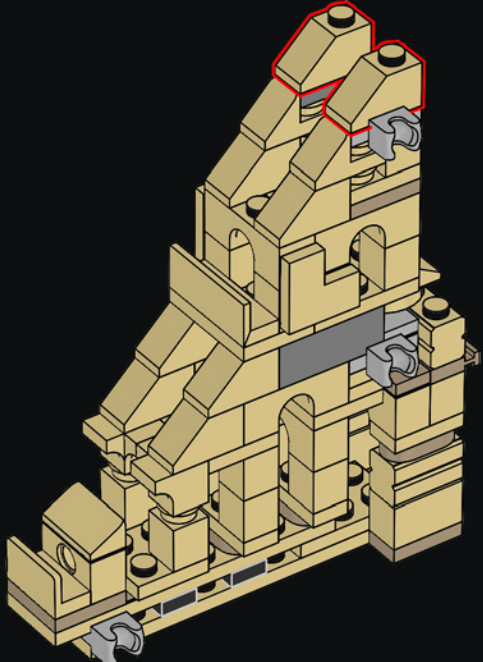

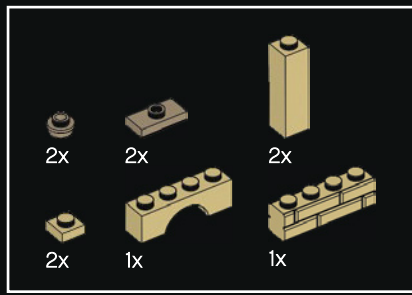

541

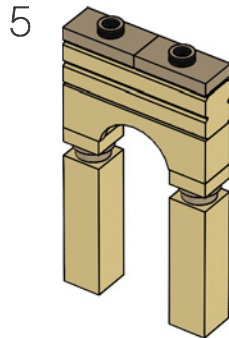
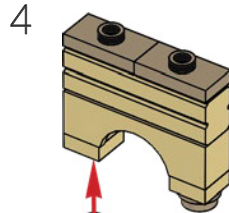
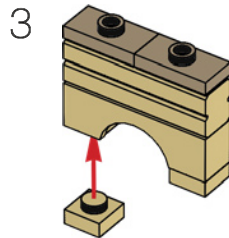
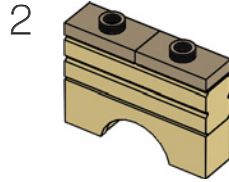
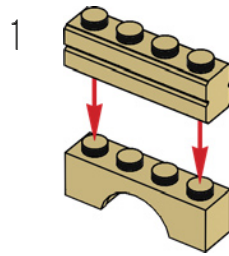
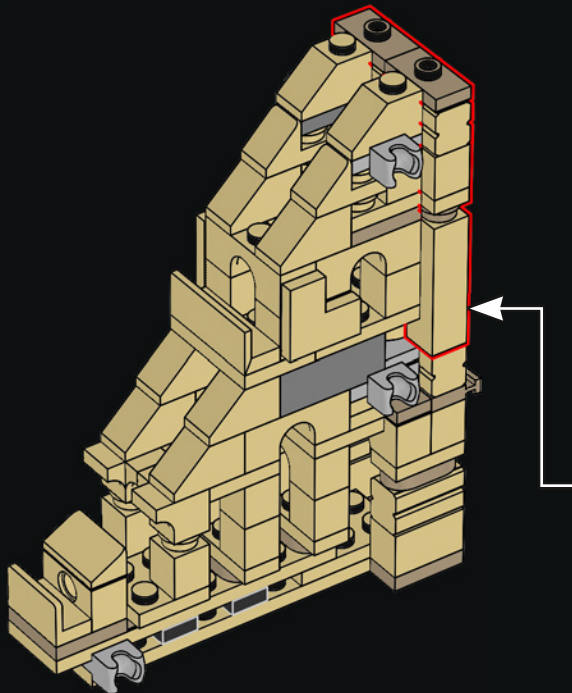

542

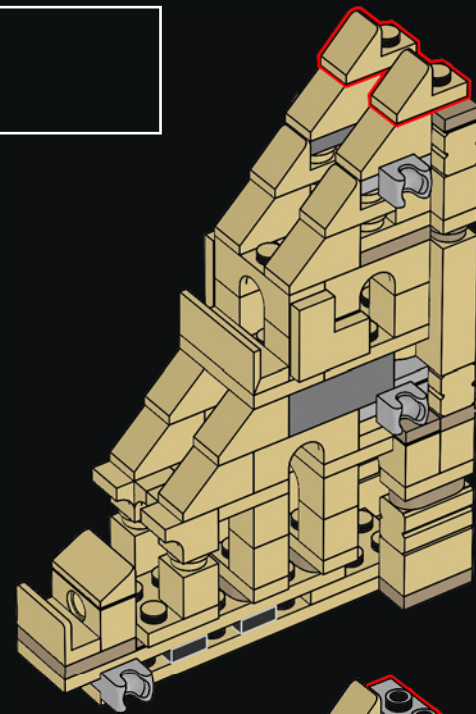

543

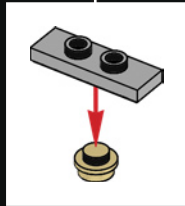
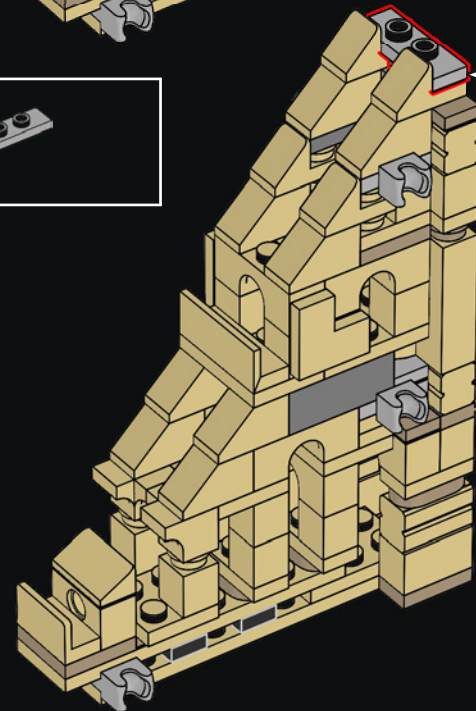

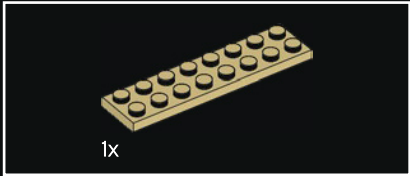
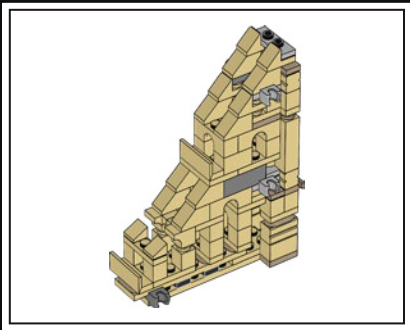

544

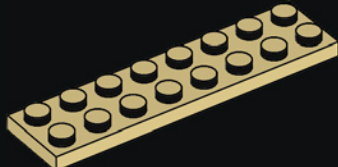

545

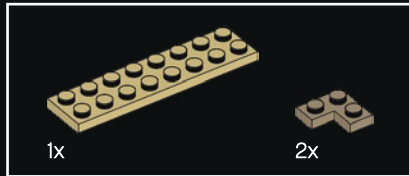
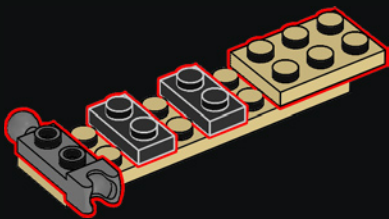

546

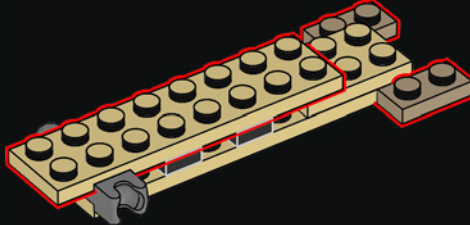

547

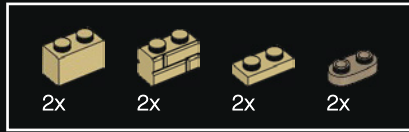
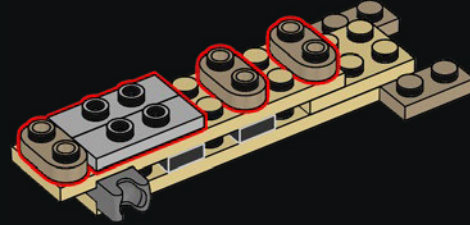

548

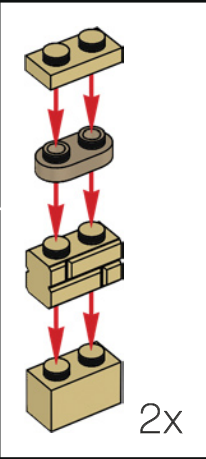
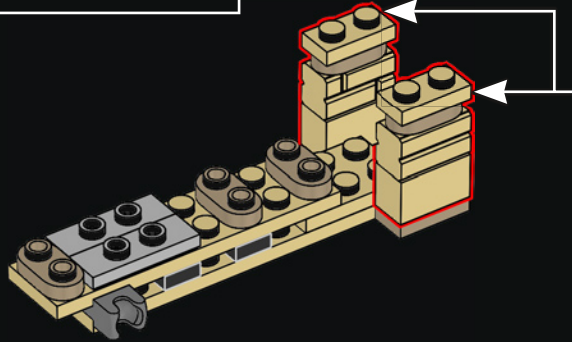



549

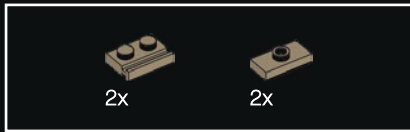
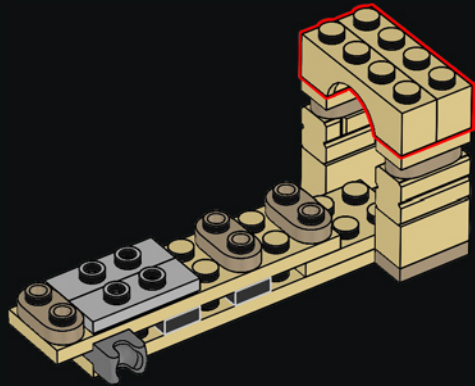

550

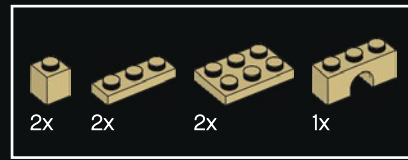
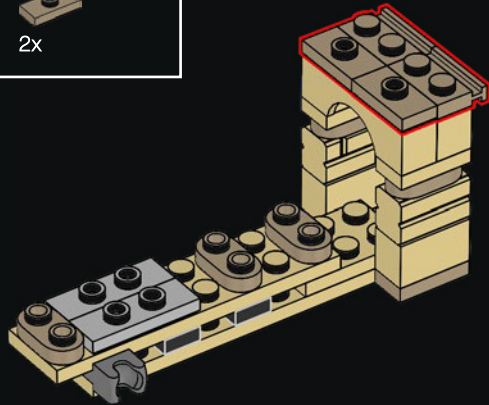

551

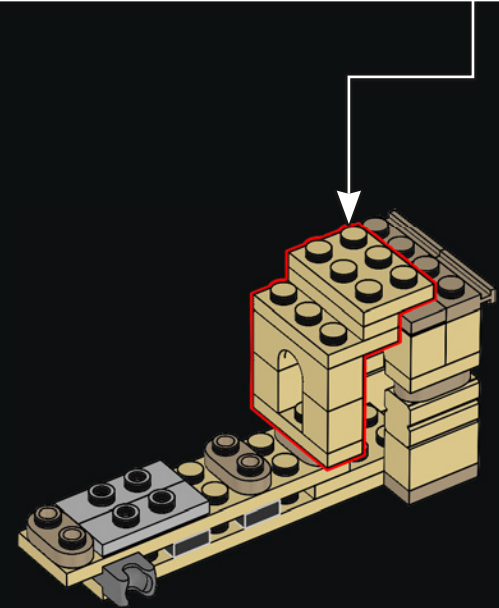
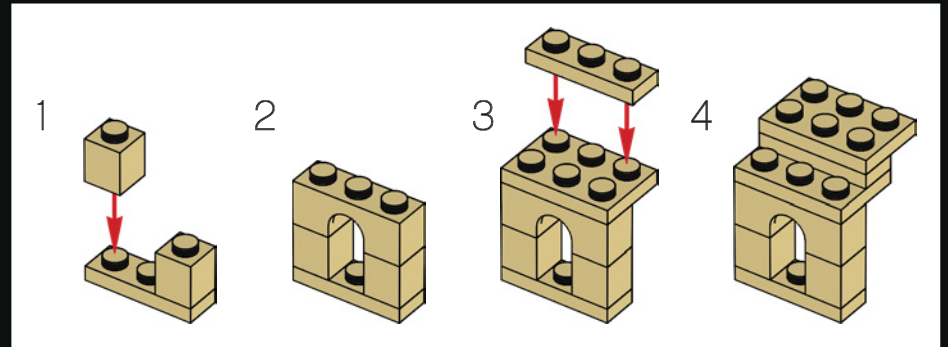

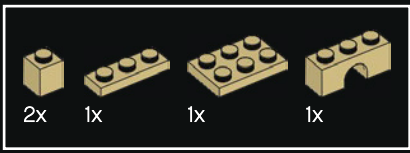

552

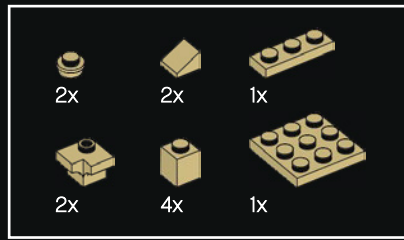
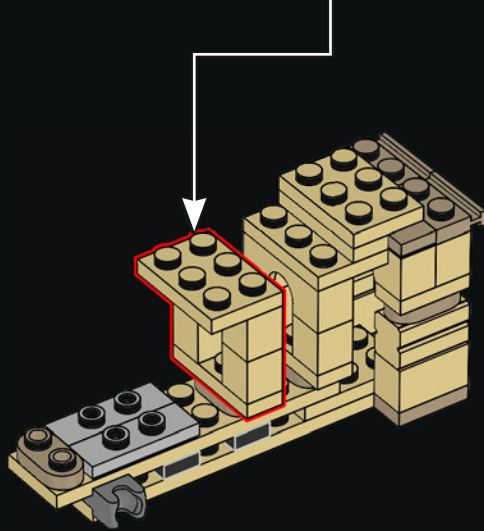
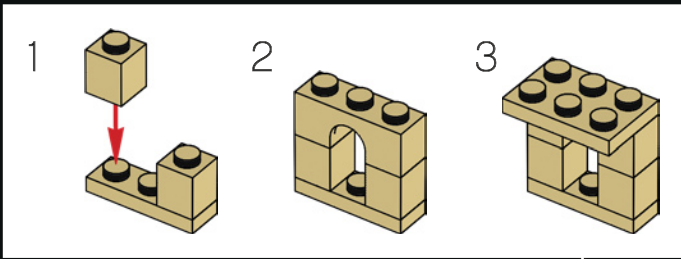

553

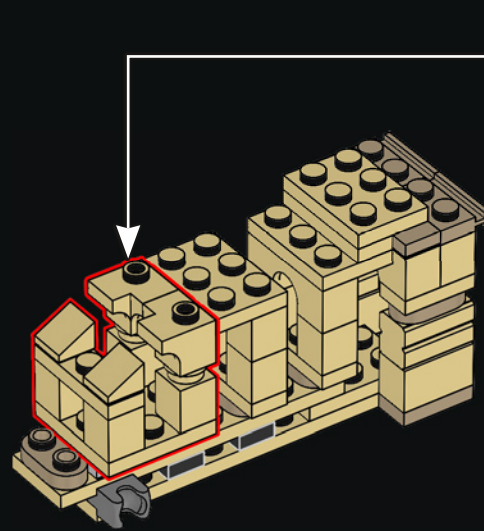
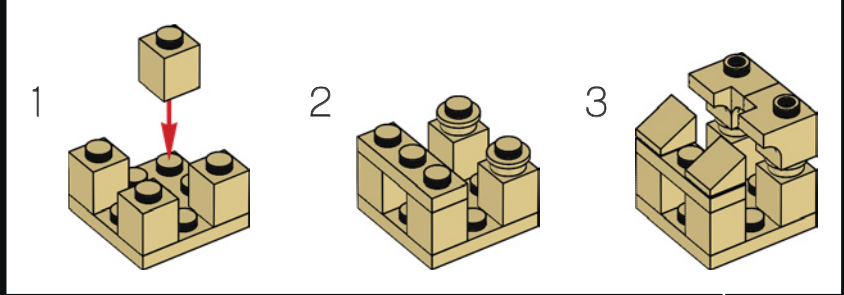

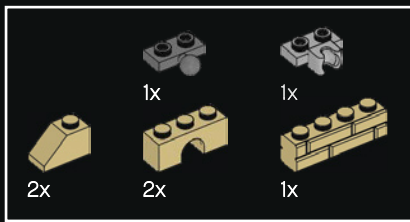

554

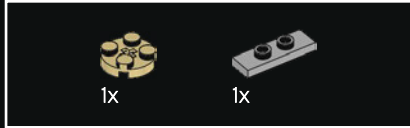
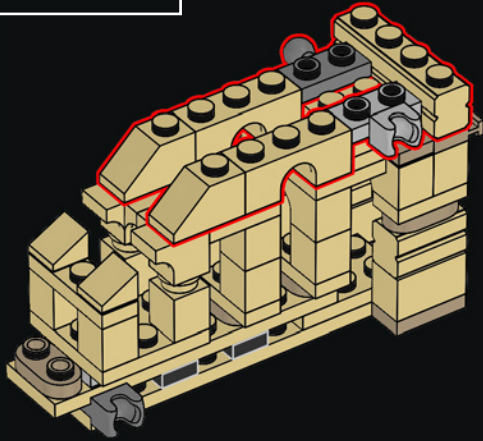

555

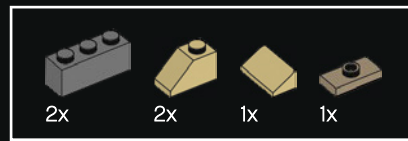
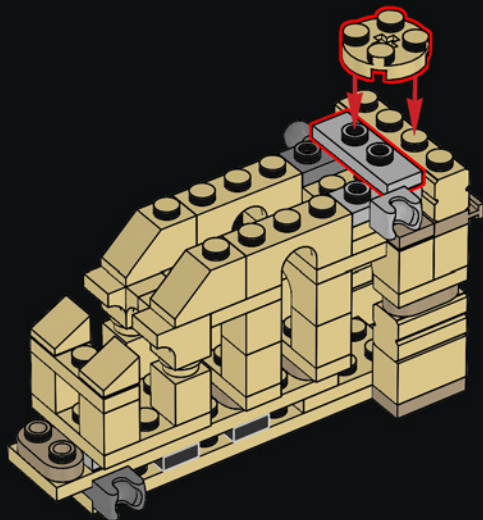

556

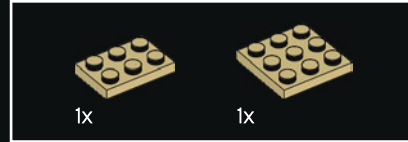
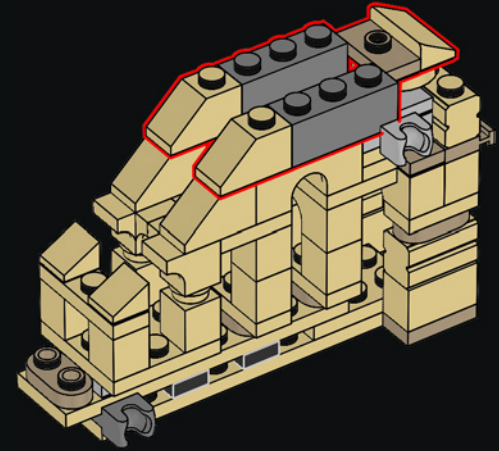

557

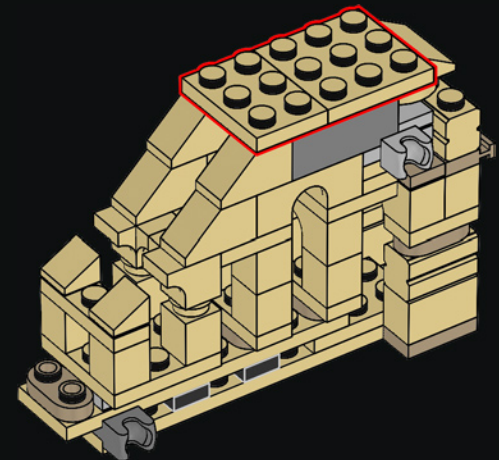

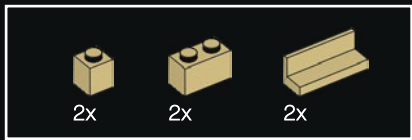

558

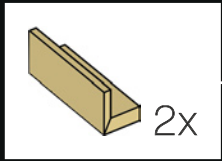
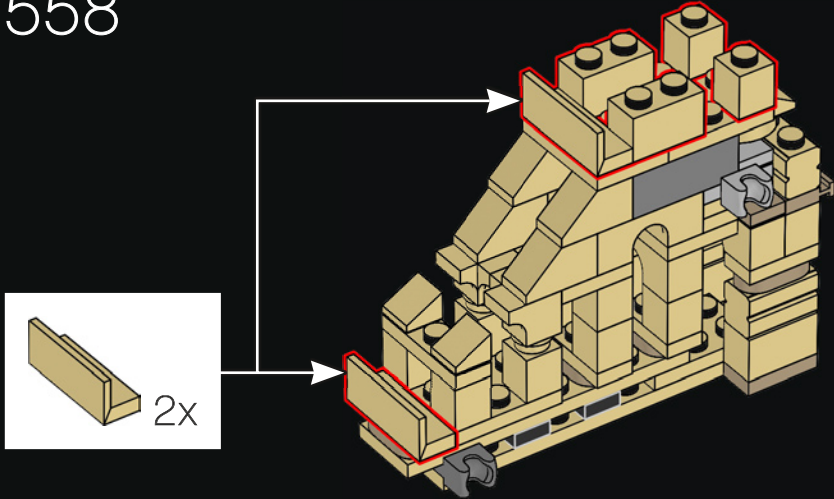

559

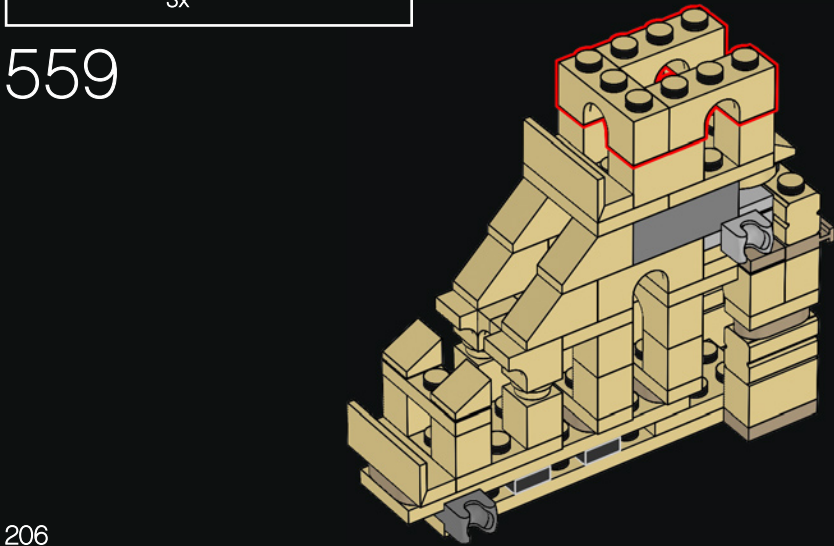

560

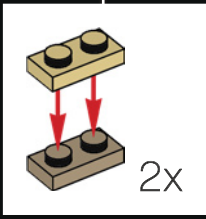
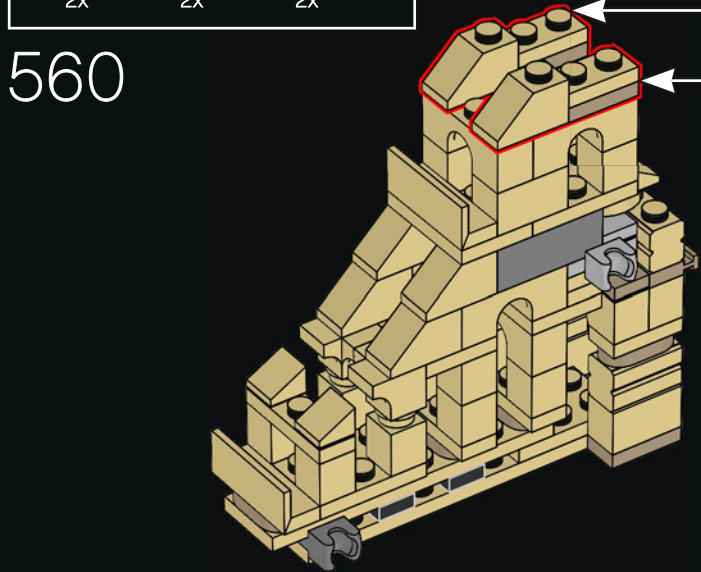

561

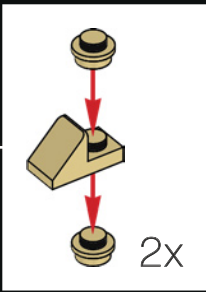
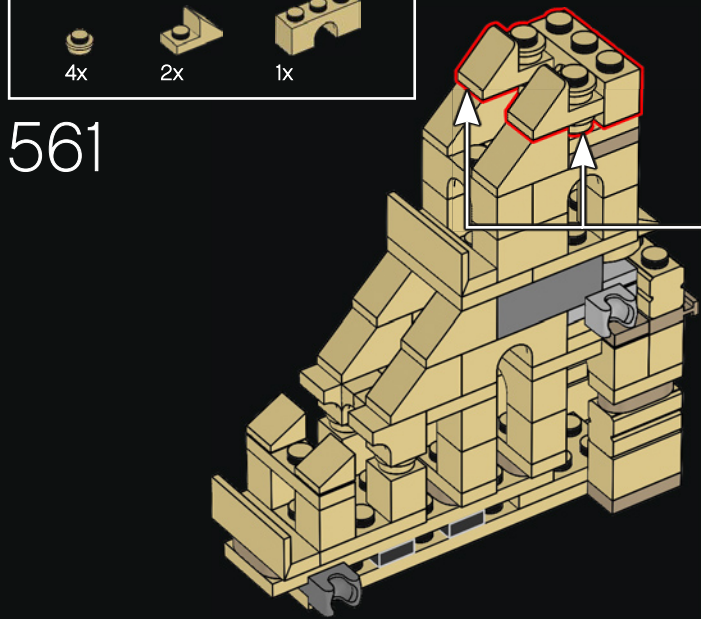



562

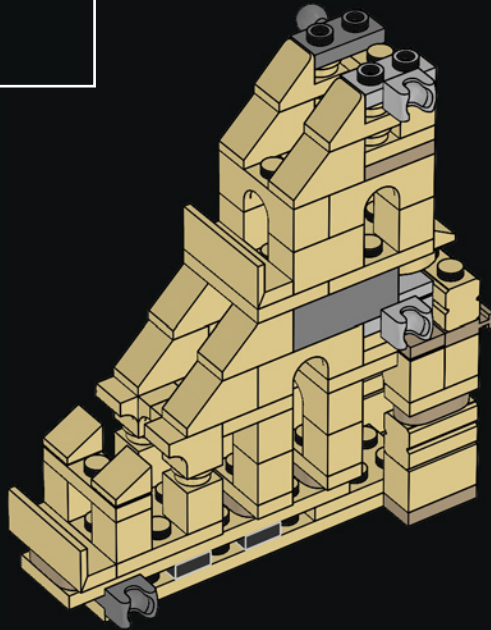

563

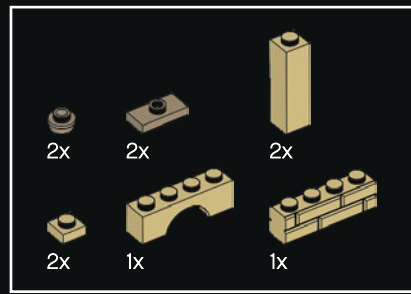
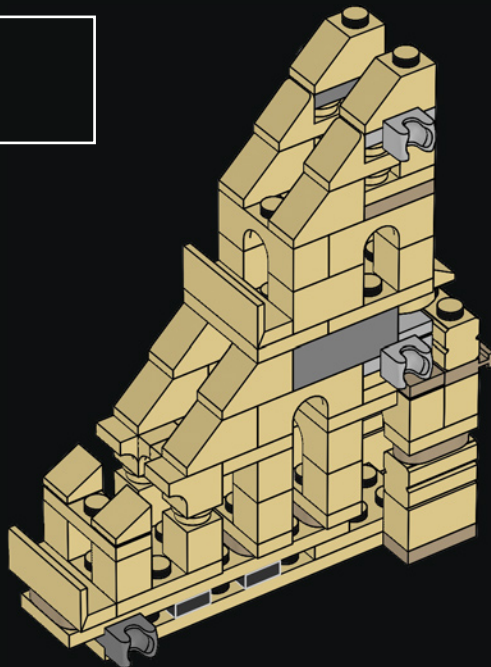

564

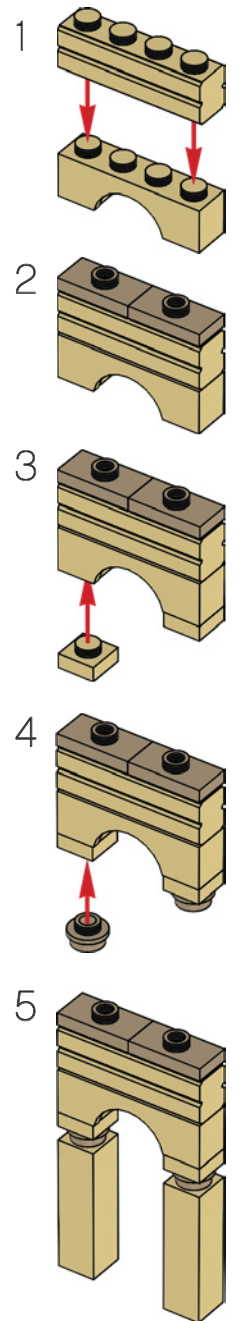
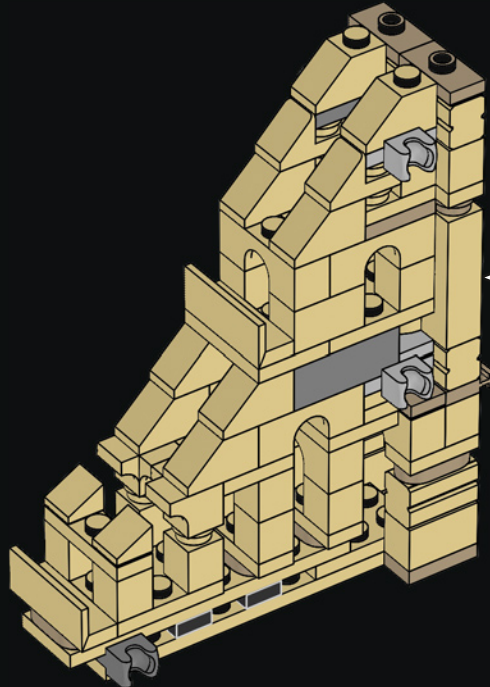



2x

565

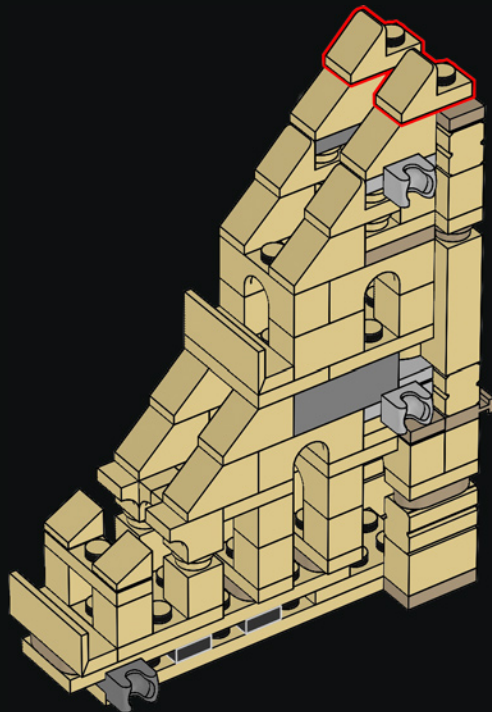

1x



1x

566

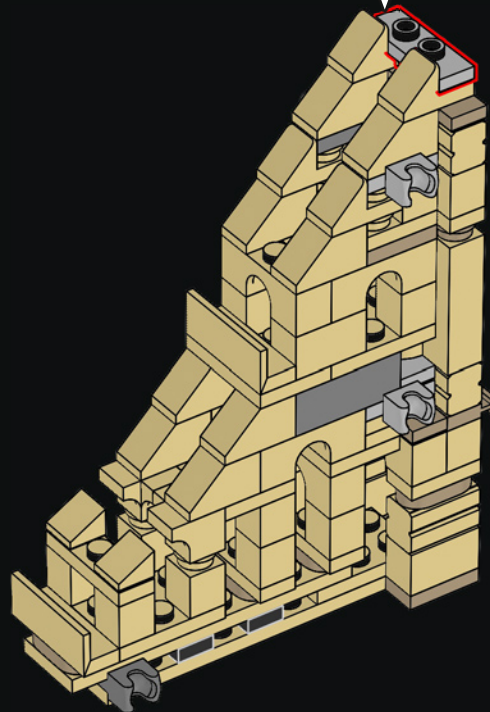
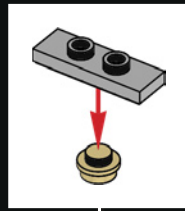

567



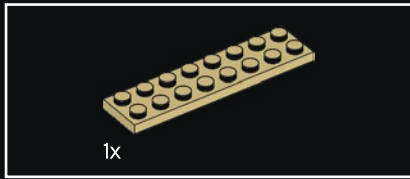
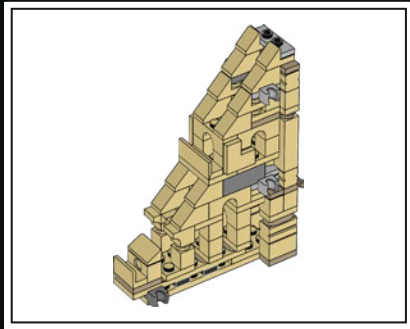
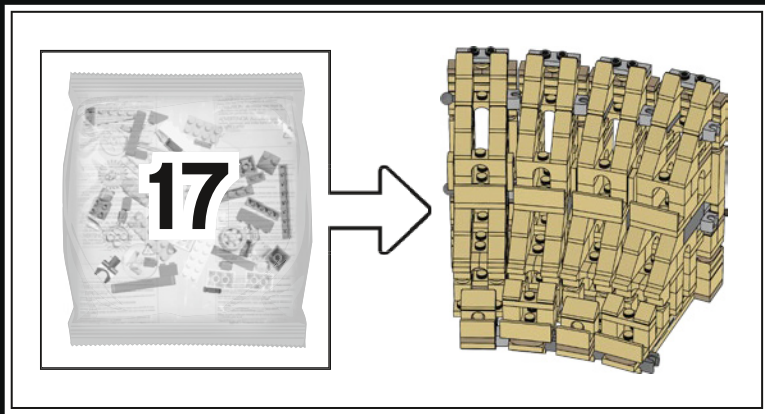

568

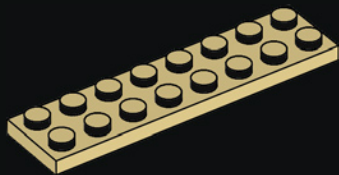

569

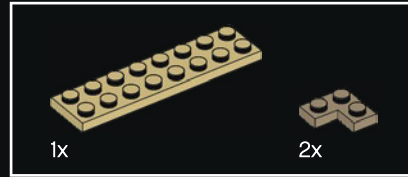
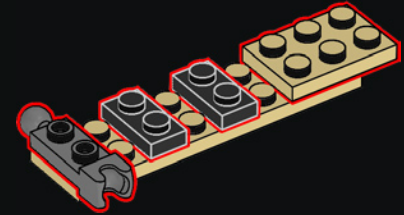

570

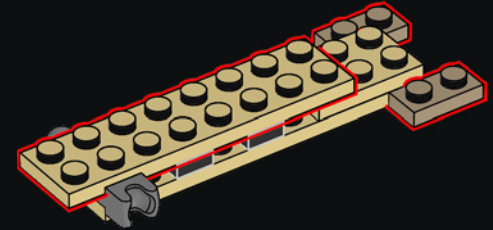

571

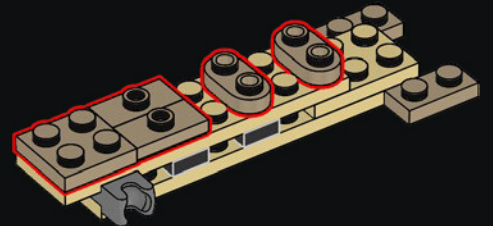

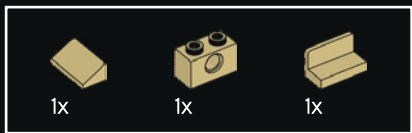

572

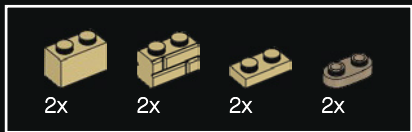
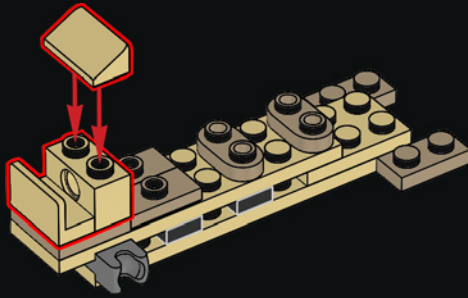

573

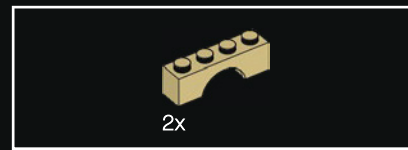
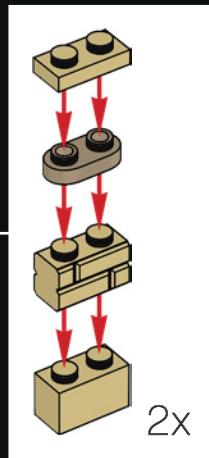
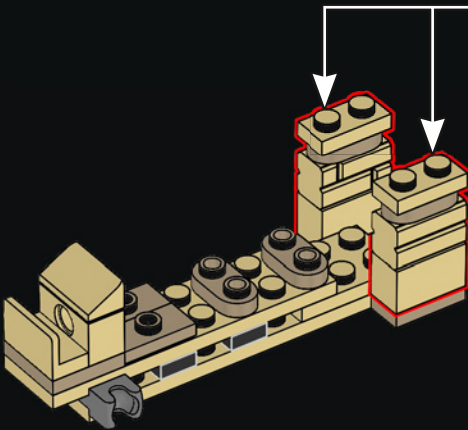

574

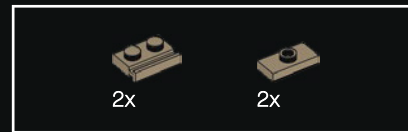
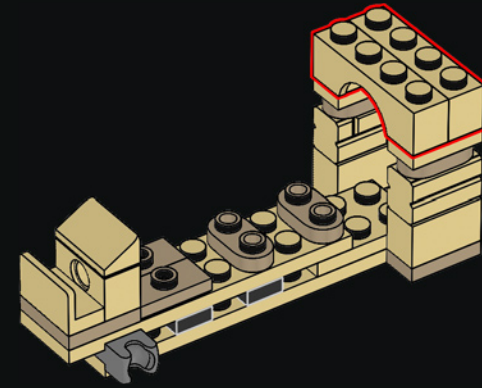

575

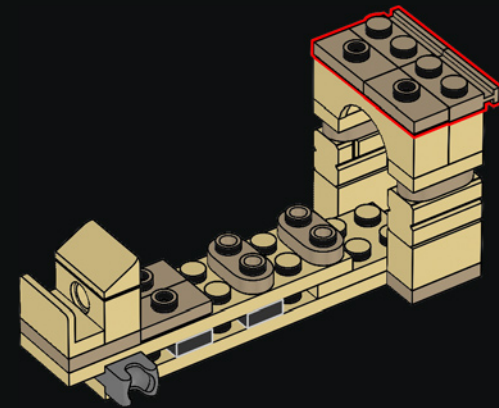

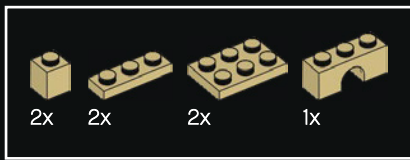

576

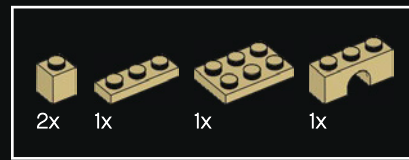
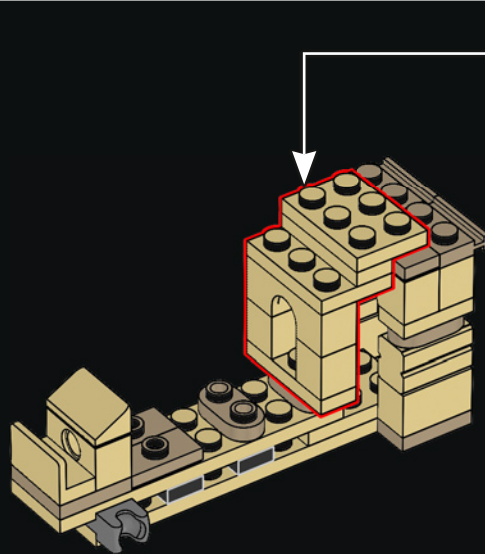
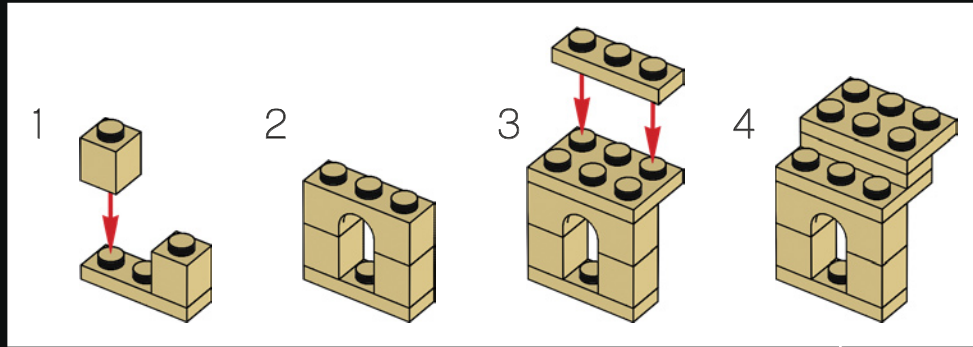

577

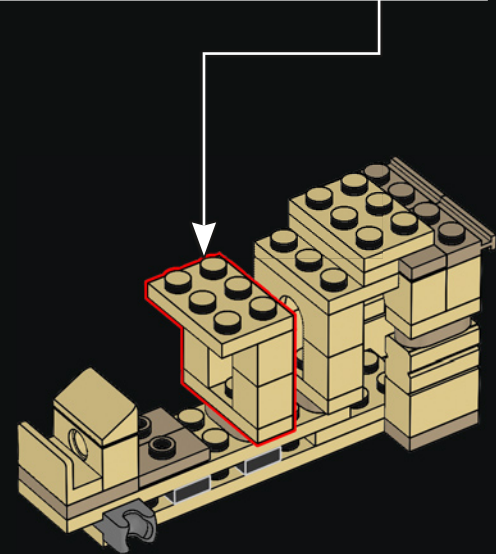
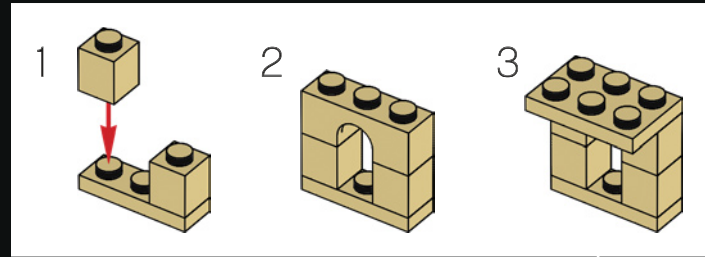



578

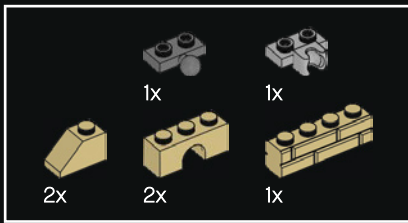
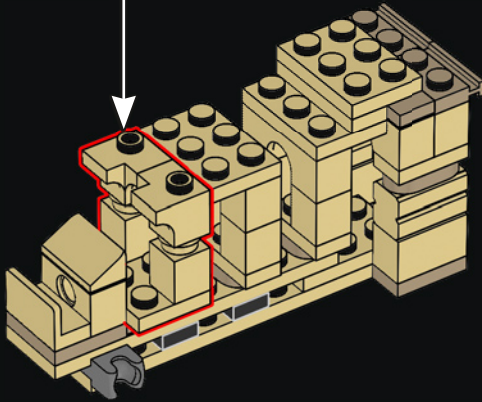
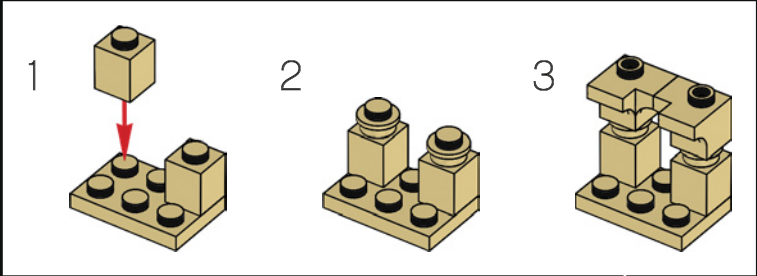

579

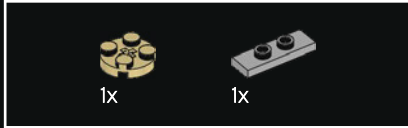
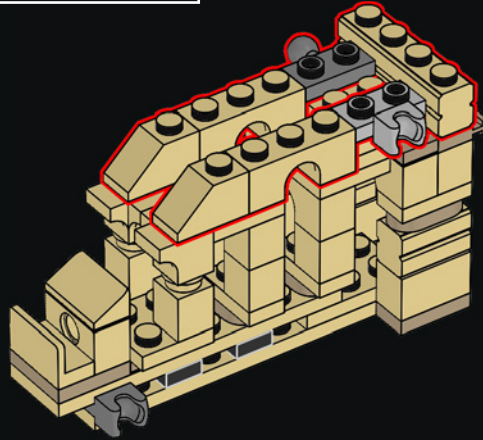

580

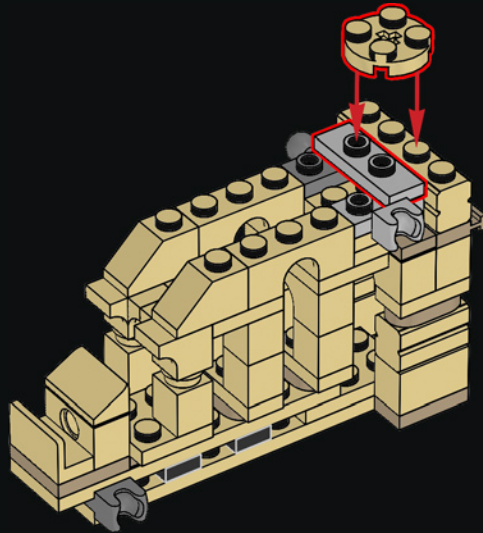



581

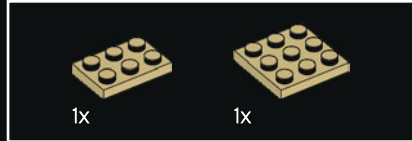
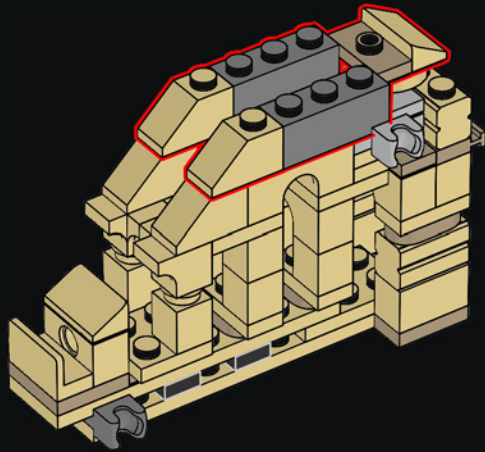

582

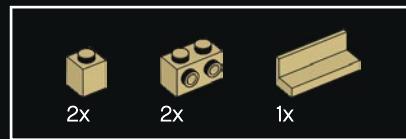
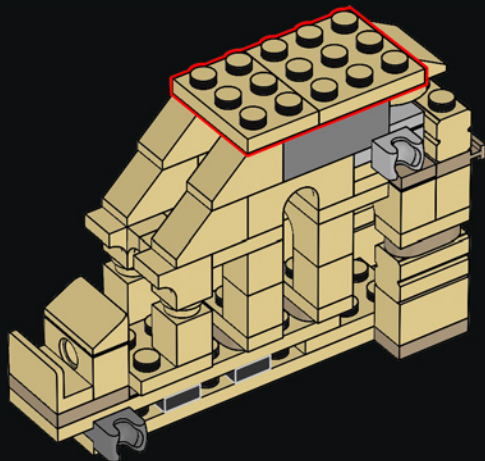

583

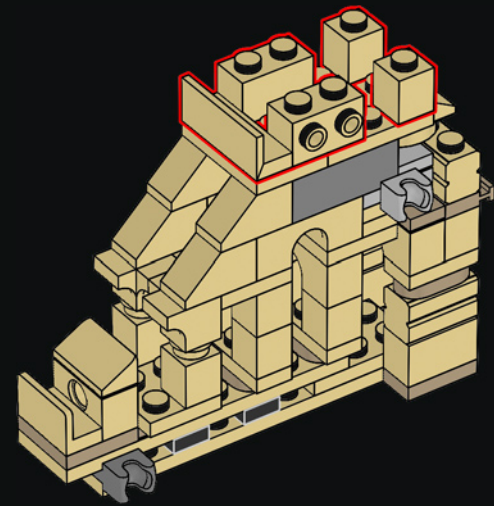

584

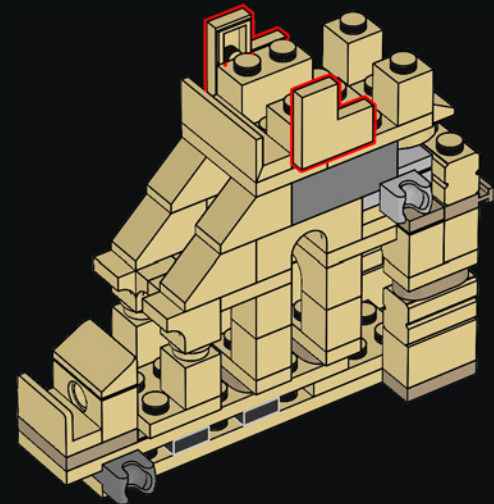

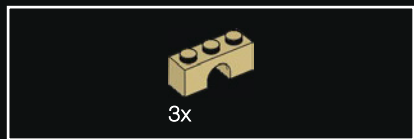

585

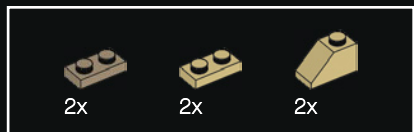
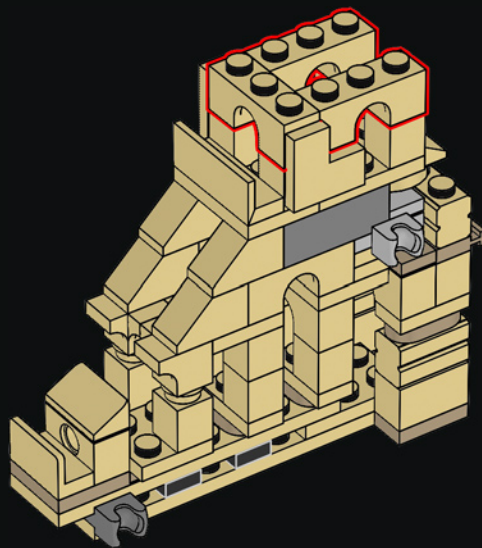

586

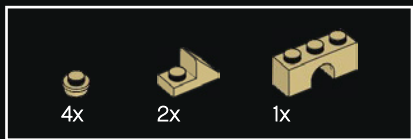
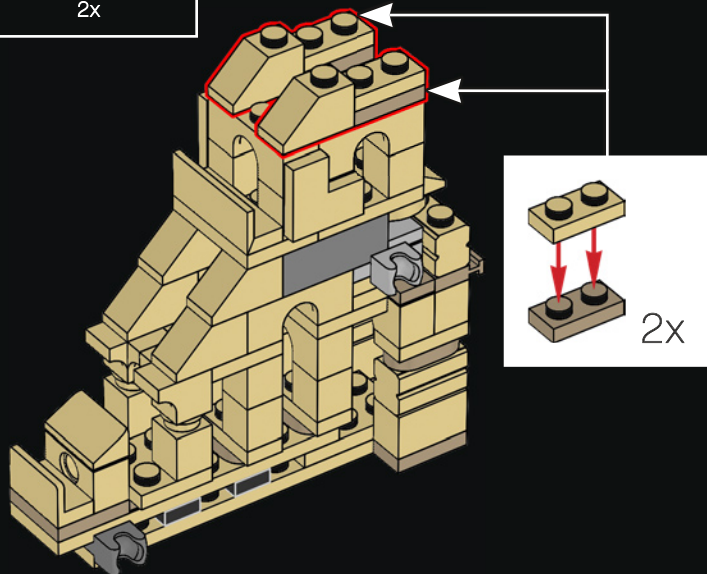

587

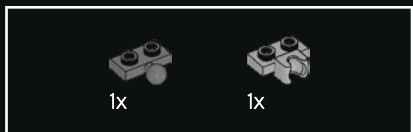
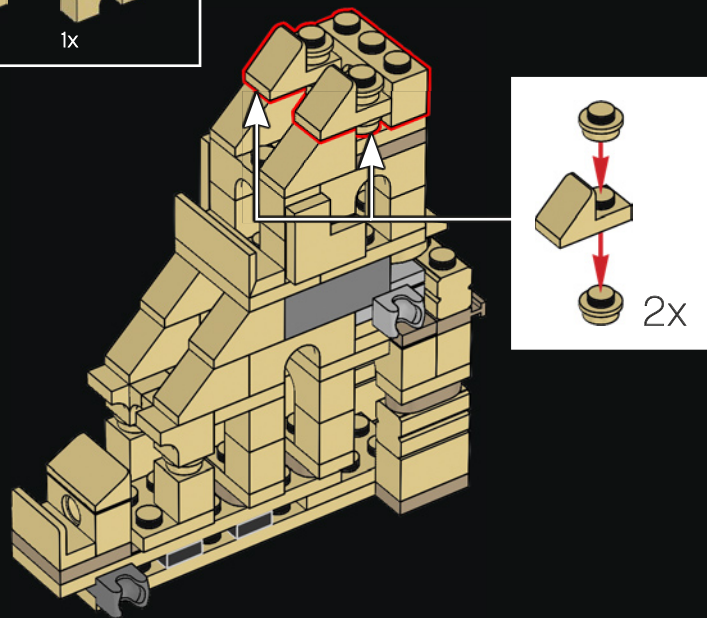

588

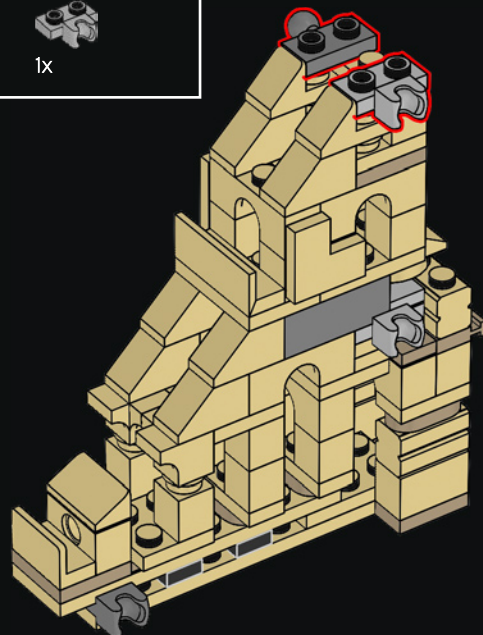



589

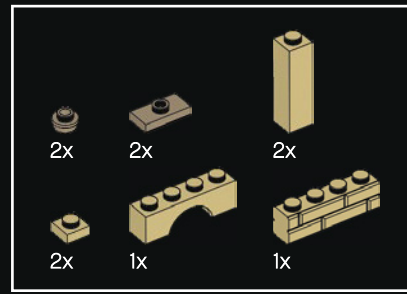
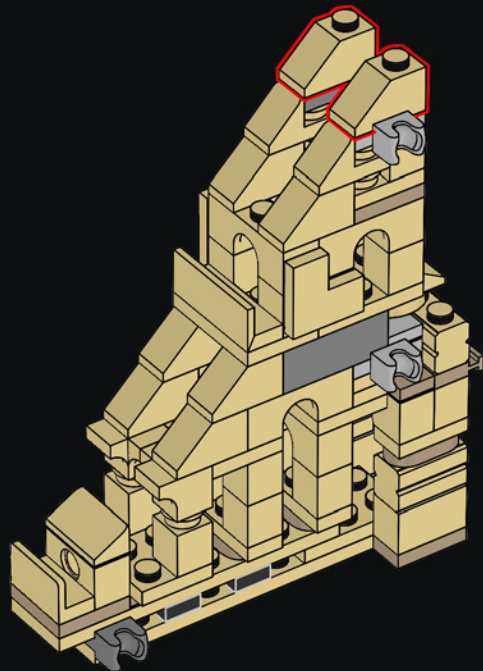

590

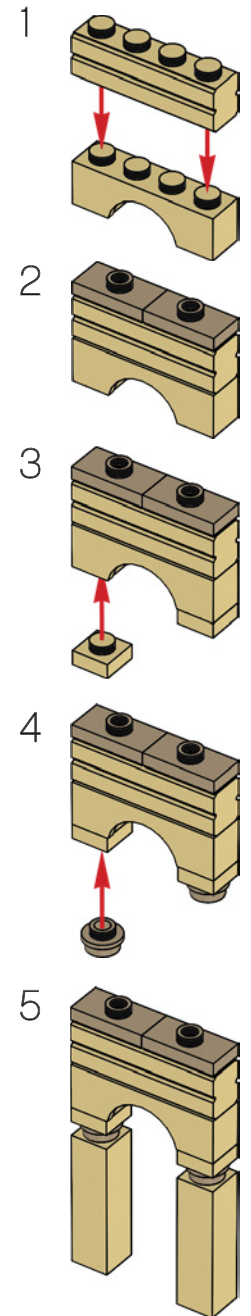
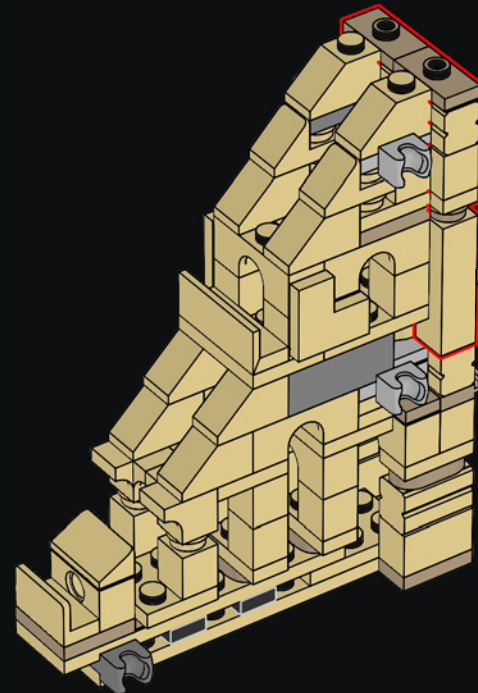



2x

591

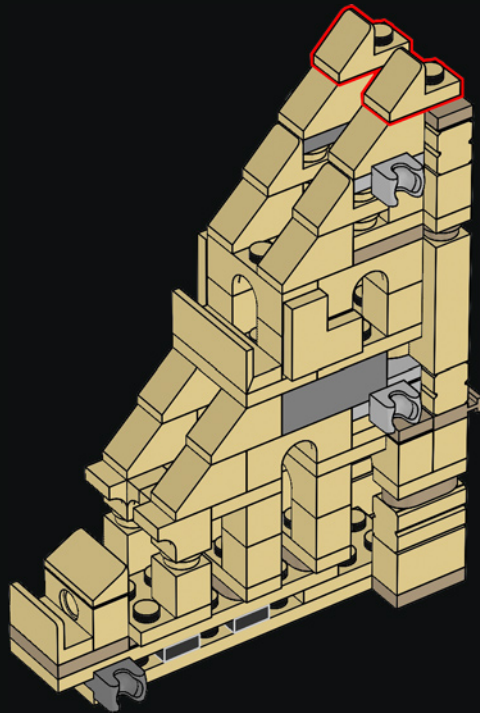

1x



1x

592

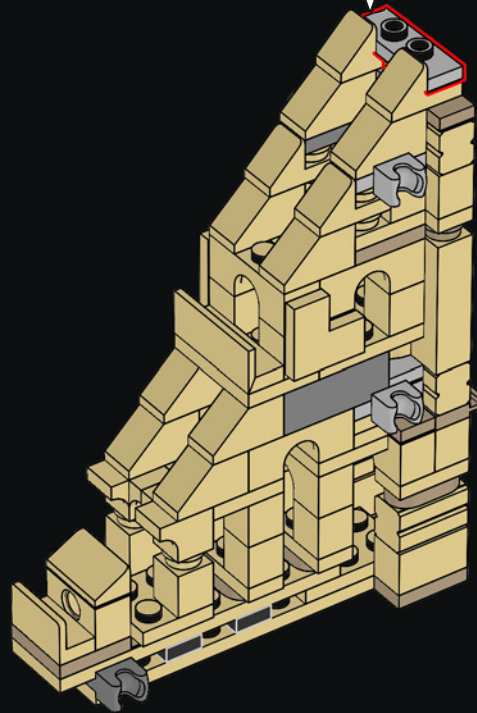
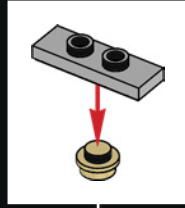

593

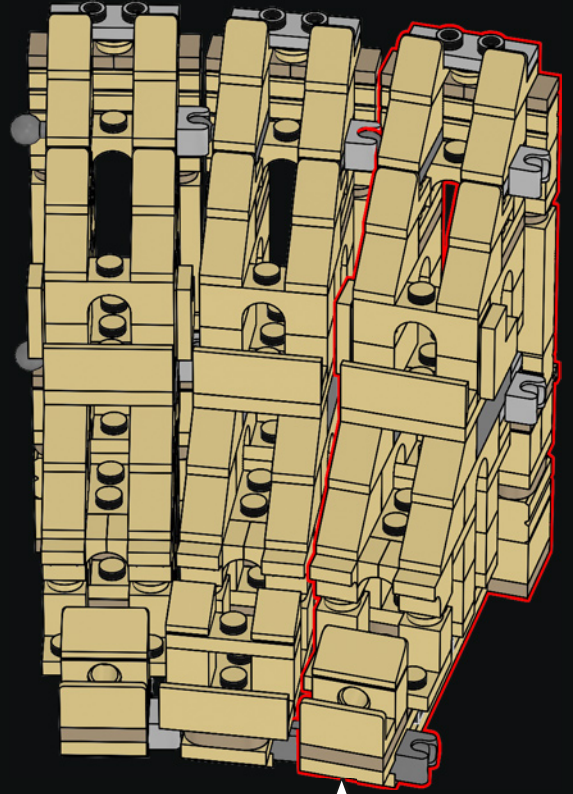

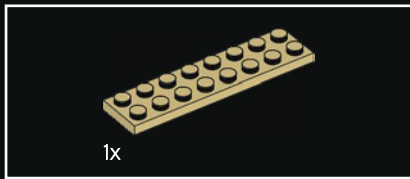
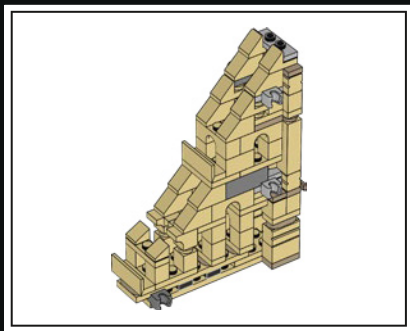

594

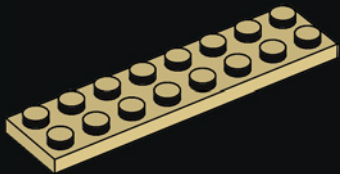

595

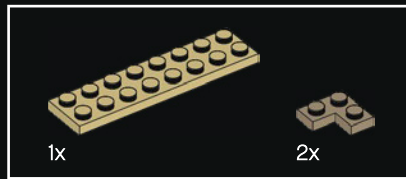
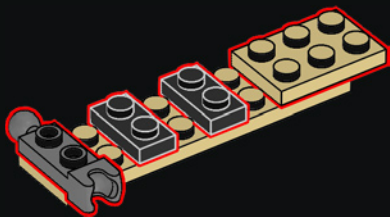

596

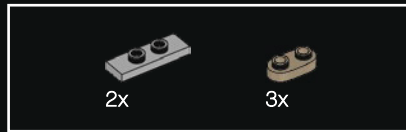
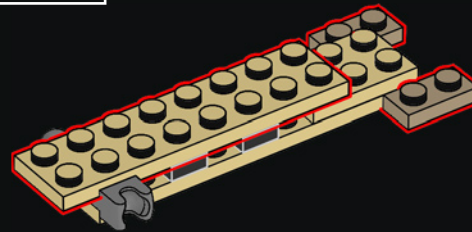

597

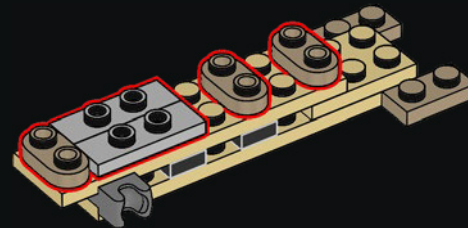

598

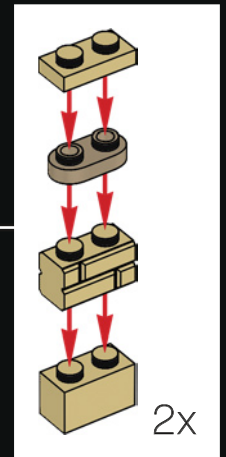
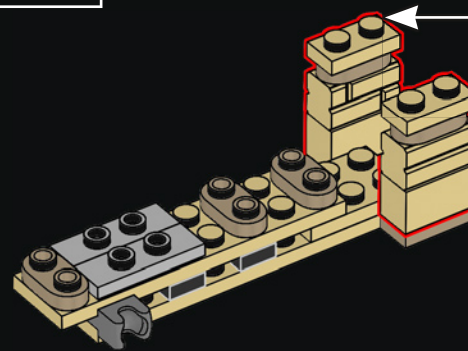



599

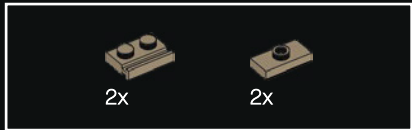
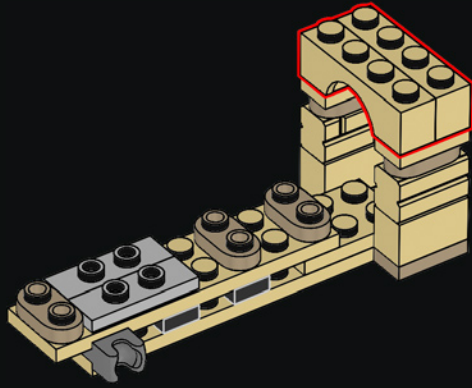

600

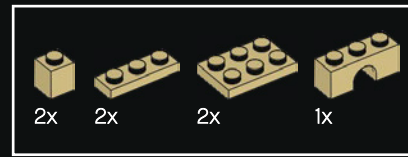
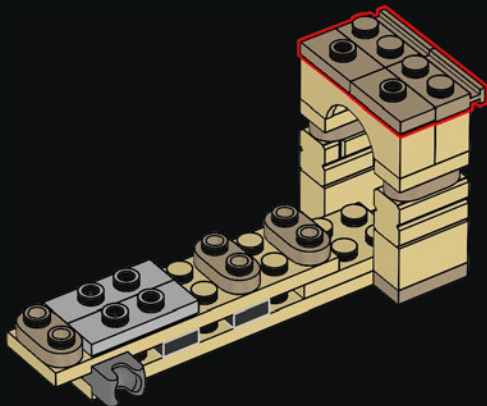

601

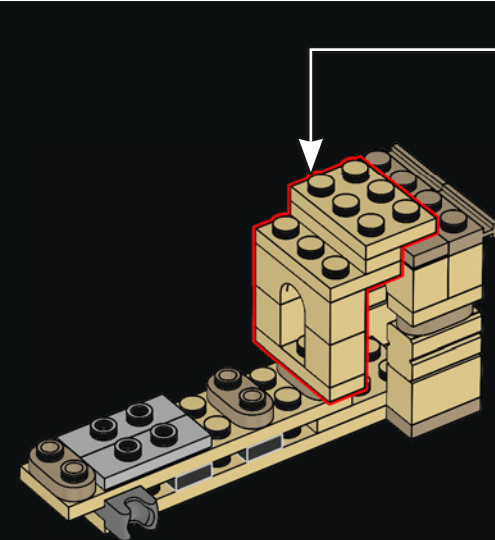
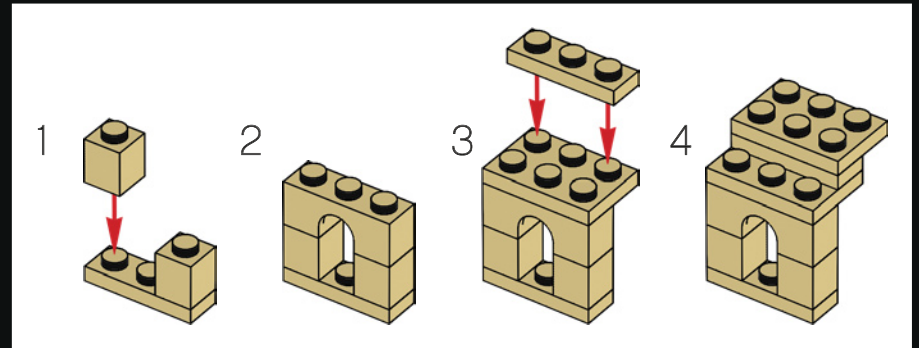

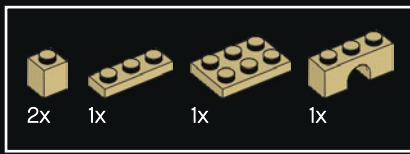

602

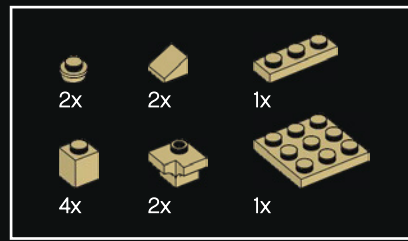
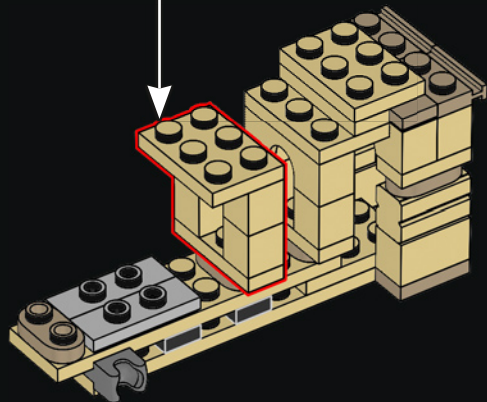
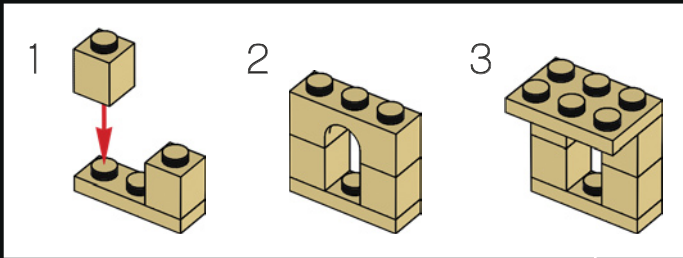

603

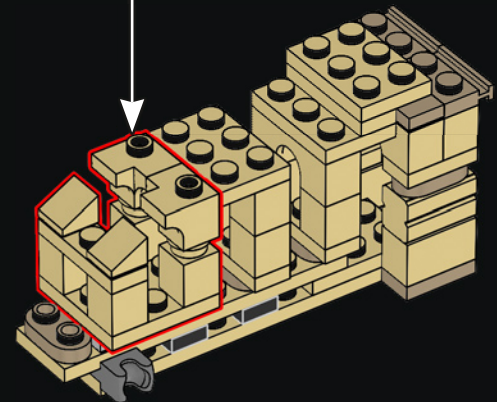
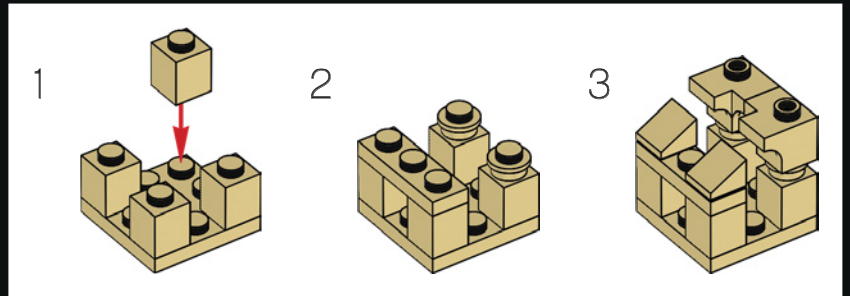

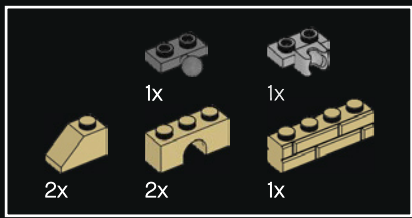

604

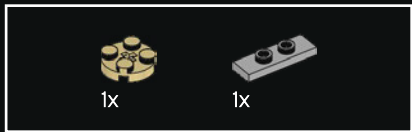
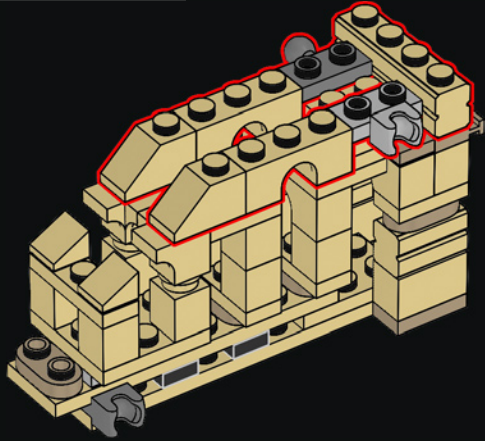

605

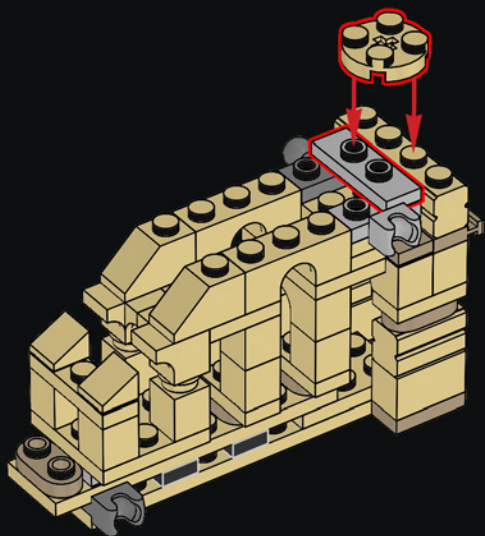

606

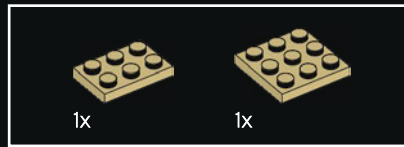
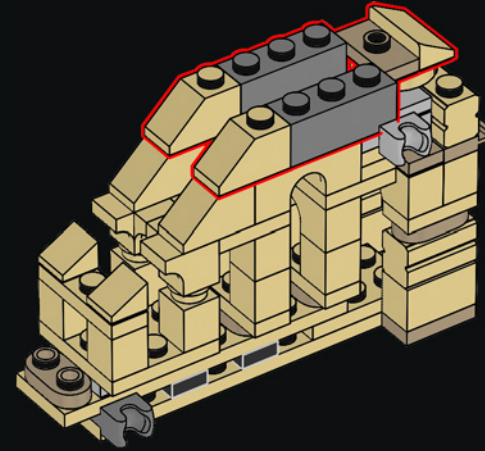

607

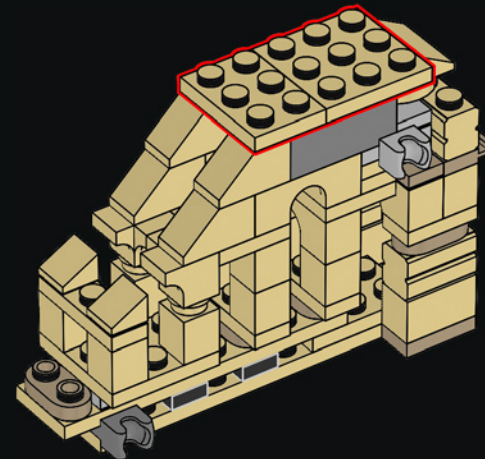

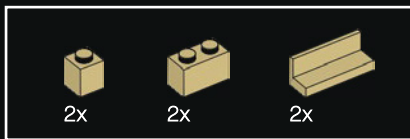

608

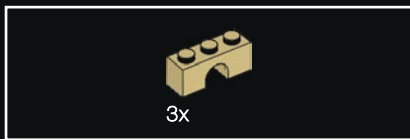
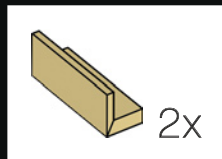
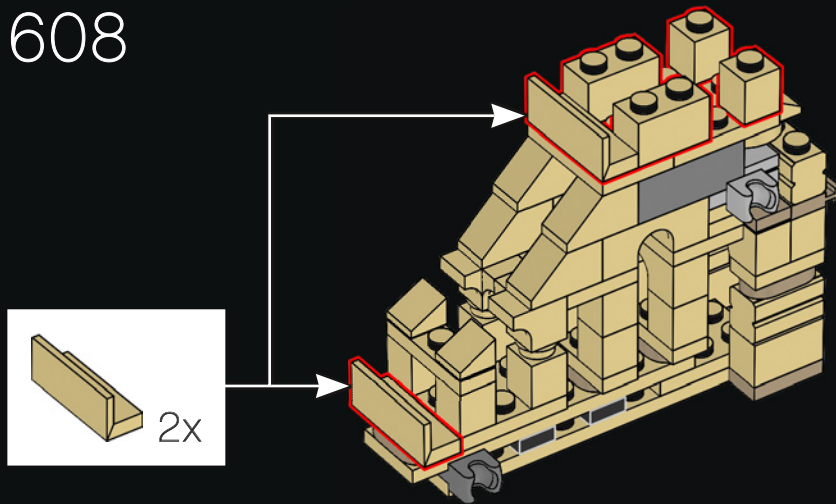

609

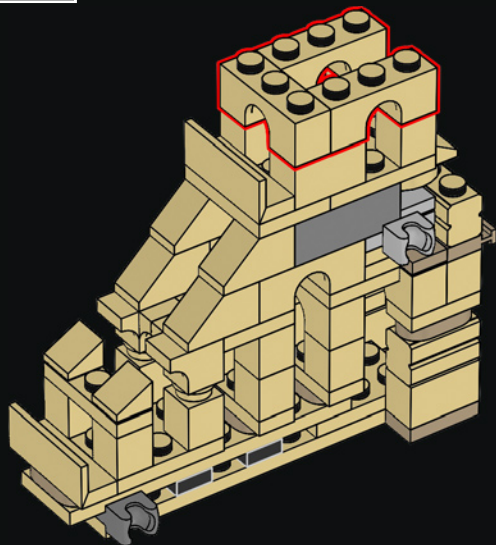

610

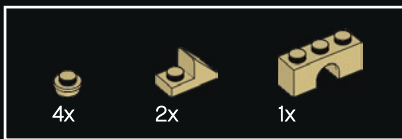
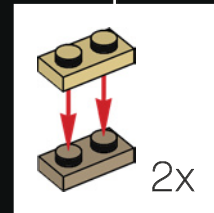
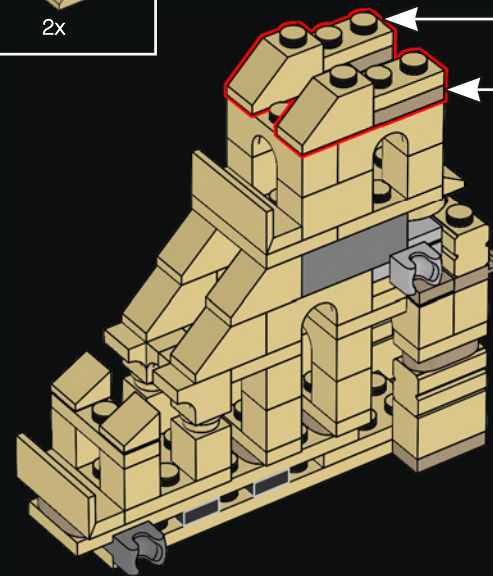

611

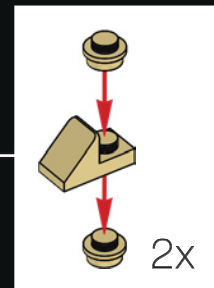
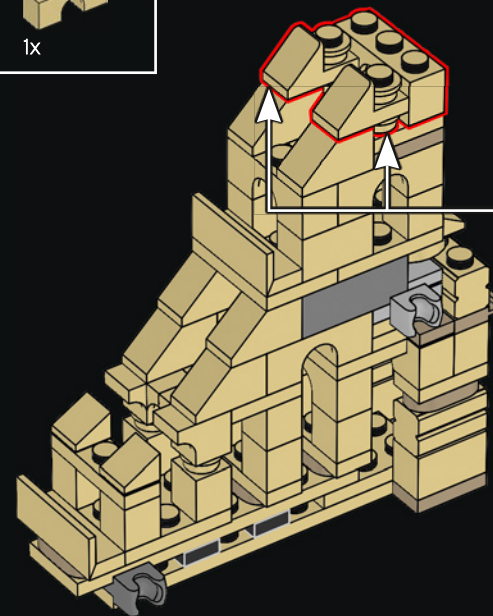



612

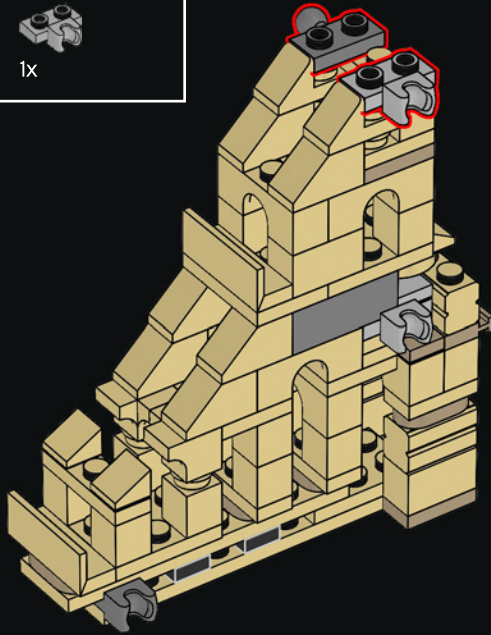

613

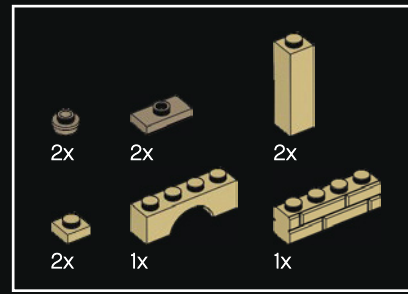
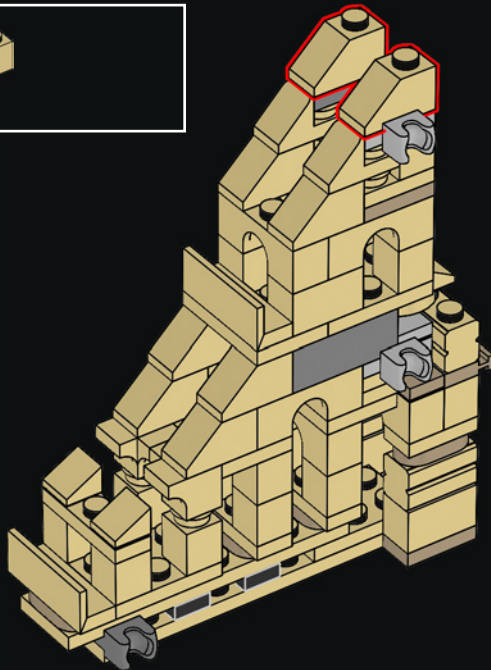

614

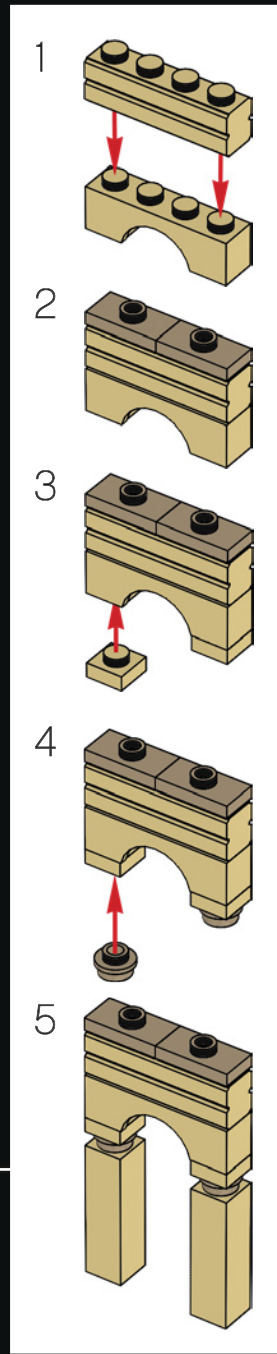
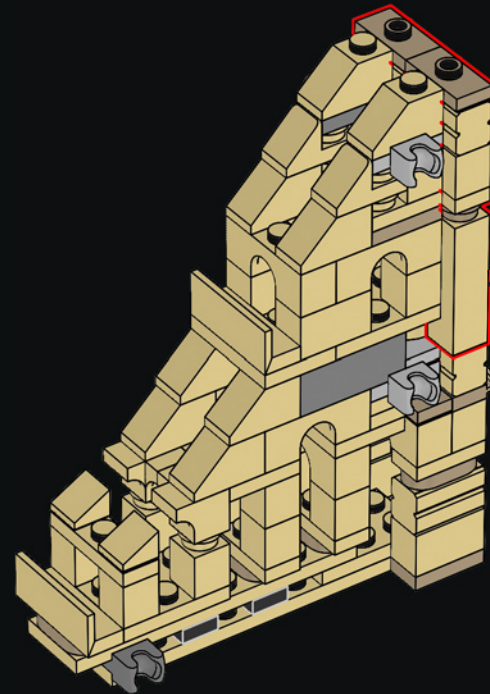



615

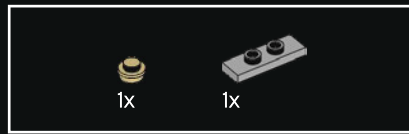
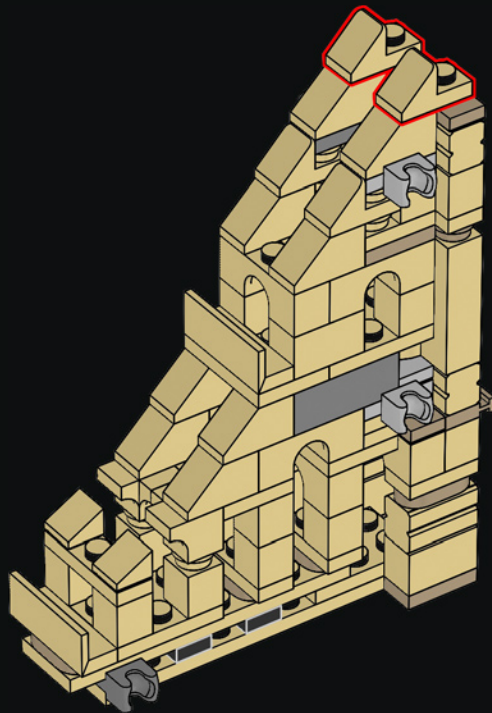

616

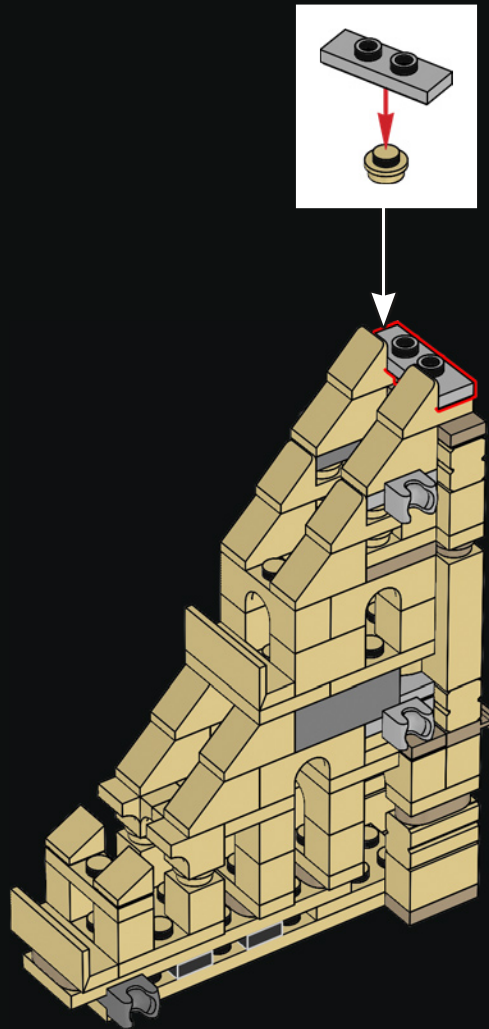

617

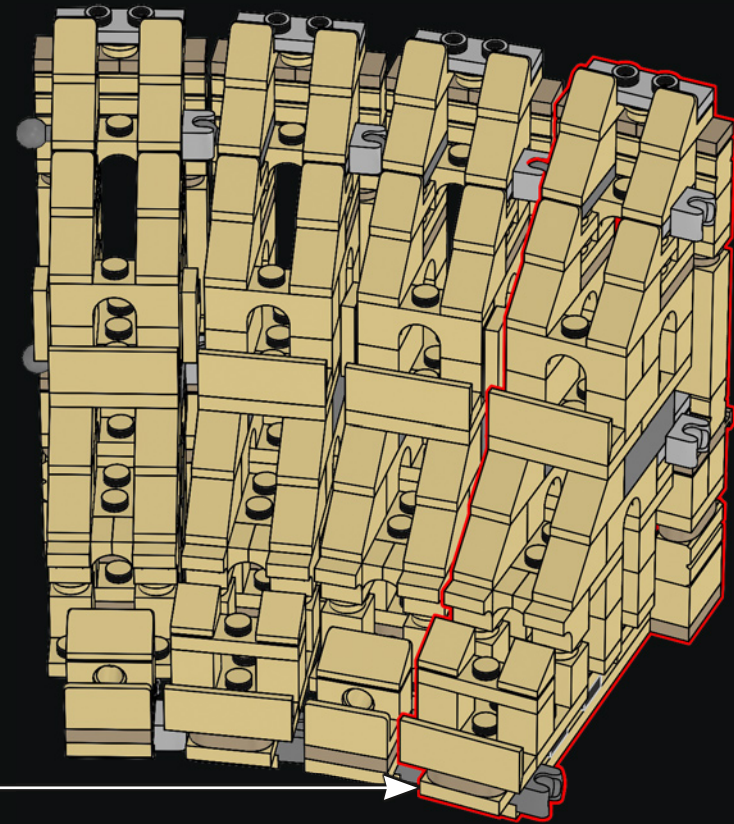

What does SPQR mean? It's an acronym for the Latin phrase *Senātus Populusque Rōmānus*. It means "The Senate and People of Rome." It's symbolic of the government of the ancient Roman Republic.

Que signifie SPQR ? C'est l'acronyme de la devise latine *Senatus Populusque Romanus*. Elle signifie « Le Sénat et le peuple romain ». Elle est l'emblème du gouvernement de l'ancienne République romaine.

¿Qué significa SPQR? Es un acrónimo creado a partir de la frase en latín *Senātus Populusque Rōmānus*. Significa *Senado y Pueblo de Roma*. Es un símbolo del gobierno de la antigua república Romana.

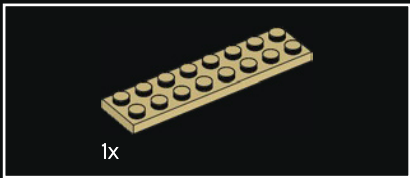
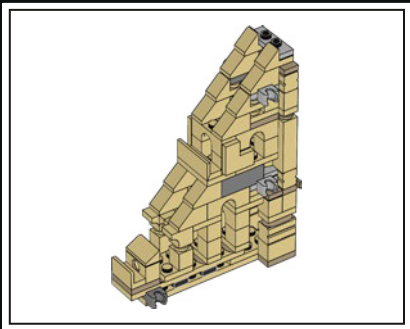
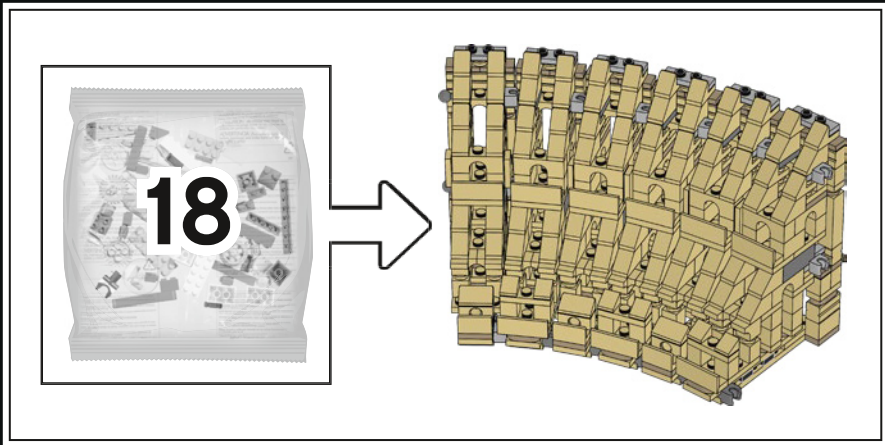

618

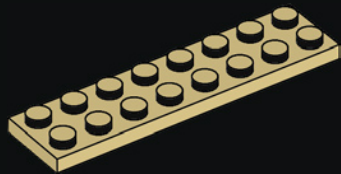

619

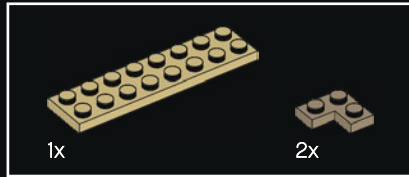
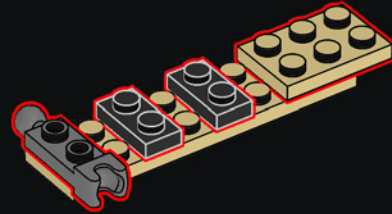

620

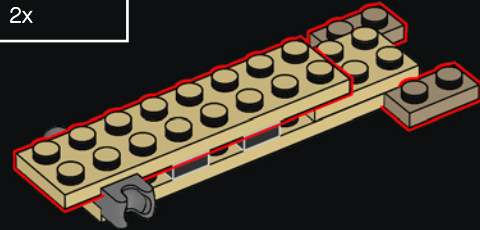

621

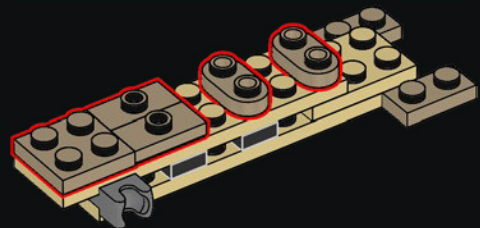

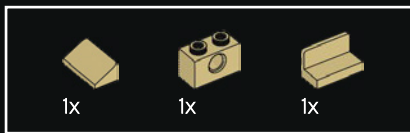

622

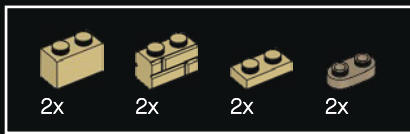
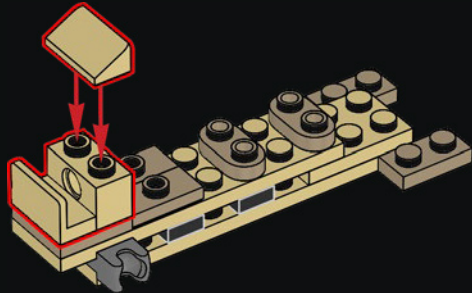

623

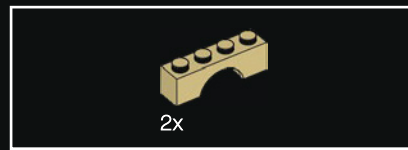
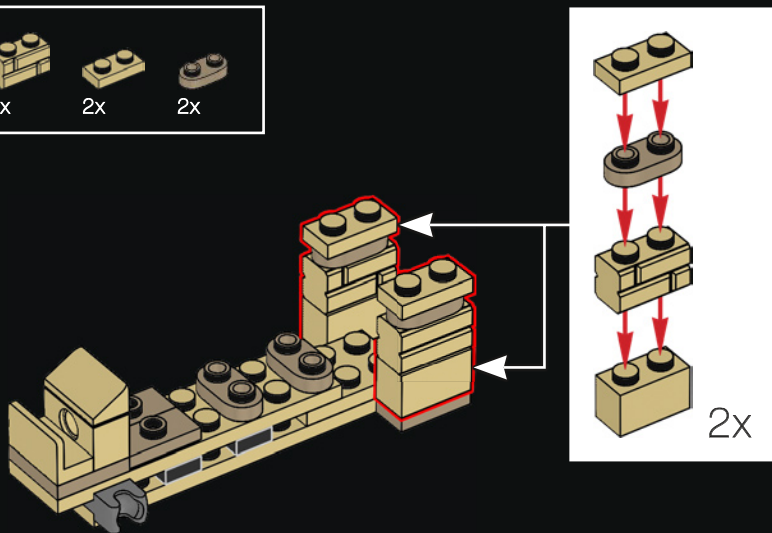

624

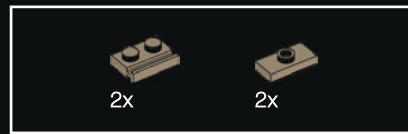
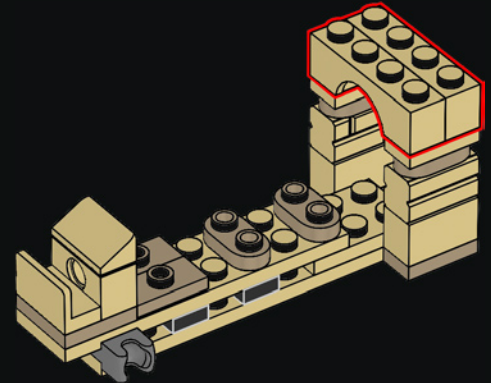

625

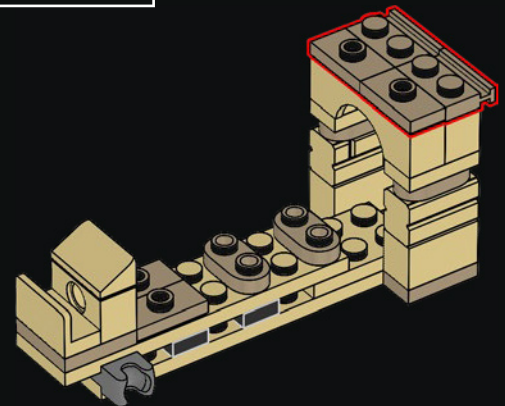

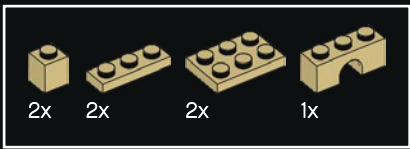

626

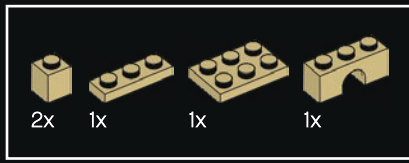
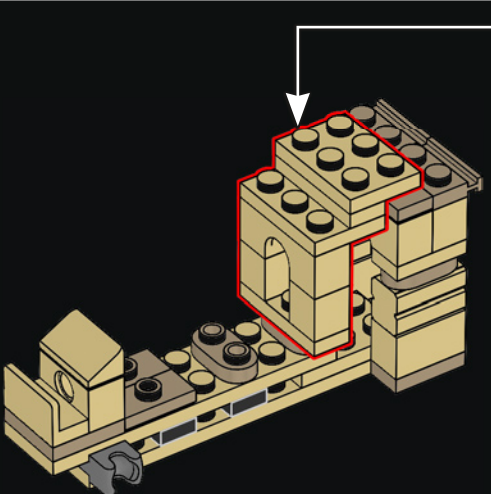
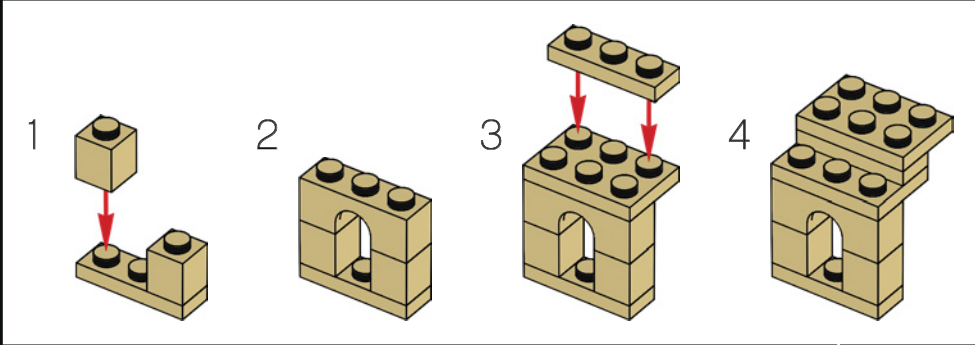

627

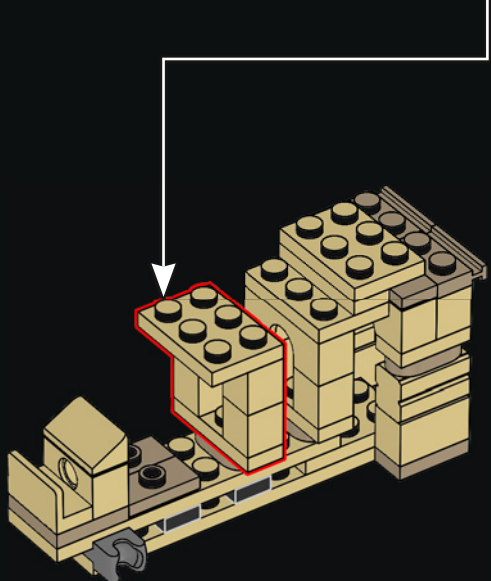
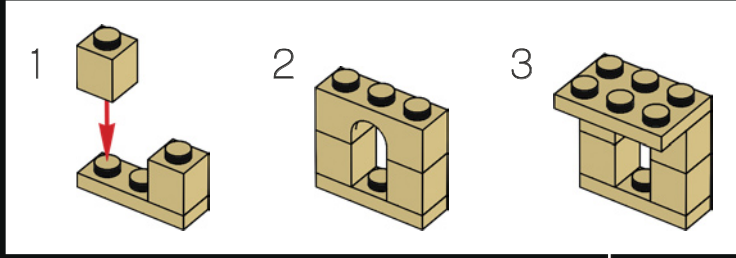



628

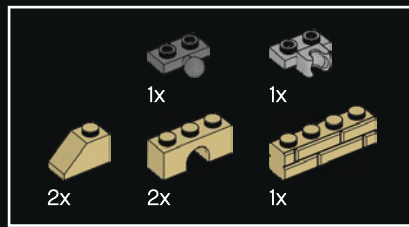
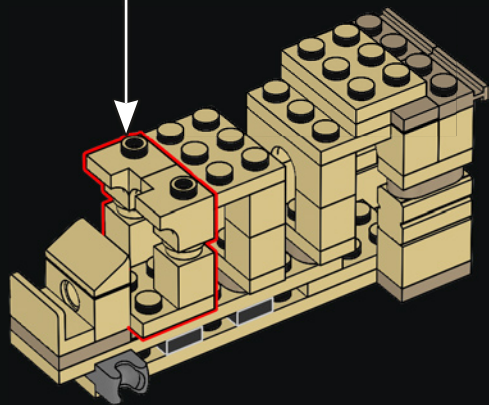
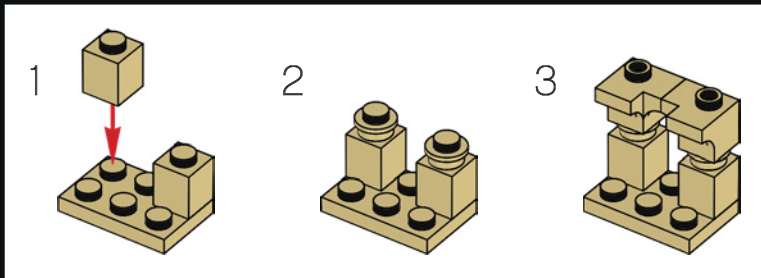

629

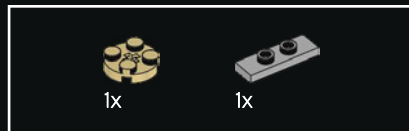
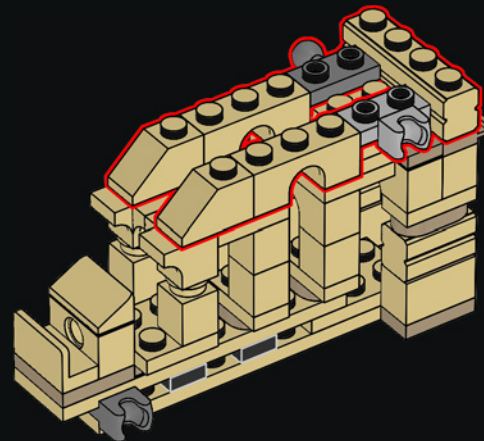

630

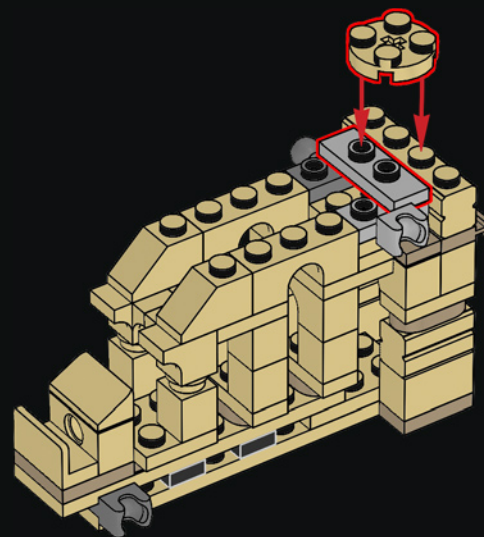



631

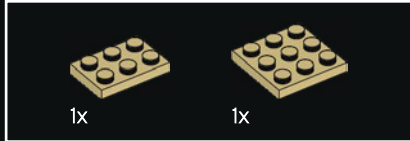
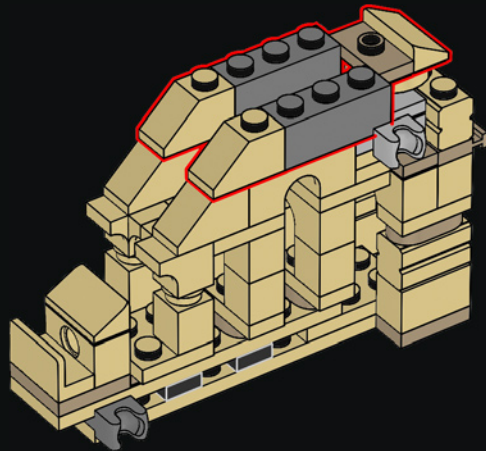

632

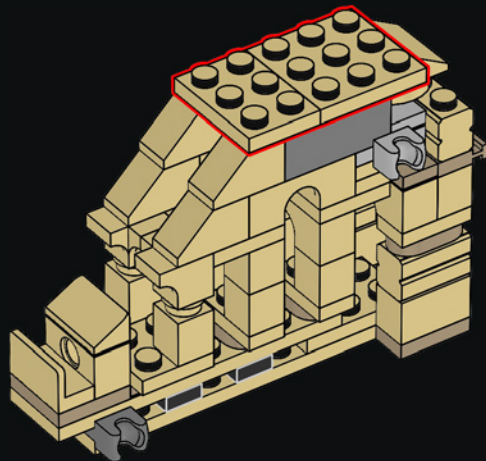

633

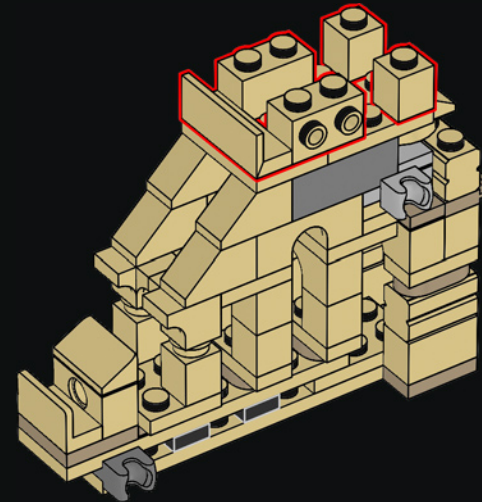

634

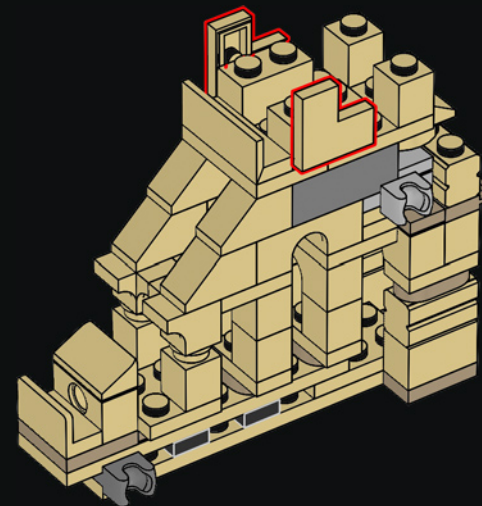

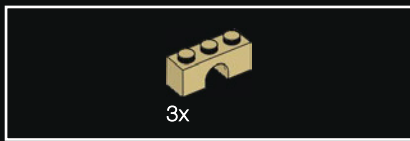

635

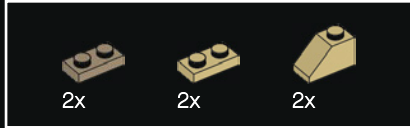
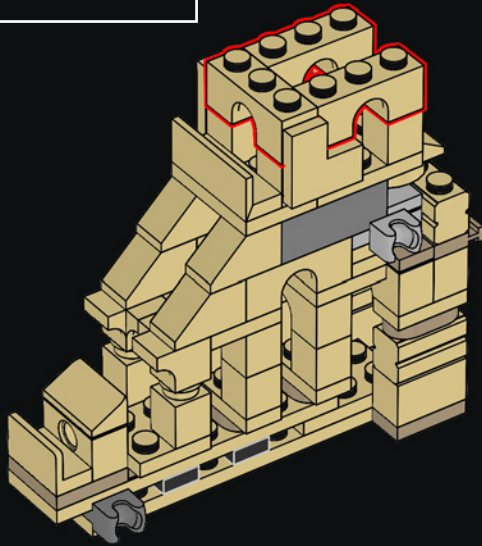

636

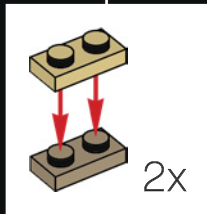
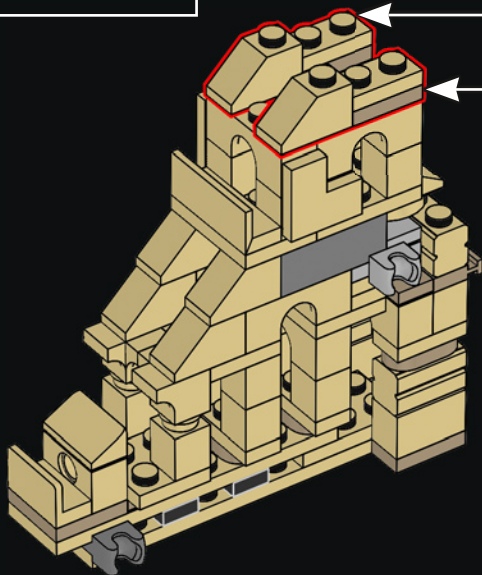

637

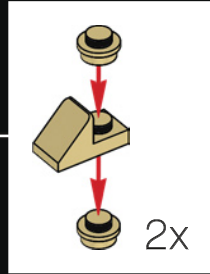
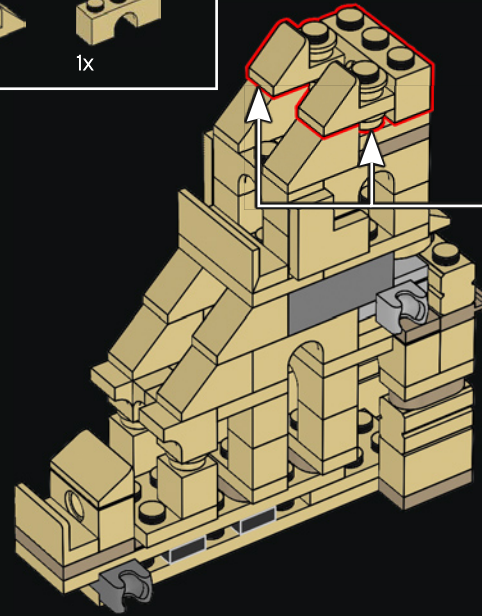

638

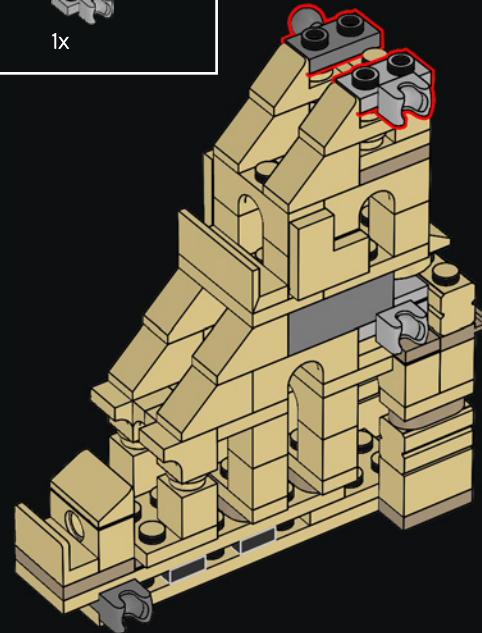



2x

639

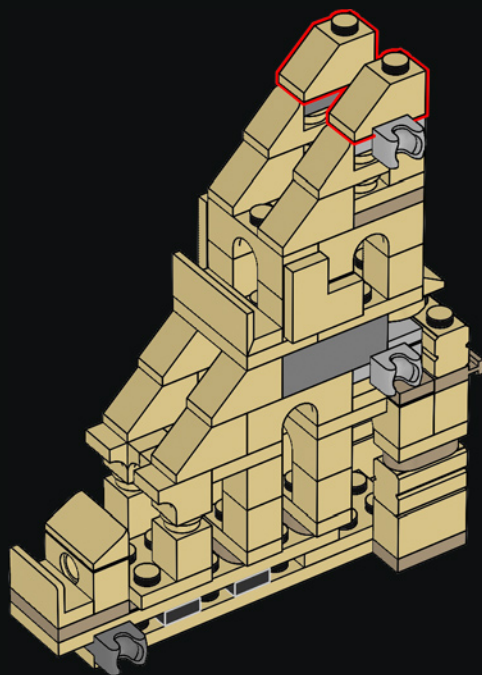

2x

2x

2x

2x

1x

1x

640

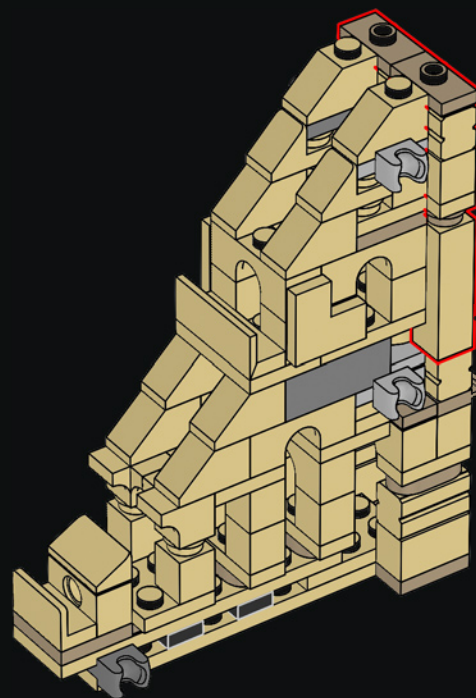

1

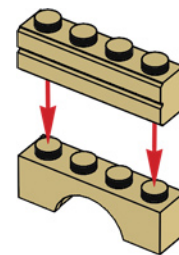

2

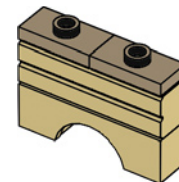

3

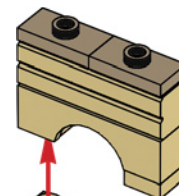

4

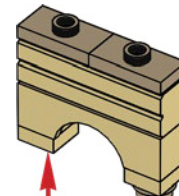

5

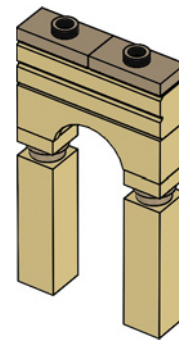



641

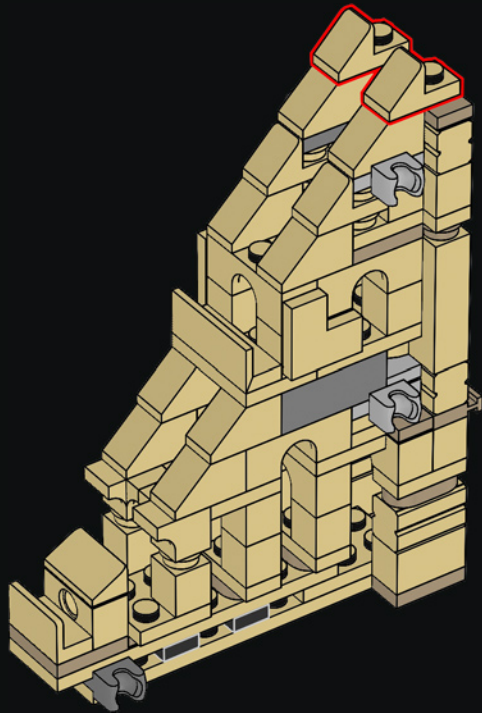

642

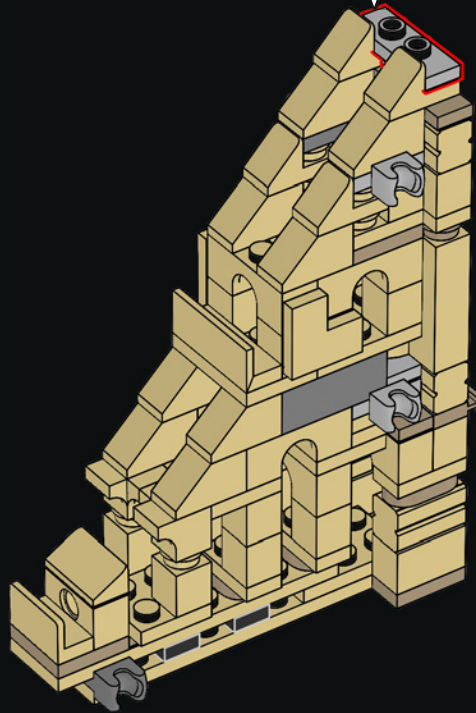
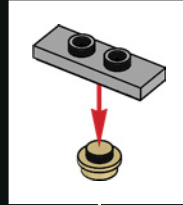

643

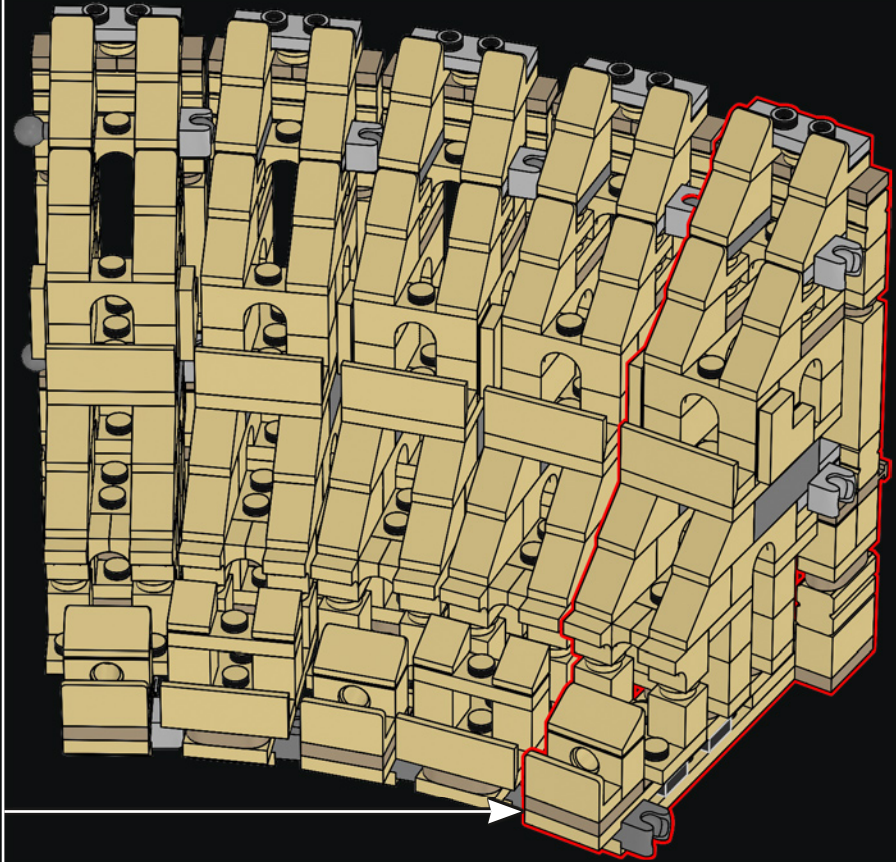

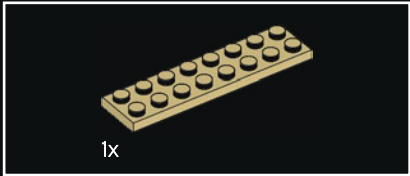
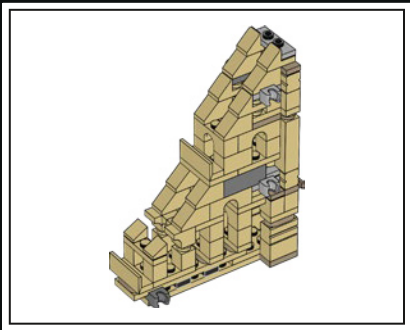

644

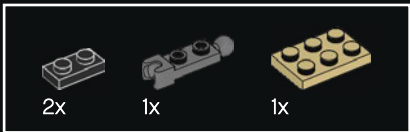
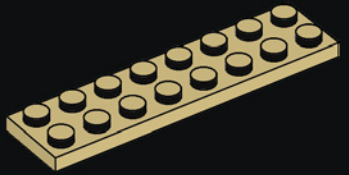

645

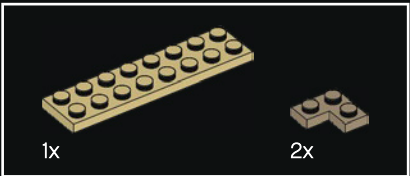
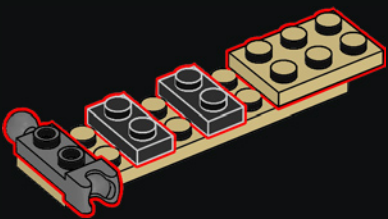

646

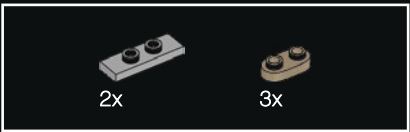
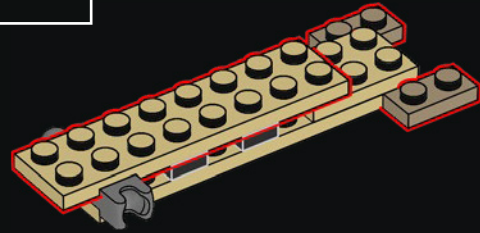

647

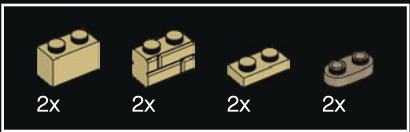
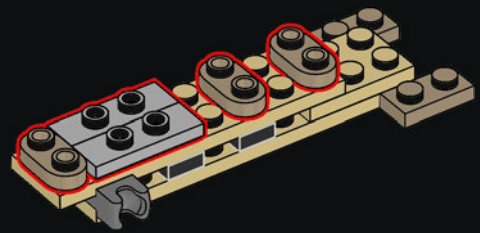

648

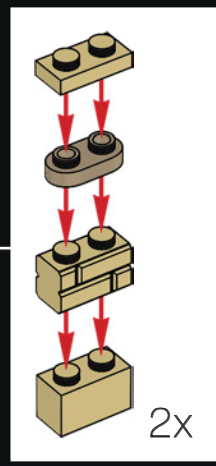
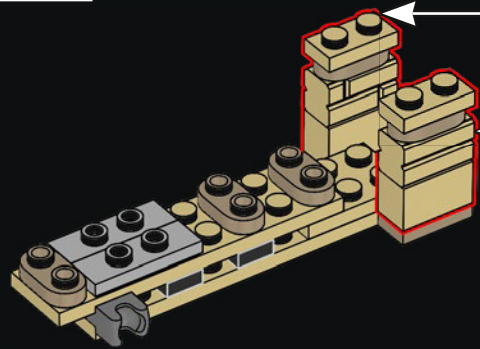



649

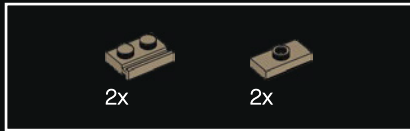
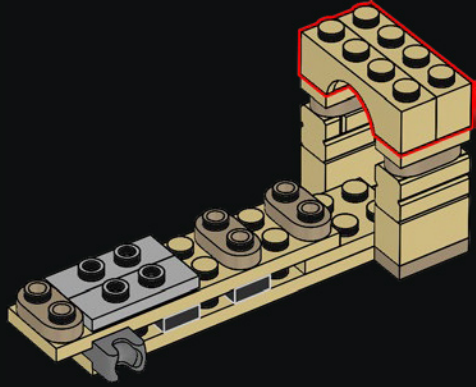

650

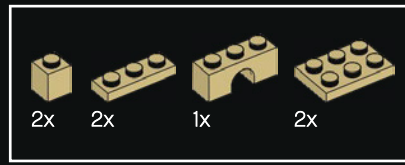
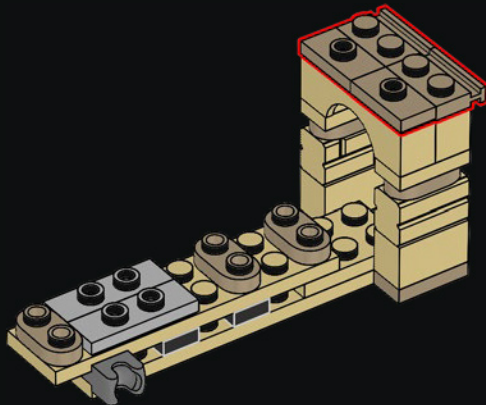

651

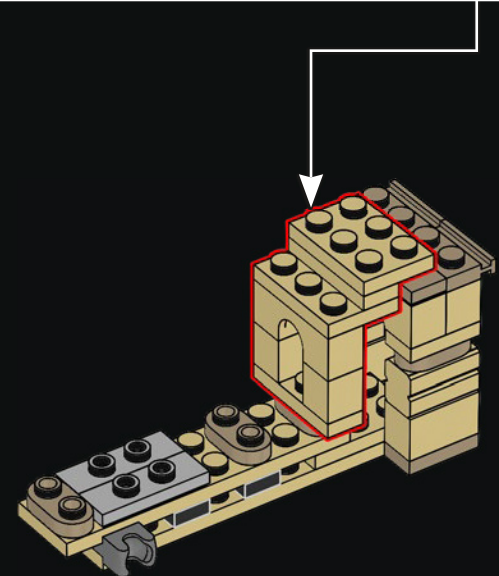
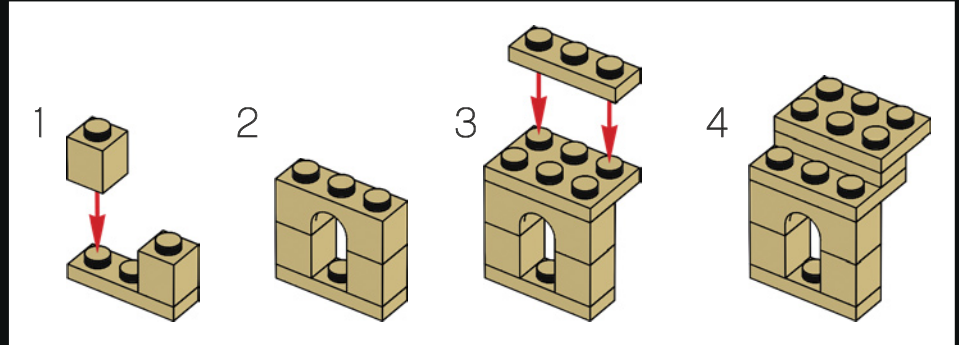

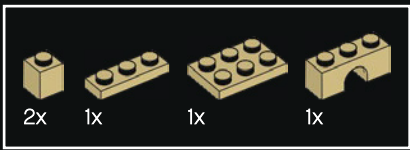

652

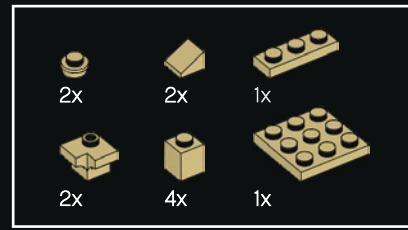
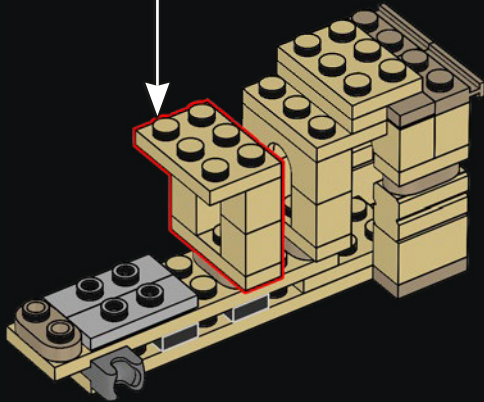
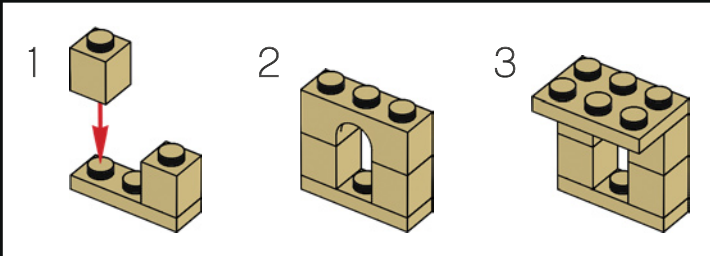

653

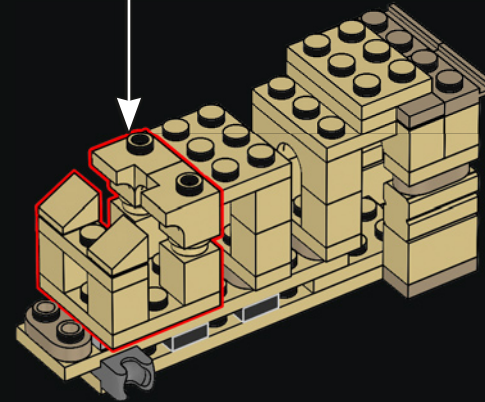
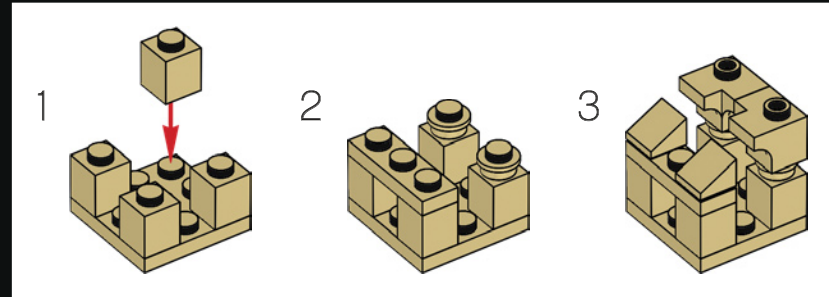

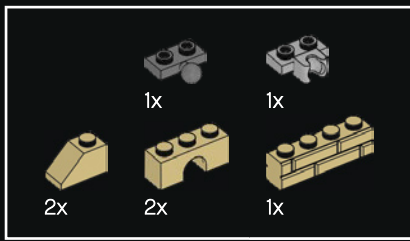

654

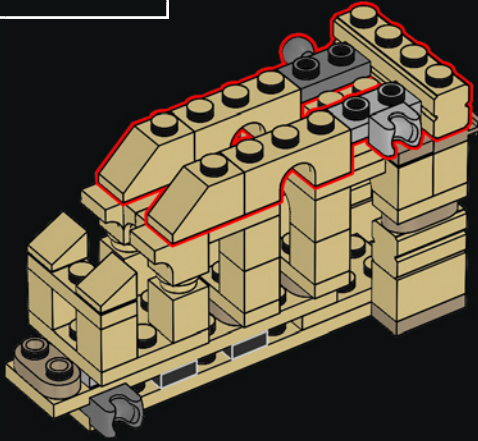

655

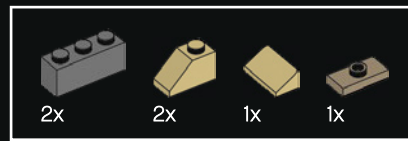
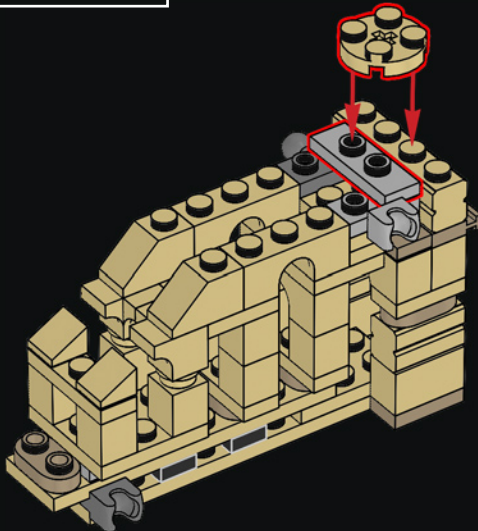

656

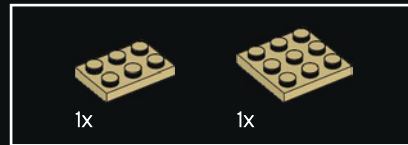
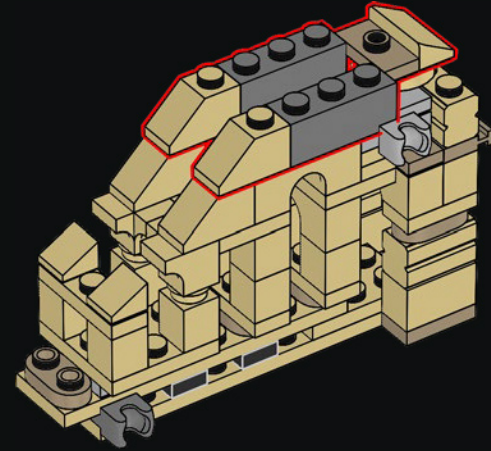

657

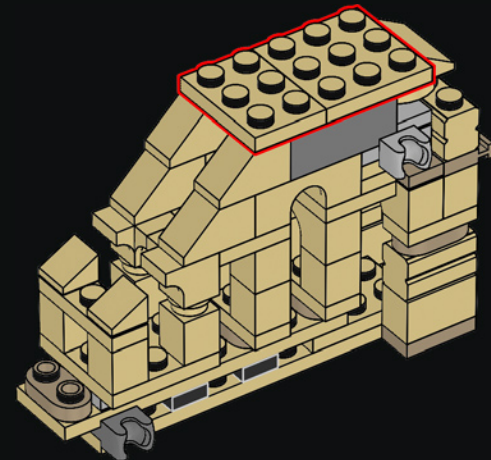



658

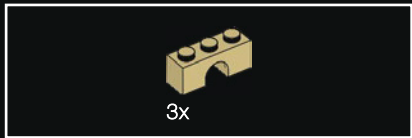
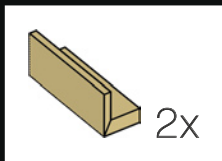
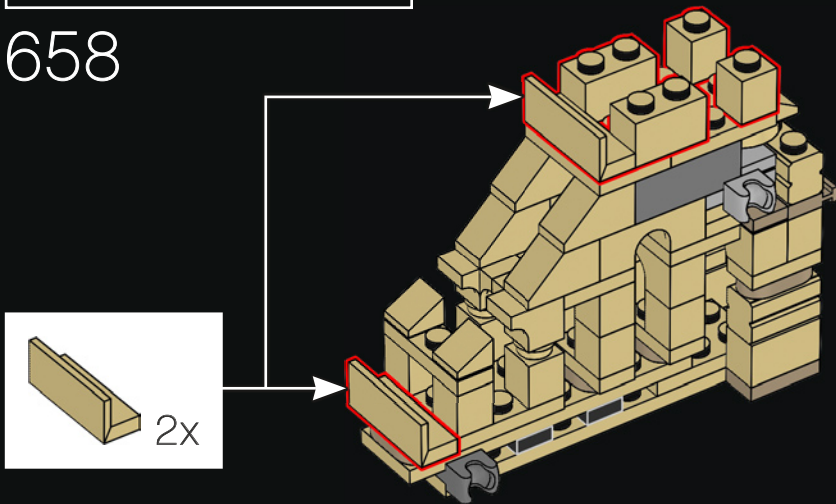

659

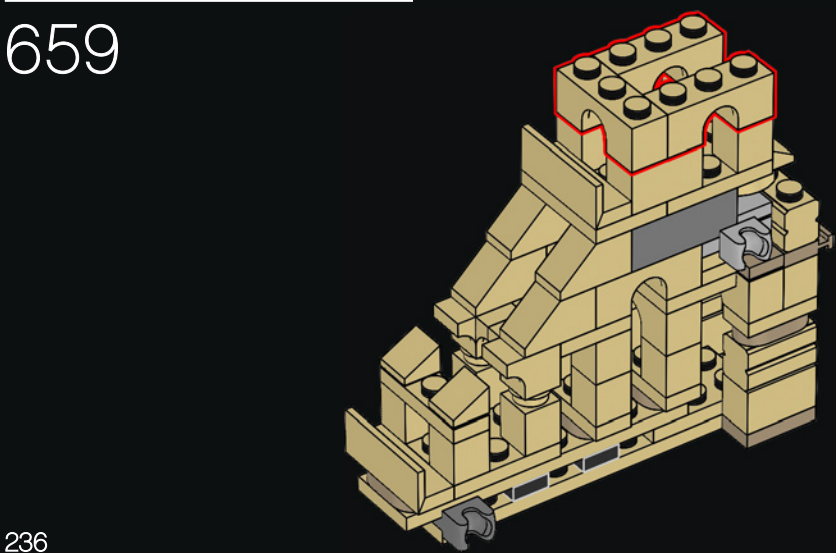

660

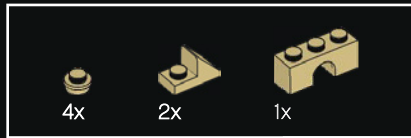
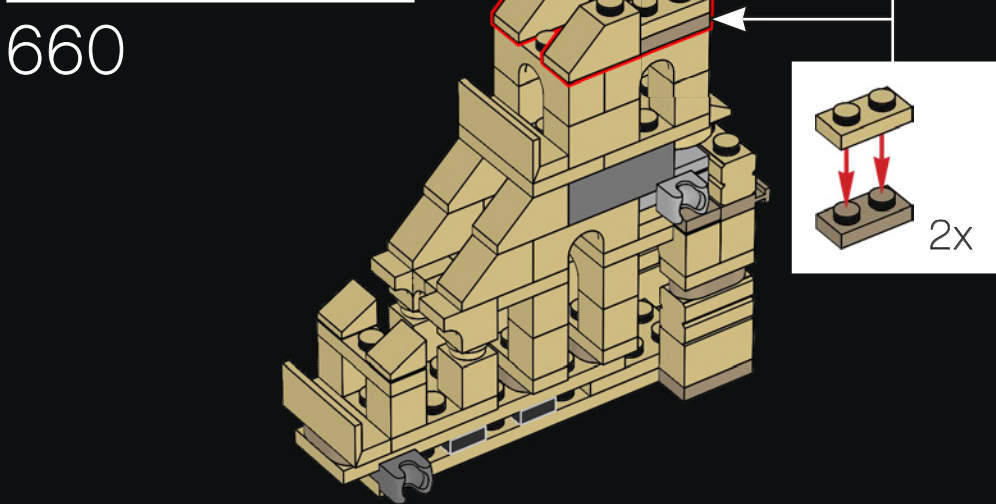

661

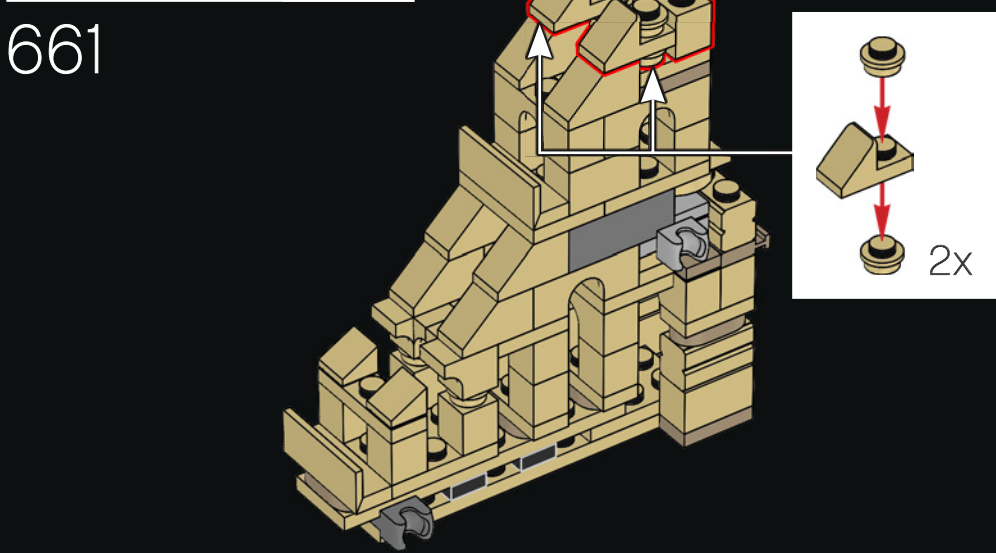



662

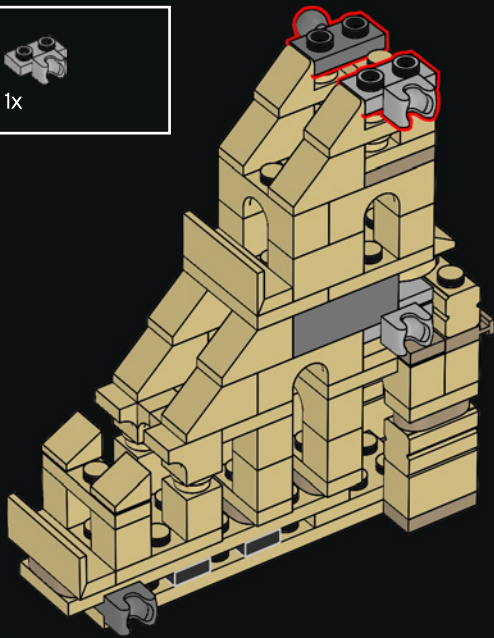

663

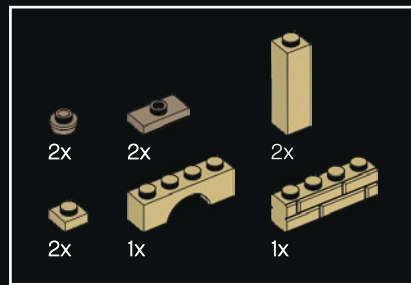
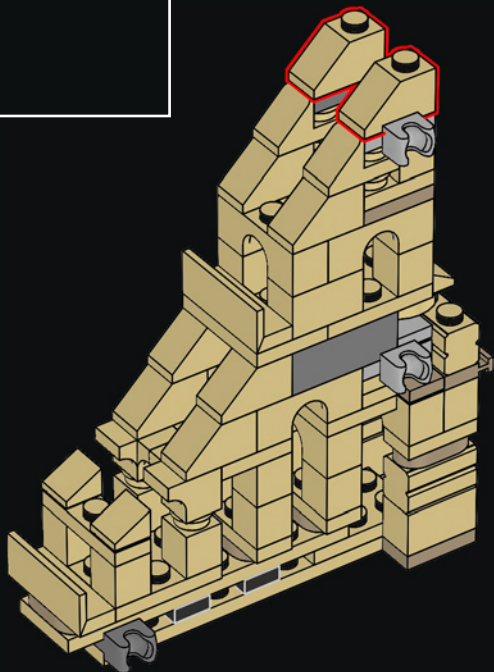

664

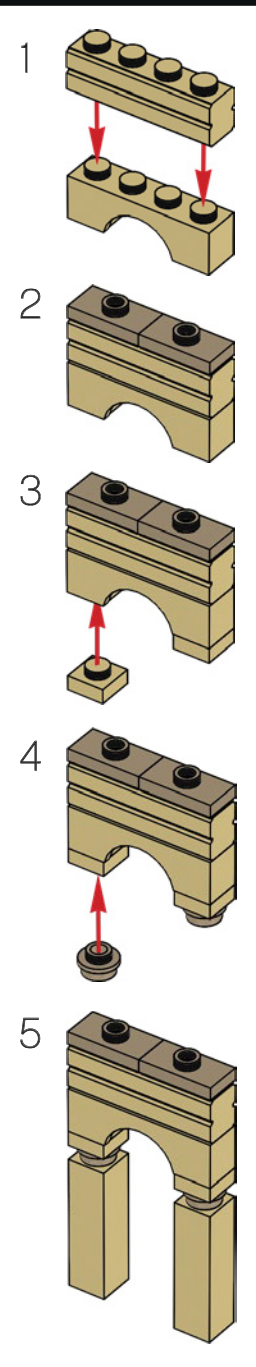
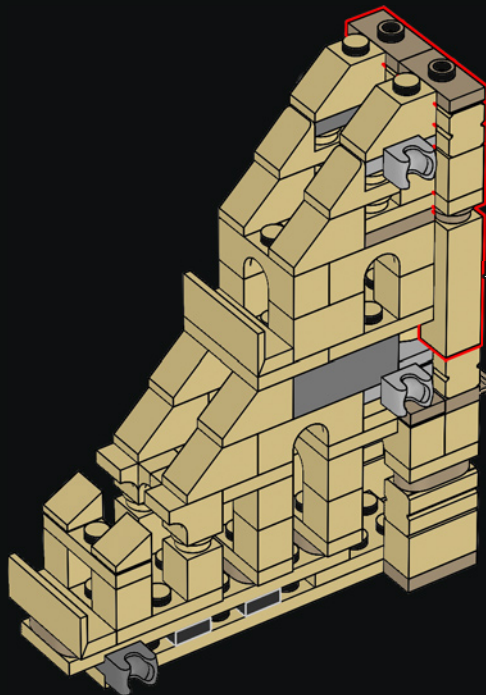



2x

665

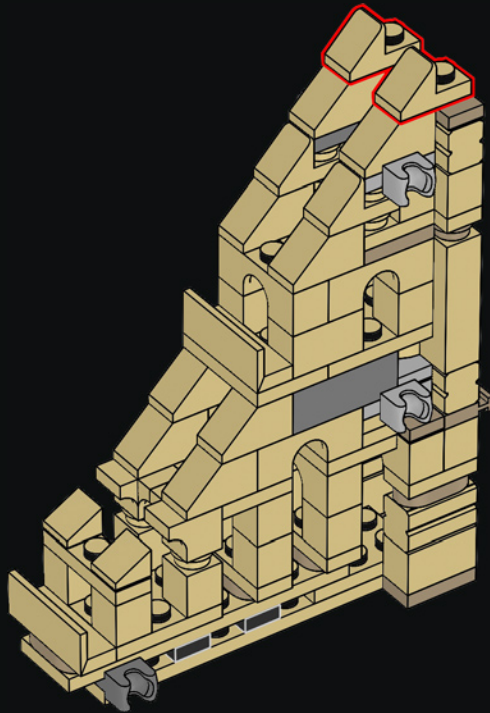

1x



1x

666

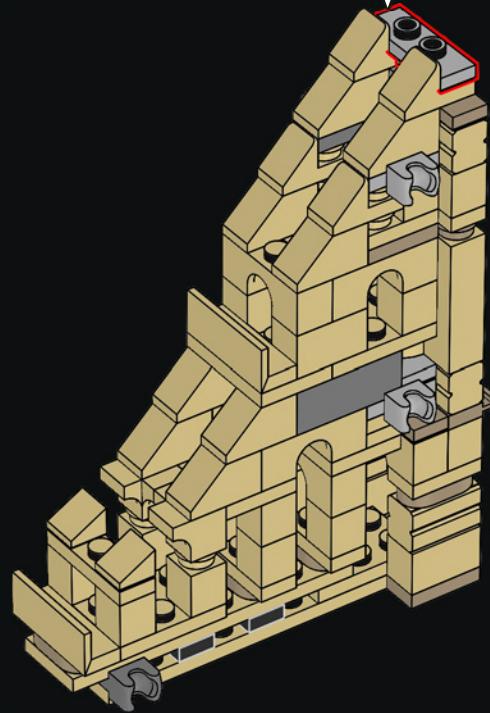
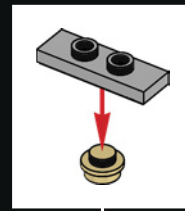

667

