

S·P·Q·R·

LE COLISÉE

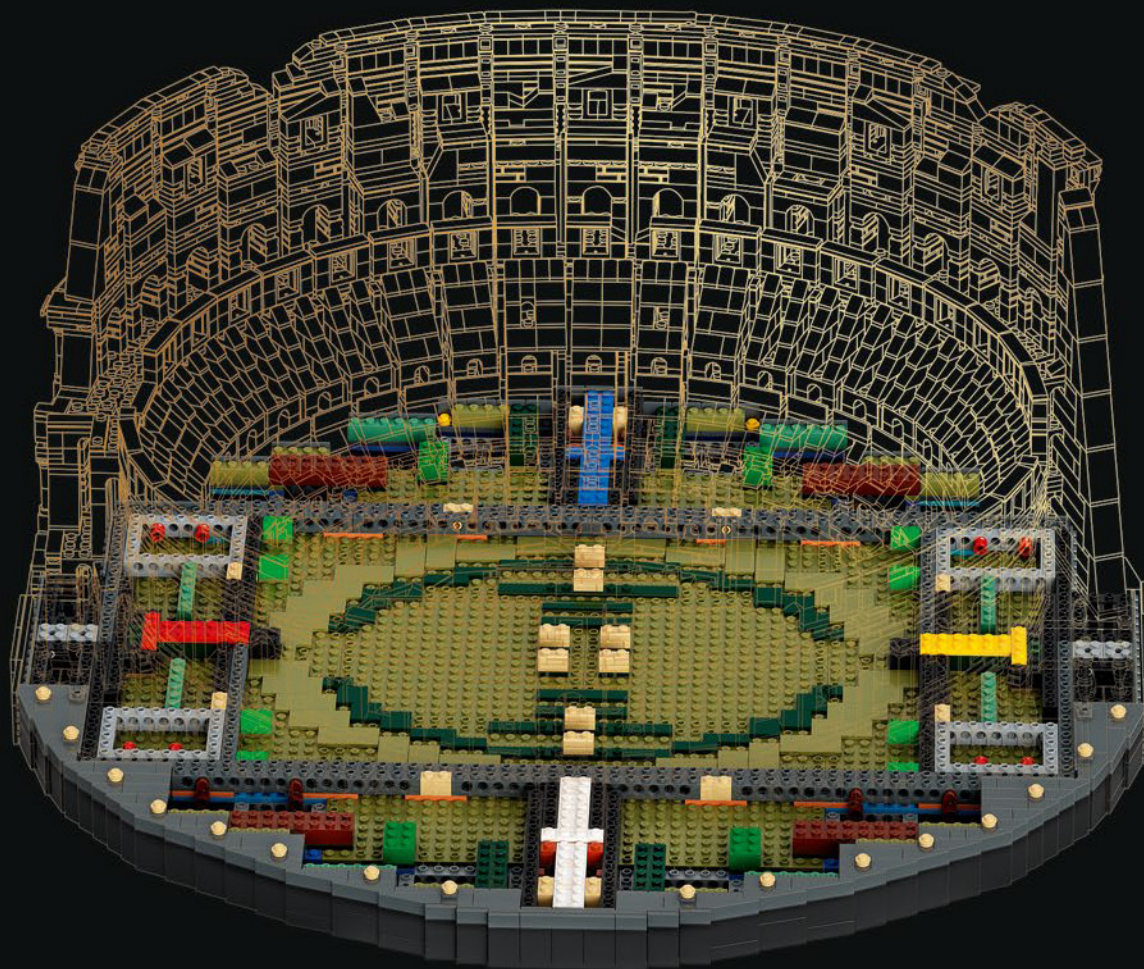

I

BIENVENUE

Nous sommes ravis de vous présenter notre interprétation du célèbre Colisée de Rome. Qu'il évoque des souvenirs d'un voyage à Rome, éveille en vous un intérêt pour l'architecture classique ou vous permette de vous détendre, nous espérons qu'il vous offrira des heures de plaisir de construction LEGO®.

Jamie Berard, responsable du design

LE COLISÉE

Le Colisée, qui se trouve au cœur de la capitale italienne, est un symbole de la Rome antique impériale. L'impressionnant amphithéâtre, le plus grand jamais construit à l'époque, pouvait accueillir entre 50 000 et 80 000 spectateurs. Ils s'y réunissaient pour assister à des combats de gladiateurs, à des chasses aux animaux et même à des reconstitutions de célèbres batailles navales. Considéré comme l'une des sept nouvelles merveilles du monde, le Colisée est également l'une des plus grandes attractions touristiques, avec plus de 7 millions de visiteurs par an.





Alors que les théâtres grecs antérieurs étaient construits à flanc de colline, l'imposant Colisée se dresse au milieu d'une vallée plate au cœur de Rome.

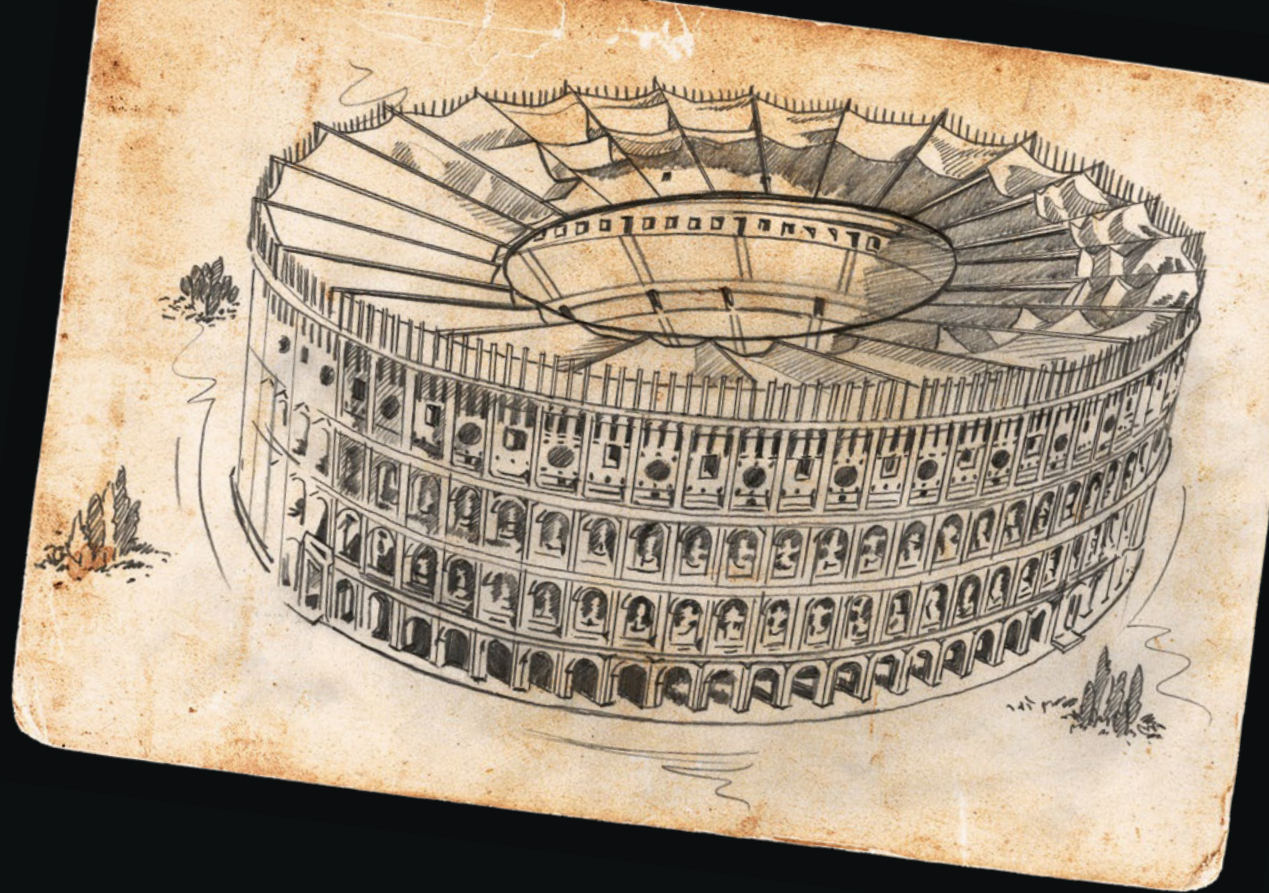

AMPHITHÉÂTRE

Le Colisée est une structure elliptique autonome de 189 m de long et 156 m de large. L'arène intérieure de forme ovale mesure 87 m de long et 55 m de large et est bordée d'un imposant mur de 5 m, surmonté de rangées de gradins. Le mur extérieur du Colisée s'élève à une hauteur impressionnante de 48 m et était encore plus haut avec le toit mobile en tissu, soutenu par un gréement et des mâts en bois.



La structure était entourée de 80 entrées au rez-de-chaussée. Les 4 entrées axiales principales, réservées à l'empereur et aux élites de la ville, étaient somptueusement décorées.

CONSTRUCTION

Plus de 100 000 m³ de travertin ont été utilisés pour construire le Colisée, dont 45 000 m³ uniquement pour les murs extérieurs. Plus de 300 tonnes d'agrafes de fer (se substituant au mortier) maintenaient les pierres ensemble. La façade extérieure de la structure est composée de 3 niveaux distincts, chacun doté de 80 arcades imposantes. Dans l'arène, un plancher de bois recouvert de sable cachait une structure souterraine complexe appelée *hypogée*.



HYPOGÉE

L'hypogée était un réseau souterrain à deux niveaux, composé de tunnels et de cages, ajouté après l'achèvement du Colisée initial. C'est là que les gladiateurs et les animaux se tenaient avant les spectacles. Suite à la construction de l'hypogée, l'arène ne pouvait plus être inondée pour recréer des batailles navales épiques.



LEGO.com/brickseparator

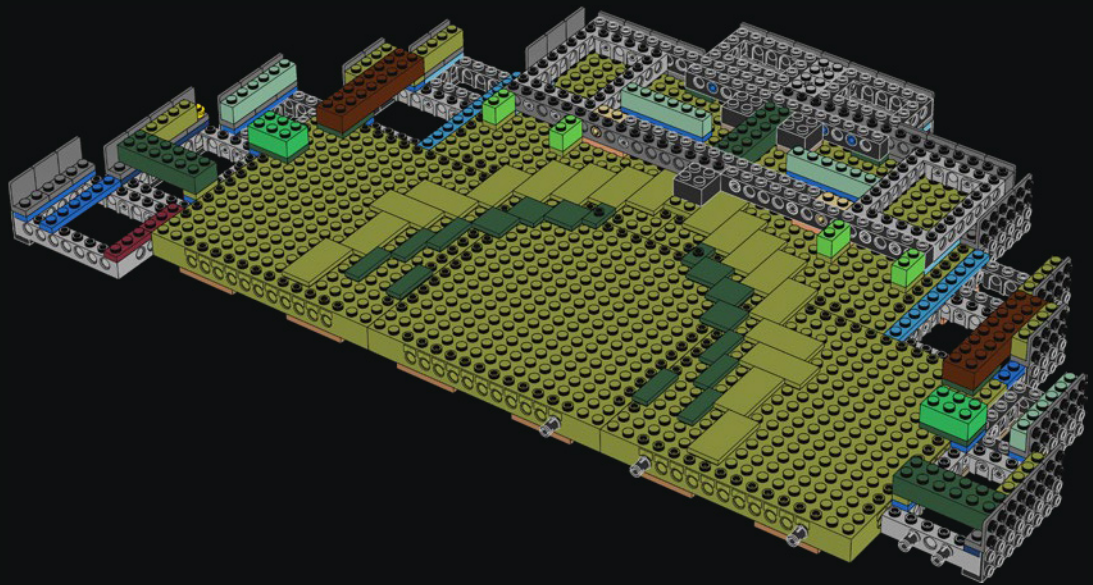

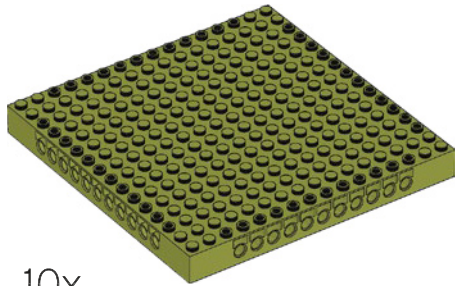

10x

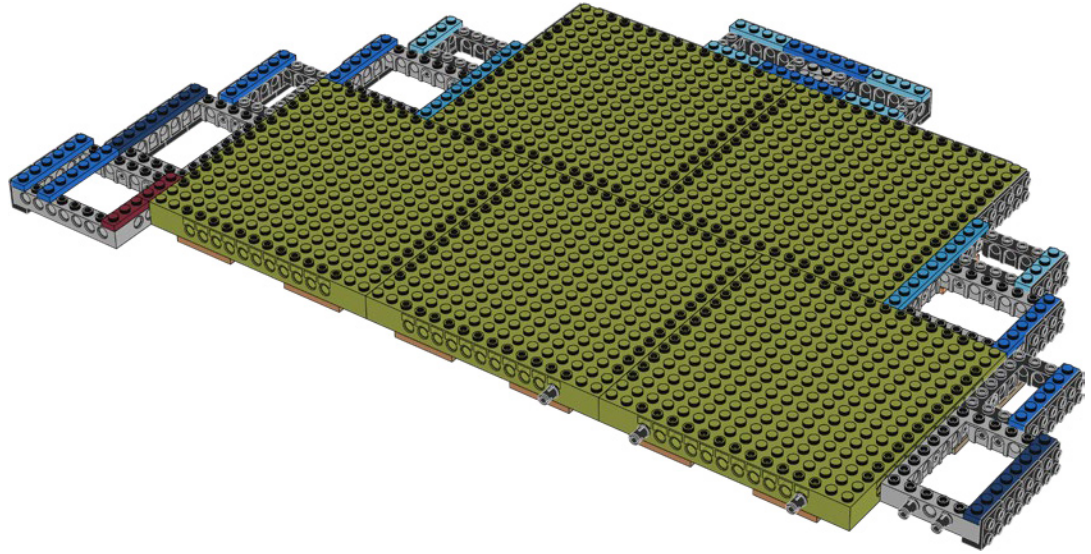
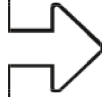

2x



1

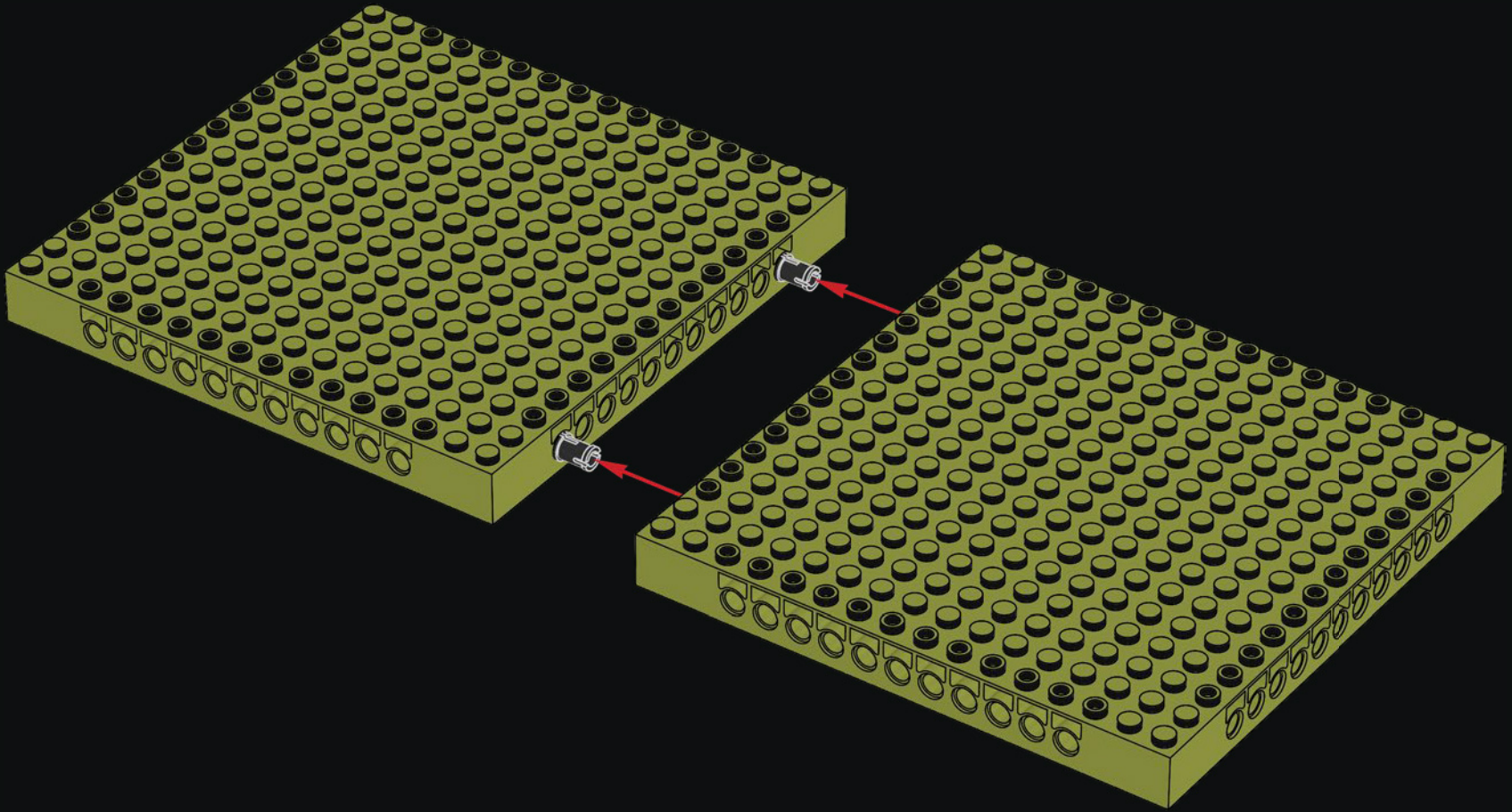

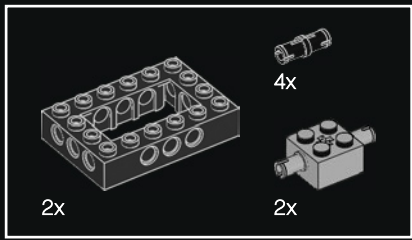

2

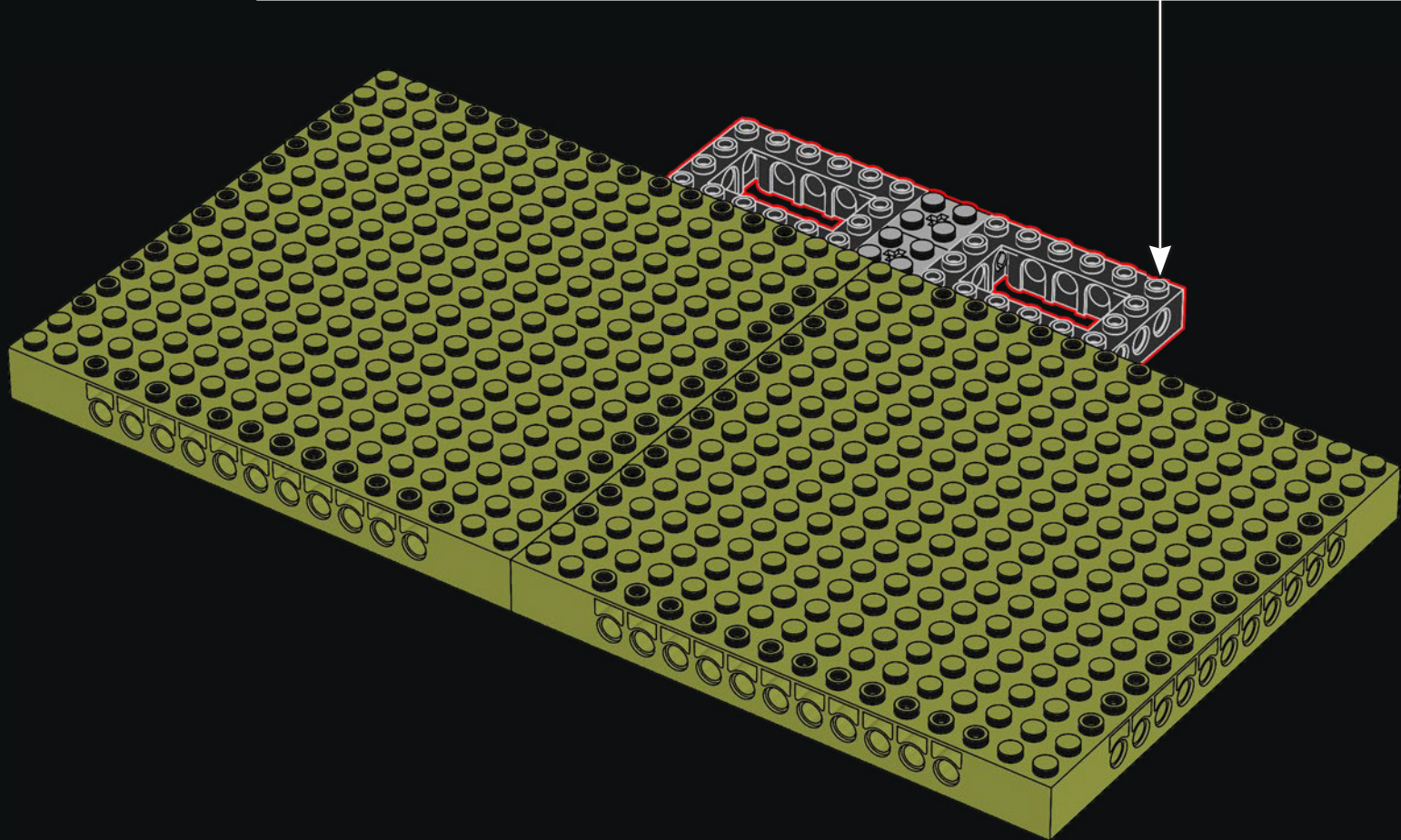
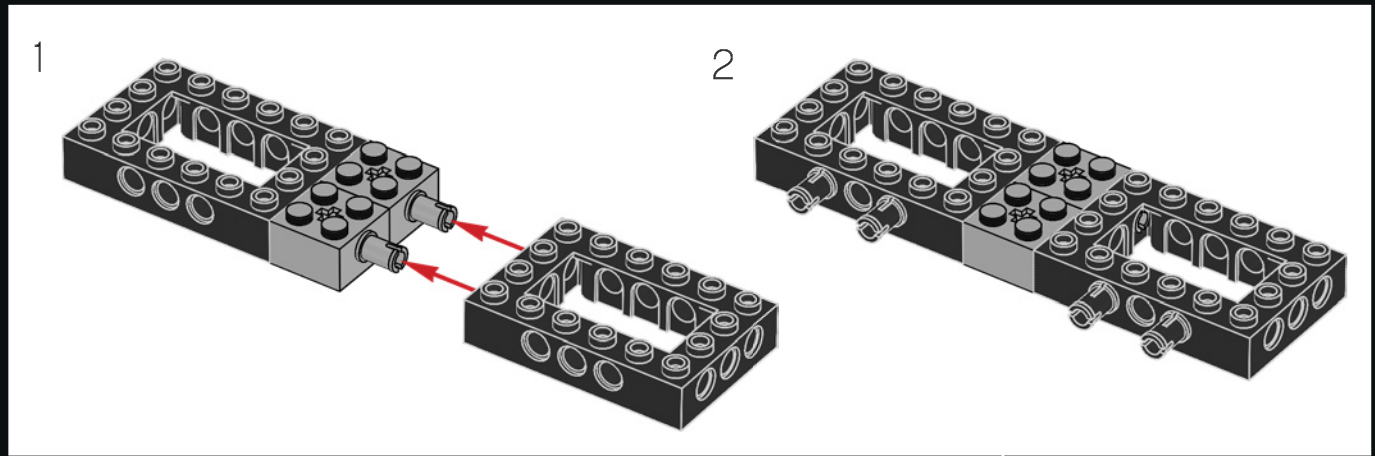



3

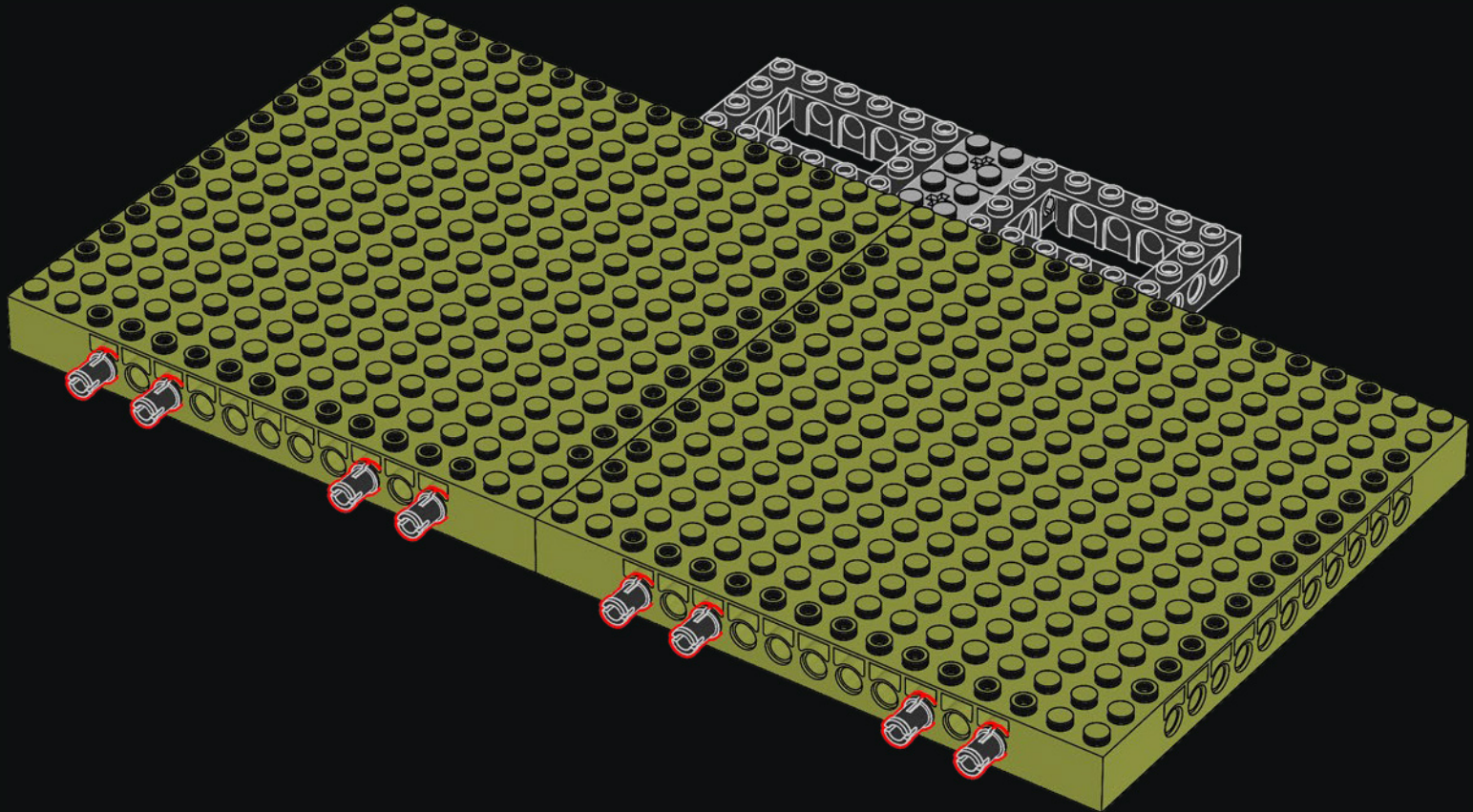

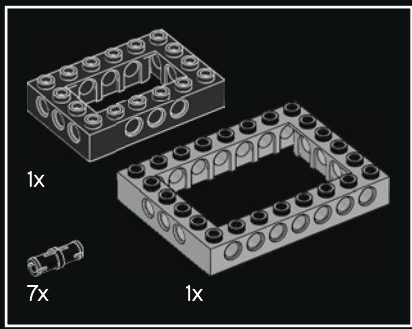

4

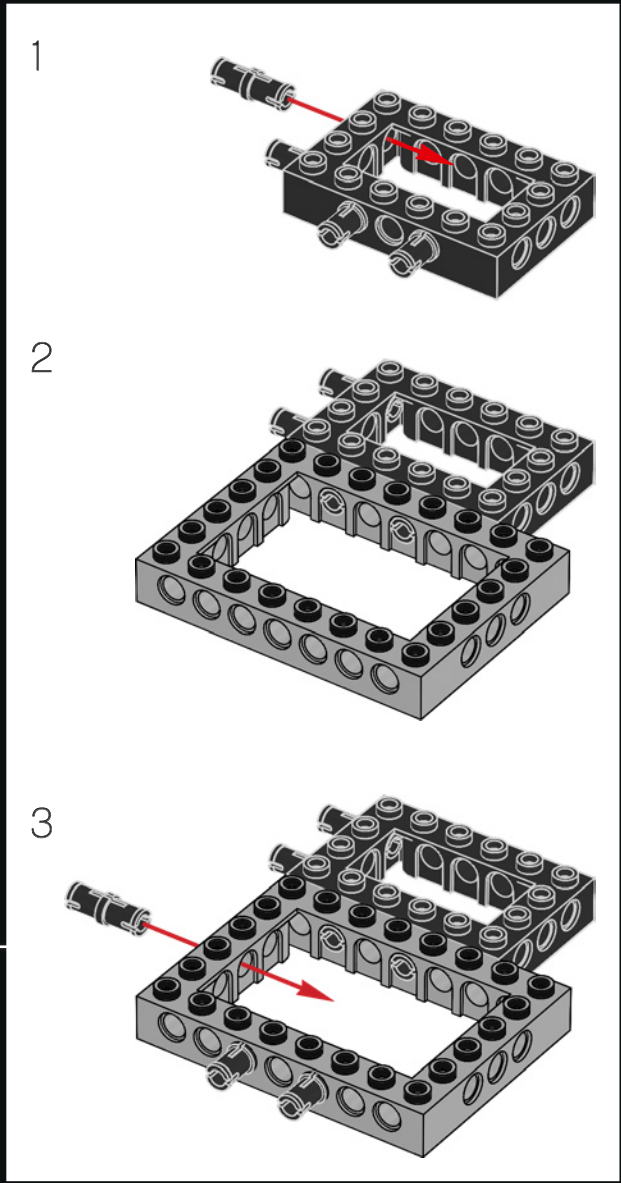
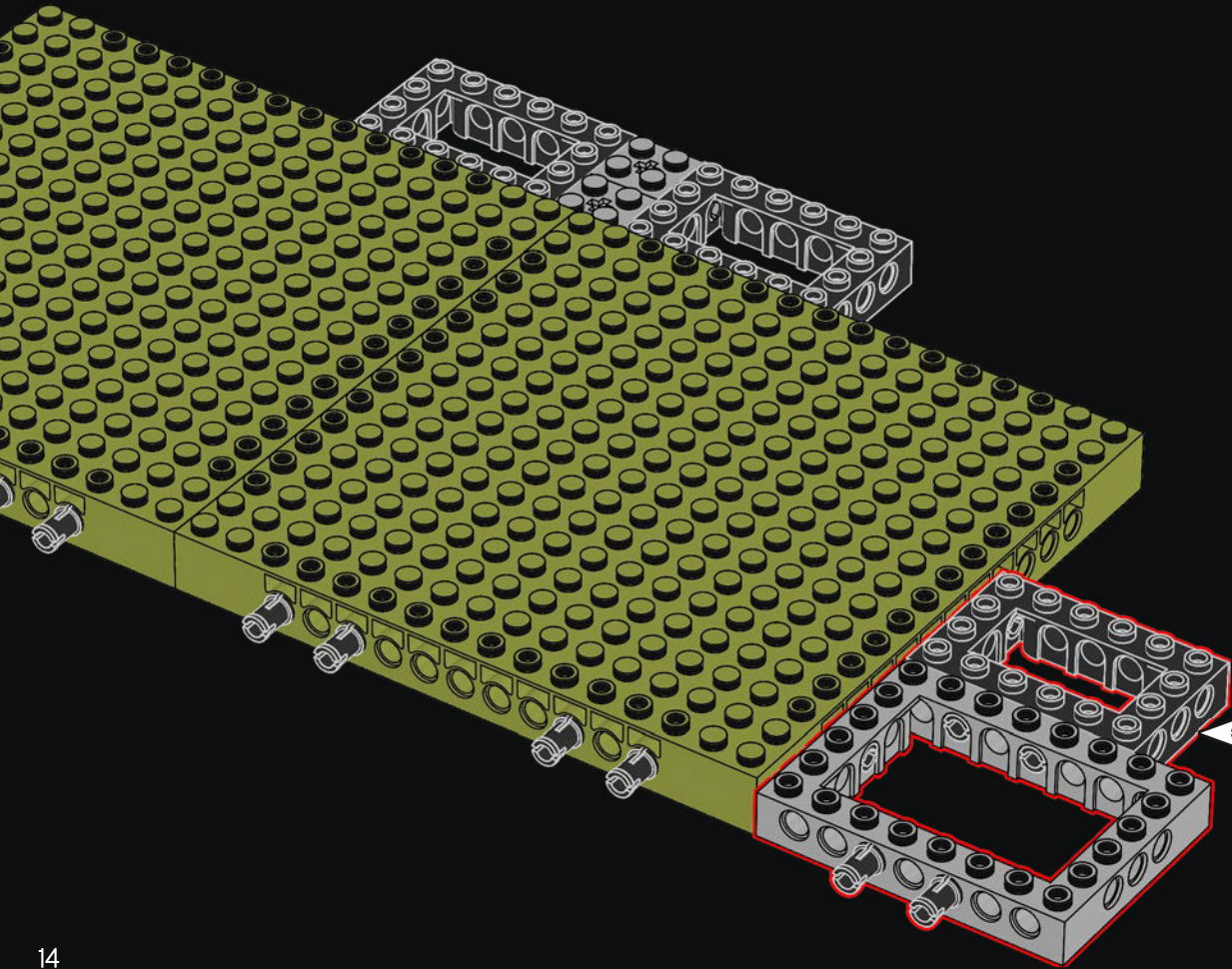

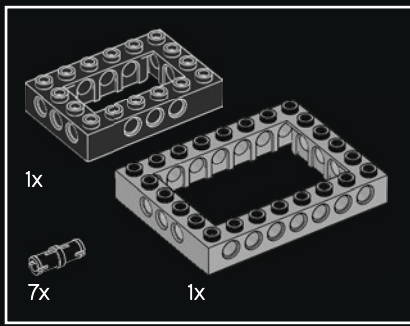

5

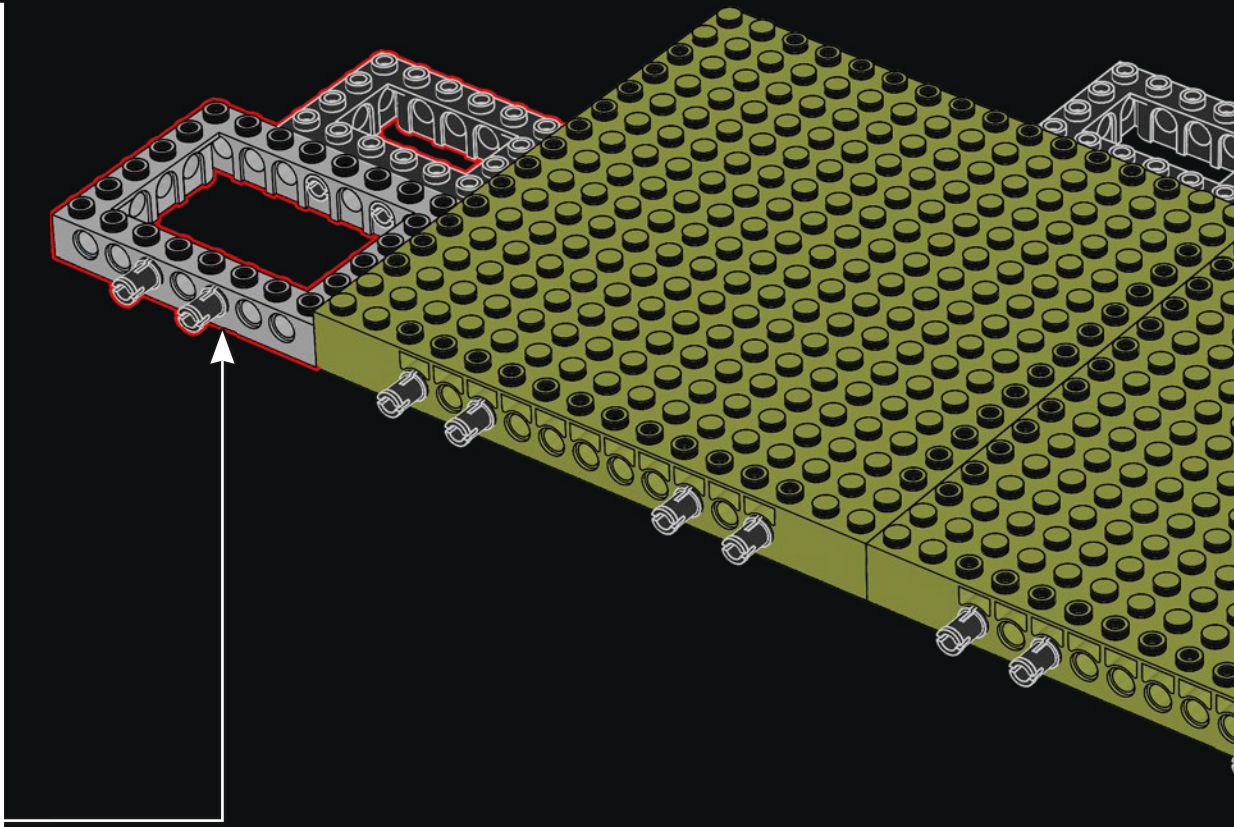
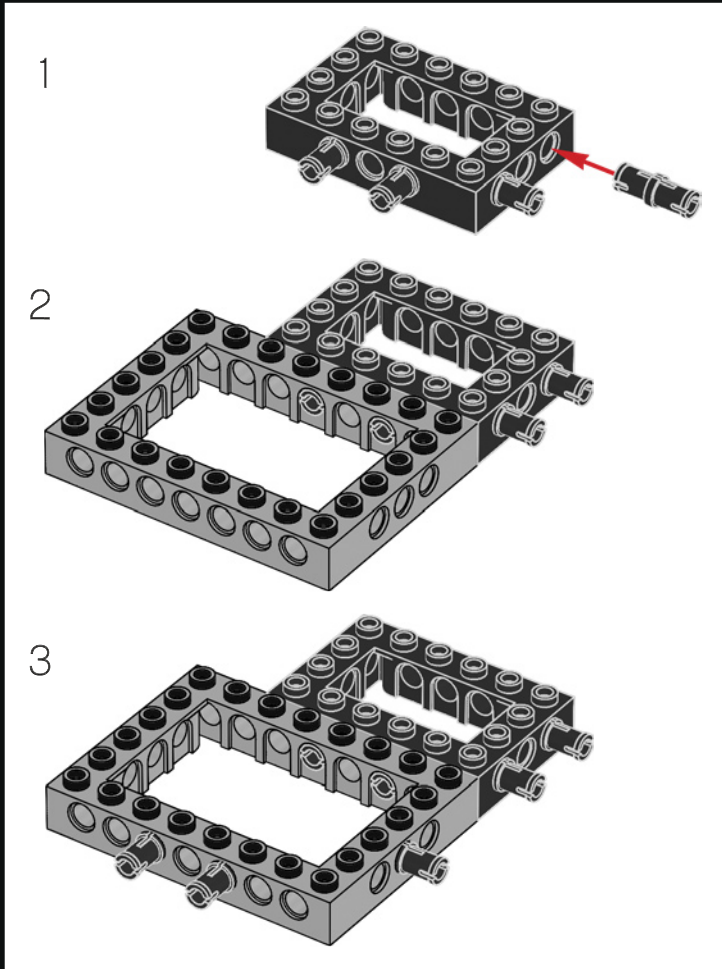



2x

6

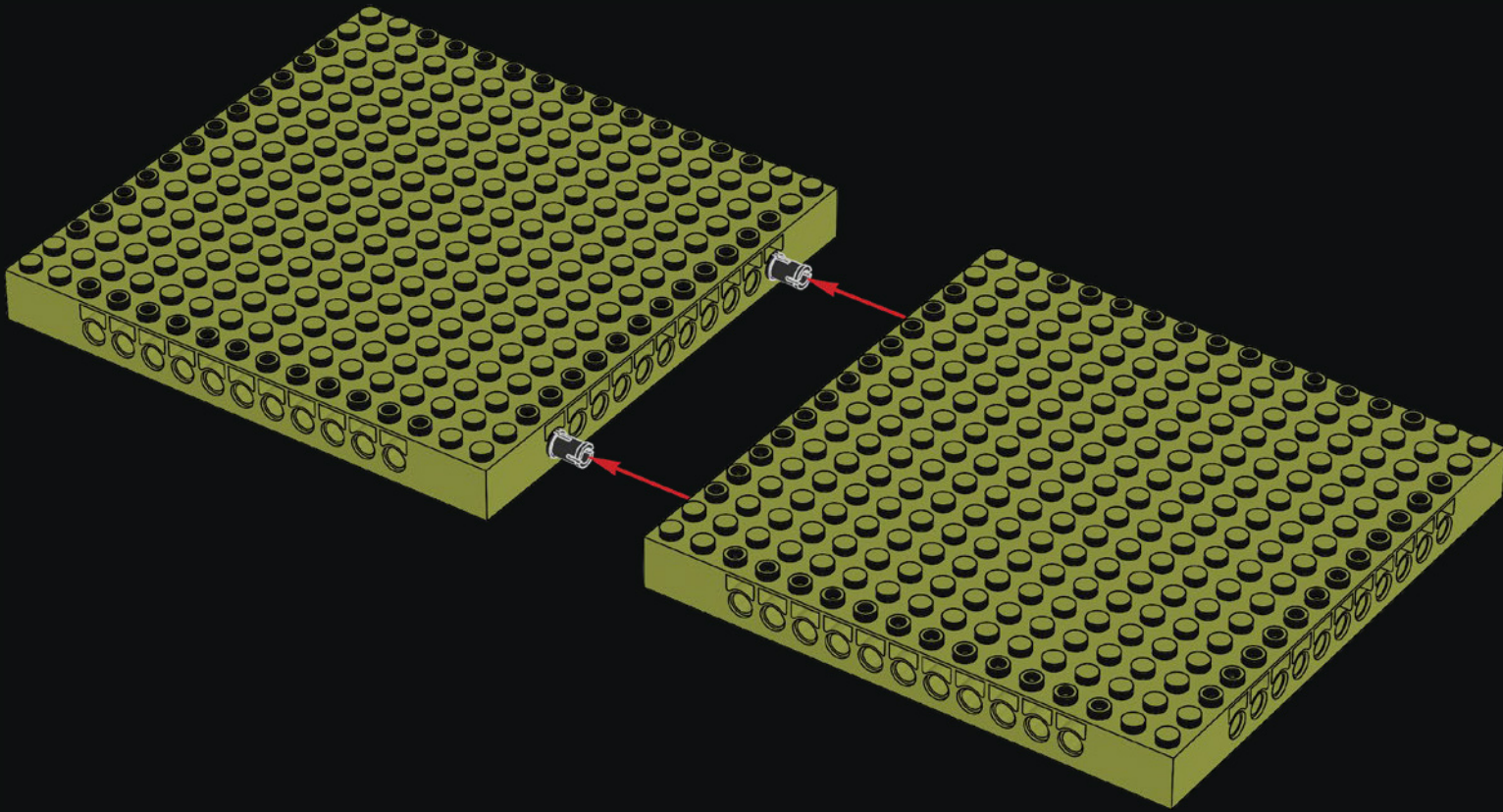



7

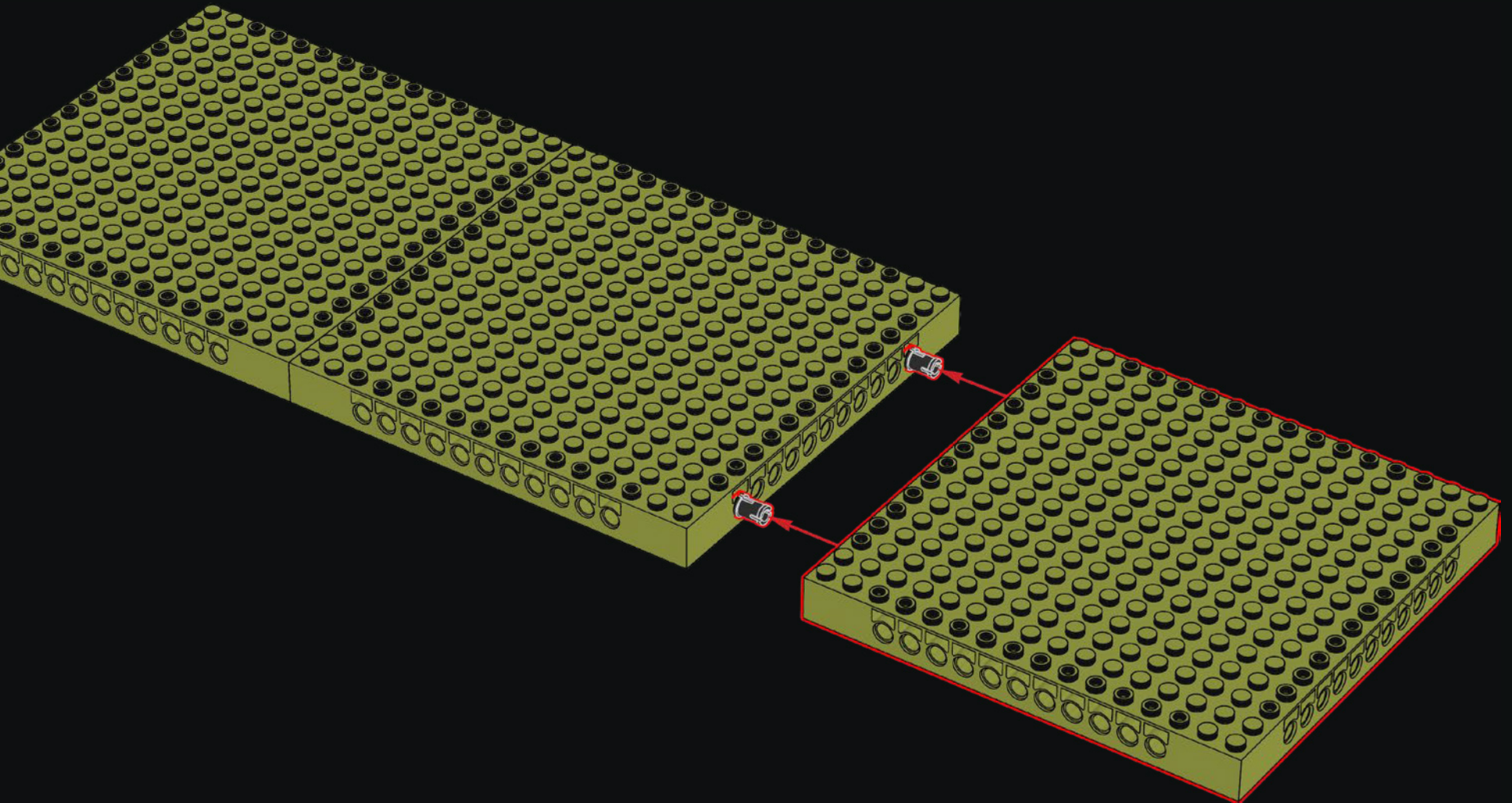

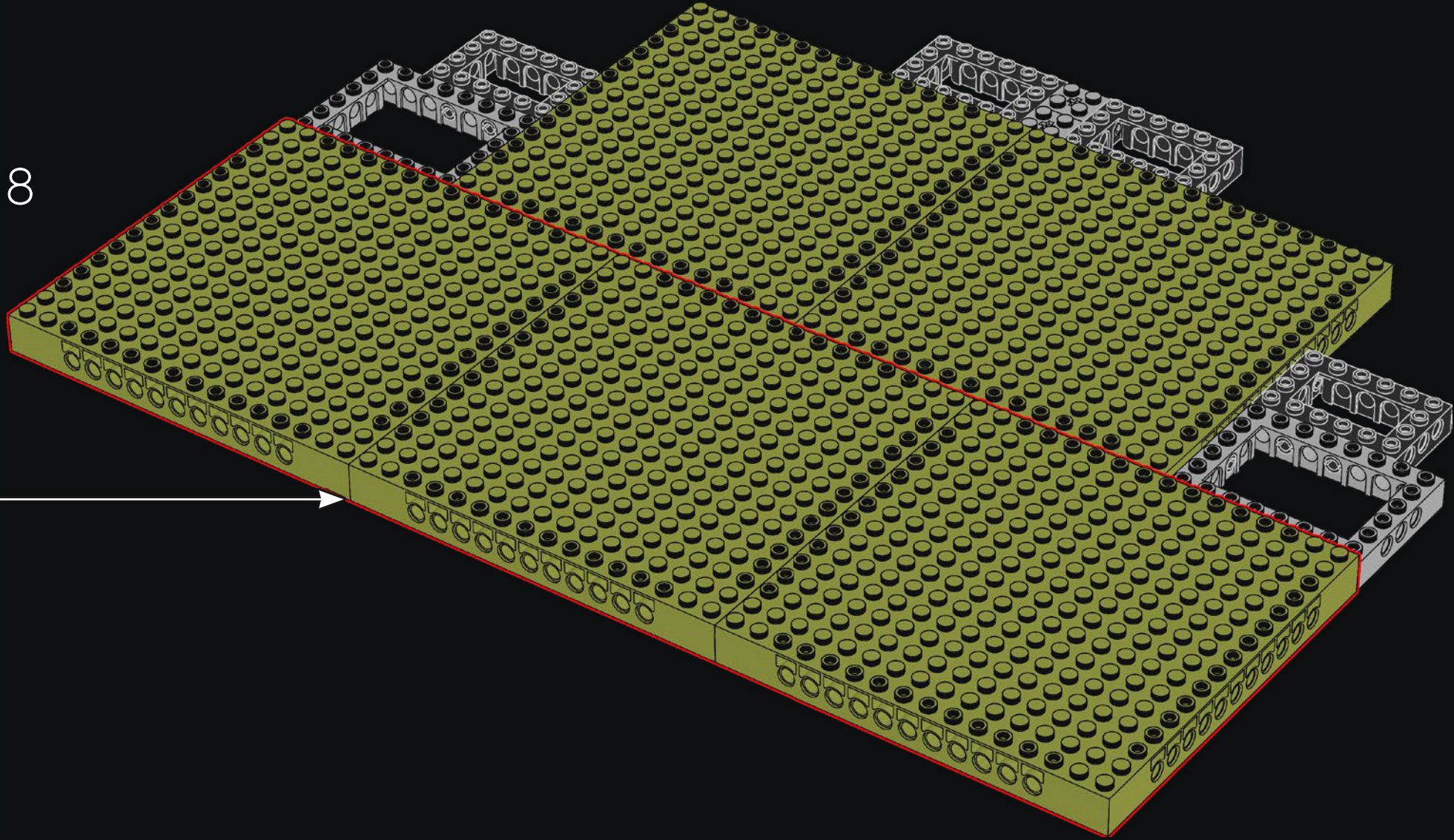

8

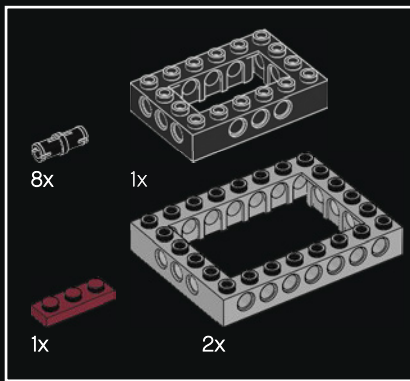

9

1

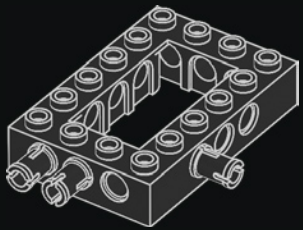

2

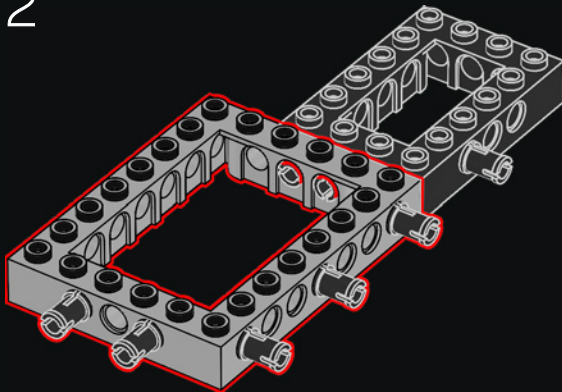

3

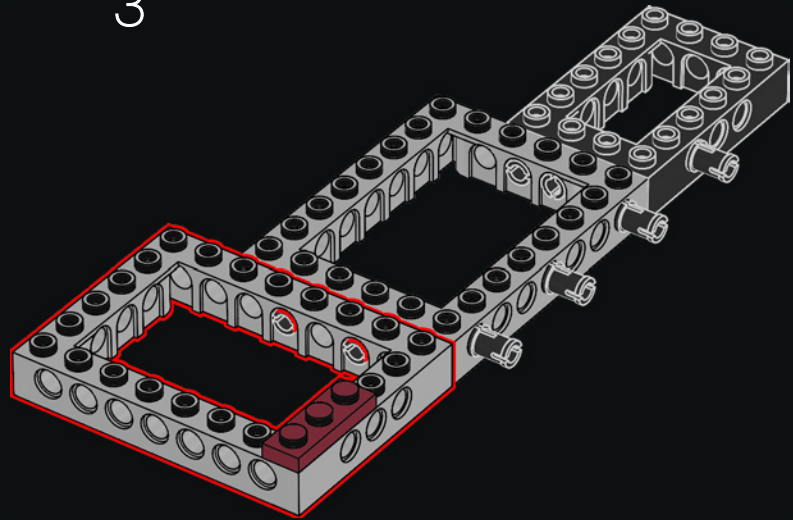

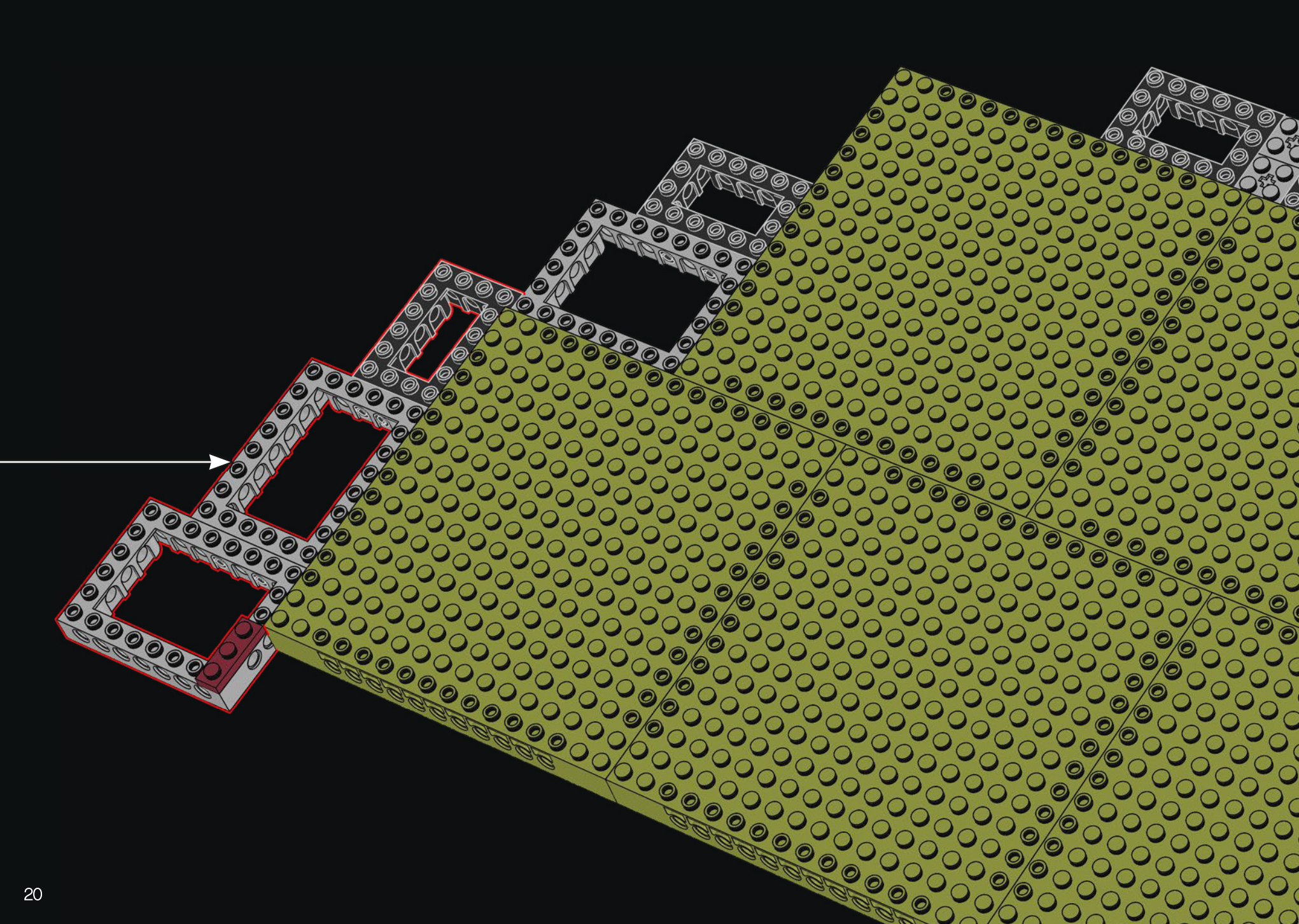

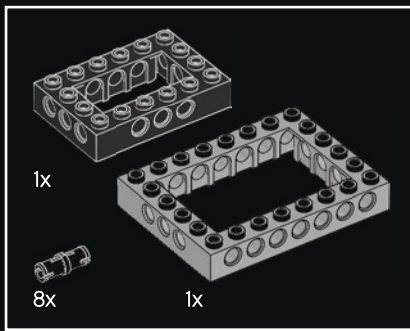

10

1

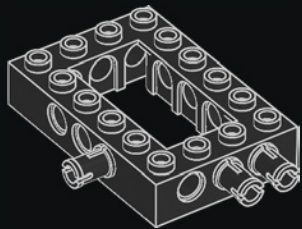

2

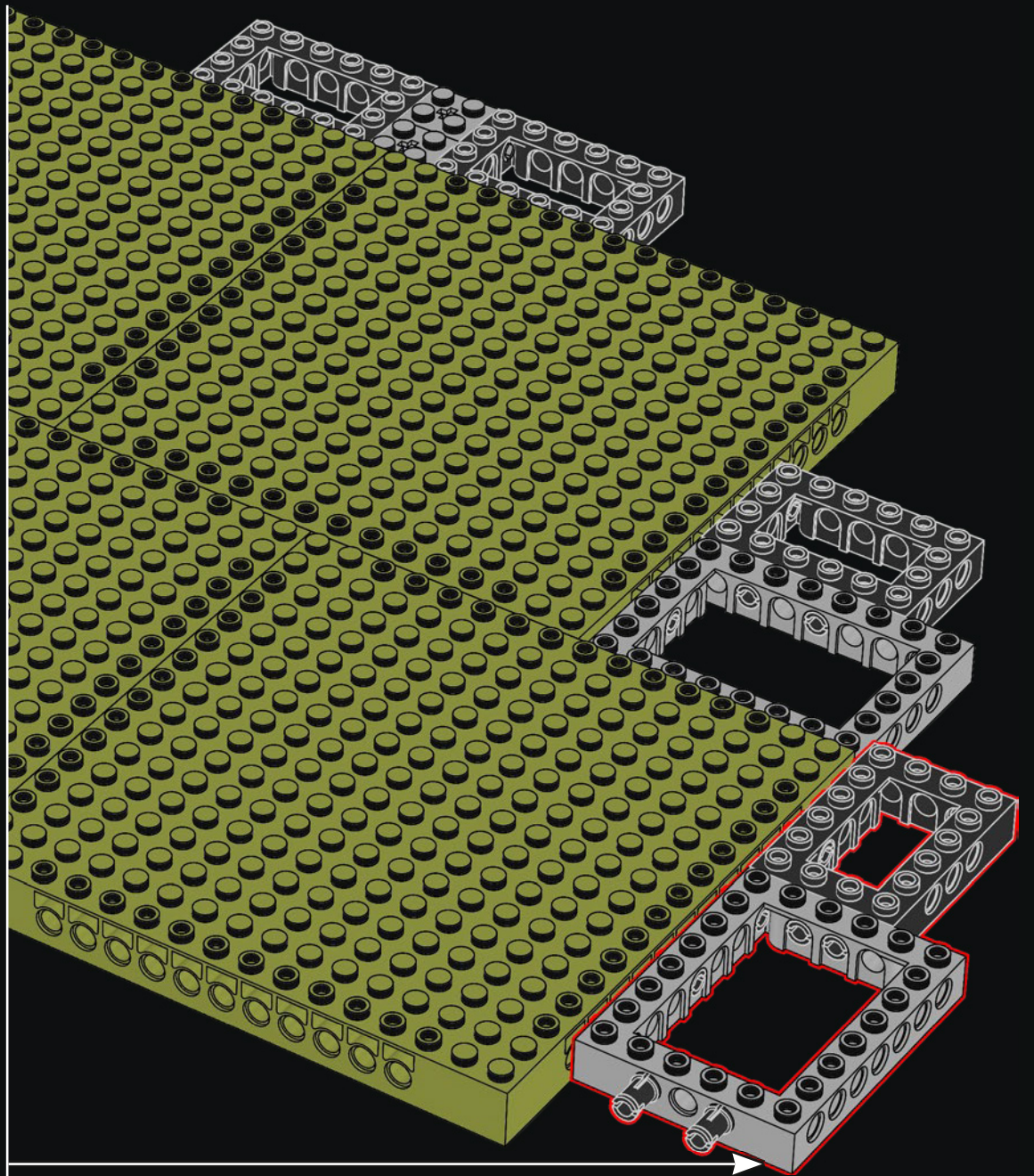
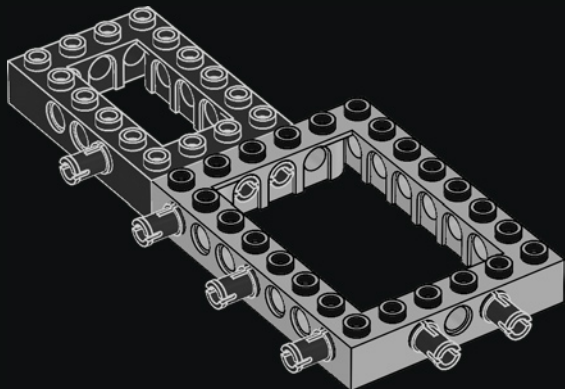

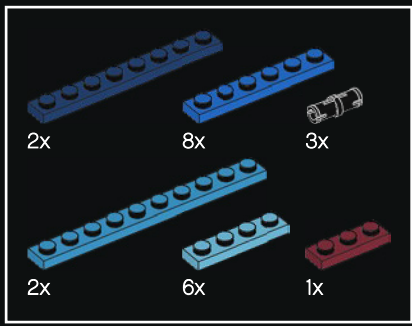

11

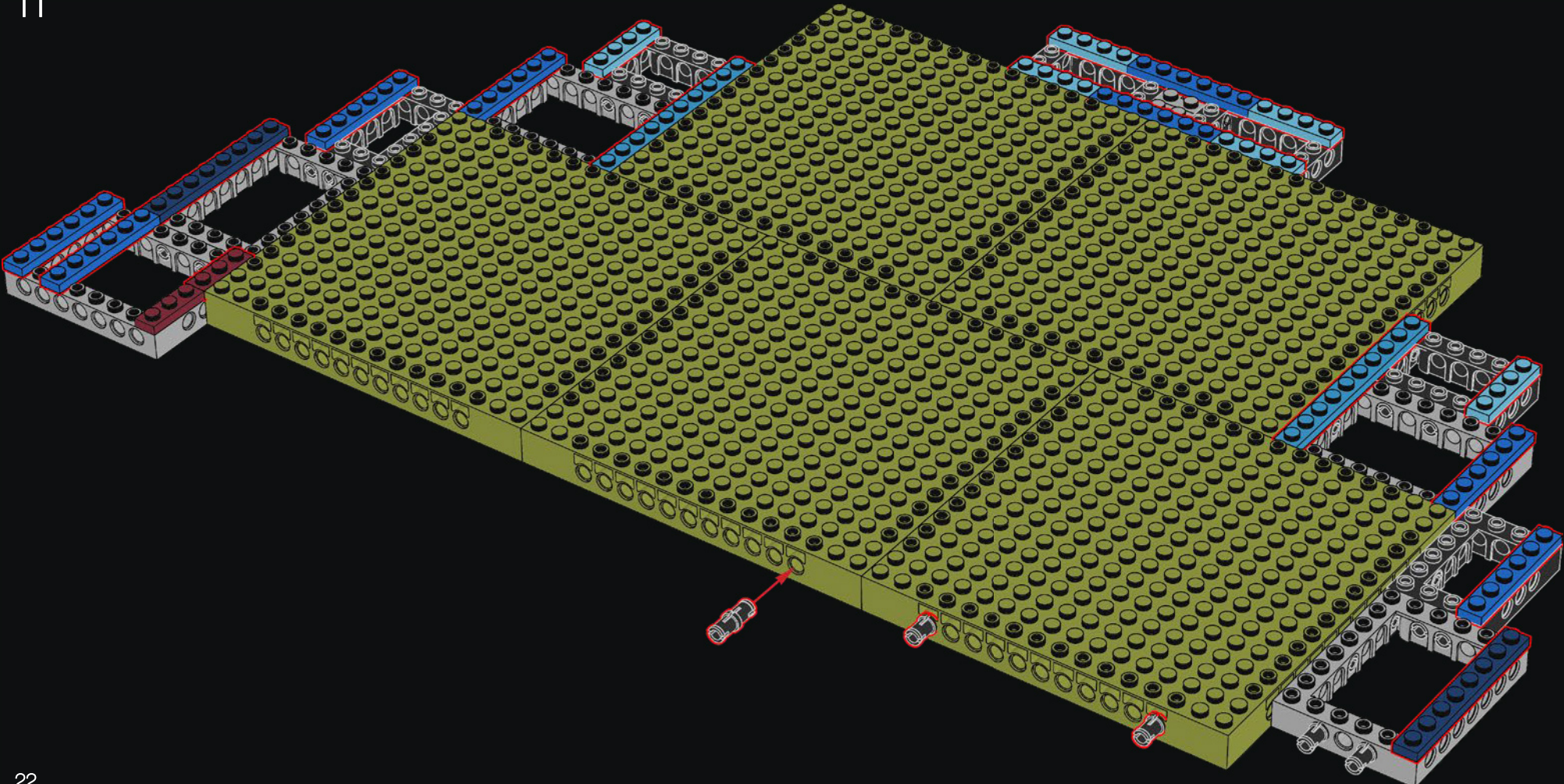

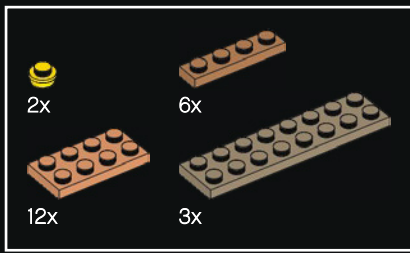

12





46x

13

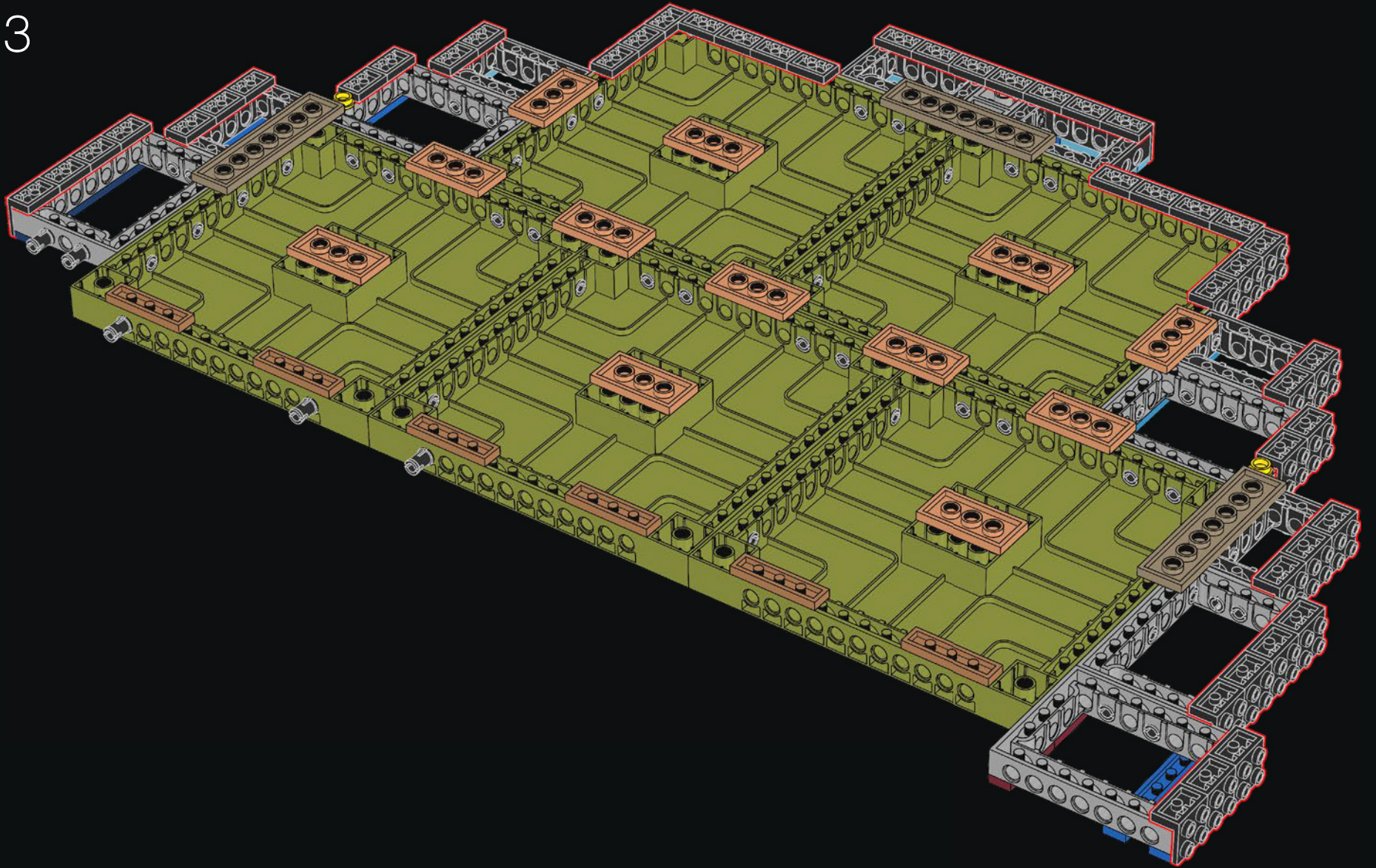

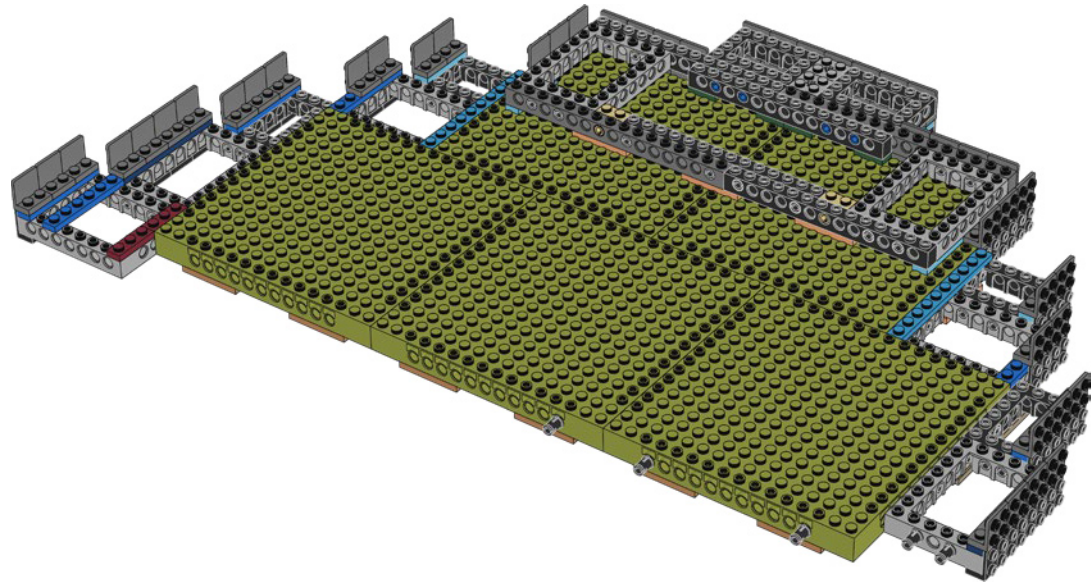
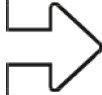



46x

14

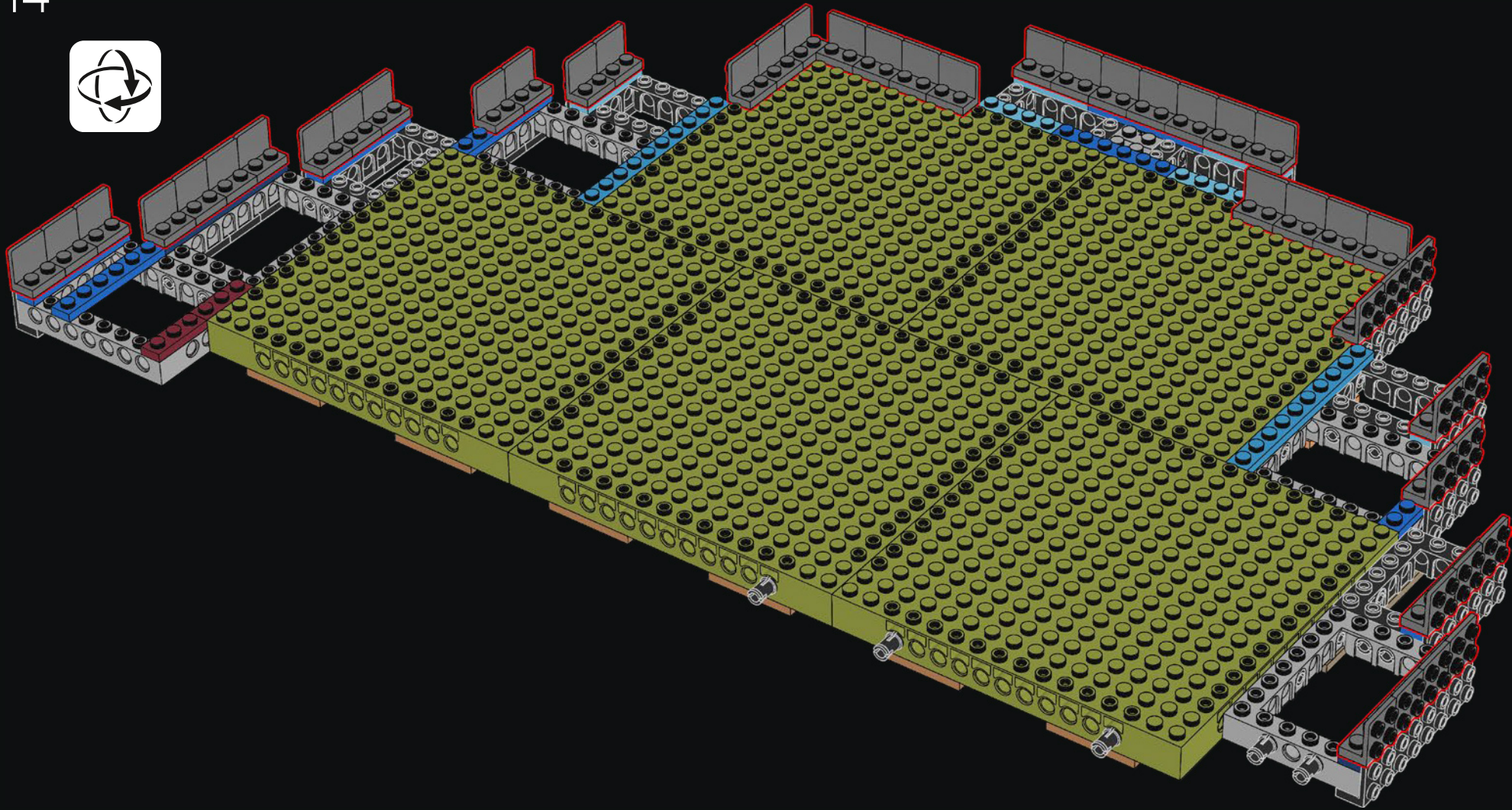

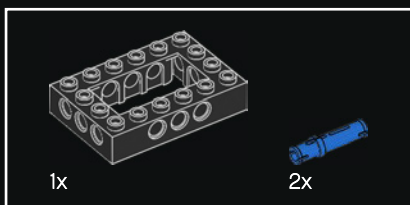
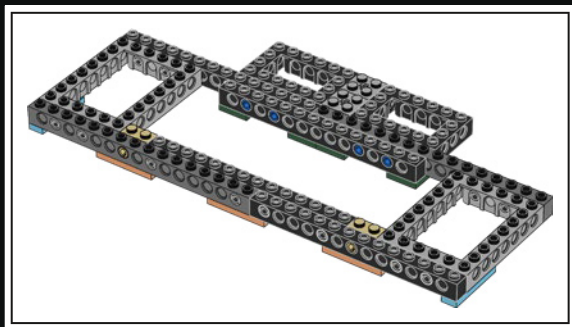

15

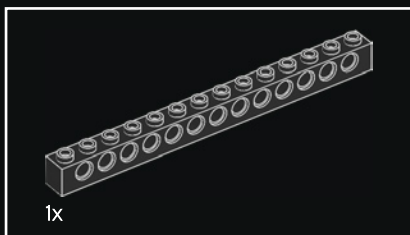
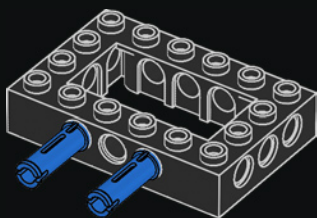

16

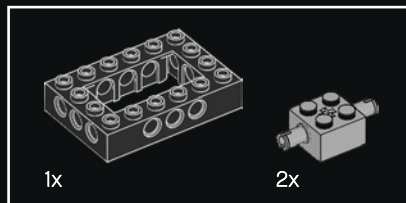
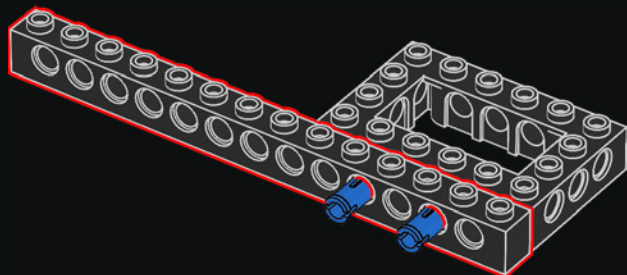

17

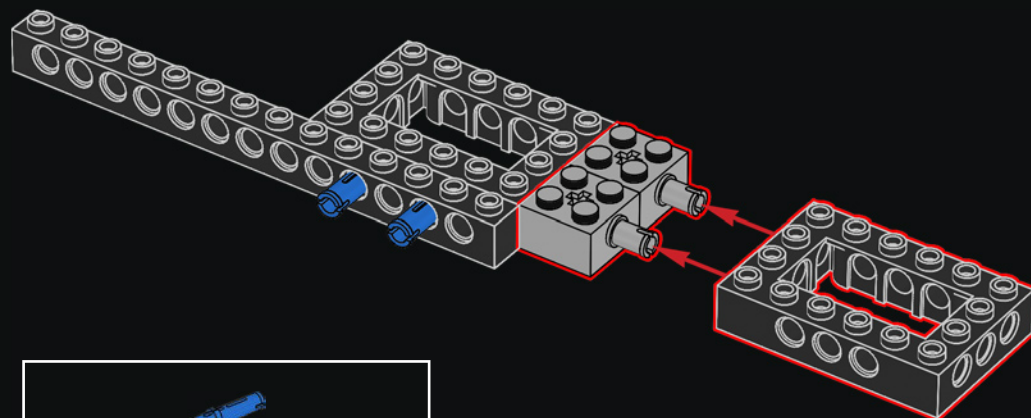

18

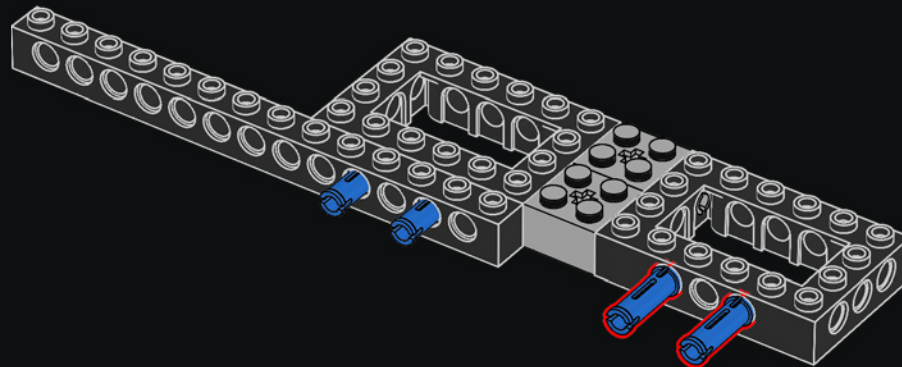

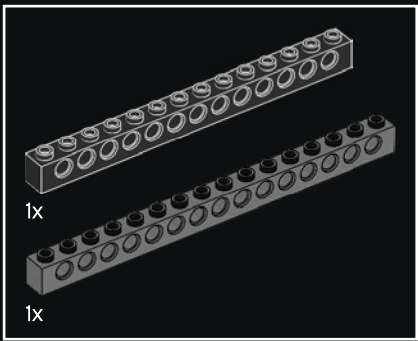

19

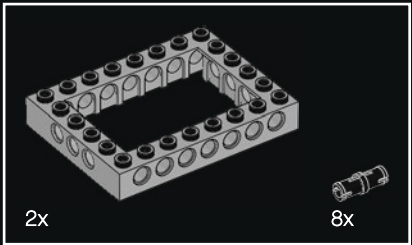
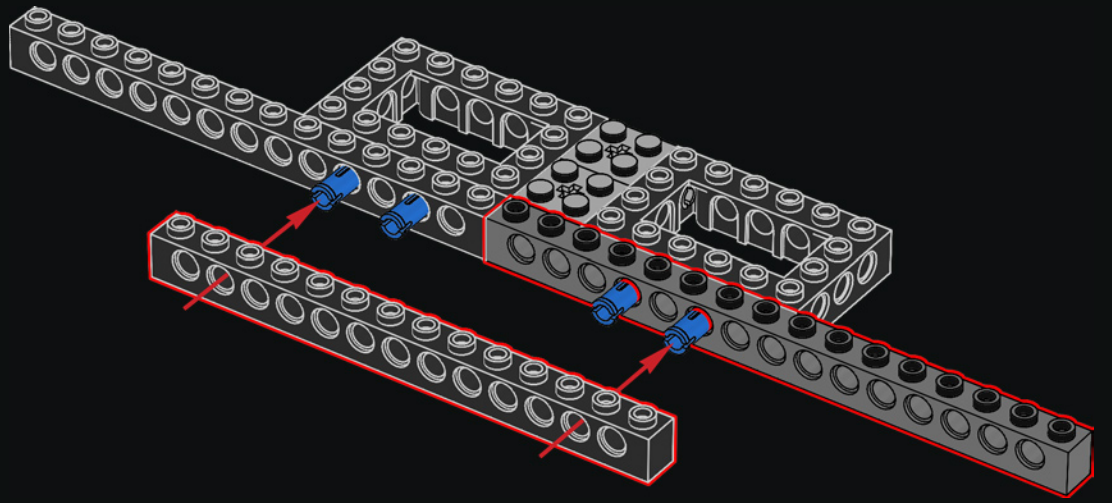

20

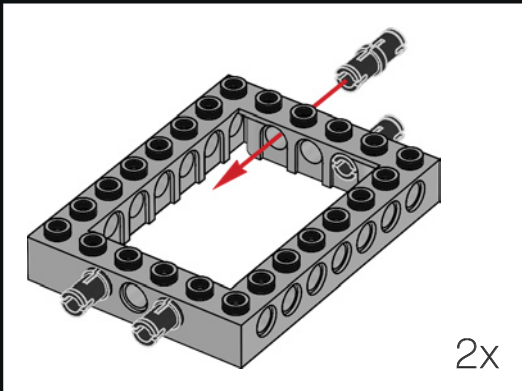
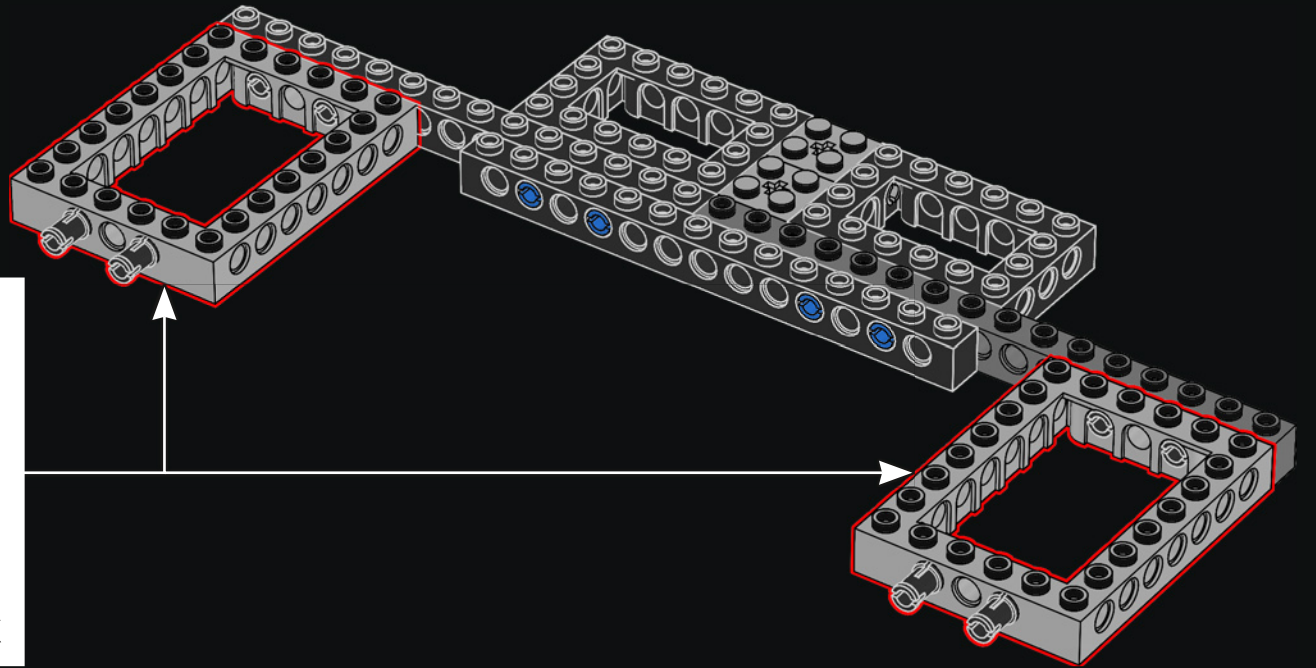

28

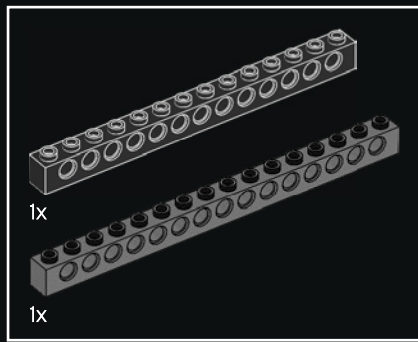

21

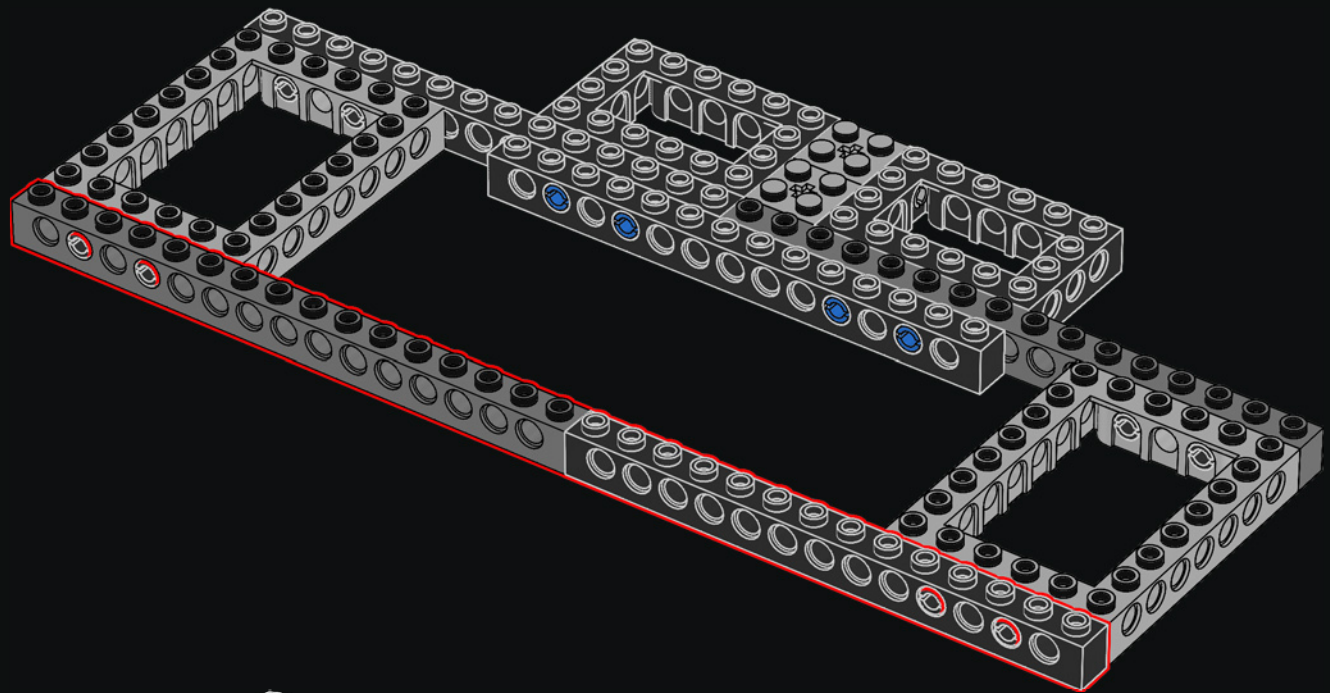

22

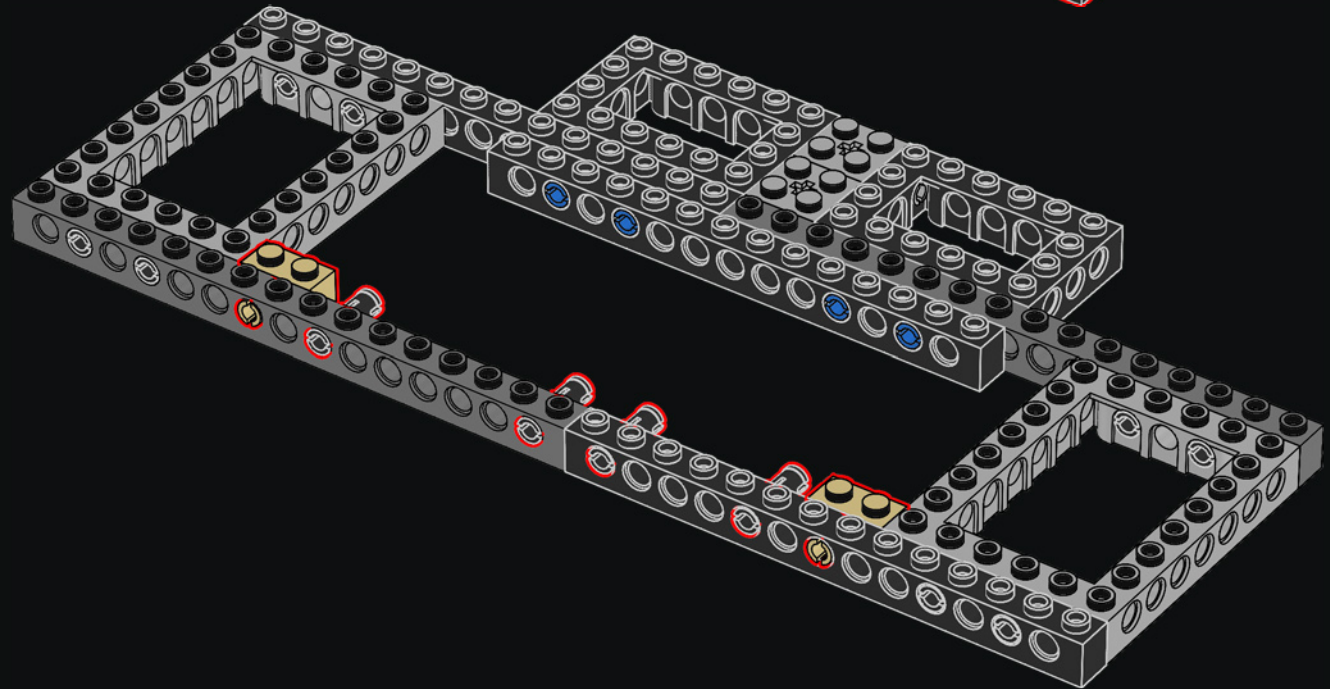

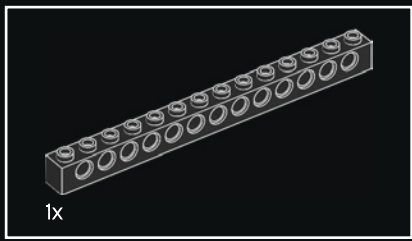

23

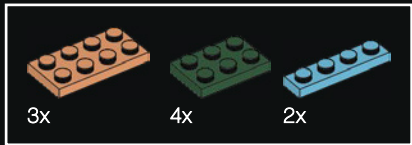
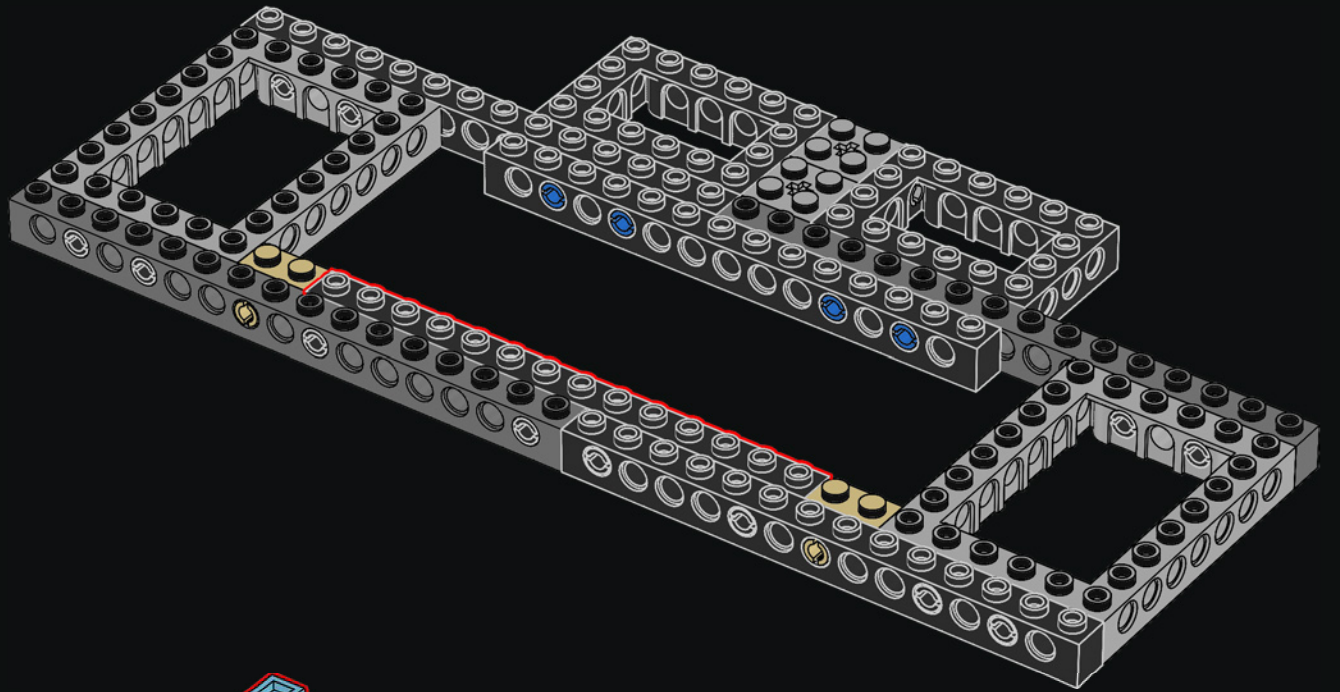

24

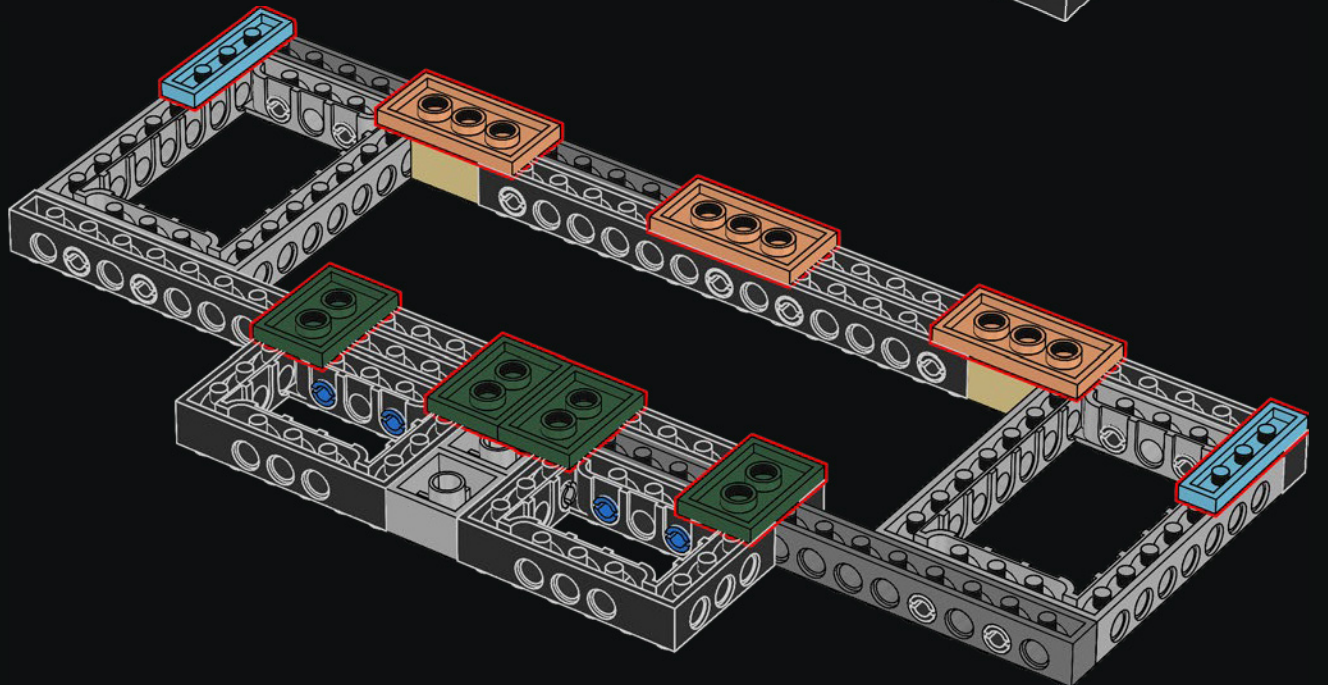

25

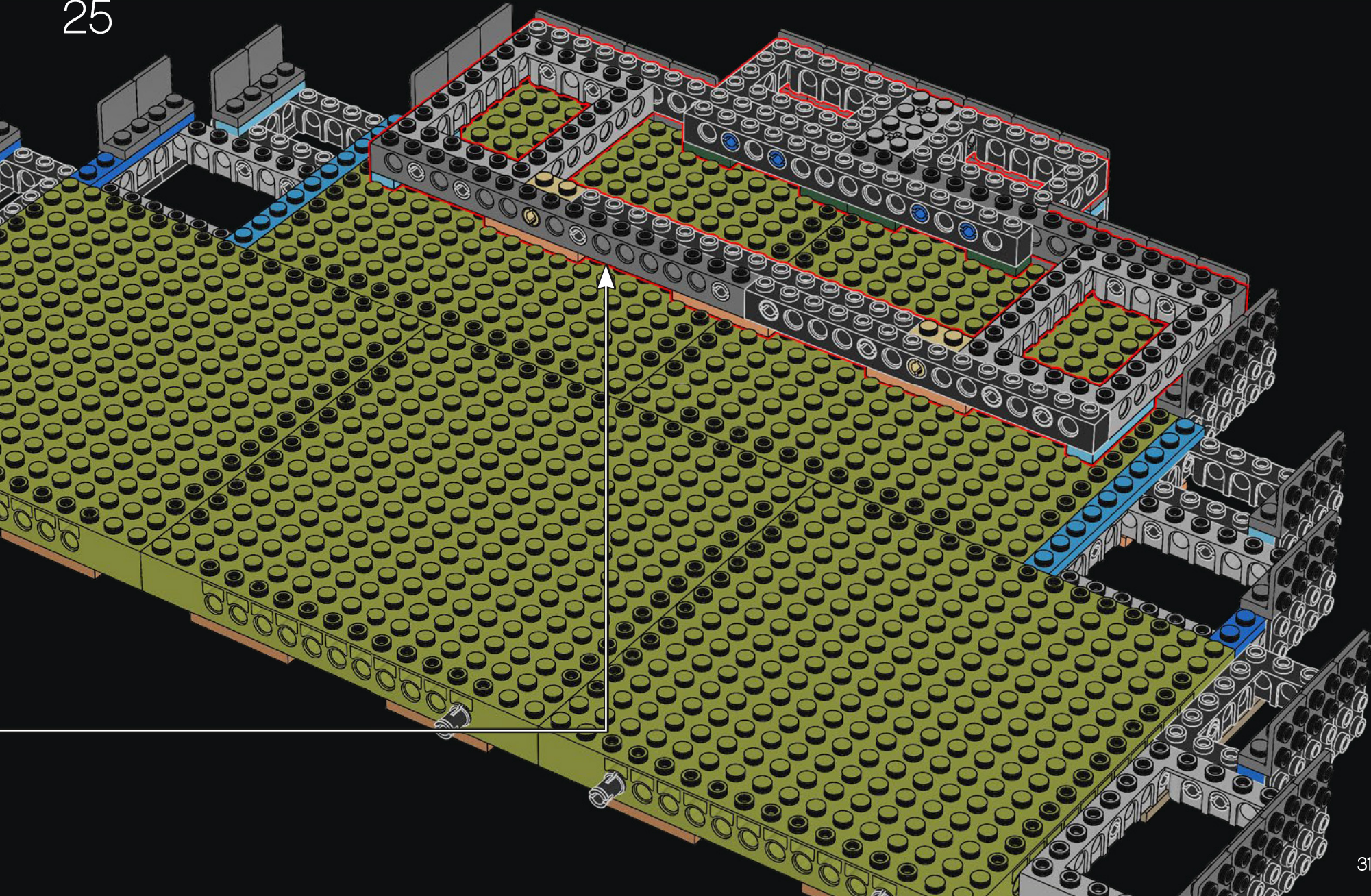

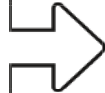

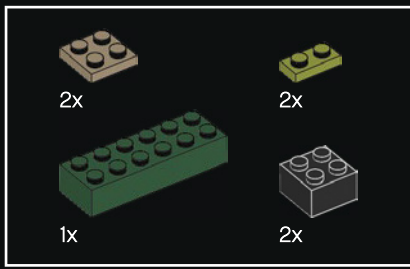

26

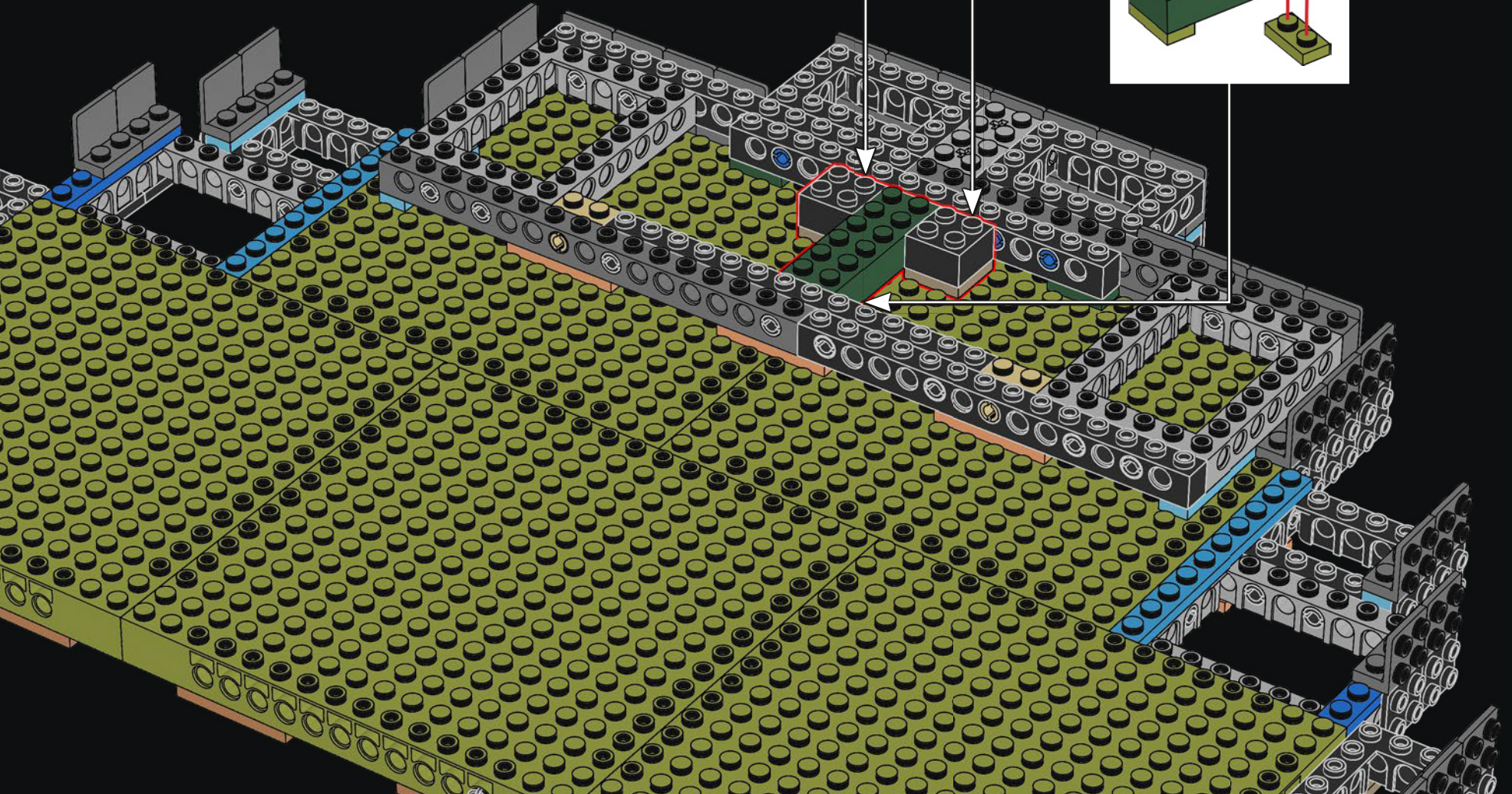
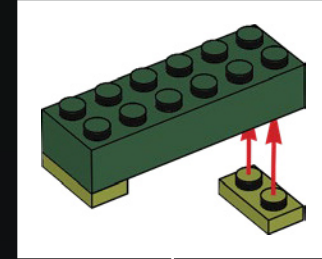
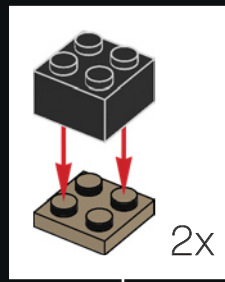

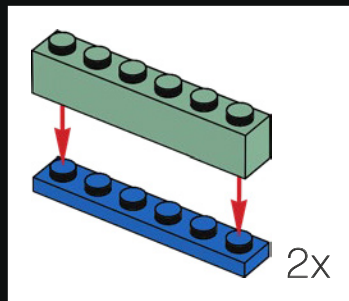
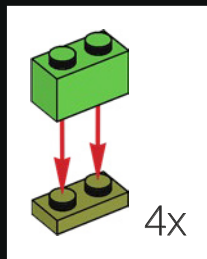
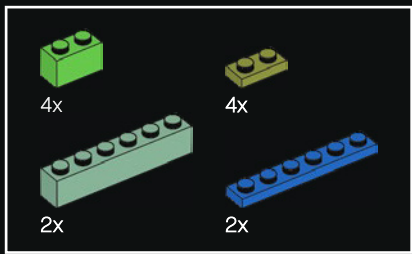

27

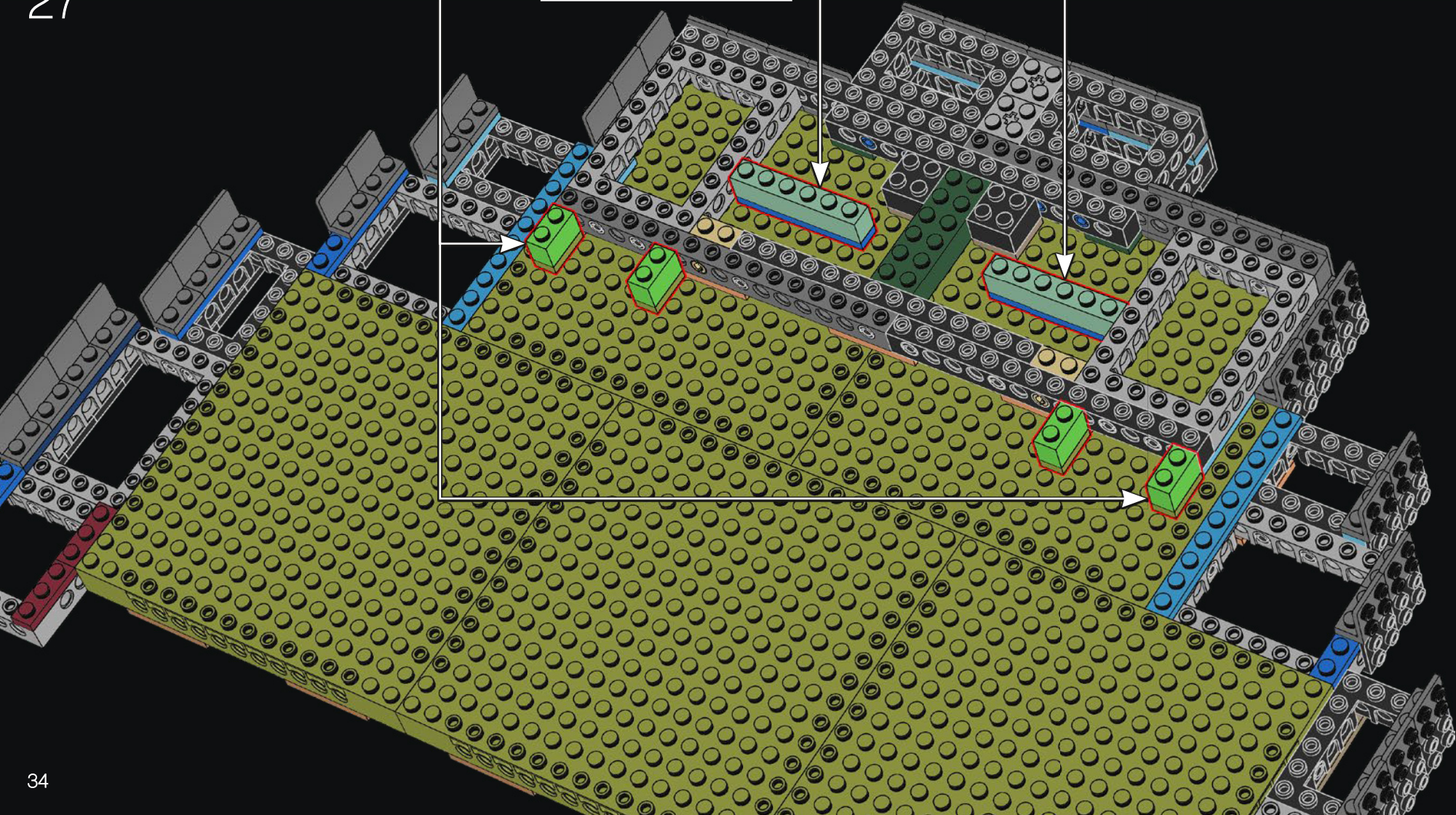

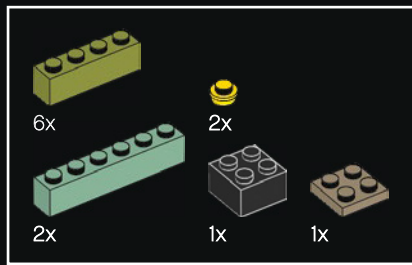

28

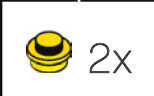
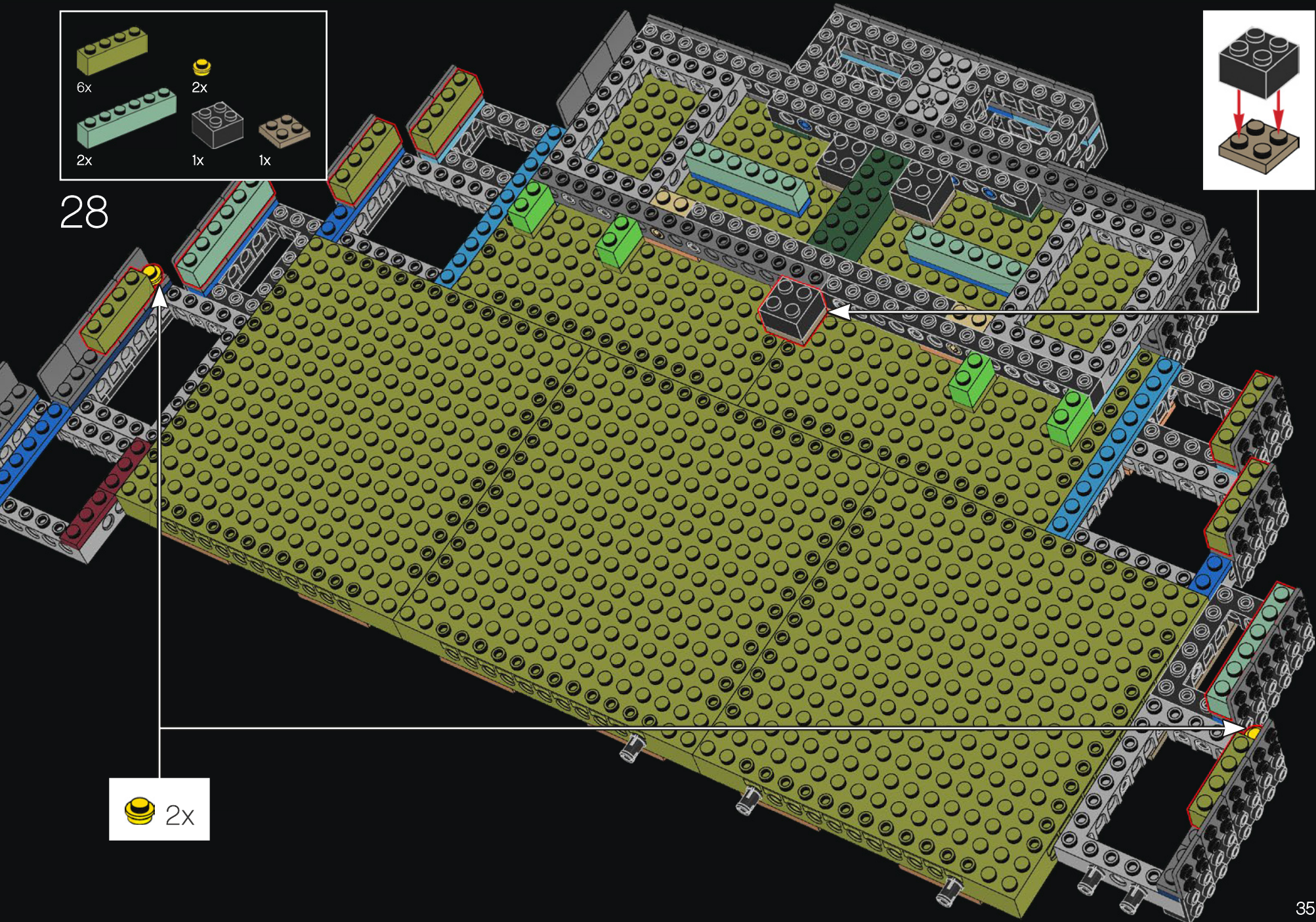
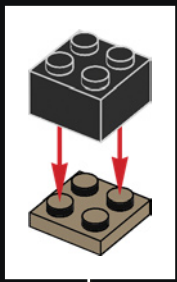

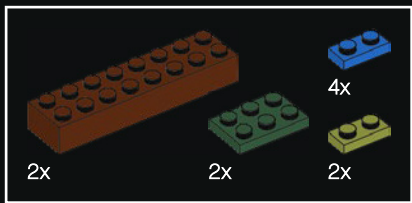

29

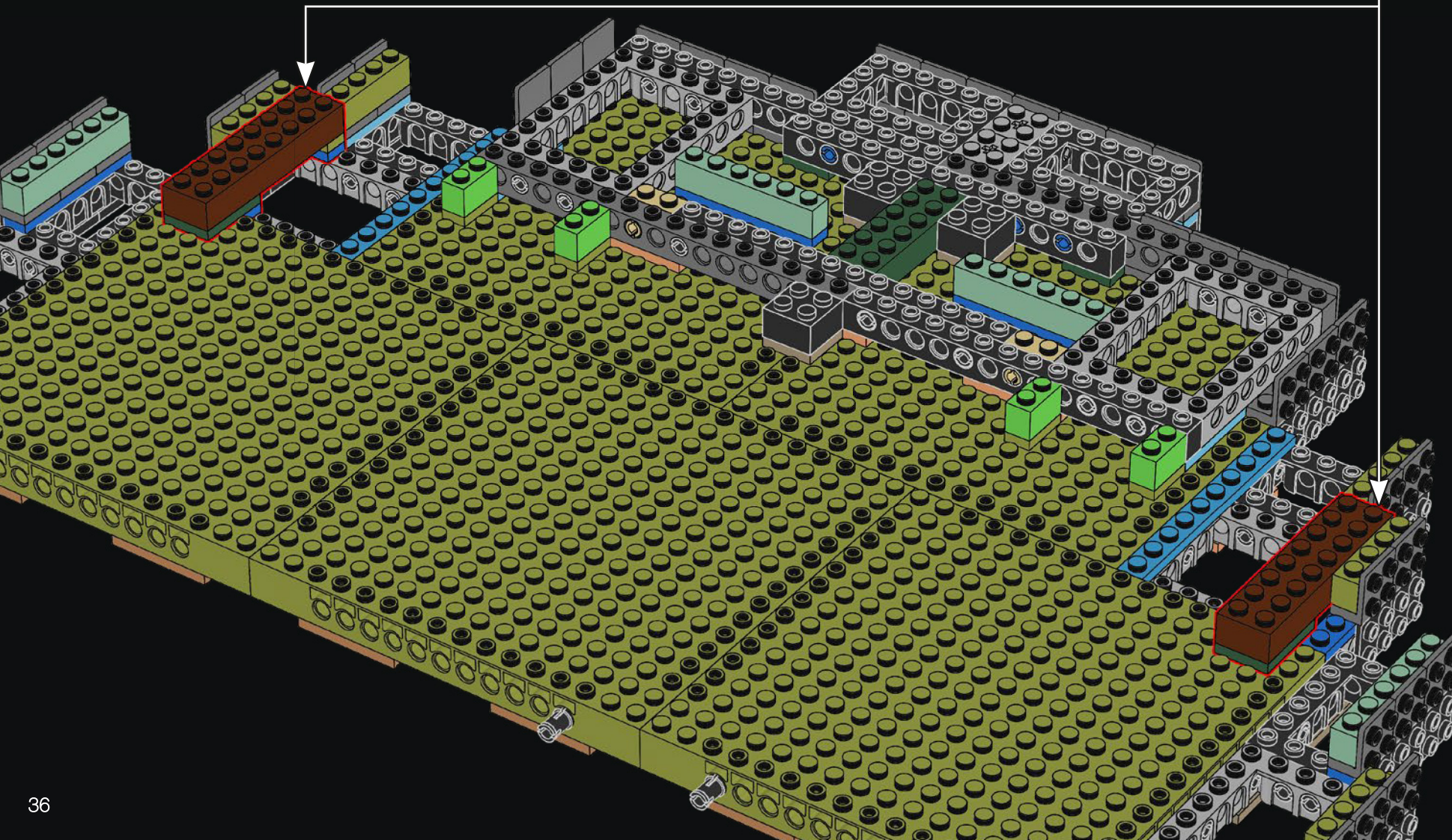
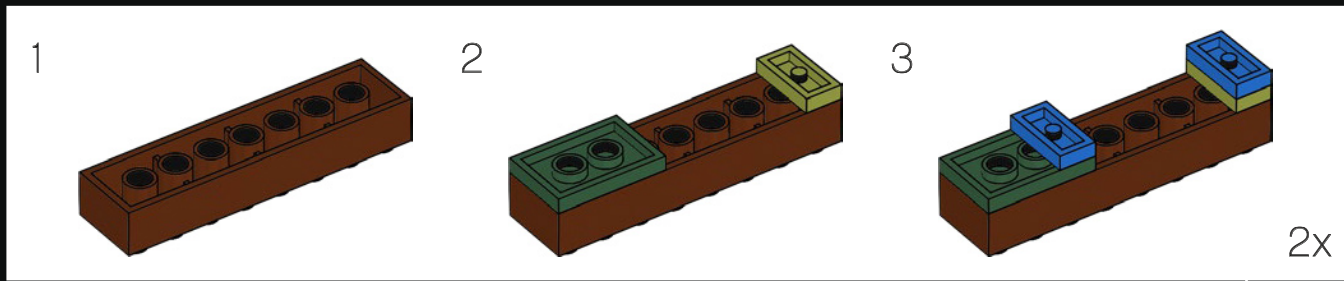

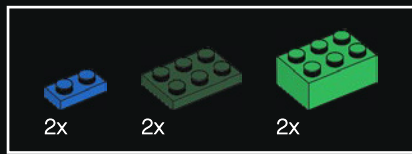

30

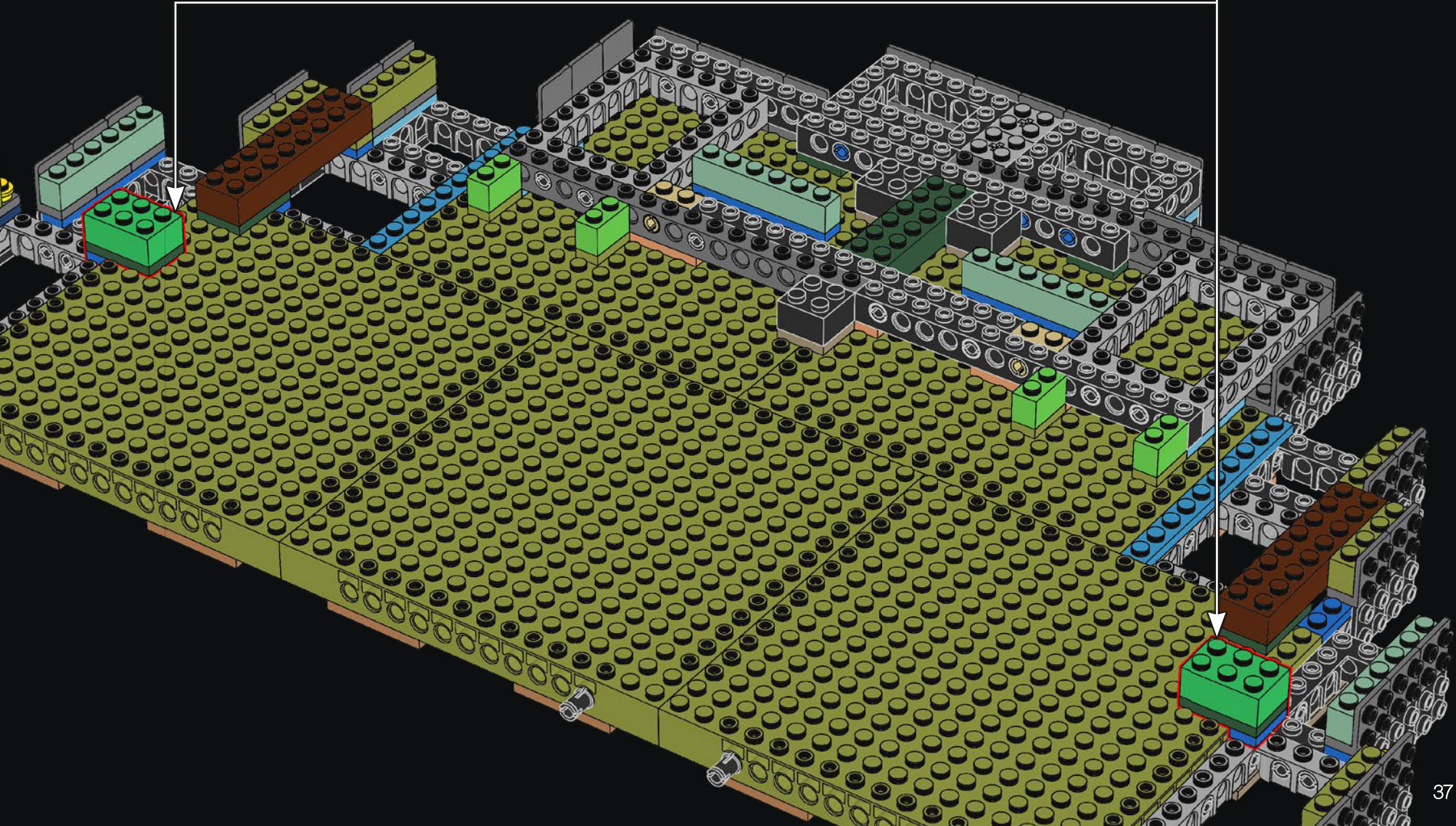
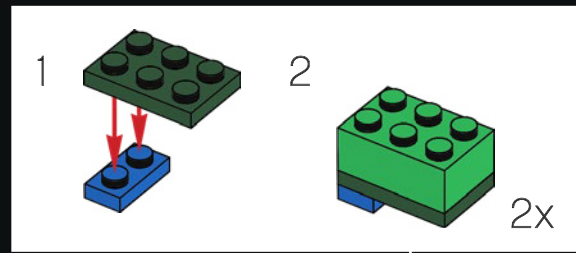

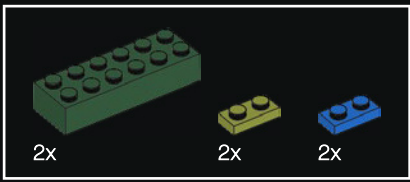

31

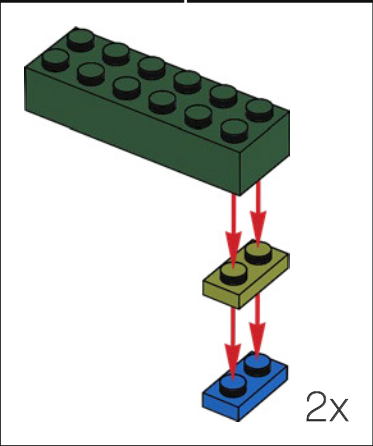
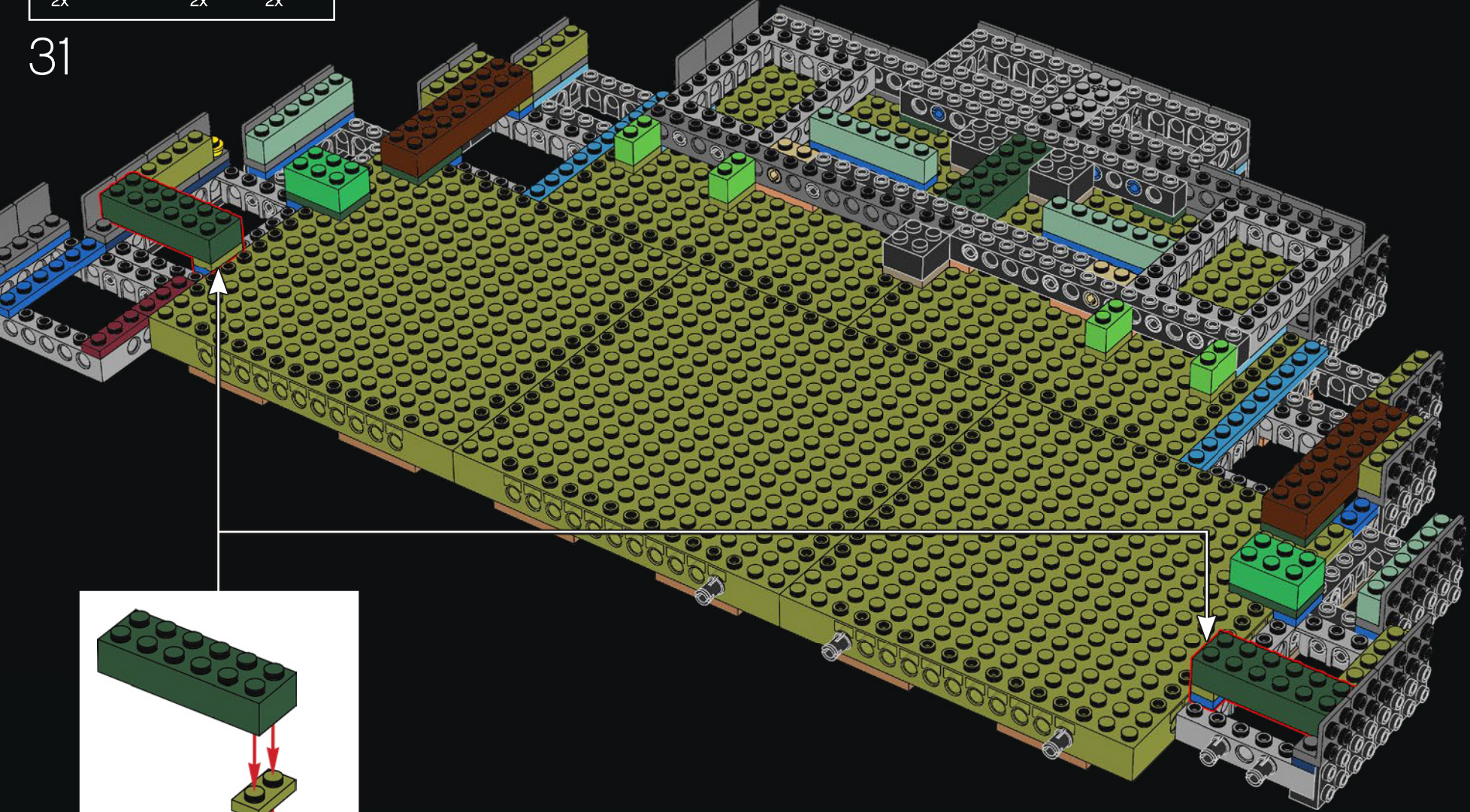

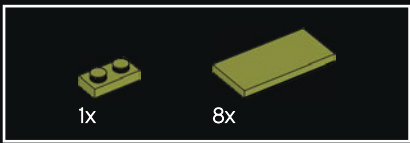

32



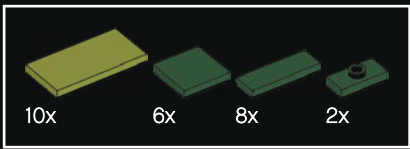

33



34

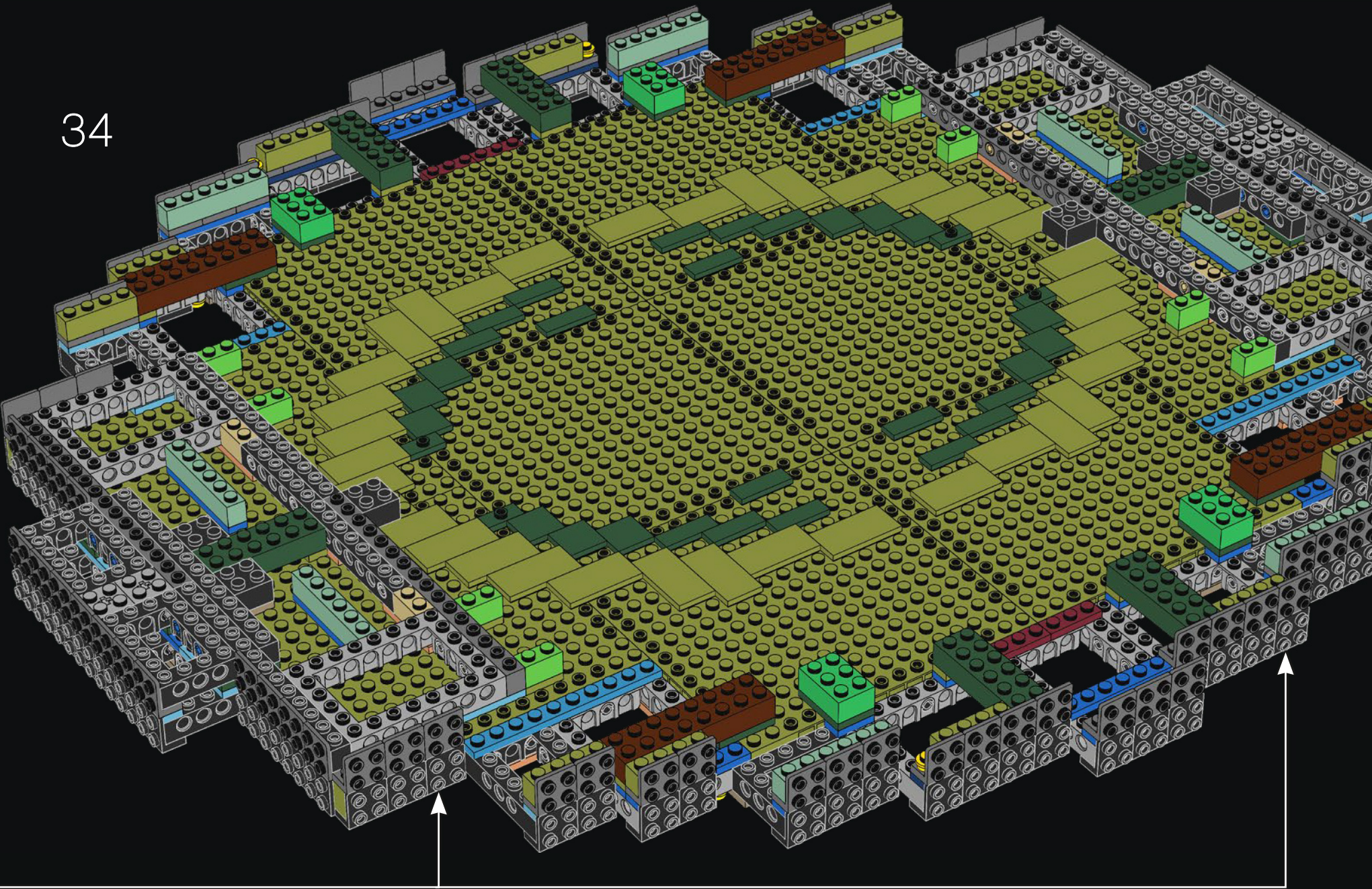

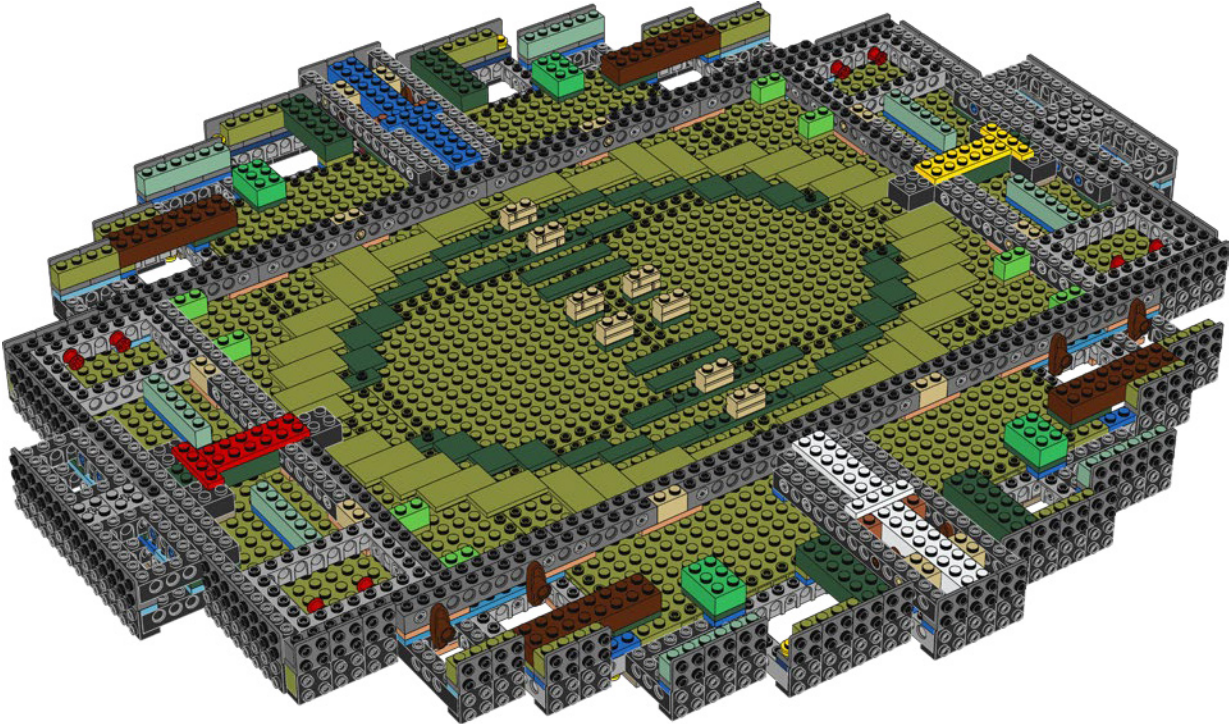
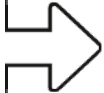

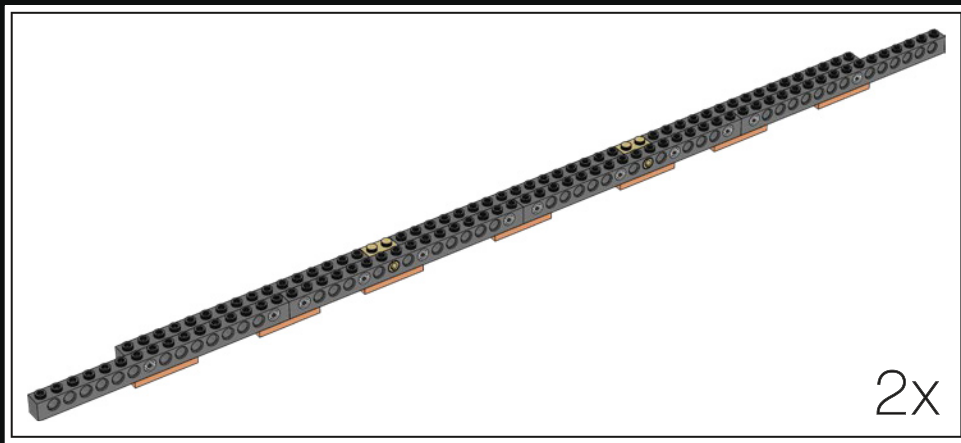

2x

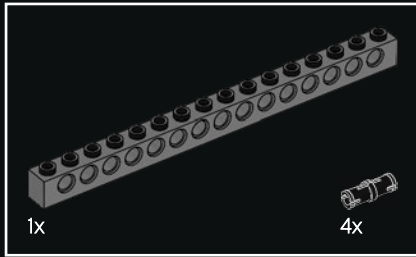

1x

4x

35

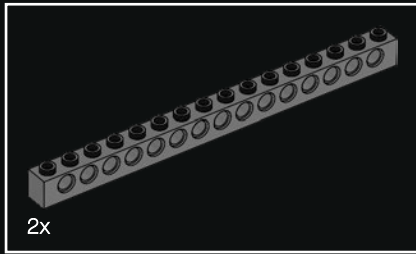
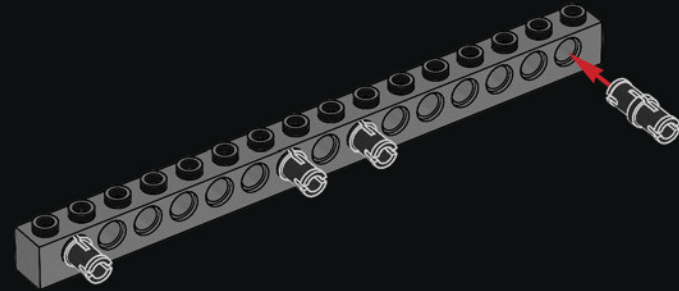

2x

36

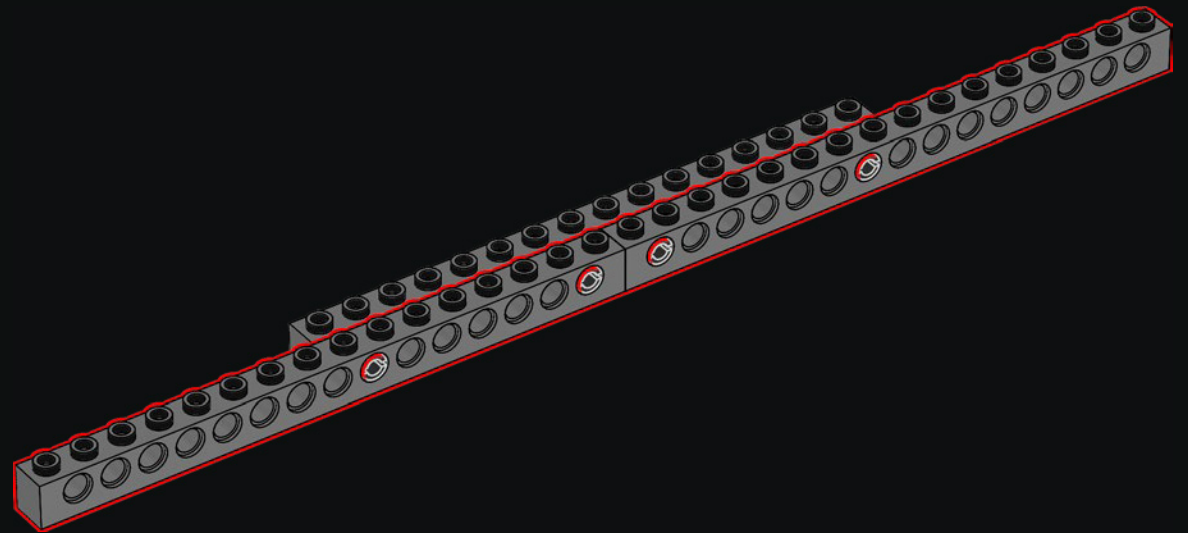



37

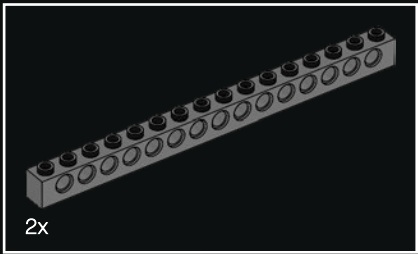
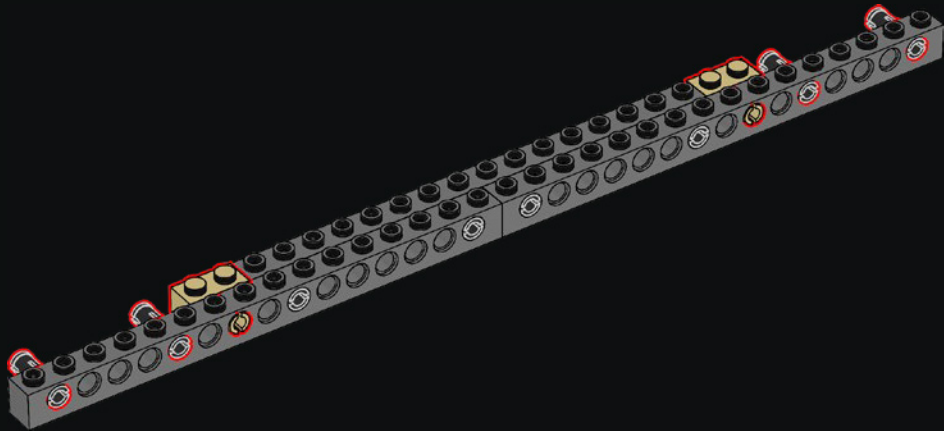

38

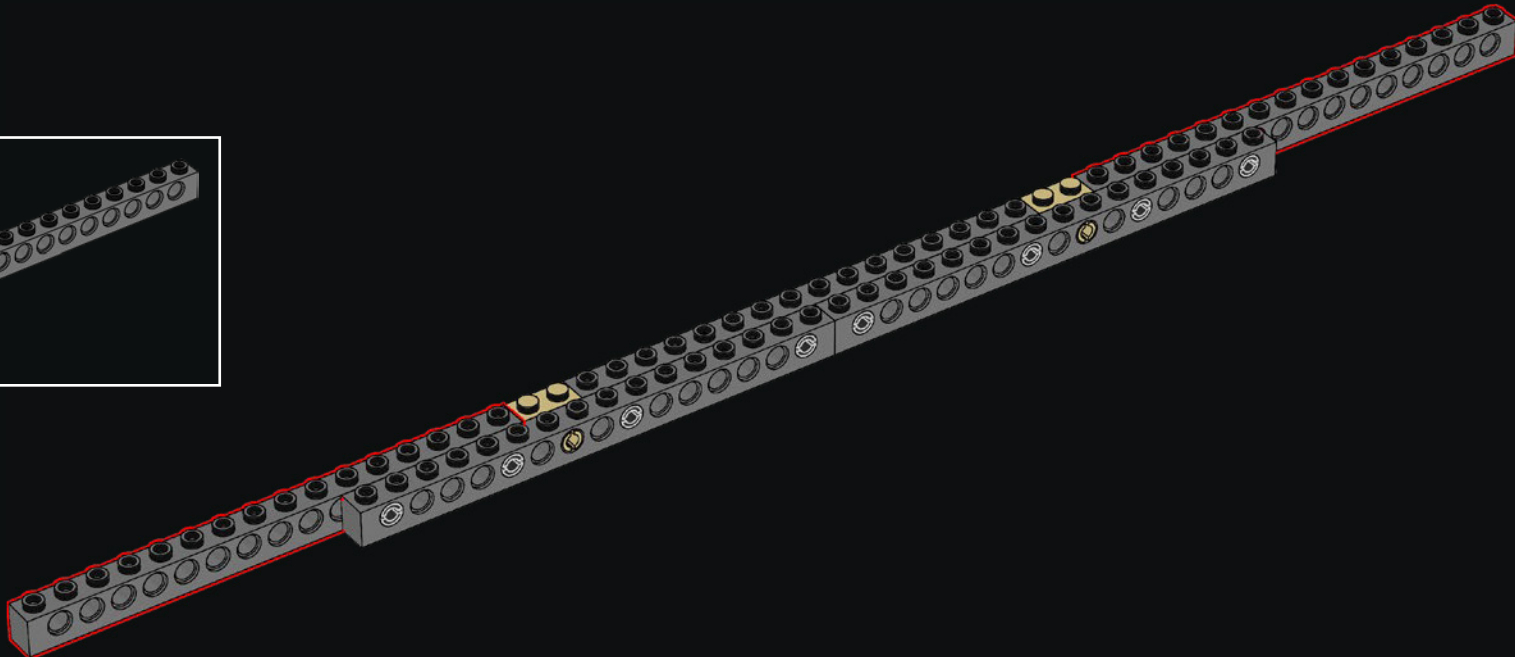



39

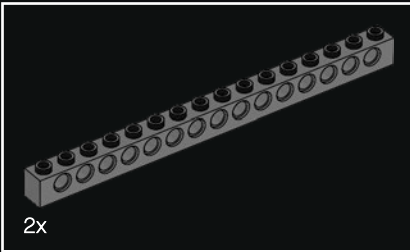
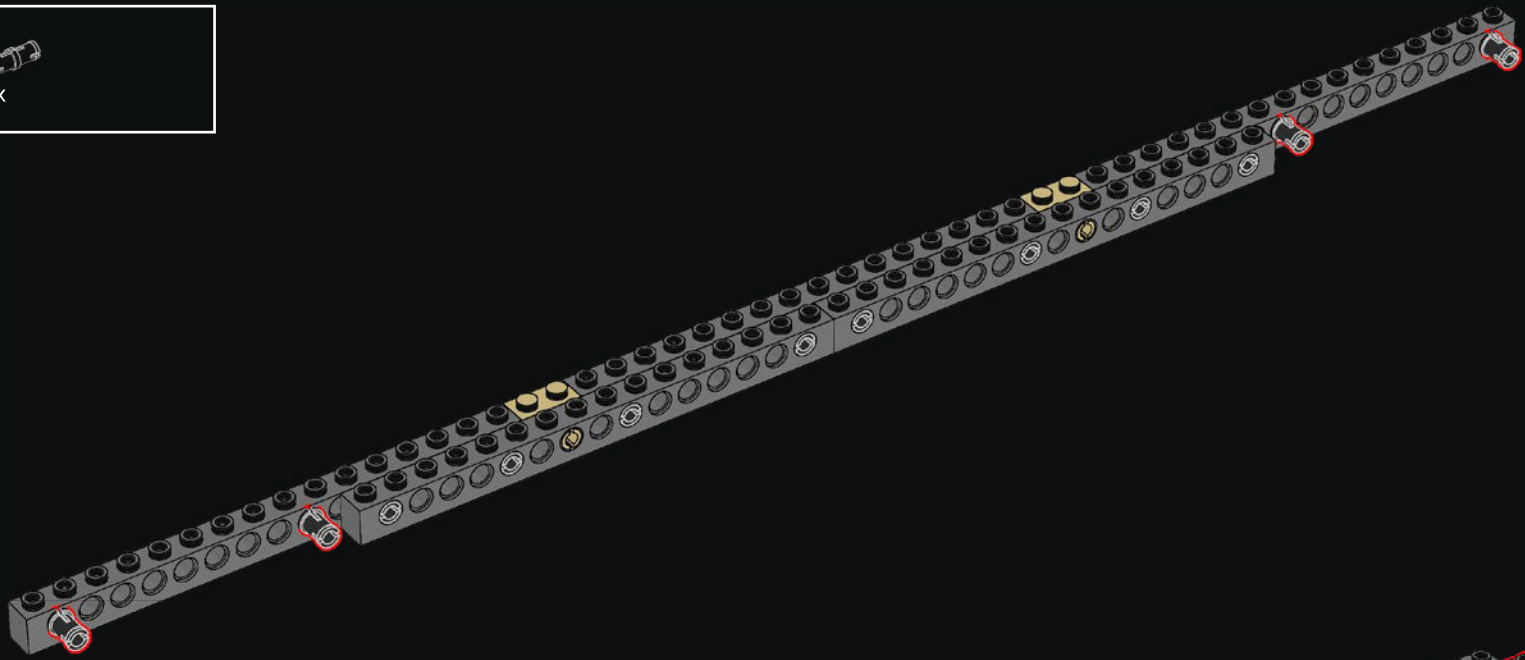

40





41

Le Colisée est également connu sous le nom d'amphithéâtre flavien, en référence aux 3 empereurs de la dynastie flavienne qui l'ont construit puis modifié.

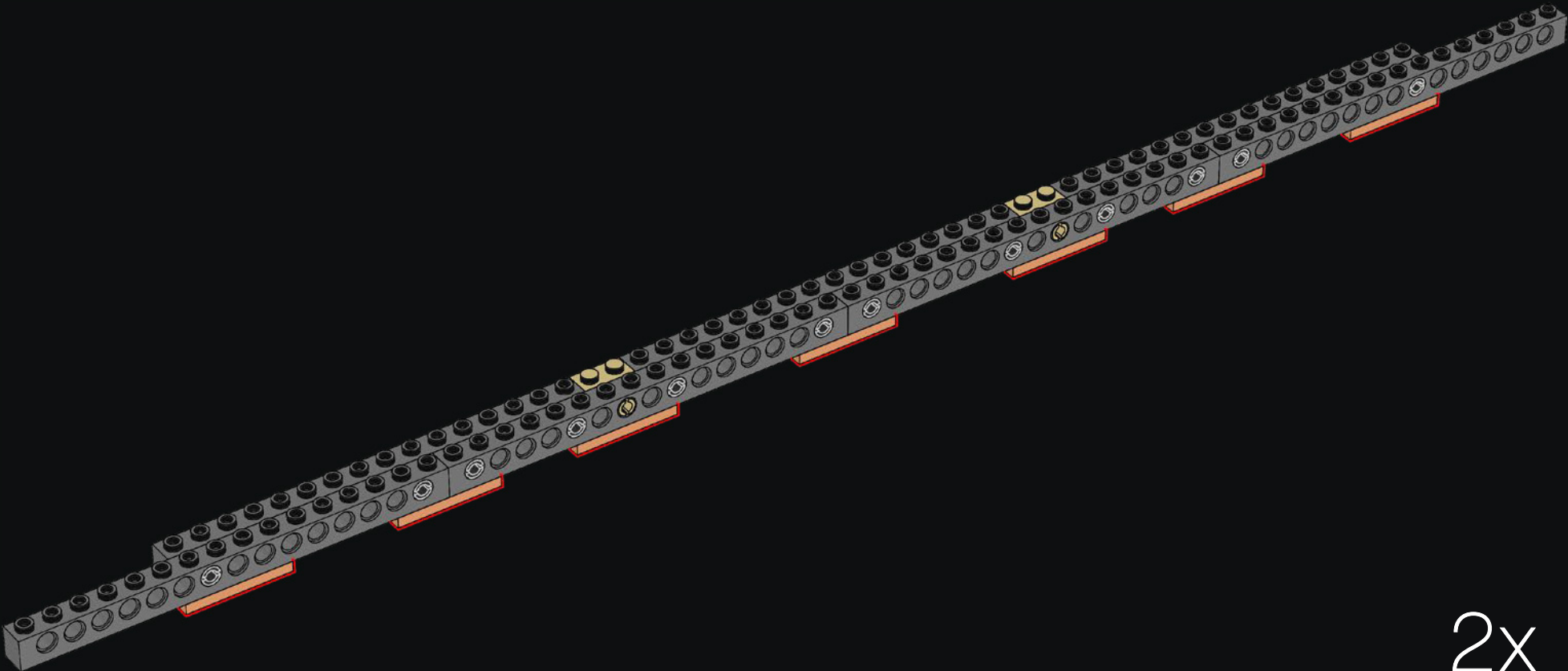

2x

42

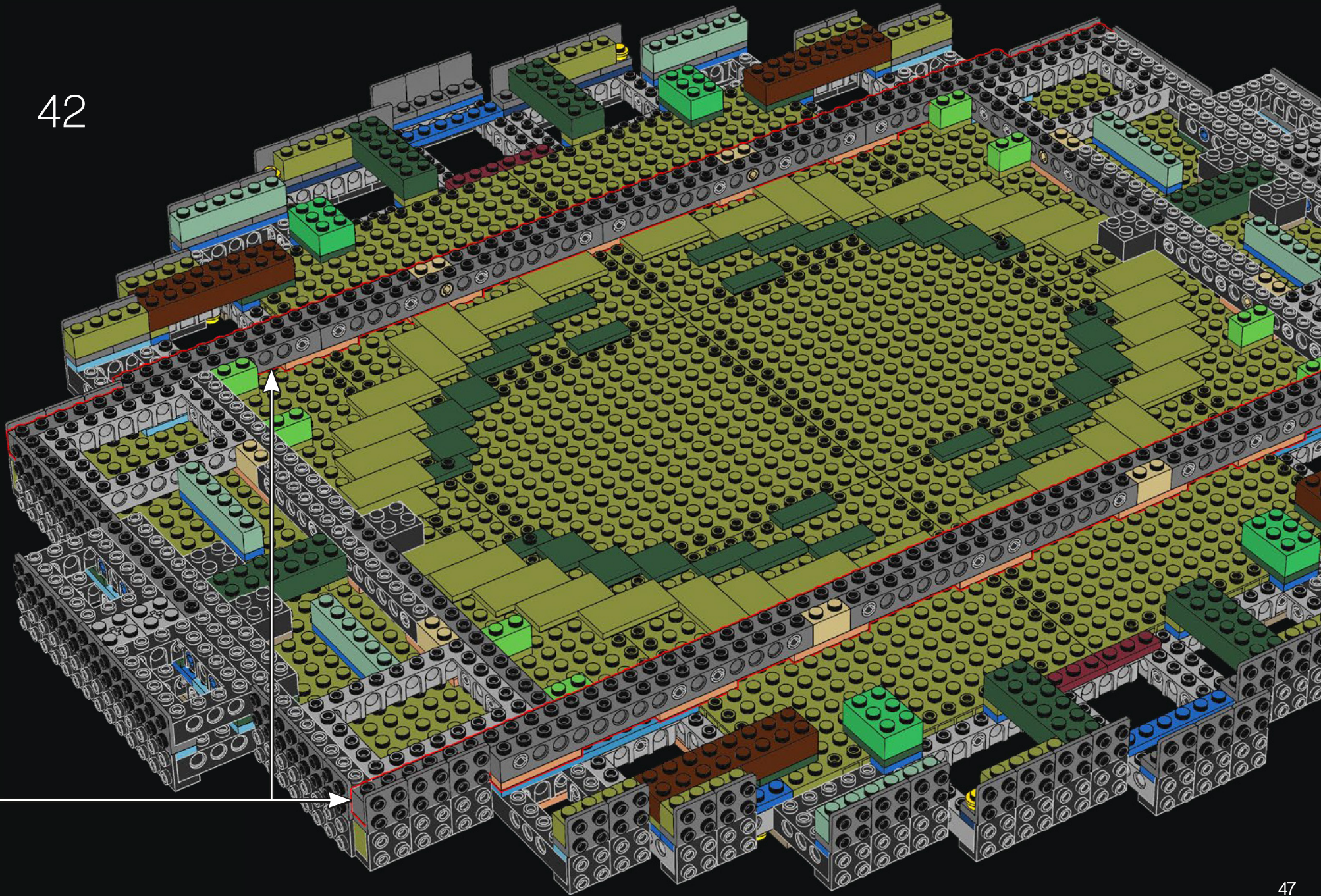



43

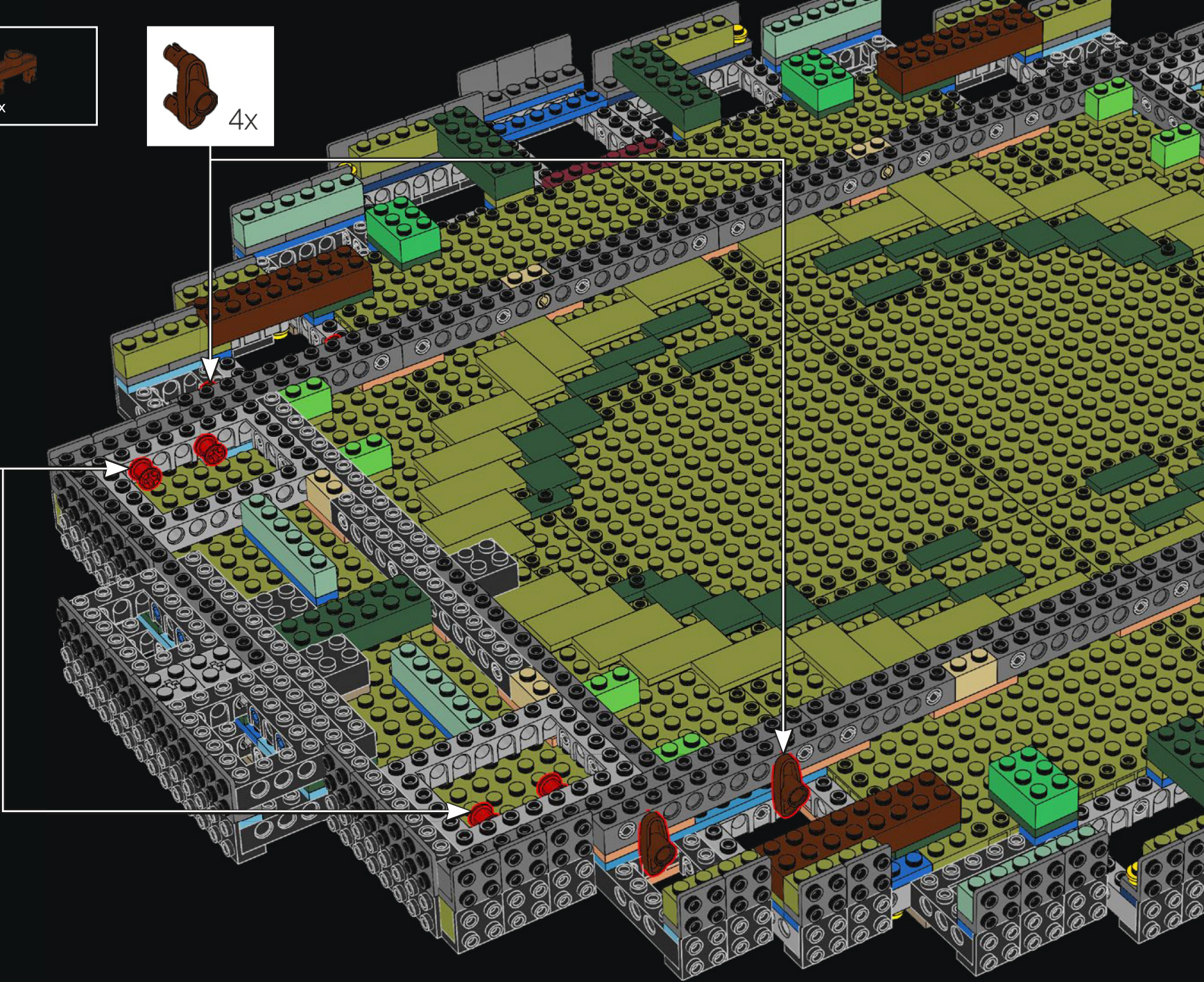



44

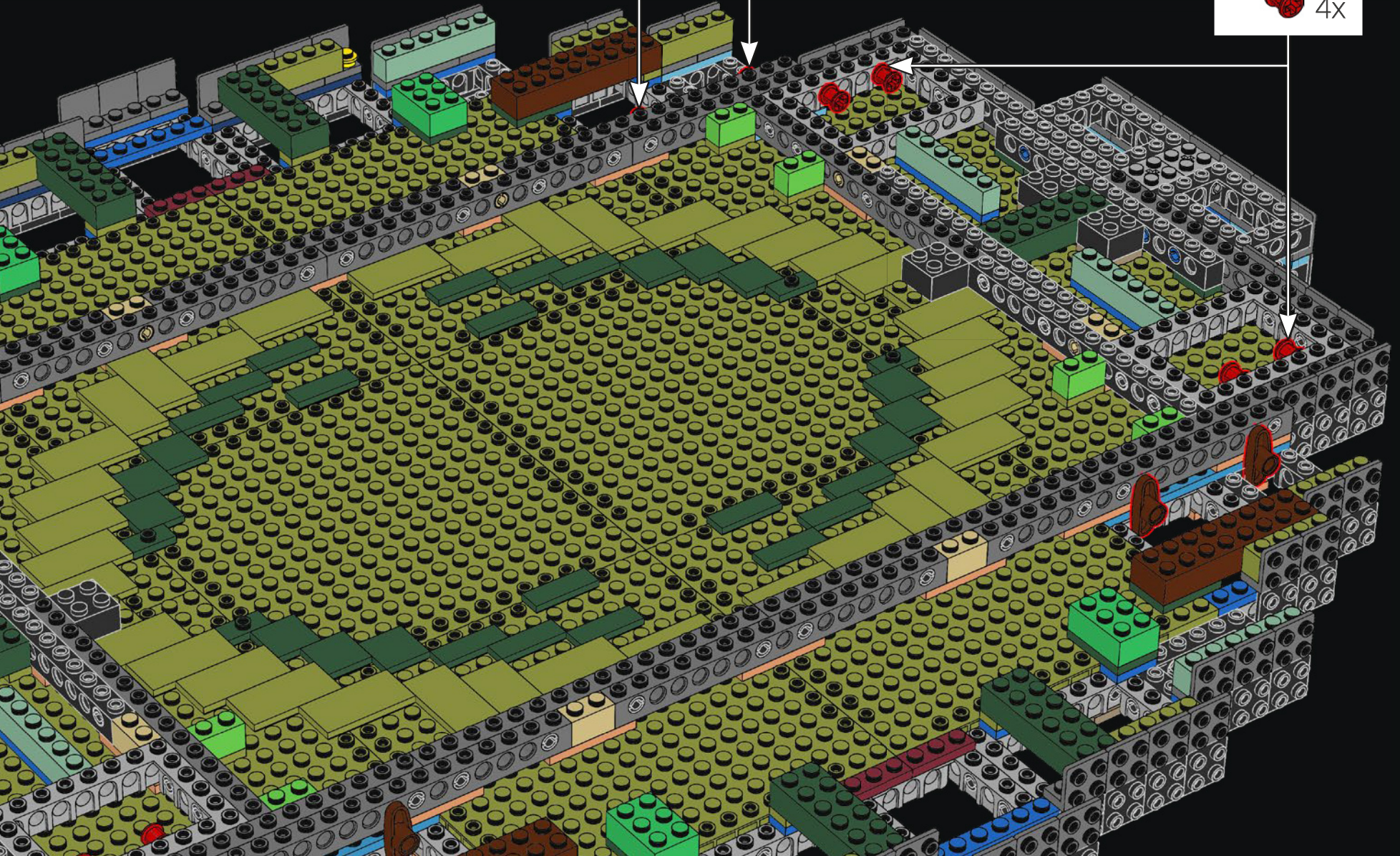

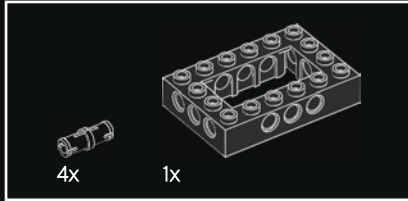
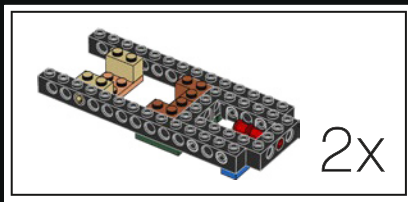

46

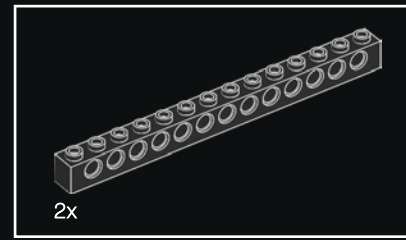
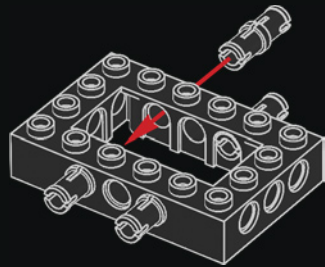

47

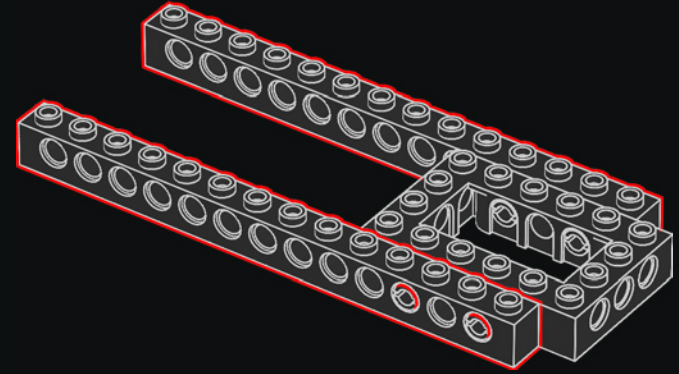

48

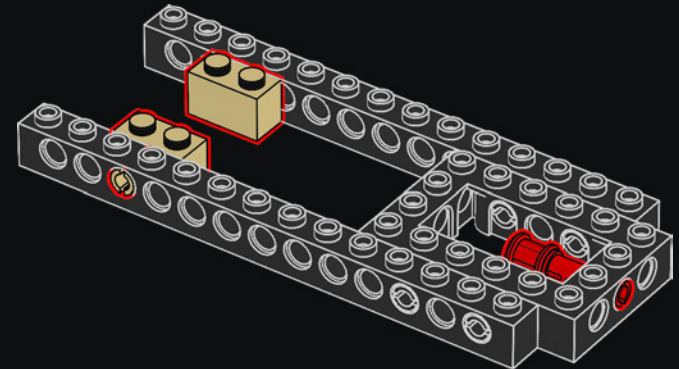

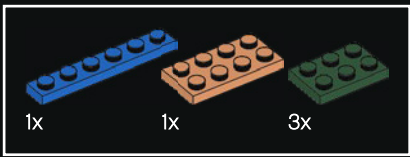

49

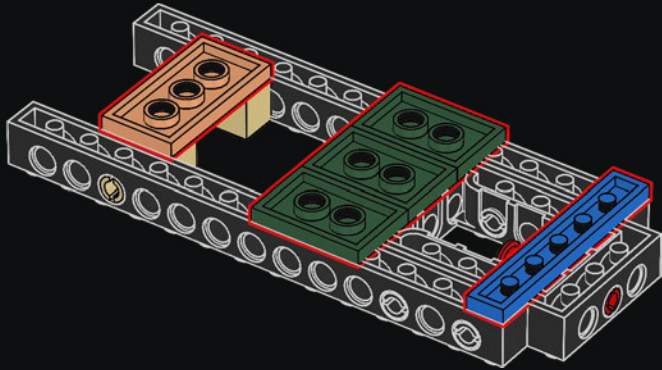

50

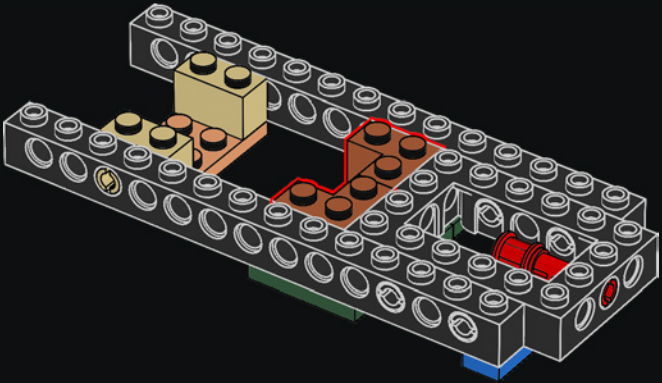

2x

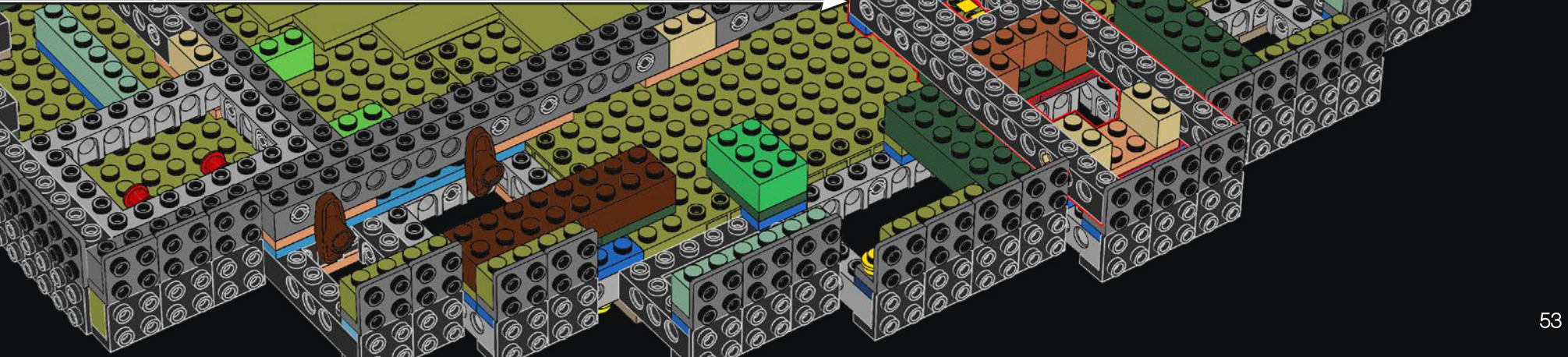
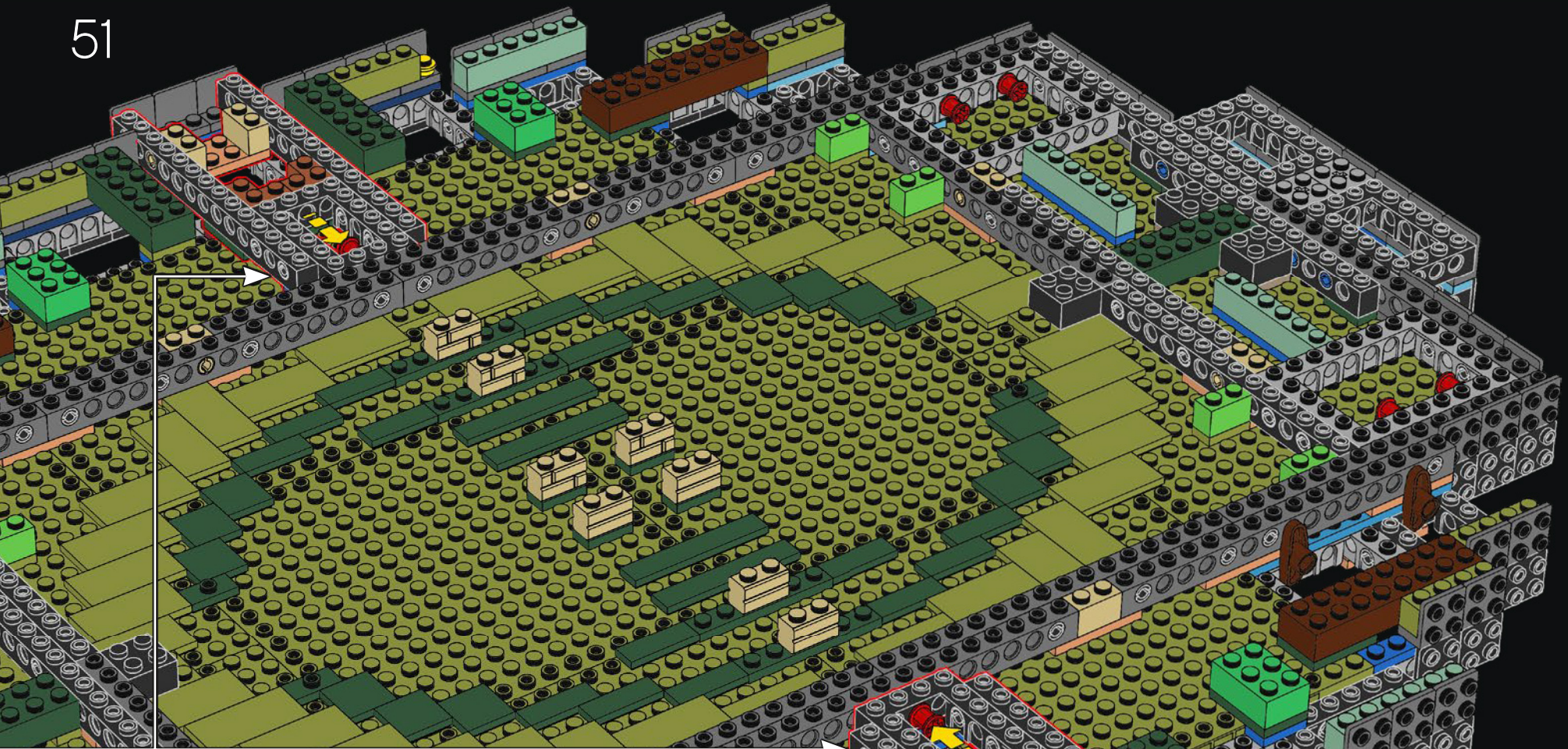



52

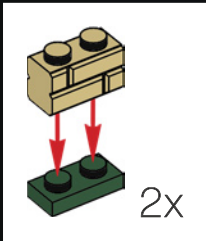

54

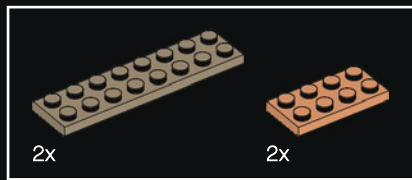

53

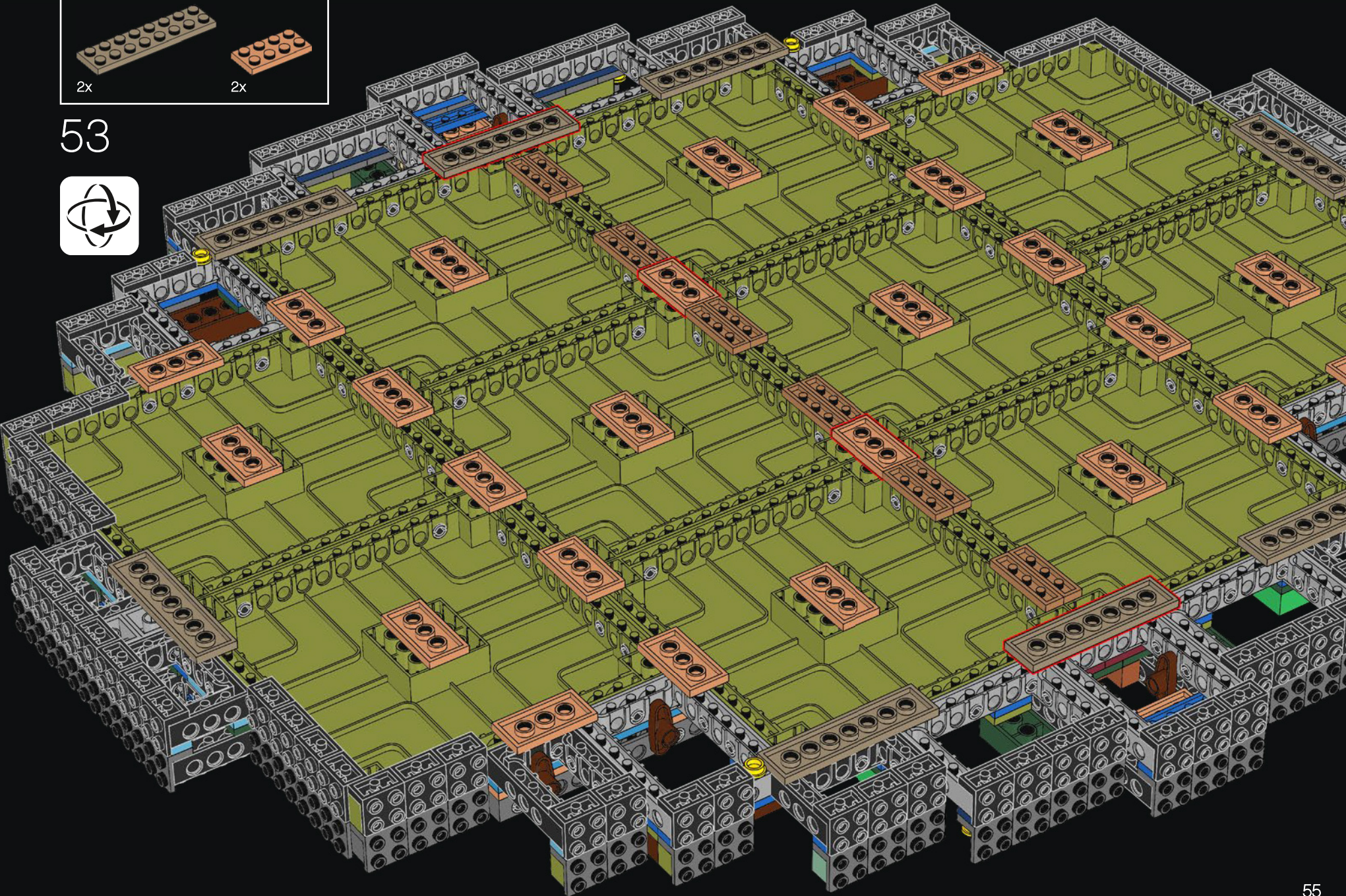

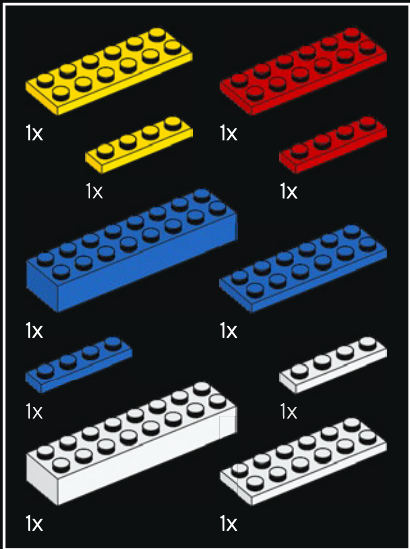

54



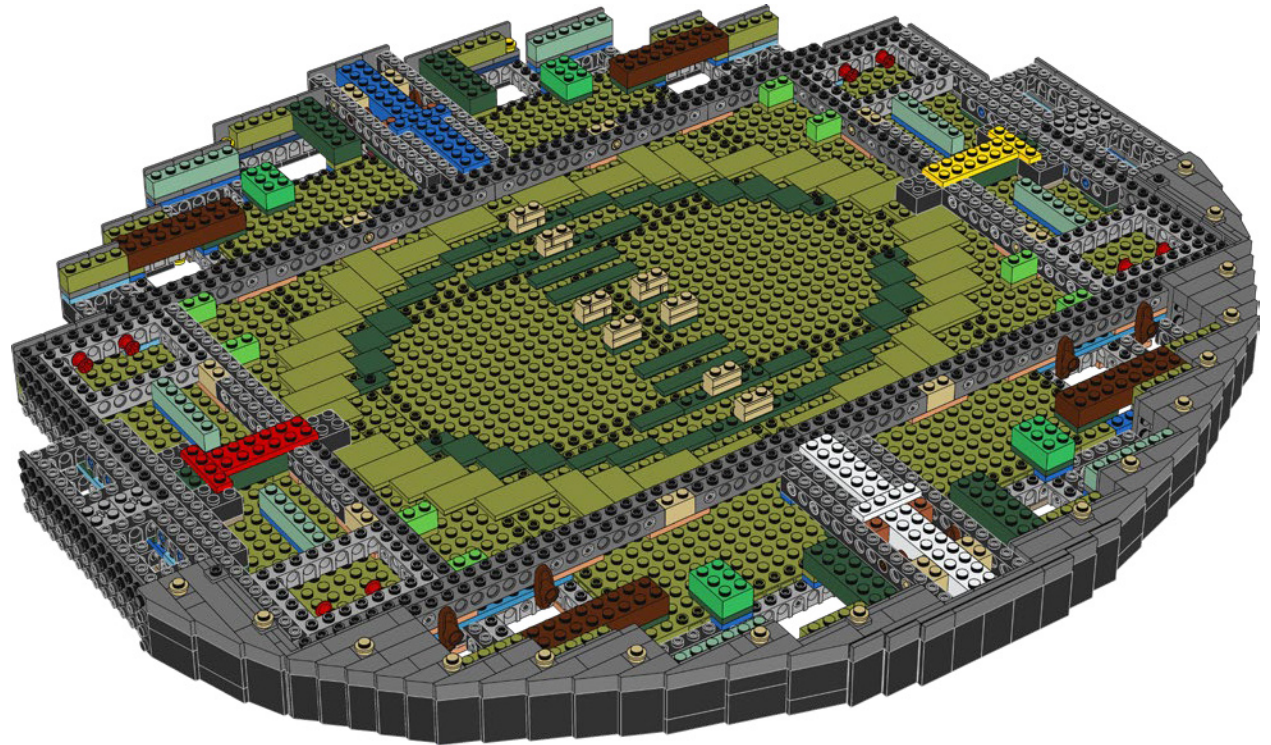
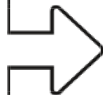

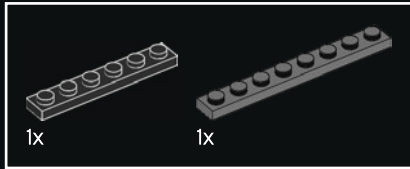
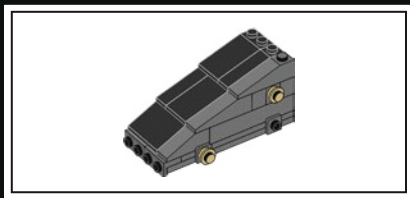

55

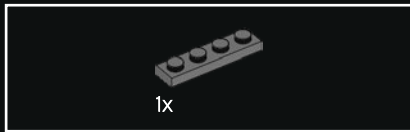
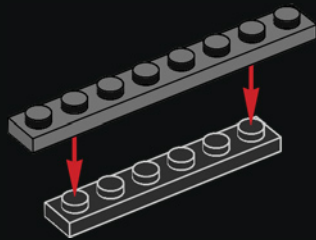

56

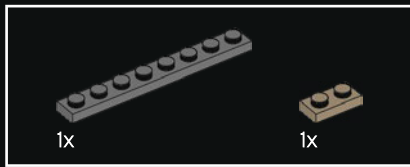
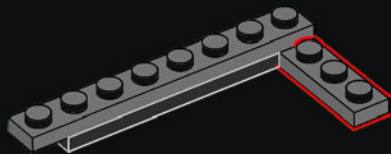

57

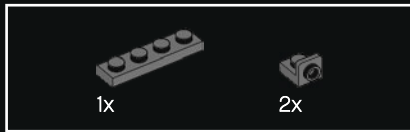
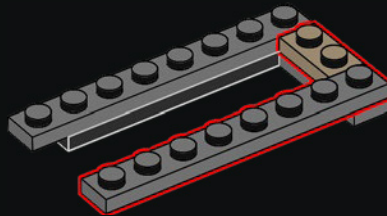

58

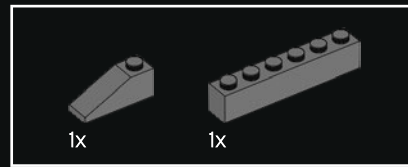
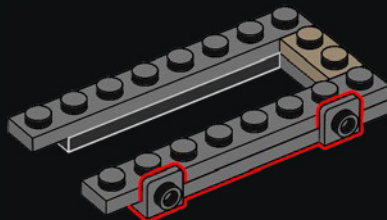

59

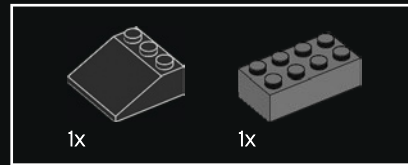
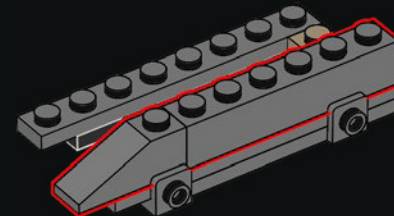

60

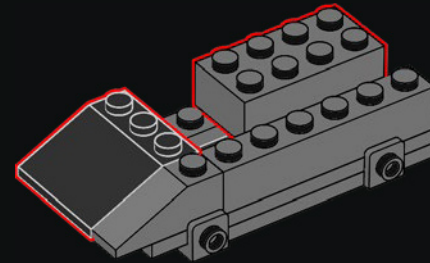

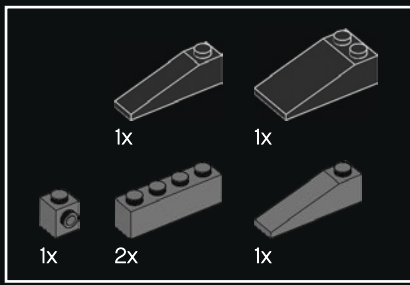

61

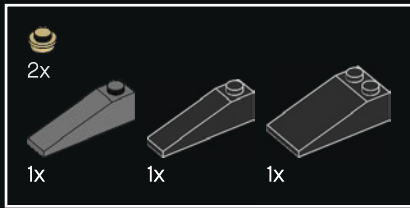
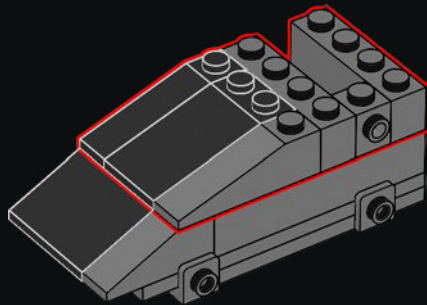

62

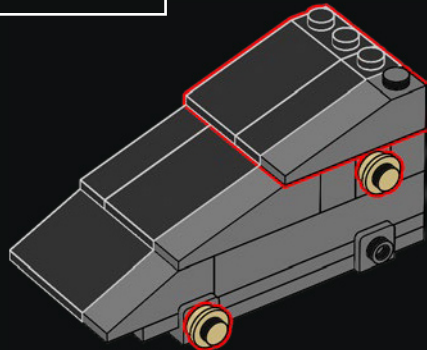

63

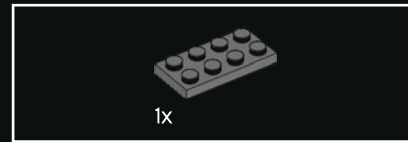
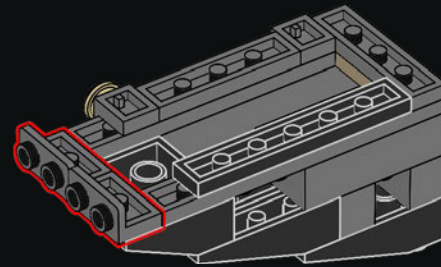

64

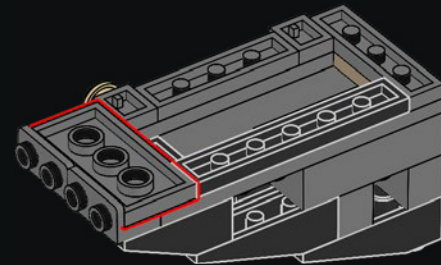

65

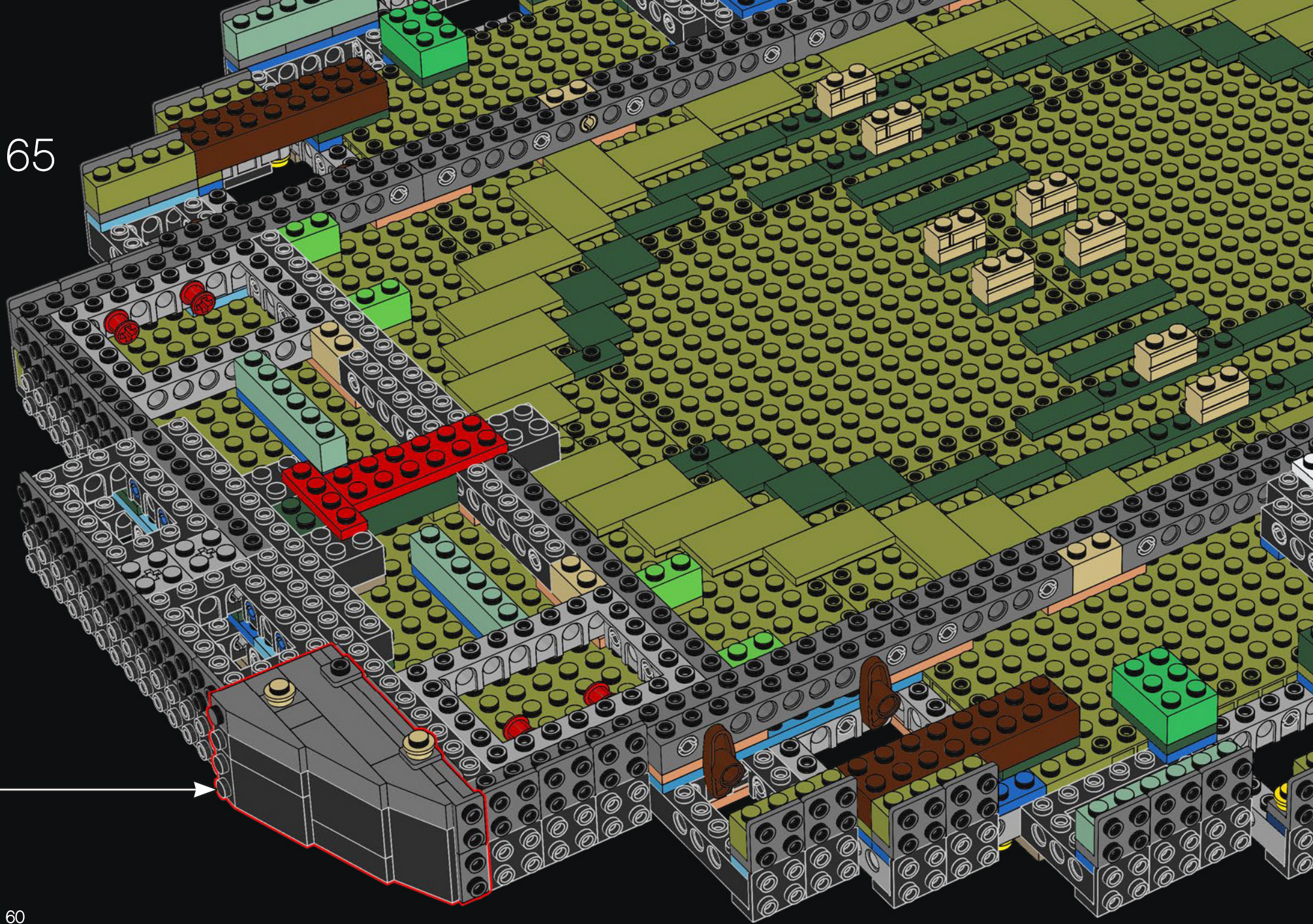

60

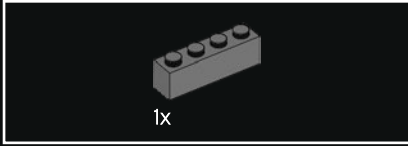
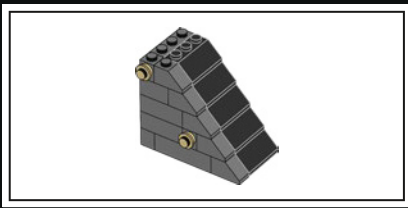

1x

66

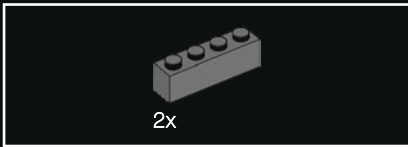

2x

67

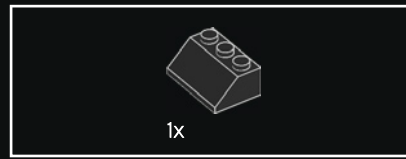
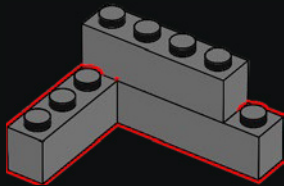

1x

68

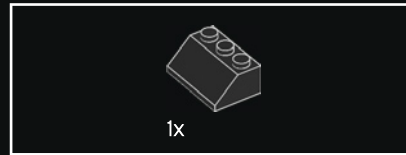
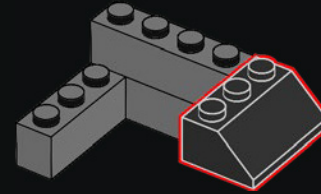

1x

69

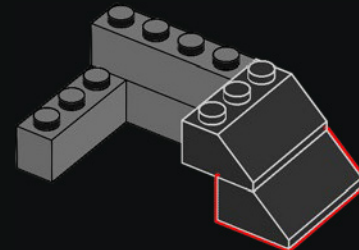

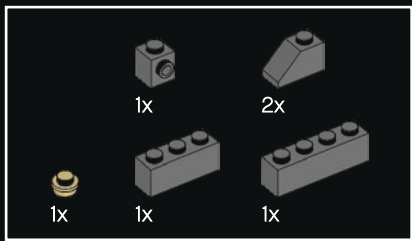

70

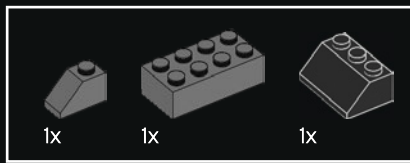
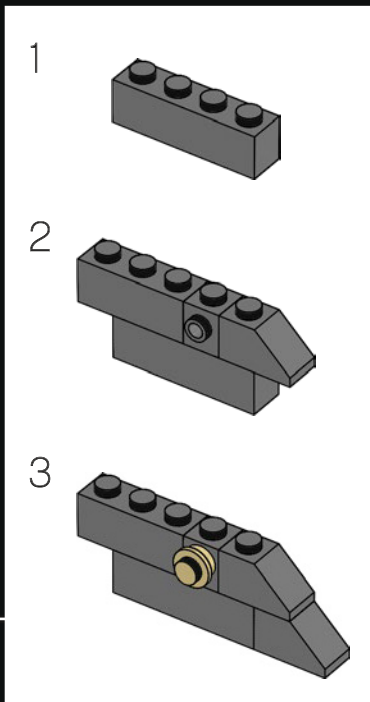
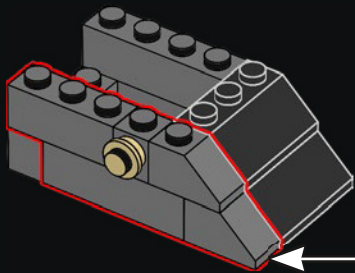

72

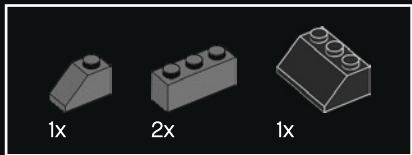
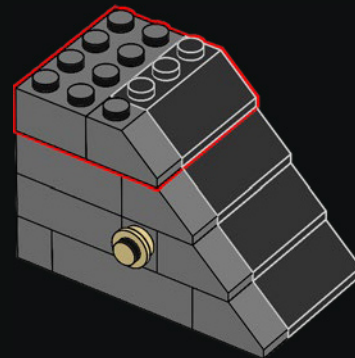

71

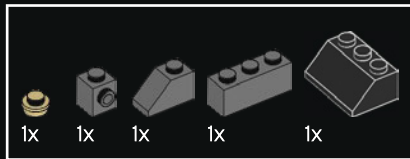
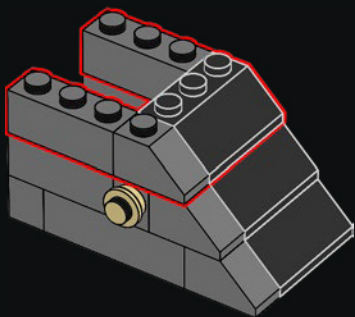

73

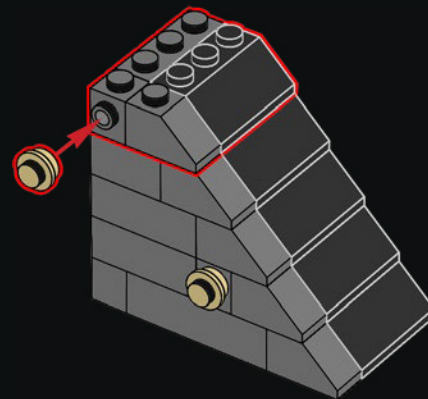

74

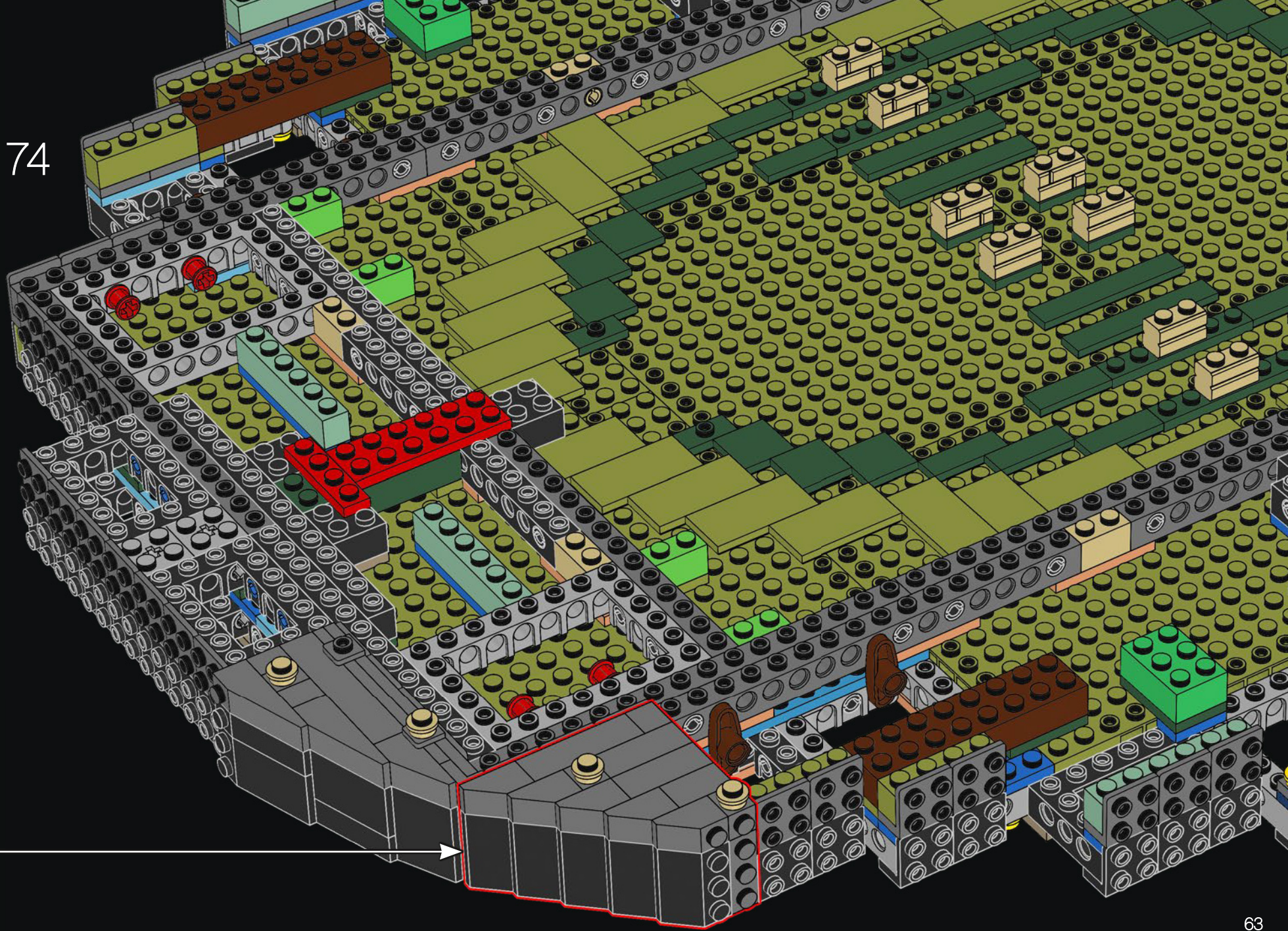

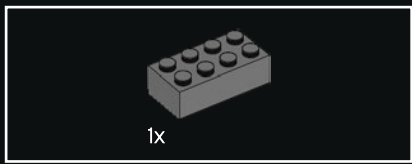

75

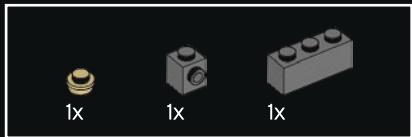
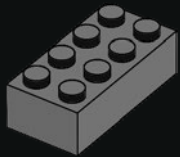

76

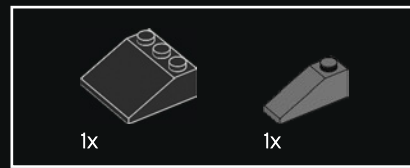
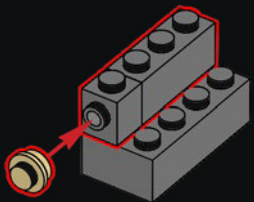

77

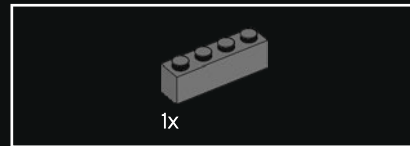
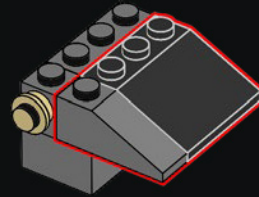

78

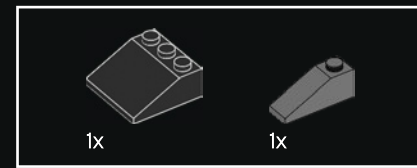
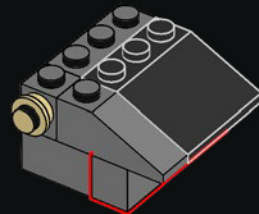

79

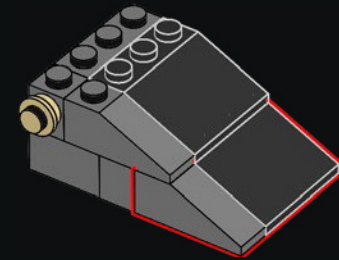

80

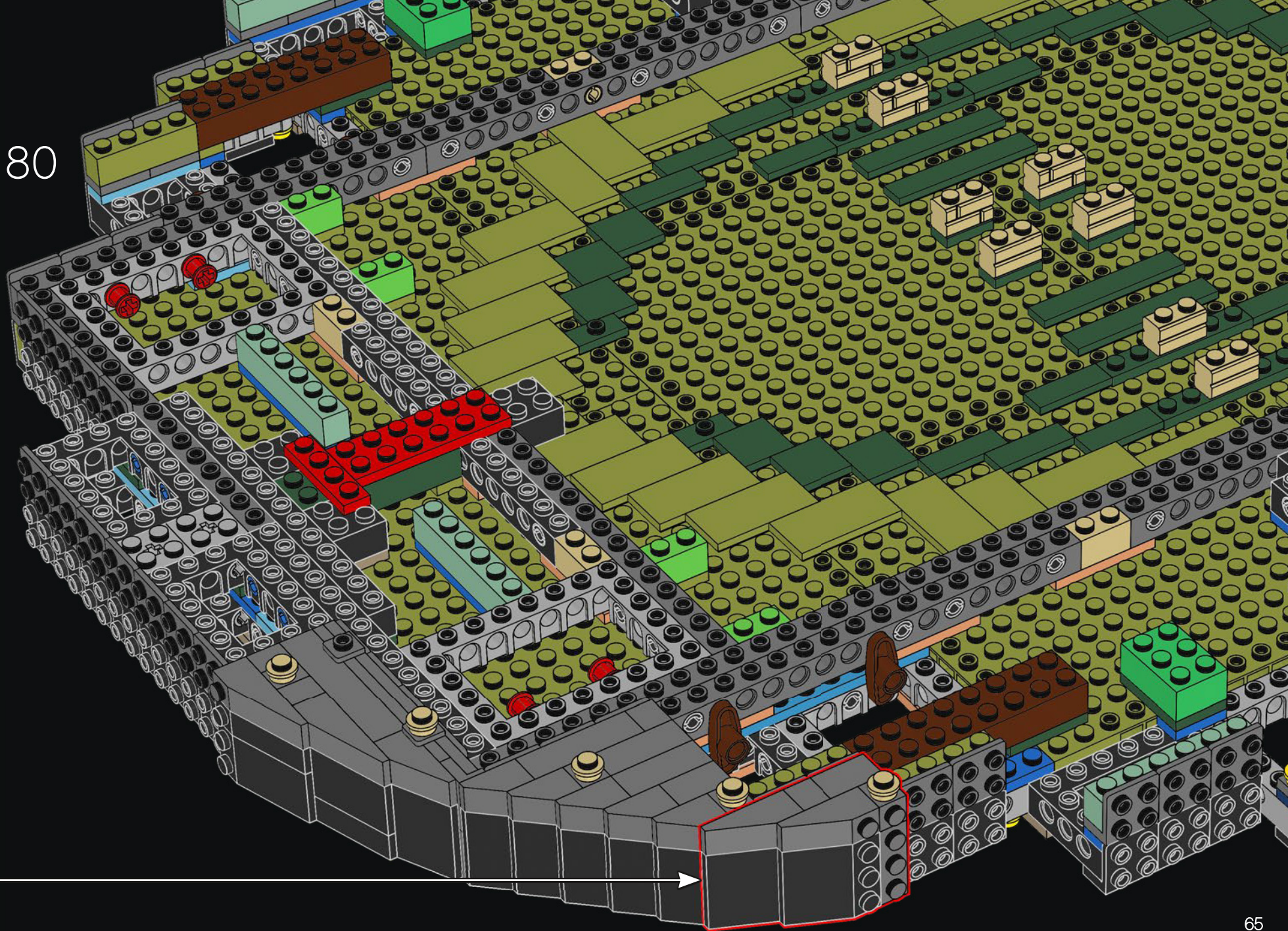

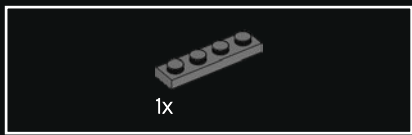

81

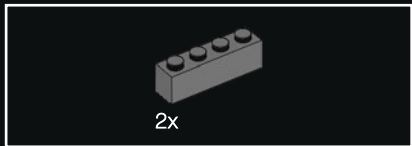

82

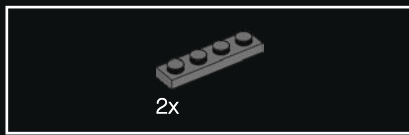
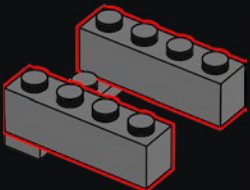

83

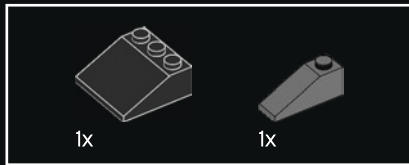
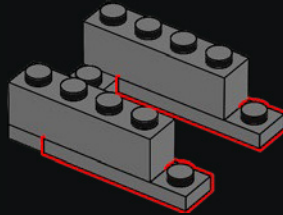

84

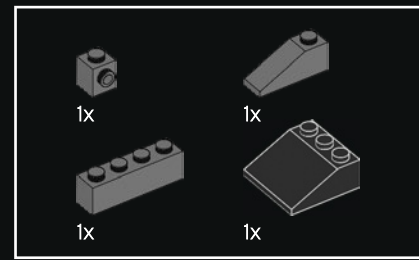
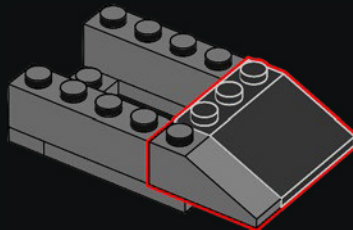

85

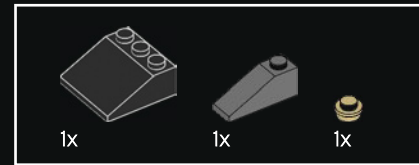
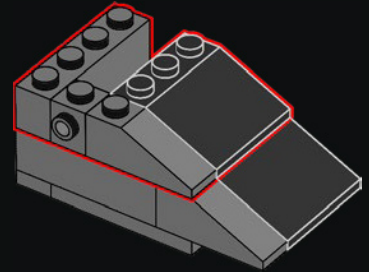

86

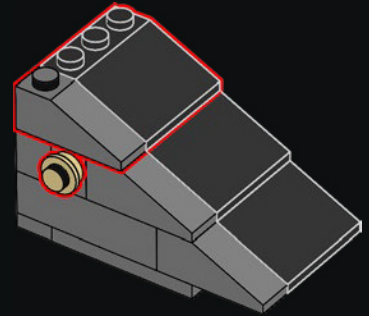

87

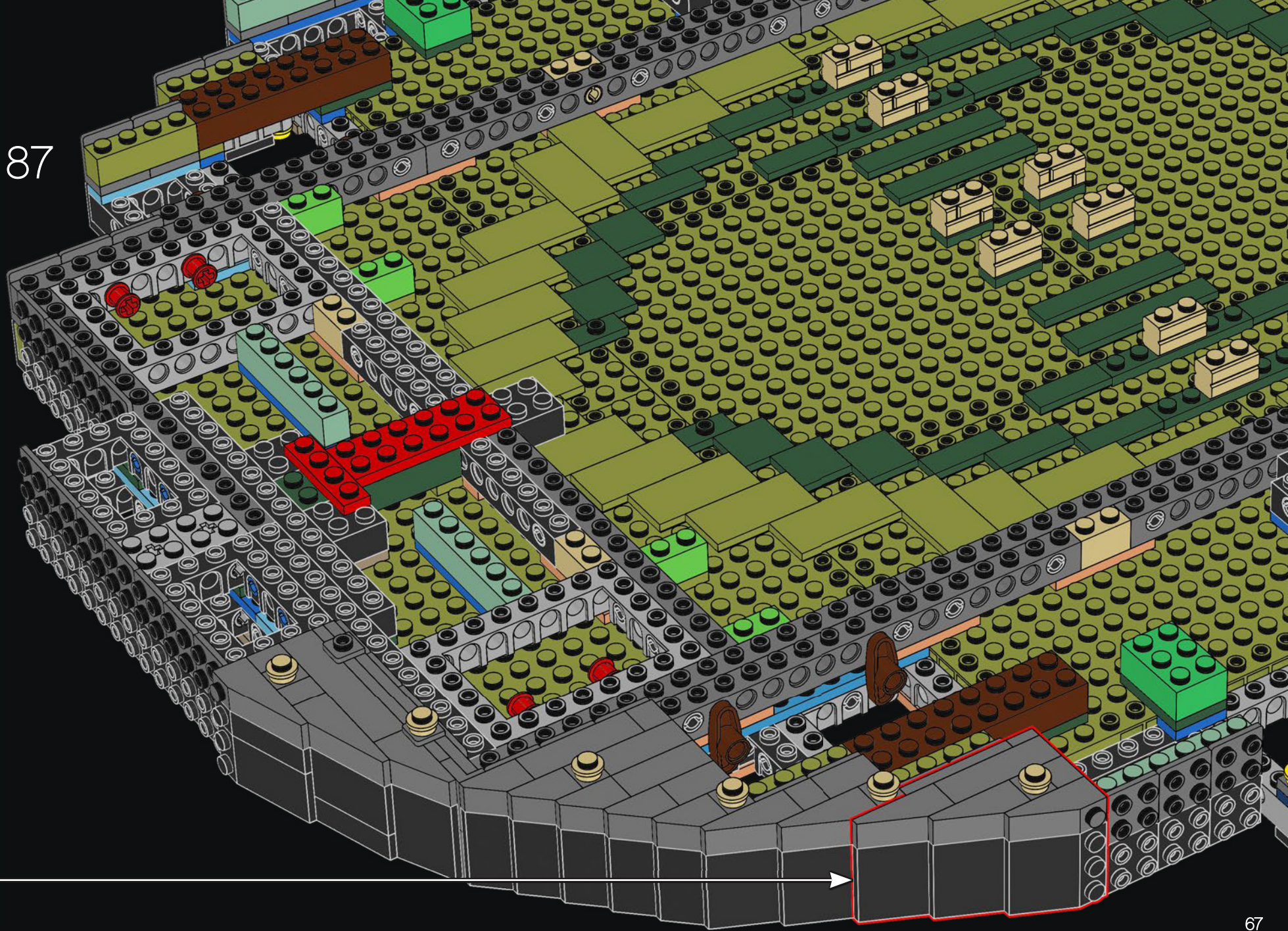

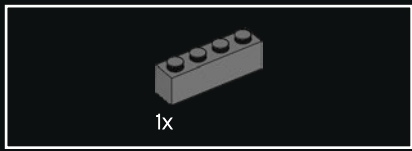

88

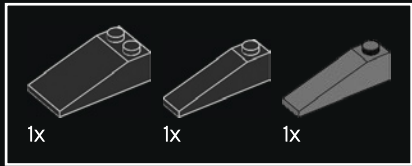
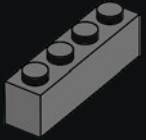

89

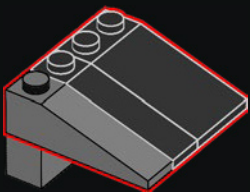

90

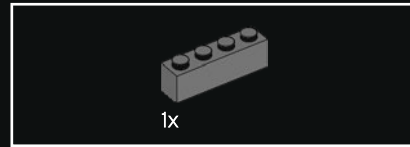
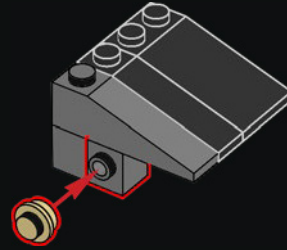

91

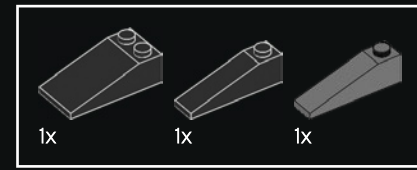
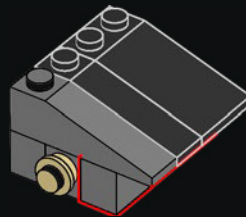

92

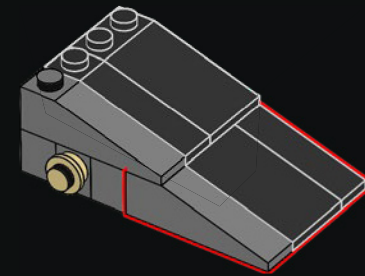



93

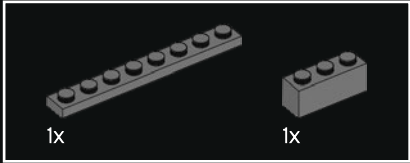
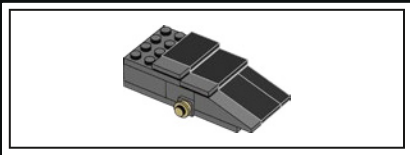

94

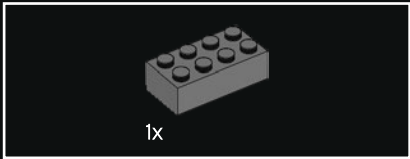
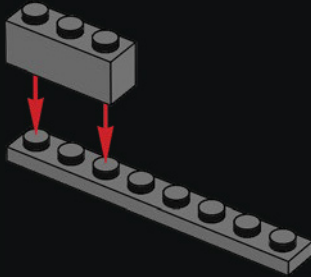

95

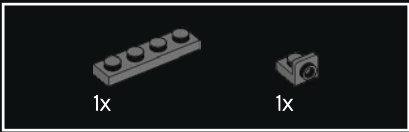
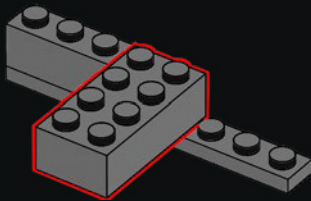

96

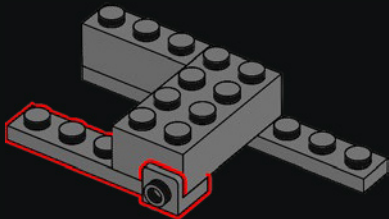

97

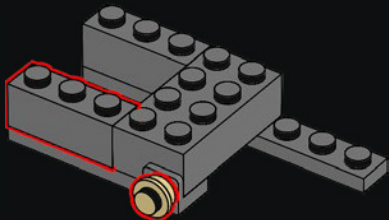

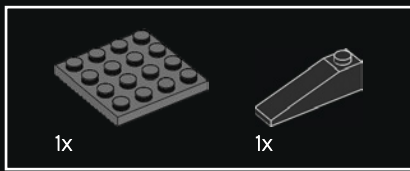

98

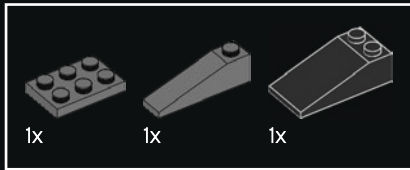
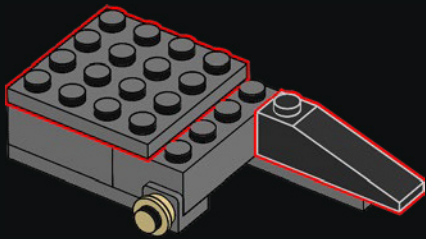

99

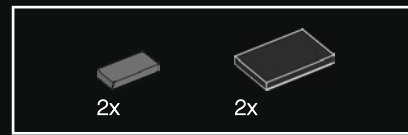
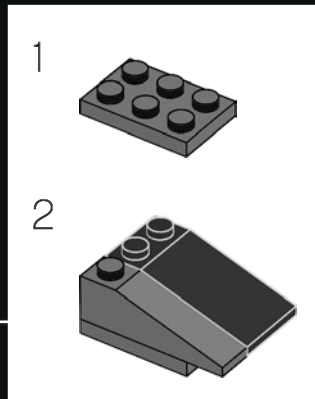
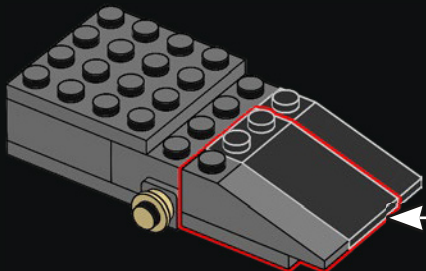

100

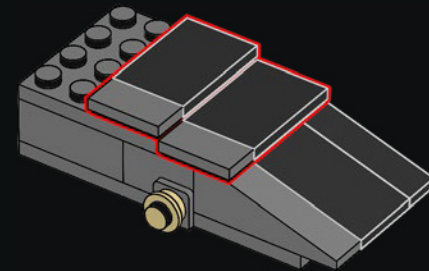

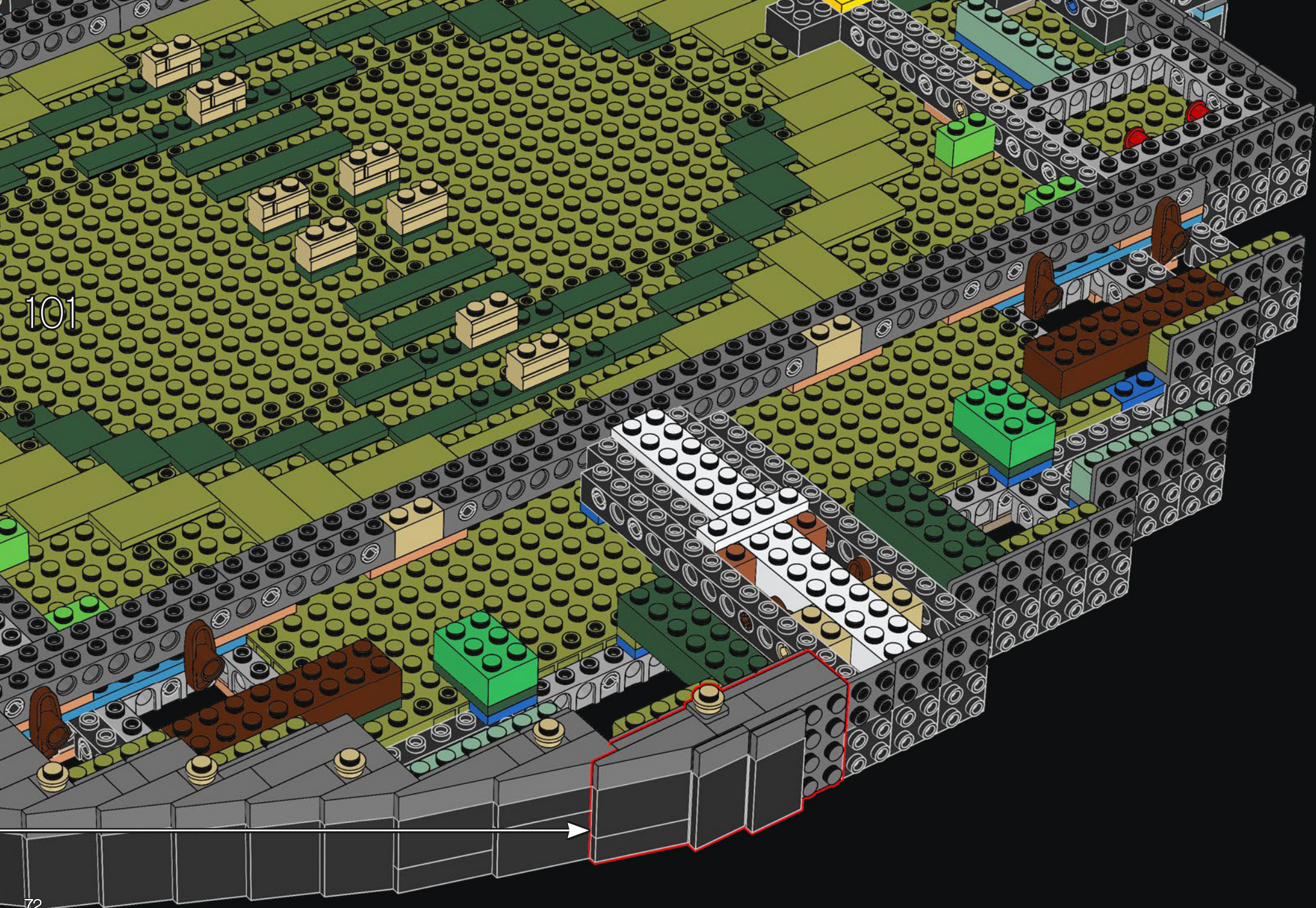

101

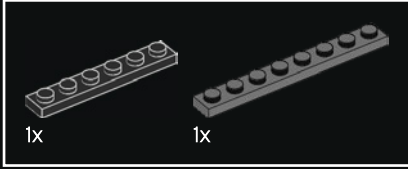
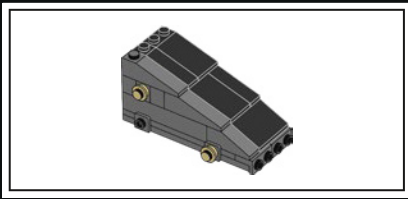

102

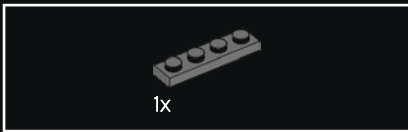
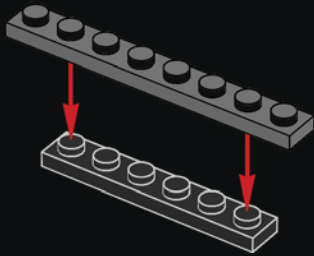

103

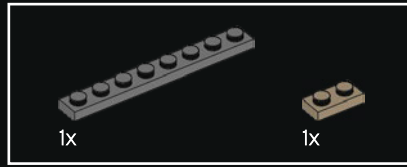
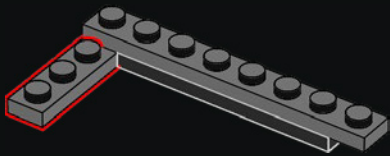

104

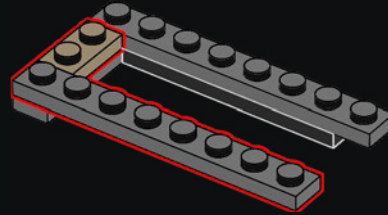

105

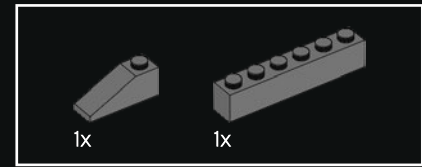
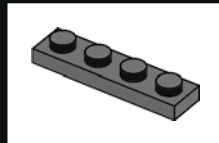
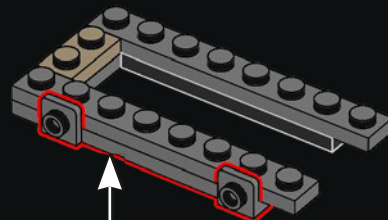

106

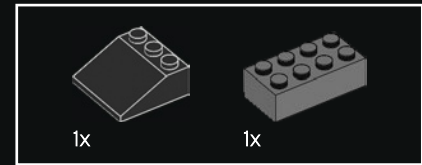
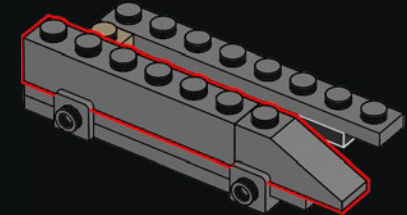

107

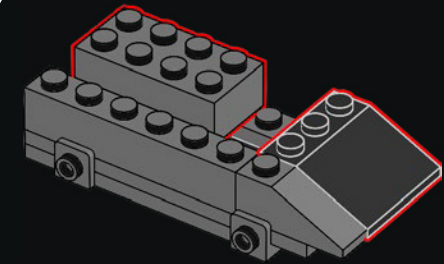

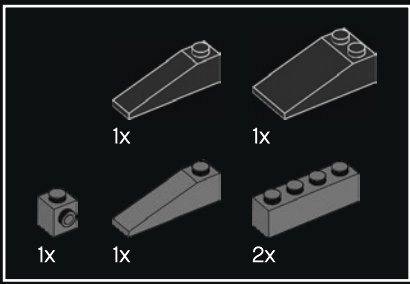

108

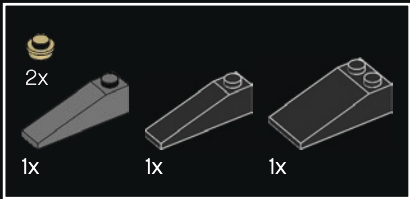
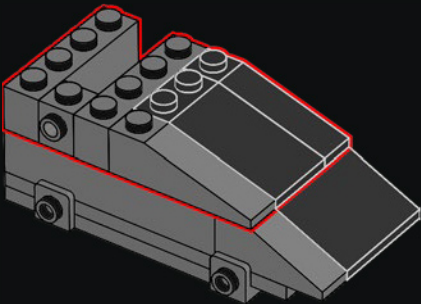

109

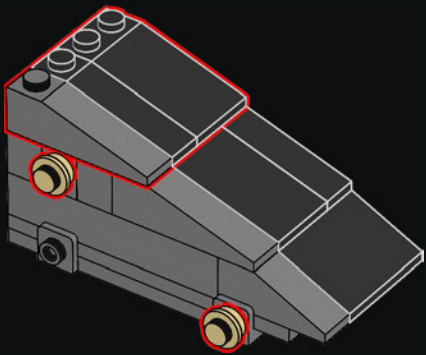

110

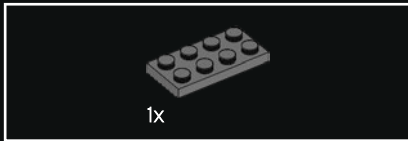
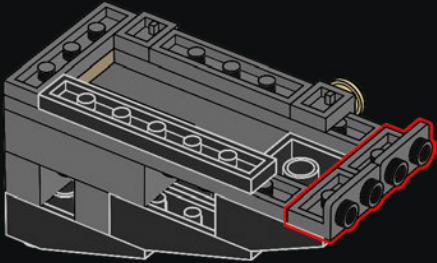

111

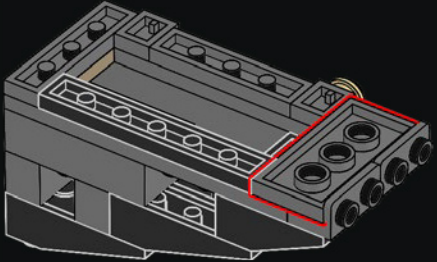

112



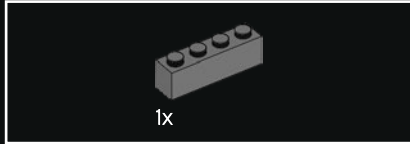
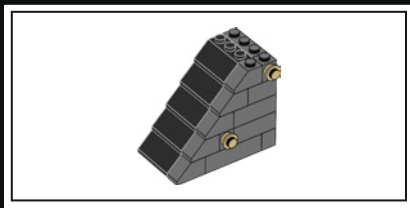

1x

113

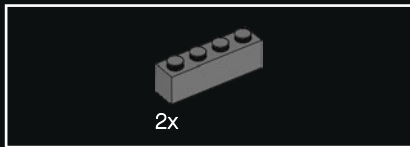
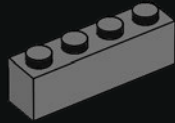

2x

114

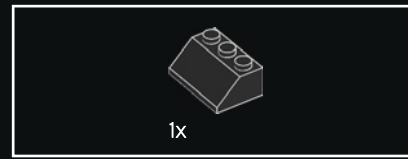
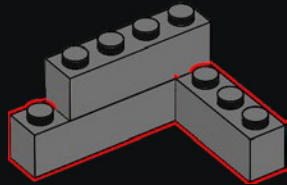

1x

115

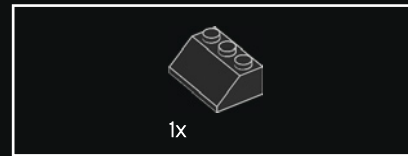
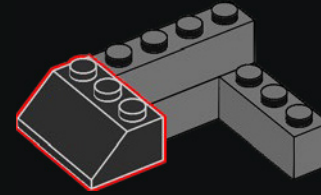

1x

116

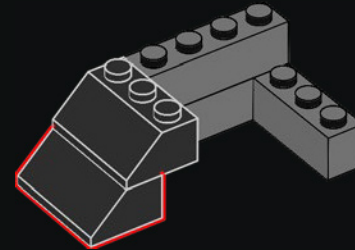

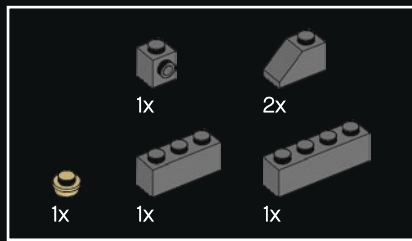

117

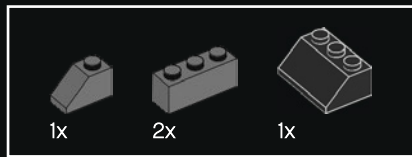
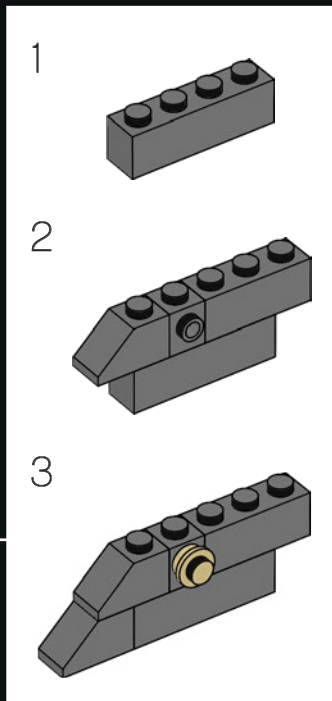
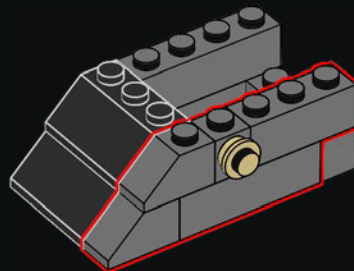

118

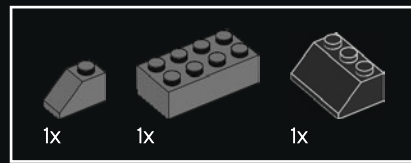
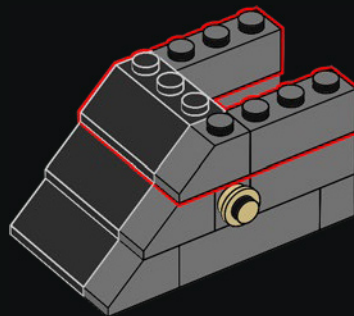

119

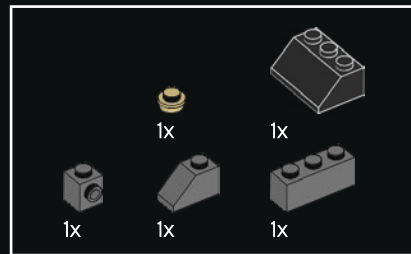
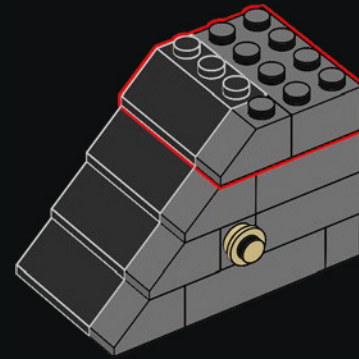

120

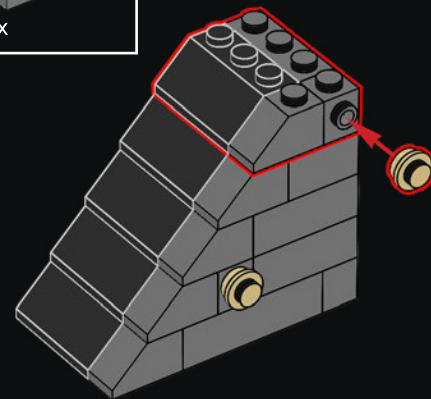



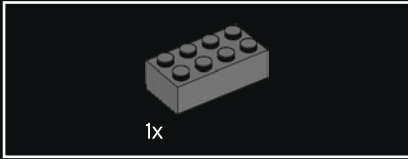
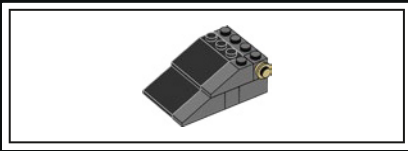

122

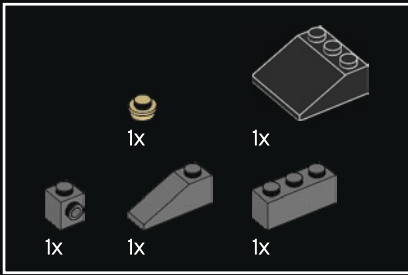
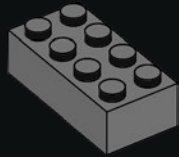

123

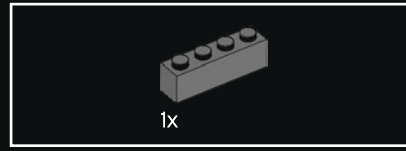
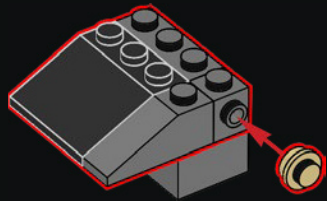

124

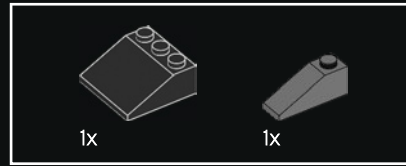
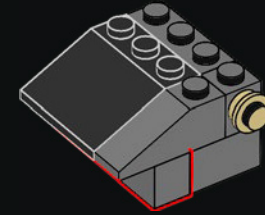

125

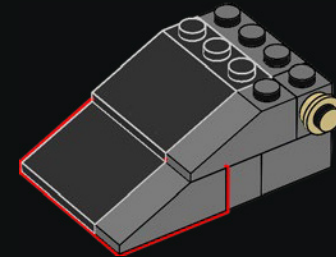



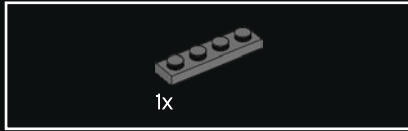
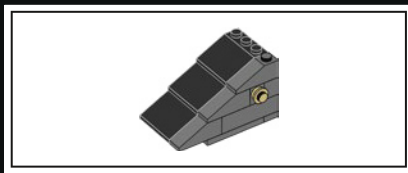

127

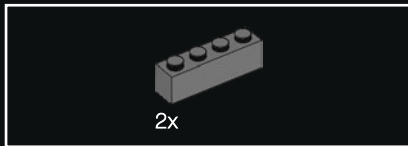

128

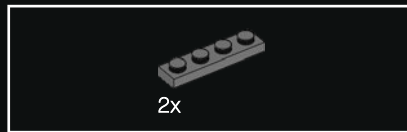
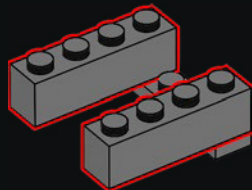

129

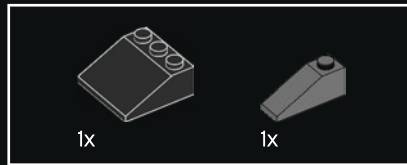
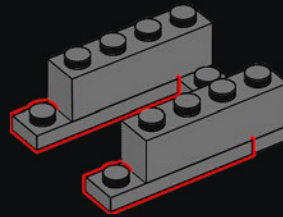

130

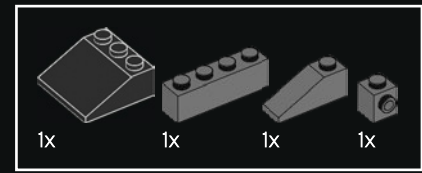
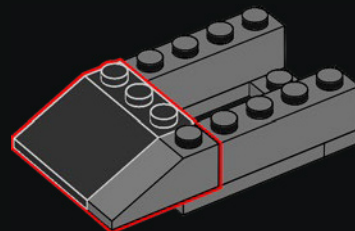

131

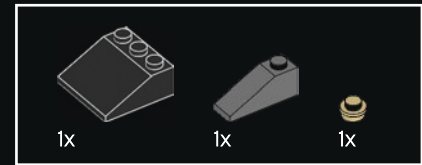
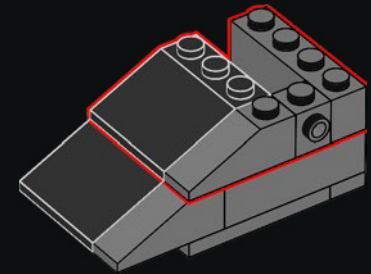

132

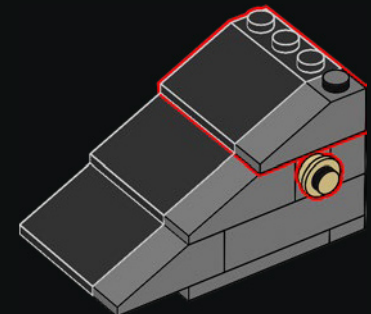



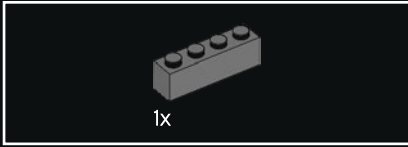
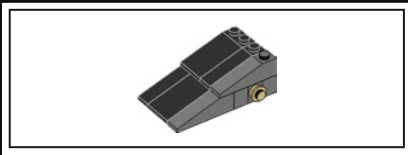

134

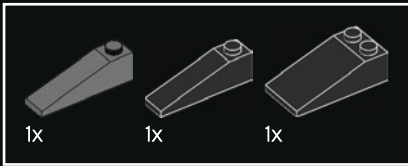
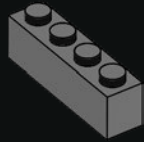

135

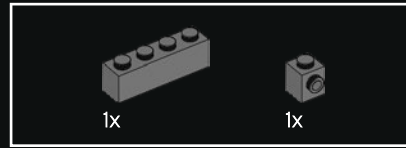
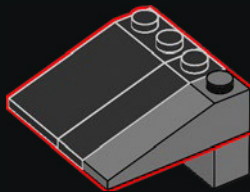

136

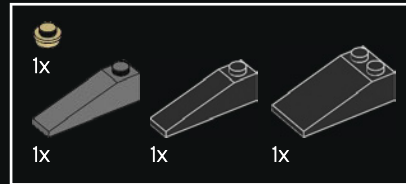
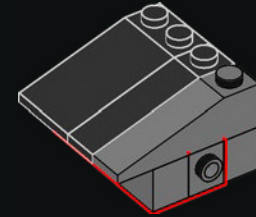

137

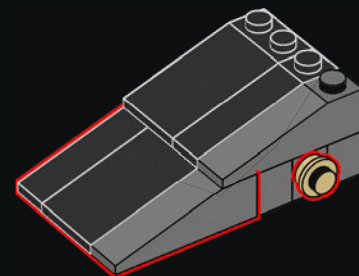



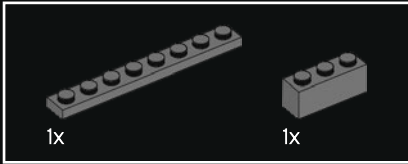
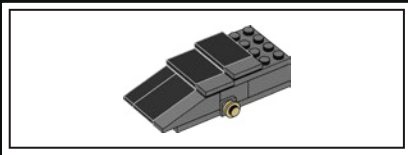

139

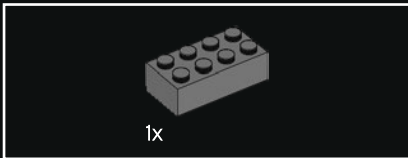
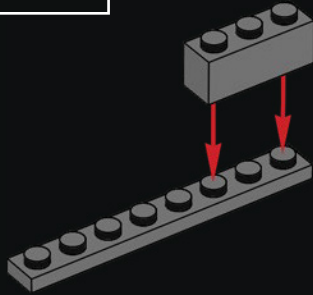

140

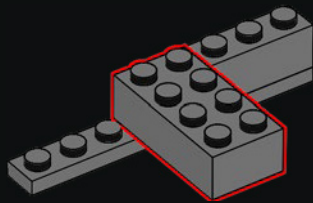

141

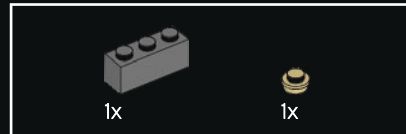
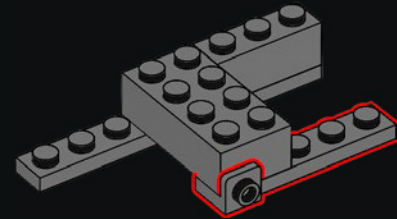

142

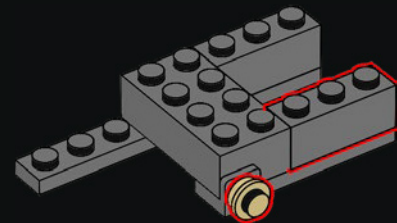

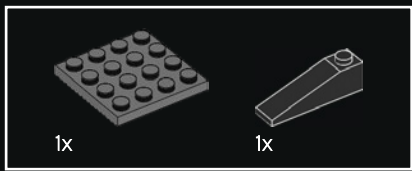

143

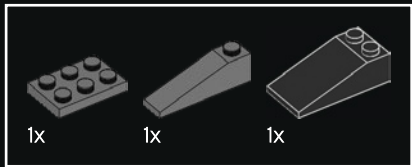
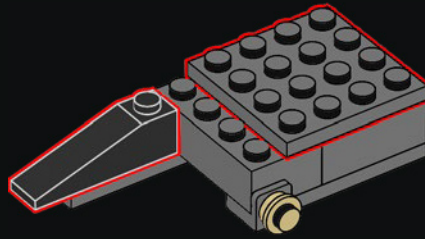

144

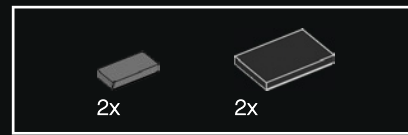
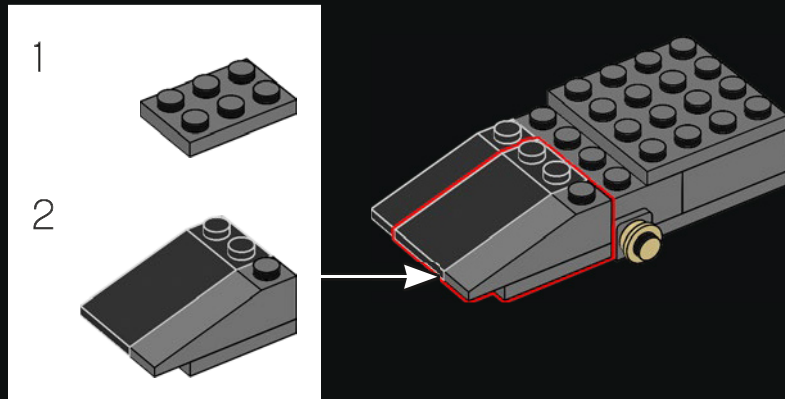

145

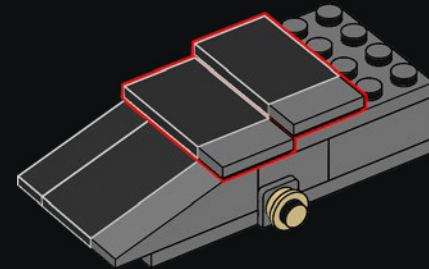

146



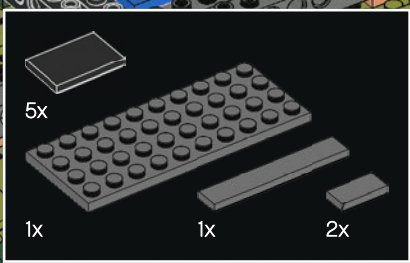

147

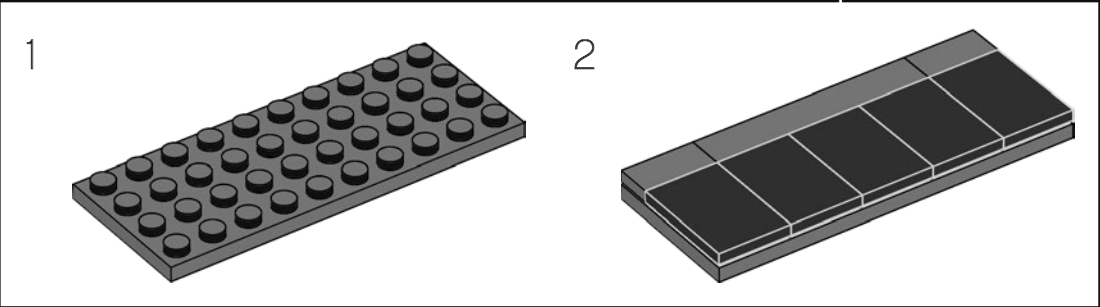

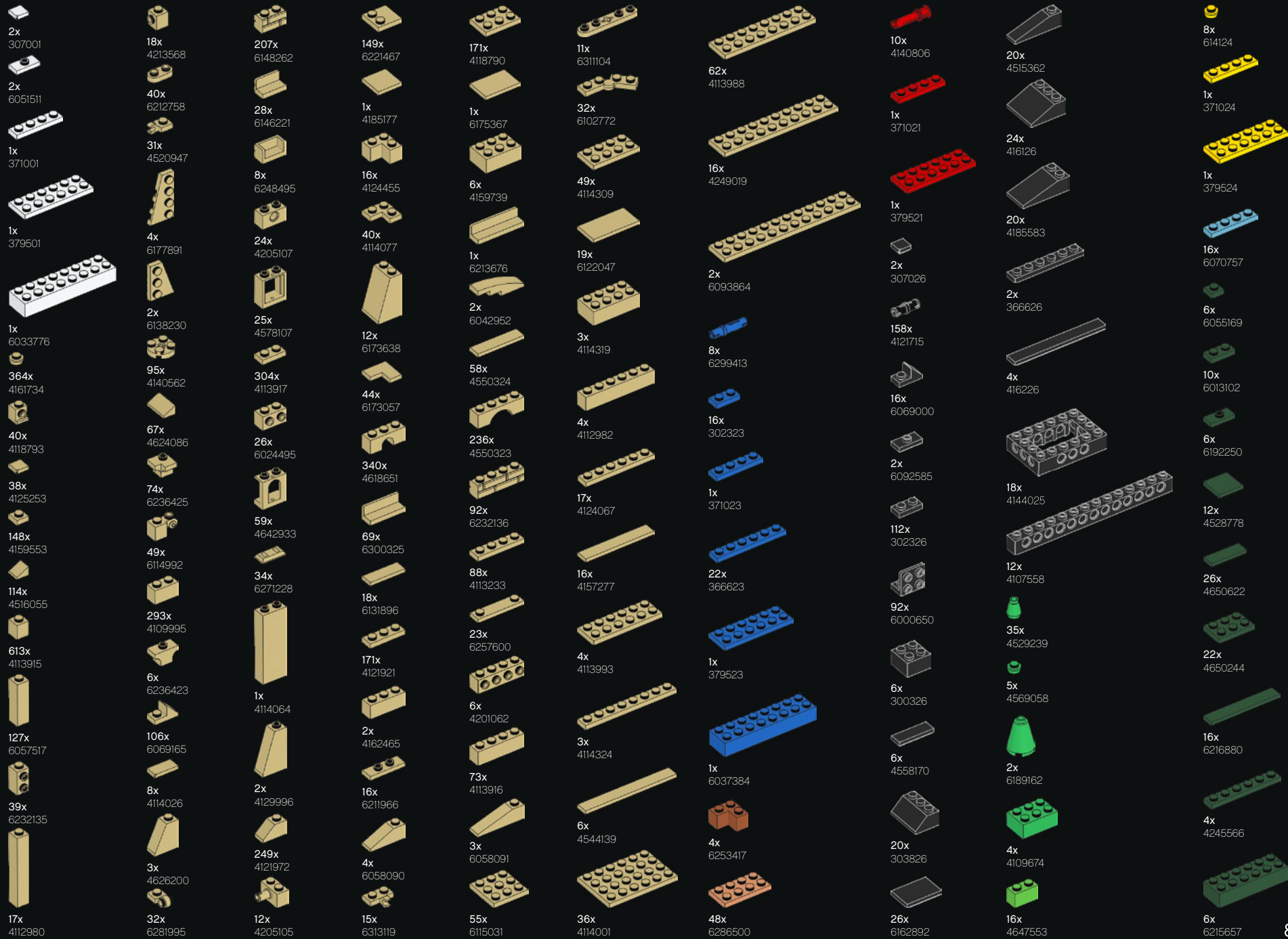

- 32x 6016483
- 10x 6212080
- 12x 6062697
- 36x 6016488
- 1x 6275877
- 1x 6195266
- 12x 6167700
- 1x 6240515

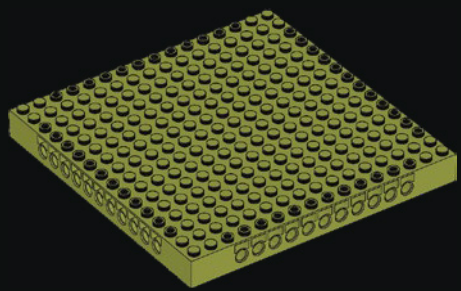

- 10x 6301768

- 115x 6300321
- 96x 6300320
- 133x 6300322
- 18x 6300318
- 36x 6055172
- 91x 4549436
- 14x 6040126
- 35x 6001824
- 239x 6231386
- 35x 6093064
- 142x 4528604
- 237x 6092591
- 35x 4521914
- 5x 4496699

- 17x 6167894
- 8x 4246957
- 115x 4530678
- 213x 4616711
- 36x 6047415
- 81x 4550168
- 40x 6184880
- 7x 6132768
- 14x 6015452
- 23x 6175927
- 23x 4626904
- 4x 4267874
- 1x 4507047
- 3x 6015424
- 1x 4550329
- 14x 6156492

- 56x 4530678
- 213x 4616711
- 36x 6047415
- 81x 4550168
- 40x 6184880
- 7x 6132768
- 14x 6015452
- 23x 6175927
- 23x 4626904
- 4x 4267874
- 1x 4507047
- 3x 6015424
- 1x 4550329
- 14x 6156492

- 19x 6039482
- 12x 4558955
- 6x 6225494
- 11x 6092572
- 79x 6039479
- 18x 4211052
- 20x 4211135
- 8x 6214341
- 92x 6308045
- 9x 6123814
- 8x 6126083
- 4x 4211094
- 2x 4211055
- 66x 4211104
- 24x 4211045
- 19x 6039482

- 12x 4558955
- 6x 6225494
- 11x 6092572
- 79x 6039479
- 18x 4211052
- 20x 4211135
- 8x 6214341
- 92x 6308045
- 9x 6123814
- 8x 6126083
- 4x 4211094
- 2x 4211055
- 66x 4211104
- 24x 4211045
- 19x 6039482

- 6x 4243831
- 18x 6187008
- 6x 4211043
- 48x 4211103
- 13x 6257592
- 24x 4211001
- 20x 4211053
- 20x 4535930
- 33x 4560184
- 2x 4211065
- 22x 4211085
- 4x 4211100
- 22x 4210651
- 6x 4243831

- 18x 6187008
- 6x 4211043
- 48x 4211103
- 13x 6257592
- 24x 4211001
- 20x 4211053
- 20x 4535930
- 33x 4560184
- 2x 4211065
- 22x 4211085
- 4x 4211100
- 22x 4210651
- 6x 4243831

- 4x 4211752
- 16x 4210998
- 2x 4210997
- 28x 6147337
- 2x 4211122
- 2x 6000970
- 18x 4256828
- 4x 6250216
- 4x 6151666
- 8x 6177081
- 4x 4539076

- 16x 4210998
- 2x 4210997
- 28x 6147337
- 2x 4211122
- 2x 6000970
- 18x 4256828
- 4x 6250216
- 4x 6151666
- 8x 6177081
- 4x 4539076

- 14x 4211848
- 1x 6170468
- 12x 6323704
- 11x 6116613
- 4x 6096701
- 20x 6168647
- 6x 4211399
- 75x 6043656
- 4x 6273227
- 9x 6043639
- 126x 6211969
- 8x 4211752

- 1x 6170468
- 12x 6323704
- 11x 6116613
- 4x 6096701
- 20x 6168647
- 6x 4211399
- 75x 6043656
- 4x 6273227
- 9x 6043639
- 126x 6211969
- 8x 4211752

- 14x 4211848



Customer Service
Kundenservice
Service Consommateurs
Servicio Al Consumidor

LEGO.com/service or dial

00800 5346 5555 : 

1-800-422-5346 : 





FEEDBACK AND WIN



FEEDBACK AND WIN

Your feedback will help shape the future development of this product series.

Please visit:

FEEDBACK UND GEWINNEN

Dein Feedback trägt zur Weiterentwicklung dieser Produktreihe bei.

Geh auf:

COMMENTEZ ET GAGNEZ

Vos commentaires nous aideront à concevoir les futurs produits de cette gamme.

Rendez-vous sur :

COMENTA Y GANA

Tu opinión nos ayudará a dar forma al desarrollo de esta serie de productos en el futuro.

Visita:

反馈有奖

您的反馈将有助于我们在今后改进本系列产品。

请访问：

[LEGO.com/productfeedback](https://www.lego.com/productfeedback)

By completing, you will automatically enter a drawing to win a LEGO® set.

Terms & Conditions apply.

Durch Ausfüllen nimmst du automatisch an der Verlosung eines LEGO® Preises teil.

Es gelten die Teilnahmebedingungen.

En envoyant vos commentaires, vous serez automatiquement inscrit(e) à un tirage au sort qui vous permettra de remporter un prix LEGO®.

Offre soumise à conditions.

Al contestar, participarás automáticamente en el sorteo y podrás ganar un set LEGO®.

Sujeto a Términos y Condiciones.

完成我们的反馈调查，即可自动进入抽奖环节，赢取乐高®套装。

适用《条款和条件》。

