

S·P·Q·R·

COLISEO

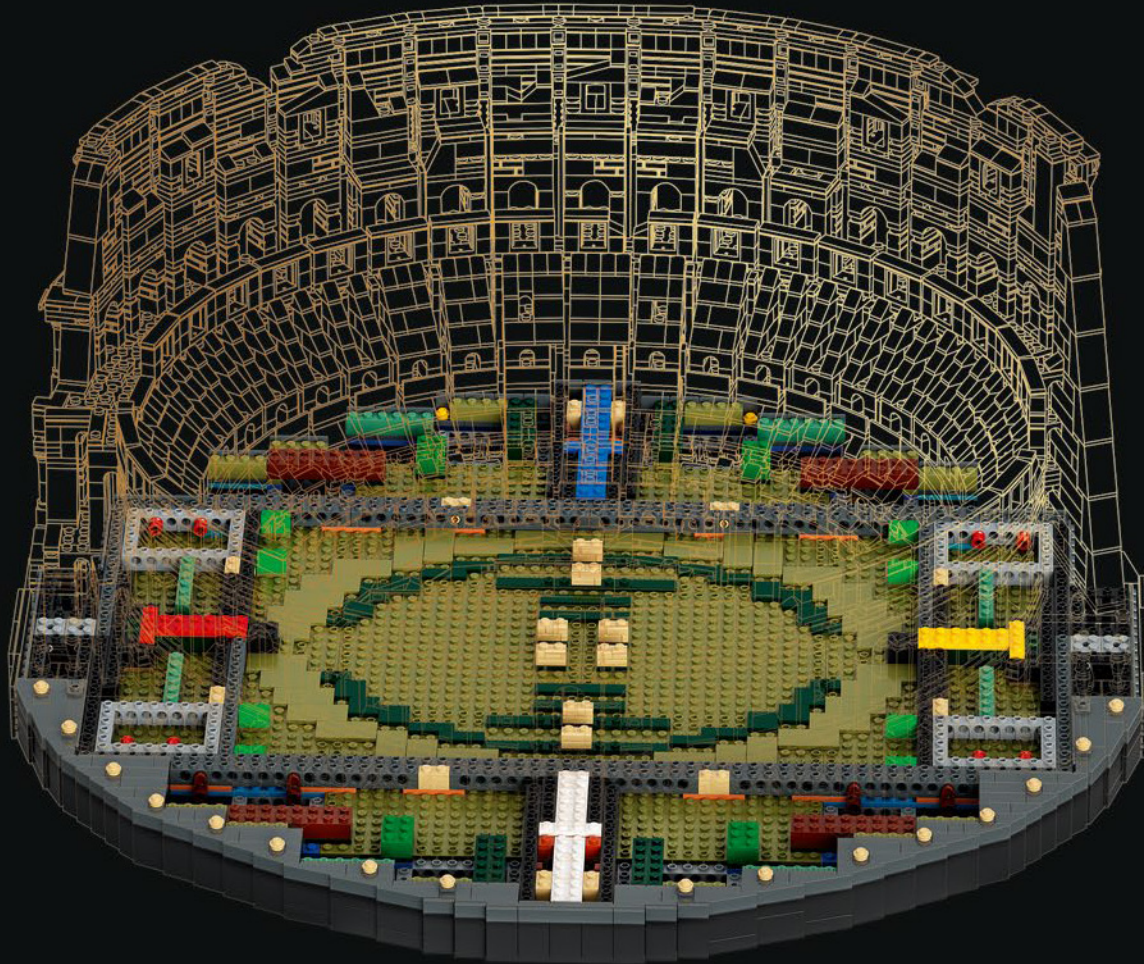

I

TE DAMOS LA BIENVENIDA

Nos complace presentarte nuestra interpretación del famoso Coliseo de Roma. Tanto si te trae recuerdos de una visita a la Ciudad Eterna como si despierta tu interés por la arquitectura clásica o, simplemente, es tu forma de relajarte, esperamos que te proporcione horas de placentera construcción con LEGO®.

Jamie Berard, jefe de diseño

EL COLISEO

El Coliseo se encuentra en el corazón de la capital de Italia y es un inconfundible símbolo de su pasado como parte del Imperio romano. Este impresionante anfiteatro, el más grande que se construyó en aquella época, podía alojar entre 50.000 y 80.000 espectadores. La gente se reunía allí para ver combates entre gladiadores, cacerías de animales e, incluso, recreaciones de famosas batallas navales. Ampliamente considerado como una de las siete maravillas del mundo moderno, es también una de las atracciones turísticas más populares y recibe más de 7 millones de visitantes cada año.





Mientras que los antiguos teatros griegos se construían en las laderas de las montañas, el imponente Coliseo se erige en solitario, sobre el fondo llano de un valle, en el centro de Roma.

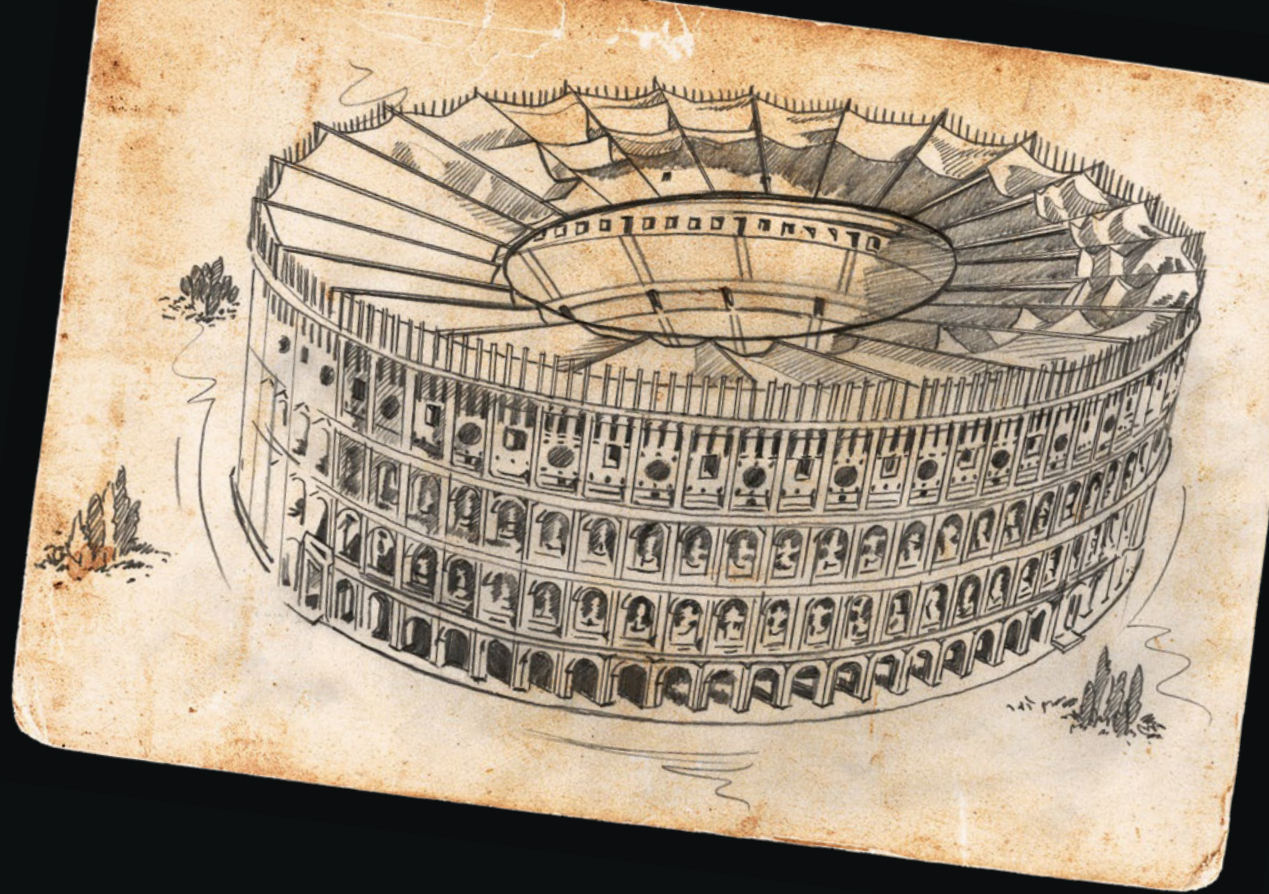

ANFITEATRO

El Coliseo es una estructura elíptica independiente de 189 m de longitud y 156 m de anchura. La arena interior ovalada tiene 87 m de longitud y 55 m de anchura, y está rodeada por un imponente muro de 5 m, por encima del cual se eleva el espectacular graderío. El muro exterior del Coliseo alcanza una altura de 48 m, que aún sería mayor si se consideran los mástiles de madera para sujetar los toldos móviles que se desplegaban en ocasiones mediante complejos mecanismos.



80 entradas a nivel del suelo rodeaban la estructura. Las 4 entradas axiales principales estaban reservadas para el emperador y las élites de la ciudad, y estaban generosamente decoradas.

CONSTRUCCIÓN

La construcción del Coliseo requirió más de 100.000 m³ de travertino (45.000 de los cuales se emplearon en el levantamiento de los muros exteriores). En lugar de usar mortero, las piedras se unieron mediante más de 300 t de abrazaderas de hierro. La fachada exterior de la estructura se compone de 3 niveles, cada uno con 80 imponentes arcadas. En la arena, una plataforma de madera cubierta de tierra ocultaba un elaborado sistema subterráneo denominado *hipogeo*.



HIPOGEO

El hipogeo era una red subterránea de 2 niveles compuesta de túneles y jaulas que se agregó después de la construcción original del Coliseo. Era donde se alojaban los gladiadores y los animales antes de los combates. Su construcción significó el fin de las espectaculares recreaciones de batallas navales, pues ya no era posible inundar la arena.



LEGO.com/brickseparator

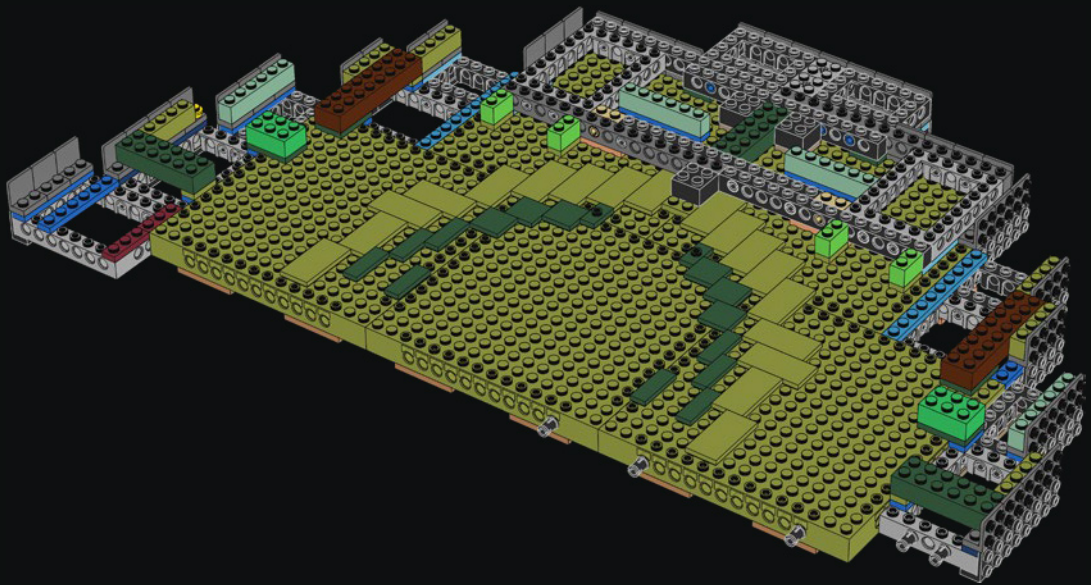

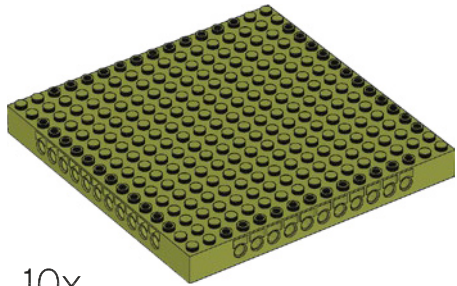

10x

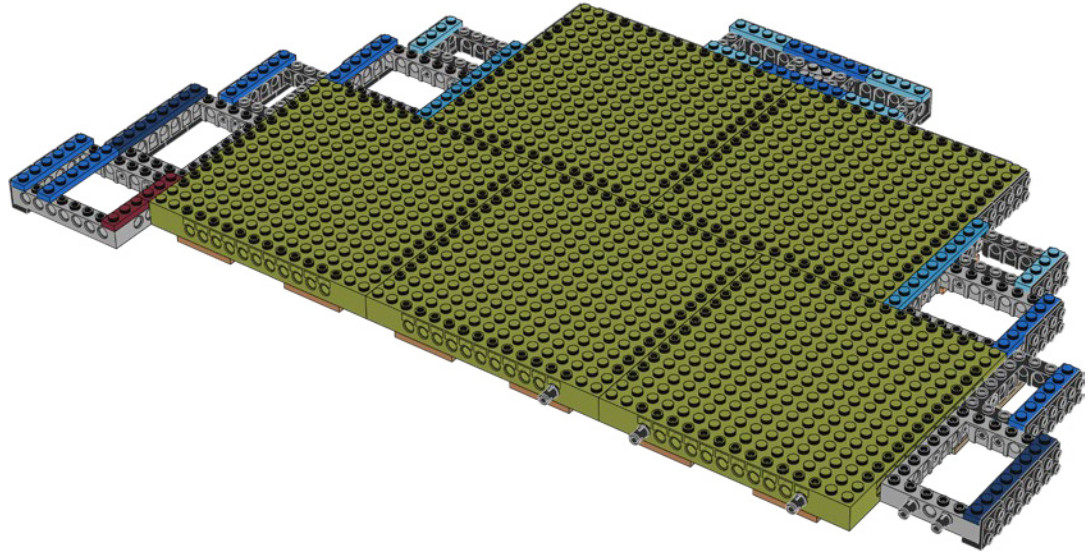
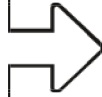

2x



1

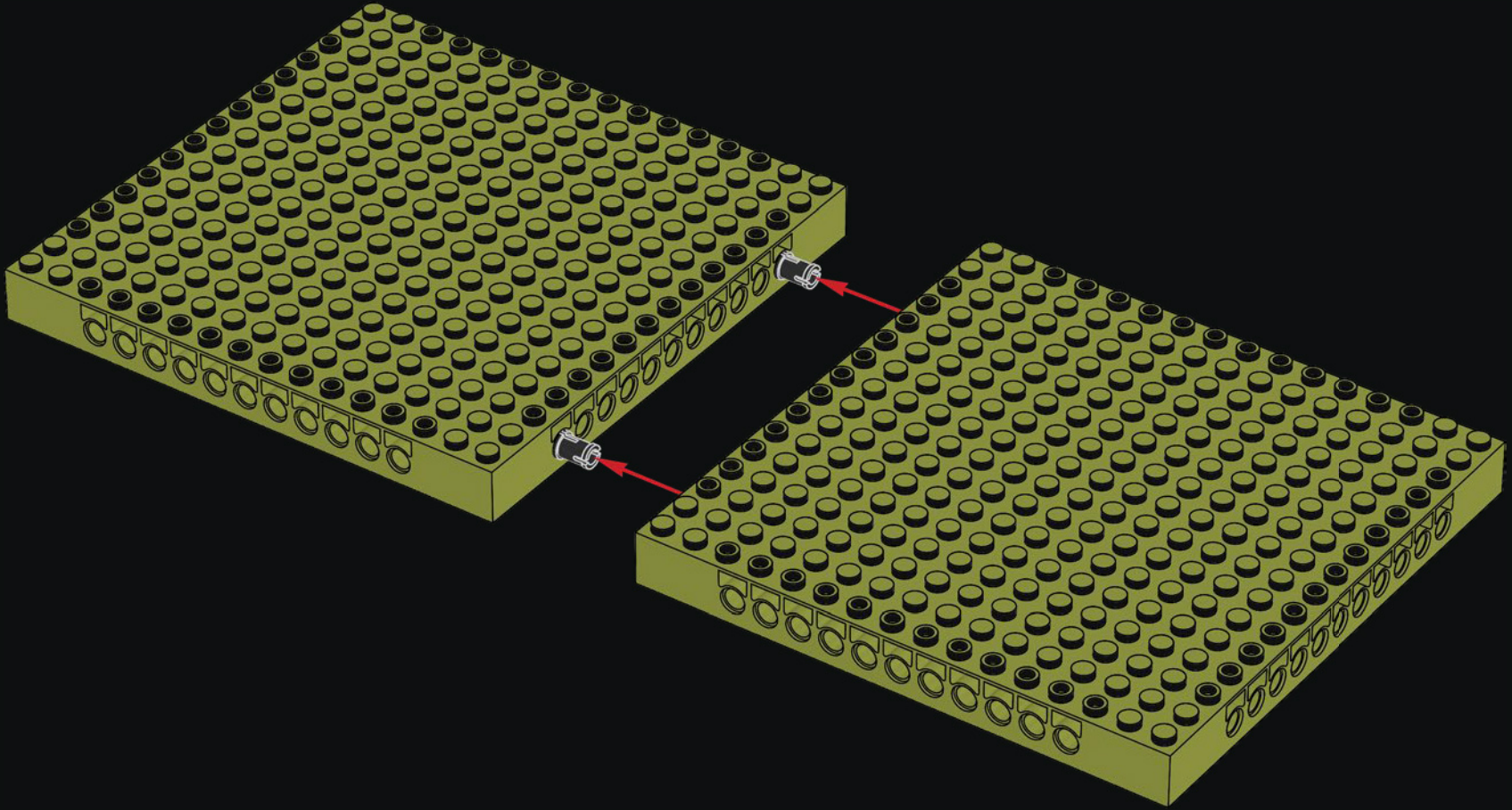

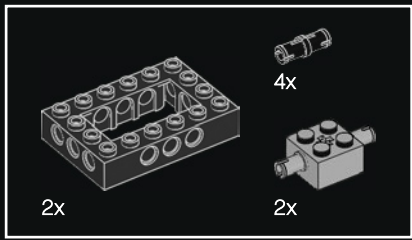

2

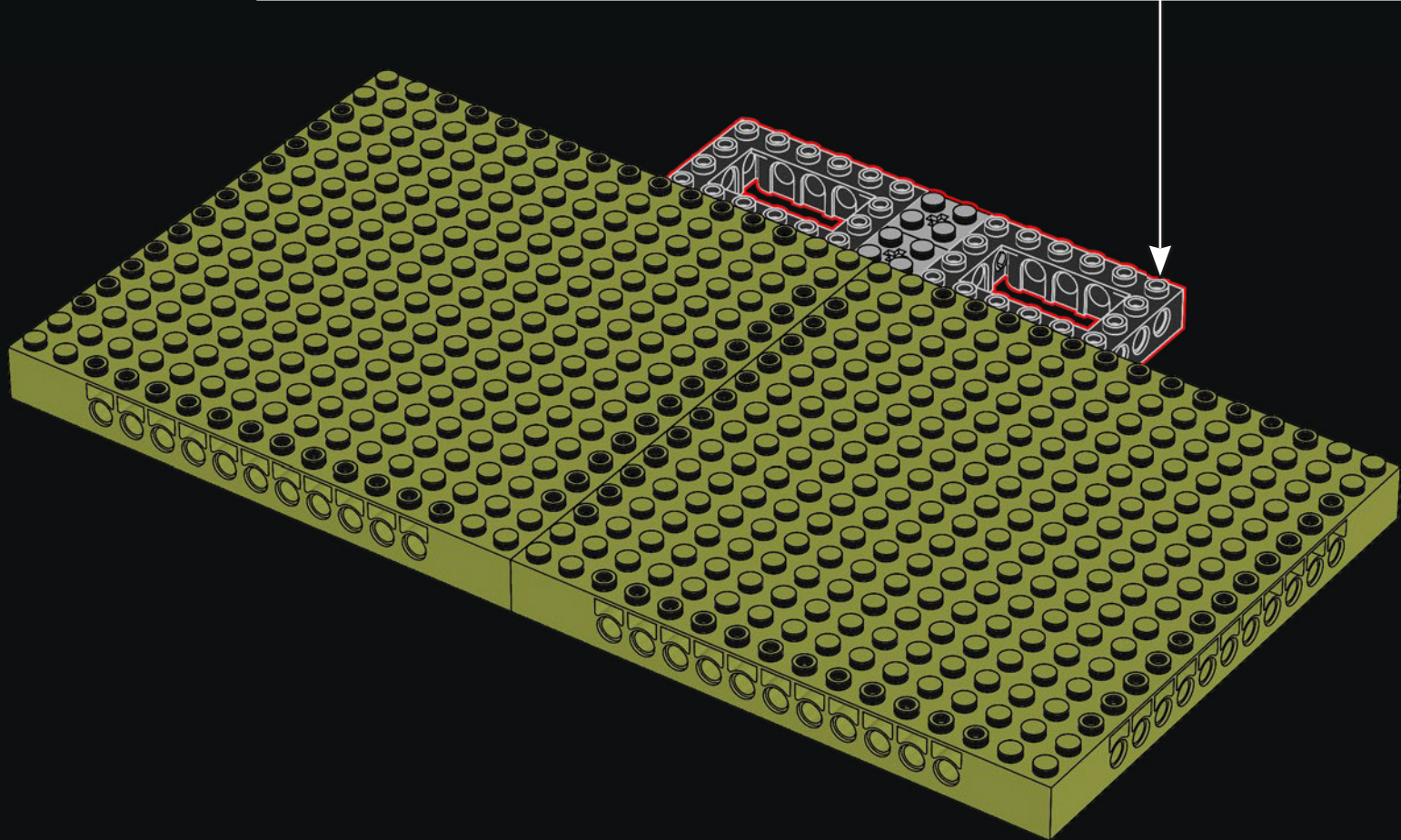
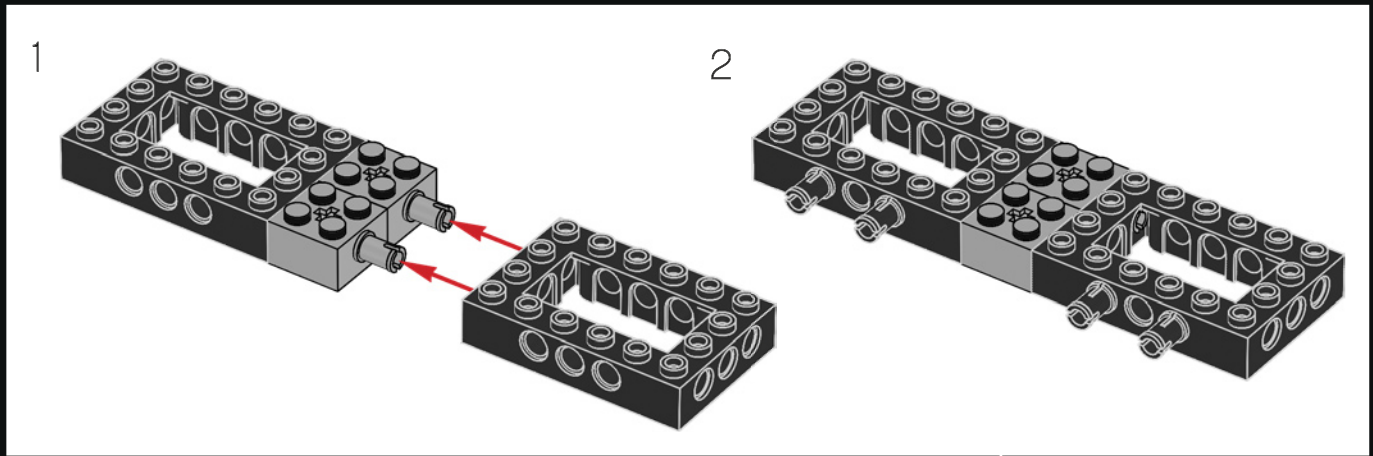



3

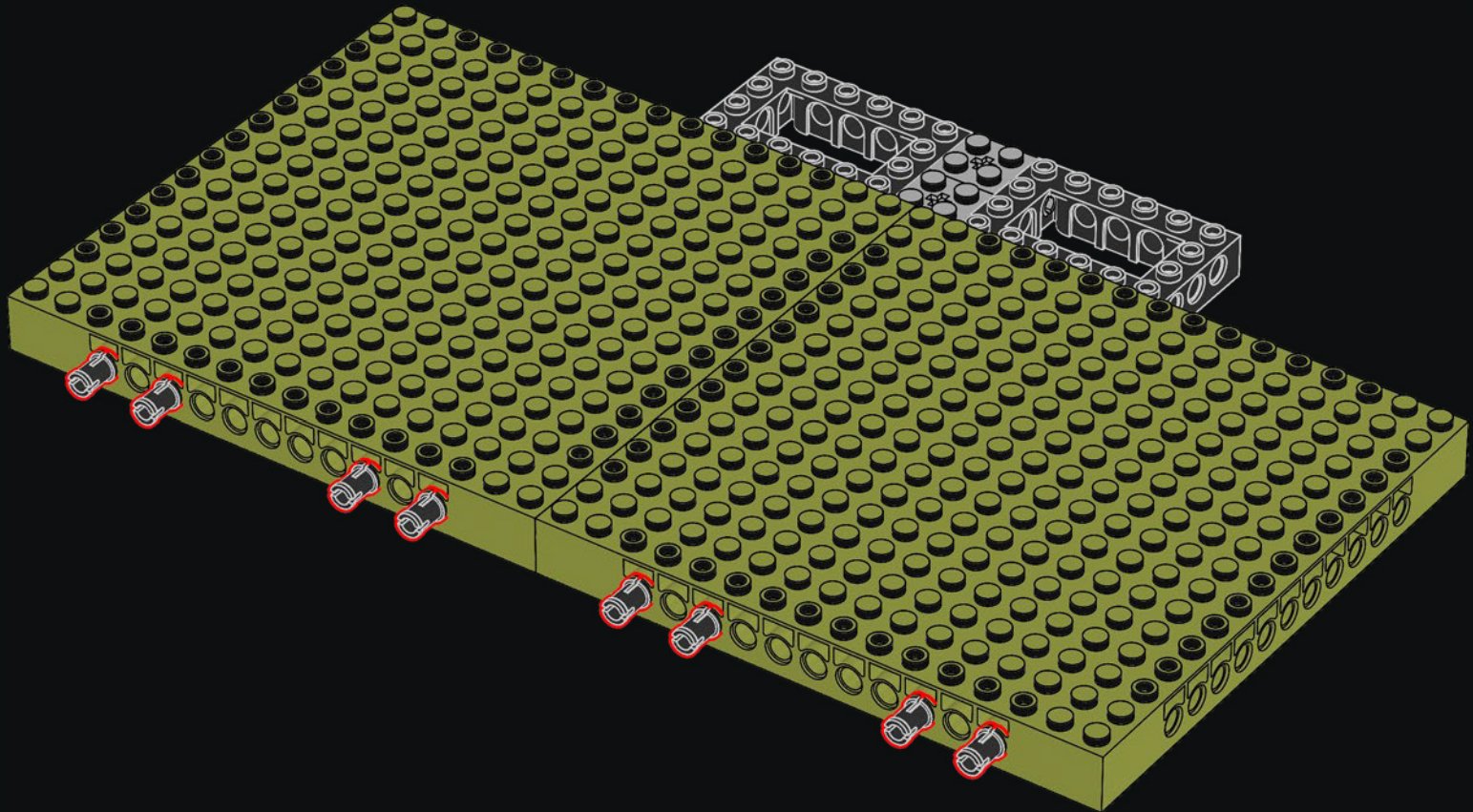

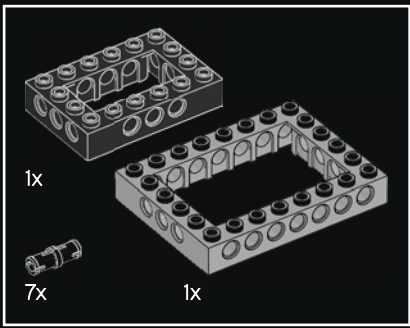

4

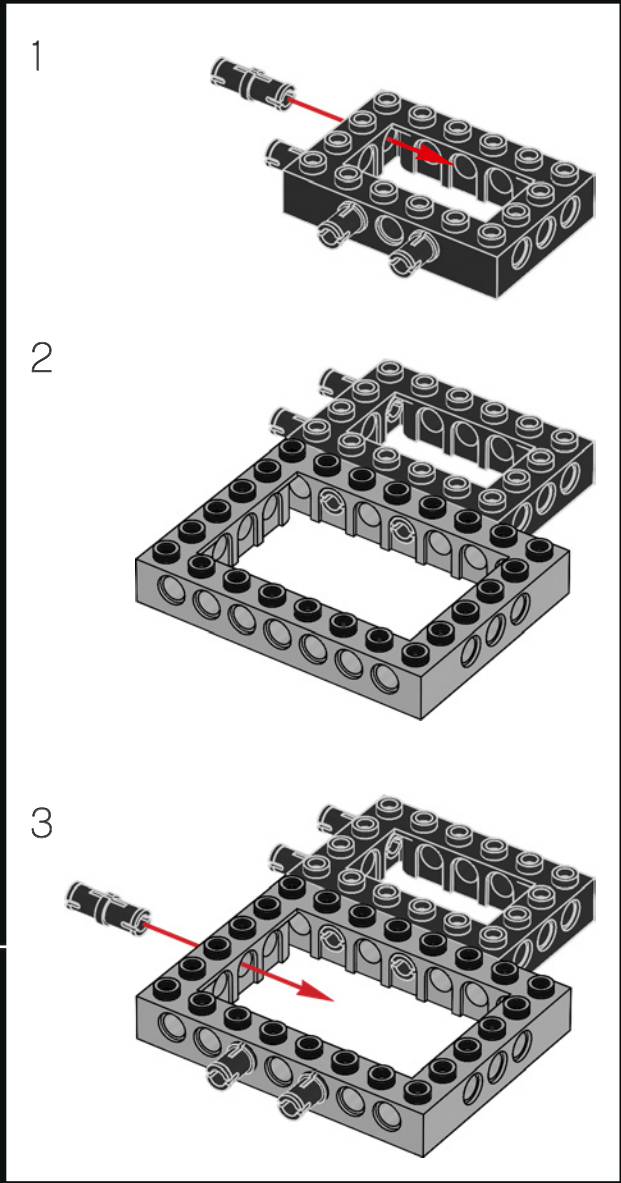
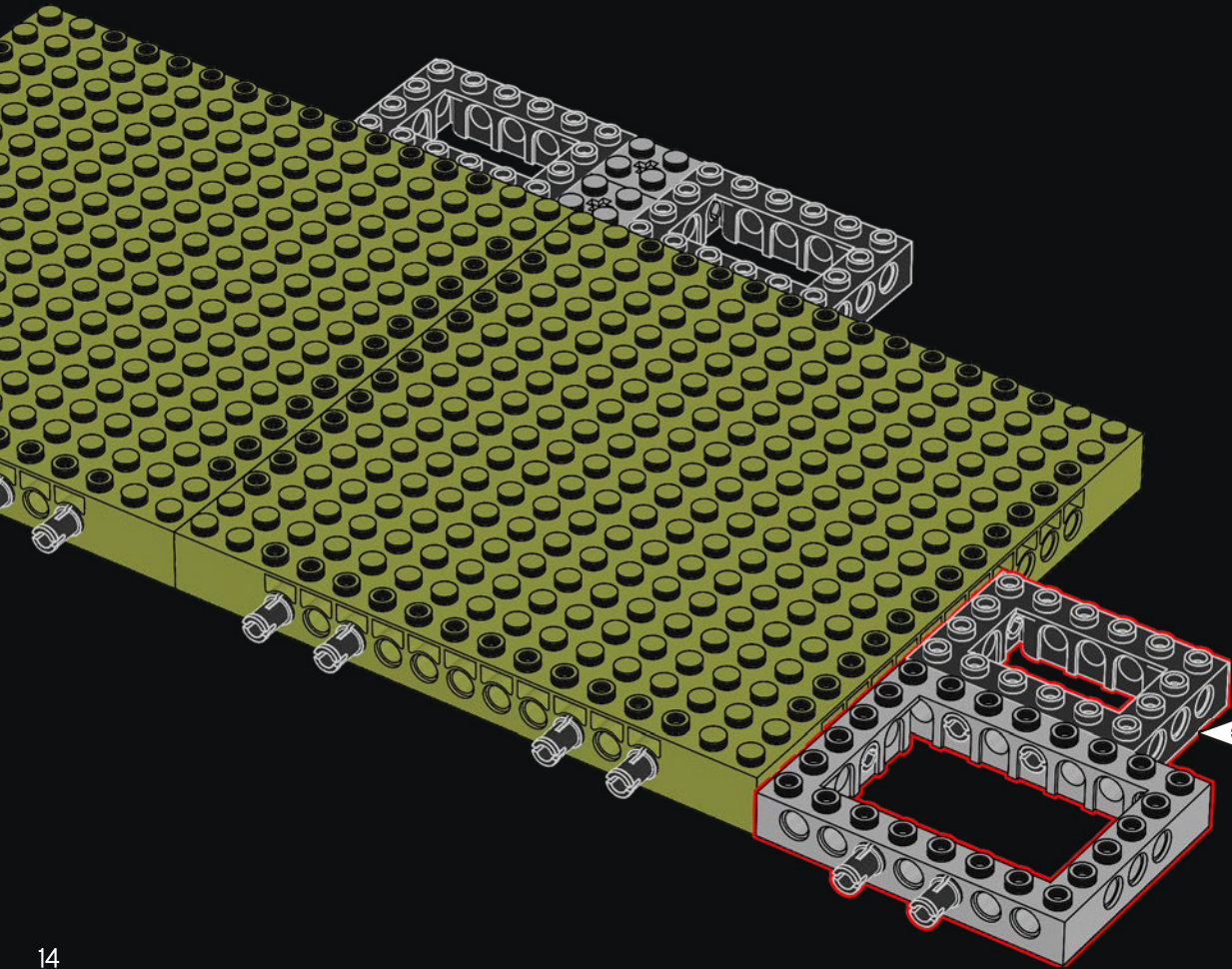

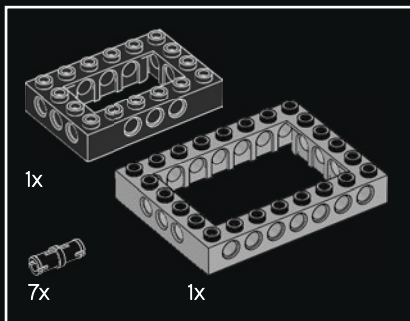

5

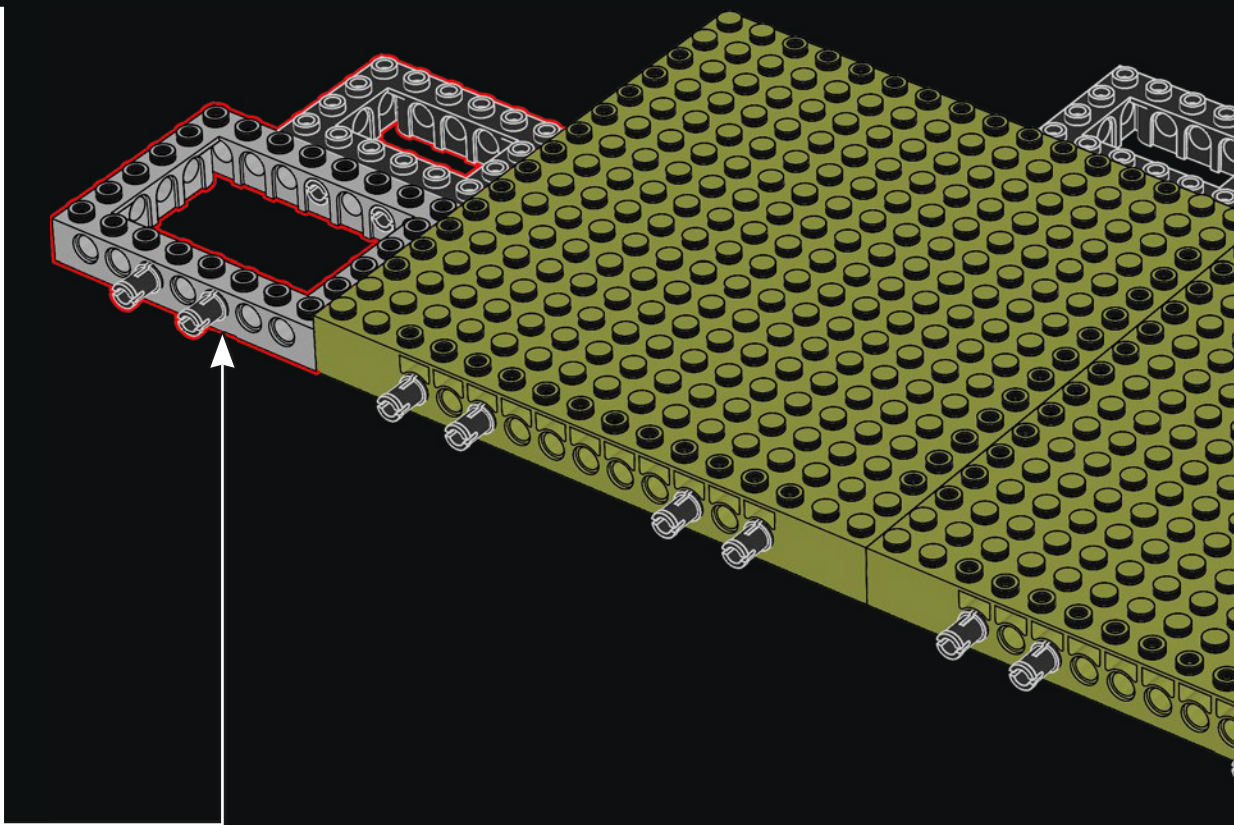
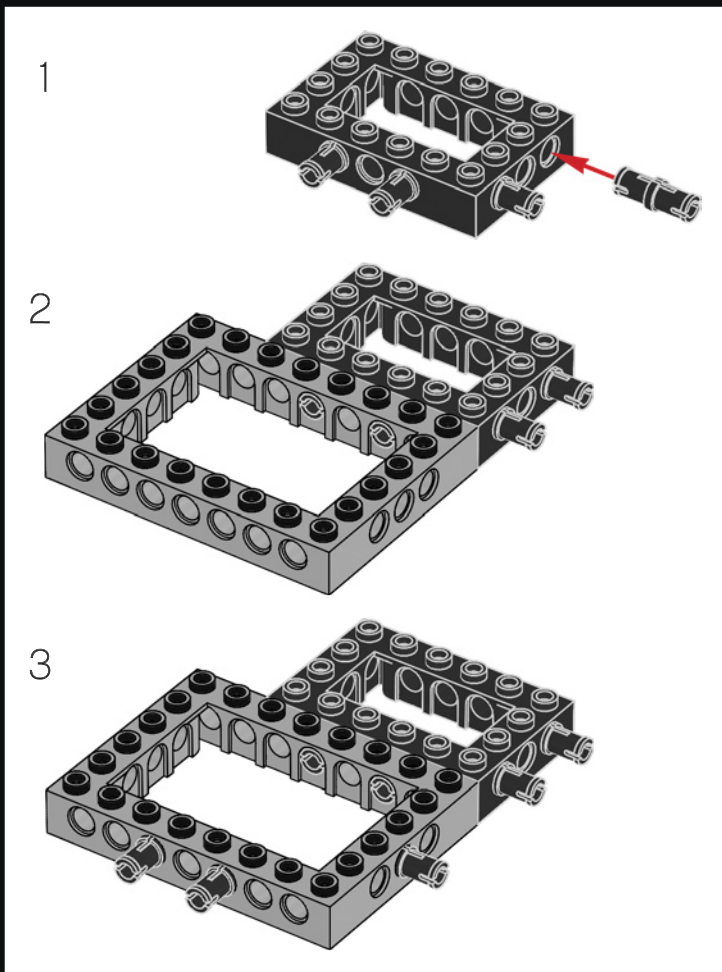



2x

6

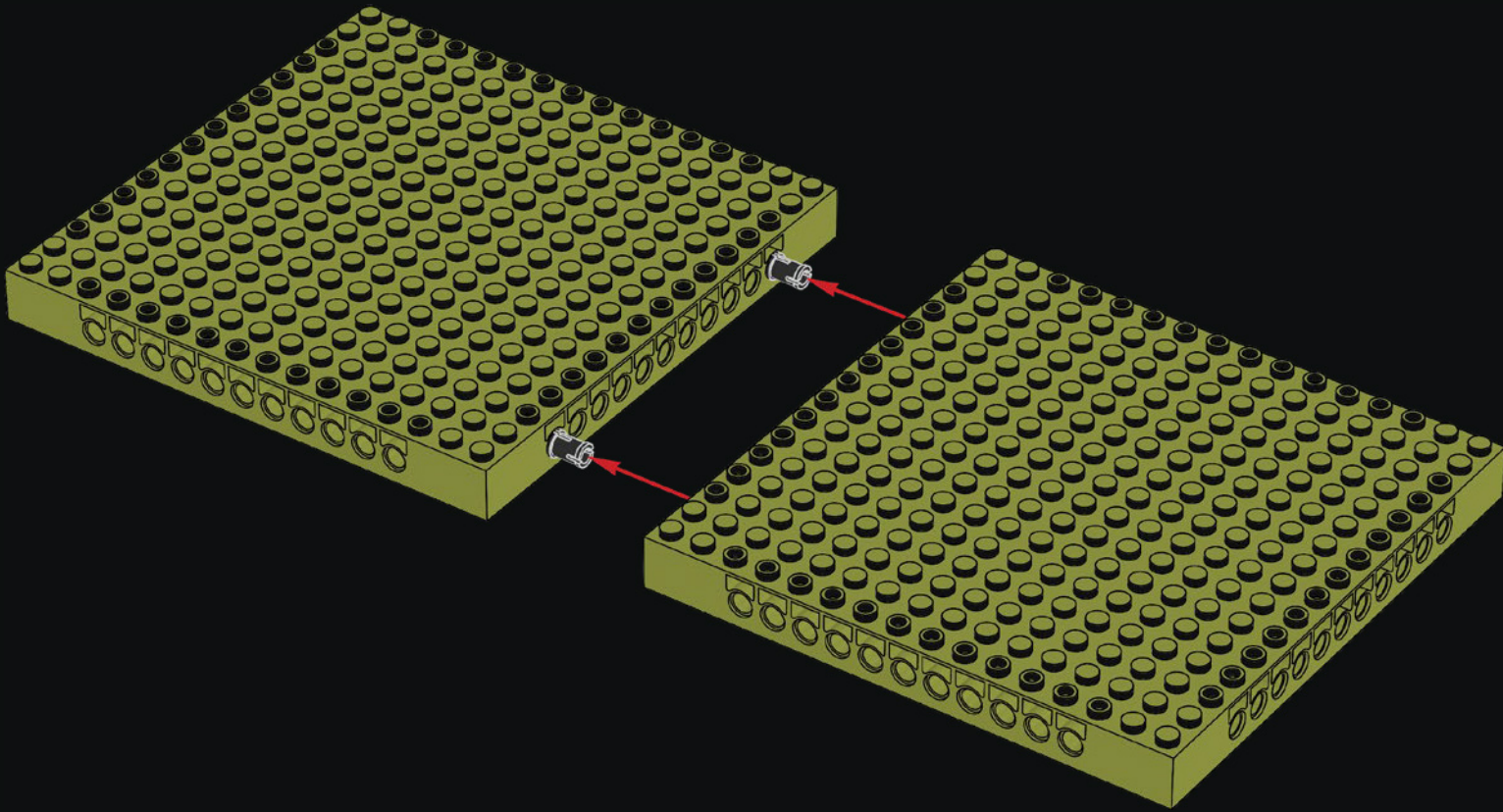



7

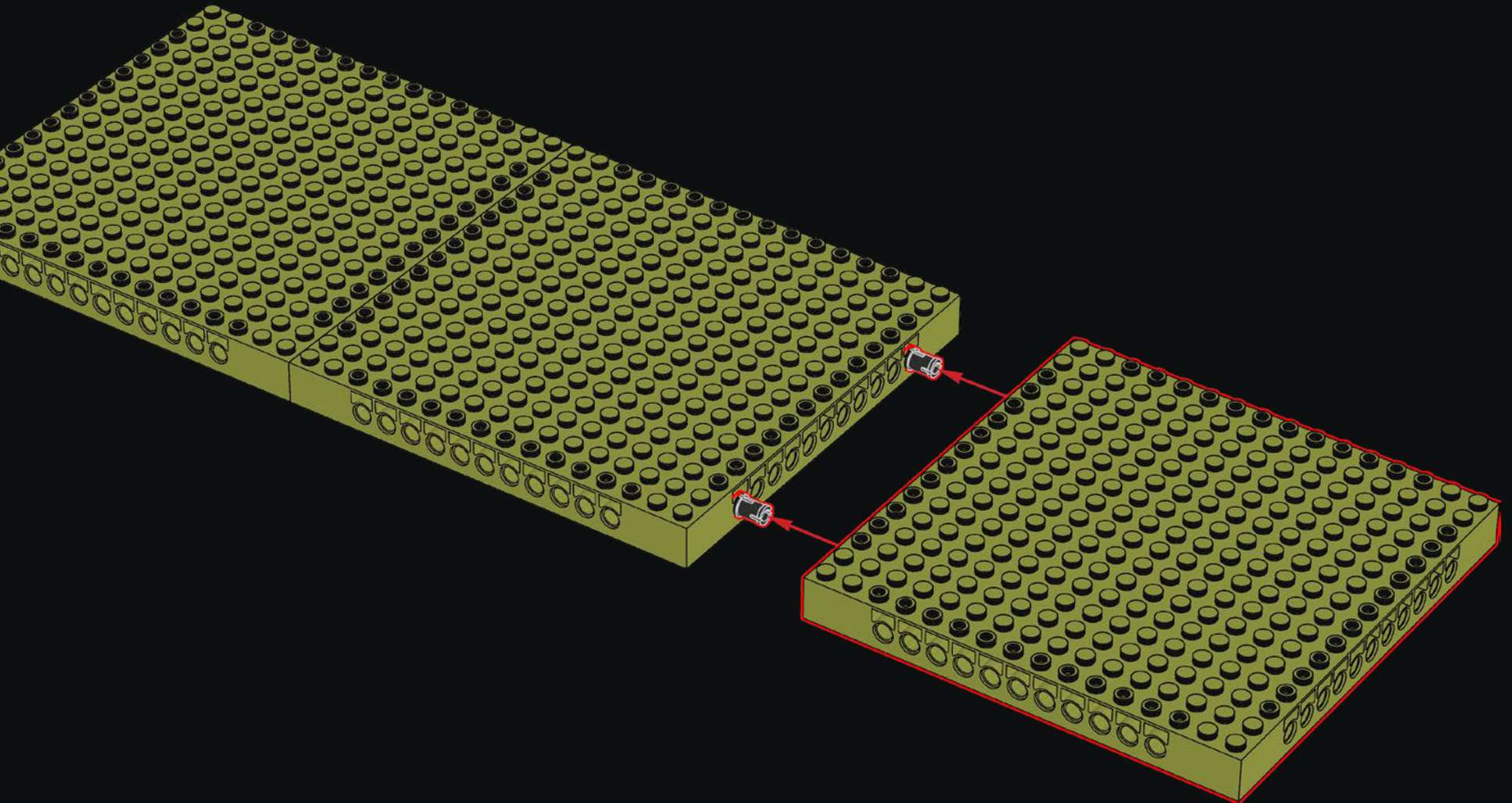

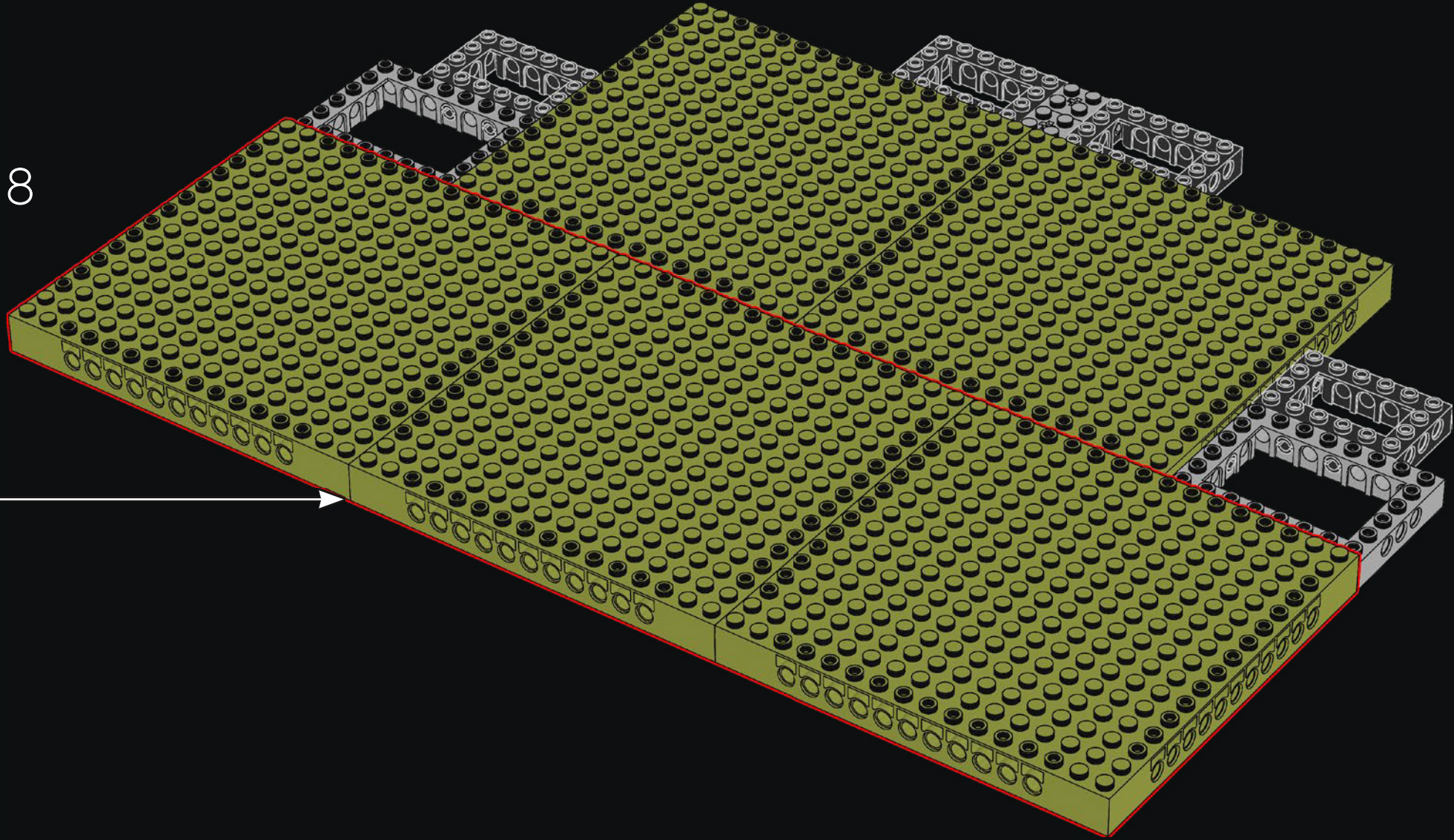

8

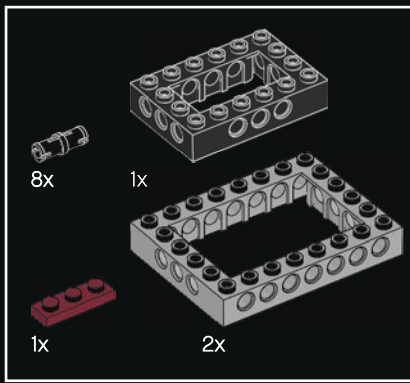

9

1

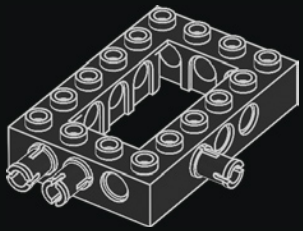

2

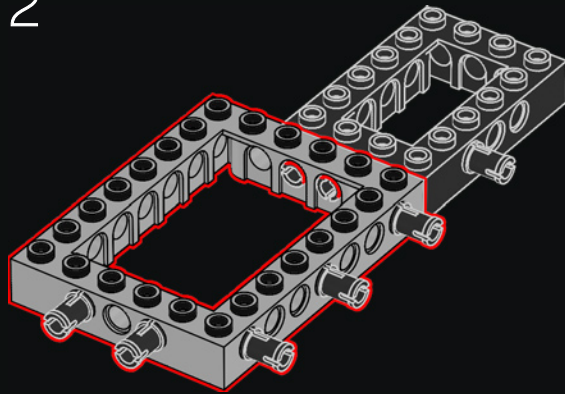

3

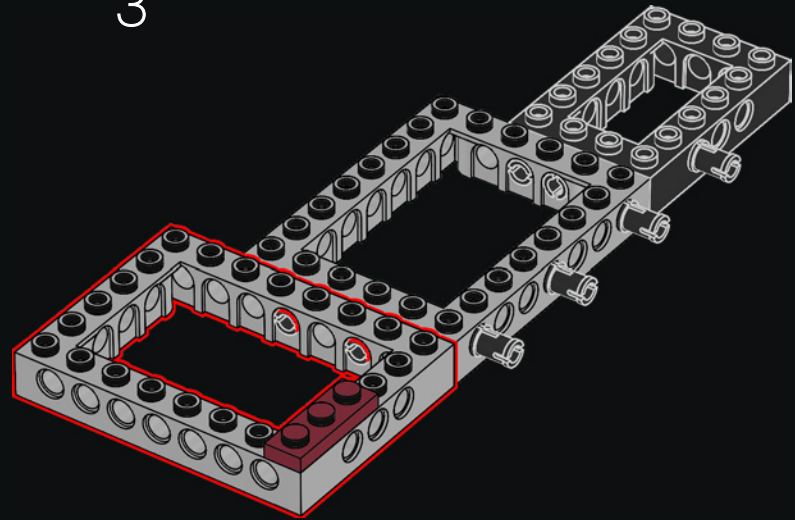

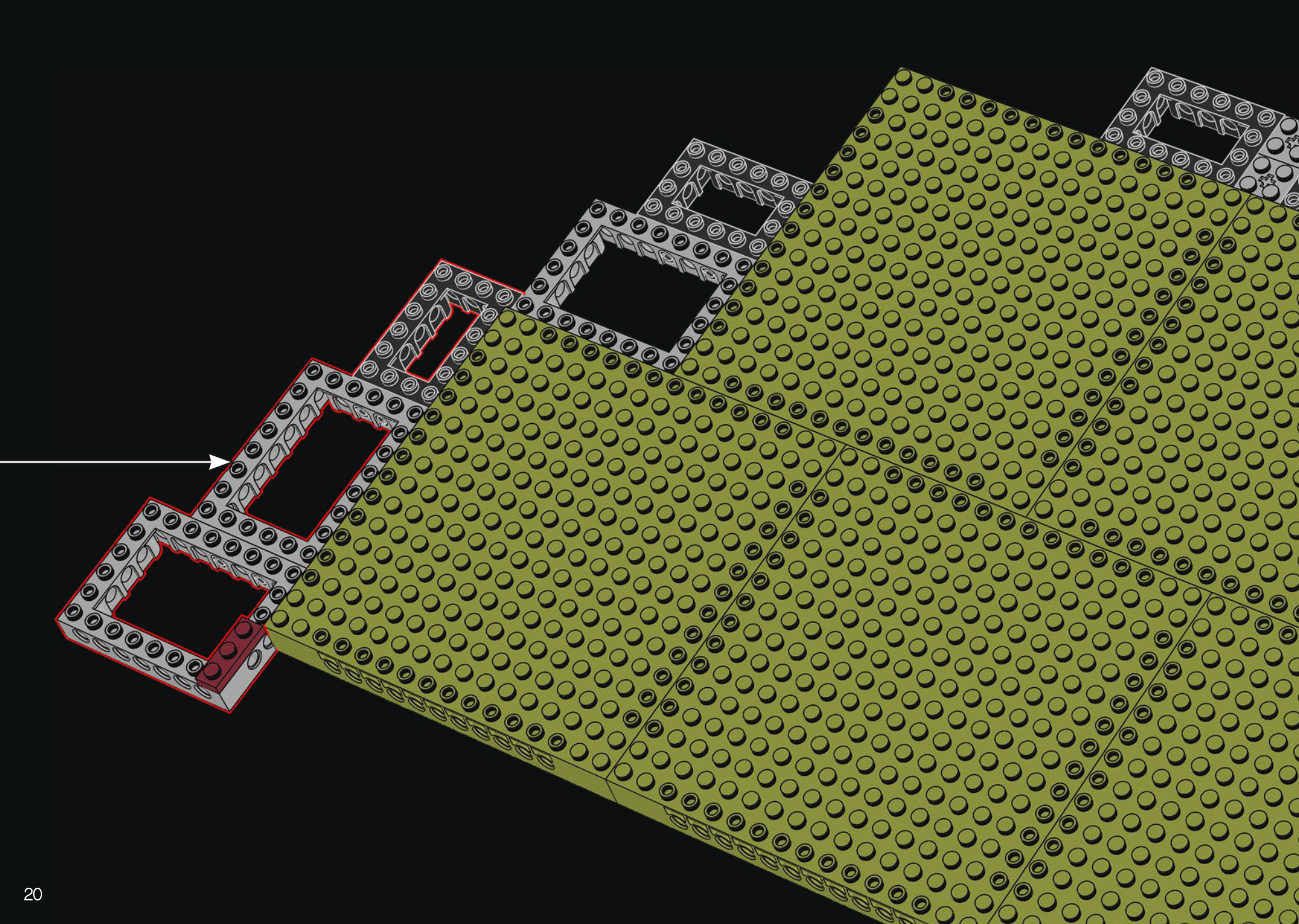

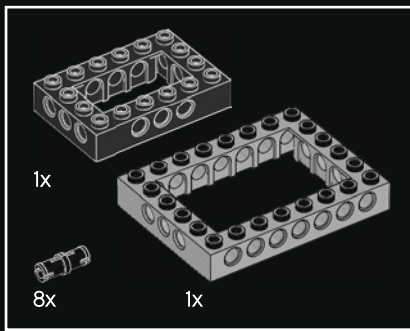

10

1

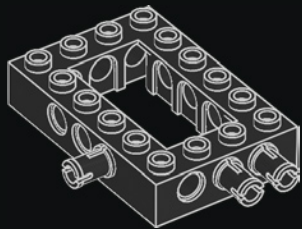

2

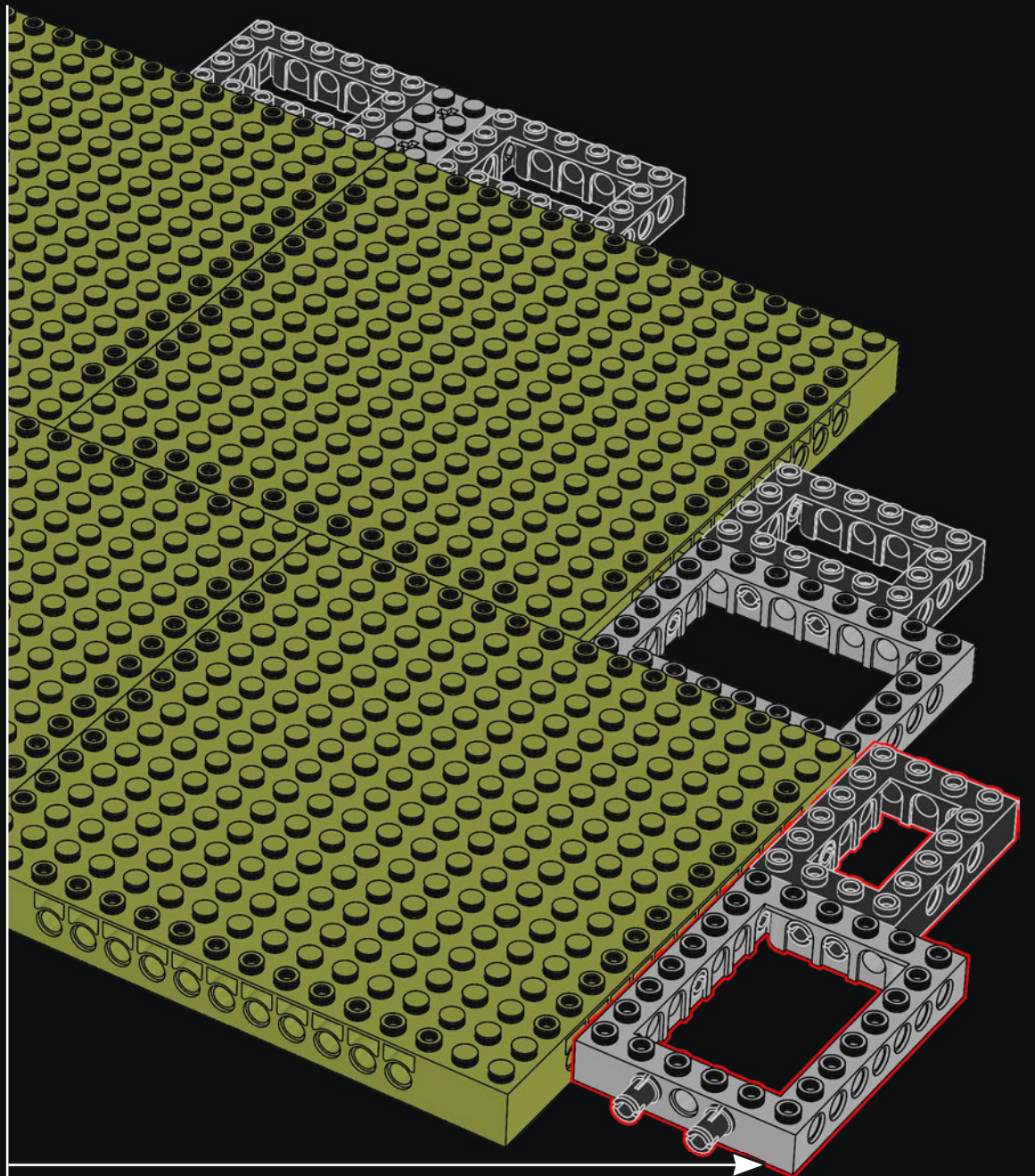
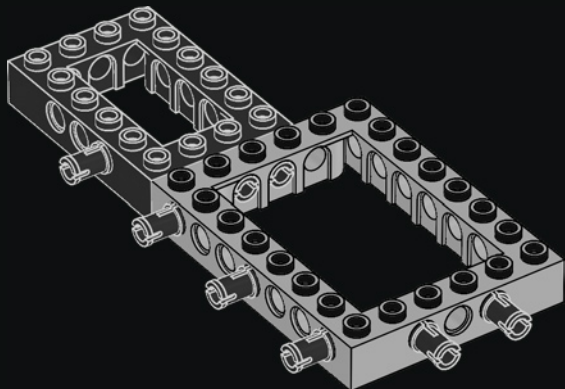

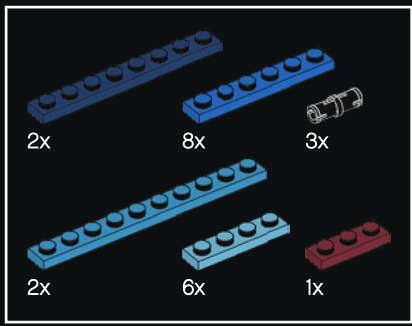

11

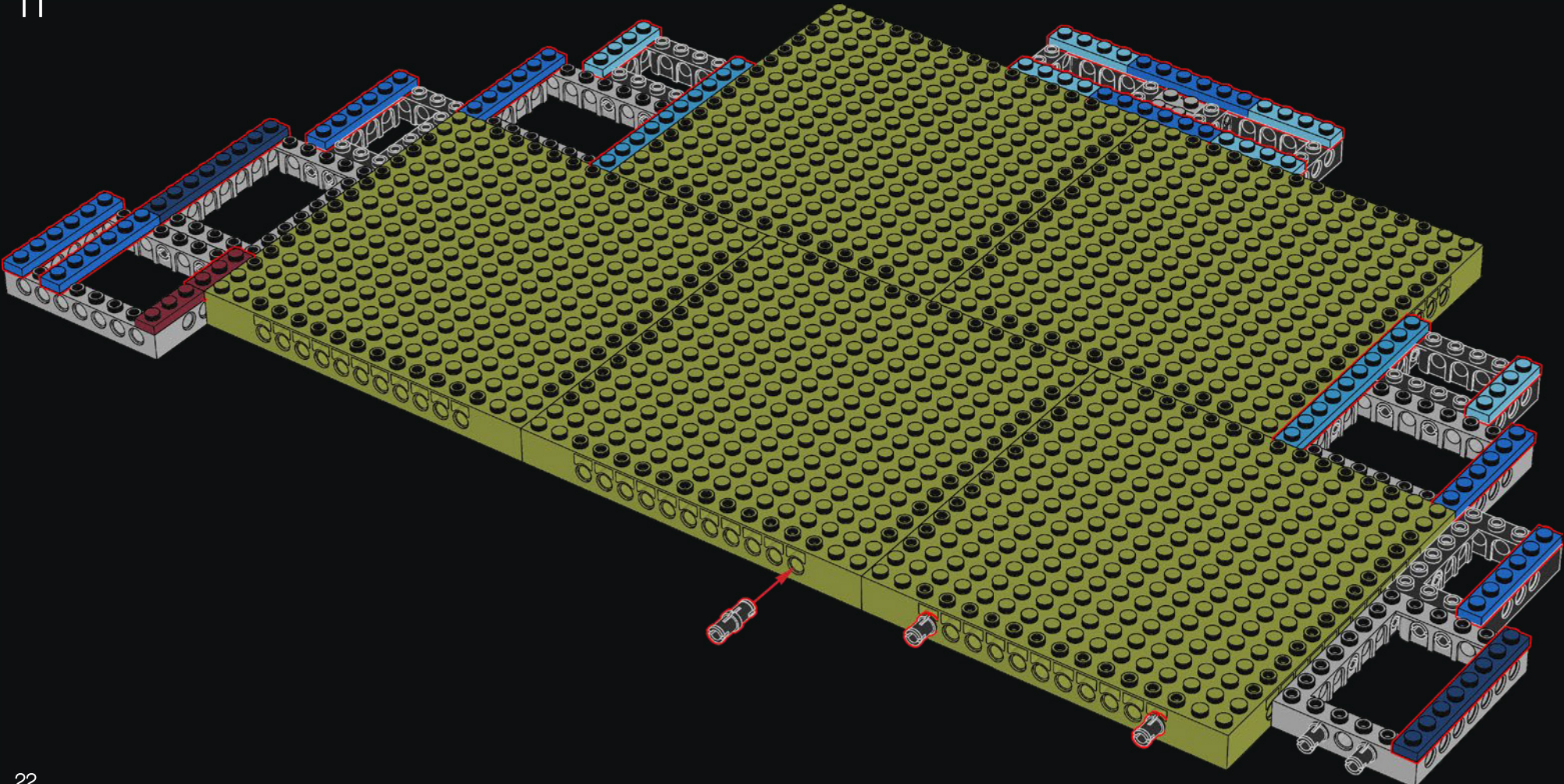

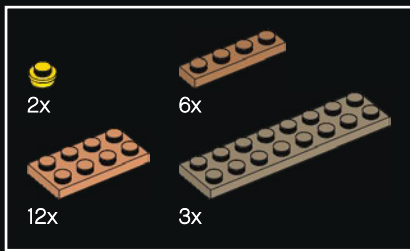

12





46x

13

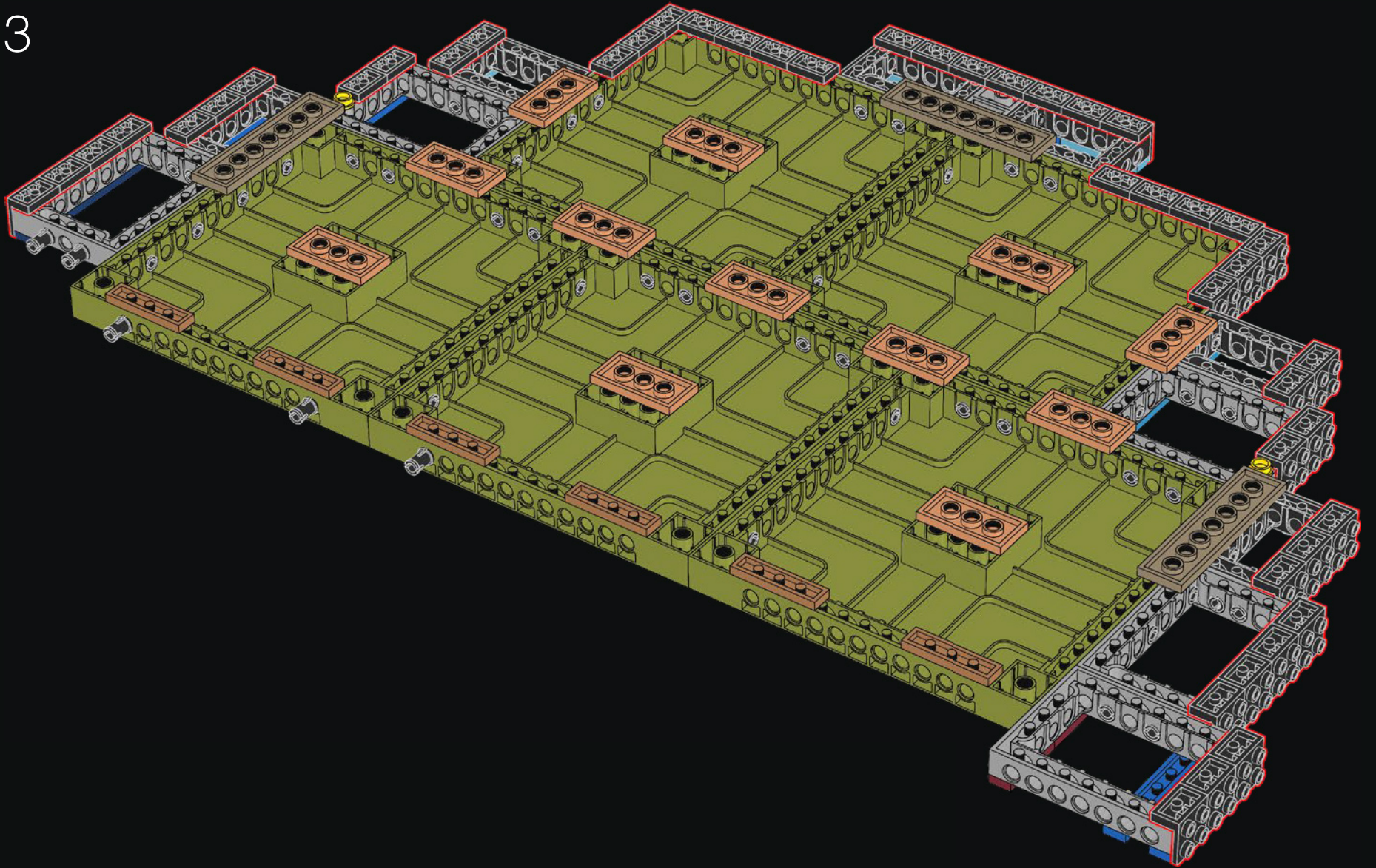

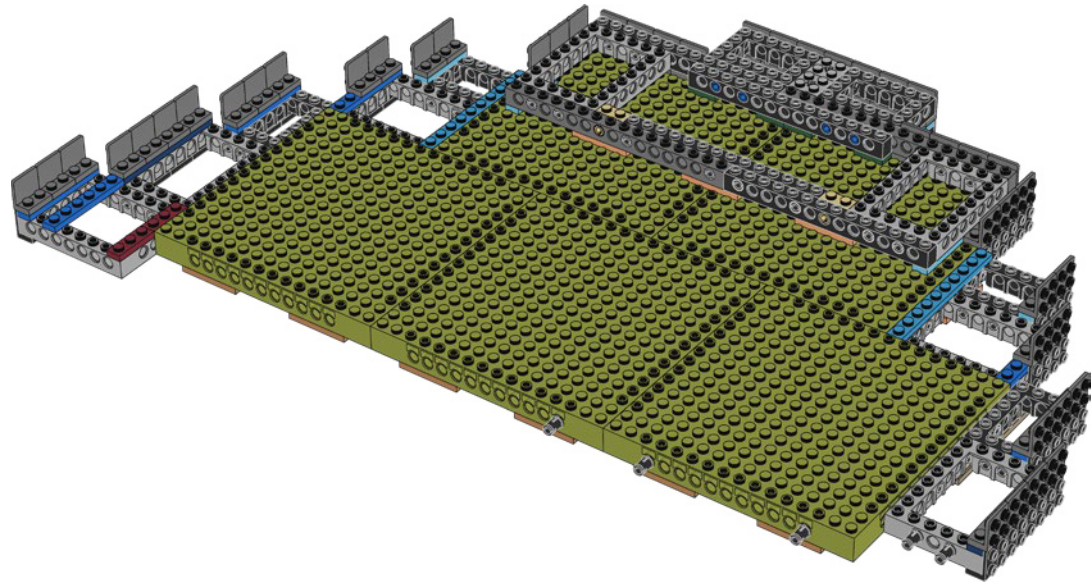
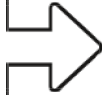



46x

14

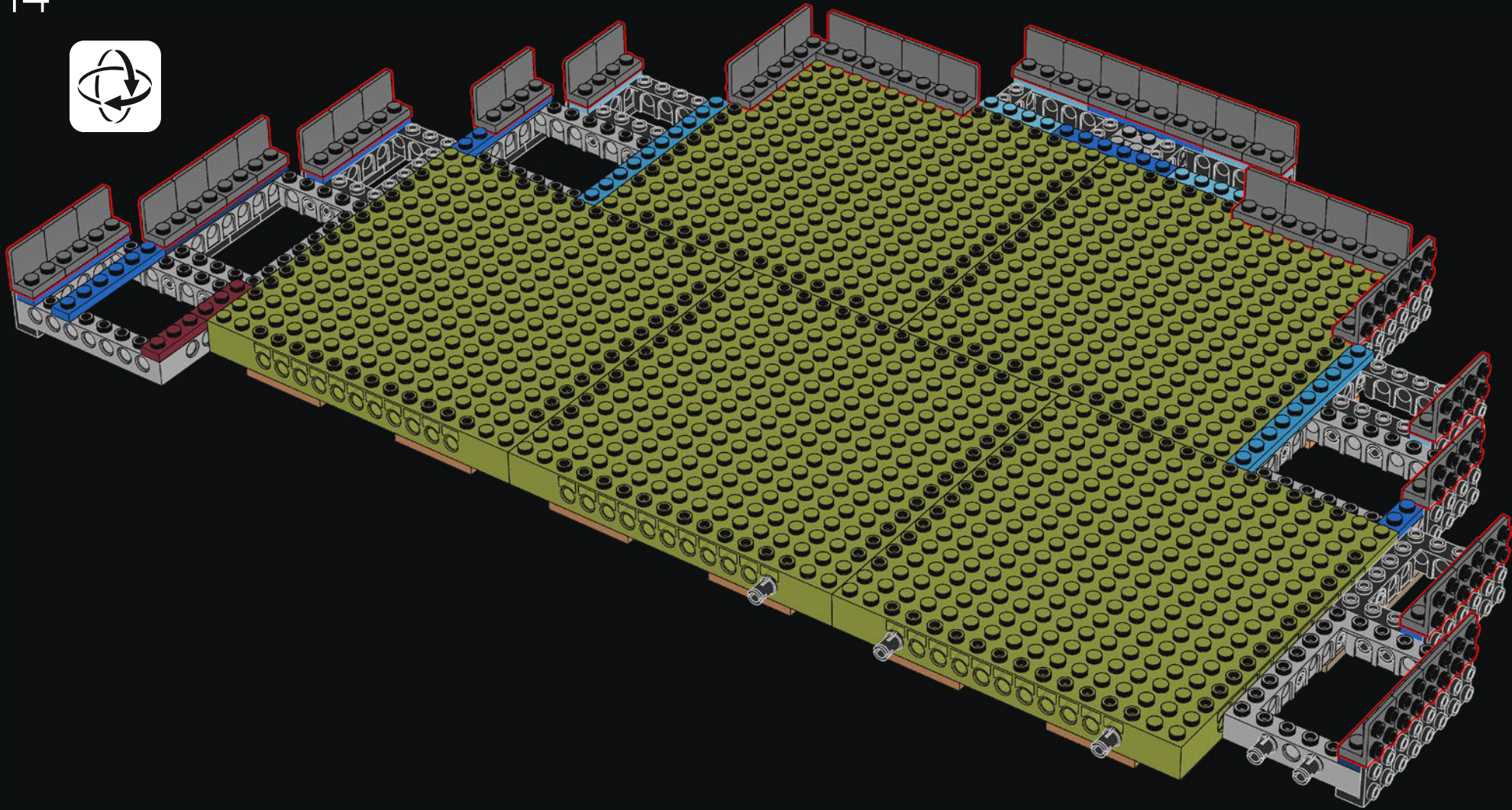

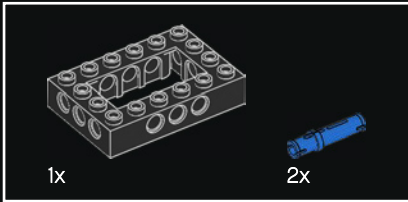
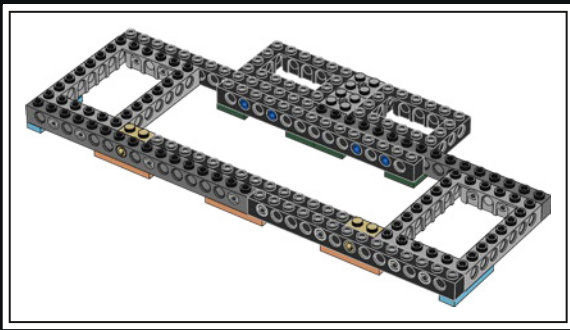

15

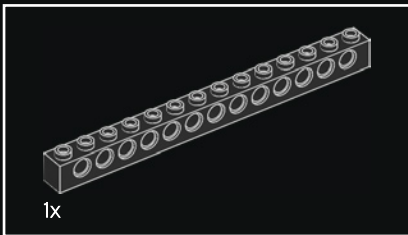
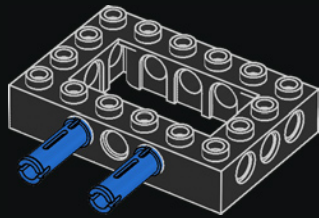

16

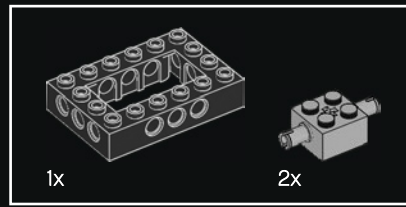
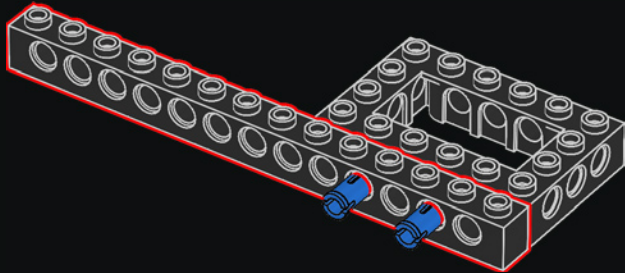

17

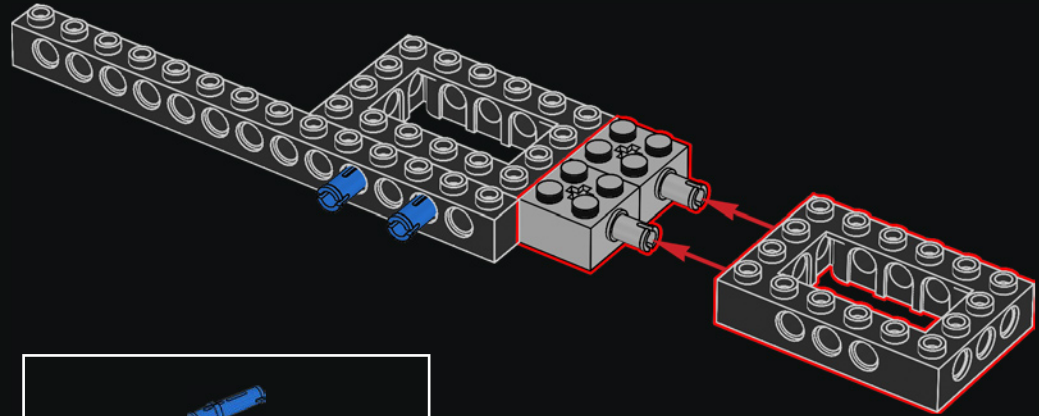

18

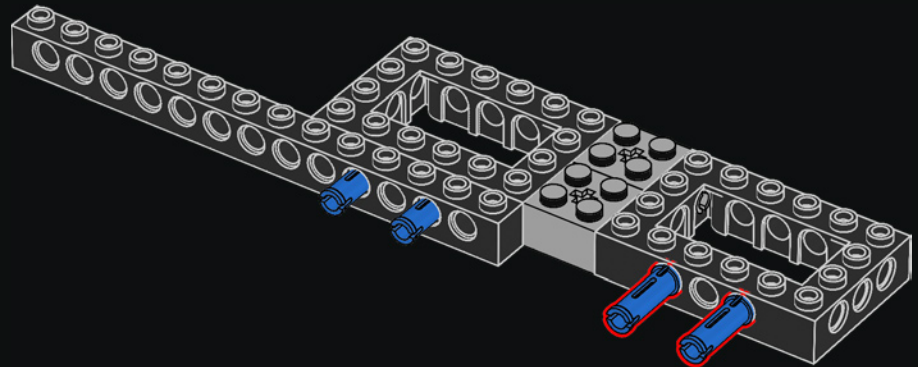

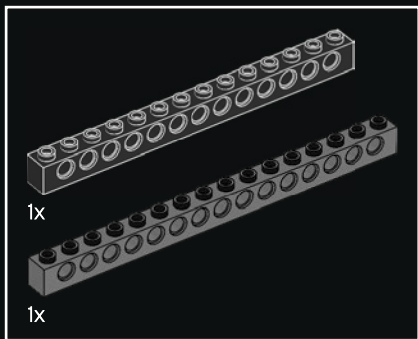

19

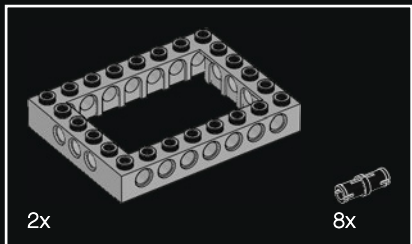
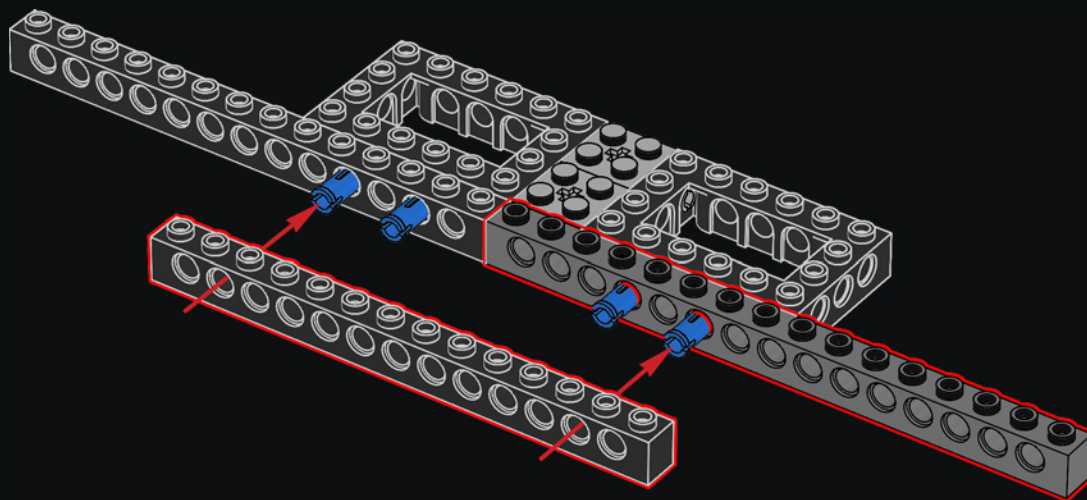

20

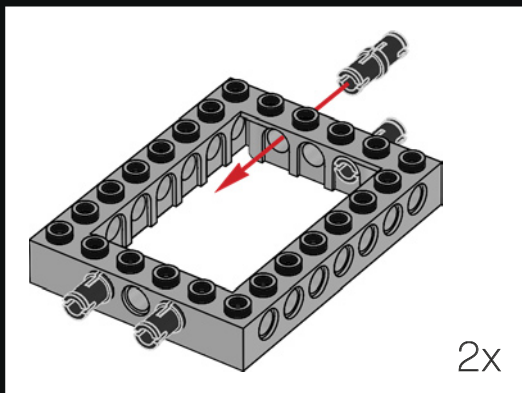
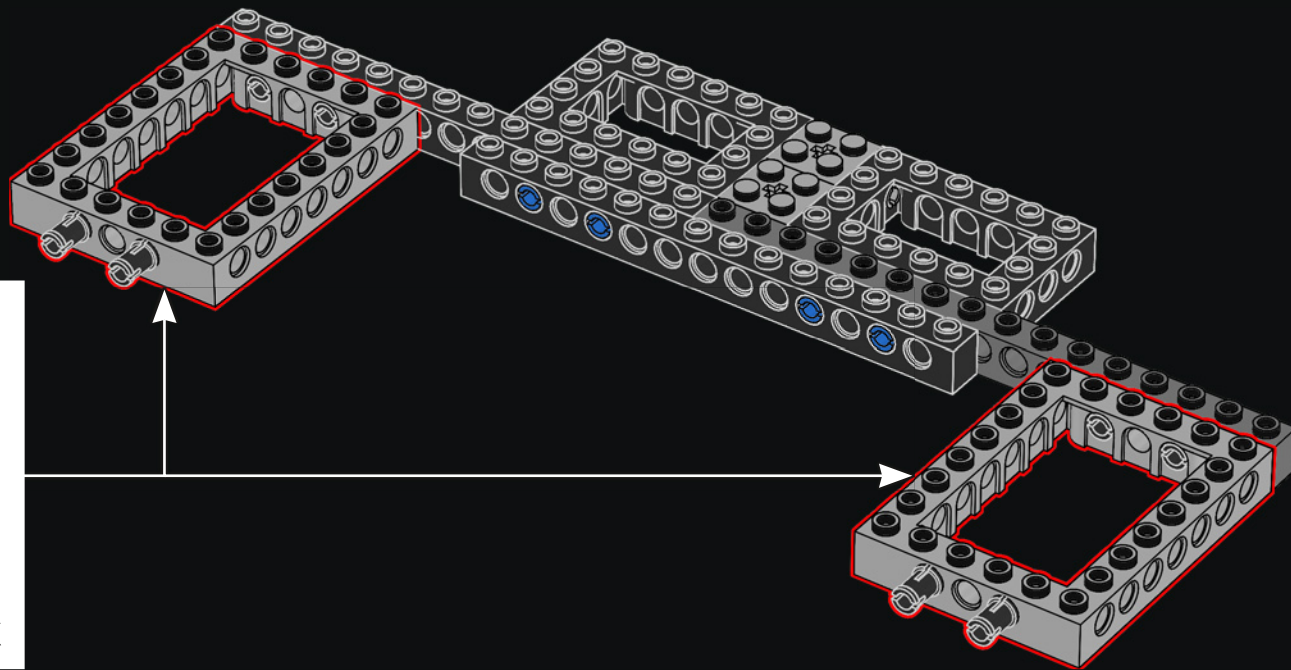

28

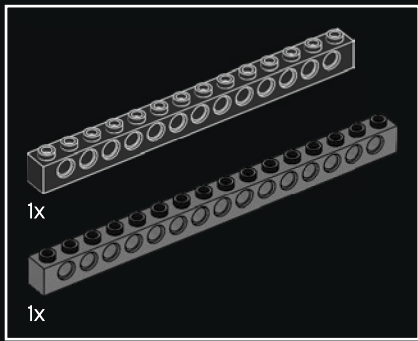

21

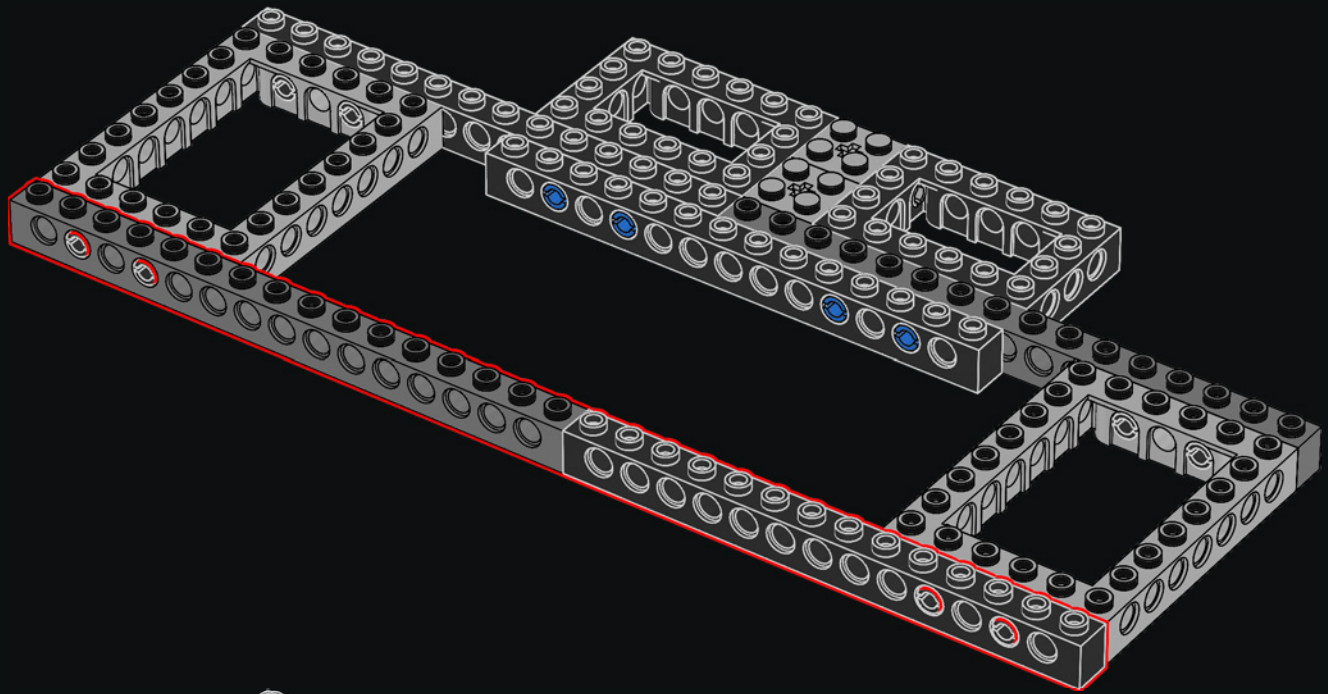

22

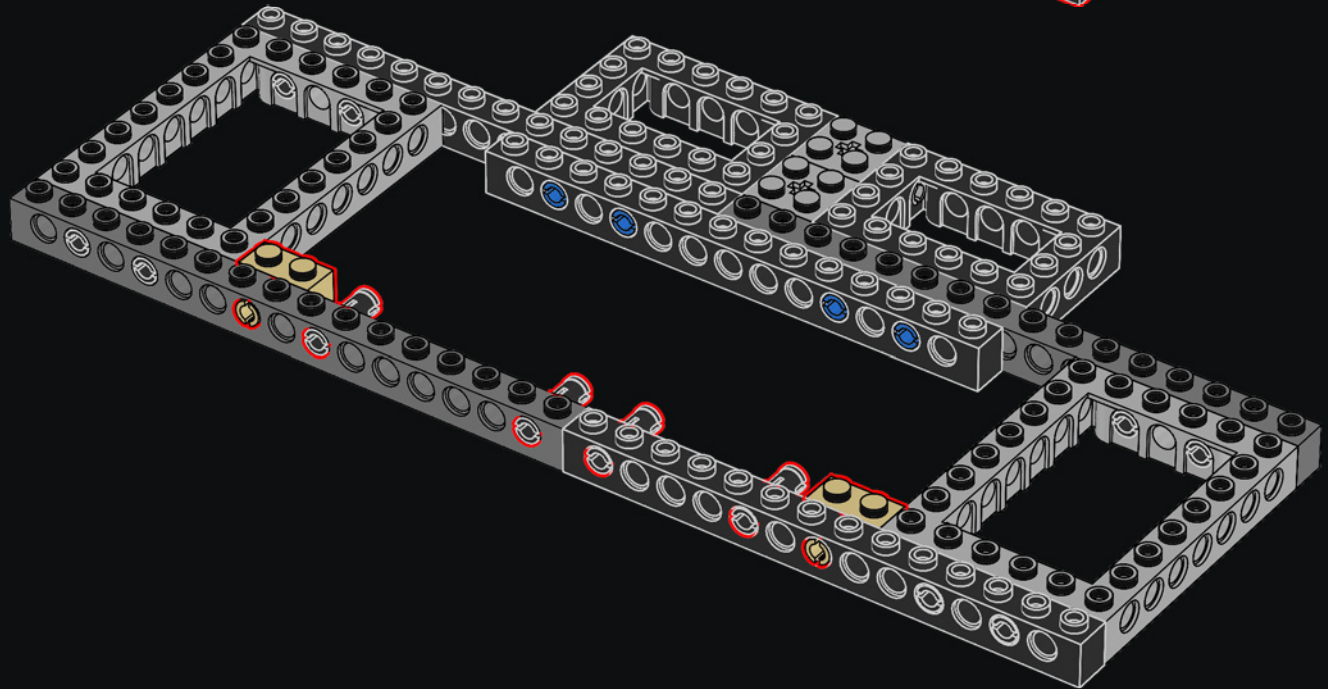

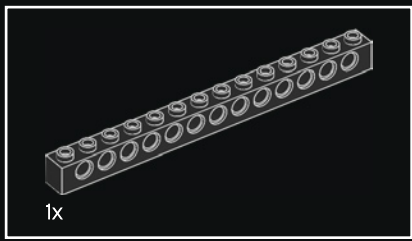

23

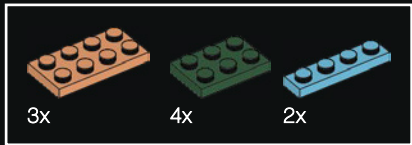
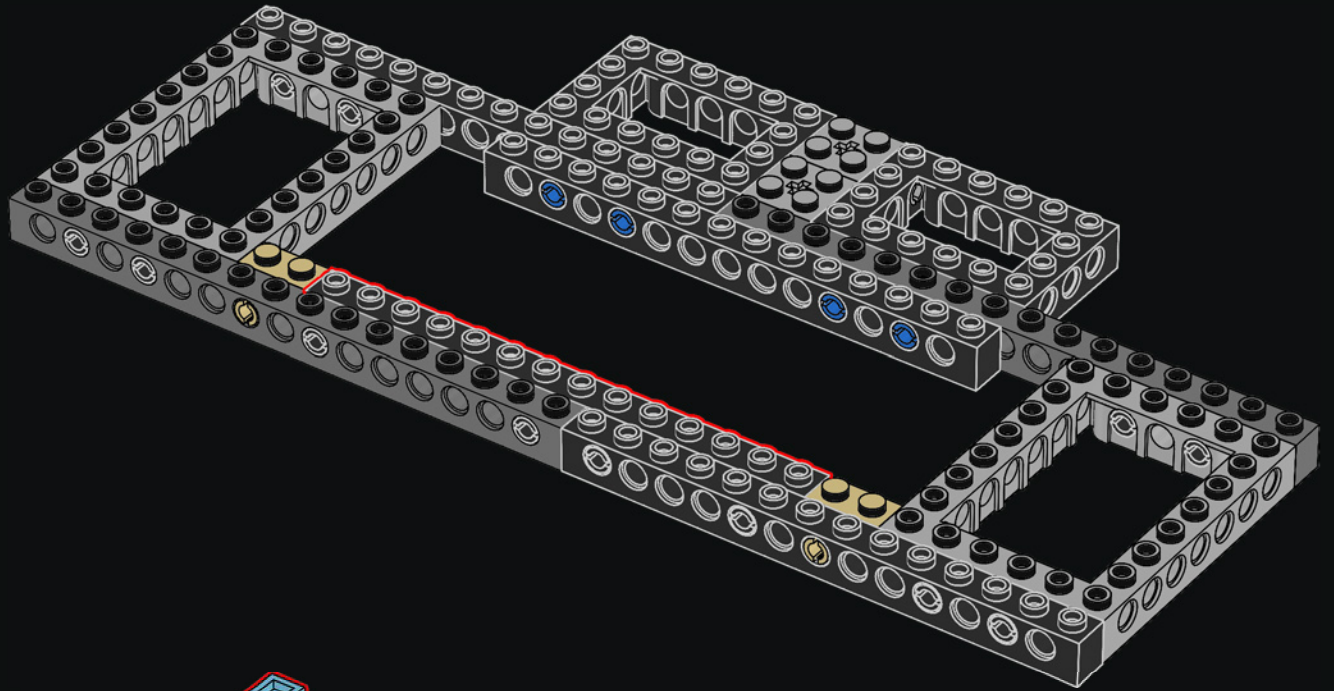

24

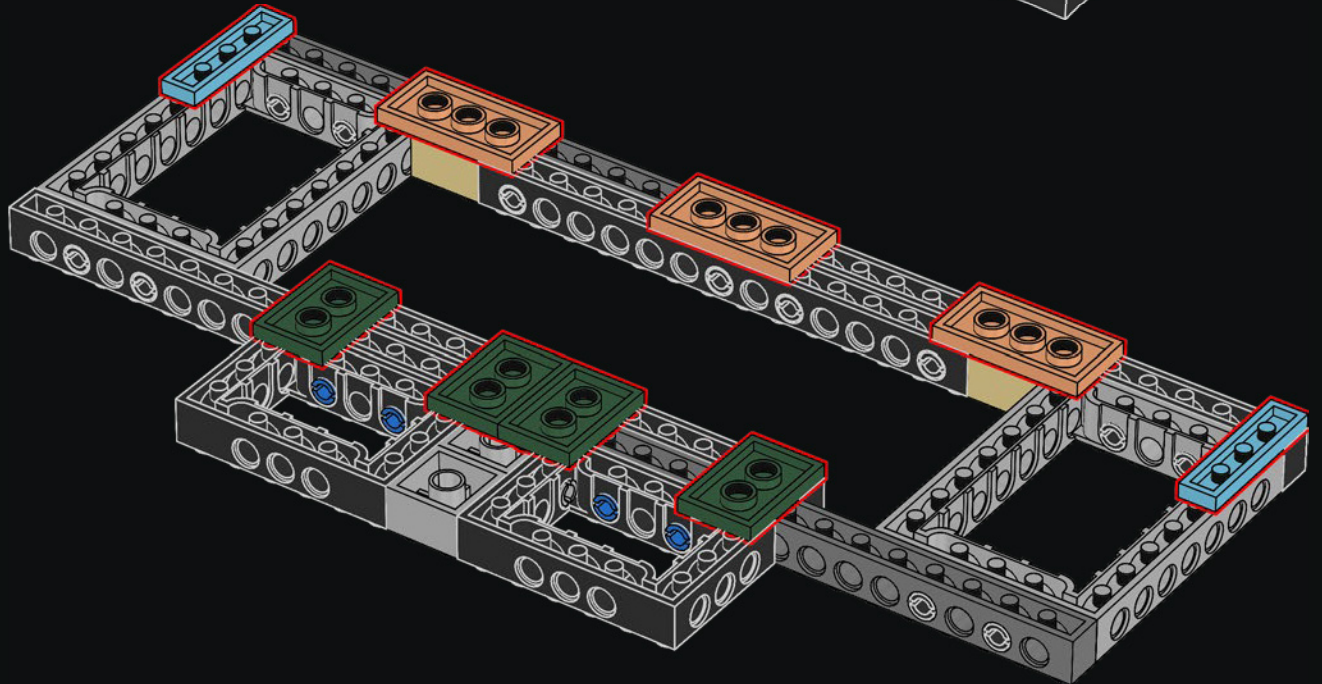

25

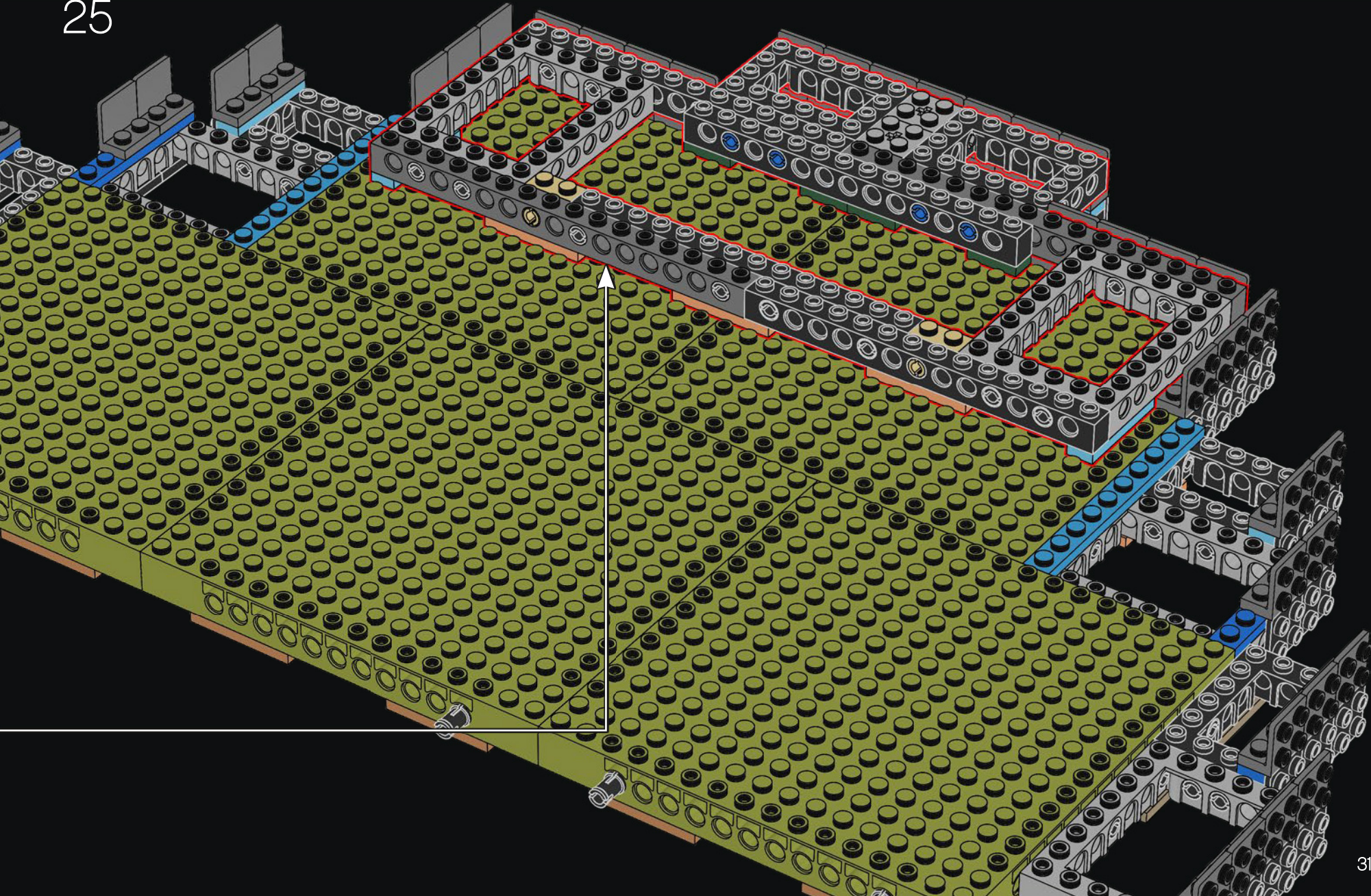

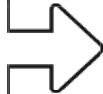

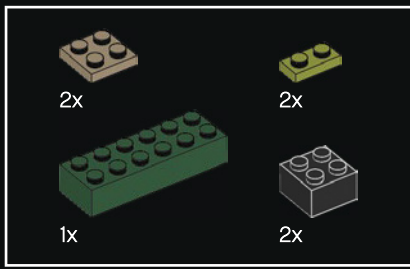

26

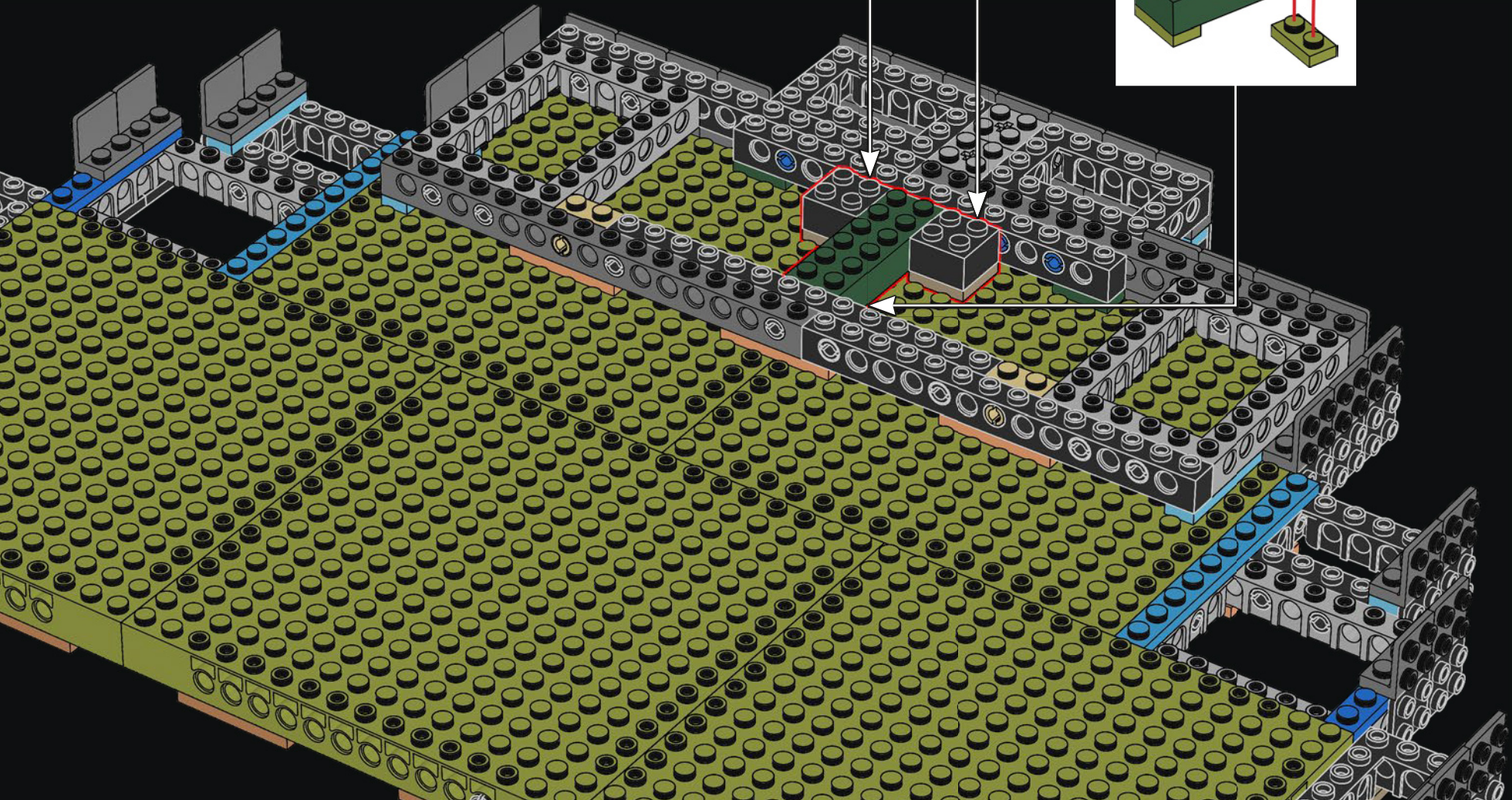
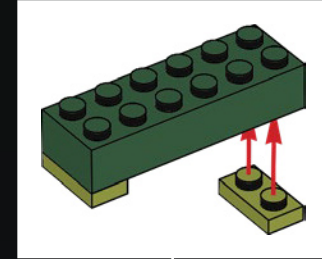
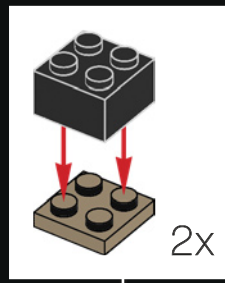

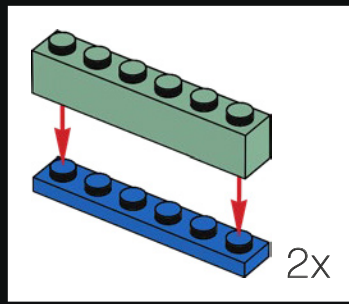
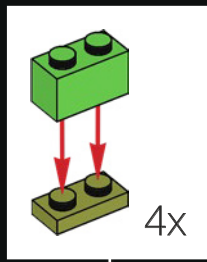
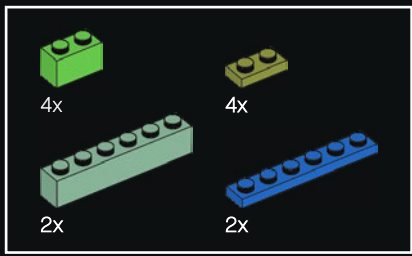

27

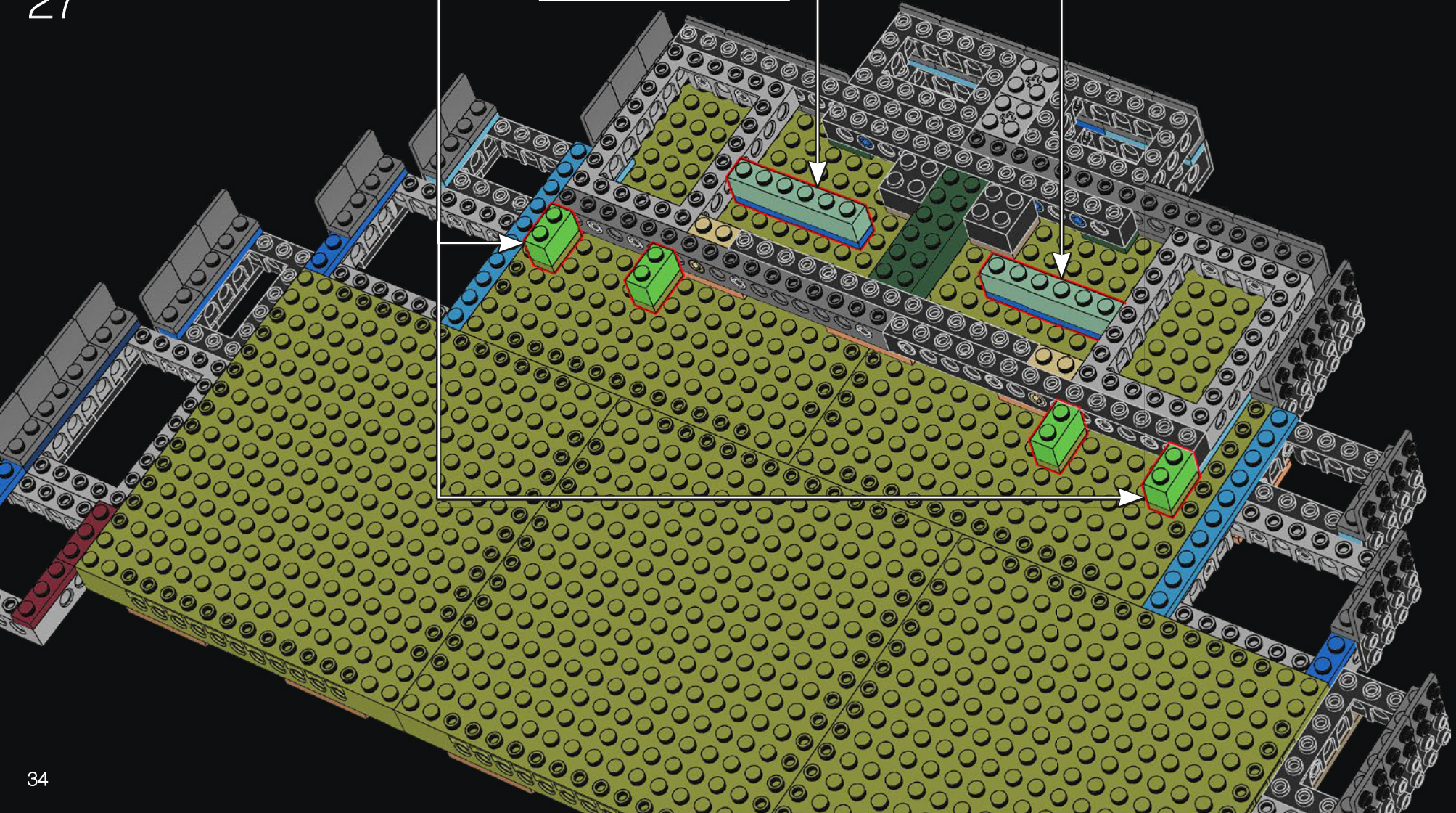

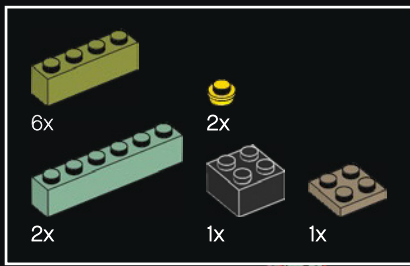

28

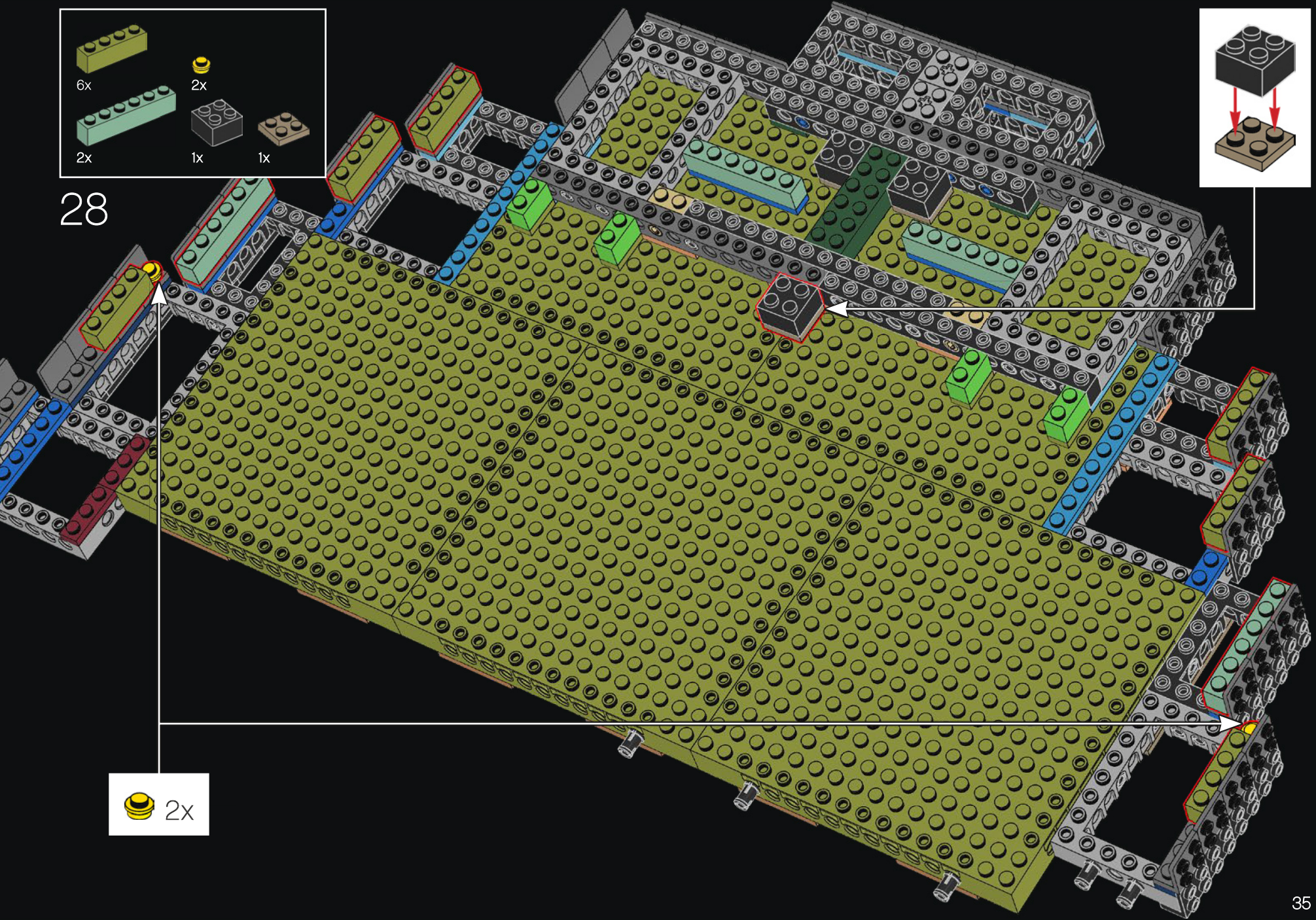
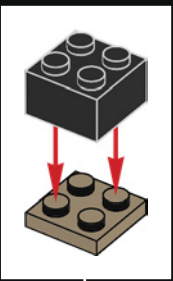

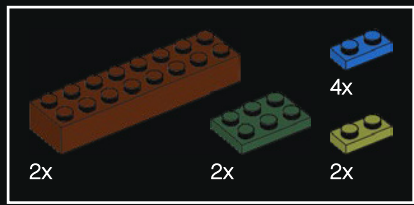

29

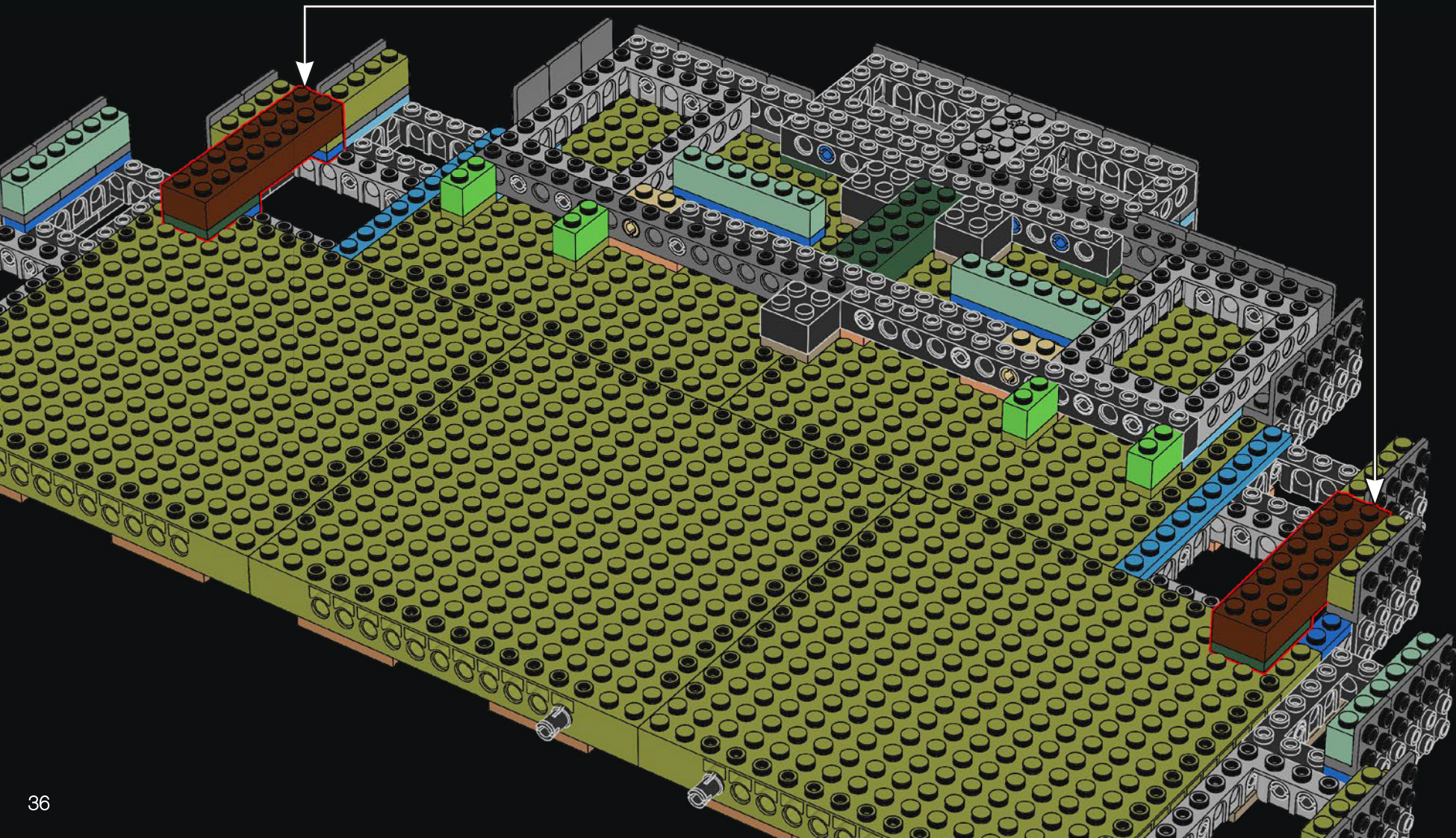
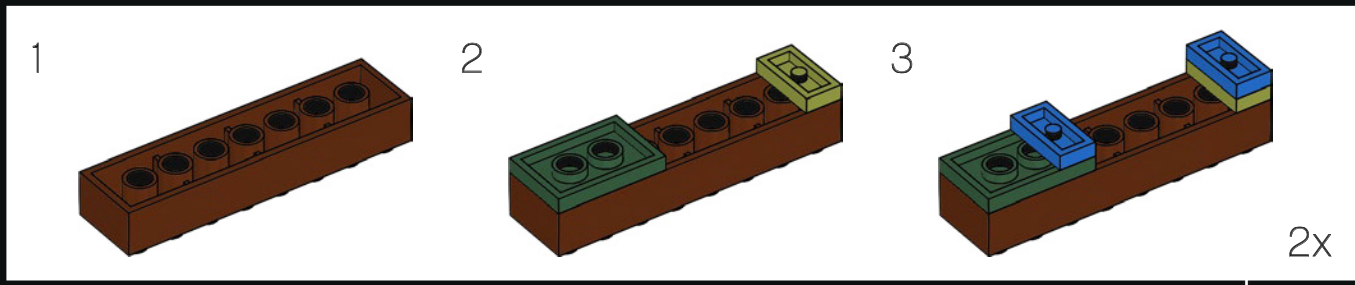

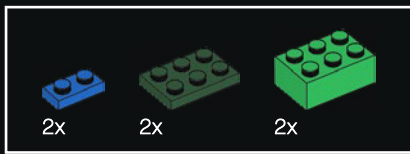

30

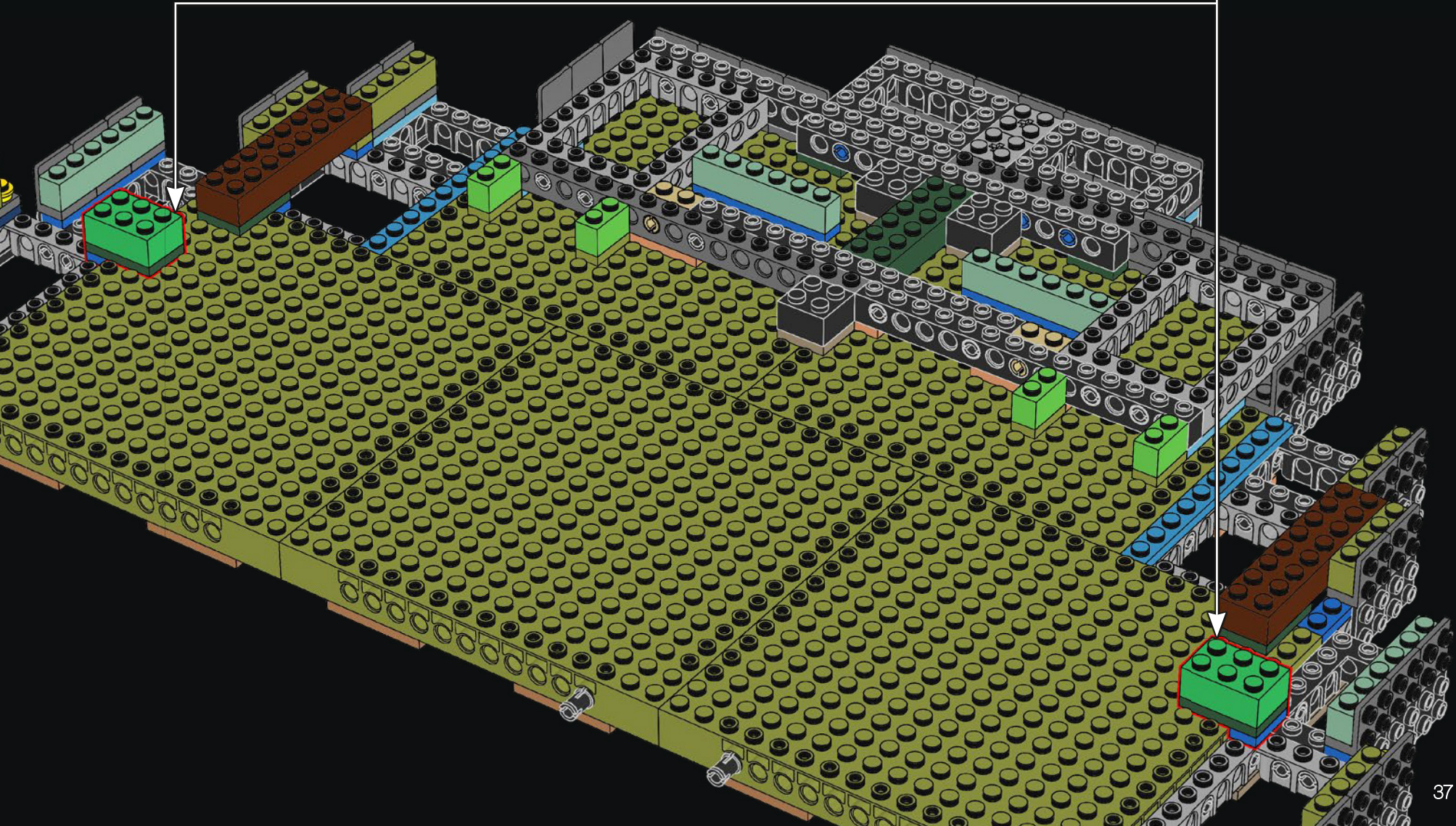
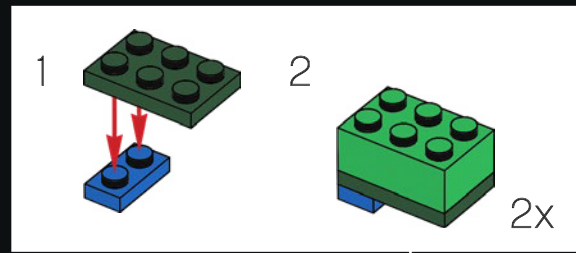

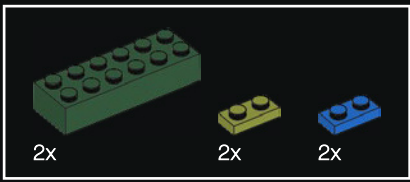

31

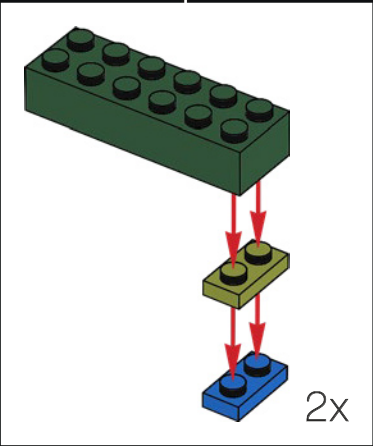
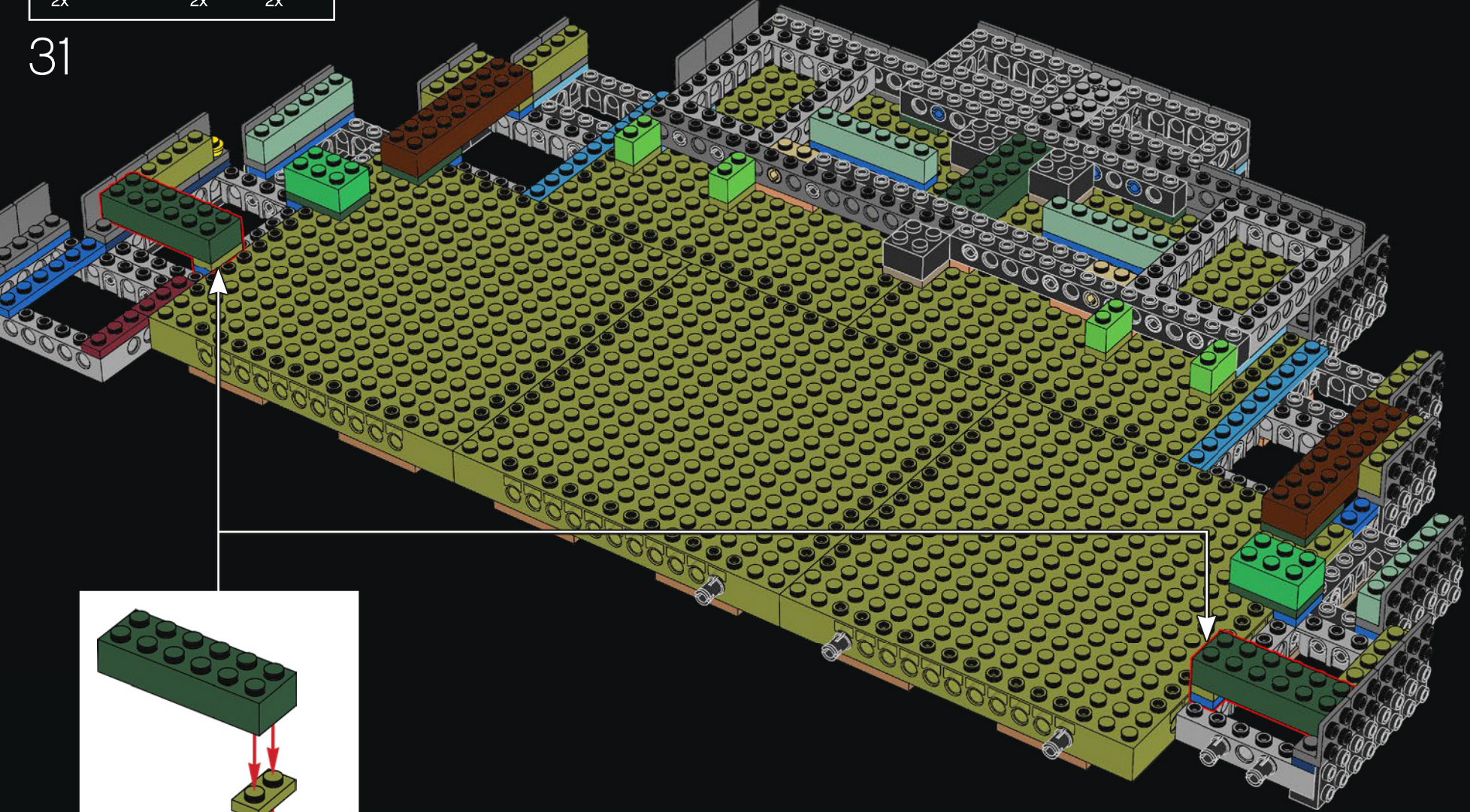

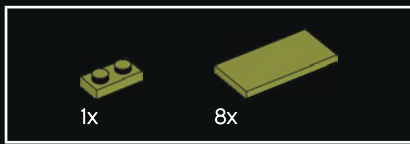

32



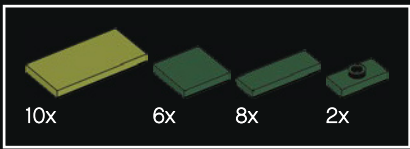

33

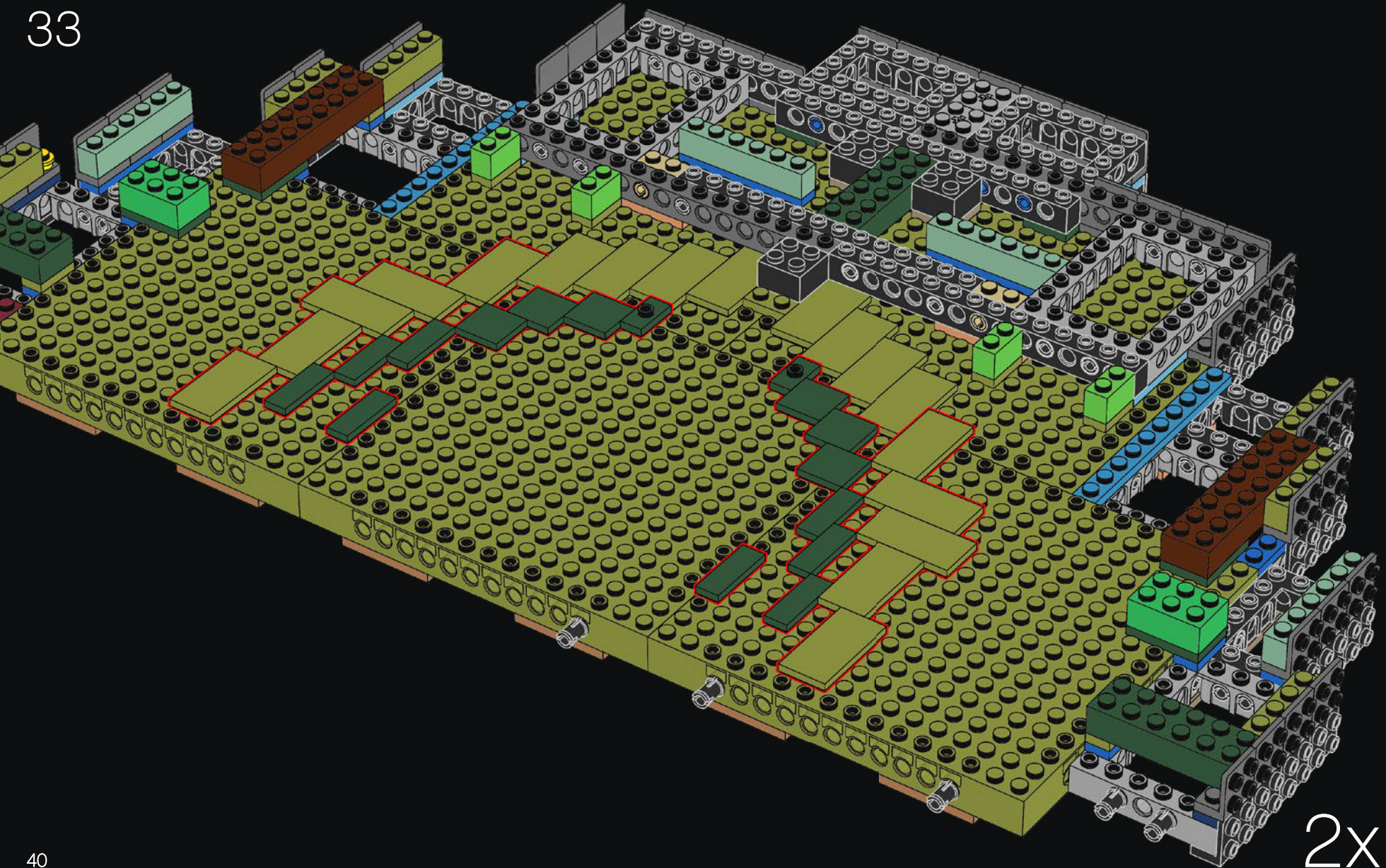

34

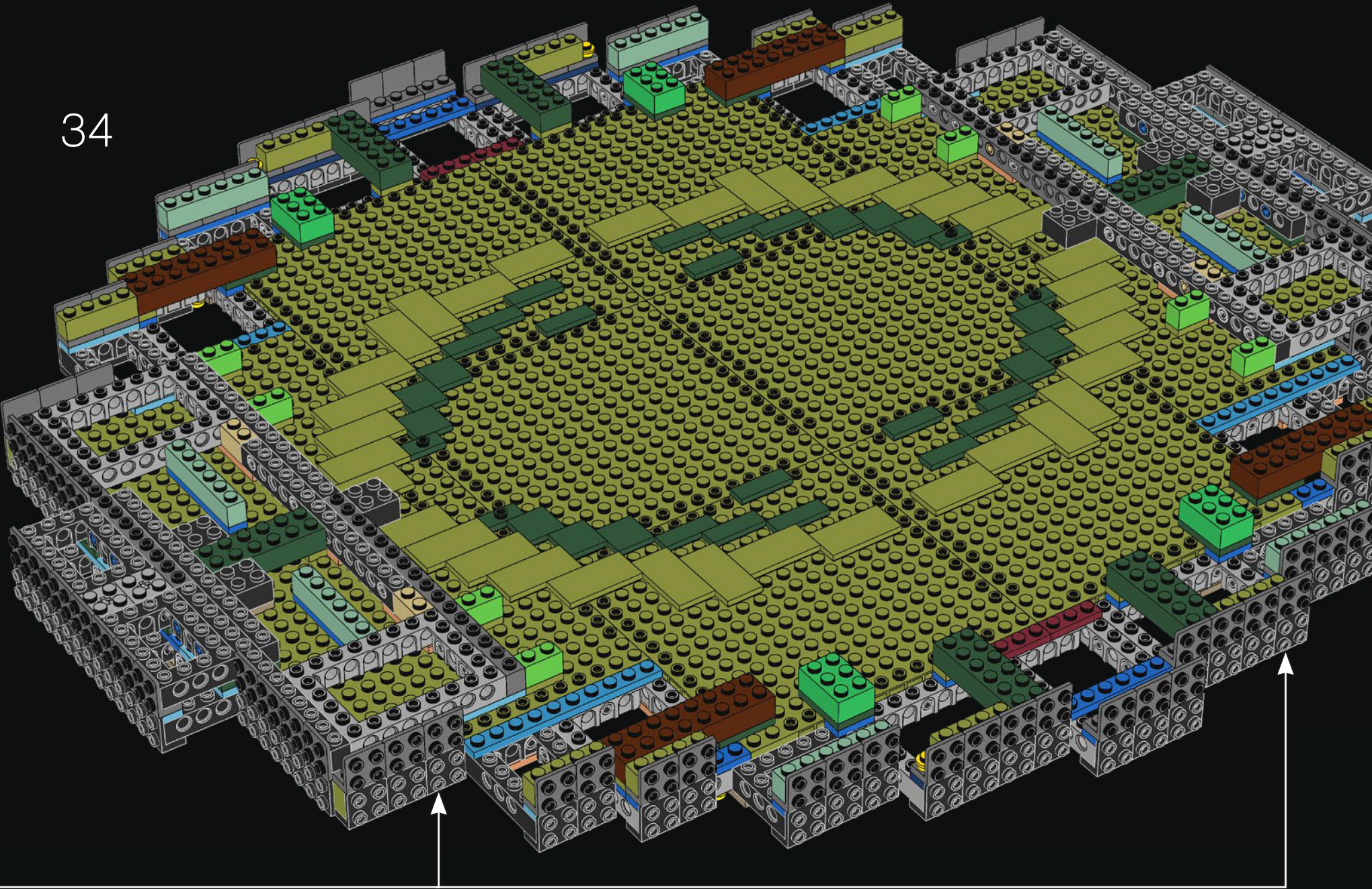

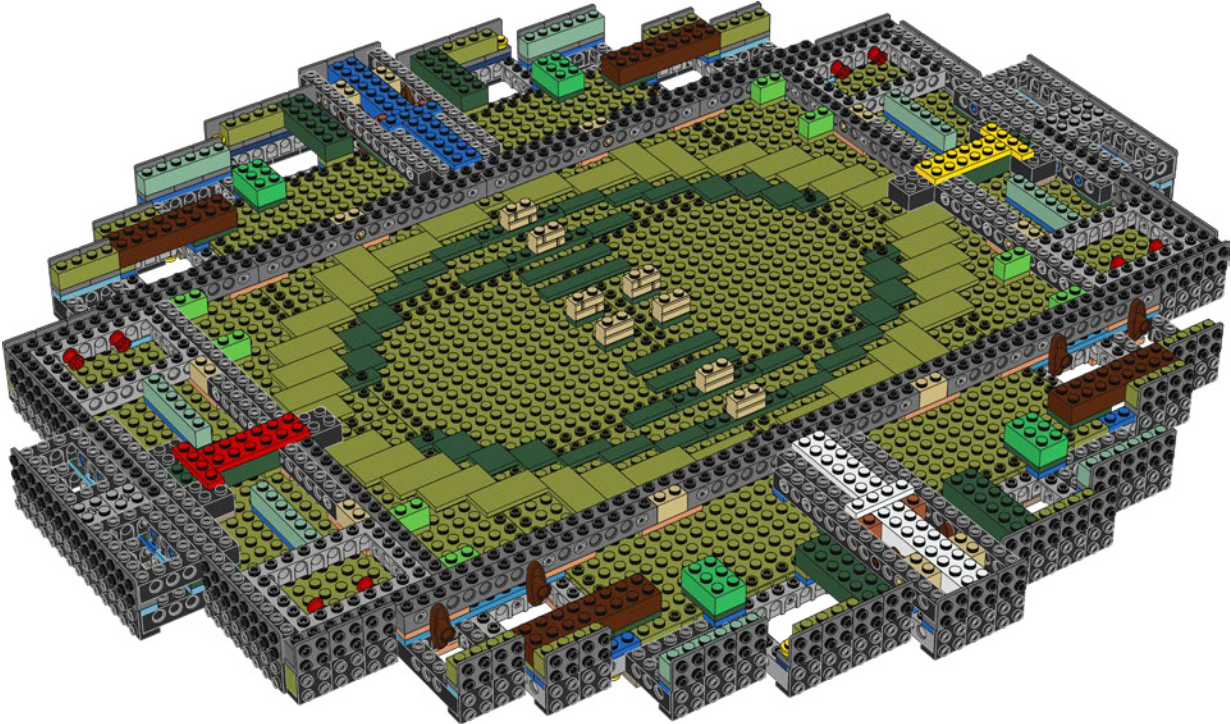
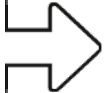

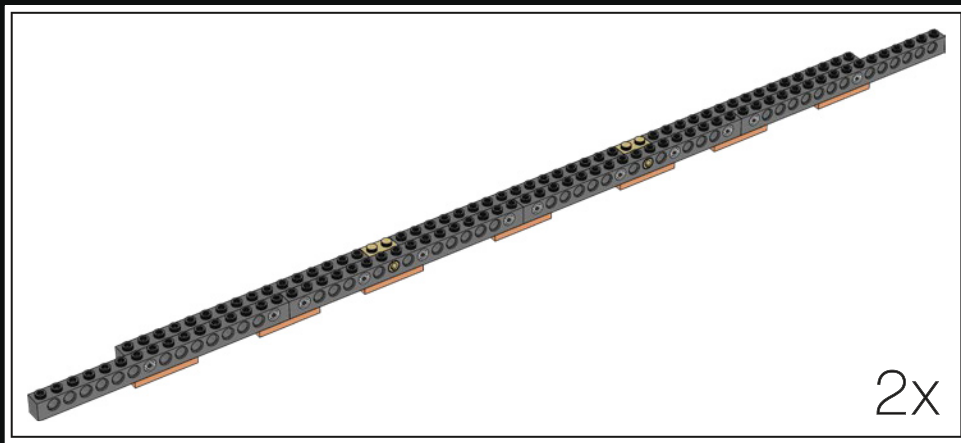

2x

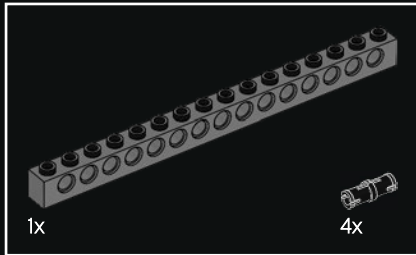

1x

4x

35

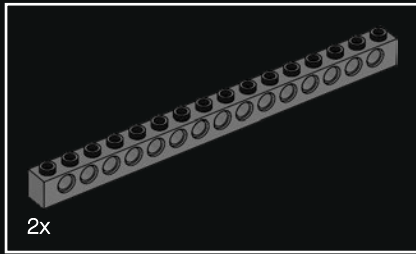
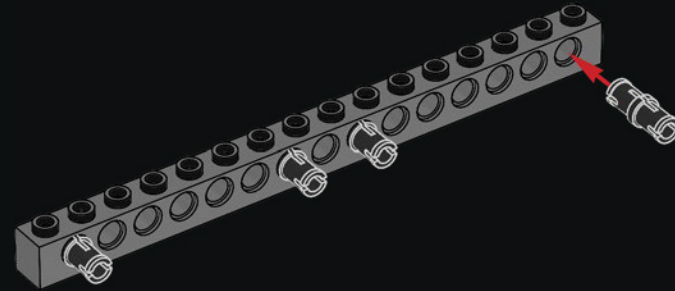

2x

36

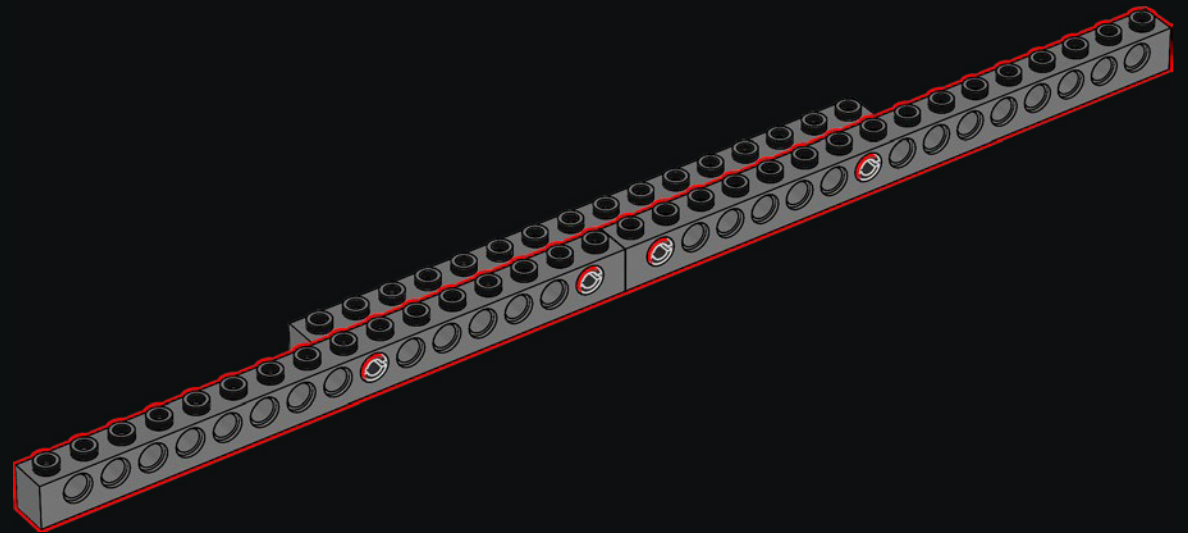



37

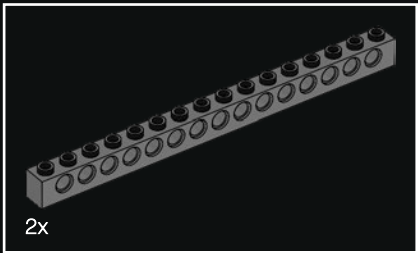
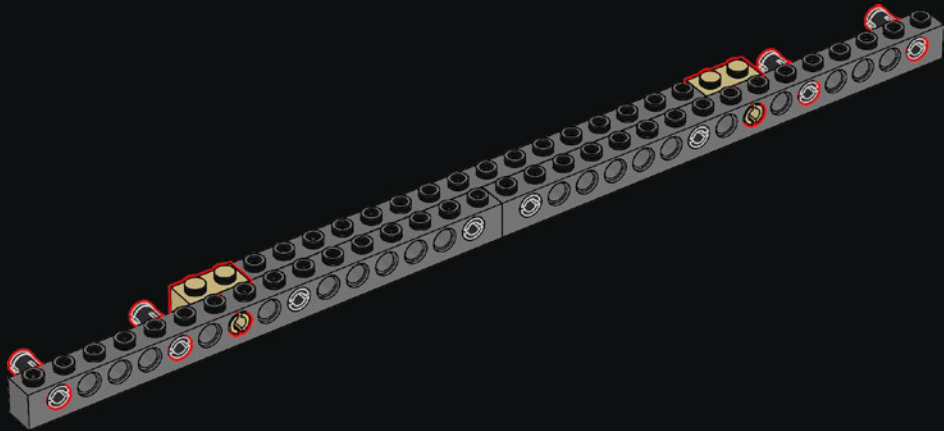

38

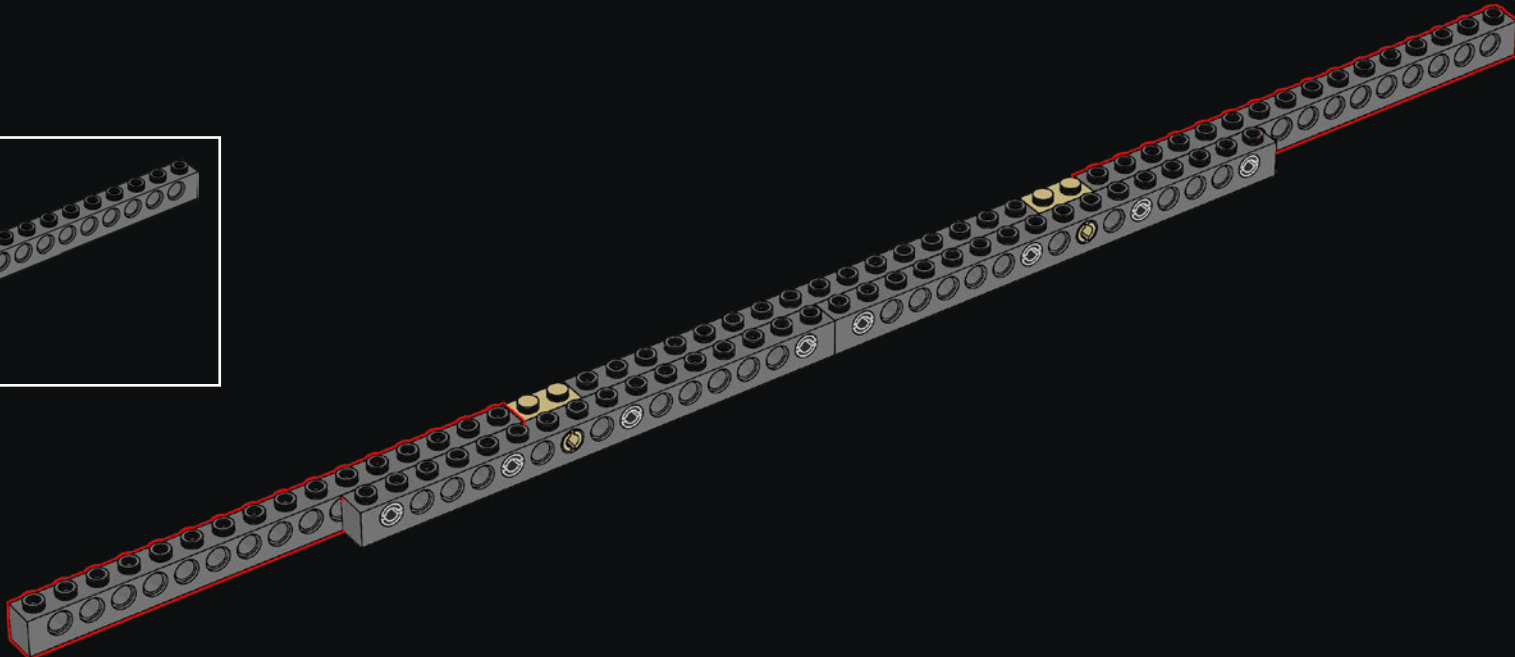



39

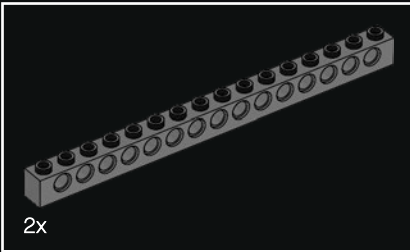
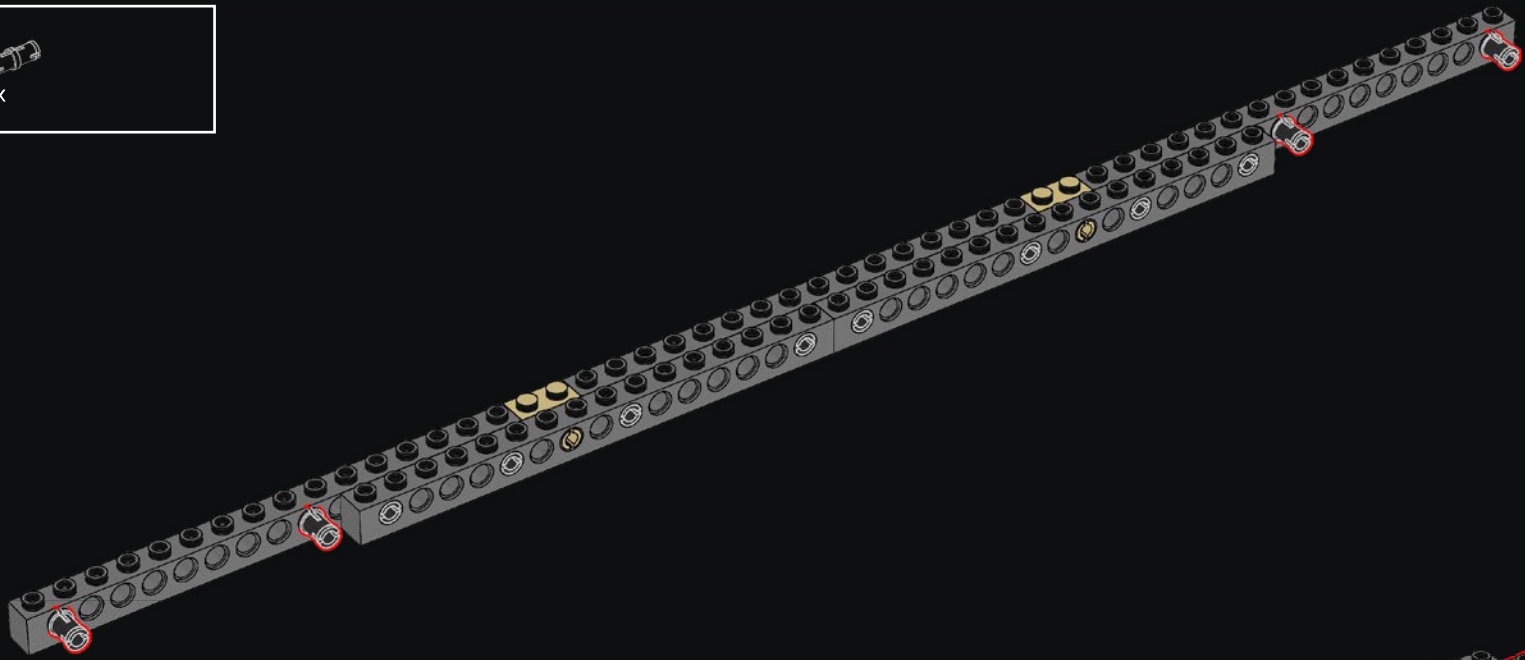

40



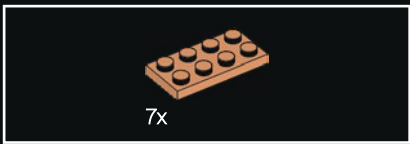

El Coliseo se conoce también como *Anfiteatro Flavio* en honor a los 3 emperadores de la dinastía flavia que lo construyeron y reformaron.

41

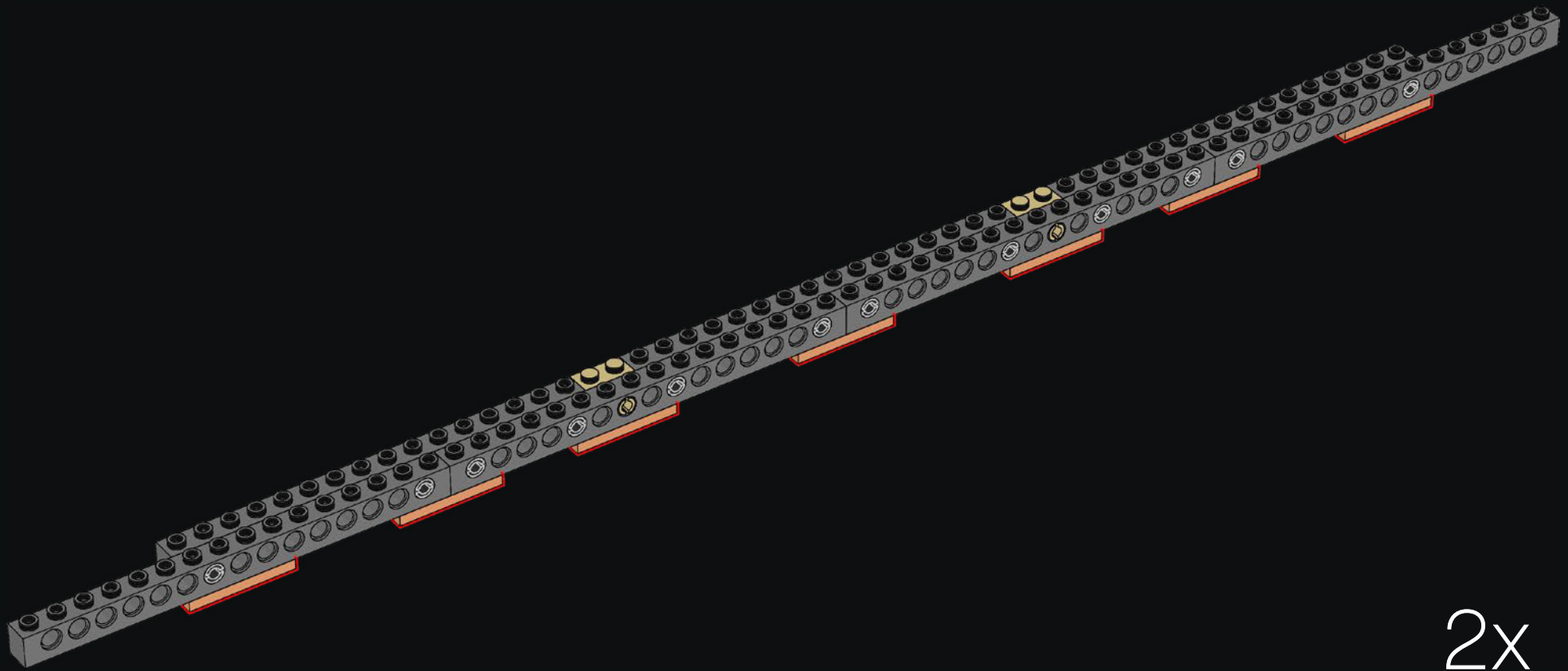

2x

42

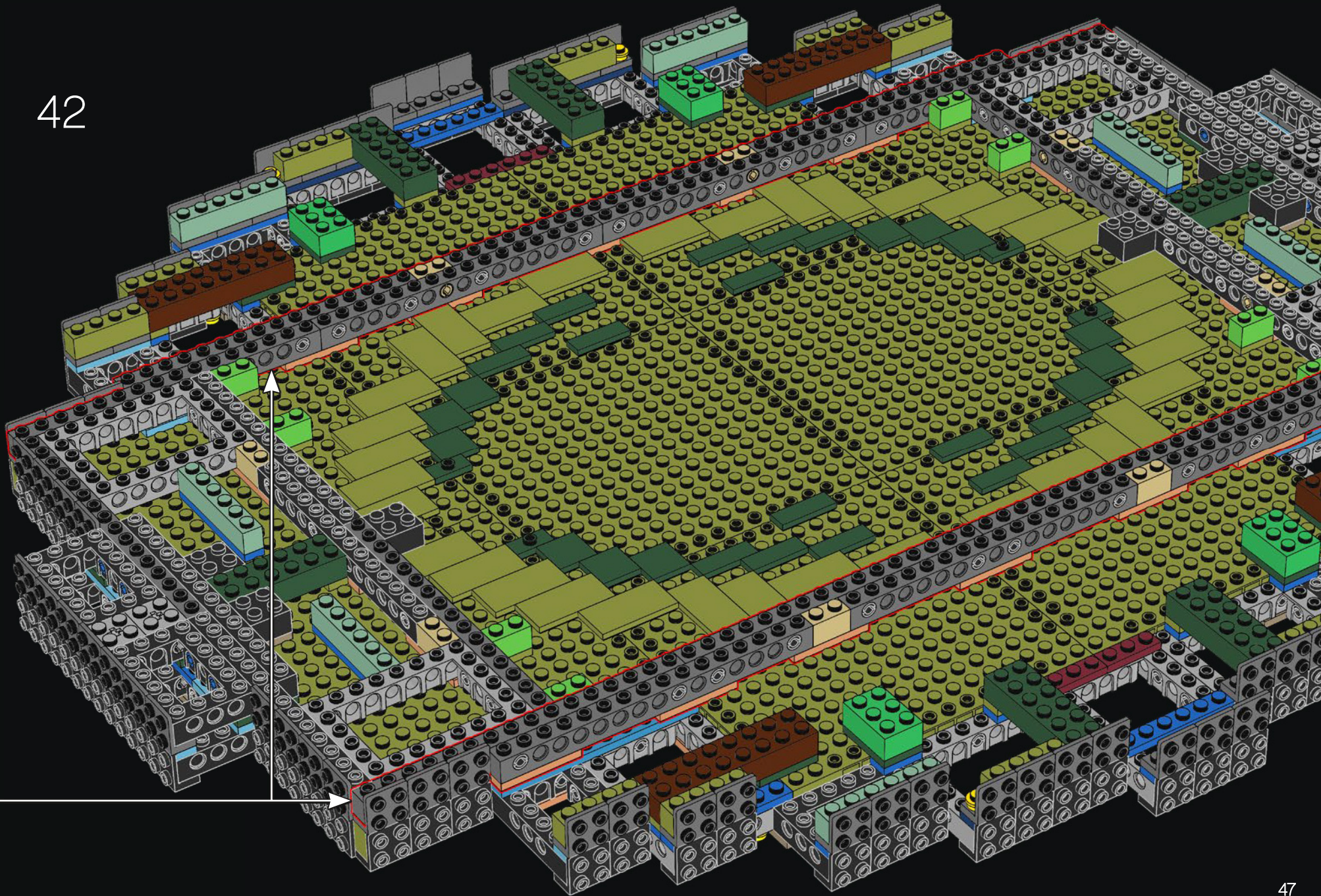



43





44



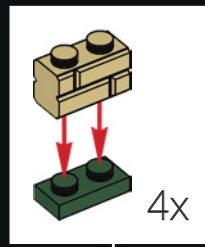
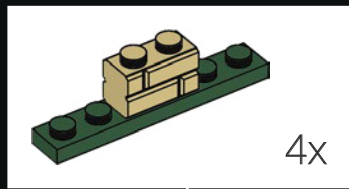
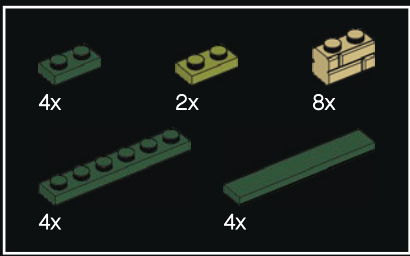

45

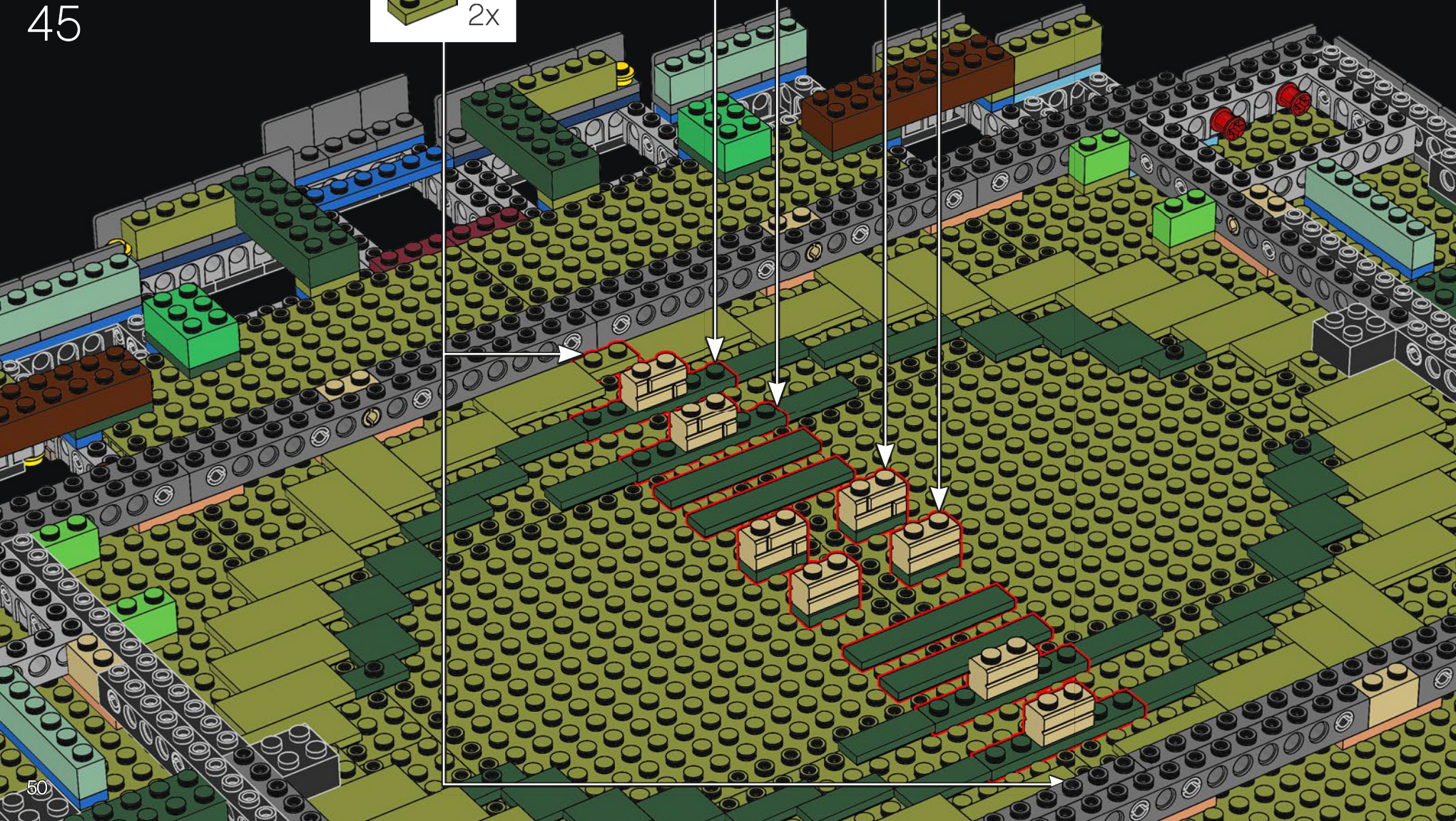

50

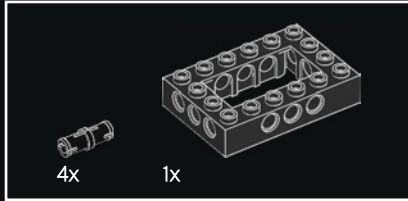
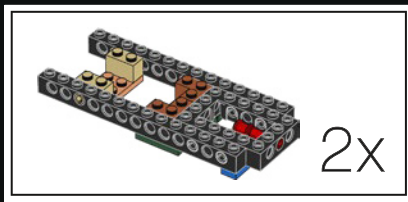

46

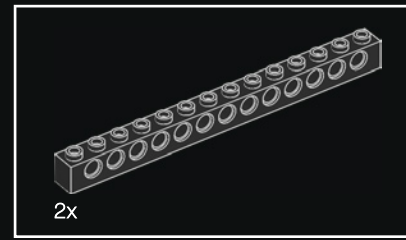
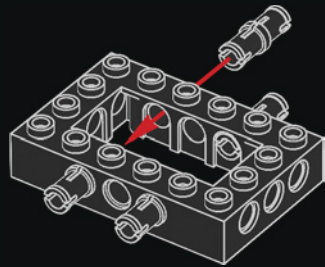

47

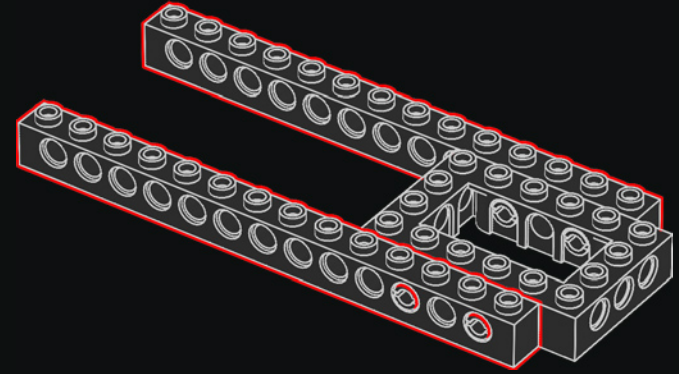

48

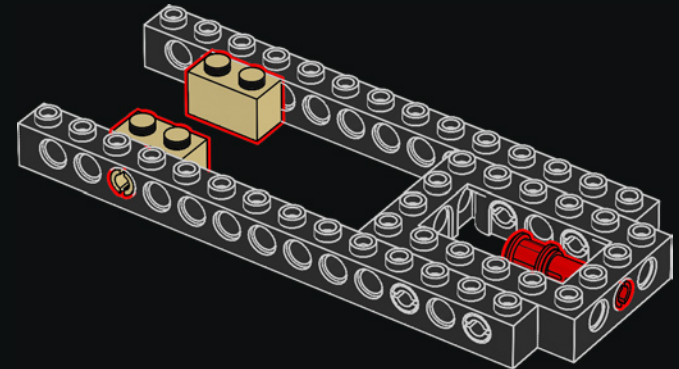

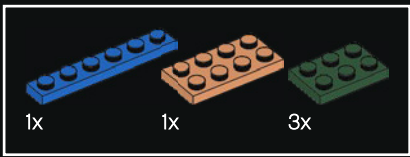

49

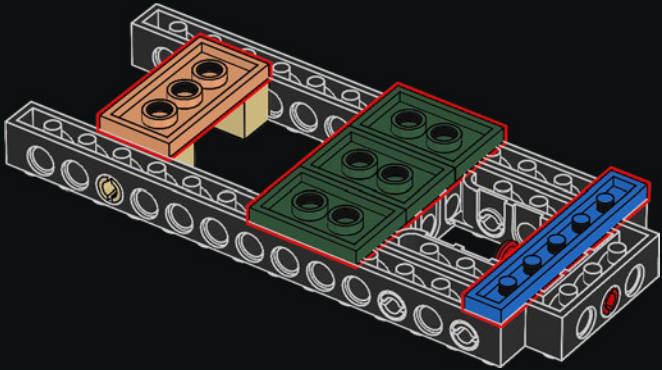

50

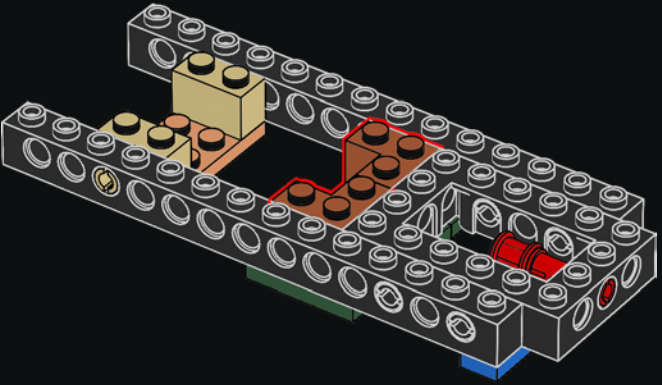

2x

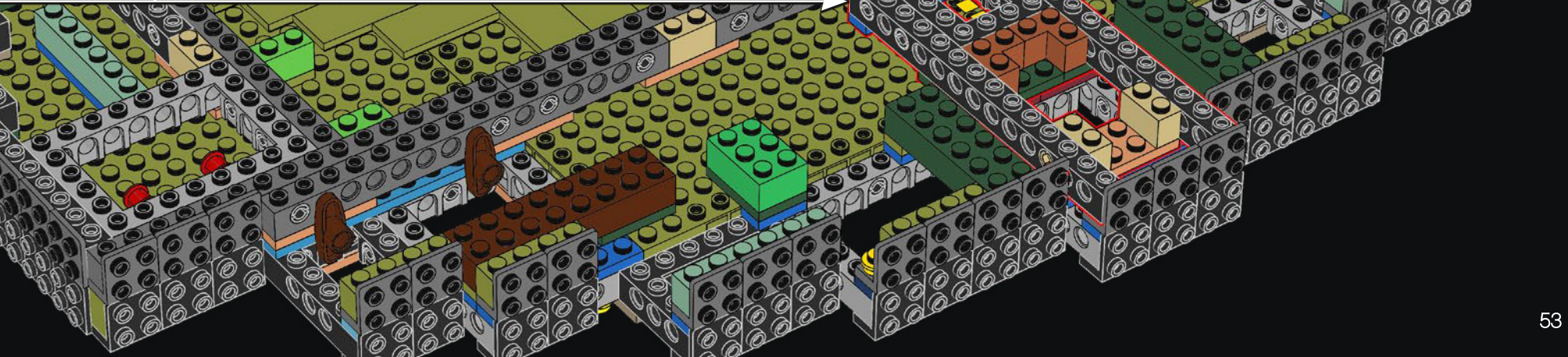
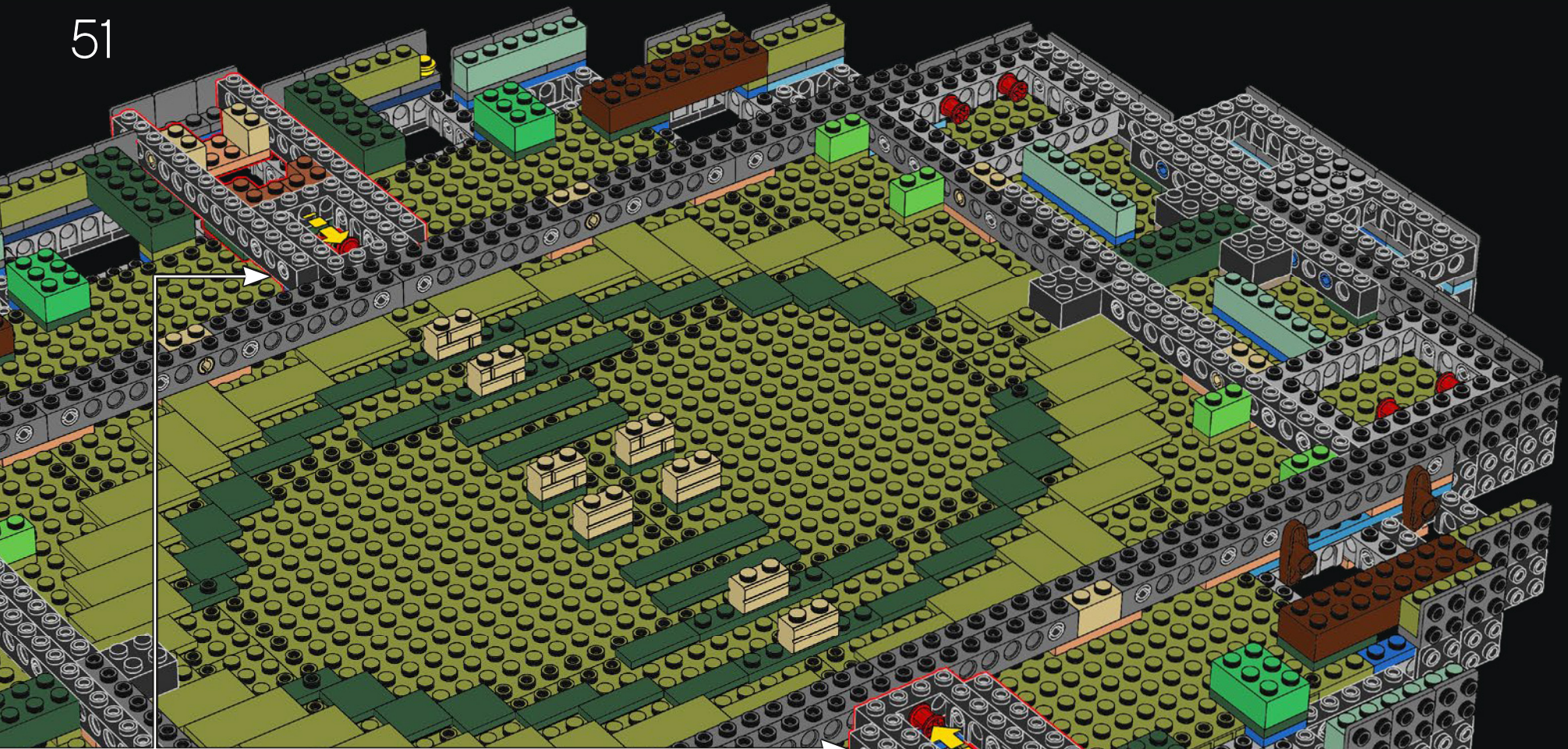



52

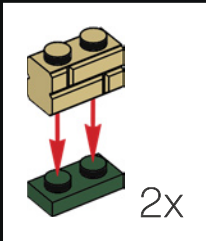

54

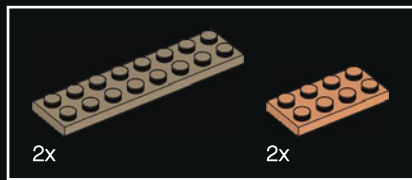

53

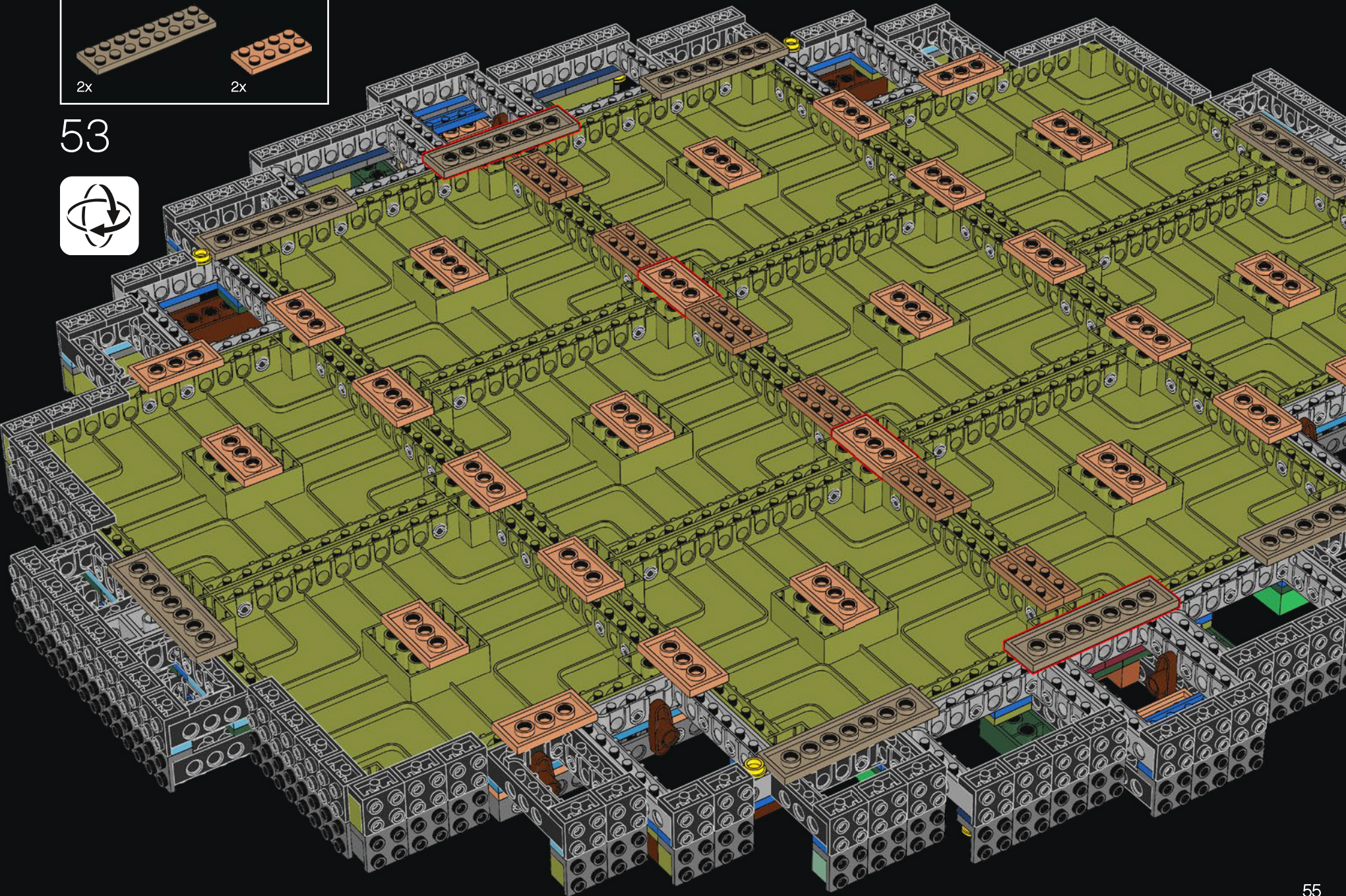

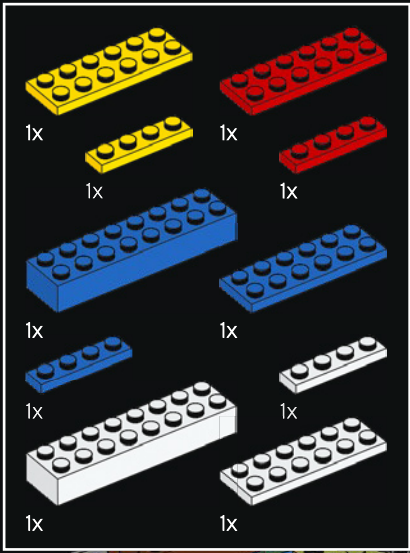

54



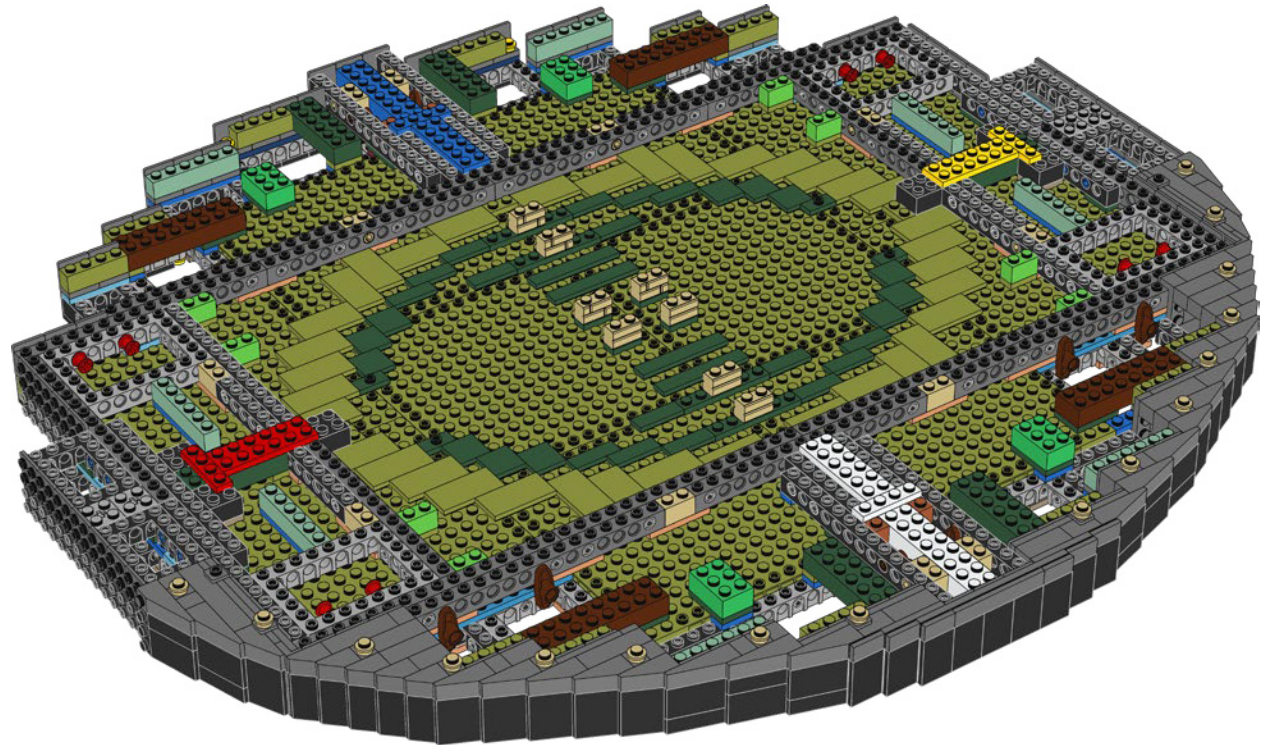
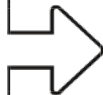

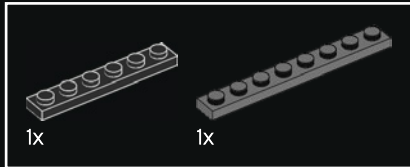
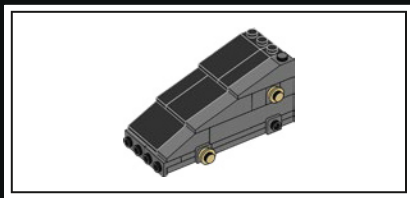

55

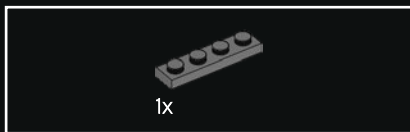
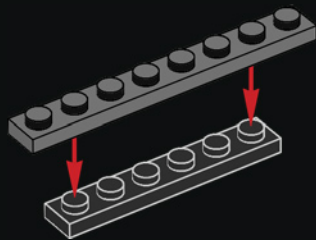

56

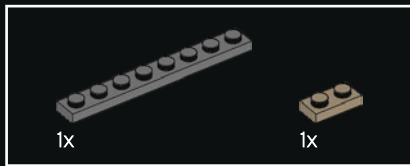
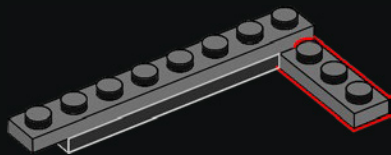

57

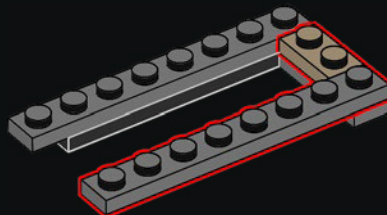

58

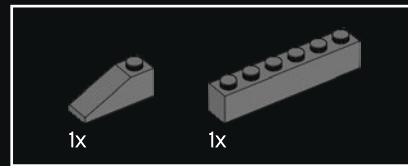
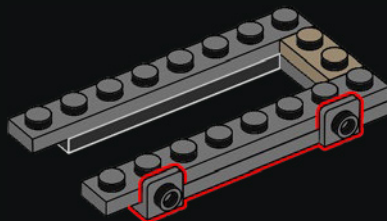

59

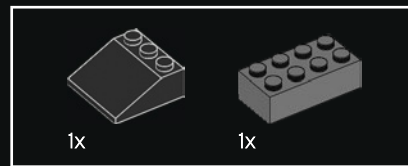
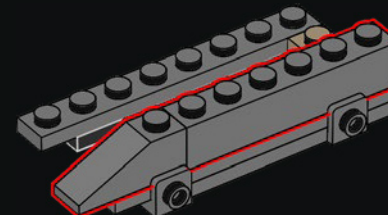

60

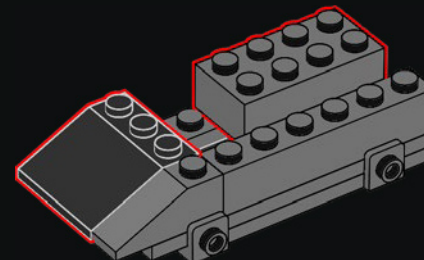

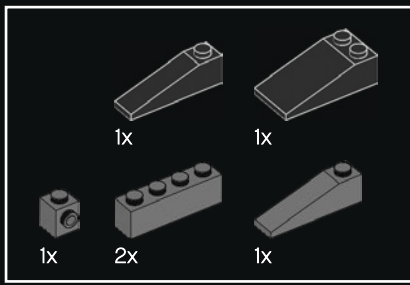

61

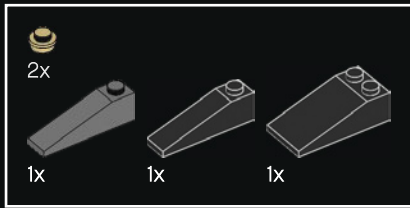
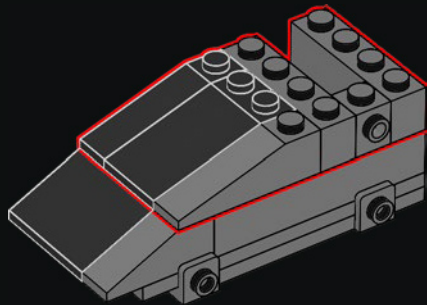

62

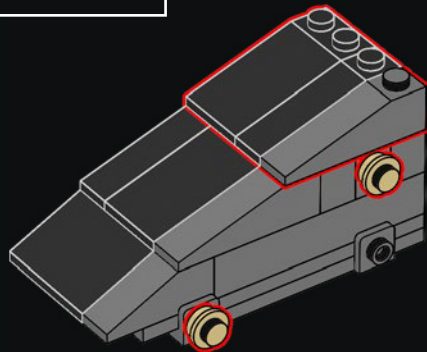

63

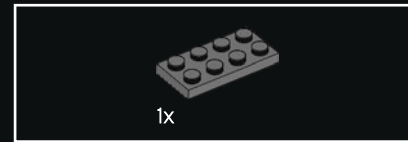
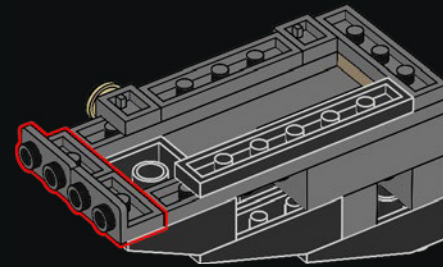

64

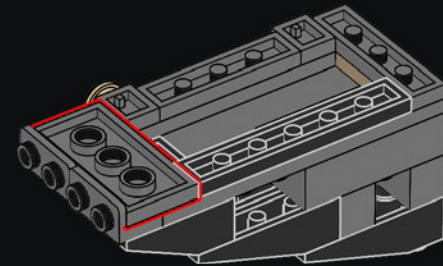

65

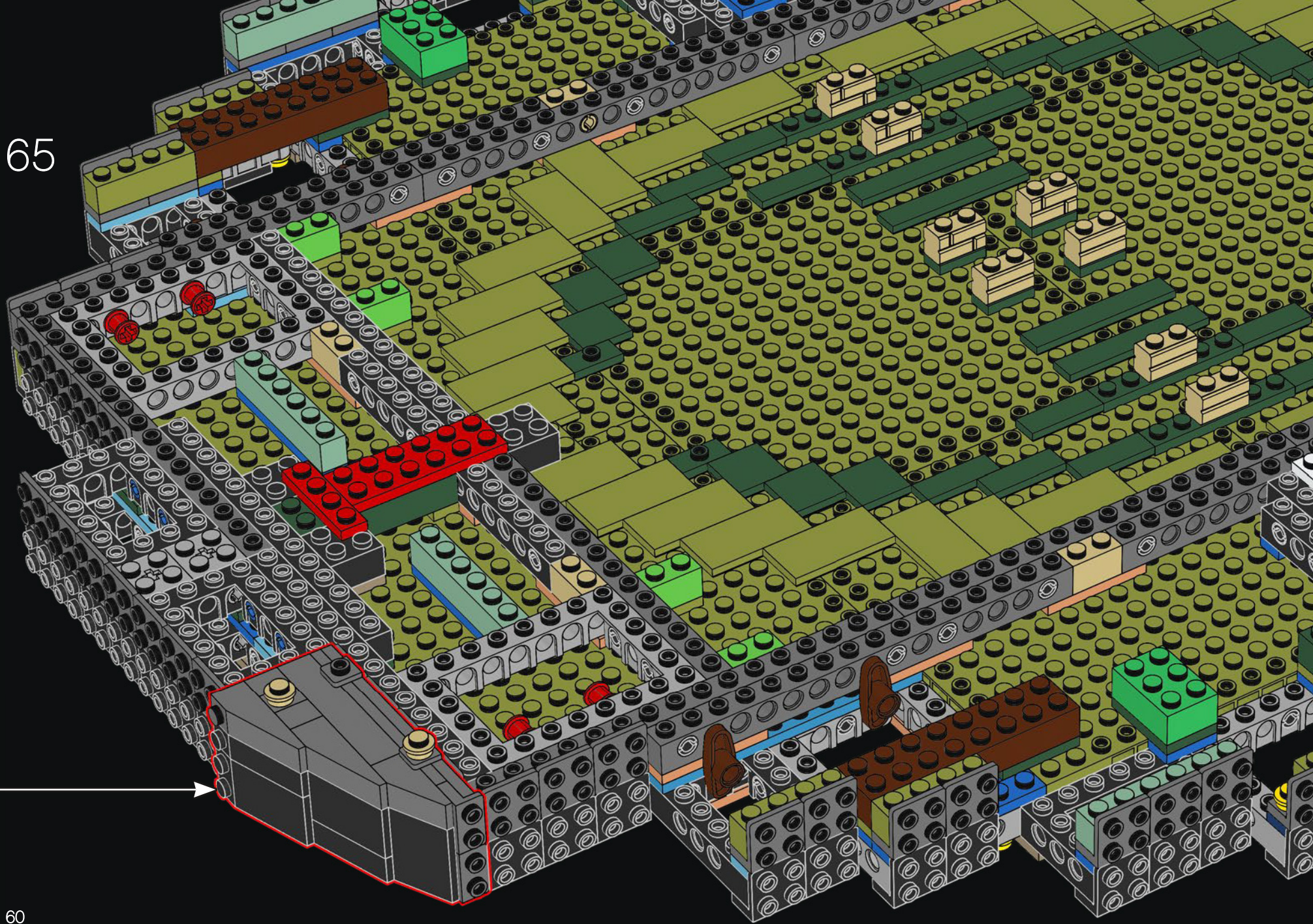

60

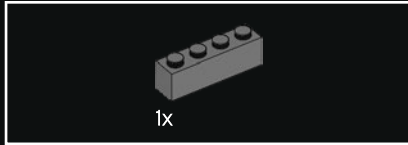
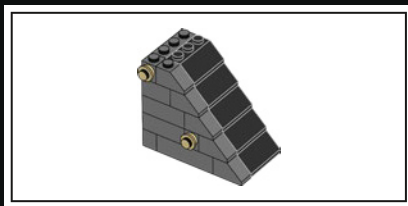

1x

66

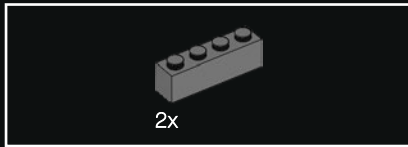

2x

67

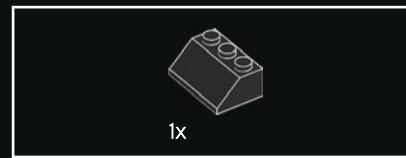
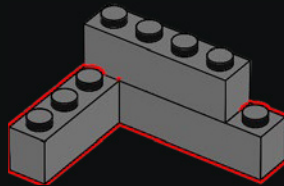

1x

68

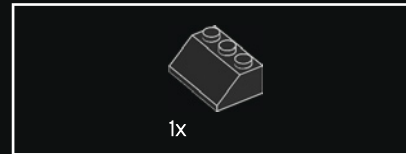
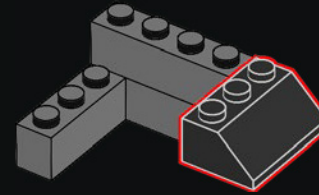

1x

69

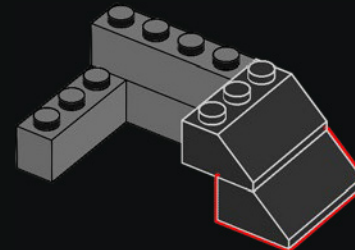

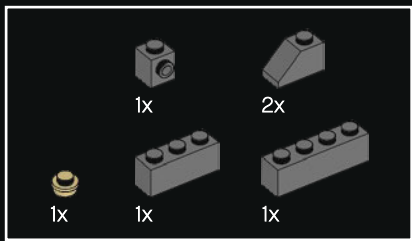

70

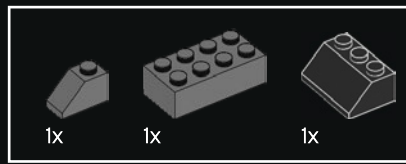
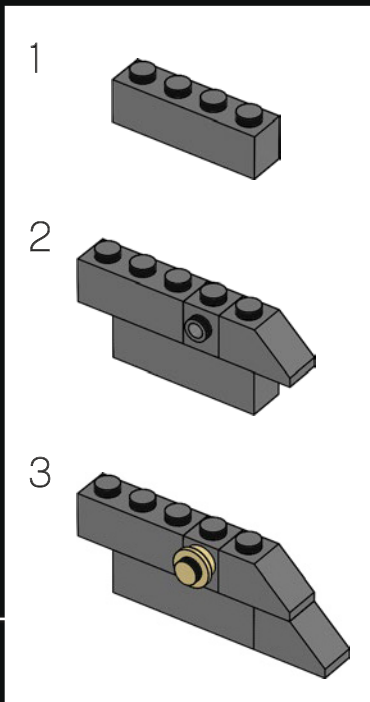
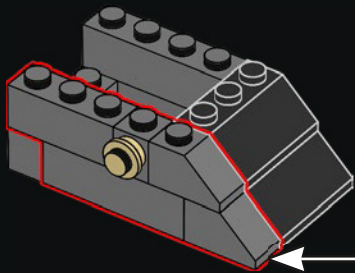

72

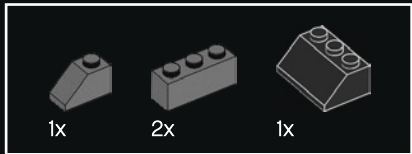
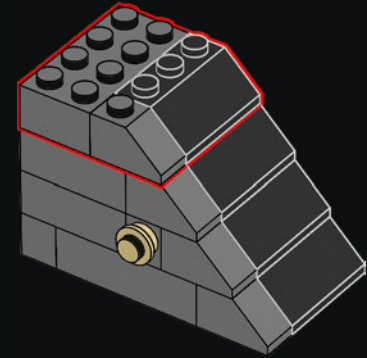

71

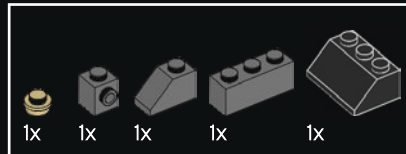
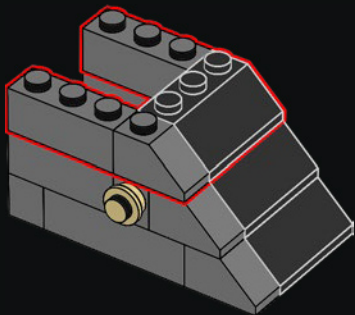

73

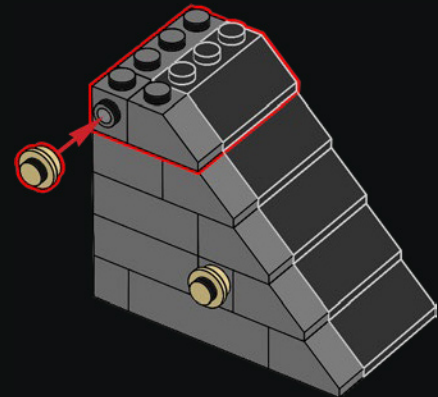

74

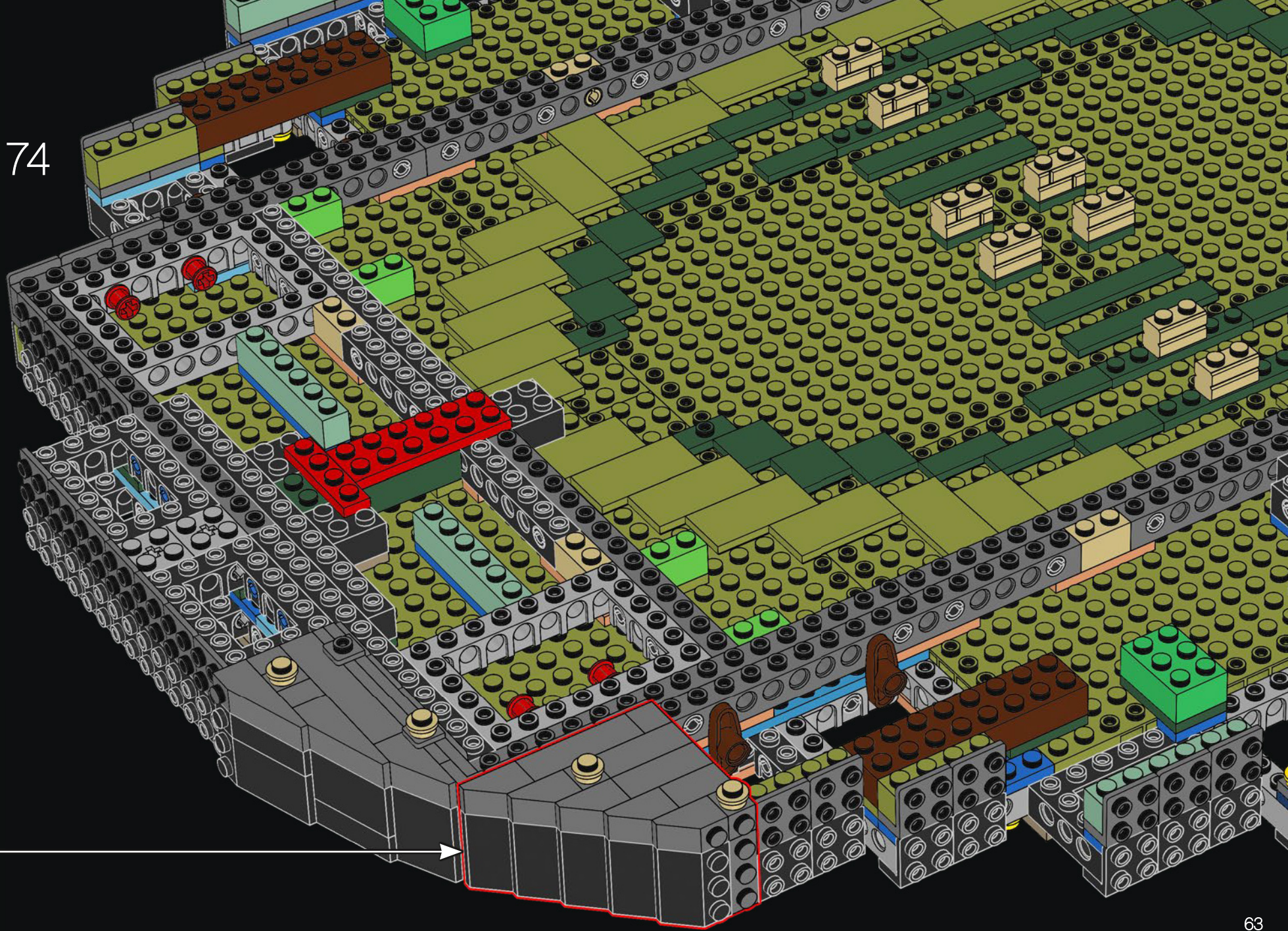

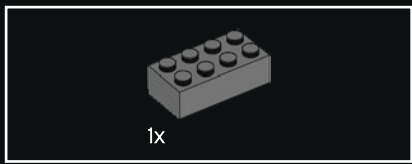

75

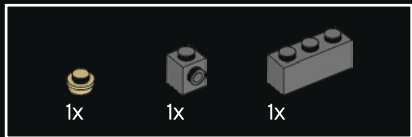
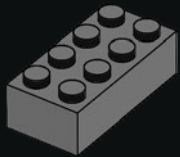

76

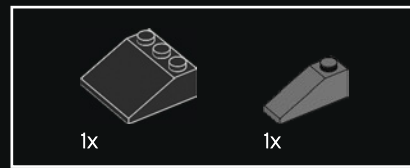
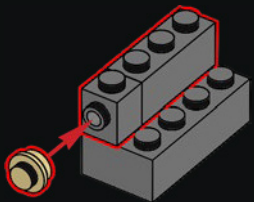

77

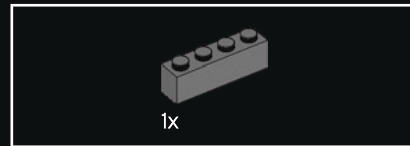
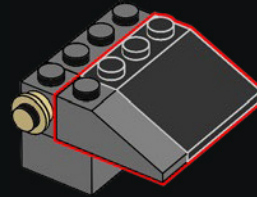

78

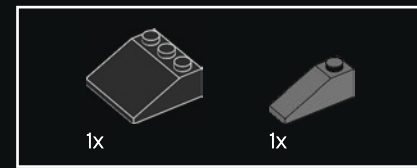
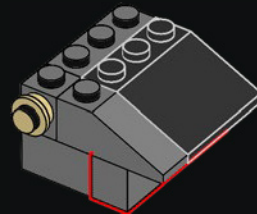

79

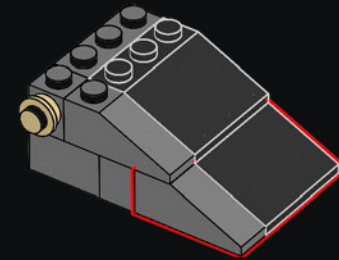

80

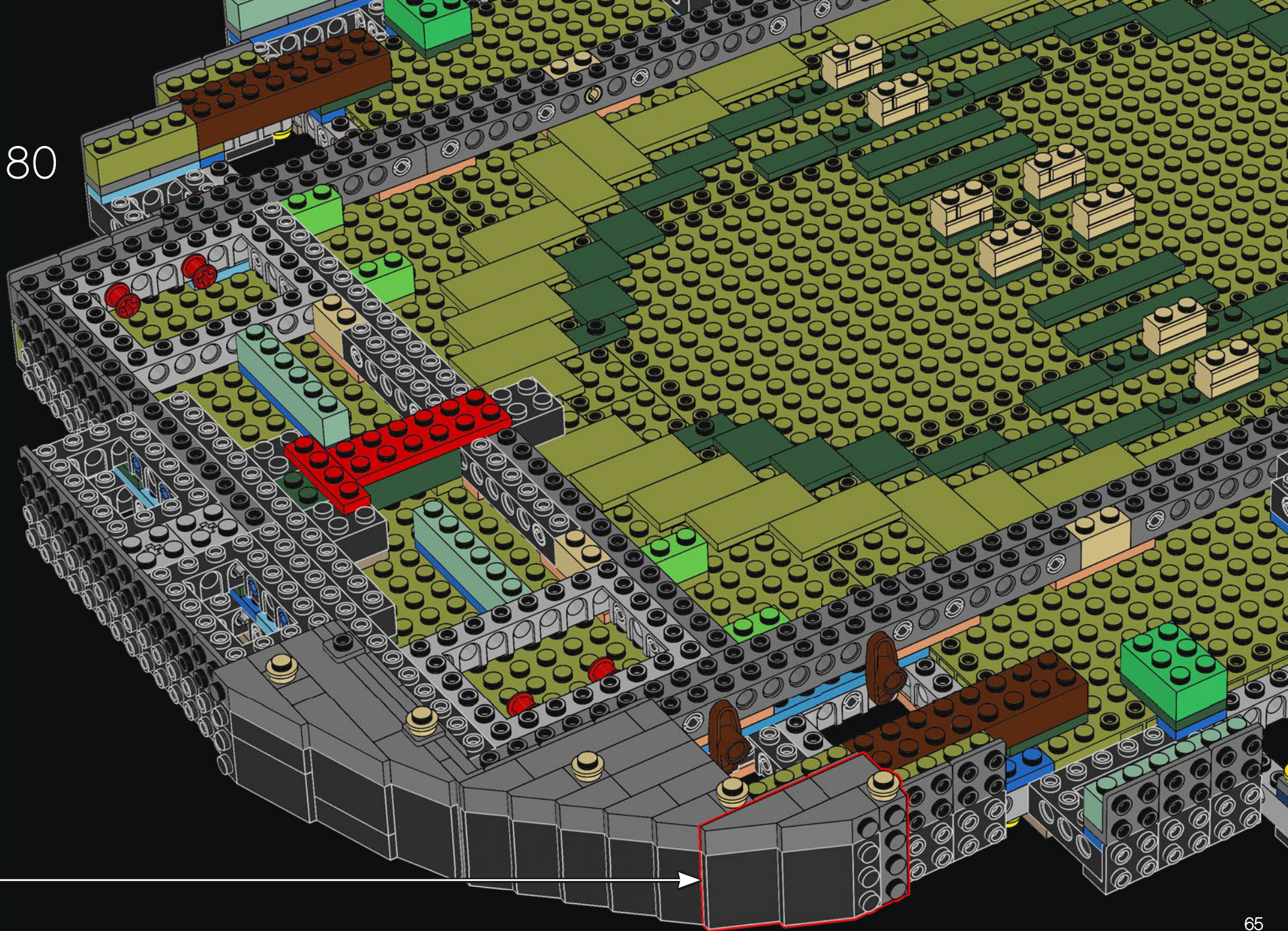

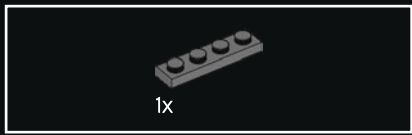

81

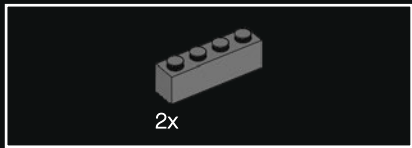

82

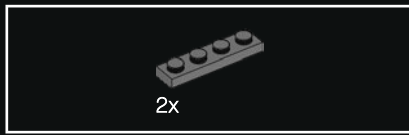
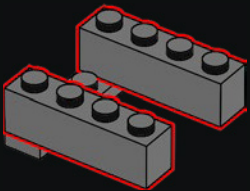

83

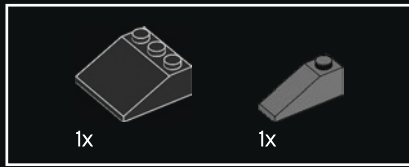
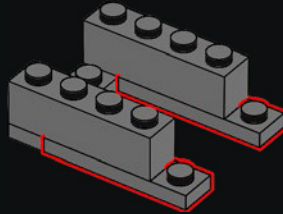

84

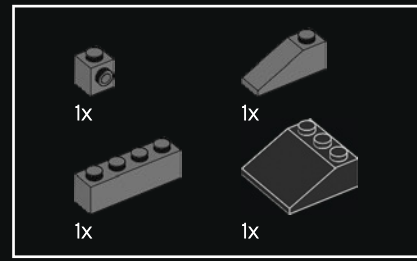
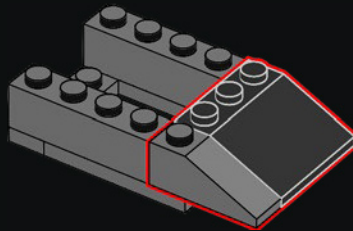

85

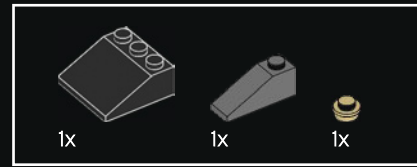
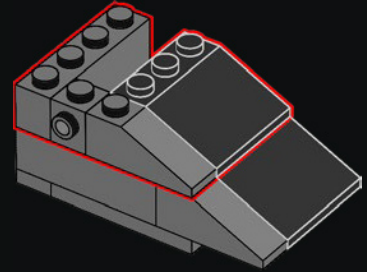

86

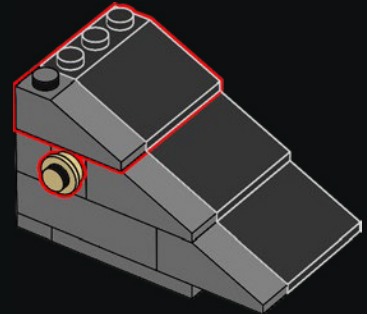

87

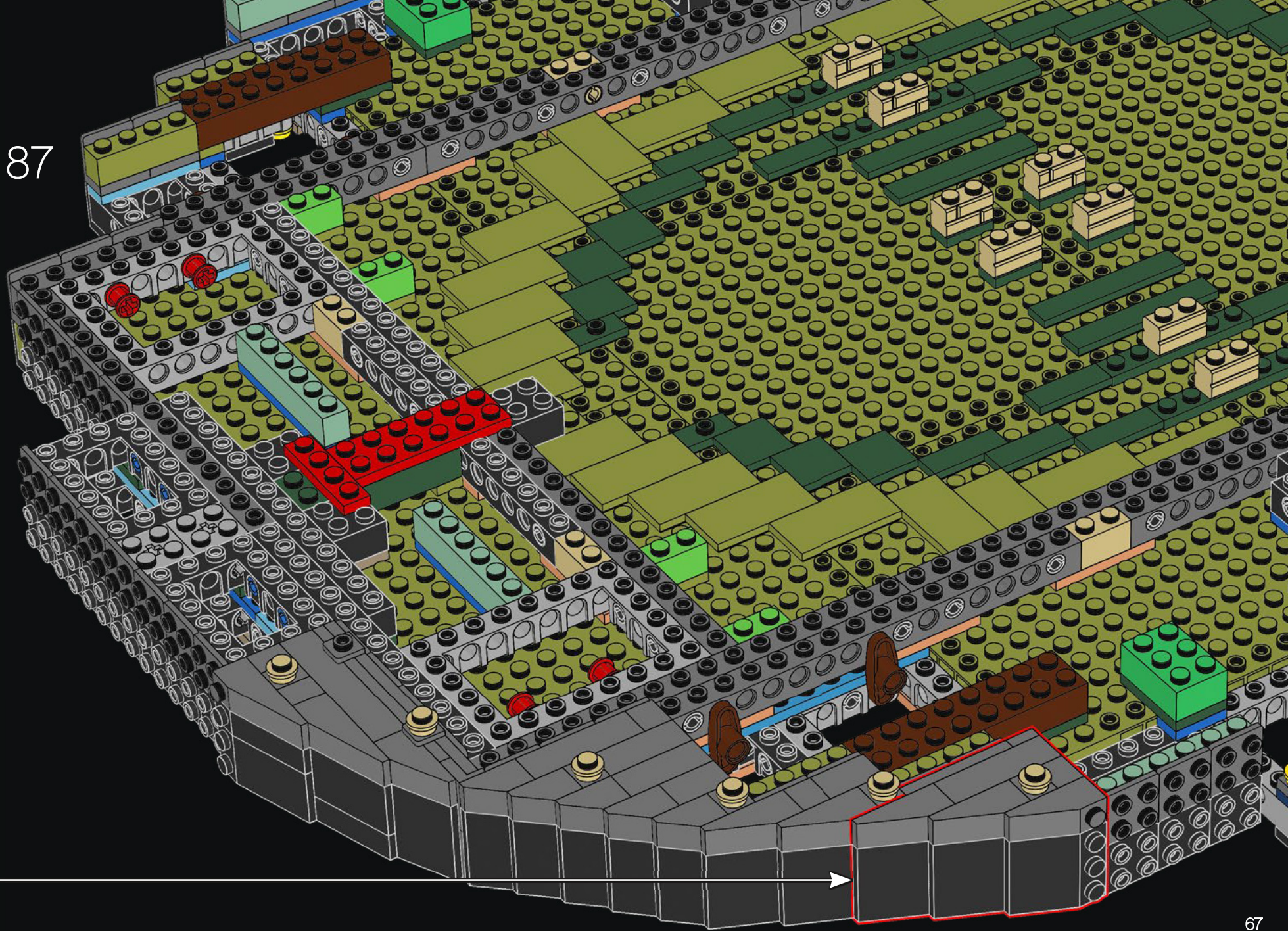

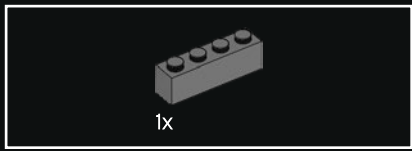

88

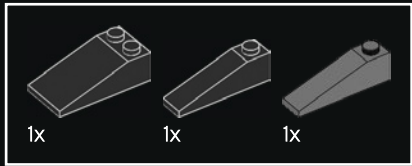
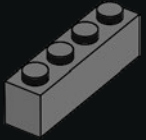

89

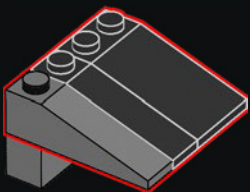

90

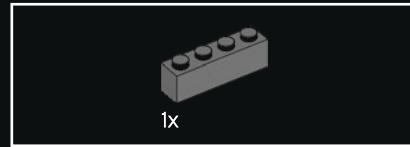
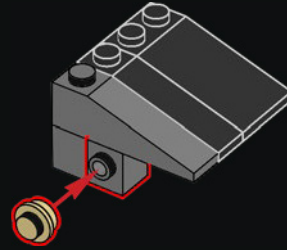

91

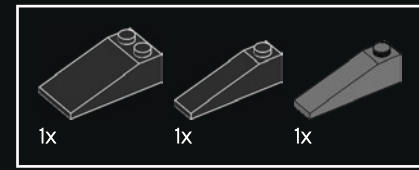
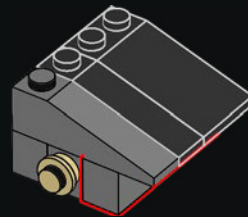

92

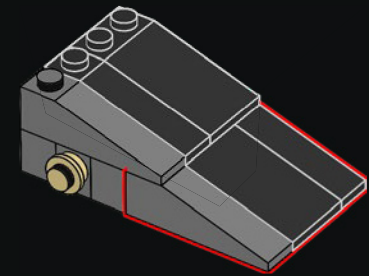

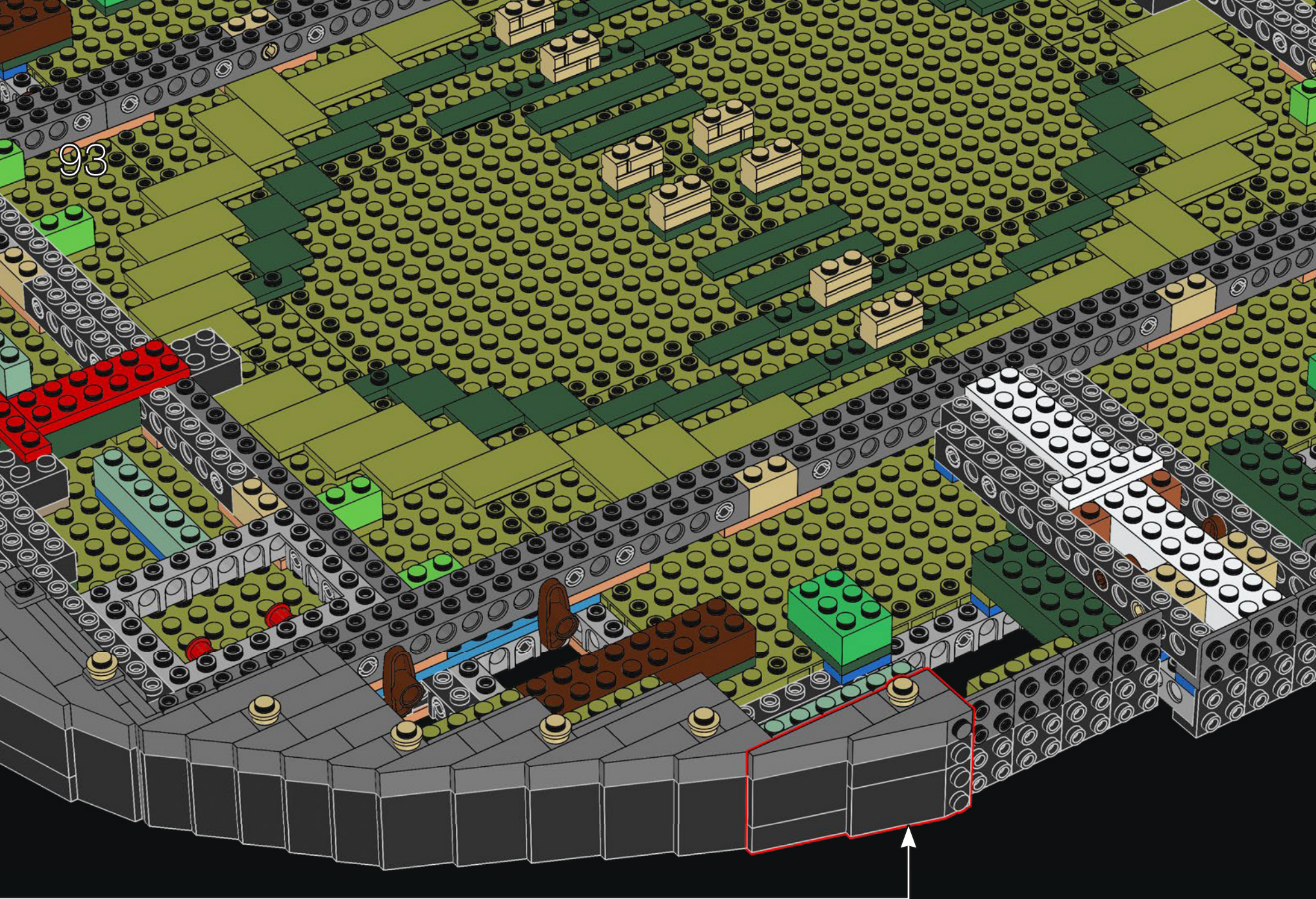

93

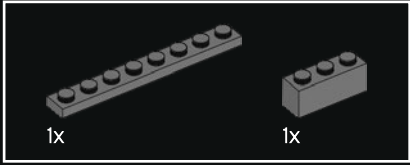
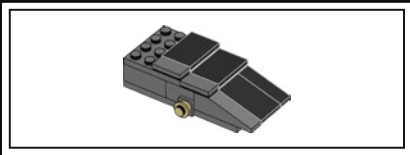

94

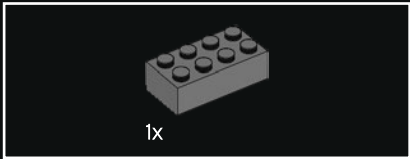
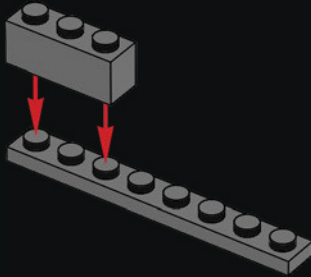

95

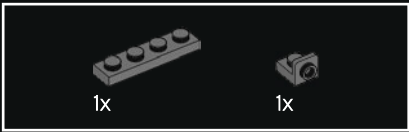
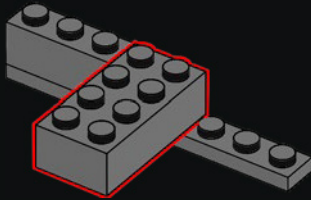

96

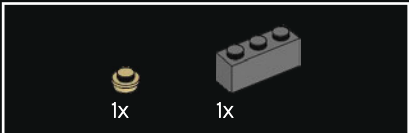
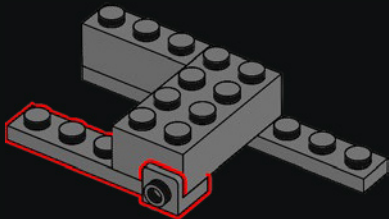

97

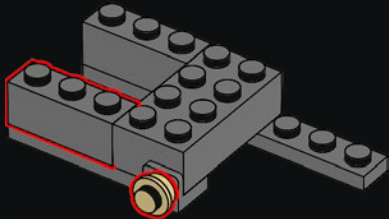

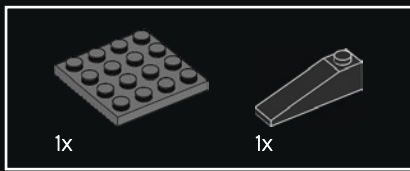

98

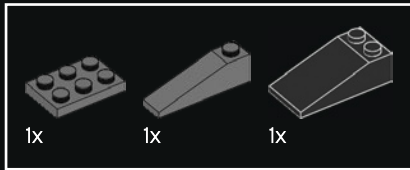
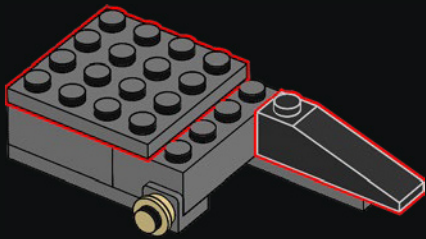

99

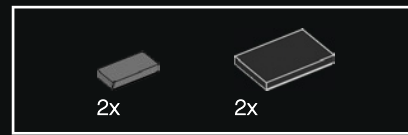
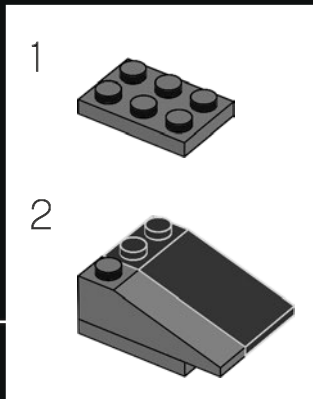
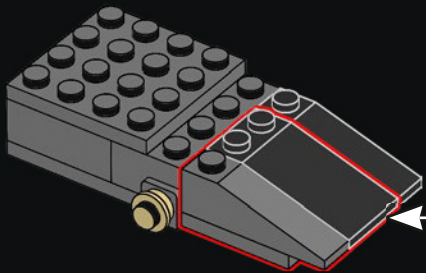

100

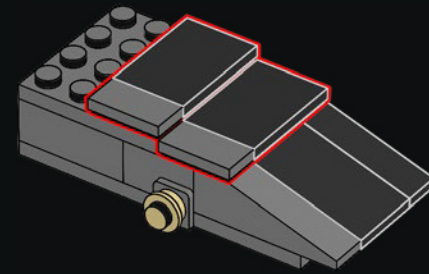

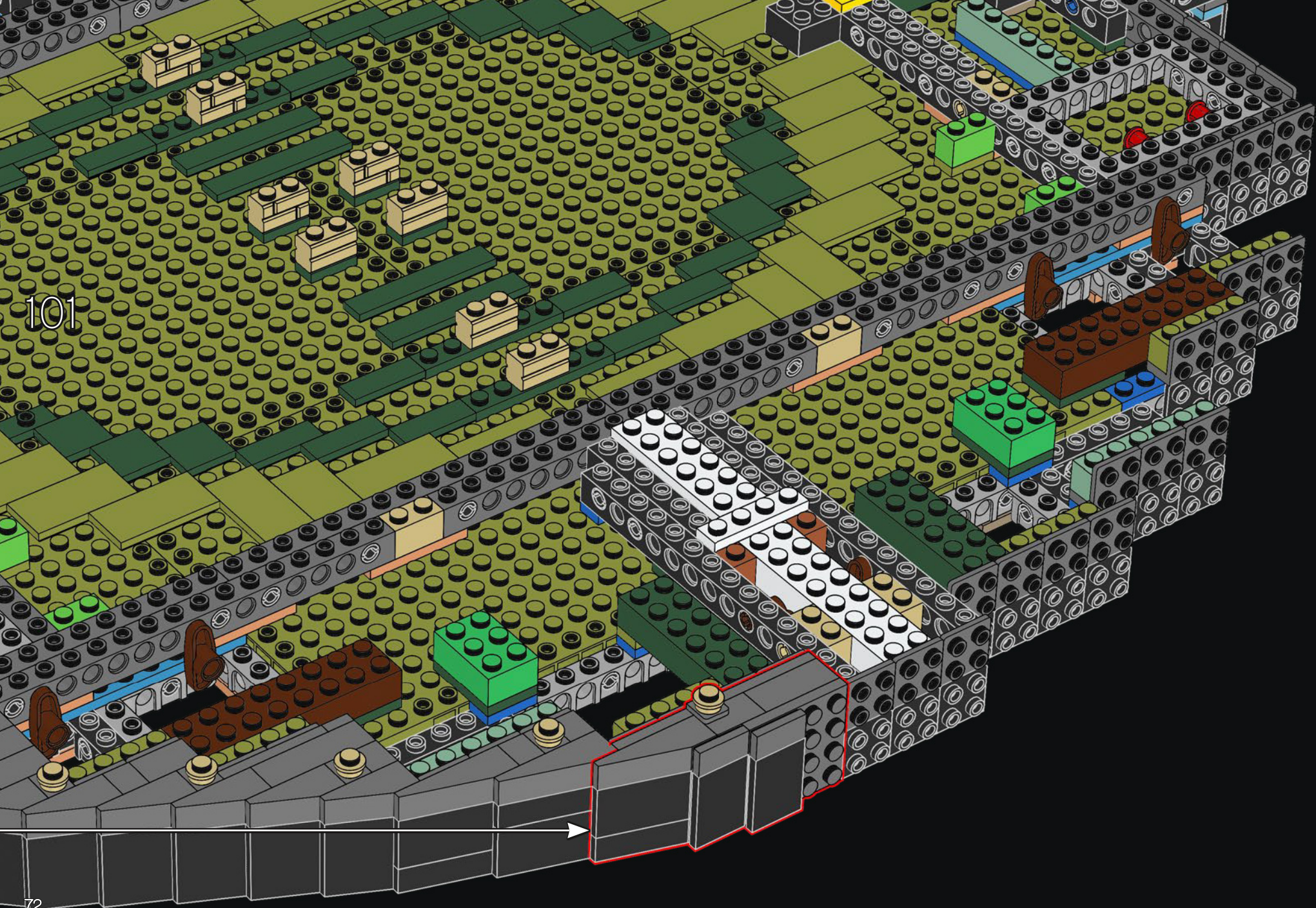

101

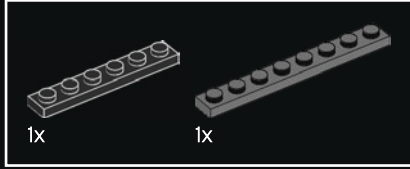
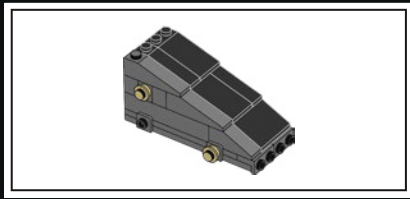

102

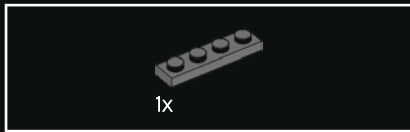
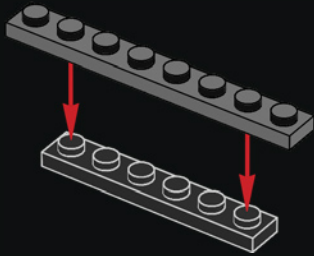

103

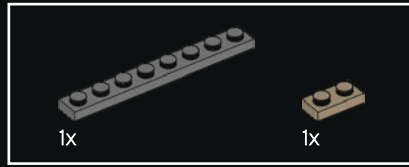
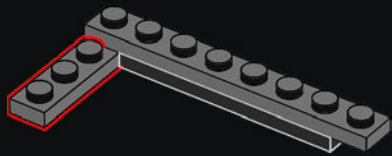

104

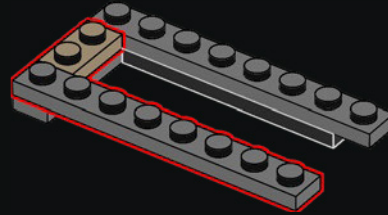

105

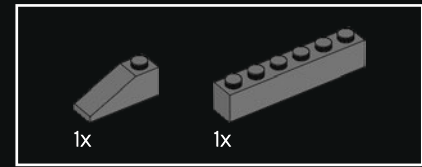
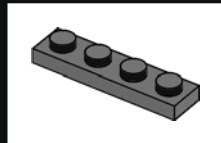
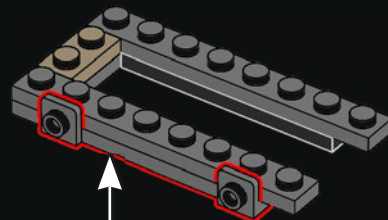

106

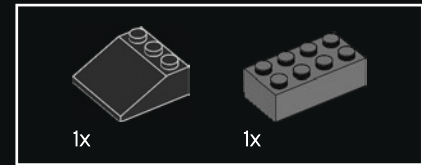
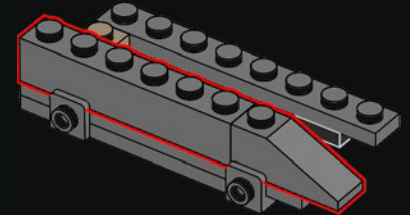

107

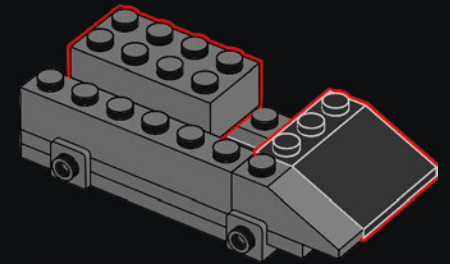

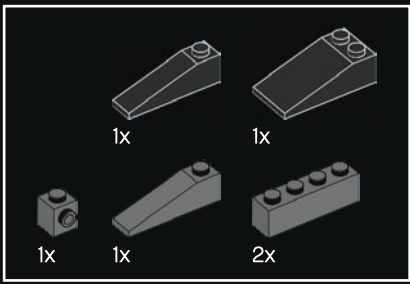

108

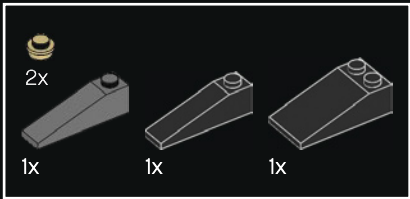
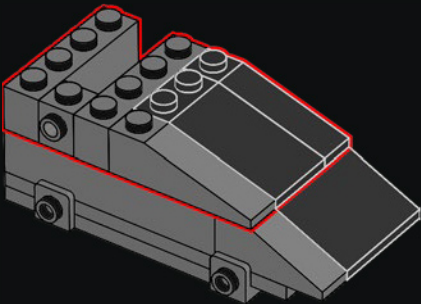

109

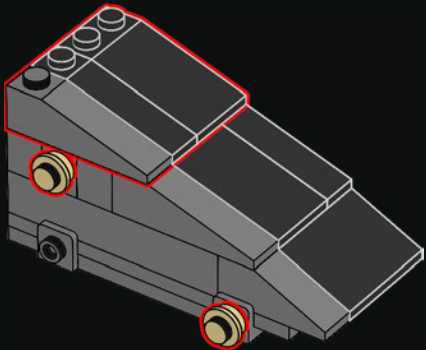

110

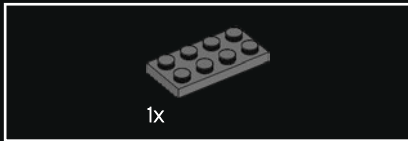
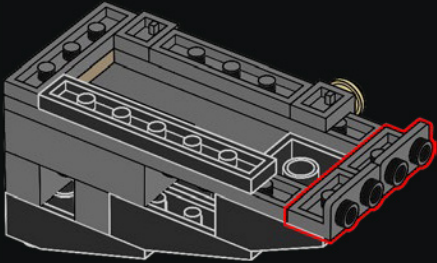

111

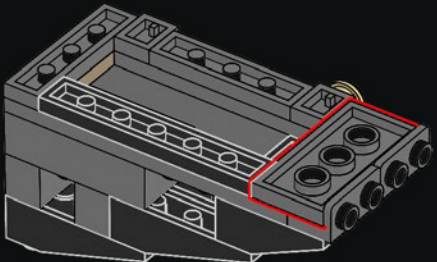

112



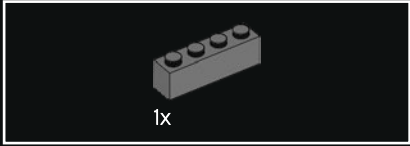
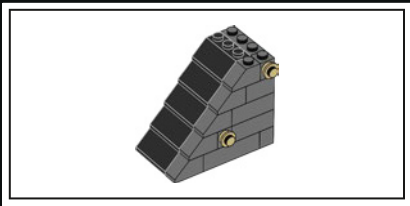

113

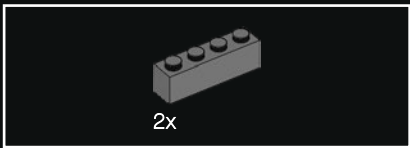
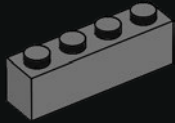

114

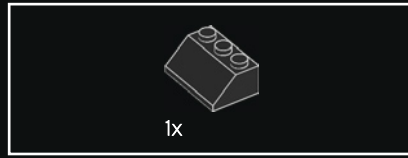
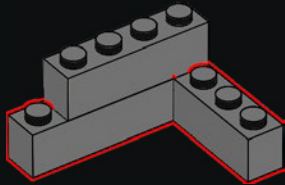

115

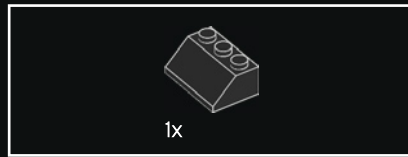
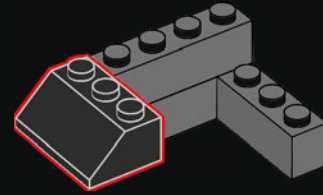

116

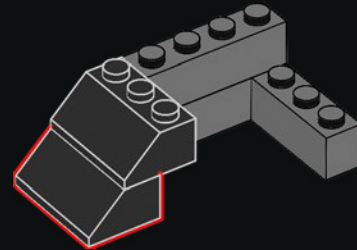

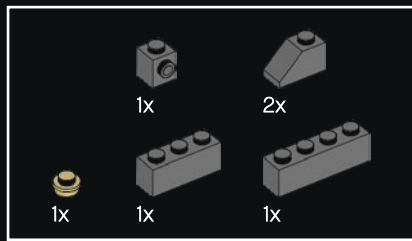

117

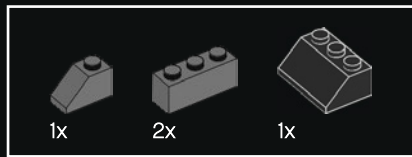
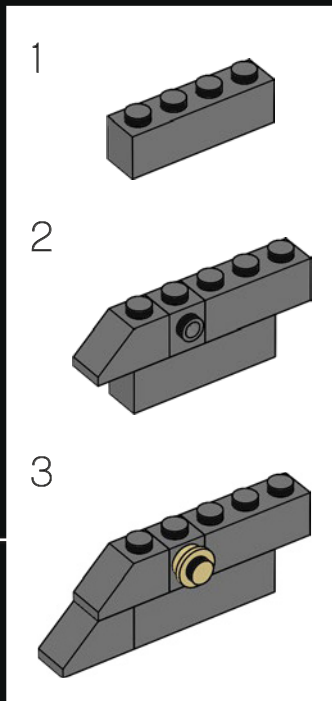
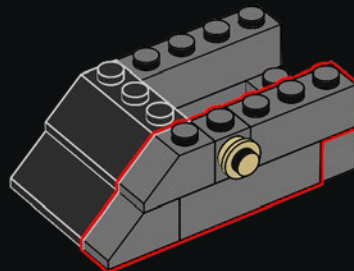

118

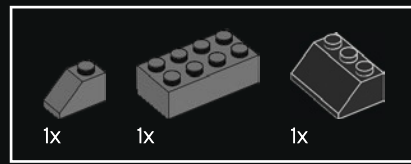
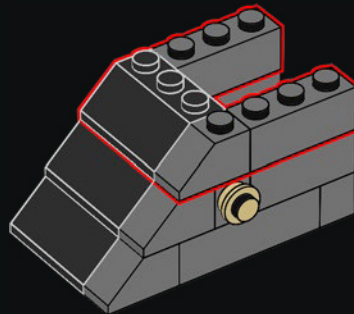

119

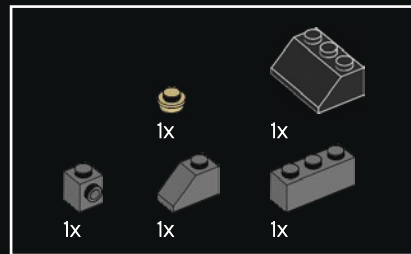
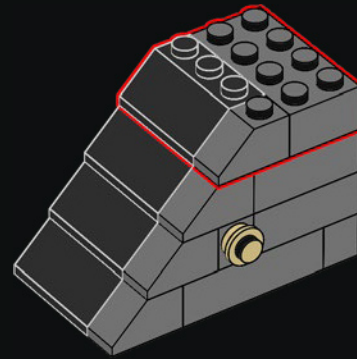

120

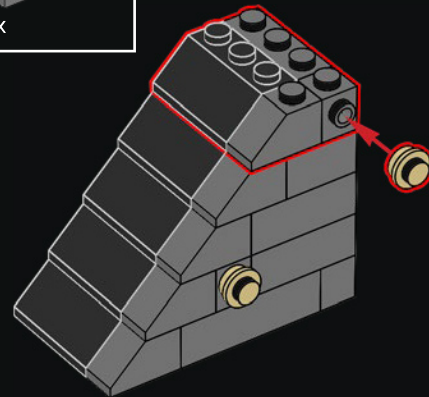

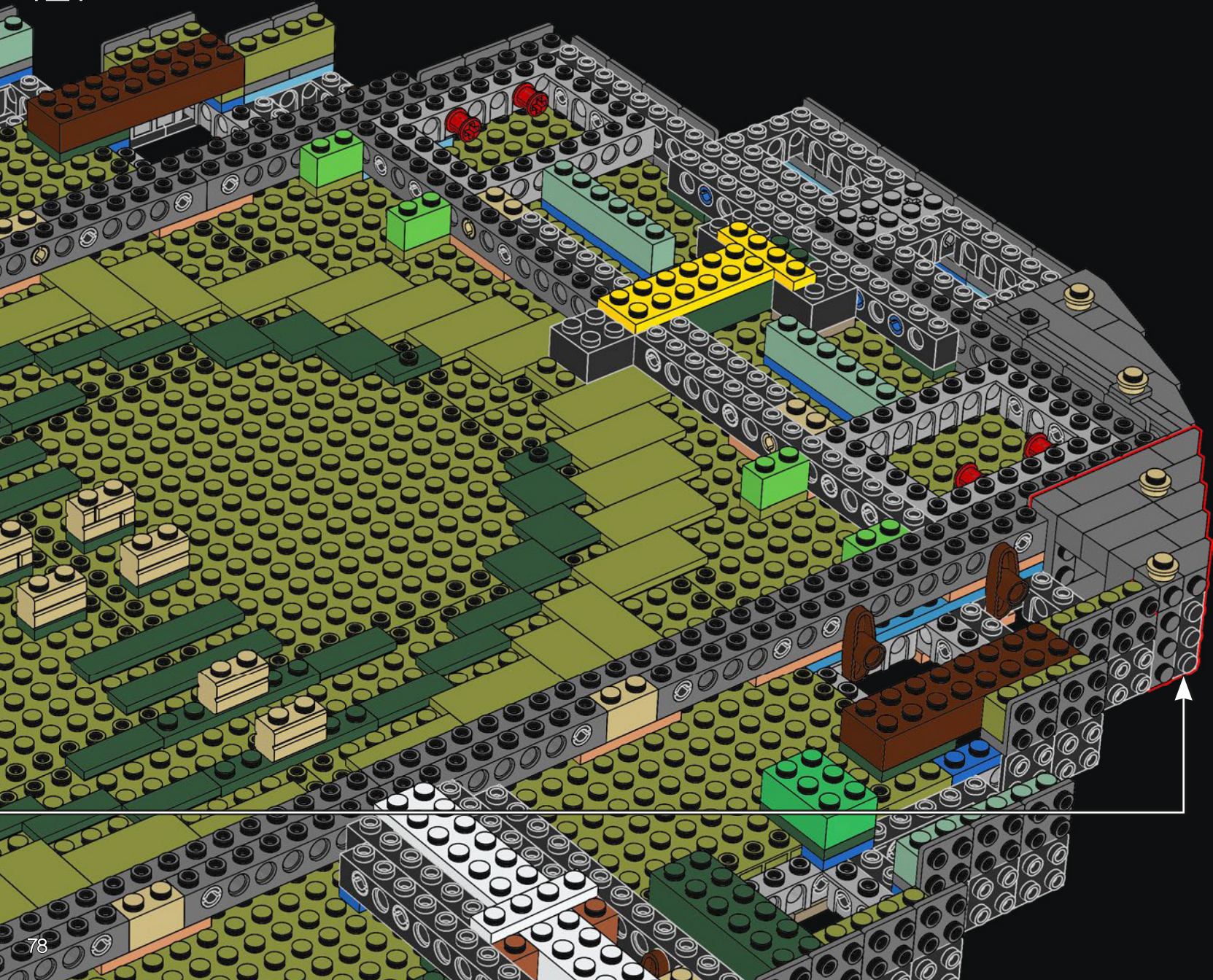

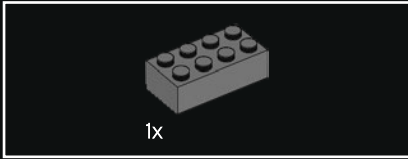
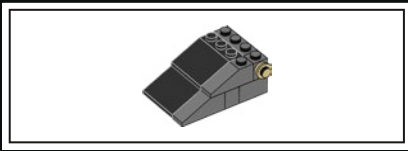

122

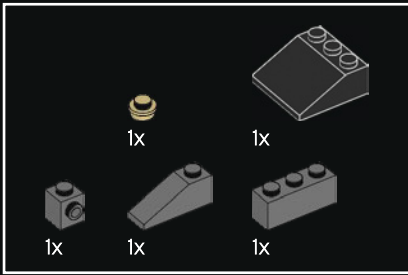
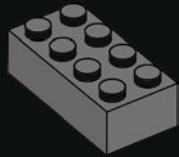

123

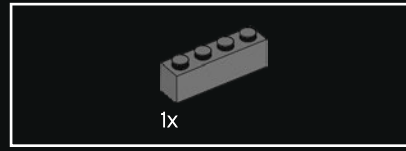
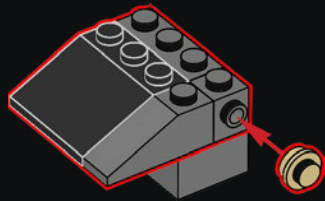

124

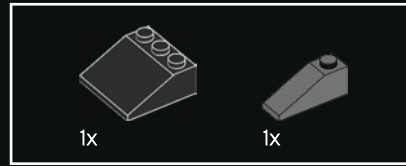
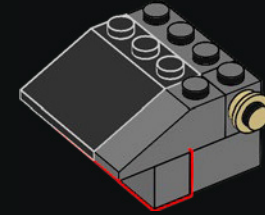

125

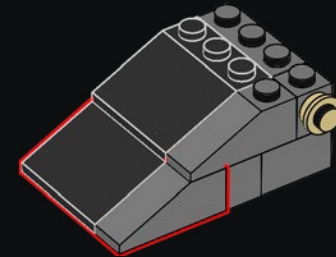



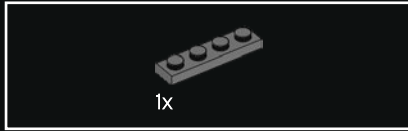
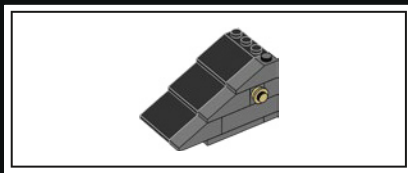

127

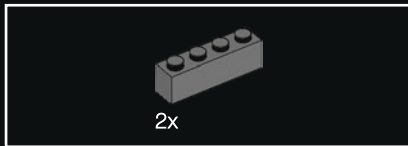
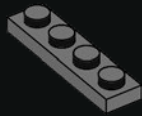

128

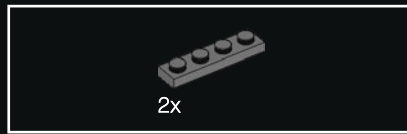
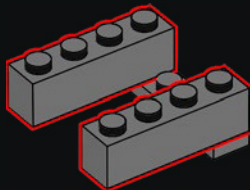

129

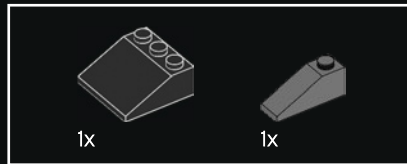
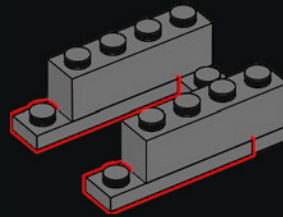

130

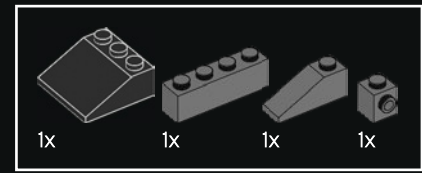
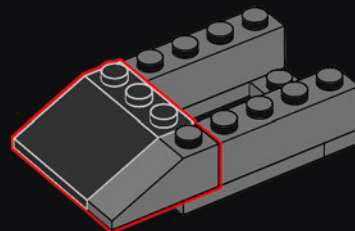

131

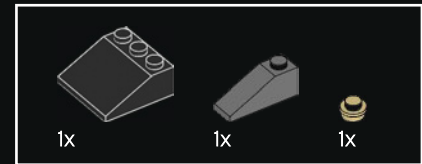
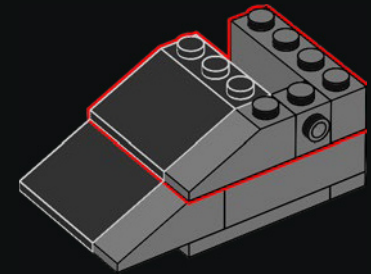

132

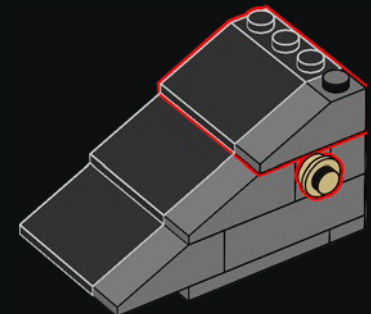



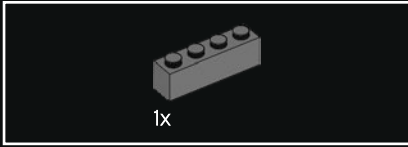
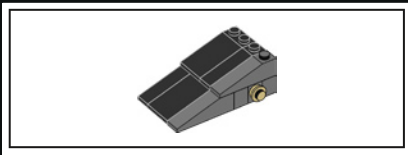

134

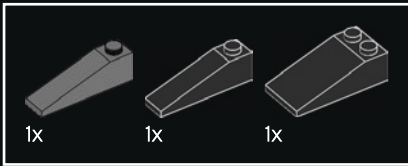
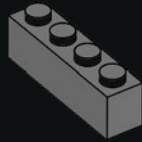

135

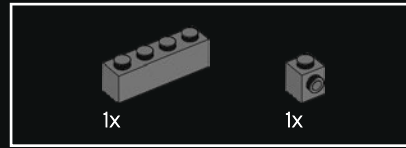
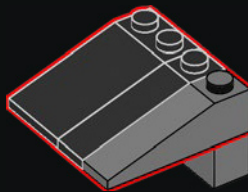

136

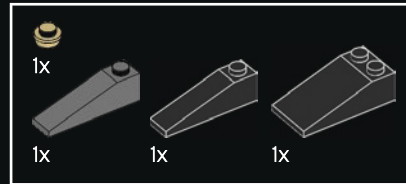
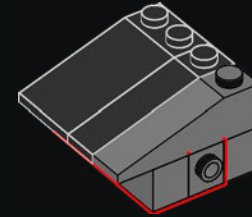

137

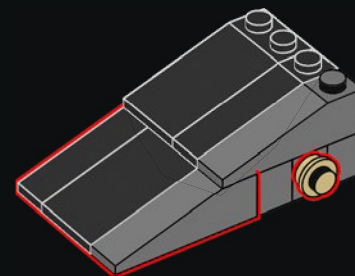



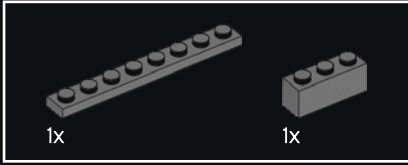
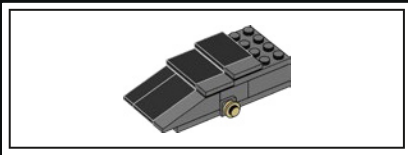

139

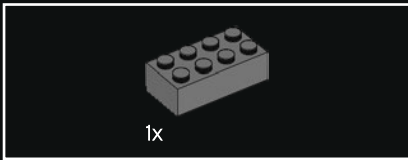
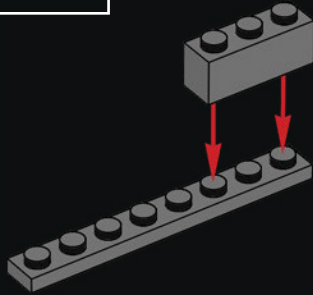

140

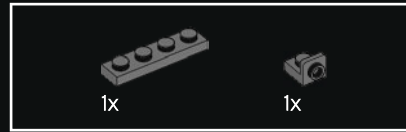
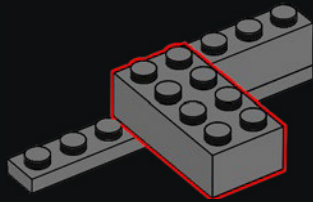

141

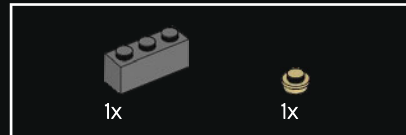
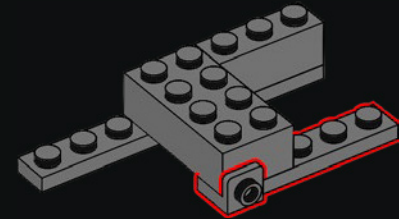

142

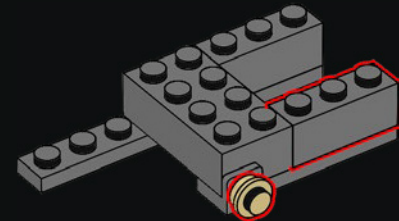

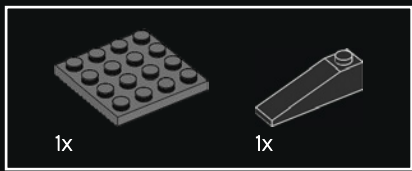

143

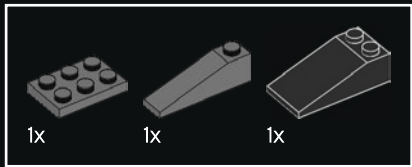
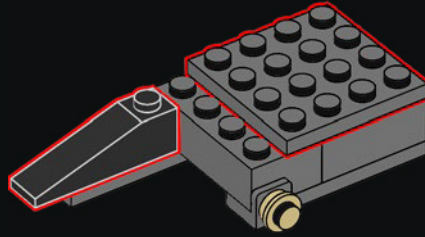

144

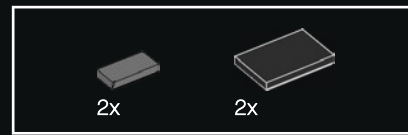
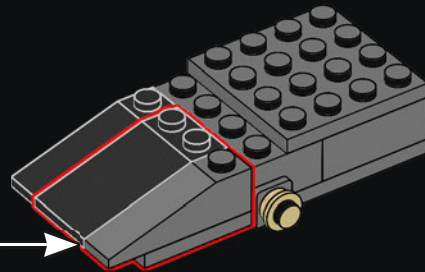
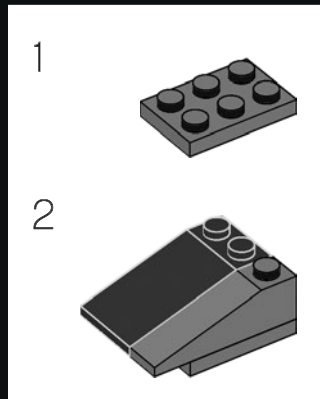

145

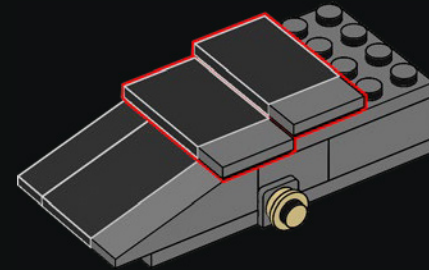

146

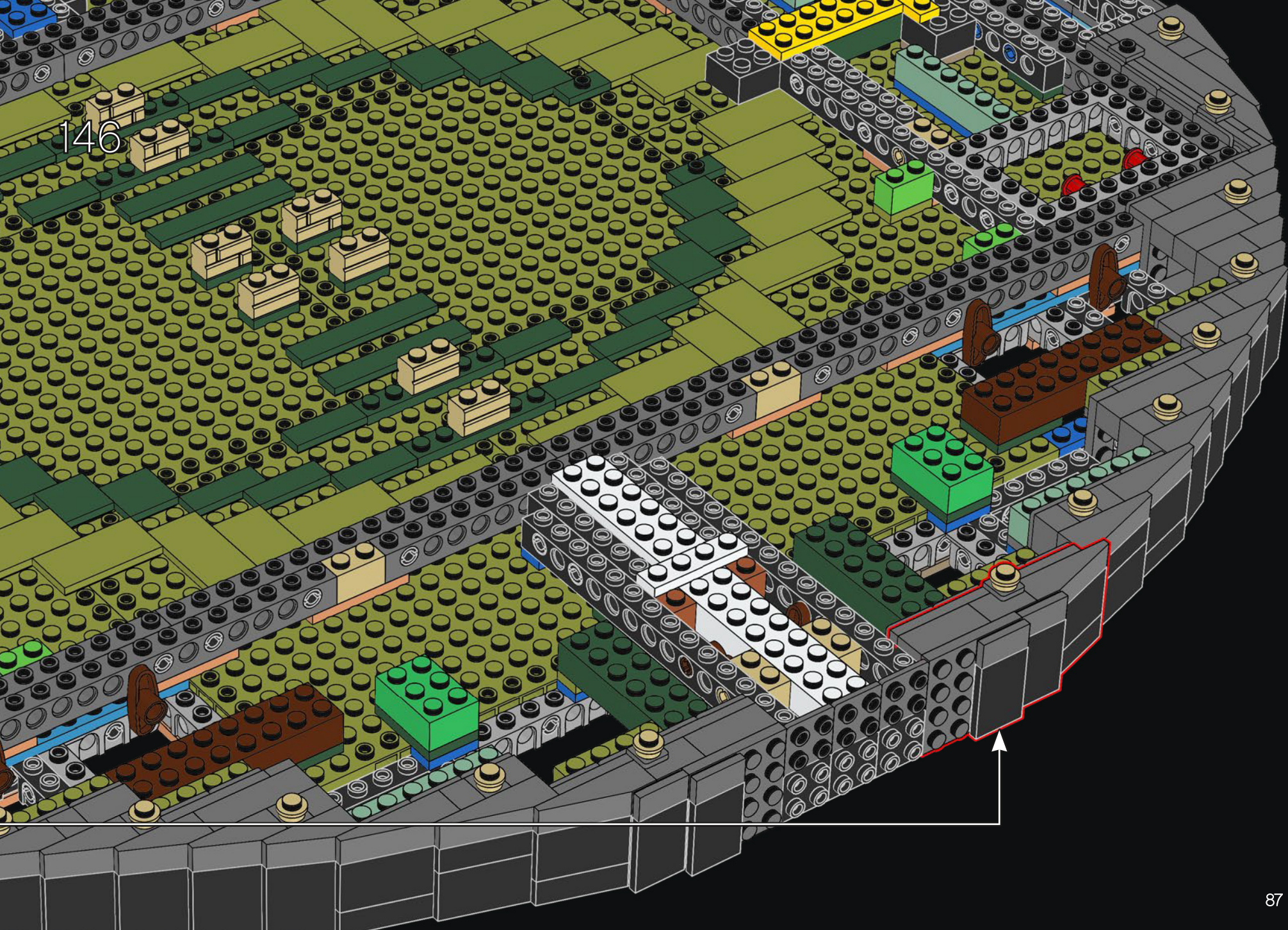

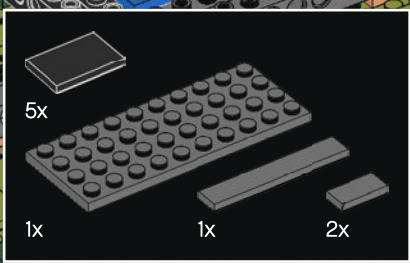

147

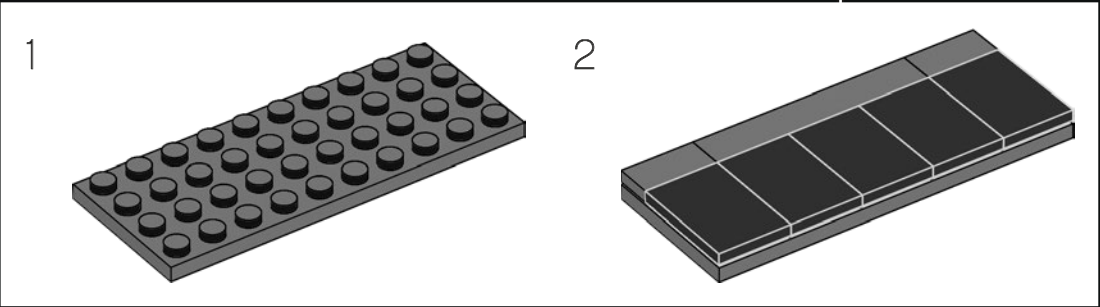

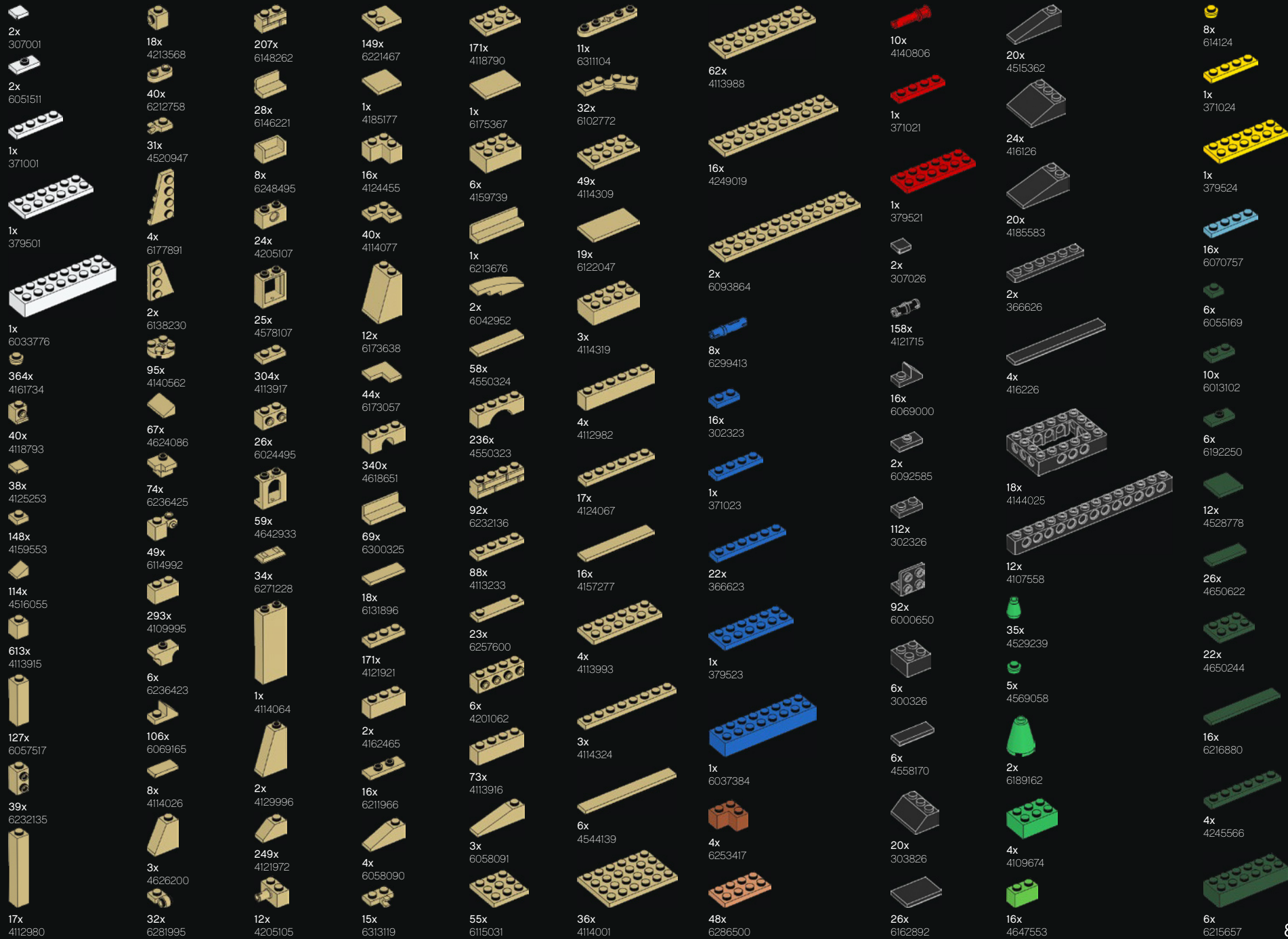

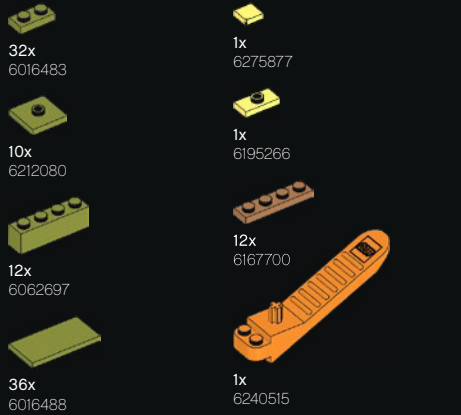

10x
6301768

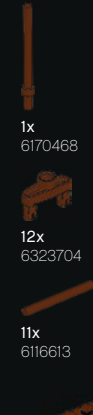
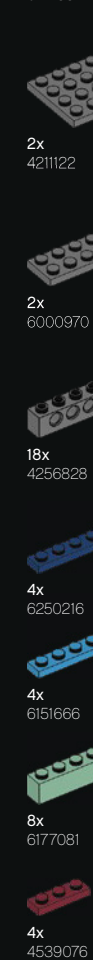
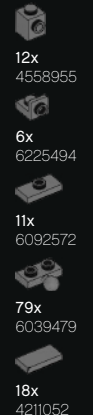
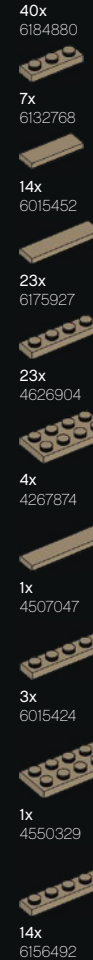
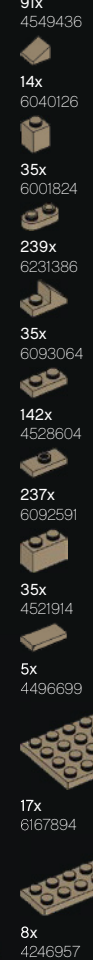
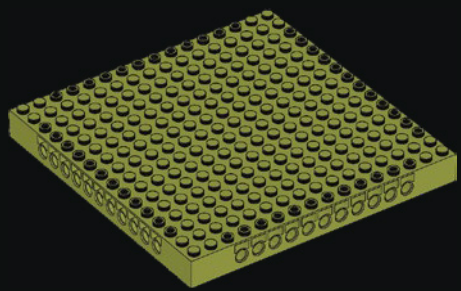

Customer Service
Kundenservice
Service Consommateurs
Servicio Al Consumidor
LEGO.com/service or dial

00800 5346 5555 : 
1-800-422-5346 : 



FEEDBACK AND WIN



FEEDBACK AND WIN

Your feedback will help shape the future development of this product series.

Please visit:

FEEDBACK UND GEWINNEN

Dein Feedback trägt zur Weiterentwicklung dieser Produktreihe bei.

Geh auf:

COMMENTEZ ET GAGNEZ

Vos commentaires nous aideront à concevoir les futurs produits de cette gamme.

Rendez-vous sur :

COMENTA Y GANA

Tu opinión nos ayudará a dar forma al desarrollo de esta serie de productos en el futuro.

Visita:

反馈有奖

您的反馈将有助于我们在今后改进本系列产品。

请访问：

[LEGO.com/productfeedback](https://www.lego.com/productfeedback)

By completing, you will automatically enter a drawing to win a LEGO® set.

Terms & Conditions apply.

Durch Ausfüllen nimmst du automatisch an der Verlosung eines LEGO® Preises teil.

Es gelten die Teilnahmebedingungen.

En envoyant vos commentaires, vous serez automatiquement inscrit(e) à un tirage au sort qui vous permettra de remporter un prix LEGO®.

Offre soumise à conditions.

Al contestar, participarás automáticamente en el sorteo y podrás ganar un set LEGO®.

Sujeto a Términos y Condiciones.

完成我们的反馈调查，即可自动进入抽奖环节，赢取乐高®套装。

适用《条款和条件》。

