



CREATOR™

10267



Save this leaflet because it contains important information.

Important information about batteries

Never use different types of batteries together, or a combination of old and new batteries. Always remove the batteries if the product is not to be used for a long time or if the batteries have run down. Never use damaged batteries. Only use batteries of the type recommended, or a corresponding type. Insert the batteries so that the poles are correctly positioned. Rechargeable batteries must be recharged using the correct battery charger under the supervision of an adult. You cannot recharge batteries while they are still in the product, and you must never try to do so. Never attempt to recharge non-rechargeable batteries. Never short-circuit the battery holder.

Wichtige Informationen zu Batterien

Benutzen Sie niemals unterschiedlich Arten von Batterien oder alte und neue gleichzeitig. Nehmen Sie stets die Batterien heraus, wenn mit dem Modell längere Zeit nicht gespielt wird oder wenn die Batterien leer sind. Verwenden Sie niemals beschädigte Batterien. Verwenden Sie ausschließlich empfohlene bzw. geeignete Batterien. Achten Sie beim Einsetzen der Batterien auf die richtige Polung. Wiederaufladbare Batterien sollten mit einem geeigneten Ladegerät aufgeladen werden - unter der Aufsicht eines Erwachsenen. Wiederaufladbare Batterien können und sollten niemals aufgeladen werden, während sie sich im Modell befinden. Versuchen Sie unter keinen Umständen, „normale“ Batterien wieder aufzuladen. Schließen Sie das Batteriefach niemals kurz.

Informations importantes concernant les piles

Ne jamais utiliser un mélange de différents types de piles, ou de piles neuves et de piles anciennes ou déjà utilisées. Toujours retirer les piles si le produit n'est pas utilisé durant une période prolongée ou si les piles sont vides. Ne jamais utiliser de piles endommagées. Utiliser uniquement des piles du type recommandé ou d'un type équivalent. En insérant les piles, respecter scrupuleusement le sens d'orientation des pôles (+/-). Les piles rechargeables doivent être rechargées en utilisant un chargeur de piles adéquat et sous la surveillance d'un adulte. Il est impossible de recharger les piles quand elles sont installées dans le produit. Ne jamais tenter de le faire. Ne jamais essayer de recharger des piles non-rechargeables. Ne jamais court-circuiter le compartiment des piles.

Salvare questo foglio perché contiene importanti informazioni.

Importanti informazioni sulle batterie

Non usare mai contemporaneamente batterie di tipo diverso o batterie nuove e usate insieme. Rimuovere sempre le batterie qualora il prodotto non venga utilizzato per periodi prolungati, oppure se le batterie sono esauste. Non utilizzare mai batterie danneggiate. Usare esclusivamente batterie del tipo raccomandato o un equivalente. Inserire le batterie avendo cura che la loro polarità sia corretta. Le batterie ricaricabili vanno ricaricate in un caricabatterie di tipo idoneo e con la supervisione di un adulto. Non è possibile e non bisogna mai tentare di ricaricare le batterie mentre queste sono inserite nel prodotto. Non tentare mai di ricaricare batterie non ricaricabili. Non cortocircuitare mai il portabatterie.

Belangrijke informatie over batterijen

Gebruik nooit verschillende soorten of een combinatie van oude en nieuwe batterijen tegelijkertijd. Verwijder de batterijen altijd als je het product lange tijd niet wilt gebruiken of als batterijen leeg zijn. Gebruik nooit beschadigde batterijen. Gebruik uitsluitend batterijen van het aanbevolen type of een overeenkomstig type. Plaats de batterijen met de polen in de juiste richting. Opladbare batterijen moeten in een voor dit doel bestemde oplader en onder toezicht van een volwassene opnieuw worden opgeladen. Opladbare batterijen kunnen niet worden opgeladen terwijl ze zich nog in het product bevinden en dit mag ook nooit worden geprobeerd. Probeer nooit niet-oplaadbare batterijen opnieuw op te laden. Laat de batterijhouder nooit kortsluiten.

Información importante acerca de las pilas

No use pilas de diferentes tipos ni pilas nuevas y antiguas para alimentar el producto. Extraiga las pilas del producto si este va a permanecer sin uso durante un período prolongado de tiempo o aquellas se han agotado. No use pilas dañadas. Use sólo pilas del tipo recomendado u otro equivalente. Inserte las pilas de modo que los polos queden situados en las posiciones correctas. La carga de pilas recargables debe tener lugar empleando un cargador apropiado y bajo la supervisión de un adulto. Las pilas recargables no se pueden cargar mientras permanecen insertadas en el producto; no intente hacerlo. No trate de cargar pilas no recargables. No cortocircuite el compartimento de las pilas.

Vigtige oplysninger om batterier

Brug aldrig forskellige batterityper sammen eller en kombination af gamle og nye batterier. Fjern altid batterierne, hvis produktet ikke skal bruges i lang tid, eller hvis batterierne er flade. Brug aldrig beskadigede batterier. Brug kun den anbefalede type batterier eller en tilsvarende type. Sæt batterierne i, så polerne vender den rigtige vej. Genopladelige batterier skal oplades i den rigtige batterioplader. Batterierne skal sættes i opladeren under opsyn af en voksen. Batterierne kan ikke oplades, mens de stadig sidder i produktet, og man må aldrig forsøge at gøre det. Forsøg aldrig at oplade ikke-genopladelige batterier. Kortslut aldrig batteriholderen.

Mikilvægar upplýsingar um rafhlöður

Aldrei skal nota mismunandi gerðir rafhlaða samtímis, né nýjar og eldri rafhlöður samtímis. Ef ekki á að nota tækid í lengri tíma eða ef rafhlöðurnar eru orðnar tómar skal fjarlægja rafhlöðurnar. Aldrei skal nota rafhlöður sem hafa skemmt. Aðeins skal nota rafhlöður af þeirri gerð sem mælt er með, eða samsvarandi gerð. Setja skal rafhlöðurnar í þannig að +- og -skaut þeirra snúi rétt. Endurhlaðanlegar rafhlöður skal endurhlaða með réttu hleðslutækni undir eftirliti fullorðinna. Rafhlöður er ekki hægt að endurhlaða á meðan þær eru enn í vörunni og það má aldrei reyna að gera það. Aldrei skal reyna að endurhlaða rafhlöður sem ekki eru endurhlaðanlegar. Aldrei ætti að valda skammhlaupi í rafhlöðuhólfinu.

Tärkeää tietoa paristoista

Älä koskaan käytä erityyppisiä paristoja yhdessä. Älä myöskään käytä samassa laitteessa sekä vanhoja että uusia paristoja. Poista paristot tuotteesta aina, kun se on pitemmän aikaa käyttämättä, tai kun paristot ovat tyhjentyneet. Älä koskaan käytä viallisia paristoja. Käytä vain tuotteessa suositeltuja tai vastaavyyppisiä paristoja. Aseta paristot siten, että navat osoittavat oikeaan suuntaan. Ladattavat paristot on ladattava oikeanlaisella laiturilla aikuisen valvonnassa. Ne on poistettava tuotteesta lataamisen ajaksi. Älä koskaan yritä ladata paristoja, joita ei ole tarkoitettu ladattaviksi. Älä koskaan aiheuta oikosulkua pariston kosketinten välillä.

Viktig information om batterier

Använd aldrig olika sorters batterier samtidigt, och inte heller en kombination av gamla och nya batterier. Ta alltid ur batterierna om produkten inte ska användas under en längre tid eller om batterierna är slut. Använd aldrig skadade batterier. Använd bara batterier av den typ som rekommenderas, eller av en motsvarande typ. Sätt i batterierna så att polerna hamnar i rätt läge. Laddningsbara batterier måste laddas med rätt slags batteriladdare och under en vuxens överinseende. Du kan inte ladda batterierna medan de fortfarande sitter i produkten, och du får heller aldrig försöka göra det. Försök aldrig ladda icke laddningsbara batterier. Kortslut aldrig batteriutrymmets kontakttyper.

Viktig informasjon om batterier

Bruk aldri ulike typer batterier sammen og heller aldri gamle og nye batterier sammen. Ta alltid ut batteriene hvis produktet ikke skal brukes på lang tid, eller hvis batteriene er brukt opp. Bruk aldri skadde batterier. Bruk kun anbefalt type batterier eller tilsvarende type. Sett inn batteriene med polene vendt riktig vei. Opladbare batterier skal lades opp med riktig batterilader, under overoppsyn av en voksen. Det er ikke mulig å lade opp batteriene mens de fremdeles er i produktet, og du må aldri forsøke å gjøre det. Forsøk aldri å lade opp ikke-oppladbare batterier. Kortslutt aldri batteriholderen.

Guardar este folheto por conter informações importantes.

Informação importante sobre as pilhas

Nunca use diferentes tipos de pilhas em simultâneo, ou uma combinação de pilhas usadas e novas. Retire sempre as pilhas se o produto não for usado durante muito tempo ou se as pilhas já não tiverem carga. Nunca use pilhas danificadas. Use apenas pilhas do tipo recomendado ou de um tipo correspondente. Insira as pilhas de forma a que os pólos fiquem corretamente posicionados. As pilhas recarregáveis devem ser recarregadas com o carregador de pilhas correto e sob a supervisão de um adulto. Não pode recarregar as pilhas enquanto as mesmas se encontram colocadas no produto e nunca deve tentar fazê-lo. Nunca tente recarregar pilhas não recarregáveis. Nunca deixe o compartimento das pilhas entrar em curto-circuito.

Σημαντικές πληροφορίες για τις μπαταρίες

Μην χρησιμοποιείτε ποτέ διαφορετικούς τύπους μπαταριών μαζί και μην συνδυάζετε παλιές και καινούργιες μπαταρίες. Αφαιρείτε πάντα τις μπαταρίες αν δεν σκοπεύετε να χρησιμοποιήσετε το προϊόν για αρκετό καιρό ή αν οι μπαταρίες έχουν αδειάσει. Ποτέ μην χρησιμοποιείτε μπαταρίες που έχουν φθορές. Χρησιμοποιείτε μόνο μπαταρίες του συνιστώμενου τύπου ή κάποιου αντίστοιχου τύπου. Τοποθετήστε τις μπαταρίες με τους πόλους στη σωστή θέση. Οι επαναφορτιζόμενες μπαταρίες πρέπει να επαναφορτίζονται χρησιμοποιώντας το σωστό φορτιστή μπαταριών υπό την επίβλεψη ενήλικου. Δεν μπορείτε να επαναφορτίσετε τις μπαταρίες όταν αυτές βρίσκονται μέσα στο προϊόν και δεν πρέπει ποτέ να δοκιμάσετε κάτι τέτοιο. Μην επιχειρήσετε ποτέ να επαναφορτίσετε μη επαναφορτιζόμενες μπαταρίες. Ποτέ μην βραχυκυκλώσετε τη θήκη των μπαταριών.

電池取扱いに関する重要事項

異なるタイプの電池や古い電池を混ぜて使用しないでください。商品を長時間使用しないときや電池が切れたときは、電池を必ず取り外してください。不具合のある電池は絶対に使用しないでください。推奨されているタイプまたは対応しているタイプの電池を必ず使用してください。電極を確認して電池を正しい向きに入れてください。充電式電池は、保護者に見てもらった上で適切な充電器を使って充電してください。充電式ではない電池は絶対に充電しないでください。電池ホルダをショートさせないでください。

关于电池的重要信息

请勿同时使用不同类型的电池，或把新旧程度不同的电池混合使用。如果产品将有很长时间不会使用，或者电池已经没电，请注意取出电池。切勿使用已破损的电池。务必仅使用推荐类型或兼容类型的电池。装入电池时请注意正负极。如果使用充电电池，务必在成人监护下使用正确的电池充电器进行充电。电池仍在产品中时不可进行充电，请勿强行尝试充电。请勿尝试给非充电电池充电。切勿对电池仓进行短路连接。

KO

배터리 사용 시 주의사항

다른 종류의 배터리를 함께 사용하거나, 새 전지와 오래된 전지를 혼용하지 마세요. 배터리가 방전되었거나 장기간 제품을 작동하지 않을 때에는 반드시 배터리를 분리하세요. 파손된 배터리는 사용하지 마세요. 레고에서 권장하는 유형의 배터리만 사용하세요. 양극과 음극의 위치를 잘 맞춰서 넣으세요. 어른의 감독에 따라 지정된 충전기에 충전지를 충전해야 합니다. 충전지를 제품에 넣은 상태로 충전하면 안 됩니다. 일반 배터리는 충전해서 사용할 수 없습니다. 배터리 홀더의 접촉부에 배터리를 정확히 끼워서 사용하세요.

RU

Необходимая информация об элементах питания

Ни в коем случае не используйте одновременно элементы питания различных типов, а также элементы питания с разным сроком годности. В обязательном порядке вынимайте элементы питания из терминалов в случае, если вы не пользуетесь прибором в течение долгого времени, либо в случае, если в элементах питания закончился заряд. Ни в коем случае не используйте поврежденные элементы питания. Используйте только рекомендуемые элементы питания либо элементы питания соответствующего типа. Установите элементы питания, соблюдая указанную полярность. Аккумуляторные элементы питания должны подзарядиться в соответствующем зарядном устройстве под наблюдением взрослого. Ни в коем случае не пытайтесь подзарядить элементы питания, находящиеся в приборе. Ни в коем случае не пытайтесь подзарядить перезаряжаемые элементы питания. Ни в коем случае не пытайтесь замкнуть полюса в устройстве для элементов питания.

PL

Ważne informacje dotyczące baterii

Nigdy nie należy stosować razem różnych rodzajów baterii ani stosować równocześnie starych i nowych baterii. Jeżeli produkt nie jest używany przez dłuższy czas lub jeżeli baterie się wyczerpały, należy wyjąć baterie. Nigdy nie należy stosować uszkodzonych baterii. Należy stosować wyłącznie zalecany rodzaj baterii lub rodzaj mu odpowiadający. Przy wkładaniu baterii należy zwrócić uwagę na właściwe położenie biegunów. Baterie akumulatorowe należy ładować w odpowiedniej ładowarce pod nadzorem osoby dorosłej. Nie można naładować baterii bez wyjęcia ich z produktu i nigdy nie należy tego próbować. Nigdy nie należy próbować ładowania baterii jednorazowych. Nigdy nie należy doprowadzać do zwarcia w gnieździe baterii.

CZ

Důležité informace o bateriích

Nikdy nepoužívejte najednou různé typy baterií nebo kombinaci starých a nových baterií. Nebude-li se výrobek delší dobu používat nebo jsou-li baterie vybité, vždy je vyjměte z výrobku. Nikdy nepoužívejte poškozené baterie. Používejte pouze doporučené nebo odpovídající typy baterií. Baterie instalujte se správnou orientací pólů. Nabíjitelné baterie musí být nabitý ve vhodné nabíječce pod dohledem dospělé osoby. Nabíjitelné baterie nelze nabíjet, jsou-li umístěny ve výrobku, a nesmíte se o to ani pokoušet. Nikdy se nesnažte nabíjet baterie, které nejsou nabíjitelné. Nikdy neskratujte kontakty v prostoru pro baterie.

SK

Dôležitá informácia o batériách

Nikdy nepoužívajte naraz odlišné typy batérií ani nekombinujte staré batérie s novými. Batérie vždy vyberte, ak sa výrobok nebude dlhšie používať, alebo ak sa batérie vybili. Nikdy nepoužívajte poškodené batérie. Používajte len odporúčané alebo zodpovedajúce typy batérií. Batérie vkladajte so správnou orientáciou pólou. Nabíjateľné batérie sa musia nabíjať vo vhodnej nabíjačke pod dozorom dospeljej osoby. Nabíjateľné batérie sa nesmú nabíjať, ak sú umiestnené vo výrobku, a nesmiete sa o to ani pokúšať. Nikdy sa nesnažte nabíjať batérie, ktoré nie sú nabíjateľné. Nikdy neskratujte kontakty v priestore pre batérie.

HU

Fontos tudnivalók az elemekről

Soha ne használjon különböző típusú elemeket, illetve ne használjon vegyesen új és használt elemeket. Mindig távolítsa el az elemeket, ha a készülékkel előre láthatóan hosszabb ideig nem fogják használni, vagy ha az elemek lemerültek. Soha ne használjon megrongálódott elemeket. Csak az ajánlott típusú, vagy annak megfelelő elemet használjon. Az elemeket helyesen helyezze be, a polaritásuknak megfelelően. Az akkumulátorokat csak a megfelelő akkumulátortöltővel szabad feltölteni, felhőlti felügyelete mellett. Az akkumulátorokat nem lehet feltölteni, ha azok a készülékben vannak. Ezt meg sem szabad próbálni. Soha ne próbálja meg feltölteni a nem tölthető elemeket. Soha ne hozzon létre rövidzárlatot az elemtartó kivezetésén.

UA

Необхідна інформація про батарейки

Ніколи не використовуйте одночасно батарейки різних типів або батарейки з різним терміном придатності. Обов'язково вилучайте батарейки з приладу, якщо довго не користуєтесь ним, або якщо в батарейках вже скінчився заряд. Ніколи не використовуйте пошкоджені батарейки. Використовуйте батарейки лише рекомендованого або відповідного типу. Вставляйте батарейки, враховуючи задану полярність. Акумуляторні батарейки повинні заряджатись у відповідному зарядному приладі під наглядом дорослого. У будь-якому випадку не намагайтесь підзарядити батарейки, що знаходяться в приладі. У будь-якому випадку не намагайтесь підзарядити батарейки, що не підлягають підзарядці. У будь-якому випадку не намагайтесь зробити коротке замикання в приладі для батарей.

HR

Važne obavijesti o bateriji

Nikada nemoj koristiti različite vrste baterija zajedno, isto tako ni kombinaciju starih i novih baterija. Uvijek izvadite baterije ako dugo nećeš koristiti proizvod ili ako su one potrošene. Nikada nemoj koristiti oštećene baterije. Koristi samo preporučenu vrstu ili odgovarajuću vrstu baterija. Umetni baterije pazeći da dobro okreneš polove. Akumulatorske se baterije moraju puniti uz pomoć propisanog punjača i uz nadzor odrasle osobe. Baterije se ne smiju puniti dok su još u proizvodu i to nikada nemoj pokušavati. Nikada ne pokušavaj puniti baterije koje nisu predviđene za punjenje. Nikada ne izazivaj kratki spoj u držaču baterija.

SR

Важне информације о батеријама

Nikada ne koristite različite tipove baterija zajedno niti kombinaciju starih i novih baterija. Uvek izvadite baterije ukoliko proizvod neћete duće vreme koristiti ili ukoliko su baterije prazne. Nikada ne koristite ošteћene baterije. Upotrebljavajte samo preporuћeni tip baterija ili odgovarajuћu zmenu. Stavite baterije tako da su polovi pravilno pozicionisani. Baterije na punjeње se moraju puniti odgovarajuћim punjačem pod nadzorom odraslog lića. Niје moguće puniti baterije dok su u proizvodu i nikad ne pokušavajte da radite to. Nikada ne pokušavajte da punitе baterije koje ne mogu da се pune. Nikada ne izazivajte kratak spoj у kuћишту за baterije.

МК

Важни информации за батериите

Nikogash ne koristete različni tipovi baterii zaедно или комбинација од стари и нови батерии. Seкогаш отстранувајте ги батериите доколку не го користите производот подолго време или доколку се потрошеле. Nikogash не користете оштетени батерии. Користете ги само препорачаните батерии или батерии од соодветен тип. Вметнете ги батериите така што точно ќе ги наместите половите. Батериите на полнење мора да се полнат со соодветниот полнач под надзор на возрасно лице. Не може да ги полните батериите додека сè уште се наоѓаат во производот и никогаш не смеете да го правите тоа. Nikogash не обидувајте се да ги полните батериите за еднократна употреба. Nikogash не предизвикувајте краток spoj на држачот за батерии.

SL

Pomembne informacije o baterijah

Nikoli ne uporabljate skupaj različnih baterij ali kombinacije starih in novih baterij. Vedno odstranite baterije, če izdelka dlje časa ne boste uporabljali ali če so iztrošene. Nikoli ne uporabljajte poškodovanih baterij. Uporabljajte le baterije priporočene ali ustrezne tipa. Baterije vstavite tako, da so njihovi poli pravilno obrnjeni. Akumulatorske baterije je treba polniti s pravim polnilnikom pod nadzorom odrasle osebe. Akumulatorskih baterij ni mogoče polniti, dokler so še v izdelku. Tega tudi ne smete poskušati. Nikoli ne poskušajte polniti baterij, ki niso akumulatorske. Pazite, da ležišč za baterije ne boste spravili v kratek stik.

RO

Informații importante despre baterii

Nu folosiți niciodată împreună tipuri diferite de baterii, sau o combinație de baterii vechi și noi. Îndepărtați întotdeauna bateriile dacă produsul nu este folosit timp îndelungat sau dacă bateriile s-au epuizat. Nu folosiți niciodată baterii deteriorate. Folosiți numai baterii de tipul recomandat, sau un tip corespunzător. Introduceți bateriile astfel ca poli să fie poziționați corect. Bateriile reincărcabile trebuie reincărcate utilizând încărcătorul corect sub supravegherea unui adult. Nu puteți reincărca bateriile în timp ce acestea sunt încă în produs, și niciodată nu trebuie să încercați să faceți acest lucru. Nu încercați niciodată să reincărcati baterii nereincărcabile. Nu scurcircuitați niciodată suportul bateriilor.

BG

Важна информация за батериите

Никога не използвайте едновременно различни типове батерии или комбинация от стари и нови батерии. Винаги изваждайте батериите, ако izdelkiot няма да се използва продължително време или ако батериите са се изтозили. Никога не използвайте повредени батерии. Използвайте само батерии от препоръчвания тип или съответстващ на него тип. Поставете батериите така, че полюсите да са разположени правилно. Аккумуляторните батерии трябва да се зареждат с подходящо зареждащо устройство под надзора на възрастни. Батериите не могат да се зареждат, докато са поставени в izdelkiot, затова никога не опитвайте да правите това. Никога не опитвайте да зареждате батерии, които не са акумулаторни. Никога не свързвайте на късо контактите на отделението за батериите.

LV
Saglabājiet šo brošūru, jo tajā ir sniegta svarīga informācija.

Svarīga informācija par baterijām

Nekad vienlaikus nelietojiet dažādu tipu, kā arī vecas un jaunas baterijas. Vienmēr izņemiet baterijas, ja tās ir izlādējušas vai ja produkts ilgāku laiku netiek lietots. Nekad nelietojiet bojātas baterijas. Lietojiet tikai ieteicamā tipa vai atbilstoša tipa baterijas. Ievietojot baterijas, ievērojiet pareizu polaritāti. Uzlādējamu bateriju lādēšanai izmantojiet atbilstošu bateriju lādētāju; uzlāde jāveic pieaugušo uzraudzībā. Baterijas nevar uzlādēt un nekad nedrīkst mēģināt uzlādēt, kamēr tās ievietotas produktā. Nekad nemēģiniet uzlādēt baterijas, kas nav uzlādējamās. Nepieļaujiet issavienojumu bateriju nodalījumā.

ET

Oluline teave patareide kohta

Ära kunagi kasuta koos erinevat tüüpi patareisid, samuti vanu ja uusi patareisid. Kui märguasja ei kasutata pika aja jooksul, võta patarei sellest välja. Ära kunagi kasuta kahjustatud patareisid. Kasuta ainult ettenähtud tüüpi või nendega samaväärseid patareisid. Pane patareid märguasja sisse nii, et pluss- ja miinusklemmi asend oleks õige. Akusid tuleb laadida ainult neile ettenähtud akulaadija abil täiskasvanu järelevalve all. Akusid ei saa laadida sel ajal, kui need on märguasja sees. Ära kunagi püüa nii teha. Ära kunagi proovi akulaadijaga laadida tavalisi patareisid. Patareipesa klemmide vahel ei tohi tekkida lühisid.

LT

Svarbi informacija apie elementus

Vienu metu nenaudokite skirtingų elementų, taip pat su naujais elementais nenaudokite senų. Jei nenaudosite gaminio ilgesnį laiką arba jei elementai išseko, visomet išimkite juos iš gaminio. Niekada nenaudokite pažeistų elementų. Naudokite tik rekomenduojamo arba atitinkamo tipo elementus. Elementus dėkite atsižvelgdami į jų poliškumą. Elementus galima įkrauti tik tinkamu krovikliu ir prižiūrint suaugusiesiems. Jokių būdu negalima, ir niekuomet nebandykite, įkrauti elementų neišėmus jų iš gaminio. Niekada nebandykite įkrauti vienkartinių elementų. Saugokitės, kad elementų įdėkle nesukeltumėte trumpojo jungimo.

TR

Piller hakkında önemli bilgiler

Hiçbir zaman farklı tipte pilleri ya da eski pillerle yeni pilleri bir arada kullanmayın. Ürün uzun süre kullanılmayacaksa ya da piller bitmişse, pilleri ürünün içinden çıkarın. Hiçbir zaman zedelenmiş piller kullanmayın. Sadece önerilen tipte piller ya da bunların dengi olan piller kullanın. Pilleri kutupları doğru konumda olacak şekilde yerleştirin. Şarj edilebilen pilleri doğru pil şarj aletini kullanarak, bir yetiştikinin denetiminde şarj edin. Şarj edilebilen pilleri, pil ürünün içindeyken şarj edemezsiniz bunu hiçbir zaman yapmaya çalışmayın. Hiçbir zaman, şarjlı olmayan pilleri şarj etmeye çalışmayın. Hiçbir zaman pil kutusuna kısa devre yaptırmayın.

AR

معلومات مهمة عن البطاريات

يُحظَر استخدام أنواع مختلفة من البطاريات معًا أو مزيج من البطاريات القديمة والجديدة. احرص دائمًا على نزع البطاريات في حال عدم استخدام المنتج لفترة طويلة أو إذا نفذت طاقة البطاريات. تجنب استخدام البطاريات التالفة. لا تستخدم إلا نوع البطاريات الموصى به أو نوعًا مماثلاً. قم بتركيب البطاريات بحيث تكون الأقطاب في موضعها الصحيح. يجب إعادة شحن البطاريات القابلة لإعادة الشحن باستخدام شاحن البطاريات المناسب وذلك تحت إشراف شخص بالغ. لا يمكنك إعادة شحن البطاريات وهي لا تزال داخل المنتج. ويجب ألا تجرب فعل ذلك. يُحظَر إعادة شحن البطاريات غير القابلة لإعادة الشحن. تجنب إحداث دائرة قصر في حامل البطارية.

ID

Informasi penting tentang baterai

Jangan gunakan baterai yang jenisnya berlainan, atau mencampur baterai lama dan baterai baru. Lepas baterai jika produk tidak akan digunakan untuk waktu lama atau jika baterai sudah lemah. Jangan gunakan baterai yang rusak. Gunakan jenis baterai yang dianjurkan atau yang sejenis. Masukkan baterai dengan posisi kutub yang tepat. Baterai isi ulang harus diisi ulang dengan charger baterai yang sesuai dan di bawah pengawasan orang dewasa. Anda tidak dapat mengisi ulang baterai saat masih terpasang di dalam produk, dan jangan pernah coba melakukannya. Jangan pernah coba mengisi ulang baterai biasa. Jangan pernah membuat arus pendek pada dudukan baterai.

MS

Maklumat penting tentang bateri

Jangan guna jenis bateri yang berbeza bersama-sama, atau gabungan bateri baharu dan lama. Tanggalkan bateri jika produk tidak akan digunakan untuk tempoh masa yang lama atau jika bateri telah kehabisan kuasa. Jangan guna bateri yang rosak. Hanya guna jenis bateri yang disyorkan, atau jenis yang berkaitan. Masukkan bateri supaya paksi berada pada kedudukan yang betul. Bateri yang boleh dicaskan semula perlu dicas semula dengan menggunakan pengecas bateri yang betul bawah pengawasan orang dewasa. Anda tidak boleh mengecap bateri semasa bateri masih berada pada produk, dan anda jangan cuba berbuat demikian. Jangan cuba untuk mengecap semula bateri yang tidak boleh dicaskan semula. Jangan pintas litar pemegang bateri.



EN
Protect the environment by not disposing of this product with your household waste.
Check with your local authority for recycling advice and facilities.

DE
Schützen Sie die Umwelt und entsorgen Sie dieses Produkt nicht mit Ihrem Hausmüll.
Informationen zu Recycling-Möglichkeiten erhalten Sie bei den örtlichen Behörden.

FR
Protégez l'environnement : ne jetez pas ce produit avec vos autres déchets ménagers.
Contactez les autorités locales pour obtenir des informations sur le recyclage et connaître les points de collecte.

IT
Proteggi l'ambiente! Non smaltire questo prodotto con i rifiuti domestici.
Per consulenza sul riciclaggio dei rifiuti e le strutture di riciclaggio, rivolgersi alle proprie autorità locali.

NL
Bescherm het milieu: gooi dit product niet samen met het andere huisvuil weg.
Raadpleeg de plaatselijke instanties voor locaties van milieustations en advies over hergebruik.

ES
Proteja el medio ambiente no deshaciéndose de este producto junto con sus residuos domésticos.
Solicite asesoramiento e información sobre instalaciones de reciclaje a las autoridades locales.

DA
Beskyt miljøet! Smid ikke dette produkt ud sammen med husholdningsaffaldet.
Få vejledning om genbrug og genbrugsstationer hos din kommune.

IS
Stuðlið að umhverfisvernd með því að farga þessari vöru ekki með heimilissorpi.
Leitið upplýsinga um endurvinnslu- og förgunarstaði hjá yfirvöldum á hverjum stað.

FI
Tämä tuote on hävitettävä ympäristöstävällisesti ja erillään muusta talousjätteestä.
Tietoja kierrätyksestä ja keräyspisteiden sijainnista saat paikkakuntasi teknisestä virastosta.

SV
Skydda miljön genom att inte kasta denna produkt bland ditt hushållsavfall.
Kontakta din kommun för frågor om återvinning och miljöstationer.

NO
Beskytt miljøet. Ikke kast dette produktet i husholdningsavfallet.
Kontakt kommunen for veiledning om gjenbruk og miljøstasjoner.

PT
Proteja o ambiente não eliminando este produto com o seu lixo doméstico.
Consulte as autoridades locais para informação sobre reciclagem e sistemas de recolha.

EL
Προστατέψτε το περιβάλλον. Μην πετάτε αυτό το προϊόν μαζί με τα συνηθισμένα οικιακά απορρίμματα.
Επικοινωνήστε με τις τοπικές αρχές σχετικά με συμβουλές και εγκαταστάσεις ανακύκλωσης.

JA
環境保護のため、本製品は家庭ごみとは別に処分してください。
リサイクルに関する指示や施設については、お住まいの地方自治体にお問い合わせください。

ZH
注意保护环境，请勿将本产品与生活垃圾一起丢弃处理。
请咨询当地相关部门，了解与回收相关的设施与建议。

KO
환경 보호를 위해 이 제품을 생활폐기물과 함께 버리지 마십시오.
재활용 방법 및 시설에 관한 사항은 현지 관계 당국에 문의하십시오.

RU
Позаботьтесь об окружающей среде: не утилизируйте этот продукт вместе с бытовым мусором.
Узнайте в органах местного самоуправления правила вторичной переработки и утилизации таких отходов.

PL
Aby chronić środowisko naturalne, nie należy wyrzucać tego produktu wraz z odpadkami z gospodarstwa domowego.
W celu uzyskania wskazówek dotyczących recyklingu oraz adresów zakładów należy skontaktować się z lokalnym urzędem.

CZ
Nevyhadzujte tento produkt do domácího odpadu, chráňte životní prostředí.
Zjistěte si prosím u místních úřadů možnosti recyklace a dostupná zařízení.

SK
Nevyhadzujte tento produkt do domáceho odpadu, chráňte životné prostredie.
Zistite si na miestnych úradoch možnosti recyklácie a dostupné zariadenia.

HU
Környezetét óvja, ha ettől a terméktől nem a háztartási hulladékkal együtt válik meg.
Érdeklődjék a lakóhelyéhez közel eső hatóságnál az újrahasznosítás módjáról és lehetőségeiről.

UA
Допоможіть захистити довкілля: не утилізуйте цей виріб разом із побутовим сміттям.
Вказівки з утилізації та відомості про пункти прийому з'ясуєте в місцевих компетентних органах.

HR
Zaštite okoliš tako da ovaj proizvod ne odložite u otpad zajedno s kućanskim otpadom.
Od lokalnih vlasti zatražite savjet ili informacije o pogonima za recikliranje.

SR
Zaštittite životnu sredinu tako što nećete da odlažete ovaj proizvod sa kućnim otpadom.
Raspitajte se kod lokalnog nadležnog organa o načinu reciklaže i o sabirnom centru.

MK
Zaštittite ja okolinata taka što nema da se oslobodite od proizvodot od domashniot otpad.
Konultirajte se so lokalnite vlasti za da doznaete za sovetite i objektite za recikliranje.

SL
Zaščitite okolje! Okolje varujte tako, da tega izdelka ne zavržete skupaj z gospodinjiskimi odpadki.
Pri krajevni upravi preverite, kakšne možnosti in kateri obrati za recikliranje obstajajo v vaši okolici.

RO
Protejați mediul înconjurător și nu vă debarasați de acest produs împreună cu deșeurile menajere
Consultați autoritățile locale pentru îndrumări și facilități de reciclare.

BG
Защитете околната среда и не изхвърляйте този продукт заедно с битовите си отпадъци.
Свържете се с местните власти относно съвети и съоръжения за рециклиране.

LV
Lai saudzētu vidi, neizmetiet šo izstrādājumu kopā ar sadzīves atkritumiem.
Vērsieties vietējās varas iestādēs, lai noskaidrotu, kur un kā tas nododams pārstrādei.

ET
Keskkonda saate kaitsta nii, et ei kõrvalda seda toodet koos olmejäätmetega.
Nõuandeid toote taaskasutusse võtmise ja ümbertöötlemispunktide kohta saate asjaomaselt kohalikult asutuselt.

LT
Saugokite aplinką: nemeskite šio produkto kartu su buitinėmis atliekomis.
Atsižvelkite į savo vietos valdžios rekomendacijas dėl pakartotinio panaudojimo ir sąlygas.

TR
Bu ürünü, evsel atıklarla birlikte atmayarak çevreyi koruyun.
Gerİ dönüşüm tavsiyeleri ve tesisler hakkında bilgi için yerel yönetimle iletişim kurun.

AR
احم البيئة بعدم التخلص من هذا المنتج مع الخلفات المنزلية.
استشر السلطة المحلية لديك للحصول على نصح بخصوص إعادة تدوير الخلفات ومرافقها.

ID
Jagalah lingkungan dengan tidak membuang produk ini bersama sampah rumah tangga Anda.
Periksa peraturan pemerintah setempat tentang saran dan fasilitas daur ulang.

MS
Lindungi alam sekitar dengan tidak melupuskan produk ini bersama sisa isi rumah anda.
Rujuk pihak berkuasa tempatan anda tentang nasihat dan kemudahan kitar semula.



EN
WARNING: This product contains a Button Cell Battery.
Dispose of used batteries immediately. Keep new and used batteries away from children.
If you think batteries might have been swallowed or placed inside any part of the body, seek immediate medical attention.

DE
ACHTUNG: Dieses Produkt enthält eine Knopfzellenbatterie.
Entsorge umgehend gebrauchte Batterien. Halte neue und gebrauchte Batterien von Kindern fern.
Wenn du glaubst, dass Batterien verschluckt wurden oder sich in einem Körperteil befinden, hole umgehend medizinische Hilfe.

FR
AVERTISSEMENT : Ce produit contient une pile bouton.
Jeter immédiatement les piles usagées. Conserver les piles neuves et usagées hors de portée des enfants.
Si vous suspectez l'ingestion d'une pile ou sa présence où que ce soit à l'intérieur du corps, consultez immédiatement un médecin.

IT
ATTENZIONE: questo prodotto contiene una batteria a bottone.
Smaltire immediatamente le batterie usate. Tenere le batterie nuove e usate lontano dai bambini.
Se si pensa che una batteria sia stata inghiottita o inserita in una parte del corpo, rivolgersi immediatamente a un medico.

NL
WAARSCHUWING: dit product bevat een knoopcelbatterij.
Gooi gebruikte batterijen onmiddellijk weg. Bewaar nieuwe en gebruikte batterijen buiten bereik van kinderen.
Als je denkt dat een kind batterijen heeft ingeslikt of ze in een lichaamsopening heeft gestopt, raadpleeg je direct een arts.

ES
ADVERTENCIA: Este producto contiene una pila de botón.
Las pilas usadas deben desecharse inmediatamente. Mantenga las pilas nuevas y usadas fuera del alcance de los niños.
Si sospecha de la ingestión o la introducción de pilas en cualquier parte del cuerpo, busque atención médica inmediatamente.

DA
ADVARSEL: Dette produkt indeholder et knapcelbatteri.
Bortskaf brugte batterier omgående. Hold både nye og brugte batterier uden for børns rækkevidde.
Hvis du har mistanke om, at batterierne kan være blevet slugt eller kommet ind i nogen del af kroppen, skal du omgående søge lægehjælp.

IS
VIÐVÖRUN: Þessi vara inniheldur hnapparafhlöðu.
Fargið notuðum rafhlöðum tafarlaust. Geymið nýjar og notaðar rafhlöður þar sem börn ná ekki til.
Ef þú telur að rafhlöður hafi verið gleyptar eða á annan hátt komist inn í einhvern hluta líkamans skaltu tafarlaust leita læknaaðstoðar.

FI
VAROITUS: Tämä tuote sisältää nappipariston.
Käytetyt paristot on toimitettava heti keräyspisteeseen. Pidä uudet ja käytetyt paristot poissa lasten ulottuvilta.
Jos epäilet jonkun nieläisseen pariston tai laittaneensa pariston kehoonsa, vie hänet välittömästi lääkäriin.

SV
VARNING: Denna produkt innehåller ett knappcells batteri.
Kassera förbrukade batterier omedelbart. Förvara nya och använda batterier utom räckhåll för barn.
Om du tror att batterierna kan ha svalts eller placerats inuti någon del av kroppen, sök omedelbart läkarvård.

NO
ADVARSEL: Dette produktet inneholder et knappcellebatteri.
Brukte batterier skal avhendes øyeblikkelig. Nye og brukte batterier skal oppbevares utilgjengelig for barn.
Hvis du tror at batterier har blitt svelget eller puttet inn andre steder i kroppen, må du kontakte lege øyeblikkelig.

PT
AVISO: Este produto contém uma pilha tipo botão.
Elimine as pilhas usadas imediatamente. Mantenha as pilhas novas e usadas fora do alcance das crianças.
Se pensa que as pilhas podem ter sido engolidas ou colocadas no interior de alguma parte do corpo, procure de imediato assistência médica.

EL
ΠΡΟΕΙΔΟΠΟΙΗΣΗ: Αυτό το προϊόν περιέχει μία στρογγυλή μπαταρία μεγέθους κομπόου. Πελάτες αμέσως τις χρησιμοποιημένες μπαταρίες. Κρατήστε τις καινούριες και τις χρησιμοποιημένες μπαταρίες μακριά από τα παιδιά.
Εάν νομίζετε ότι κάποια μπαταρία έχει καταποθεί ή τοποθετηθεί εντός οποιοδήποτε μέρους του σώματος, ζητήστε αμέσως ιατρική βοήθεια.

JA
警告: 本製品には、ボタン型電池が使用されています。
使用済みの電池は直ちに廃棄してください。新しい電池および使用済み電池はどちらもお子様の手の届かないところに保管してください。
電池を誤飲した恐れがある、または電池が身体のどこかに混入した恐れがある場合は、直ちに医師の診察を受けてください。

ZH
警告: 本产品内含一颗纽扣电池。
请立即妥善处理旧电池。请将新、旧电池放置于儿童接触不到的地方。
如果电池被不慎吞下, 或被置入身体的任何一个部位, 请立即就医!

KO
경고: 이 제품에는 버튼 셀 배터리가 포함되어 있습니다.
다 쓴 배터리는 즉시 폐기하십시오. 배터리를 어린이의 손에 닿지 않는 곳에 보관하십시오.
배터리를 삼켰거나 신체 어느 부위에든 들어간 것으로 판단될 경우, 즉각 의사의 도움을 구하십시오.

RU
ПРЕДОСТЕРЕЖЕНИЕ. Эта игрушка работает от батарейки таблеточного типа.
Своевременно утилизируйте использованные батарейки. Храните новые и использованные батарейки в местах, недоступных для детей.
Если у вас есть основания полагать, что ребенок проглотил батарейку или она попала внутрь какой-либо части его тела, немедленно обратитесь за медицинской помощью.

PL
OSTRZEŻENIE: w tym produkcie znajduje się mała okrągła bateria.
Gdy bateria się zużyje, należy się jej natychmiast pozbyć. Nowe i używane baterie należy przechowywać z dala od dzieci.
W przypadku stwierdzenia, że bateria mogła zostać połknięta lub inaczej trafić do organizmu, należy natychmiast poszukać pomocy lekarskiej.

CZ
VAROVÁNÍ: Tento výrobek obsahuje knoflíkovou baterii.
Použité baterie ihned vyjměte a zlikvidujte. Nové i použité baterie uchovávejte mimo dosah dětí.
V případě spolknutí či uviznutí baterie v některé části těla okamžitě vyhledejte lékařskou pomoc.

SK
UPOZORNENIE: Tento produkt obsahuje gombíkovú batériu.
Použité batérie ihneď vyhodte. Nové aj použité batérie uchovávajte mimo dosahu detí.
Ak si myslíte, že mohlo dôjsť k prehltnutiu batérie alebo sa batéria mohla dostať do vnútra ktorejkoľvek časti tela, okamžite vyhľadajte lekársku pomoc.

HU
FIGYELMEZTETÉS: Ez a termék gomebelemet tartalmaz!
Az elhasznált elemeket azonnal dobja ki! Az új és a használt elemeket ne adja gyermekek kezébe!
Ha úgy gondolja, hogy valaki lenyelt egy elemet, vagy bekerült valakinek valamely testrészebe, akkor azonnal kérjen orvosi segítséget!

UA
ОБЕРЕЖНО: Продукт містить батарейку типу «таблетка».
Негайно утилізуйте використані батарейки. Зберігайте нові і використані батарейки недоступними для дітей.
Якщо вам здається, що дитина проковтнула батарейку, чи вона опинилася в будь-якій частині тіла дитини, негайно зверніться до лікаря.

HR
UPOZORENJE: Ovaj proizvod sadrži gumbastu bateriju.
Iskorištene baterije odmah odložite u otpad. Nove i stare baterije čuvajte dalje od djece.
Ako mislite da je baterija progutana ili je dospjela unutar bilo kojeg dijela tijela, odmah zatražite liječničku pomoć.

SR
УПОЗОРЕЊЕ: Овај производ садржи дугмасту батерију.
Одмах одложите искоришћене батерије у отпад. Чувајте нове и искоришћене батерије ван дохвата деце.
Ако мислите да је дошло до гутања батерија или стављања у било који део тела, одмах потражите помоћ лекара.

MK
ПРЕДУПРЕДУВАЊЕ: Овој производ садржи копче-батерија.
Исфрлете ги веднаш искористените батерији. Држете ги новите и користените батерији подалеку од деце.
Ако мислите дека е можно батериите да се прогутани или поставени во кој било дел на телото, веднаш побарајте медицинска помош.

SL

OPOZORILO: Ta izdelek vsebuje gumbasto baterijo.
Iztrošene baterije takoj zavržite. Pazite, da nove ali iztrošene baterije ne bodo v dosegu otrok.
Če menite, da je oseba zaužila baterijo ali si jo vstavila v kateri koli del telesa, takoj poiščite zdravniško pomoč.

RO

AVERTIZARE: Acest produs conține o baterie de tip pastilă.
Debarasați-vă imediat de bateriile uzate. Nu lăsați bateriile noi și uzate la îndemâna copiilor.
Dacă credeți că bateriile ar fi putut fi înghițite, sau ar fi putut ajunge în interiorul oricărei părți a corpului, solicitați imediat asistență medicală.

BG

ПРЕДУПРЕЖДЕНИЕ: Този продукт съдържа батерия тип "копче".
Незабавно изхвърляйте използваните батерии. Дръжте новите и стари батерии далеч от деца.
Ако смятате, че е възможно батериите да са били погълнати или да са попаднали където и да е вътре в тялото, потърсете незабавно медицинска помощ.

LV

BRĪDINĀJUMS. Šis produkts satur pogas tipa akumulatoru.
Nekavējoties izlietotus akumulatorus. Jaunas un lietotas akumulatorus glabājiet bērniem nepieejamā vietā.
Ja uzskatāt, ka akumulators varētu būt norīts vai ievietots kādā ķermeņa daļā, nekavējoties vērsieties pēc medicīniskās palīdzības.

ET

HOIATUS! See toode sisaldab nõõppatareid.
Kõrvaldage kasutatud patareid viivitamatult. Hoidke uusi ja kasutatud patareisid lastele kättesaamatus kohas.
Kui arvate, et keegi on patareid alla neelanud või need on sattunud mõnda kehaosasse, pöörduge kohe arsti poole.

LT

ĮSPĖJIMAS: šiame gaminyje yra sagos formos baterija.
Panaudotas baterijas nedelsdami utilizuokite. Naujas ir panaudotas baterijas laikykite atokiau nuo vaikų.
Jei manote, kad vaikas galėjo praryti arba įsprausti bateriją sau į kūną, nedelsdami kreipkitės medicininės pagalbos.

TR

UYARI: Bu ürün bir düğme pil içerir.
Kullanılmış pilleri derhal atın. Yeni ve kullanılmış pilleri çocuklardan uzak tutun.
Pillerin yutulmuş ya da vücudun başka bir yerine sokulmuş olabileceğini düşünüyorsanız derhal doktora başvurun.

AR

تحذير: يحتوي هذا المنتج على بطارية خلايا فرصية.
يرجى التخلص من البطاريات المستعملة على الفور. مع الاحتفاظ بالبطاريات الجديدة والمستعملة بعيداً عن متناول الأطفال.
إذا كنت تعتقد أن البطاريات تم ابتلاعها أو إدخالها إلى أي جزء من أجزاء الجسم، فاطلب المساعدة الطبية على الفور.

ID

PERINGATAN: Produk ini berisi Baterai Sel Kancing.
Segera buang baterai yang sudah tidak digunakan. Jauhkan baterai baru maupun bekas dari jangkauan anak-anak.
Jika Anda curiga baterai telah tertelan atau berada dalam bagian tubuh, segeralah minta bantuan dokter.

MS

AMARAN: Produk ini mengandungi Bateri Sel Butang.
Buang bateri terpakai dengan serta-merta. Jauhkan bateri baharu dan terpakai daripada kanak-kanak.
Jika anda mendapati bateri mungkin telah ditelan atau termasuk ke dalam mana-mana bahagian badan, dapatkan rawatan perubatan dengan segera.

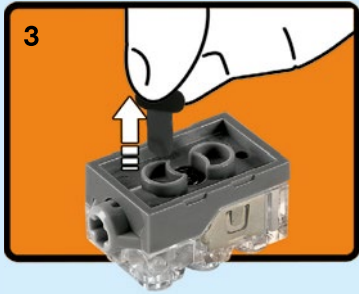
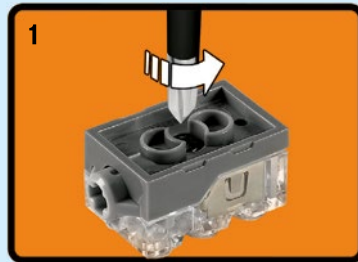

1:1
2x  1.5V

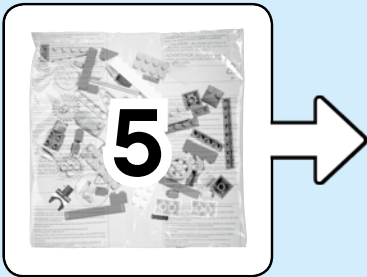
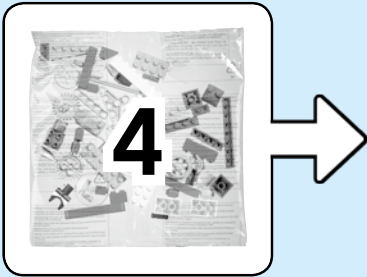
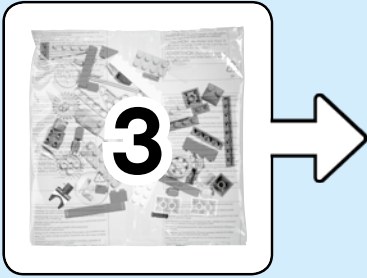
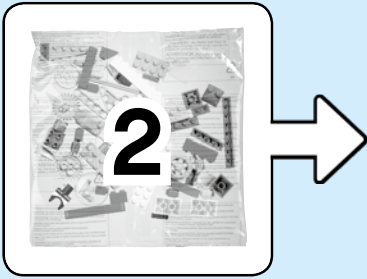

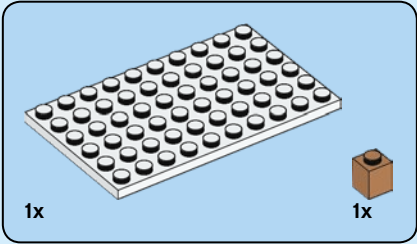
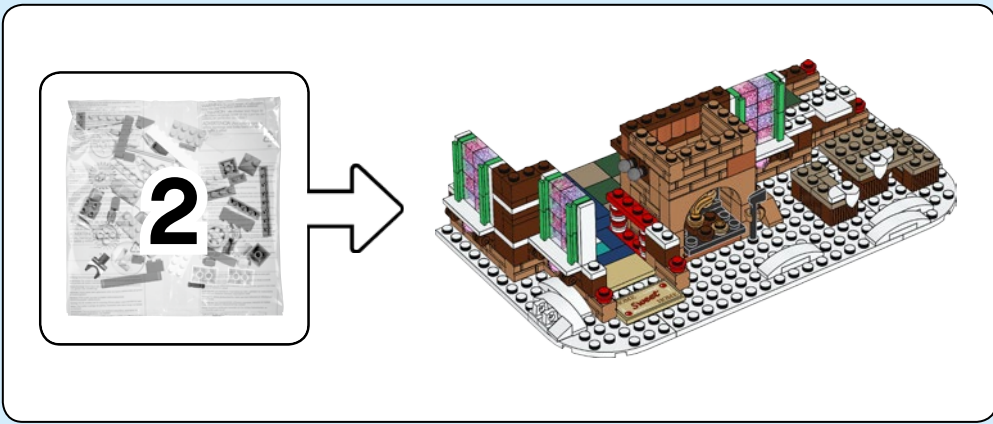

1

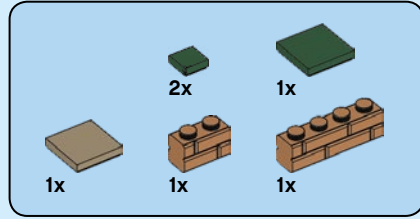
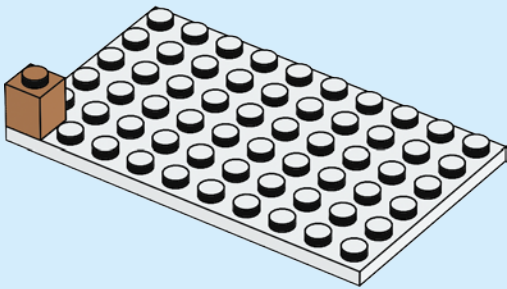

2

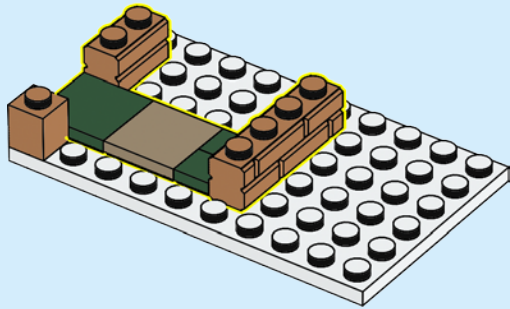

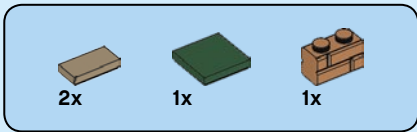

3

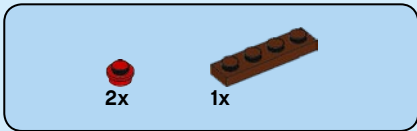
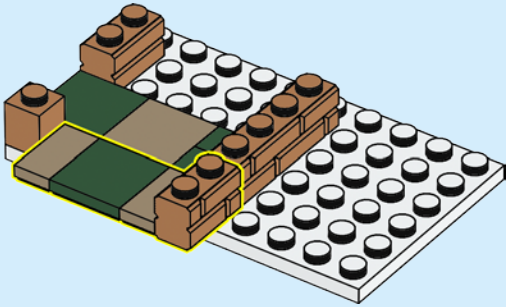

4

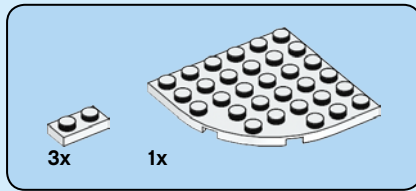
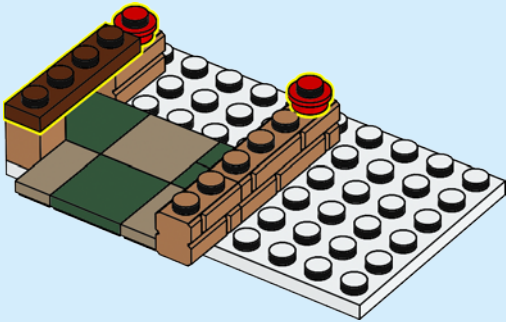

5

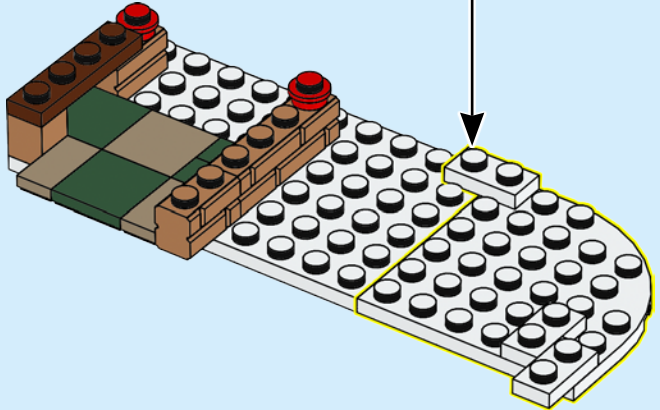
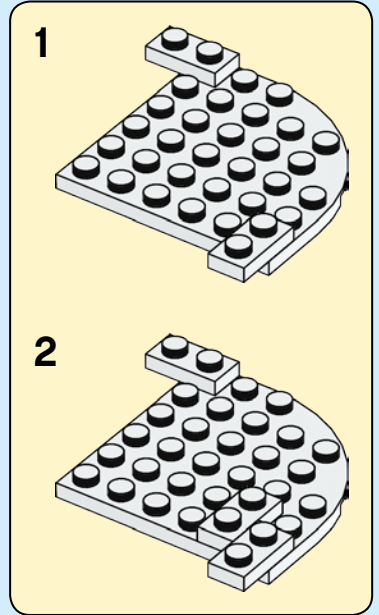

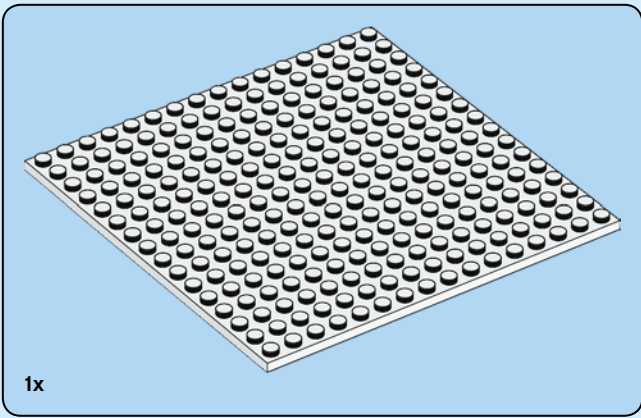

6

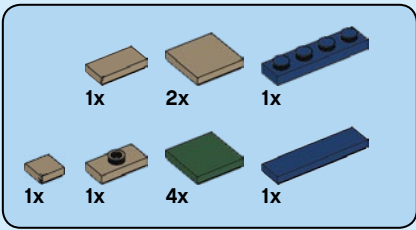
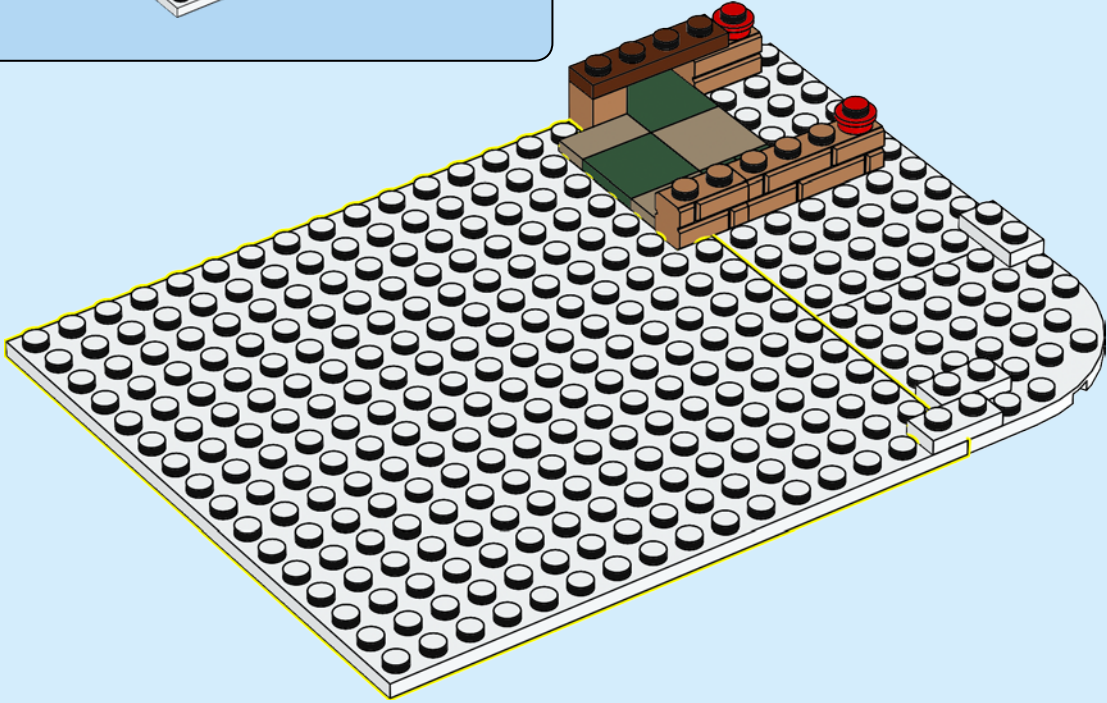

7

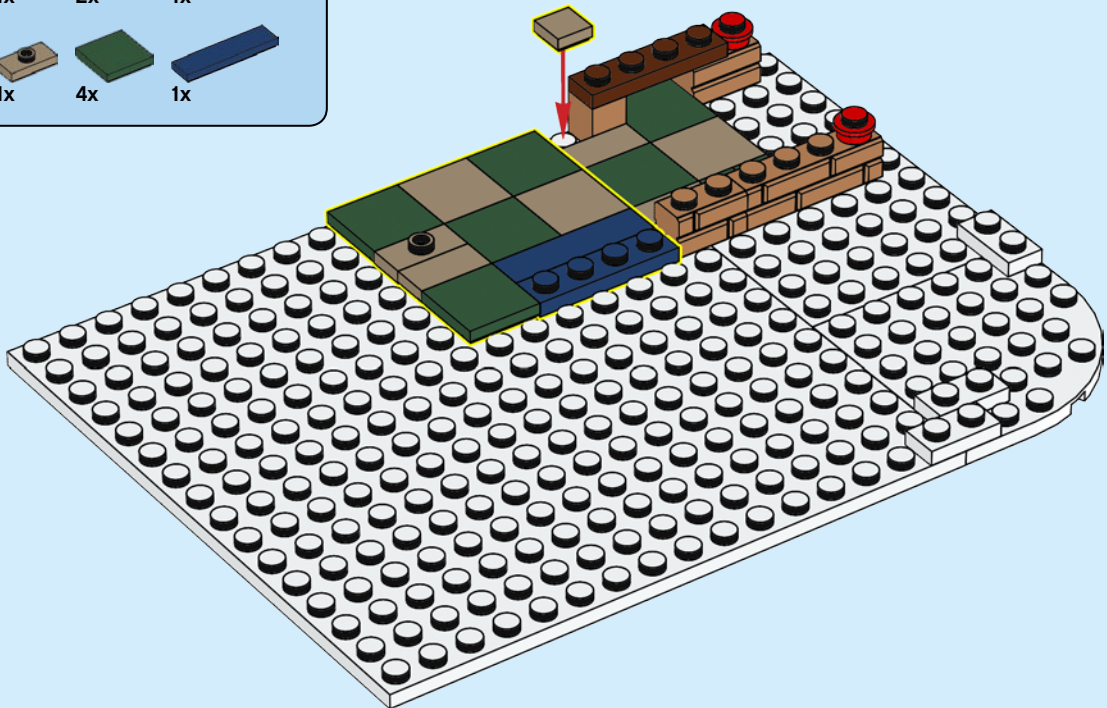

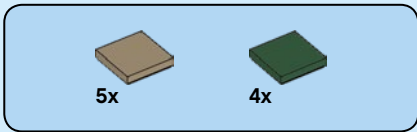

8

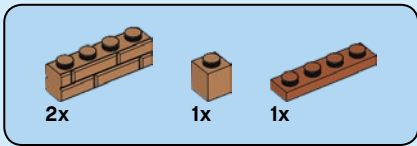
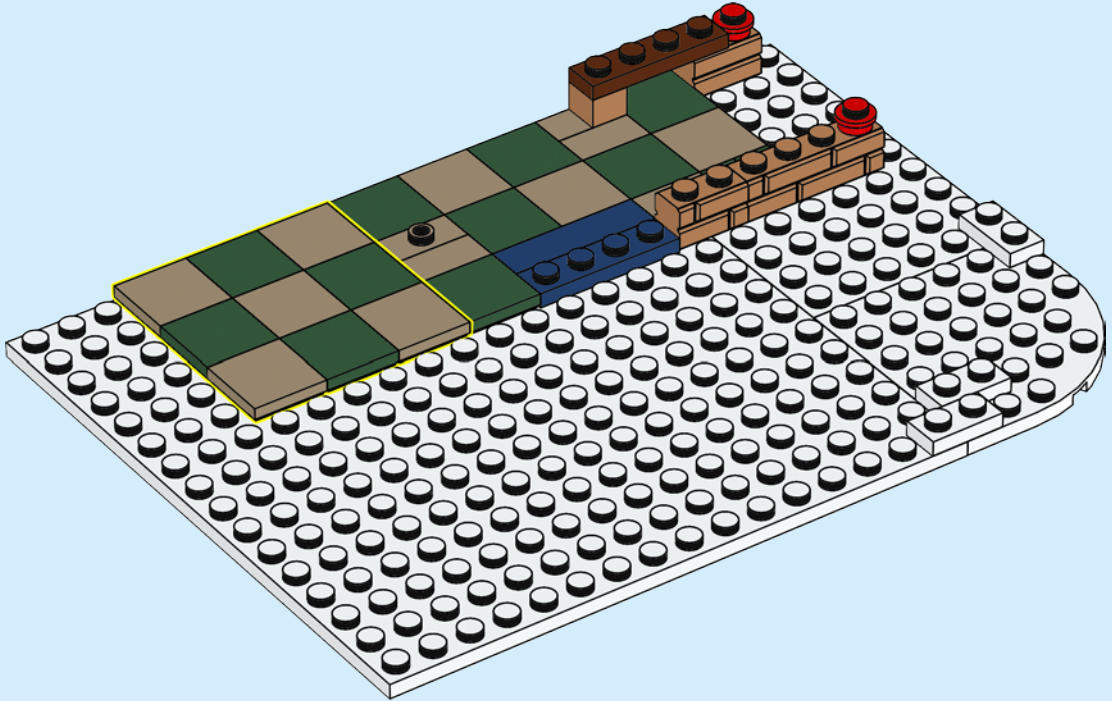

9

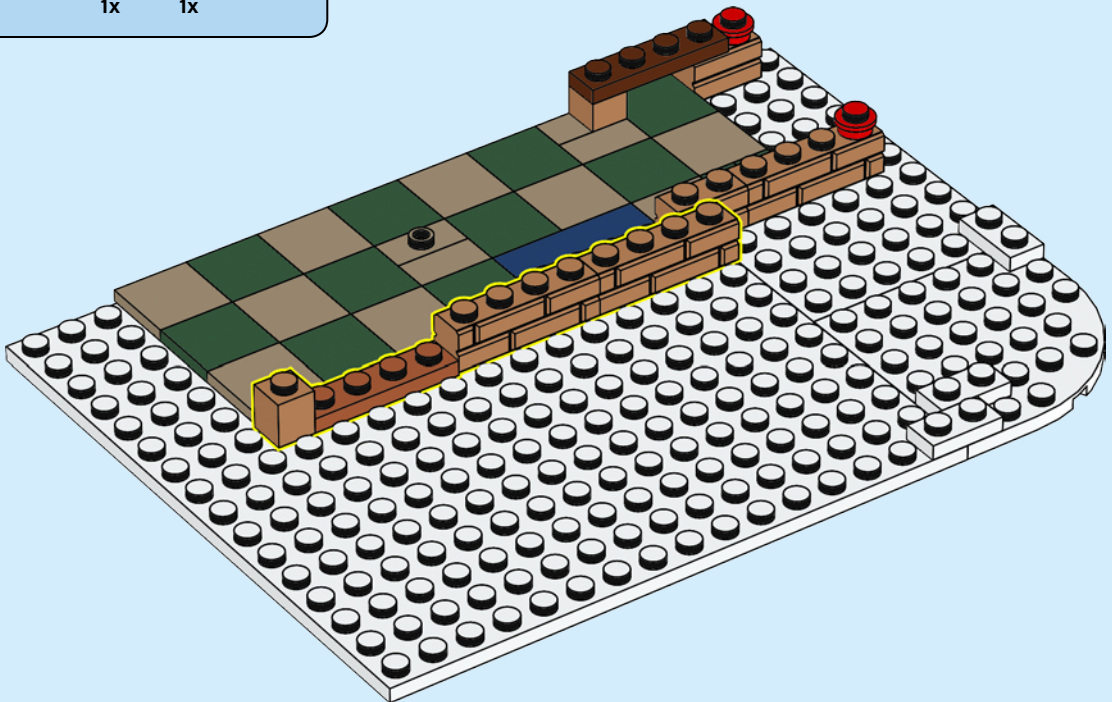

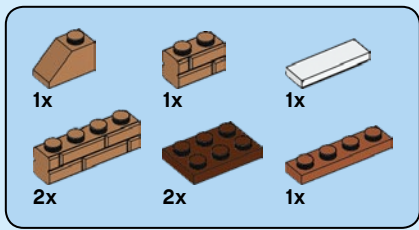

10

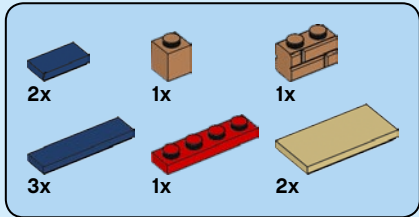
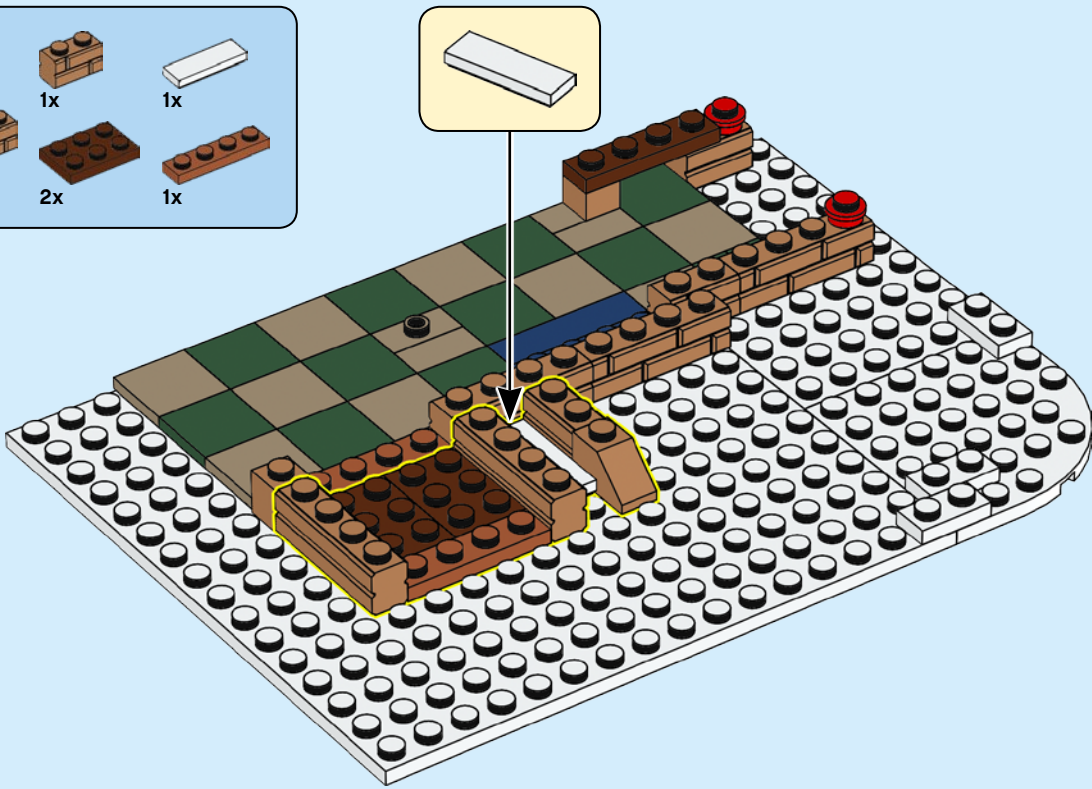

11

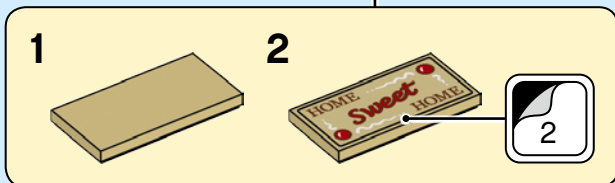
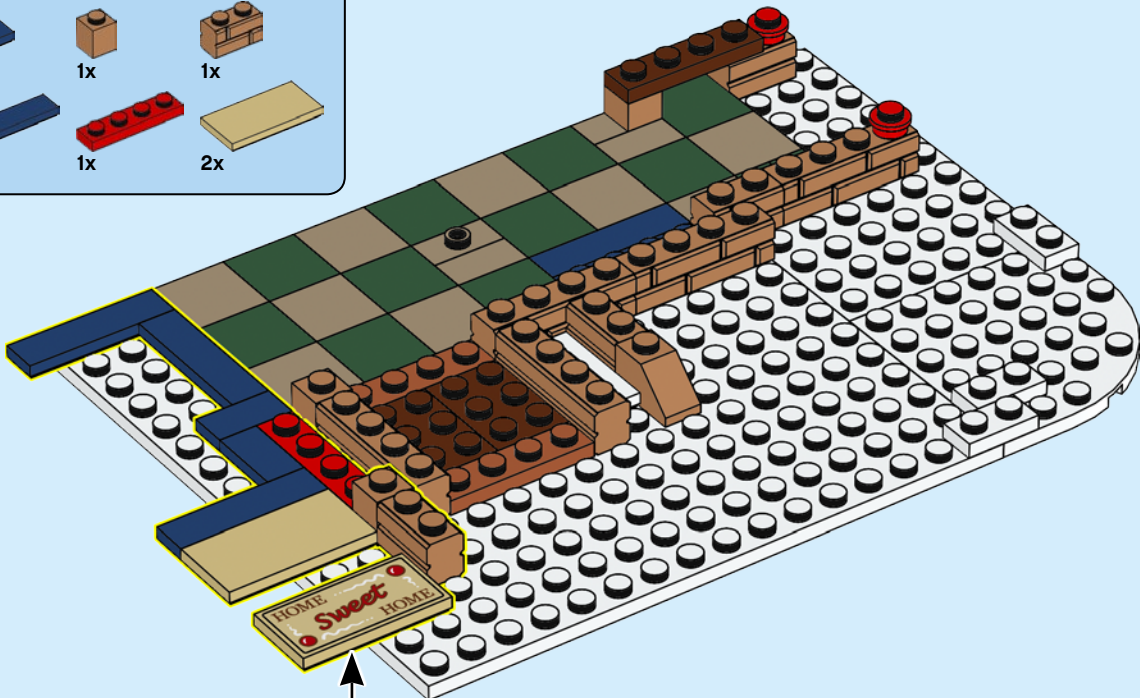

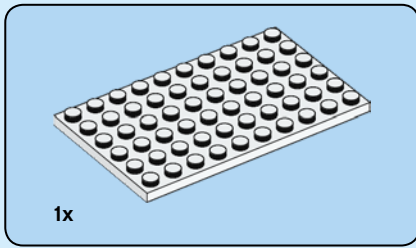

12

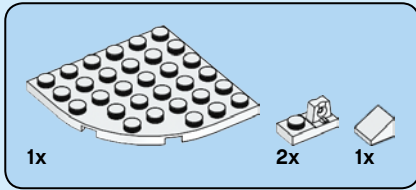
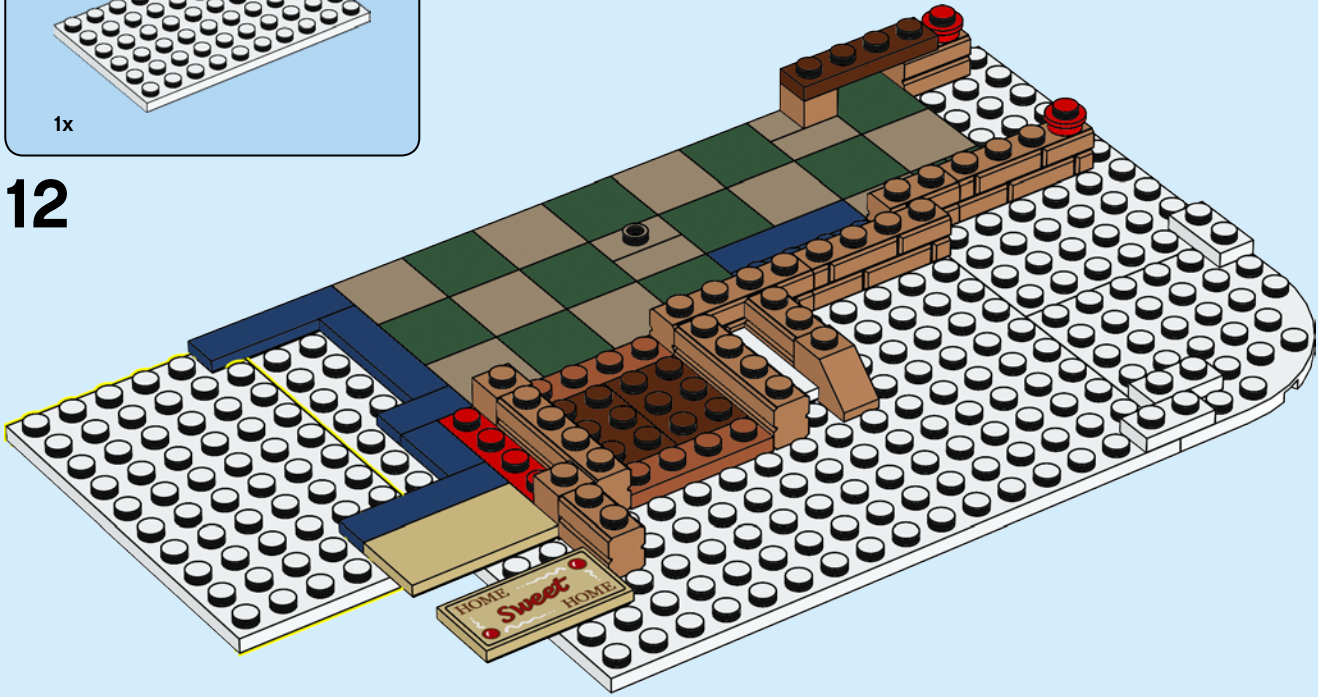

13

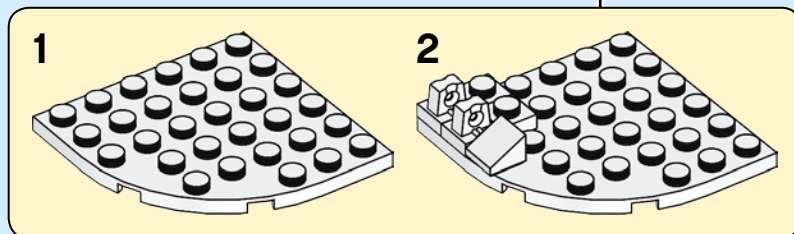
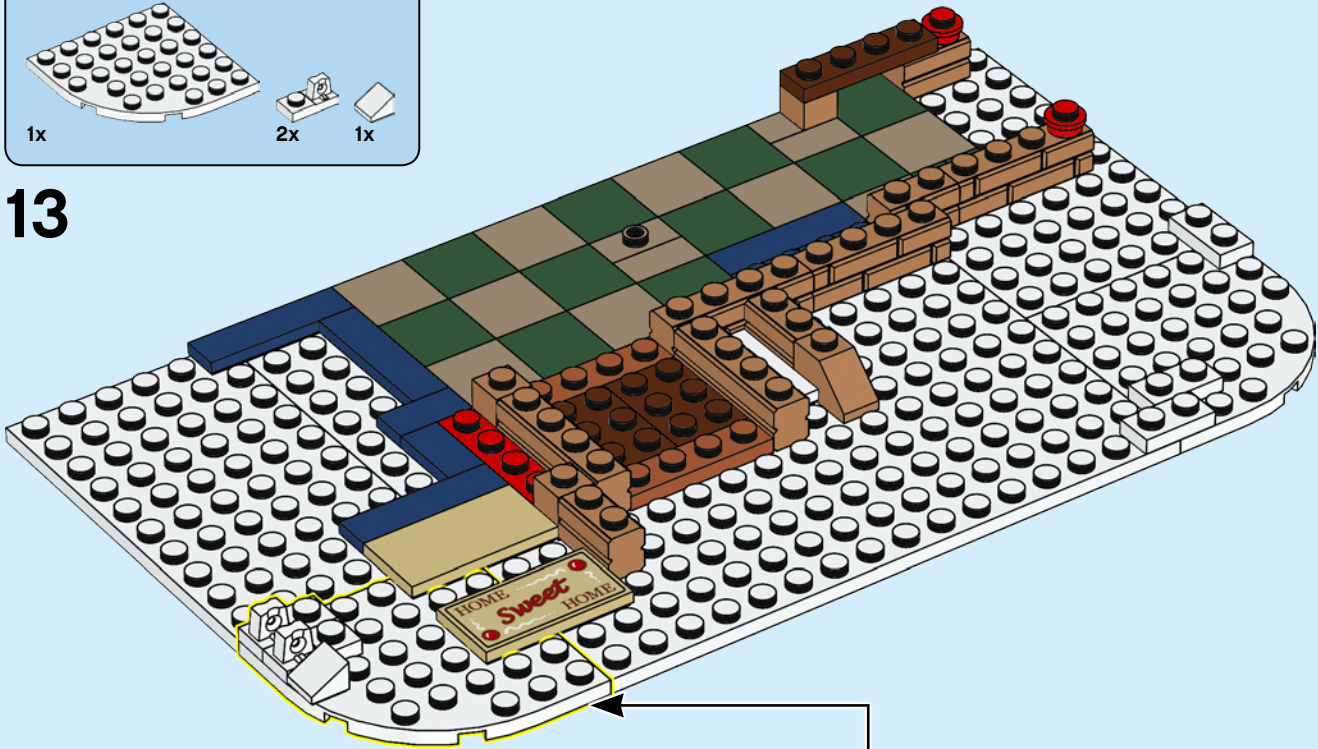

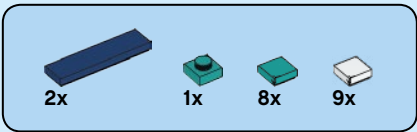

14

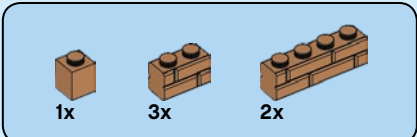
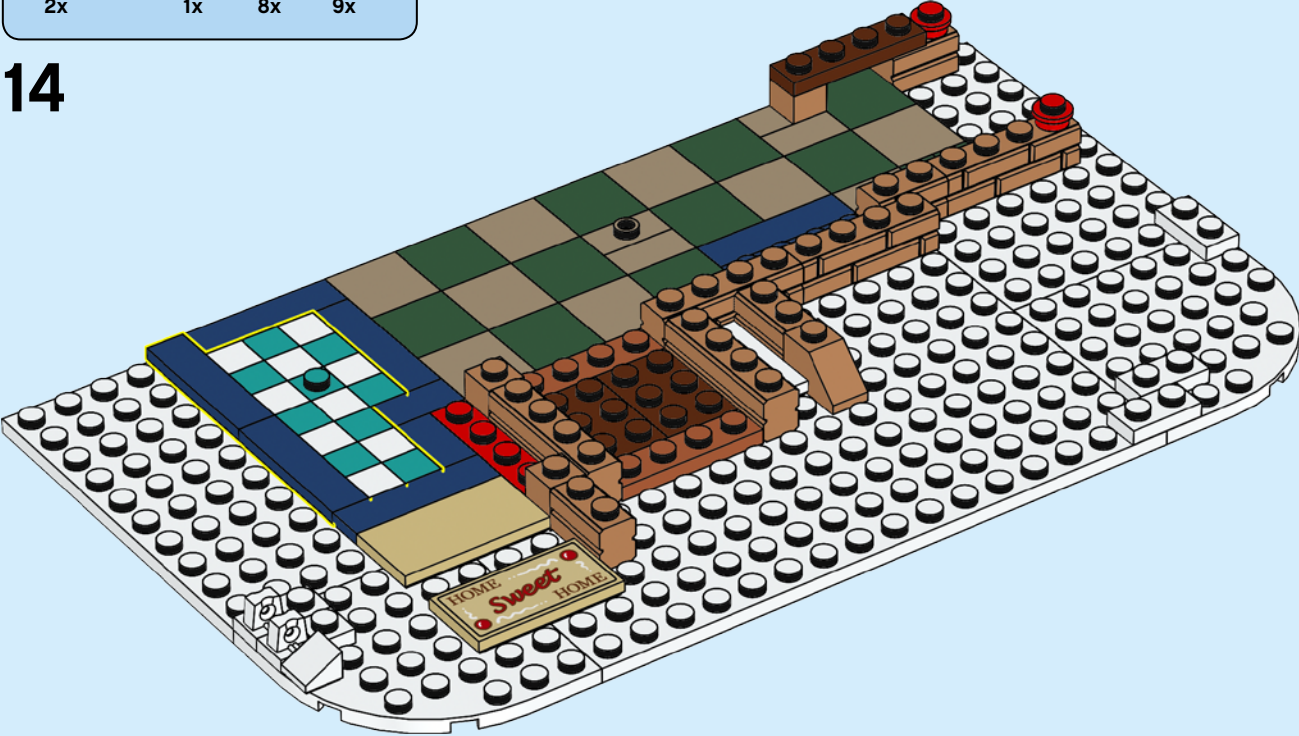

15

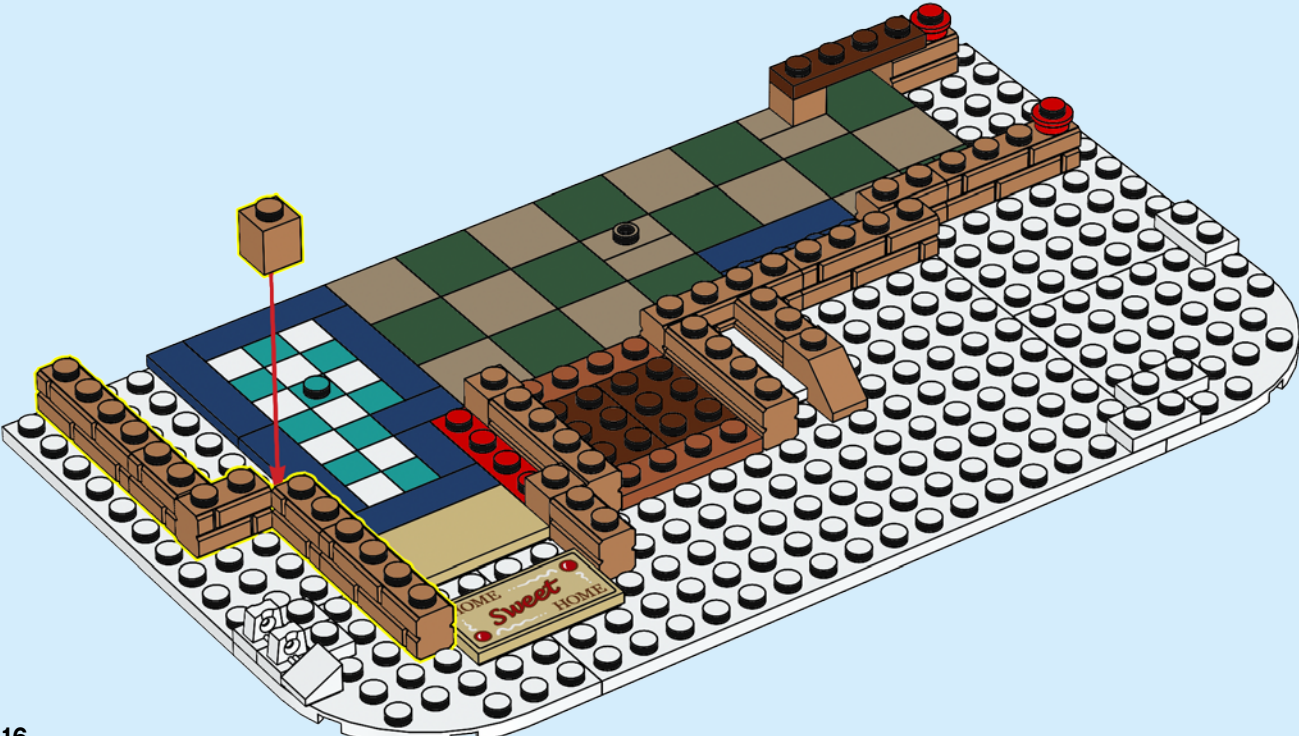

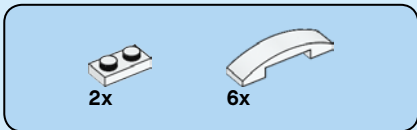

16

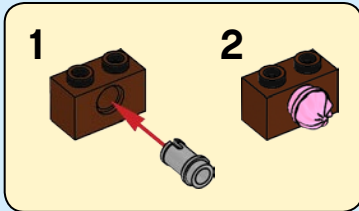
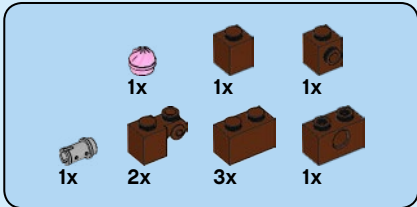
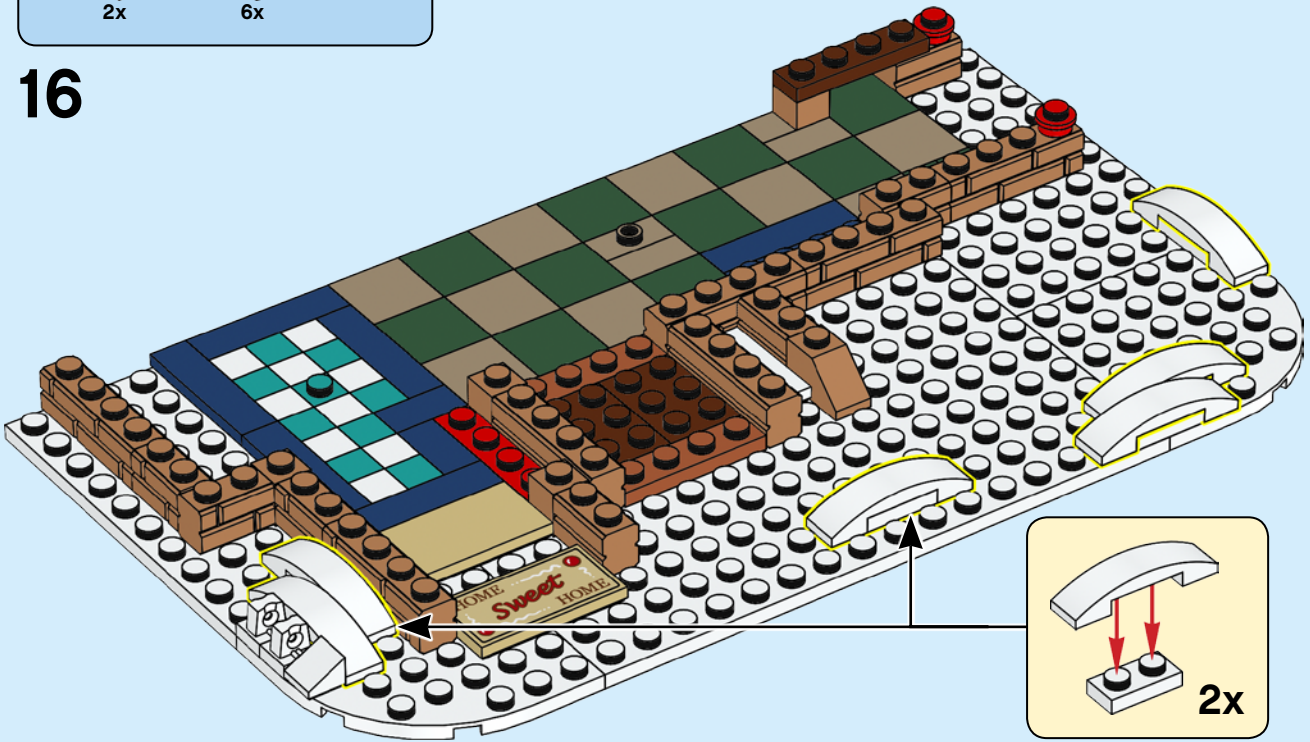

17

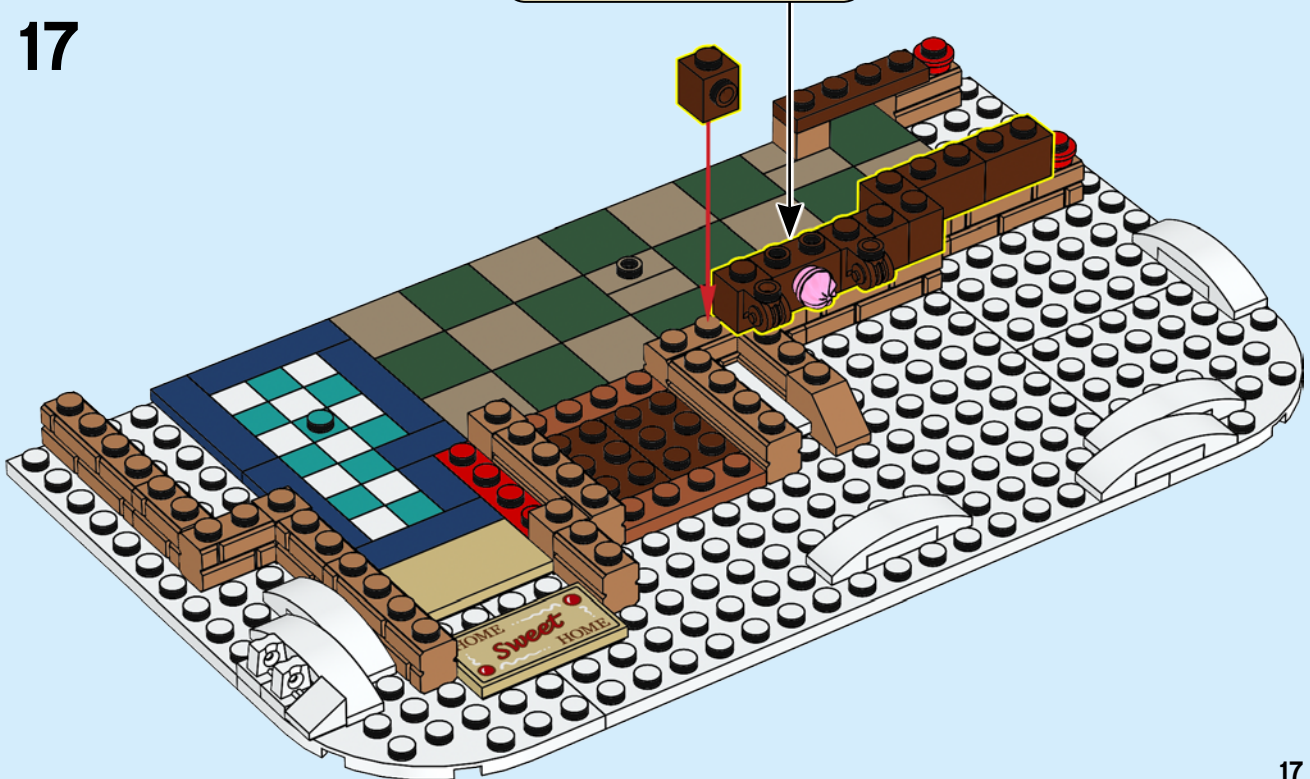

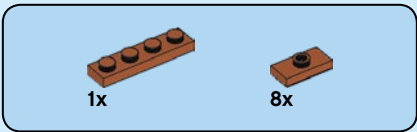

18

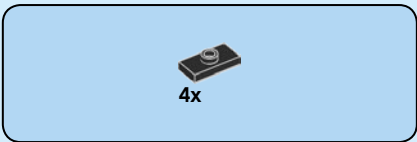
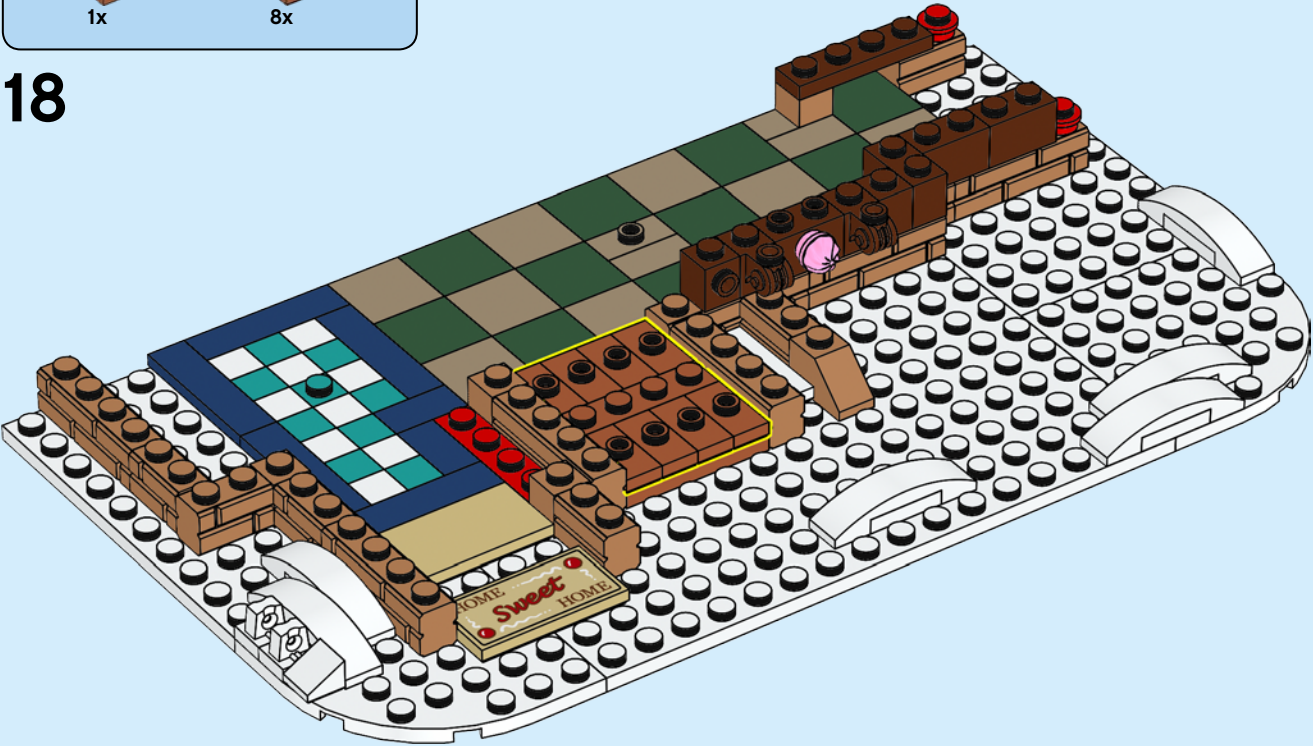

19

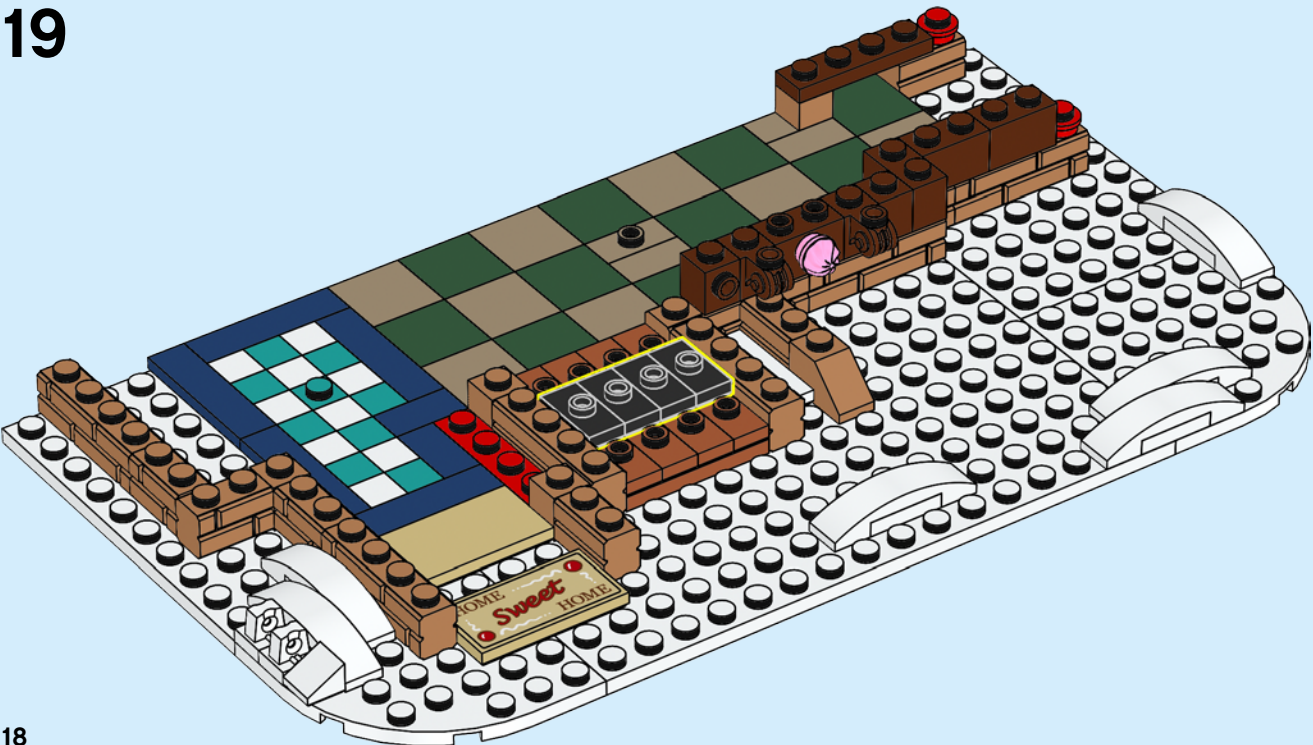

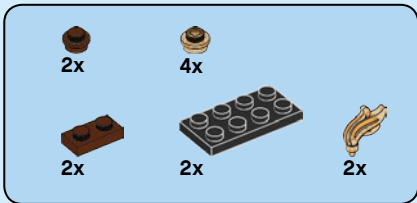

20

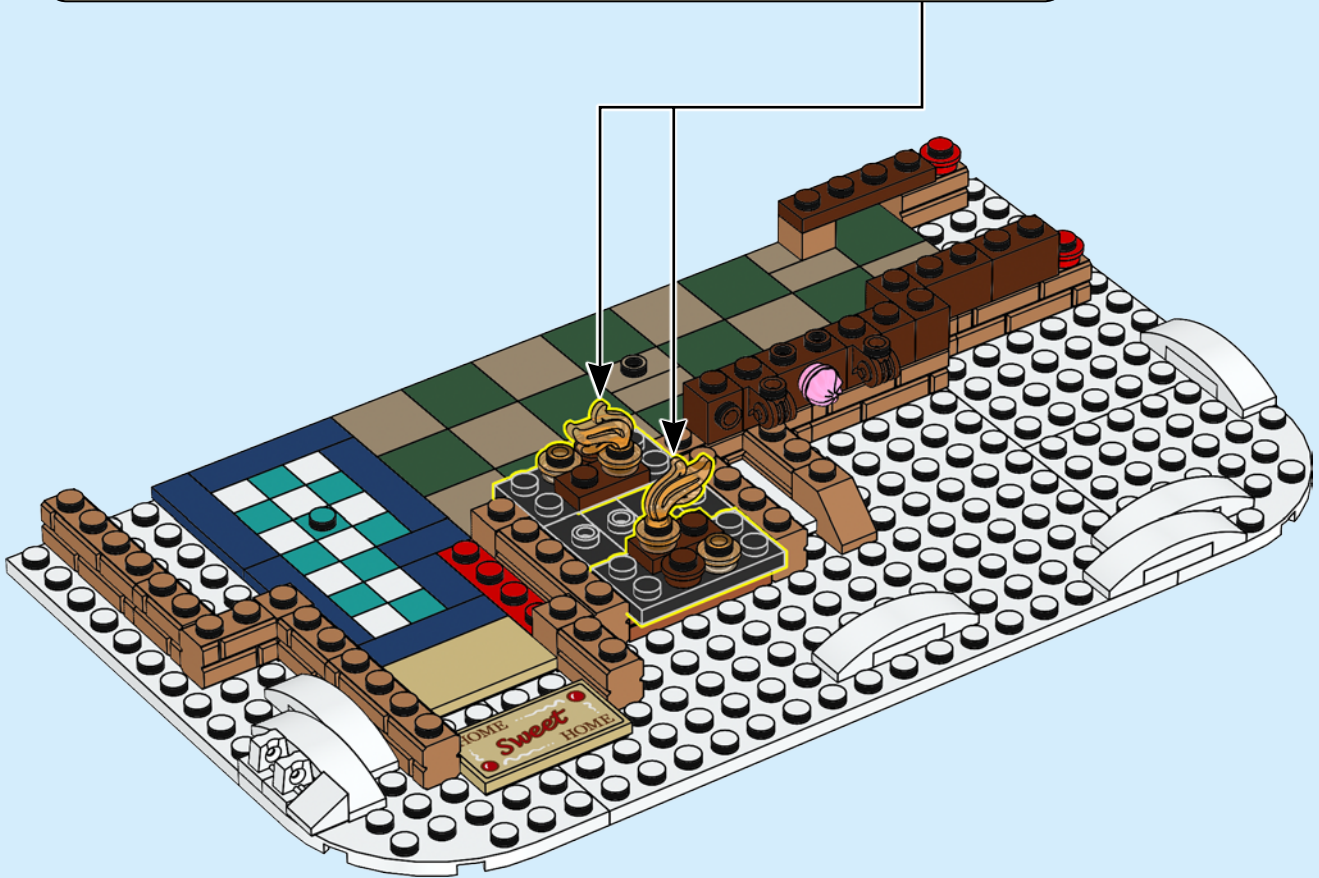
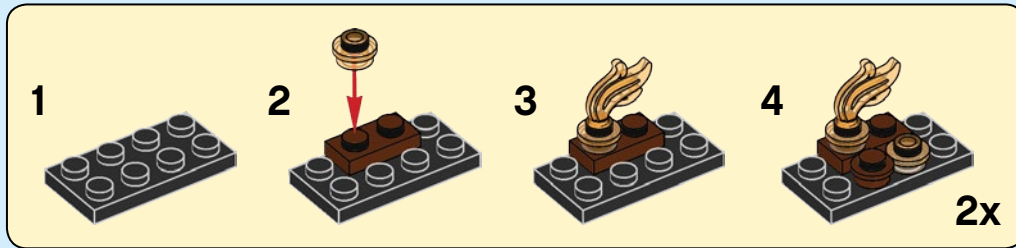

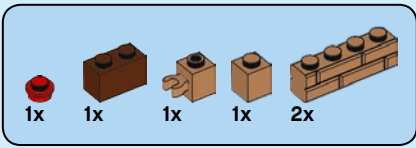

21

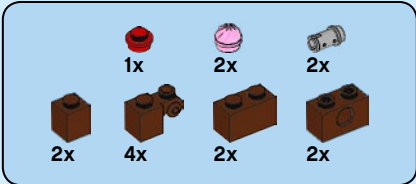

22

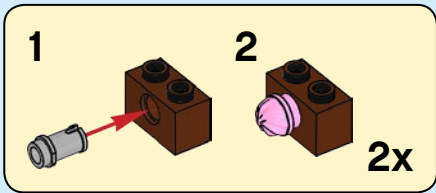

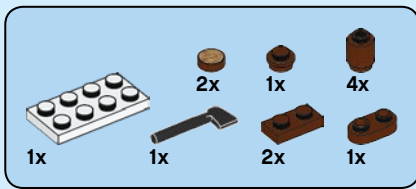

23

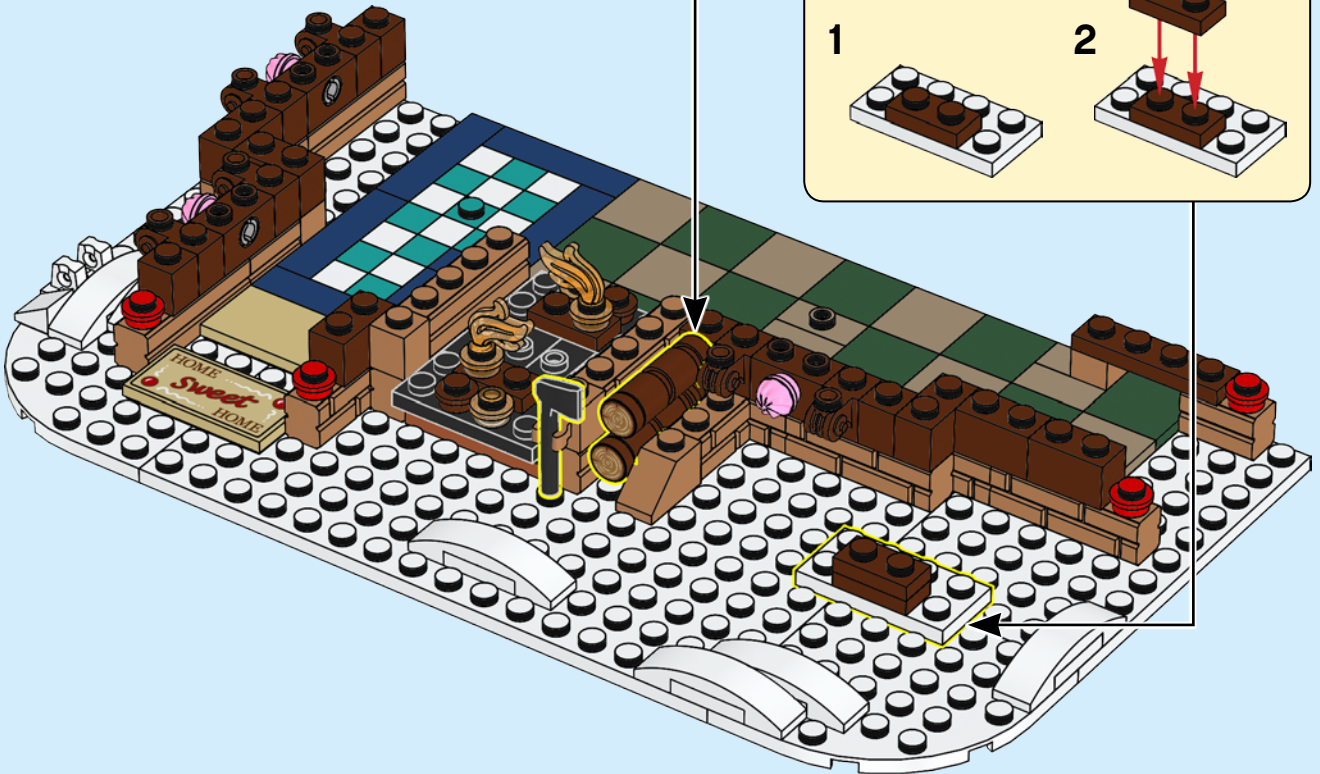
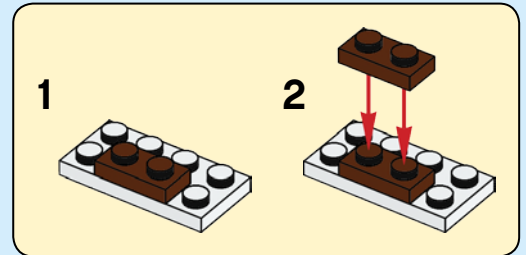
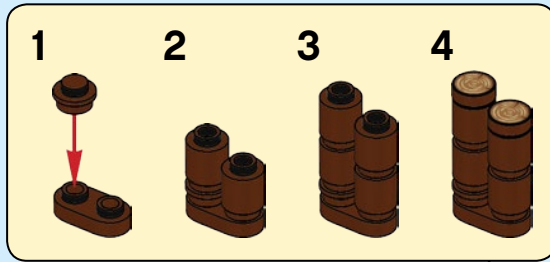

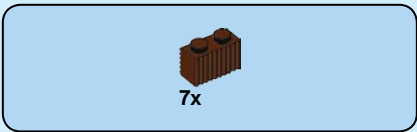

24

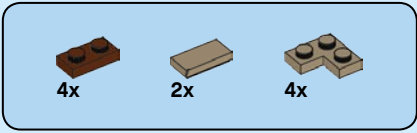

25

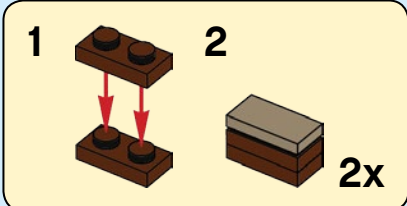

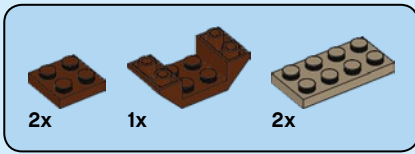

26

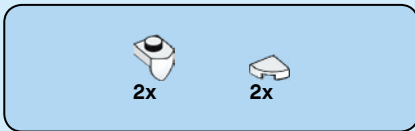
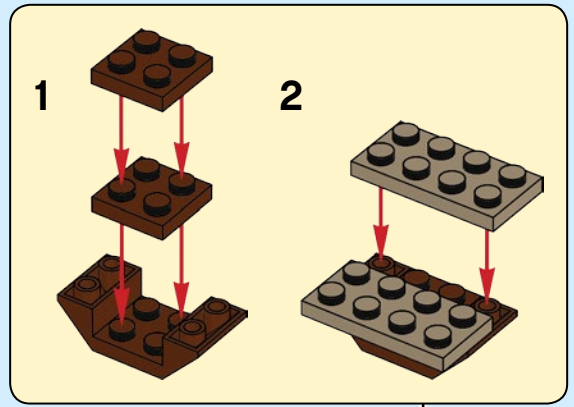

27

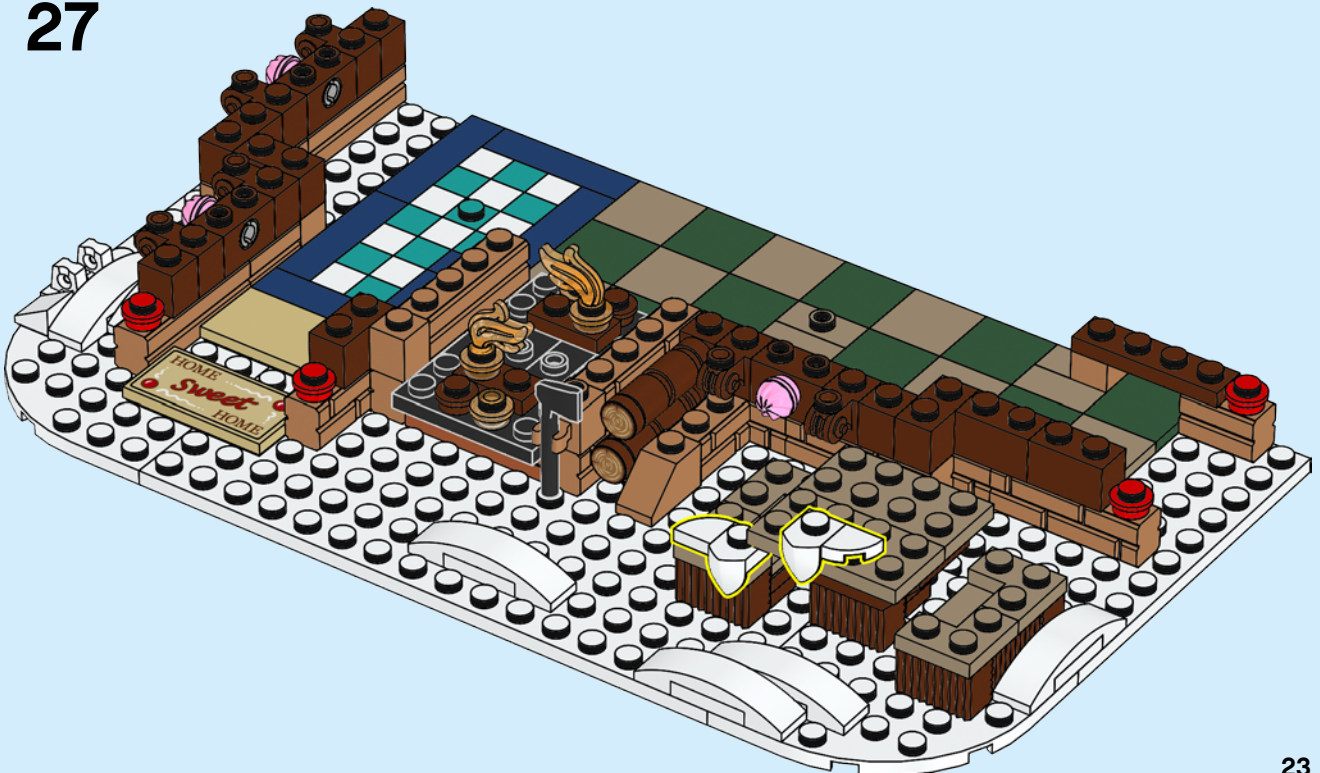

6x

4x

28

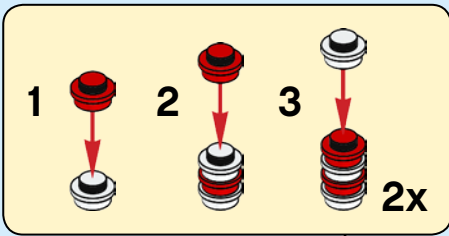

4x

4x

1x

3x

29



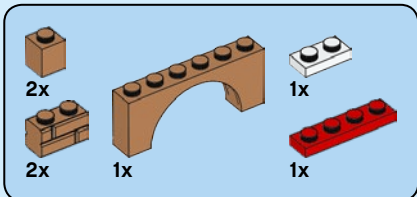

30

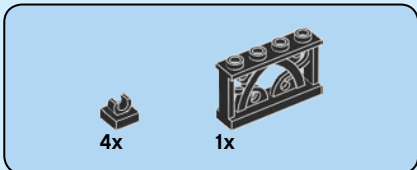

31

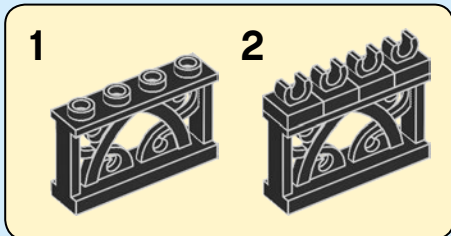

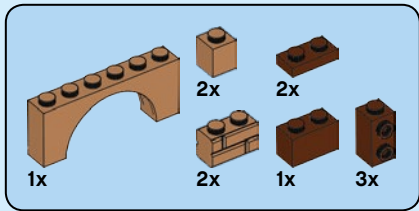

32

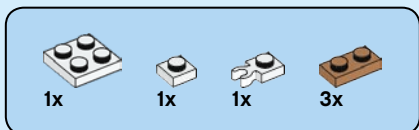
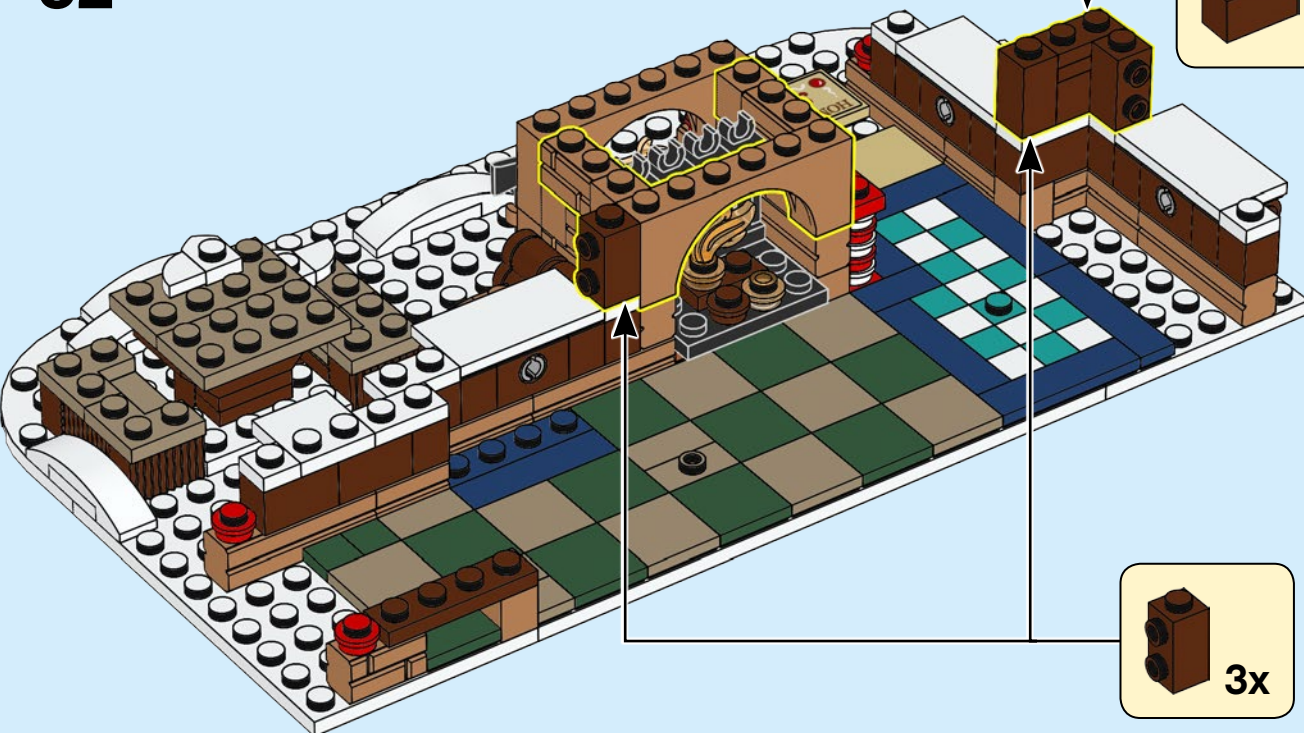
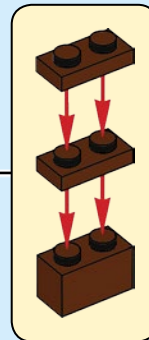

33



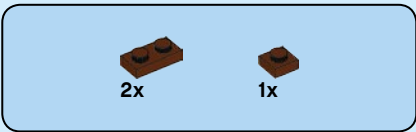

34

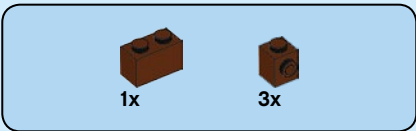

35



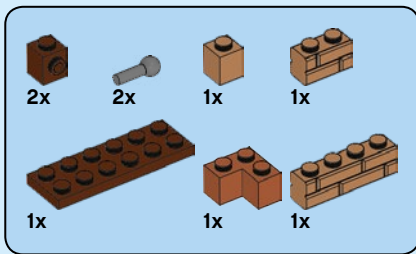

37

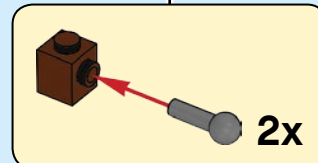

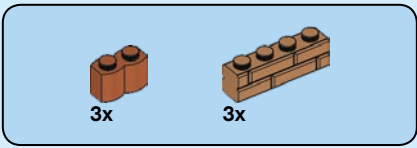

38

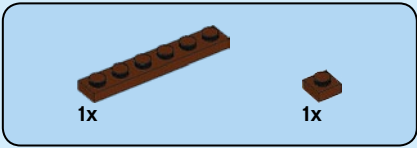

39



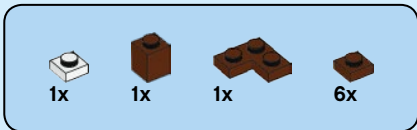
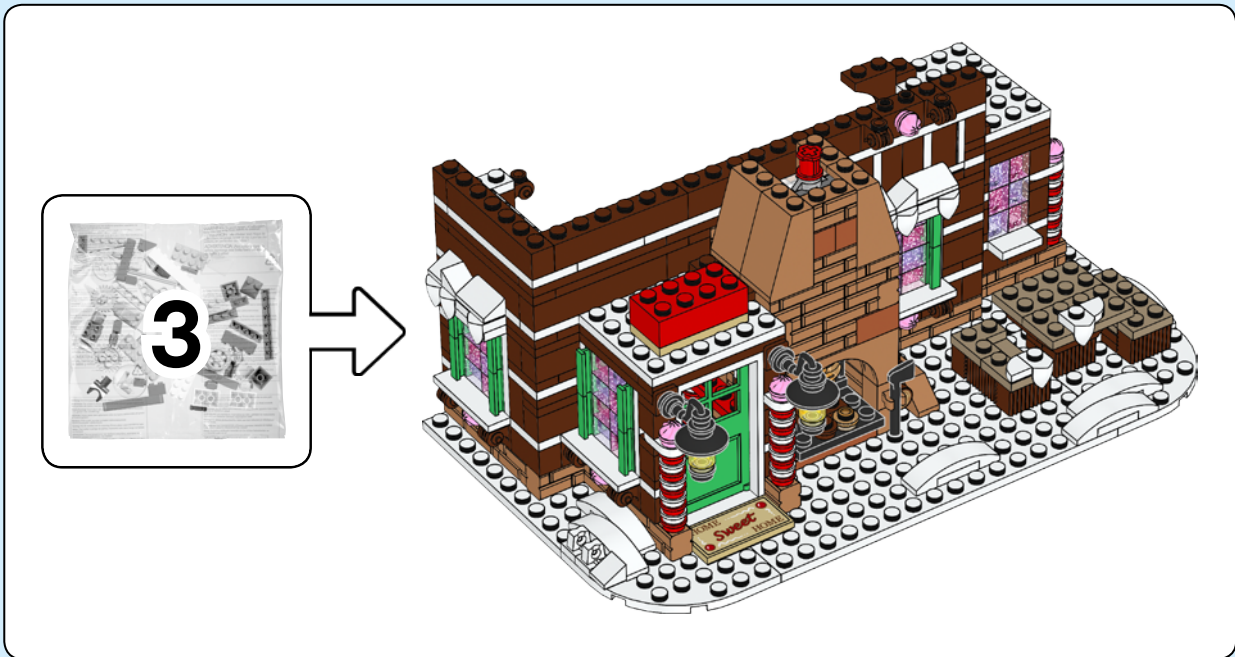

40

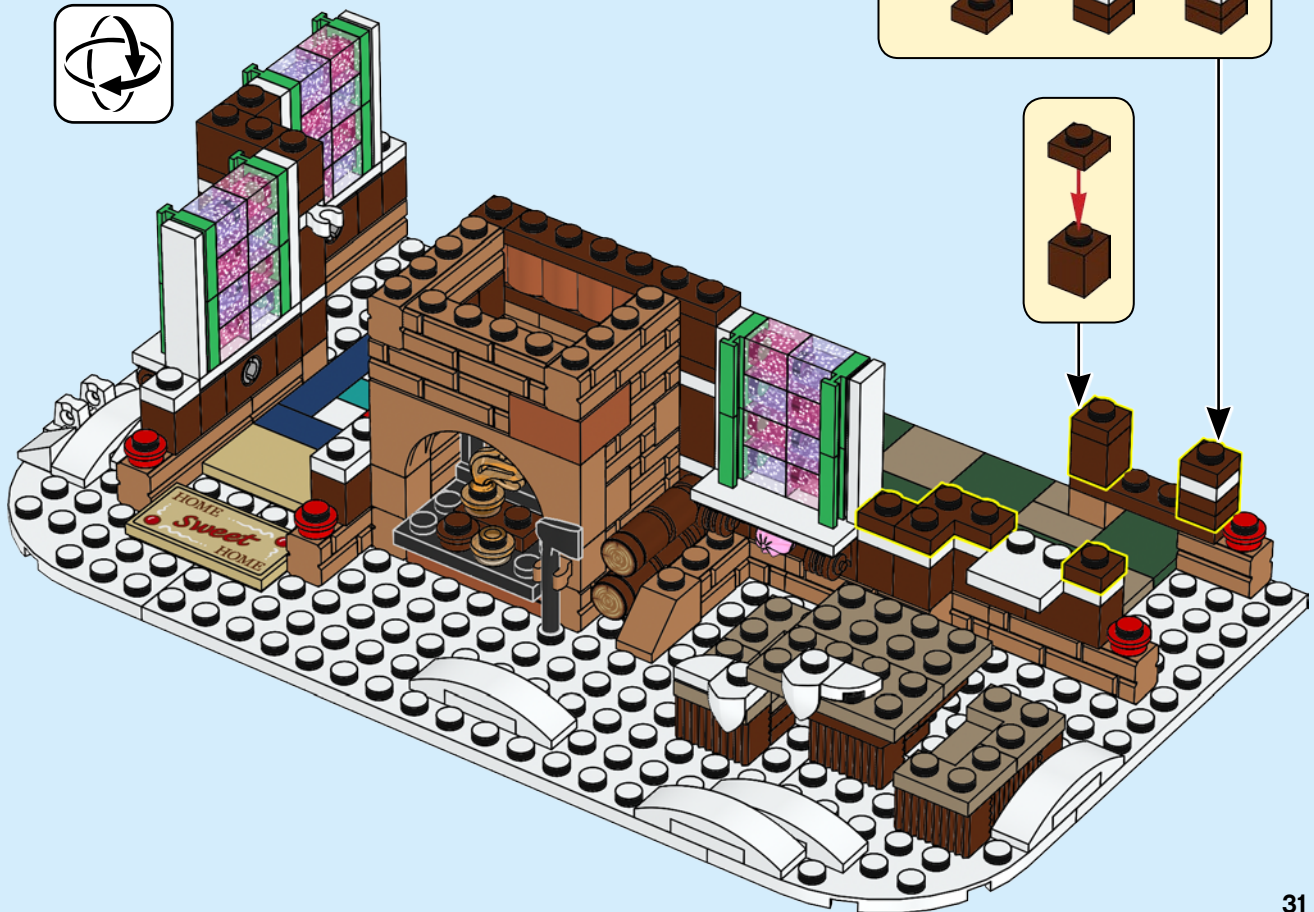
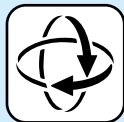
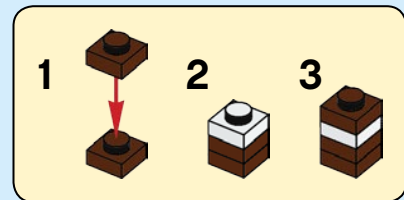

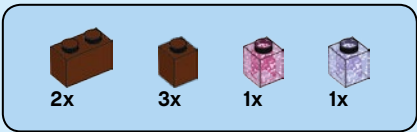

41

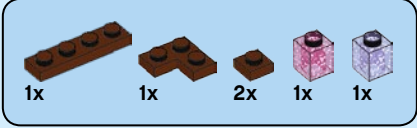
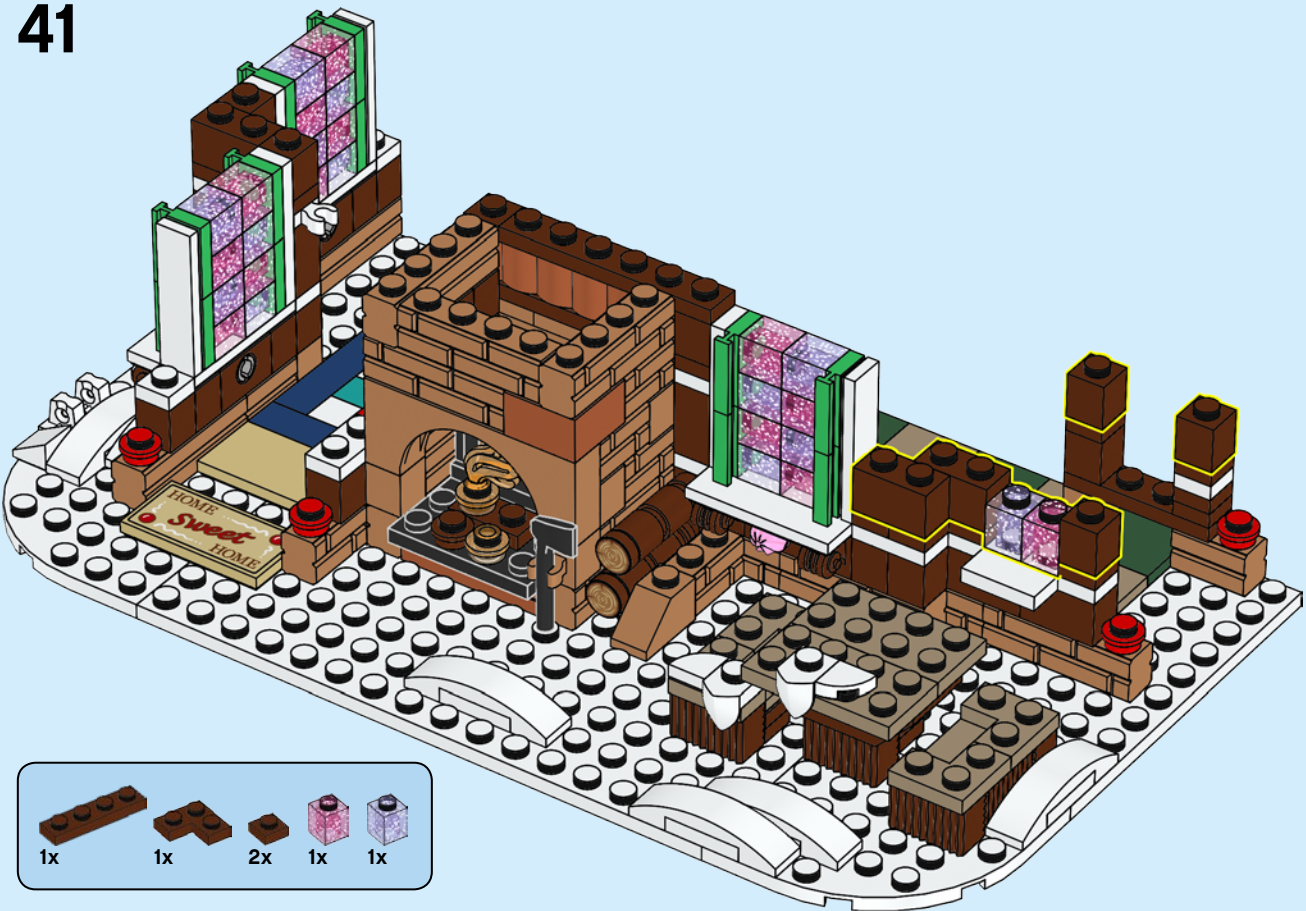

42



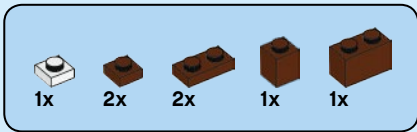

43

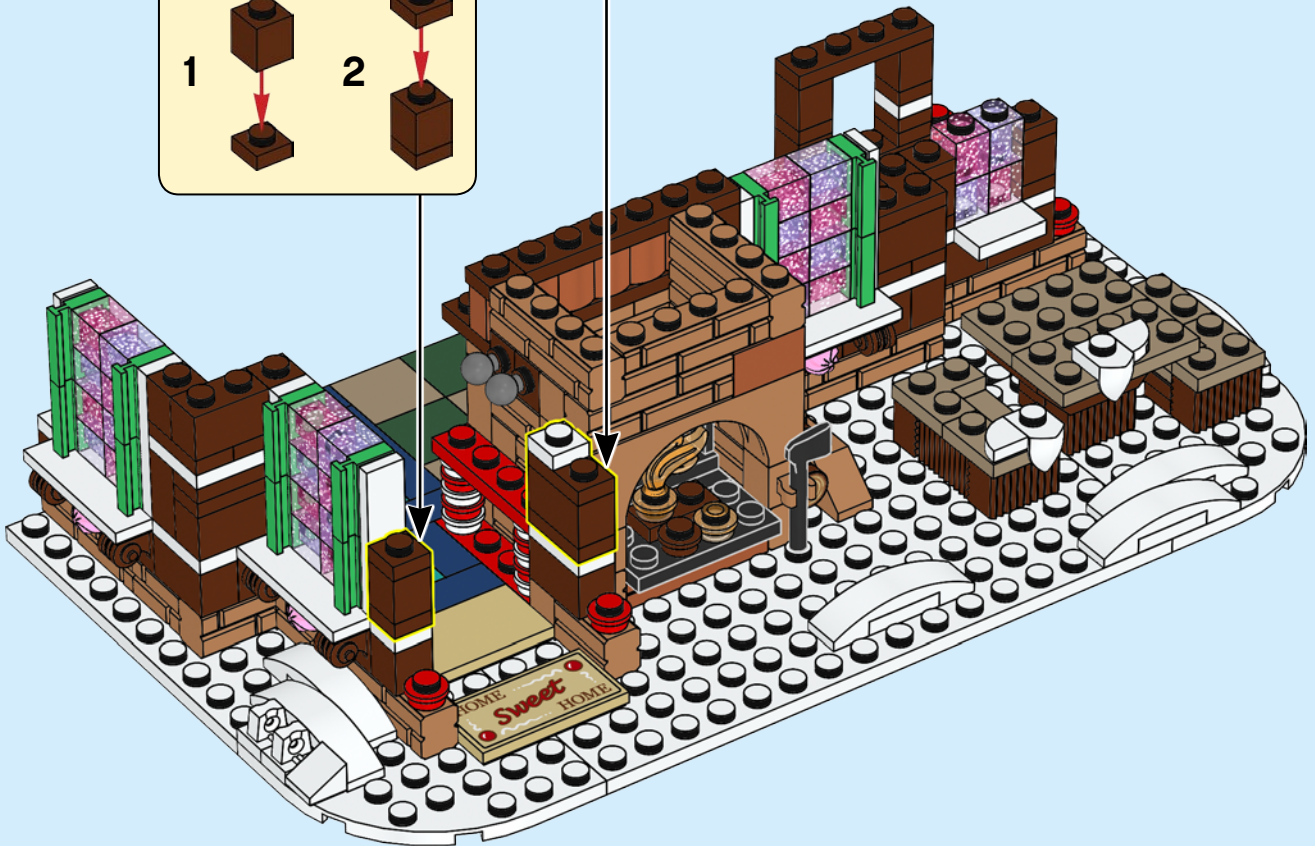
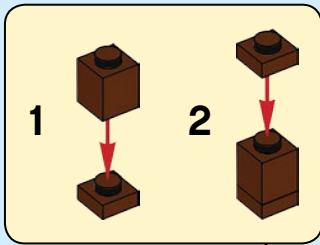
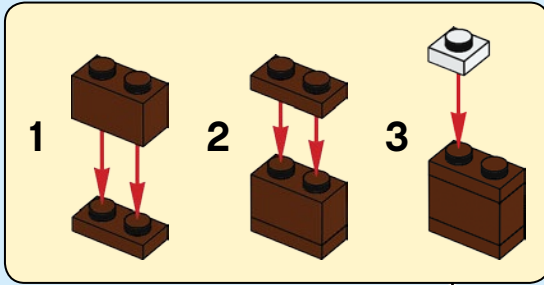

16x

16x

44

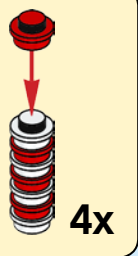

4x

4x

4x

2x

45

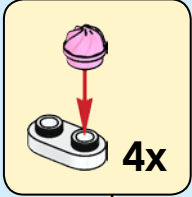

4x

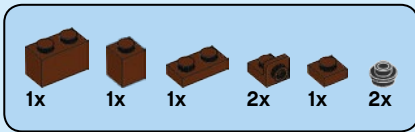

46

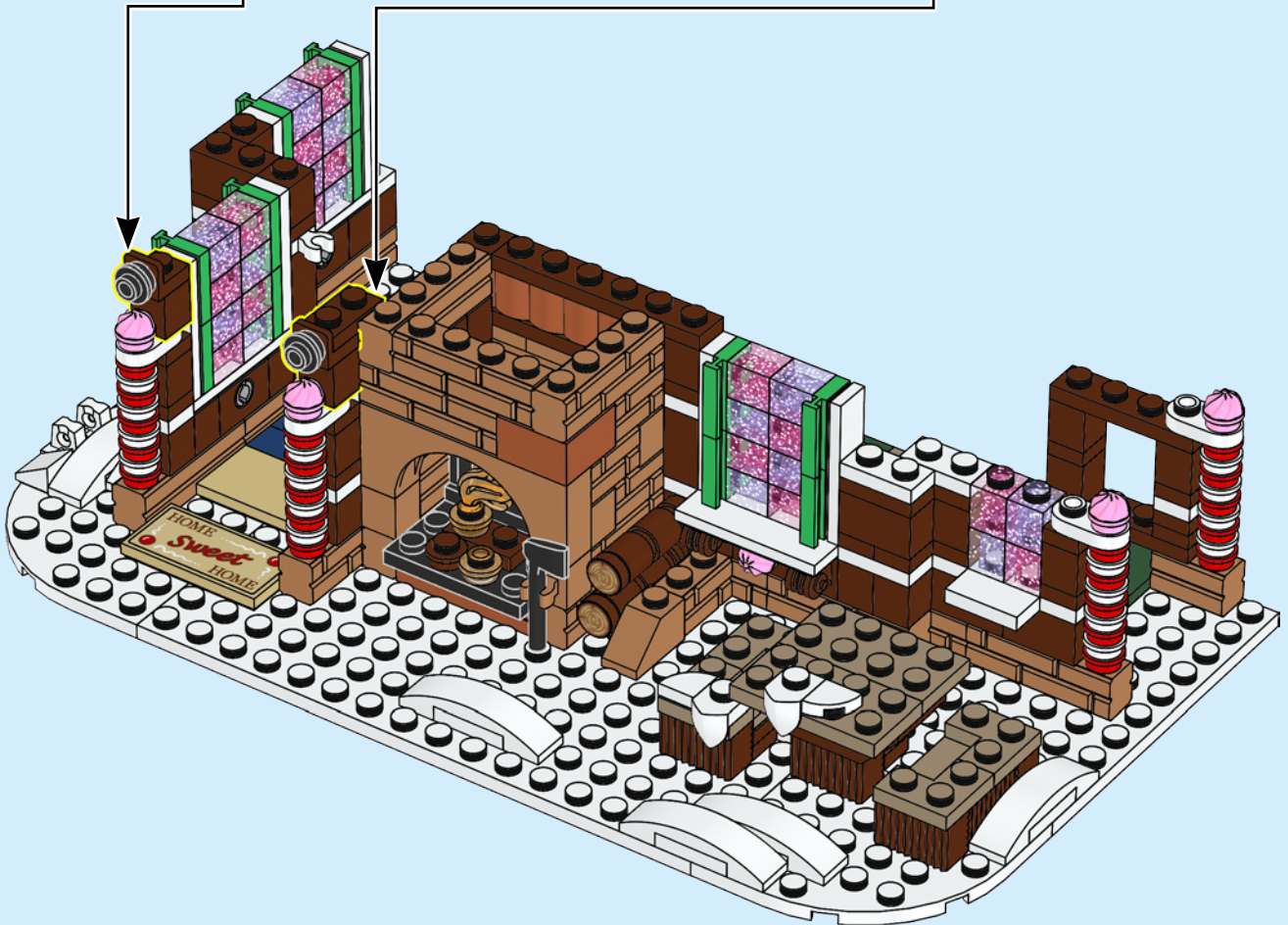
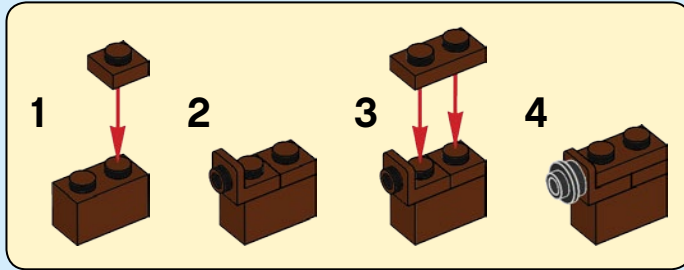
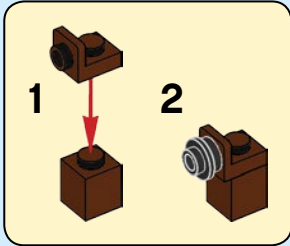

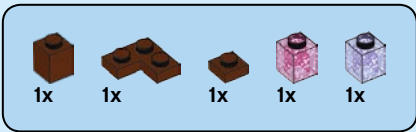

47



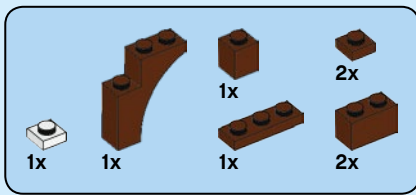

48

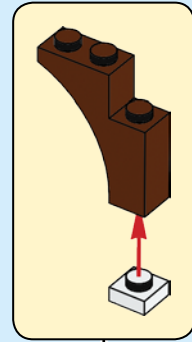
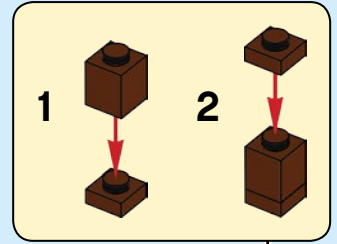

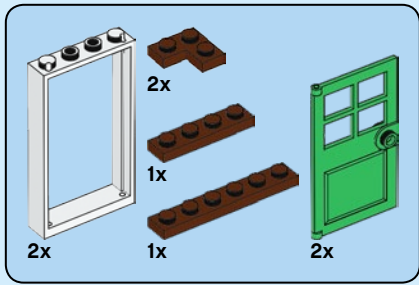

49

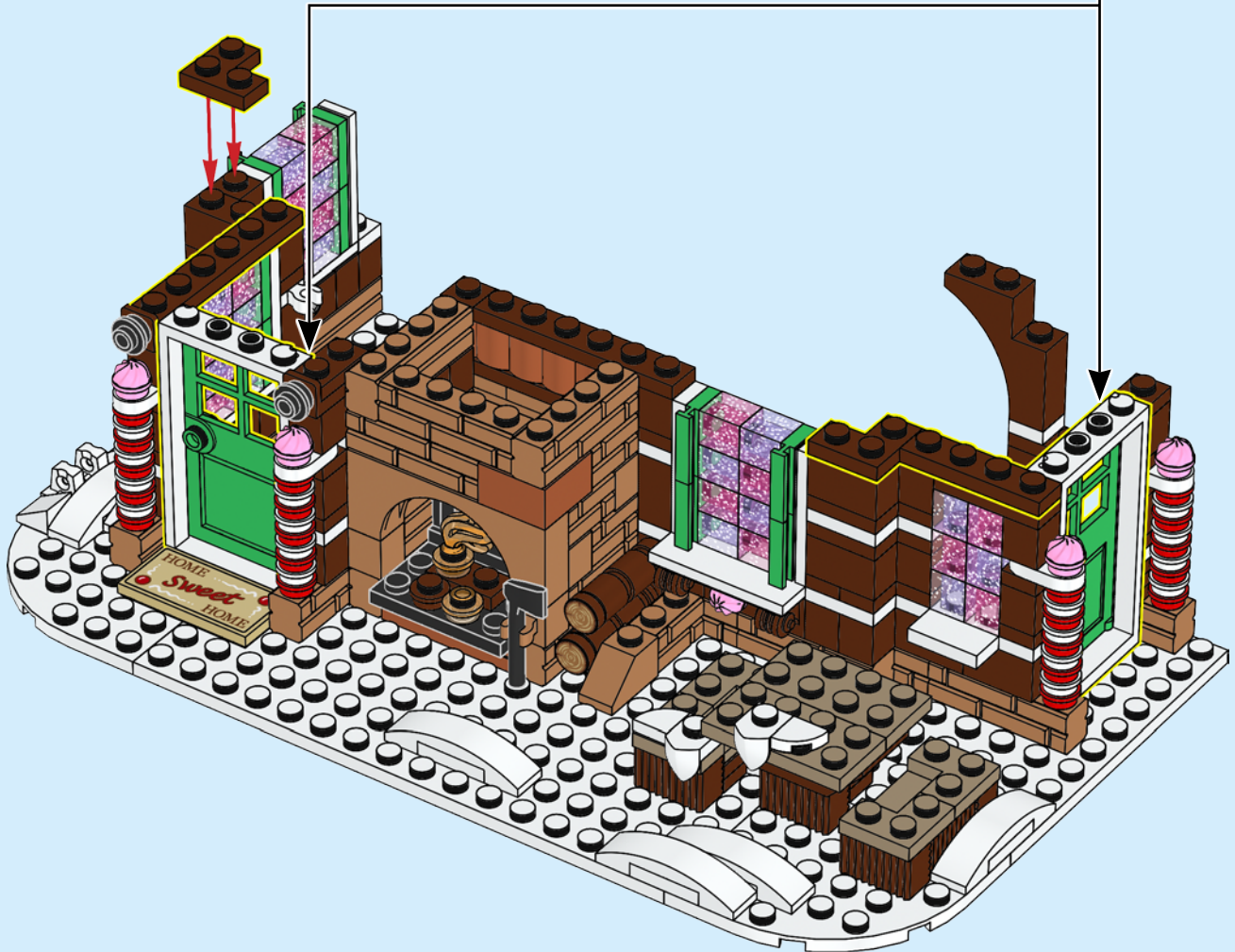
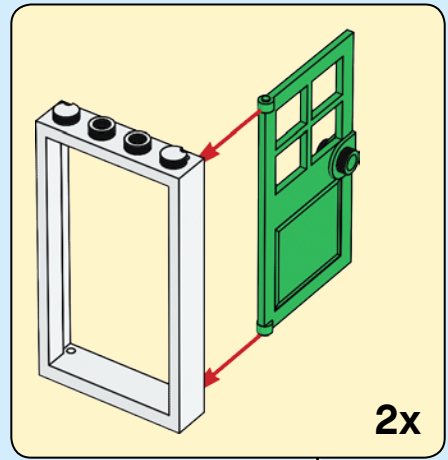

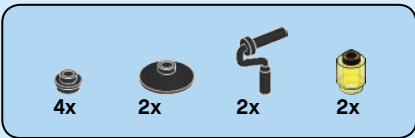

50

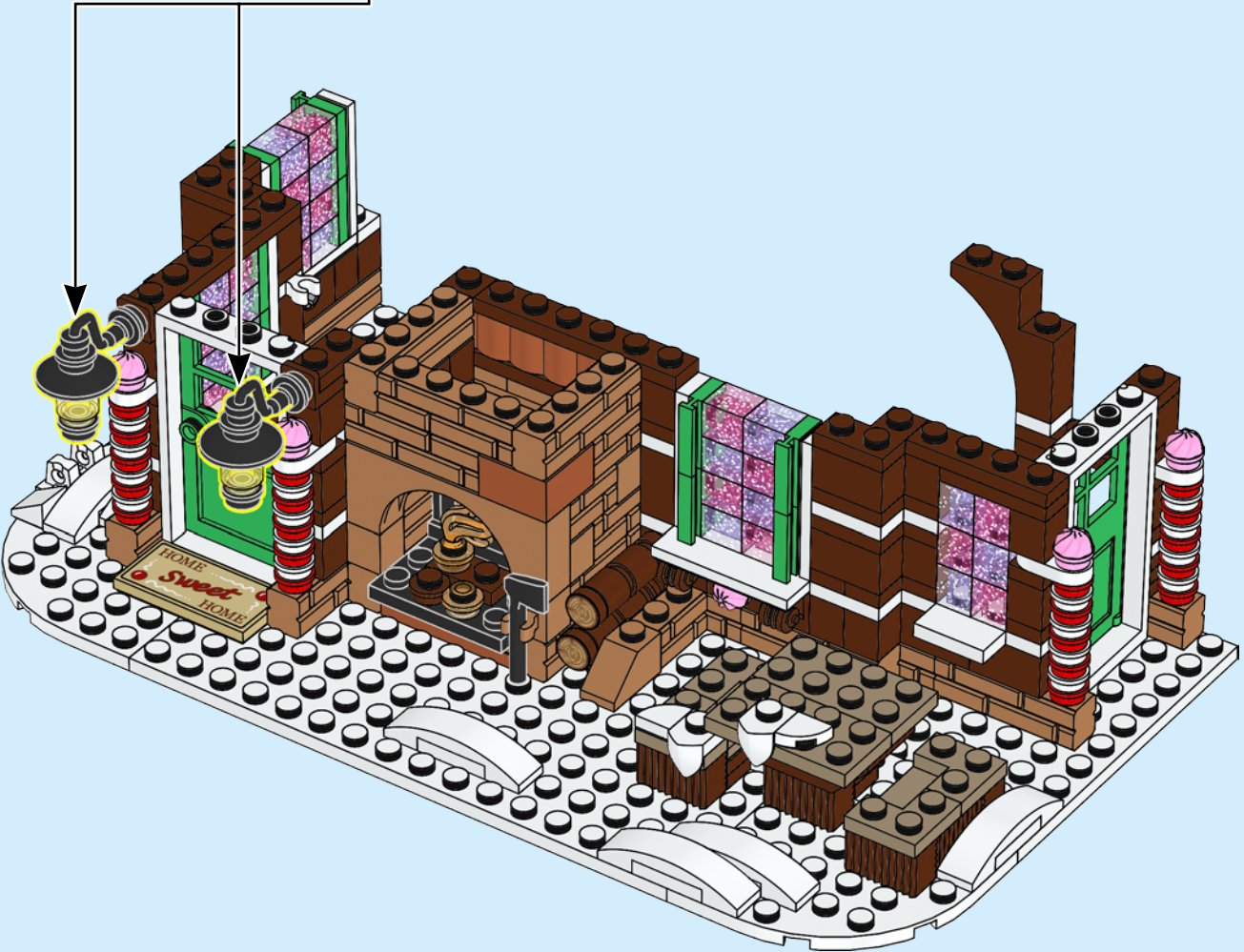
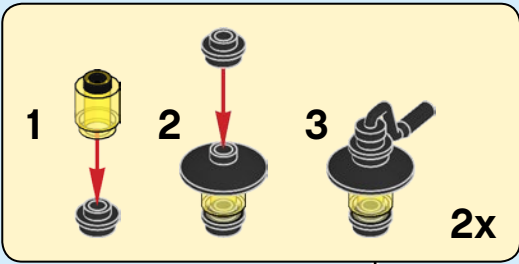

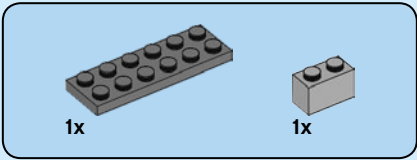
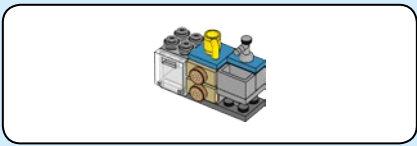

51

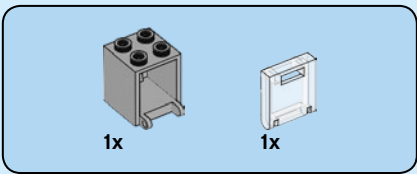
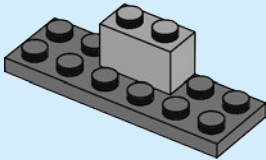

52

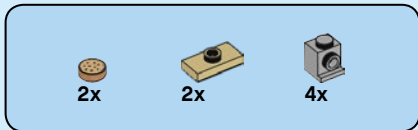
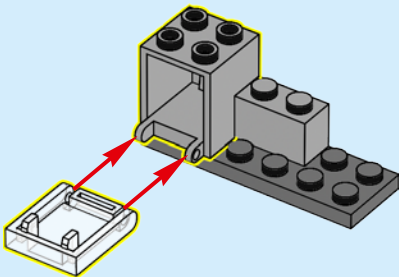

53

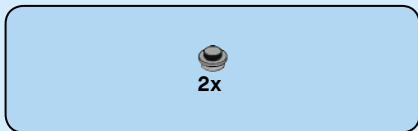
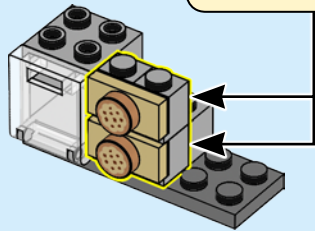
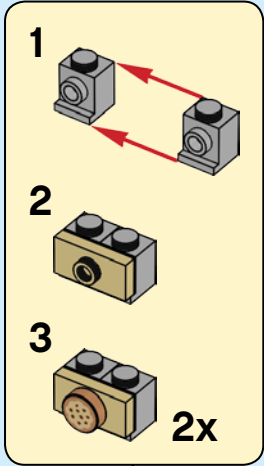

54

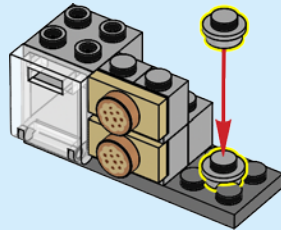

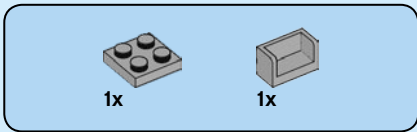

55

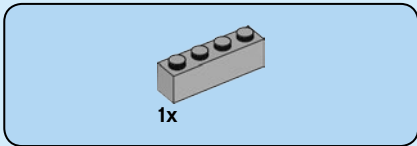
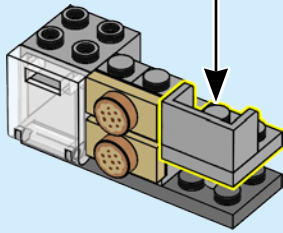
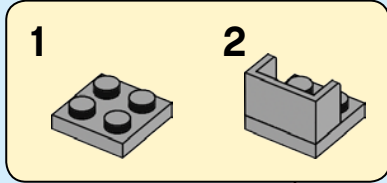

56

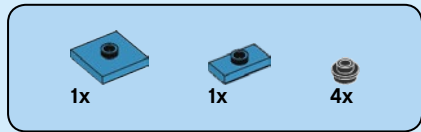
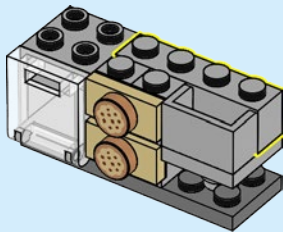

57

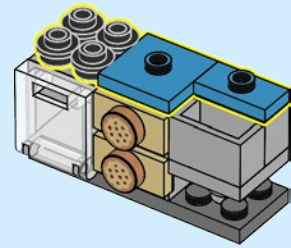

58

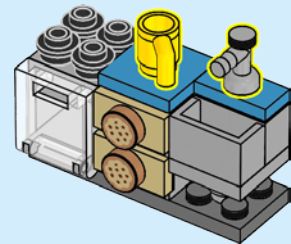



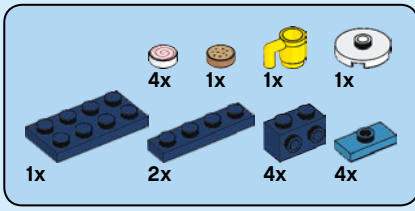

60

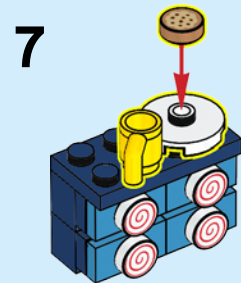
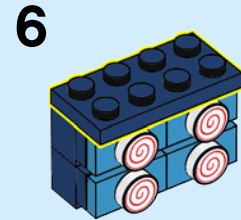
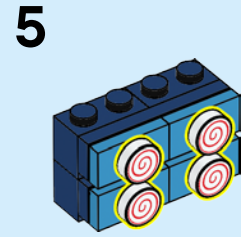
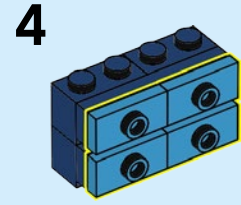
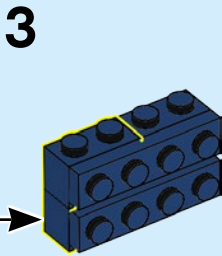
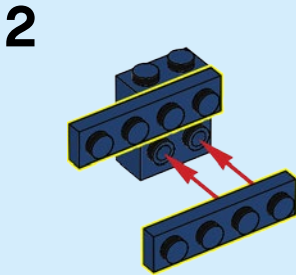
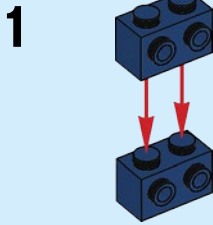

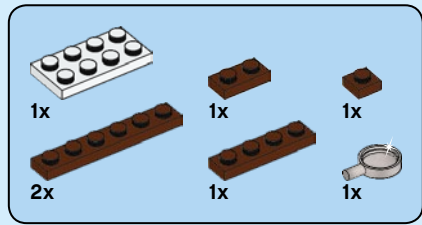

61

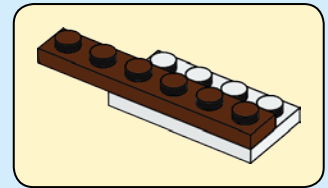

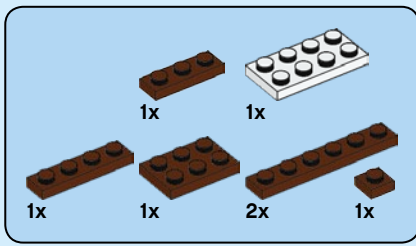

62



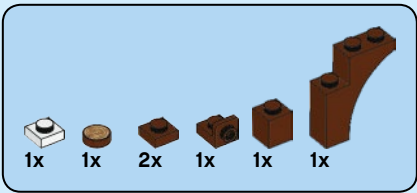

63

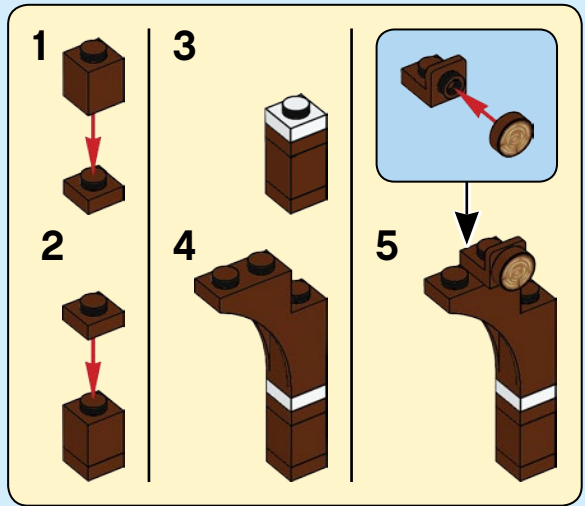

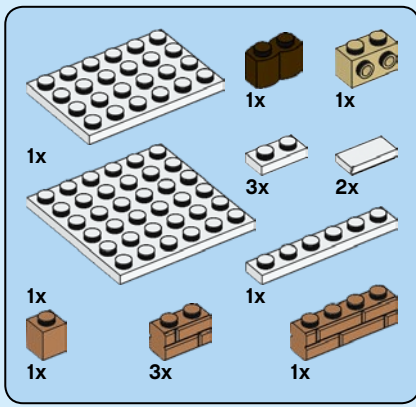

64



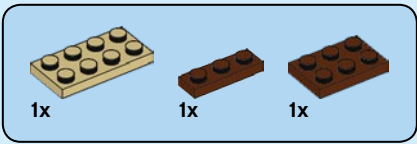

65



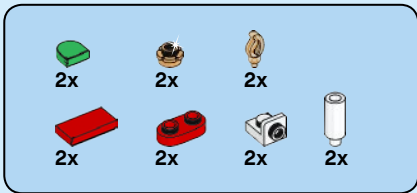

66

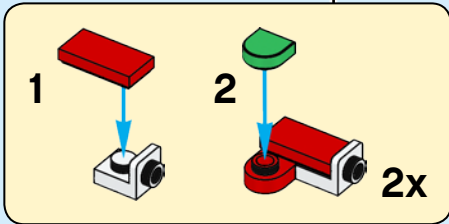
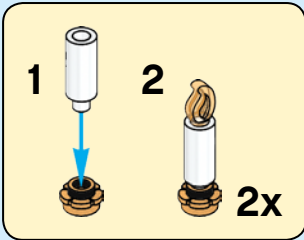

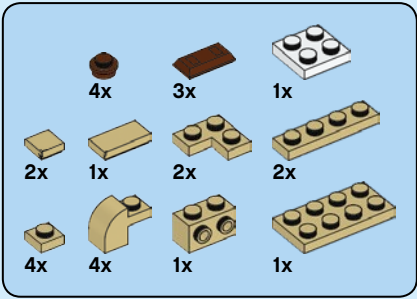

67

1

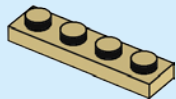

2

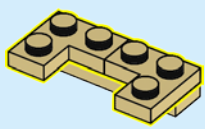

3

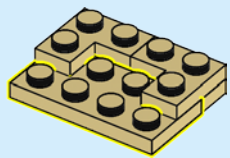

4

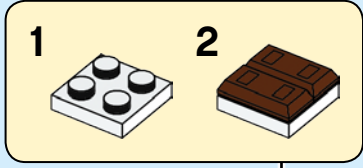
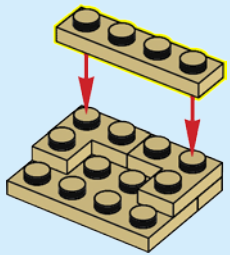

5

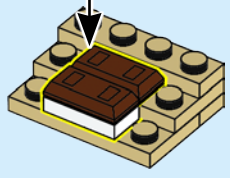

6

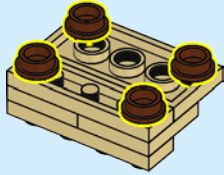

7

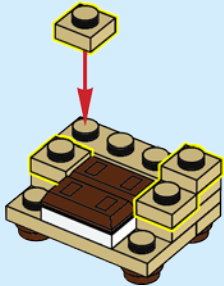

8

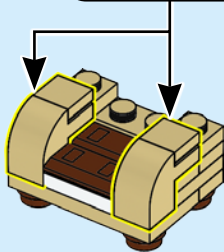
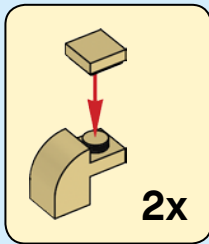

9

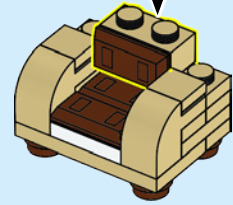
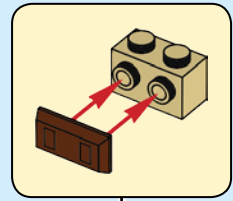

10

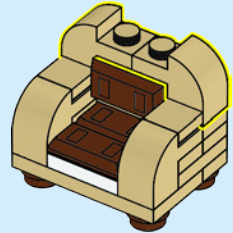

11

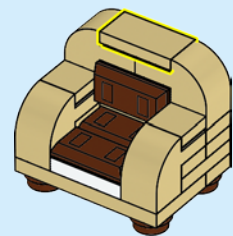

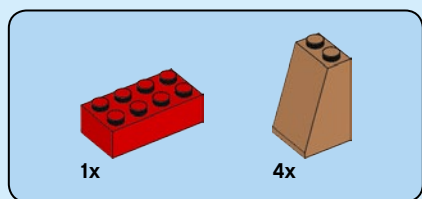

68



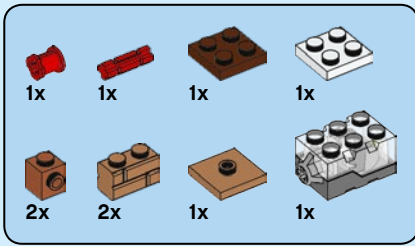

69

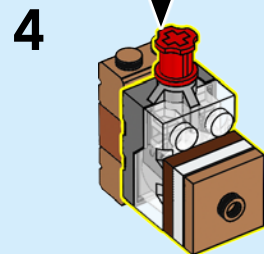
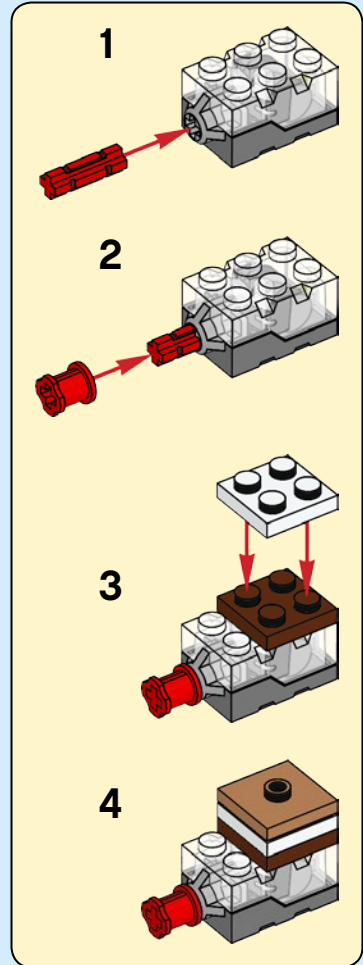
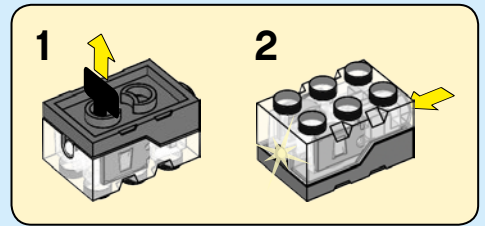
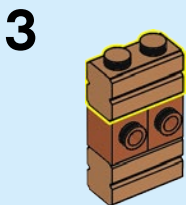
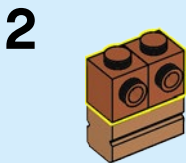

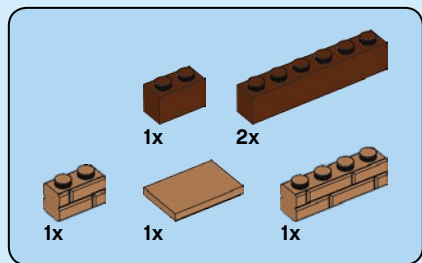

70



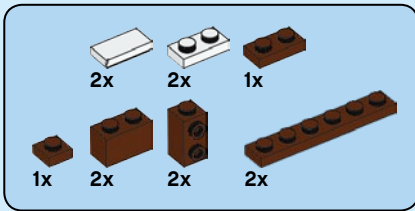

71

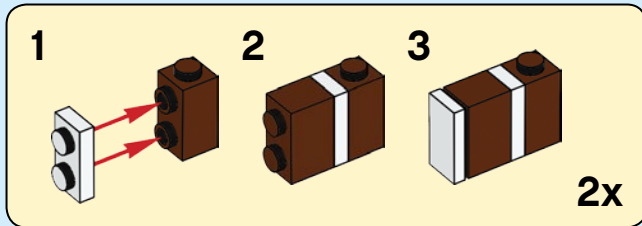

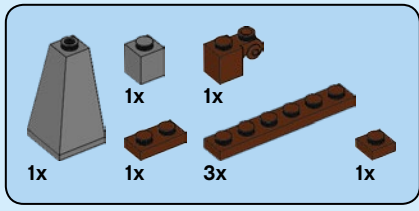

72

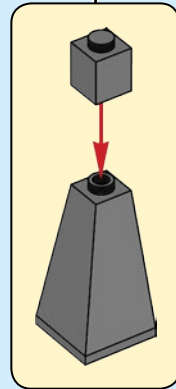

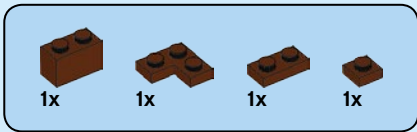

73

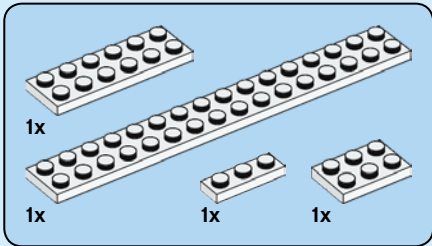
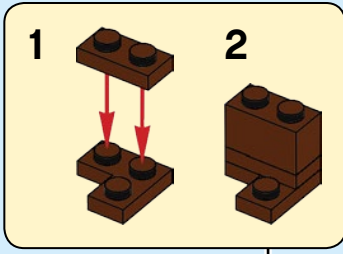

74



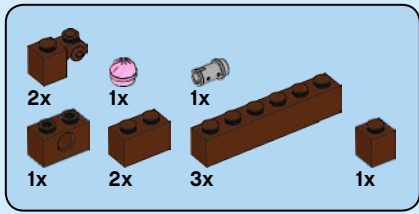

75

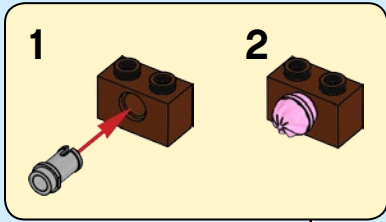

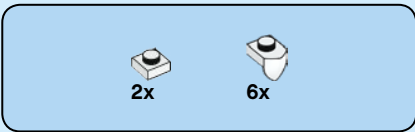

76

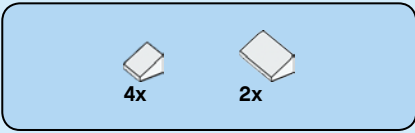

77



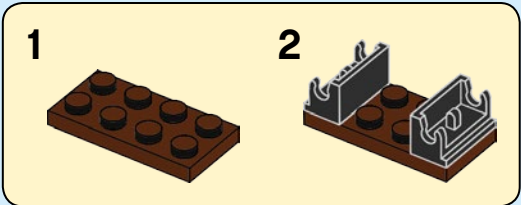
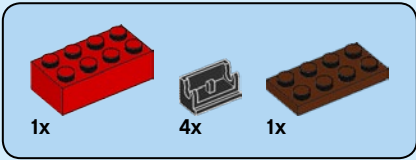
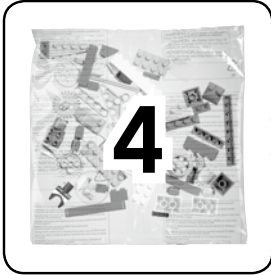

78



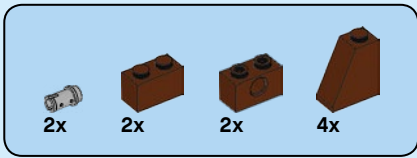

79

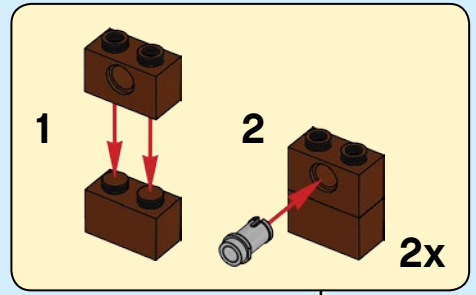

2x



2x

80



2x



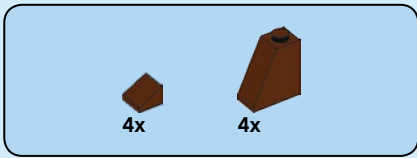

81

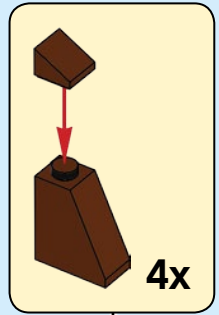

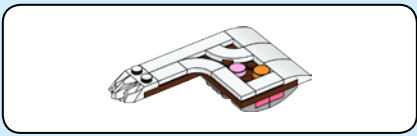

82

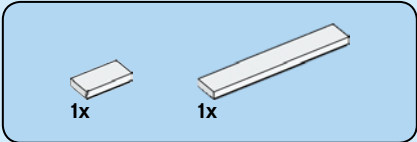
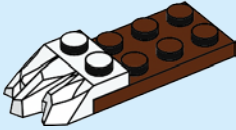

83

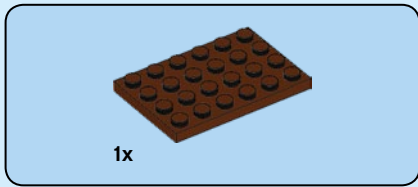
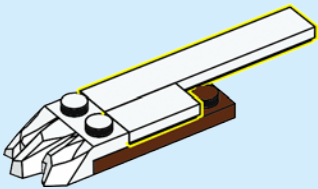

84

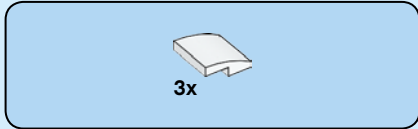
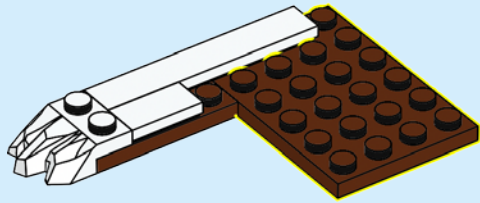

85

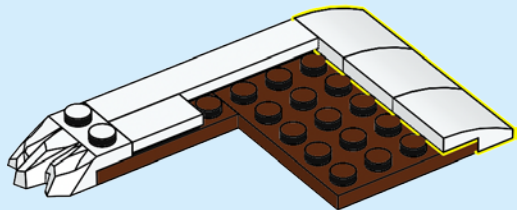

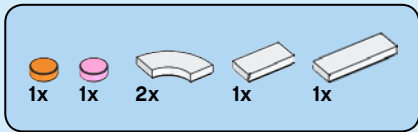

86

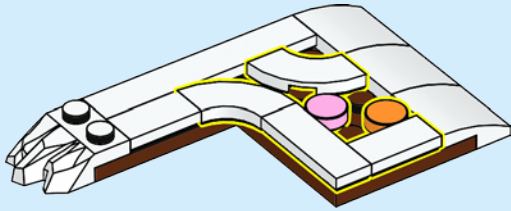

87

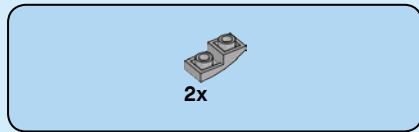
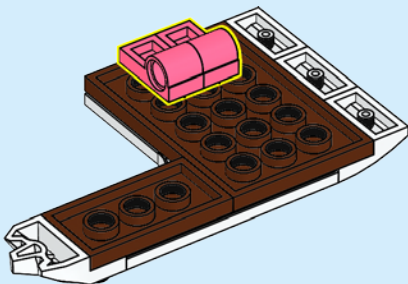

88

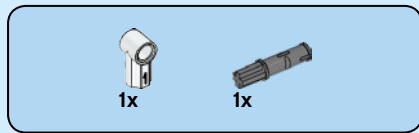
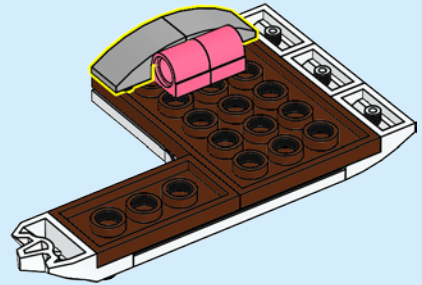

89

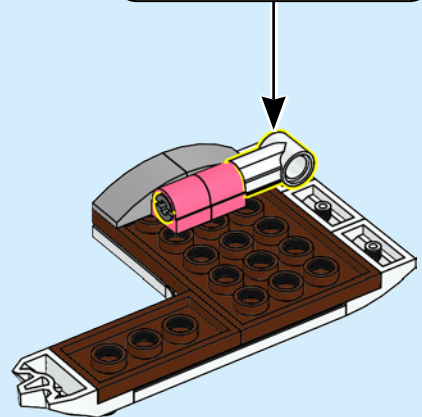
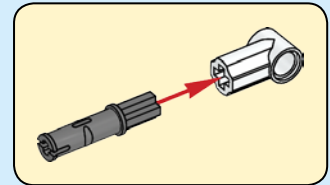

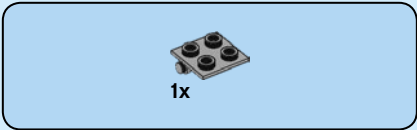

90

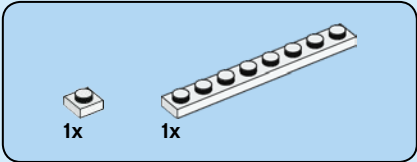
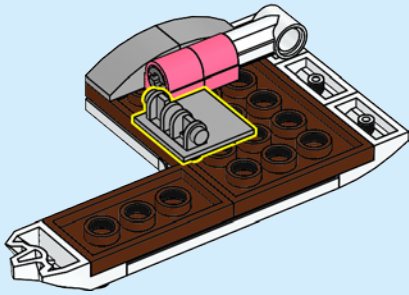

91

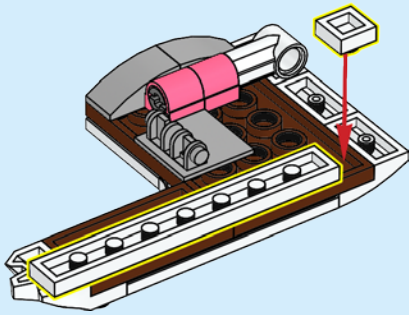



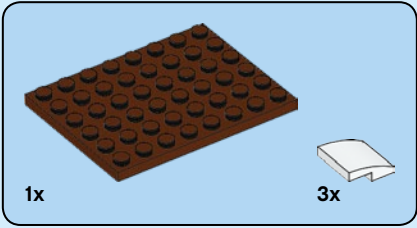
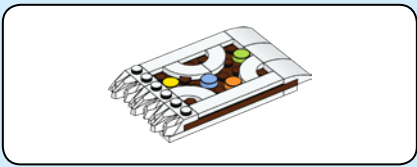

93

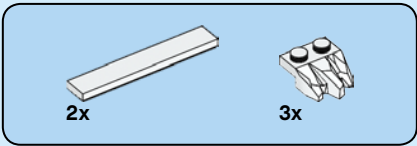
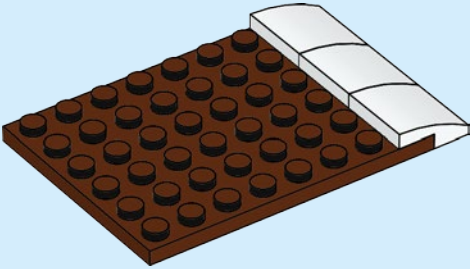

94

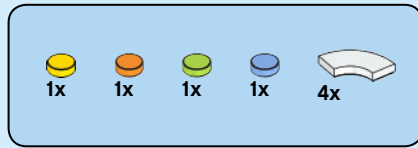
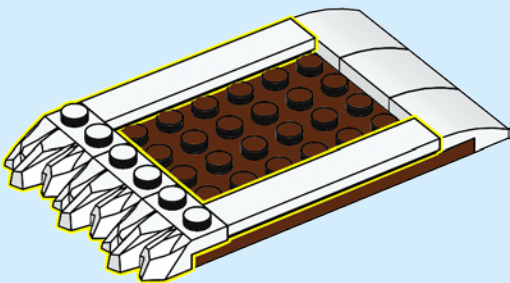

95

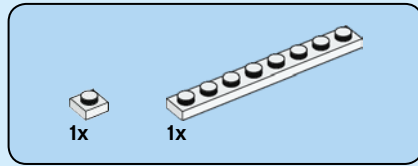
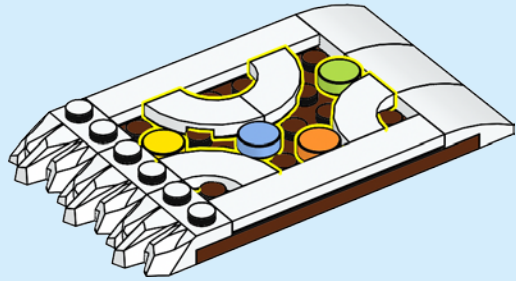

96

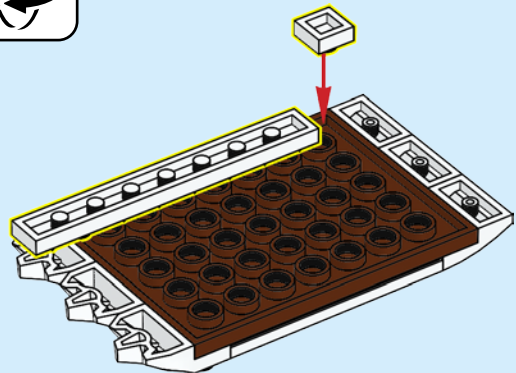
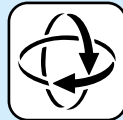



97

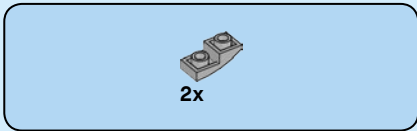
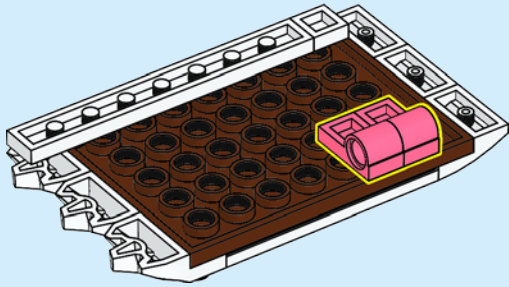

98

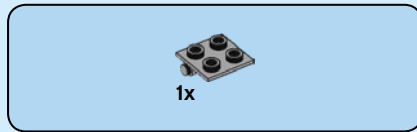
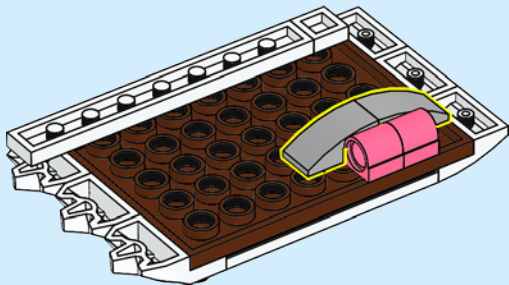

99

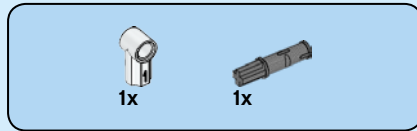
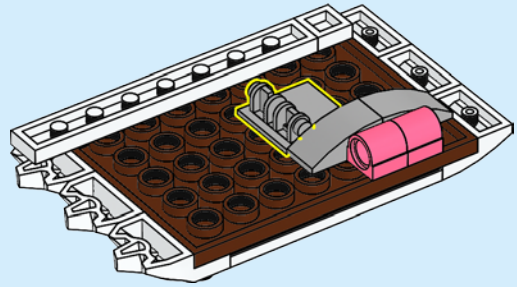

100

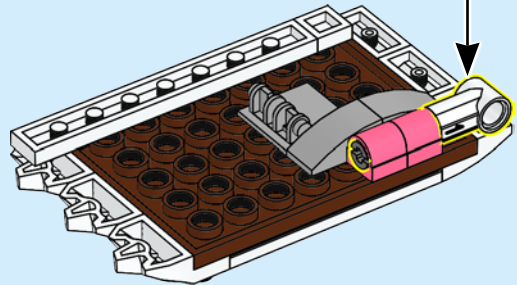
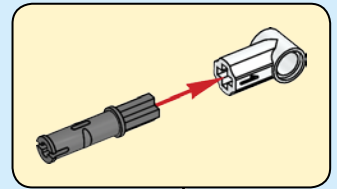



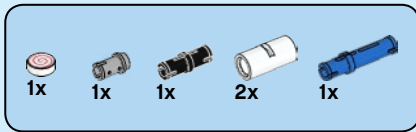

102

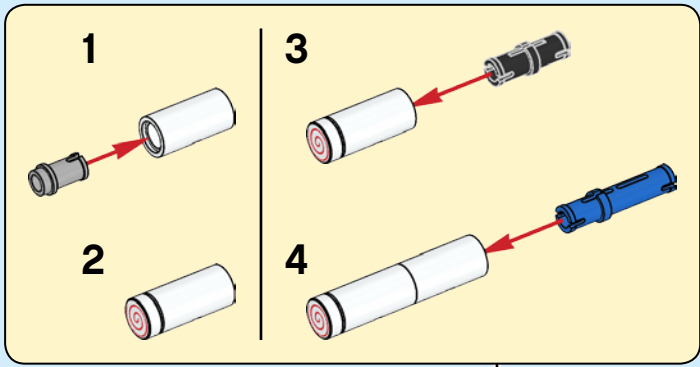

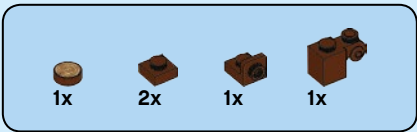

103

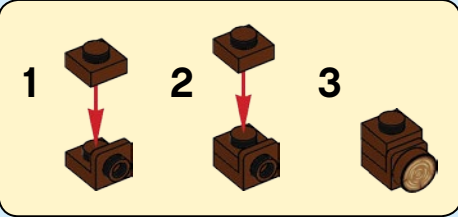

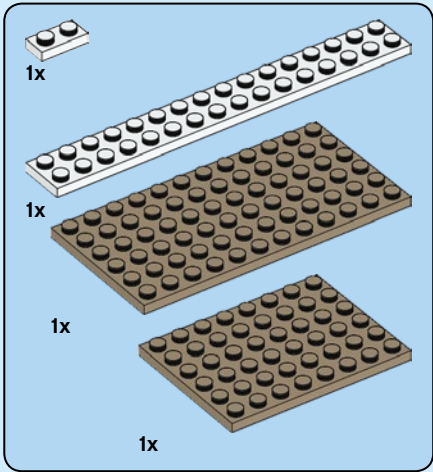
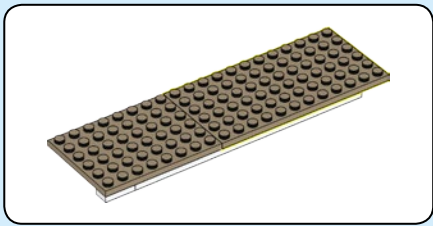

104

1

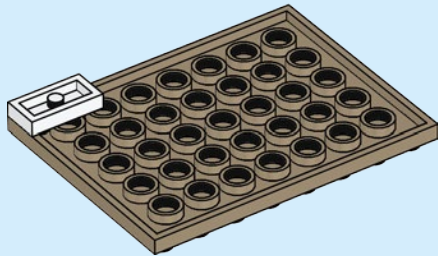

2

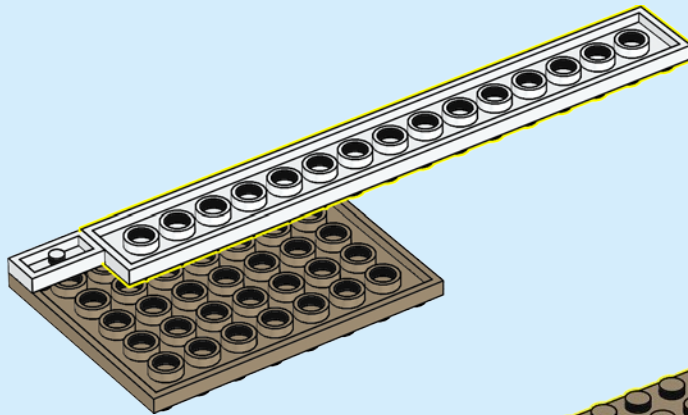

3

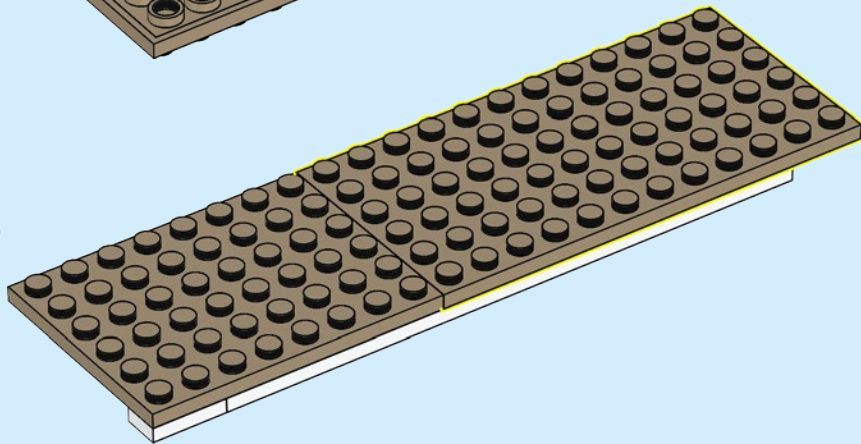

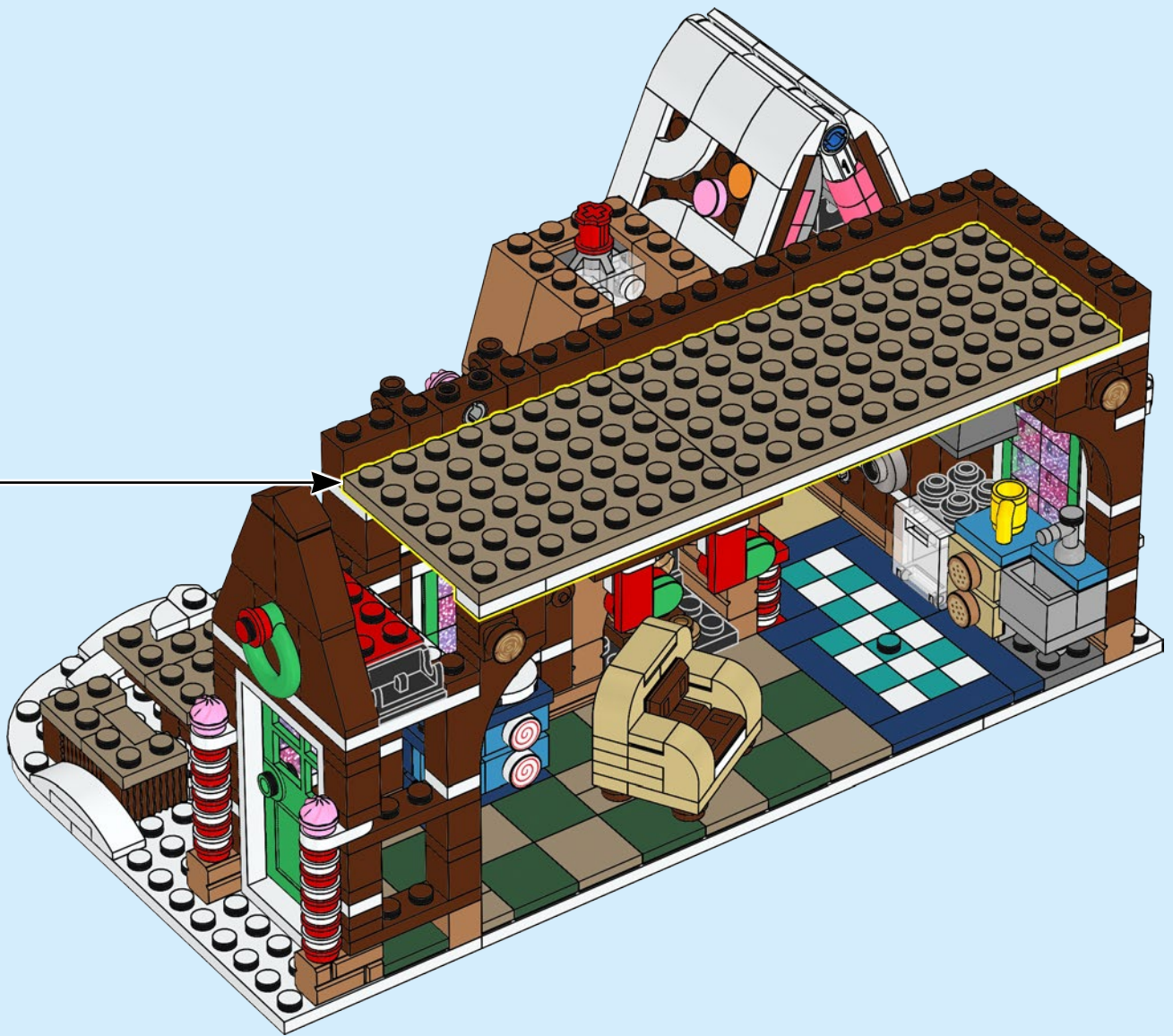

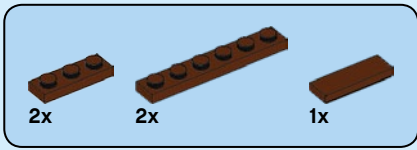

105

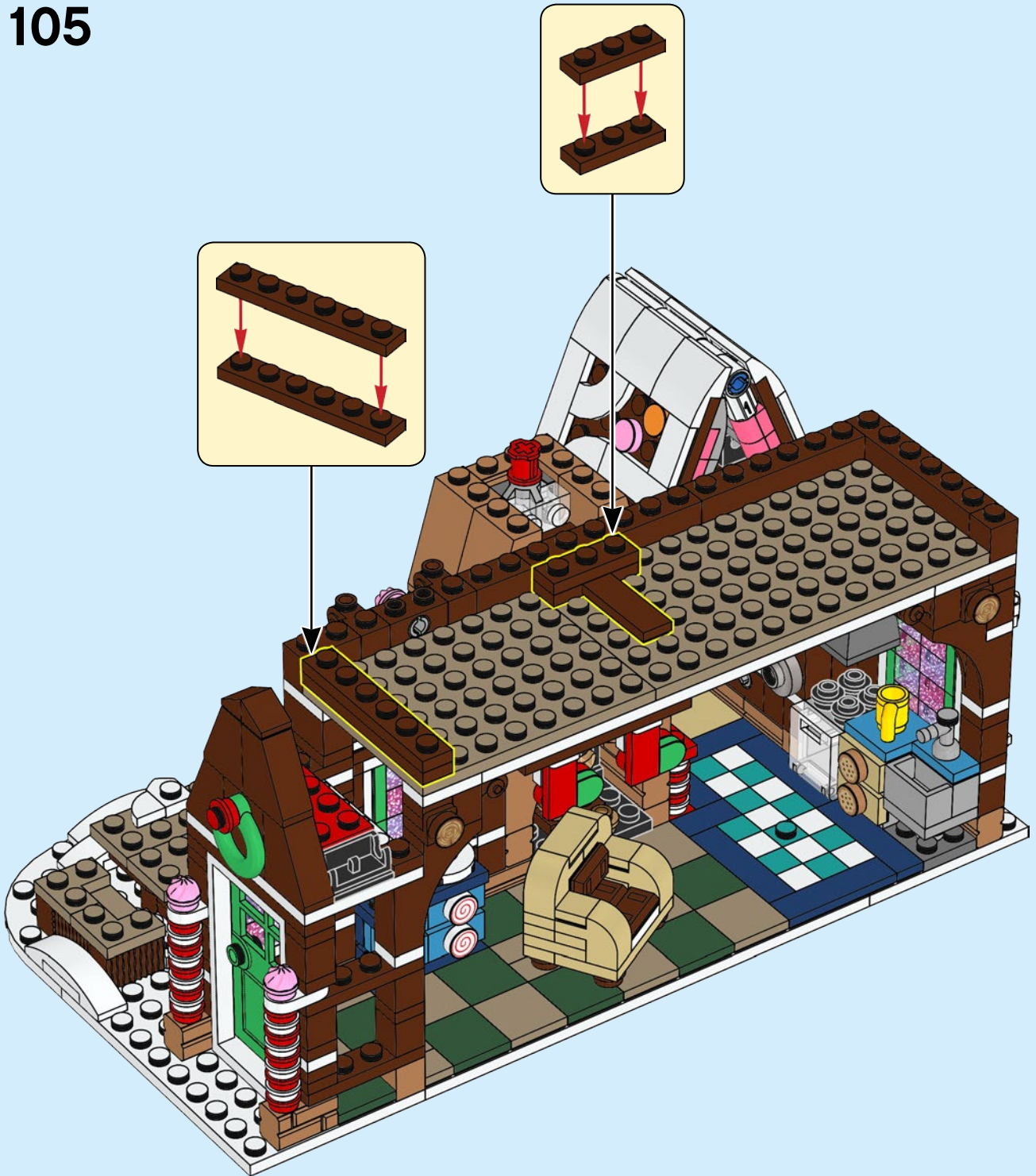

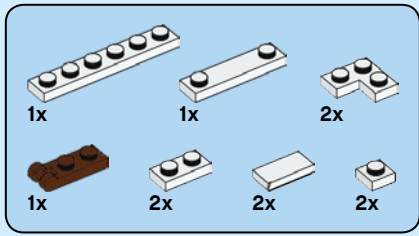

106



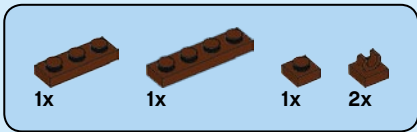

107



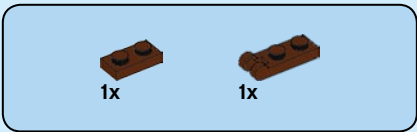

108



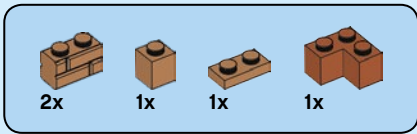

109



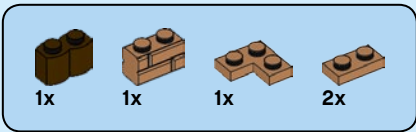

110



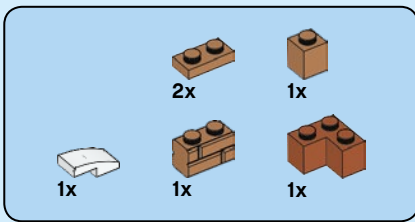

111



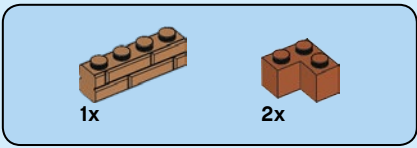

112



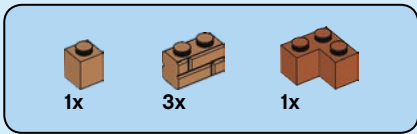

113



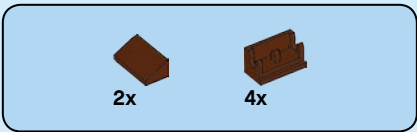

114



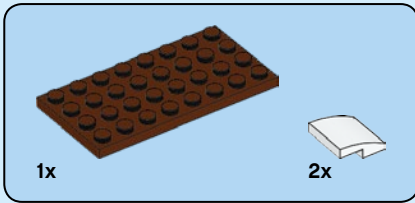
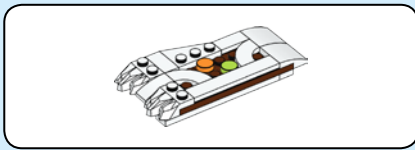

115

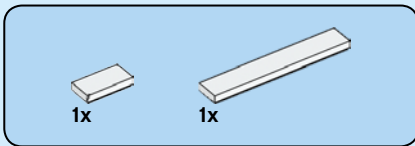
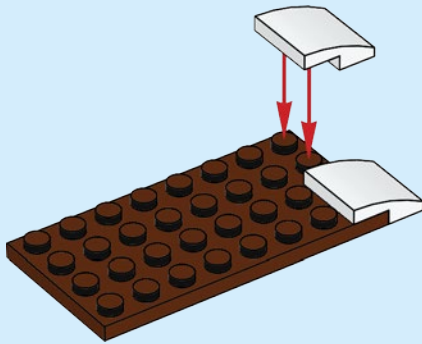

116

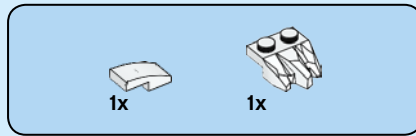
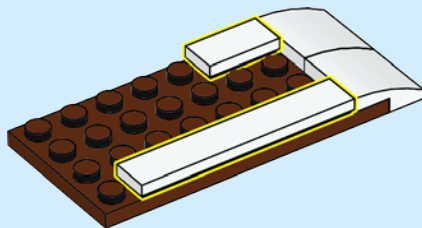

117

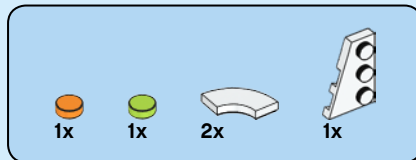
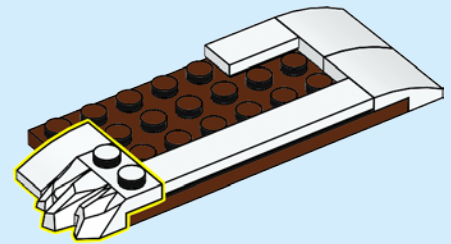

118

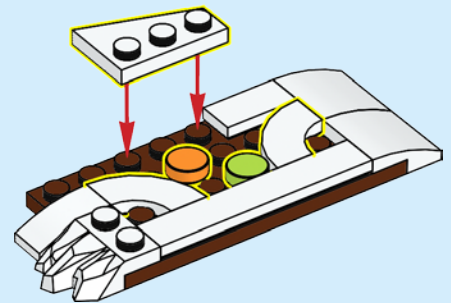

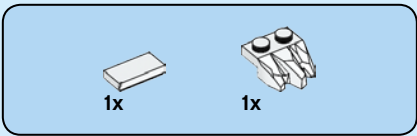

119

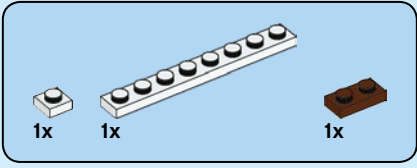
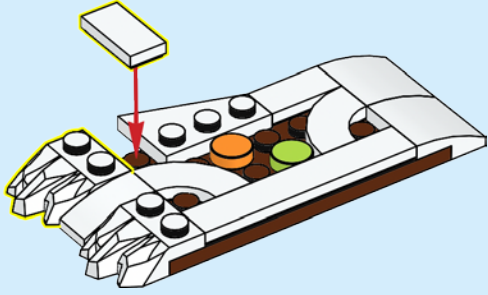

120

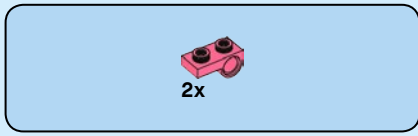
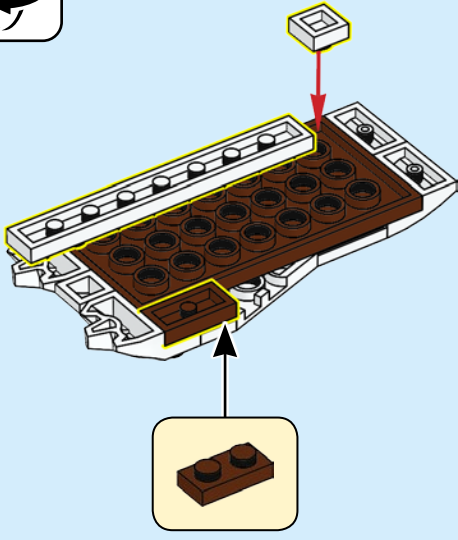

121

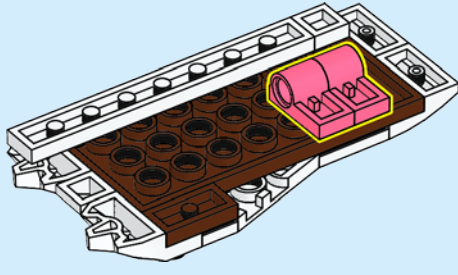

122

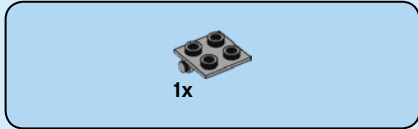
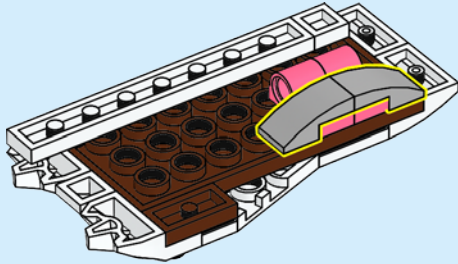

123

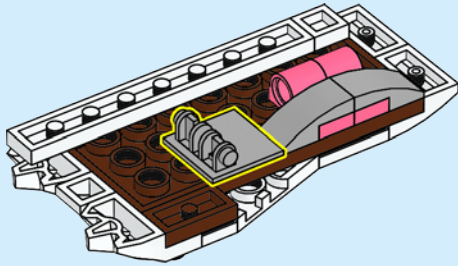

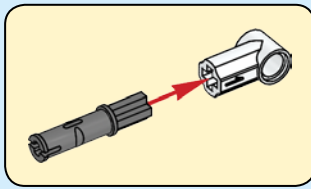
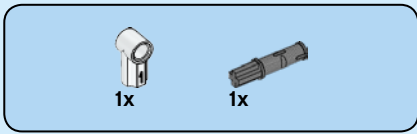

124

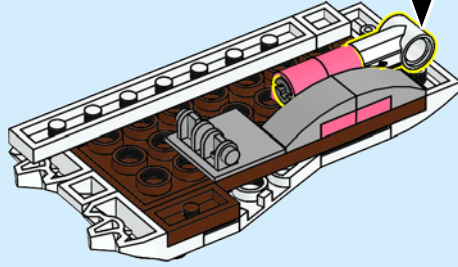

125

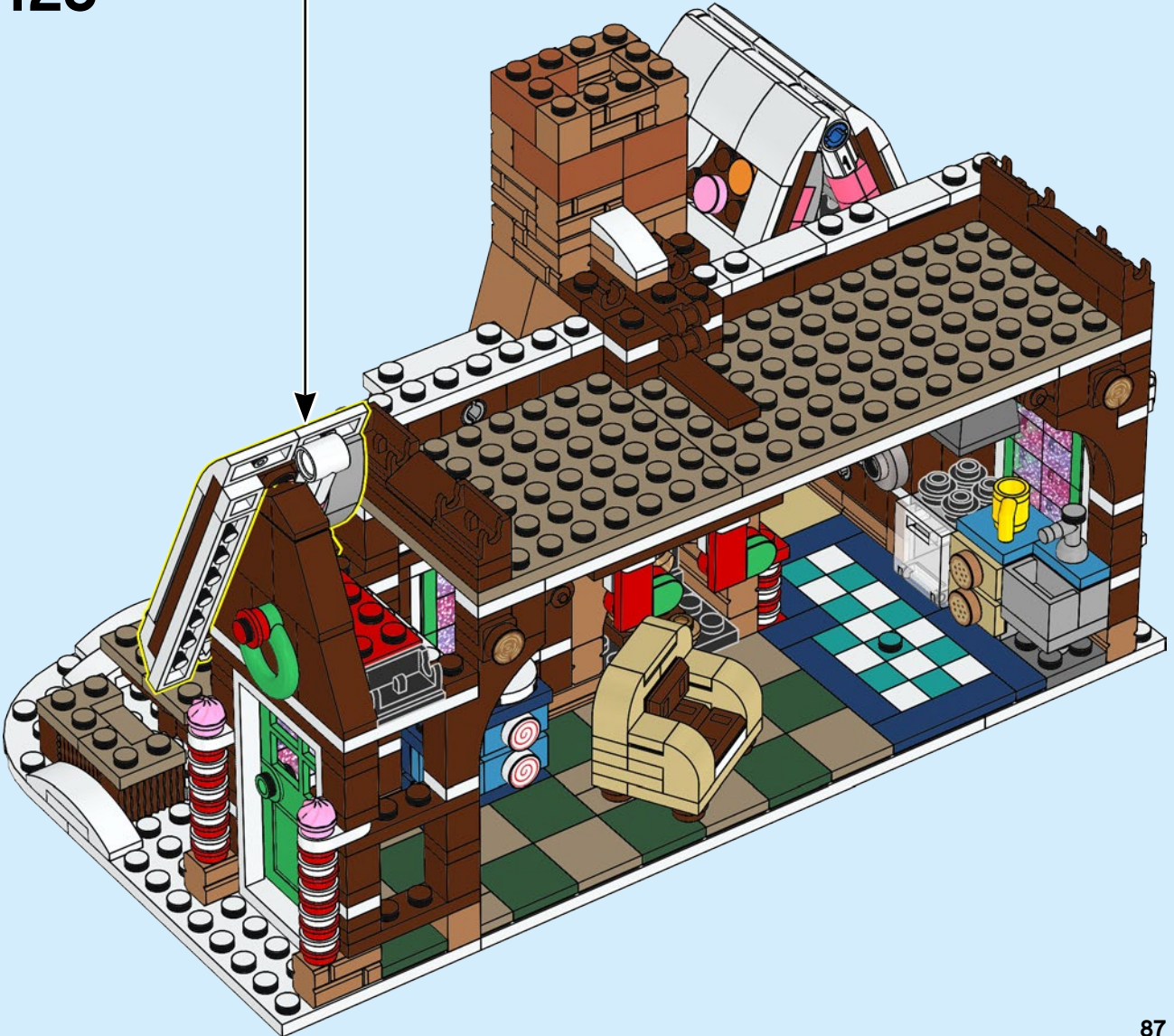



130

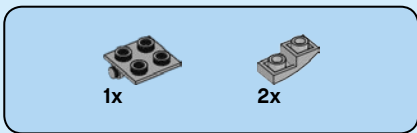
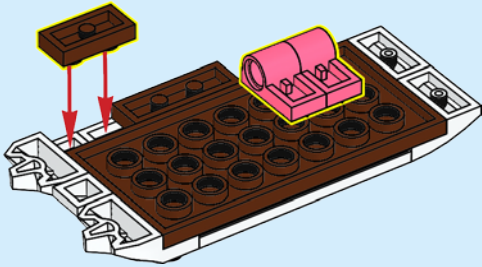

131

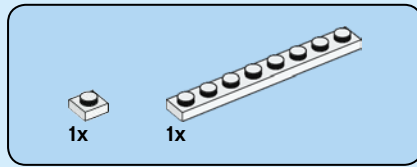
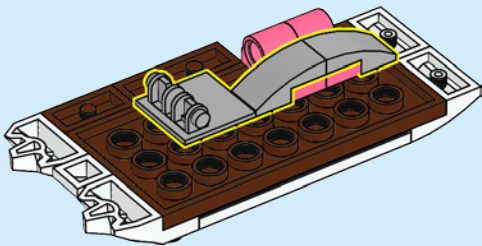

132

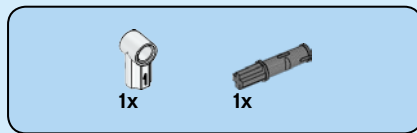
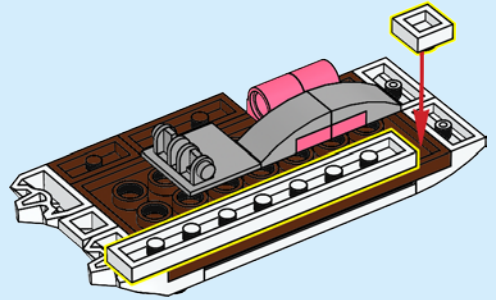

133

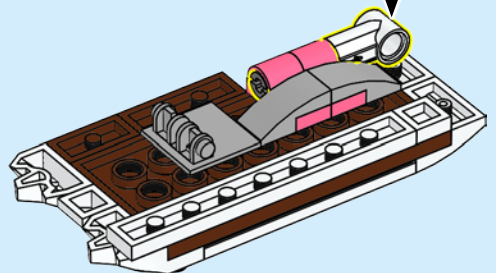
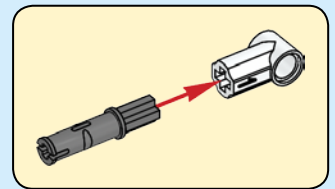

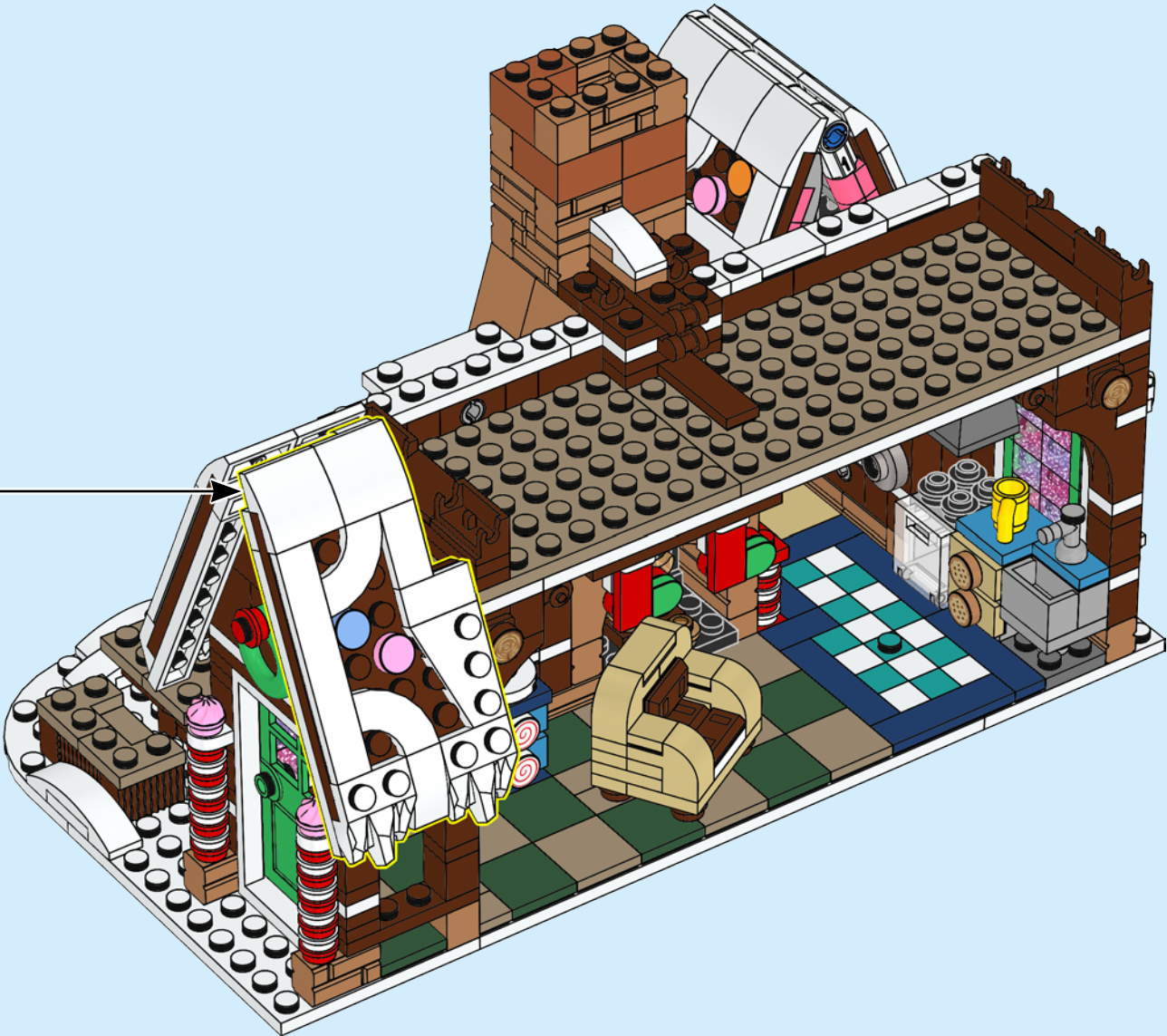

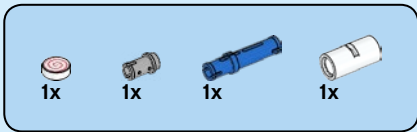

135

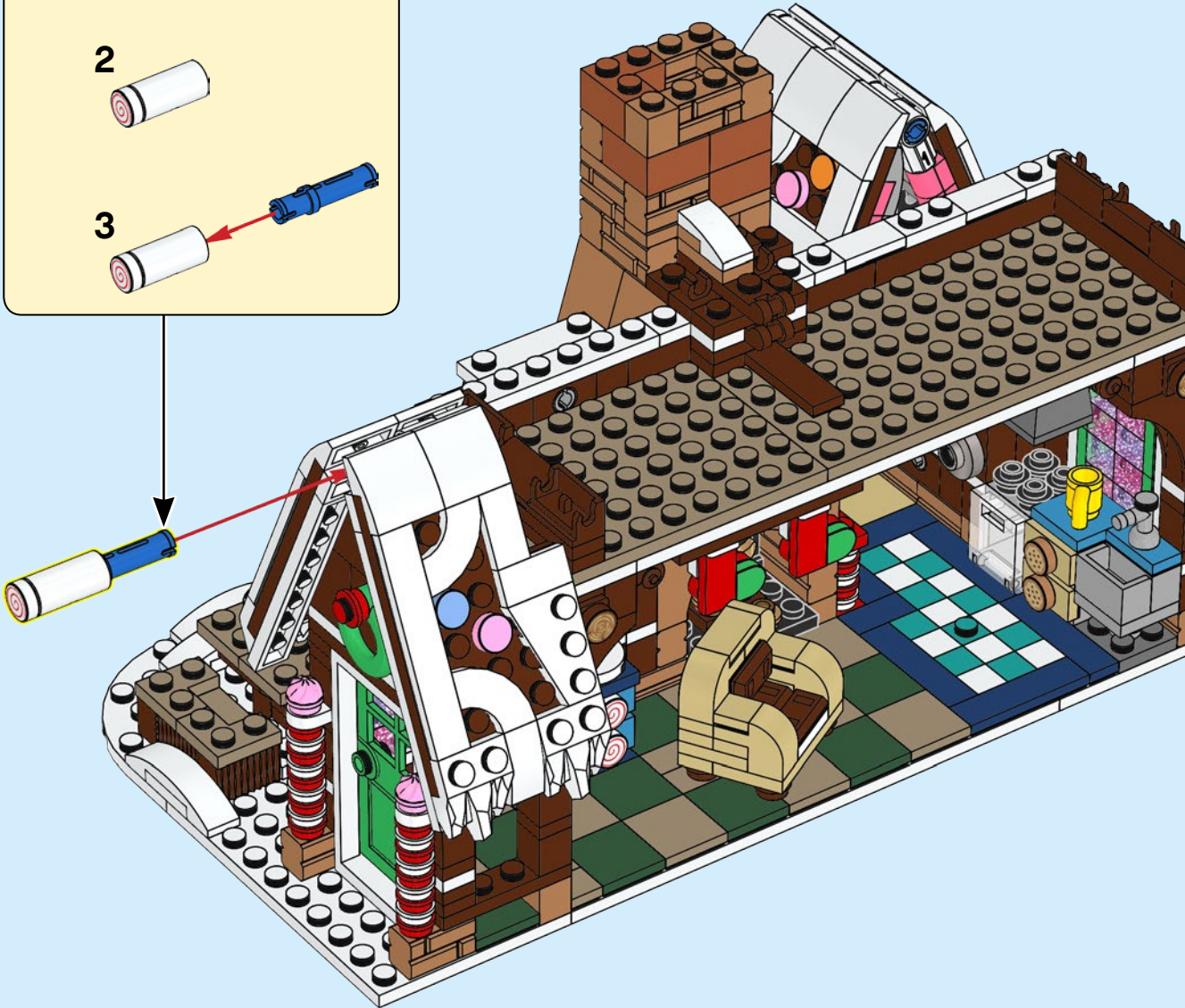
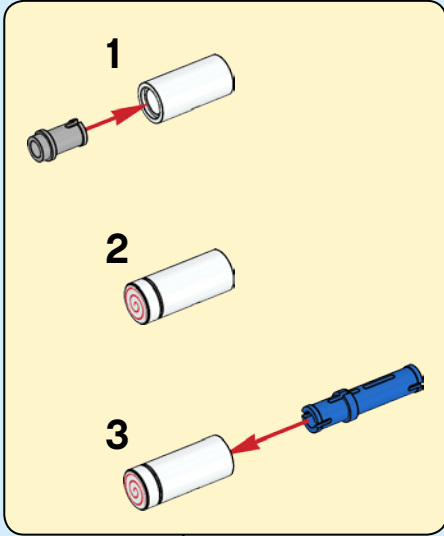

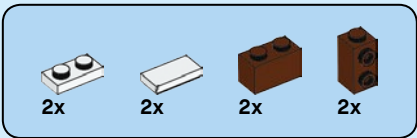

136

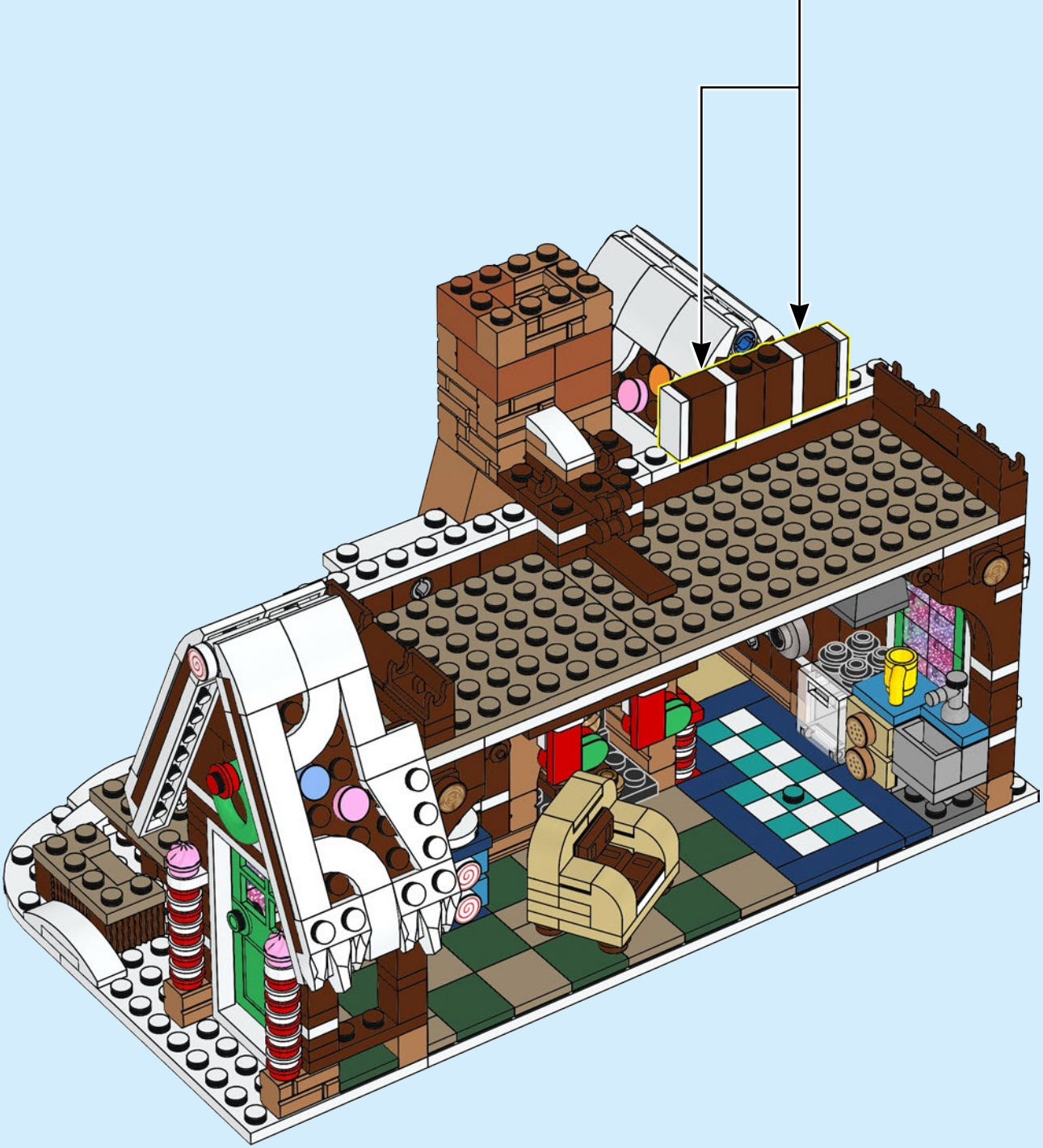
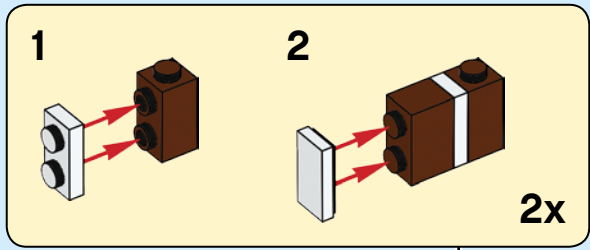

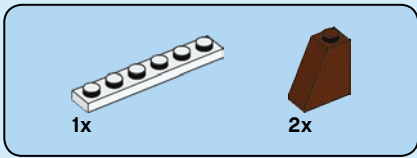

137

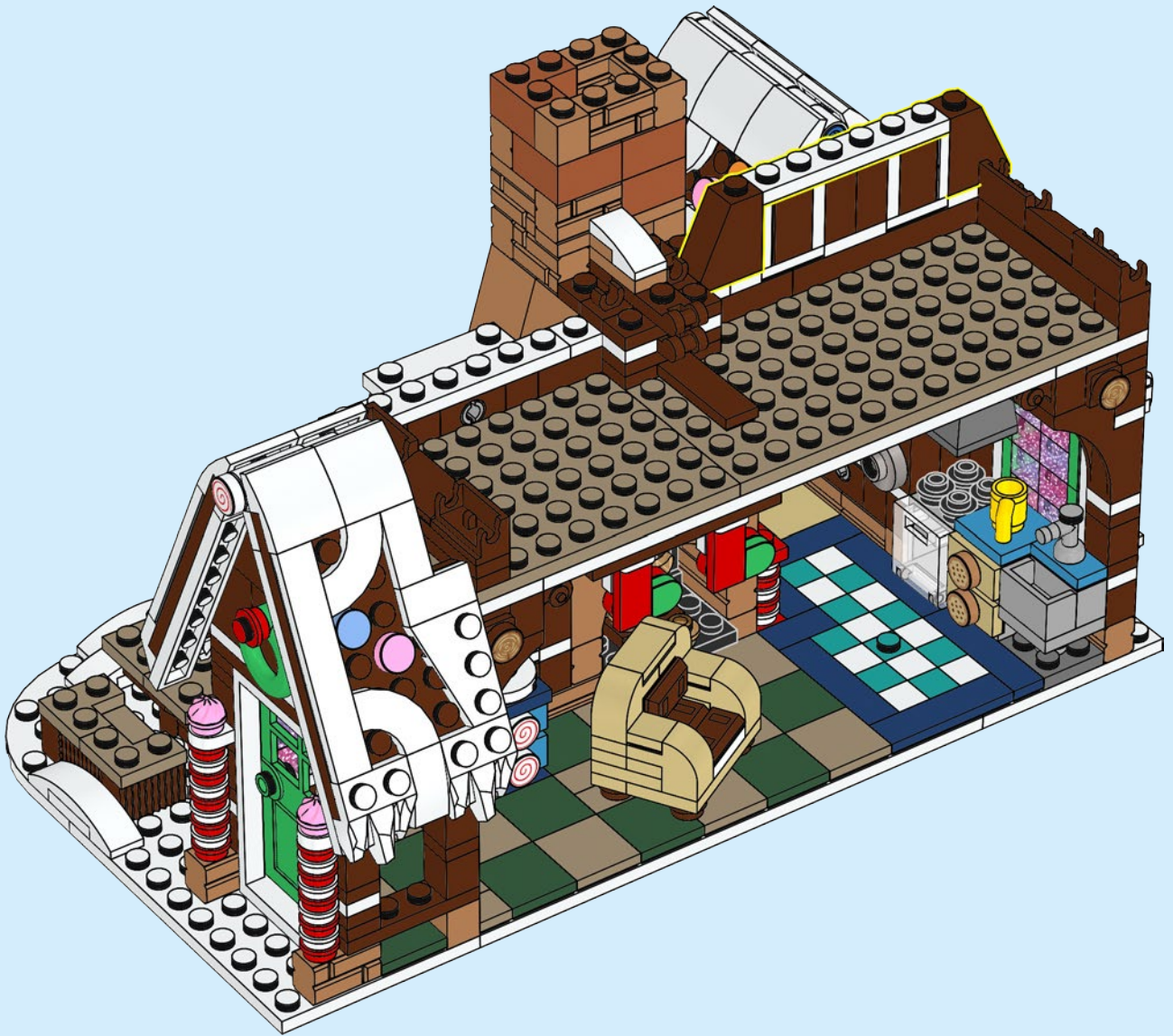

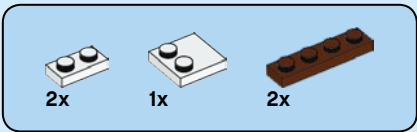

138

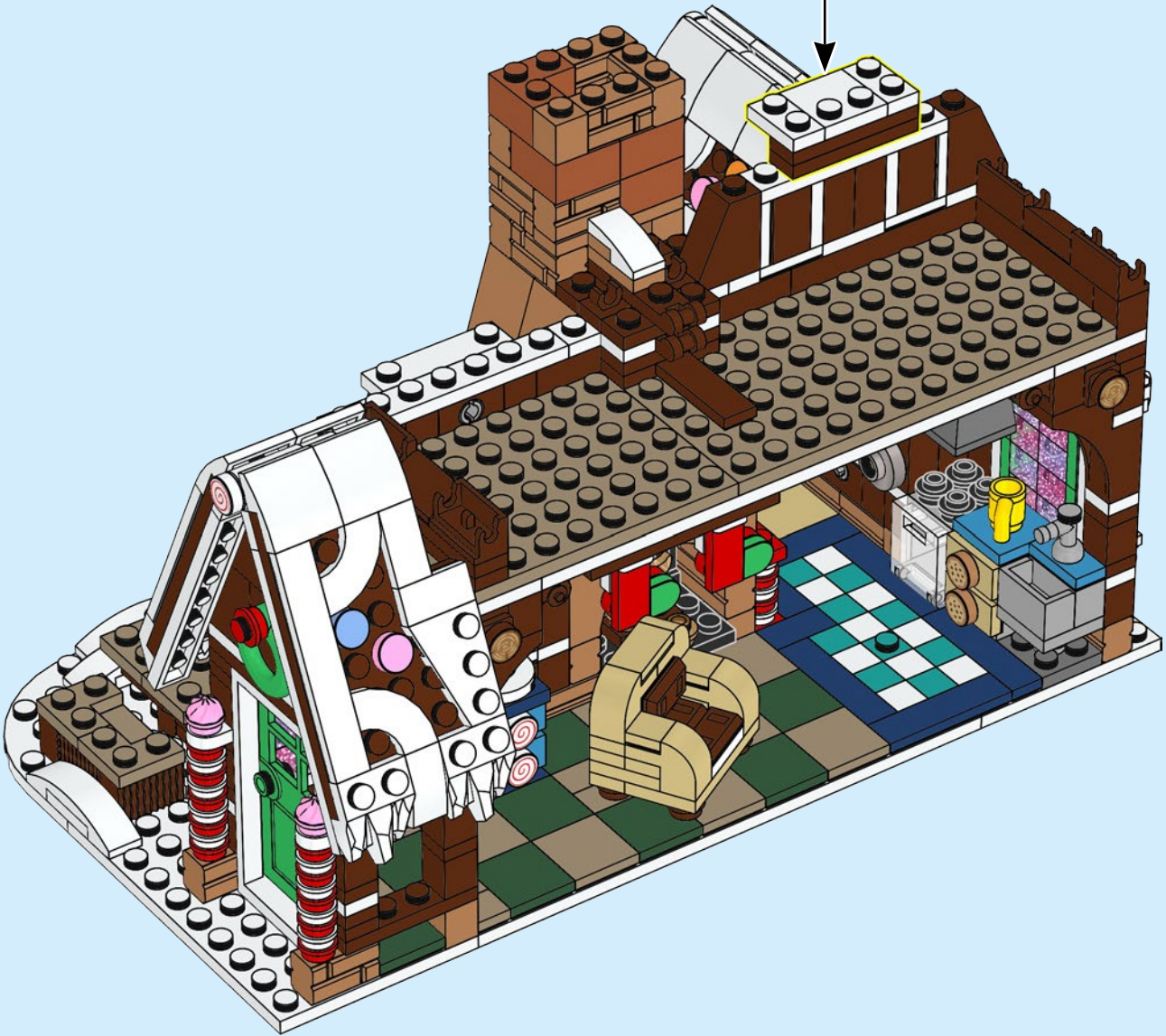
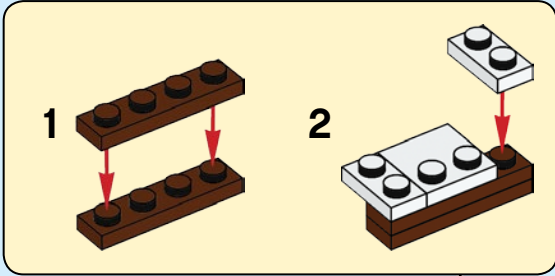

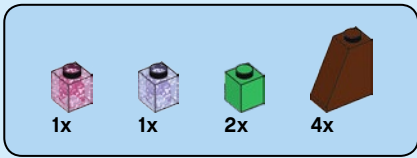

139



4x
2x
2x

140

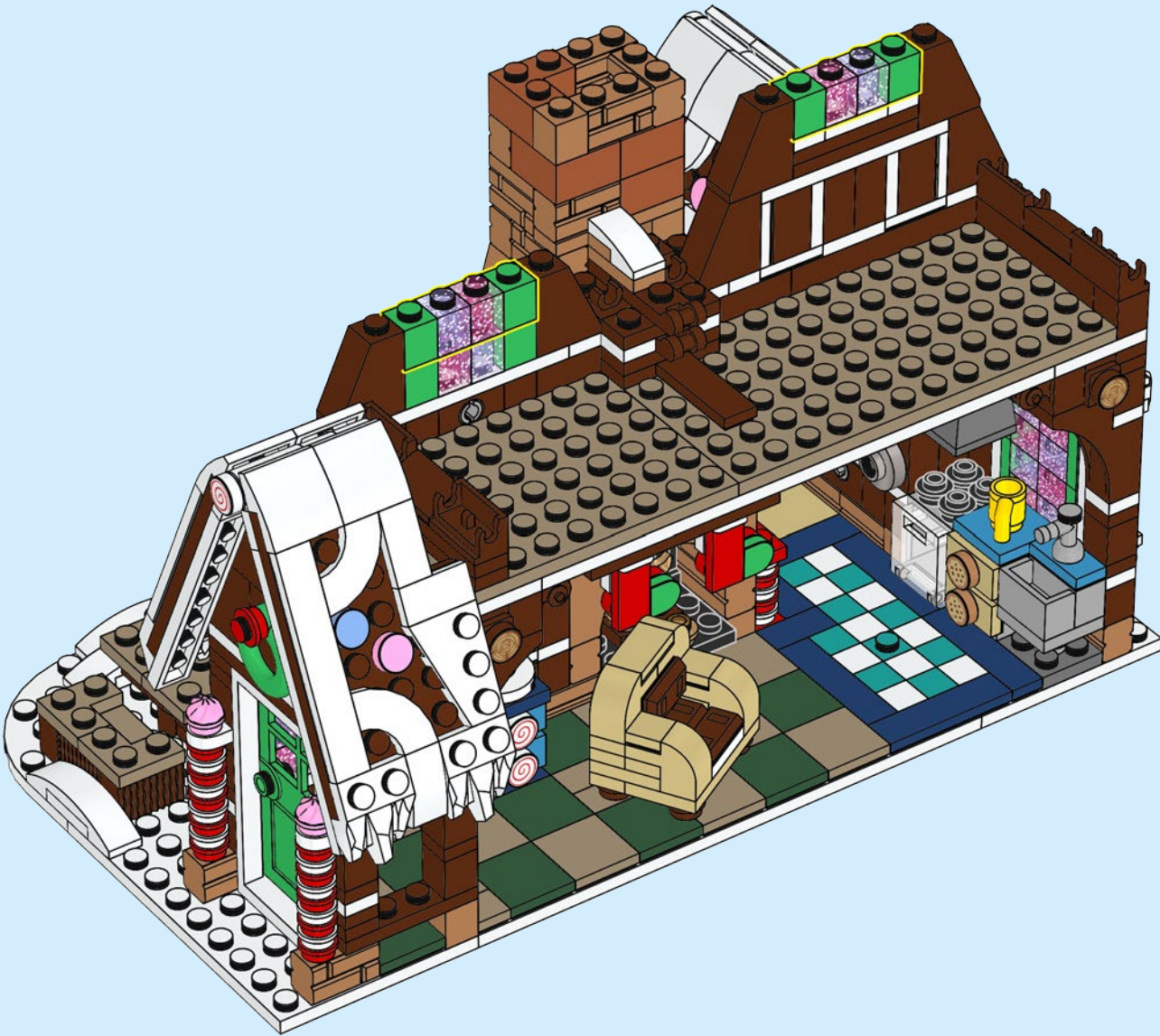

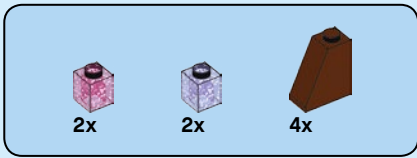

141



10x

14x

142

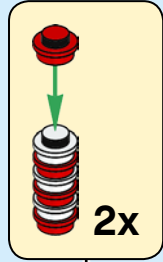
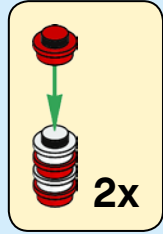

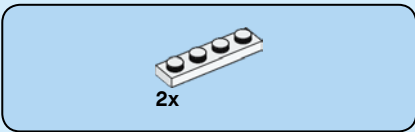

143





1x



3x

144



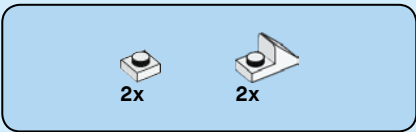

145





6x



1x

146

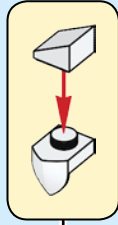

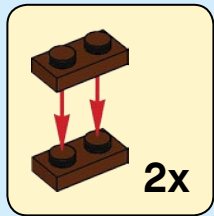
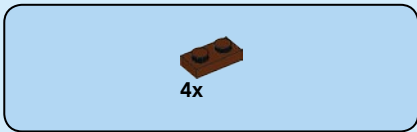

147



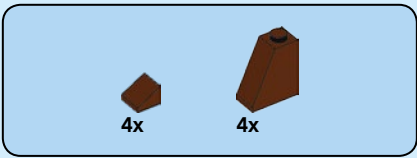

148

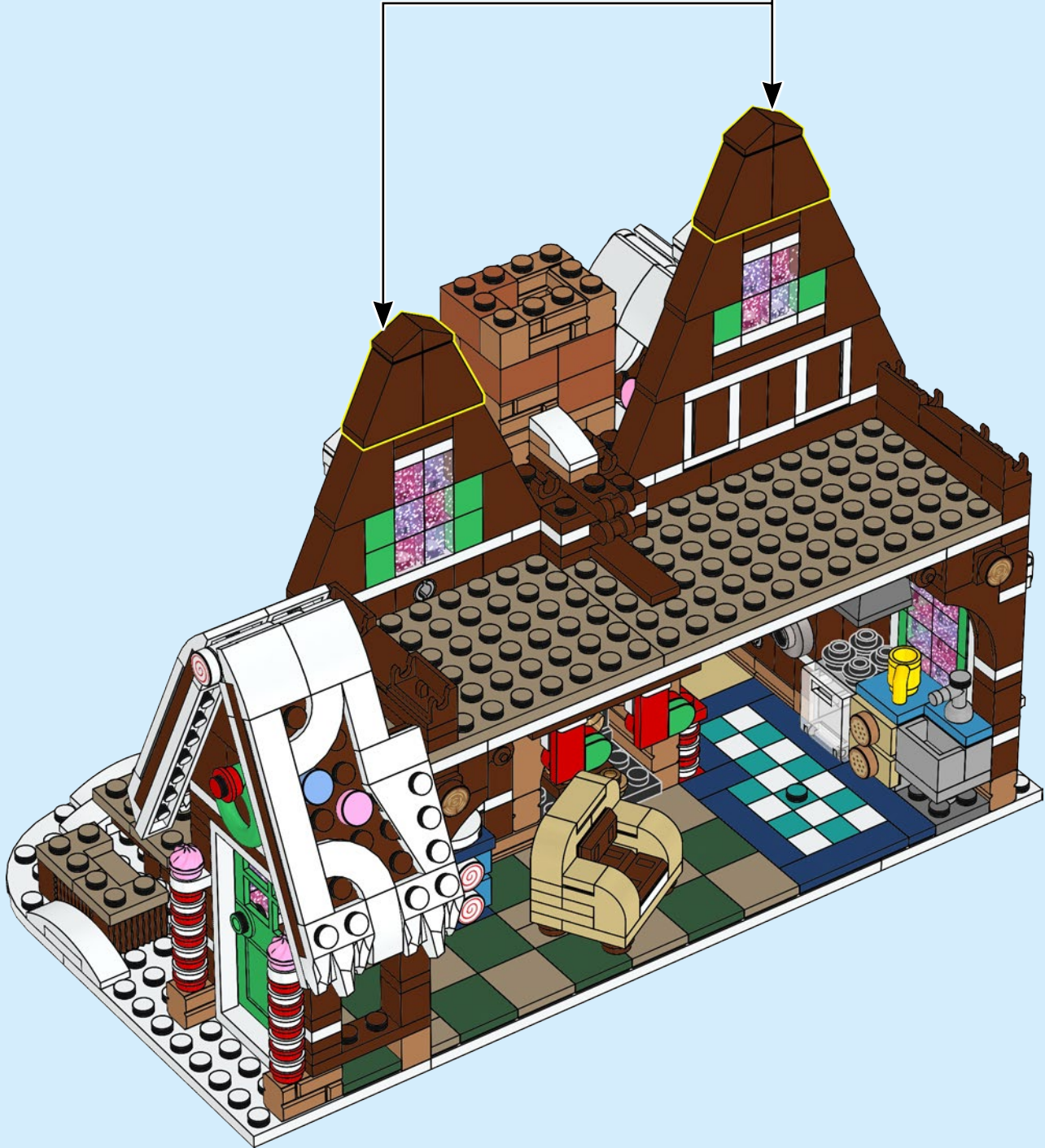
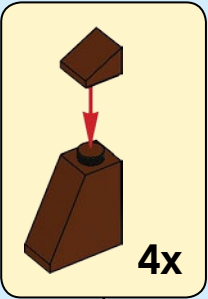

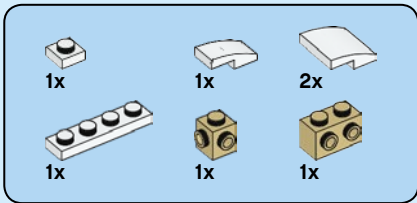

149

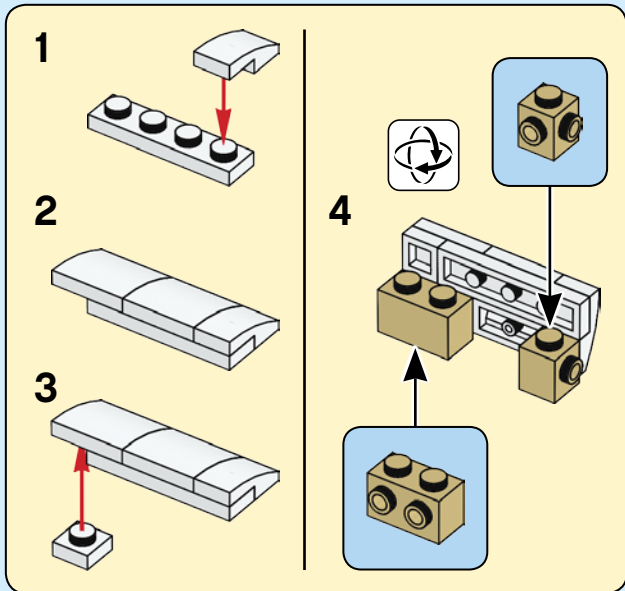



1x



1x

150



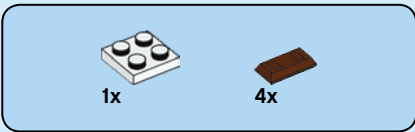

151

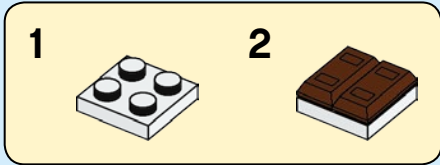

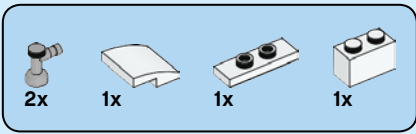

152

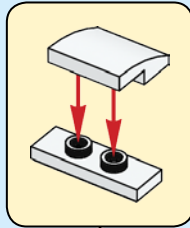
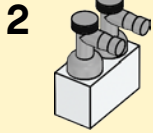
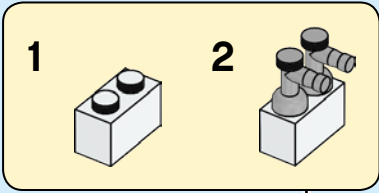

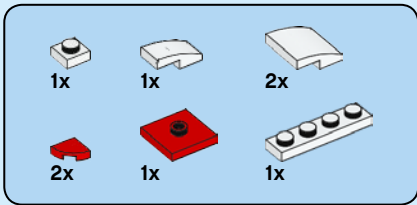

153

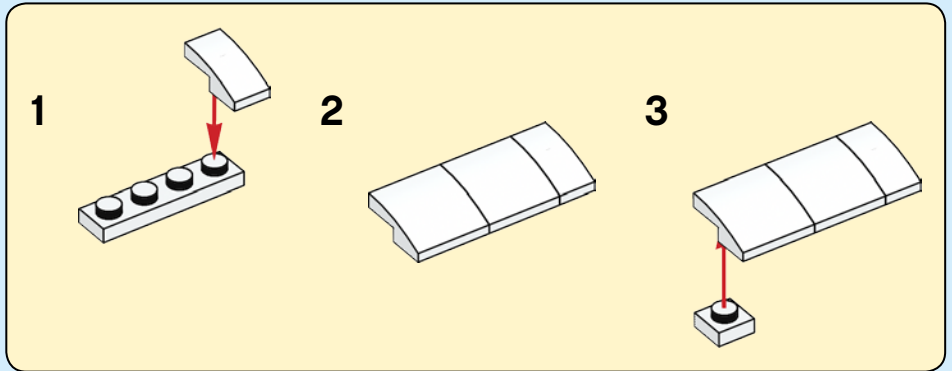

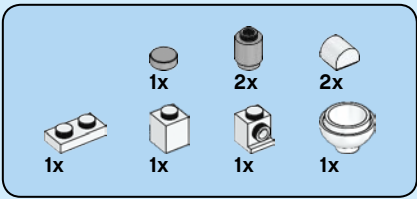

154

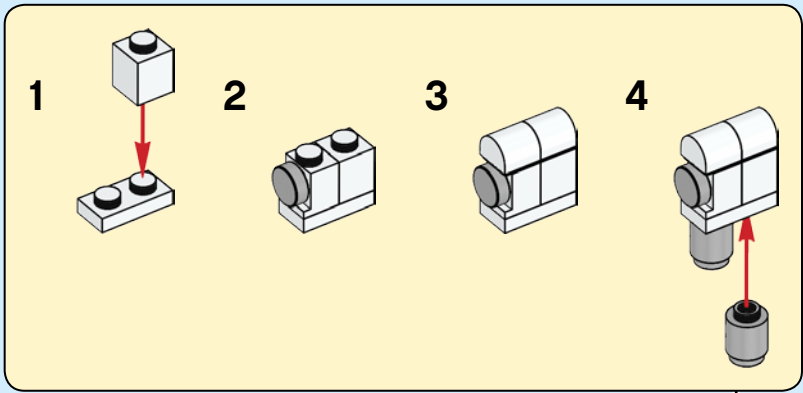



5x

155



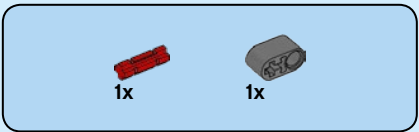

156

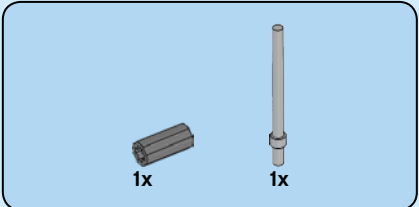
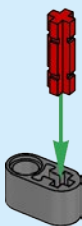

157

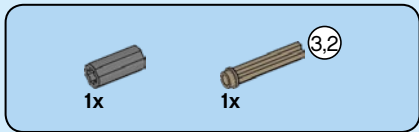
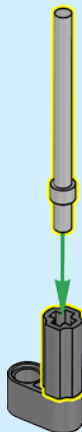

158



159

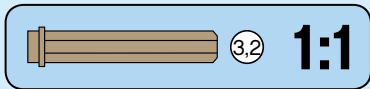
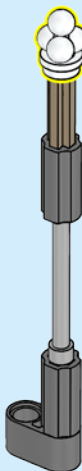



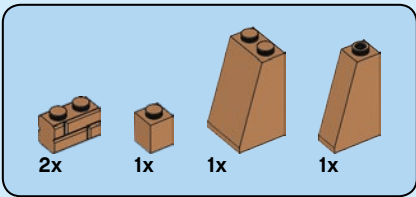

161

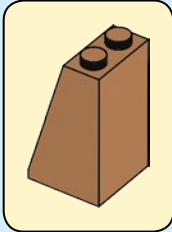

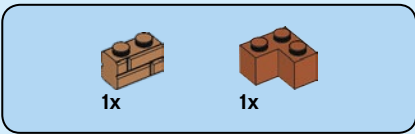

162



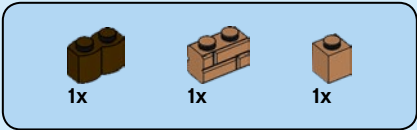

163



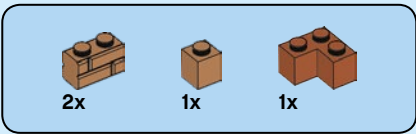

164





4x

165



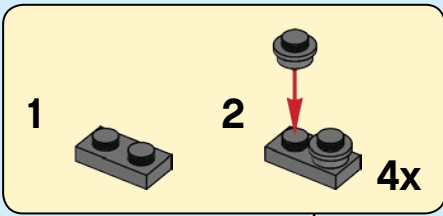
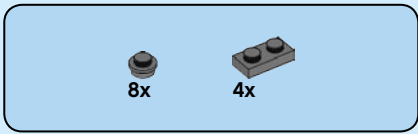

166





4x

167



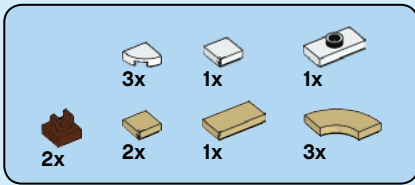

168



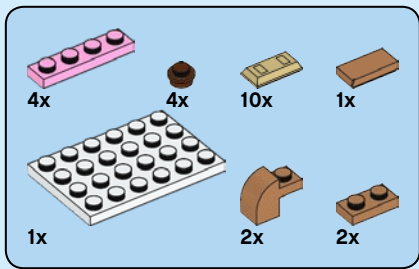

169

1

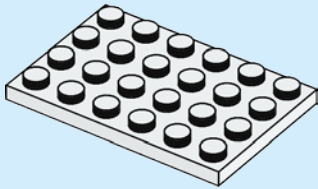

2

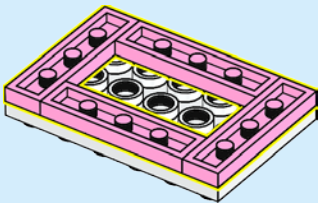

3

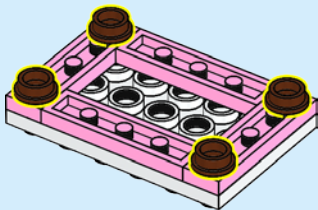

4

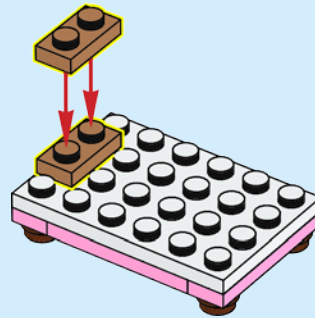
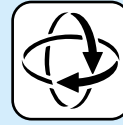

5

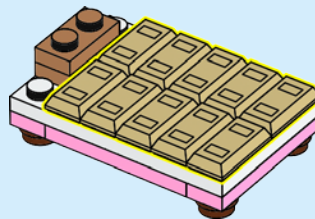

6

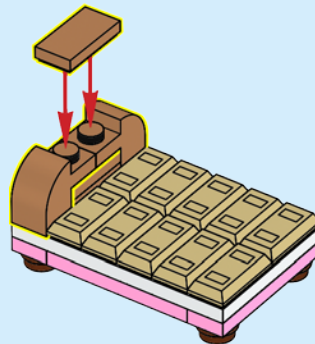



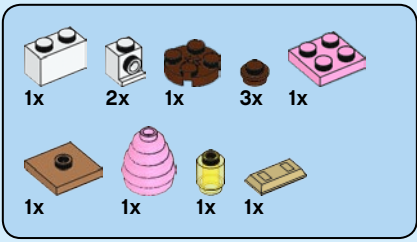

170

1

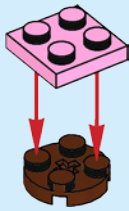

2

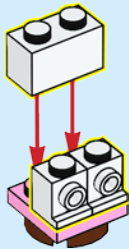

3

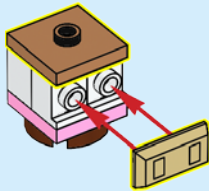

4

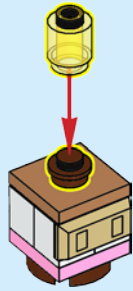

5



6





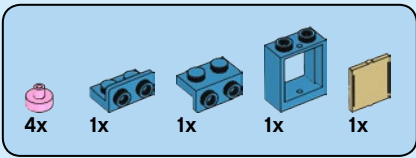

171

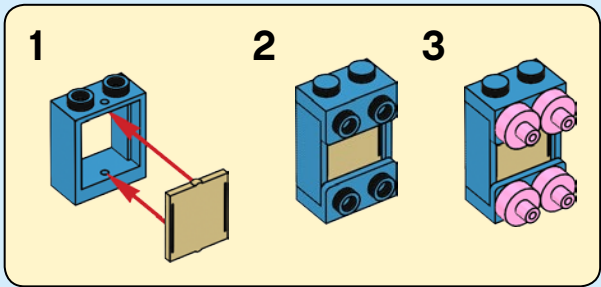

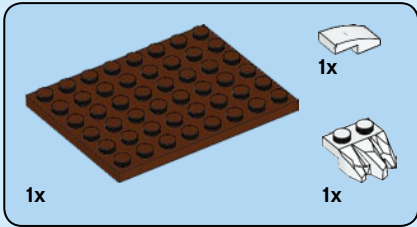

172

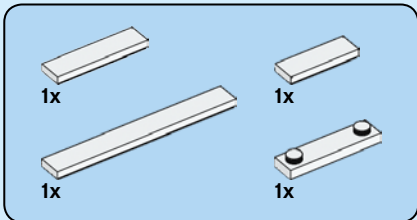
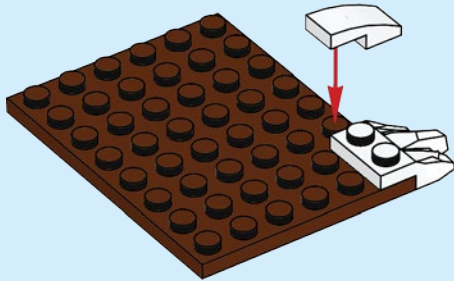

173

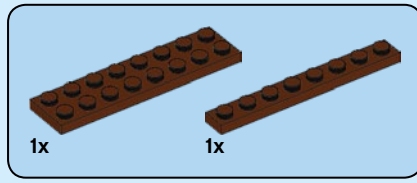
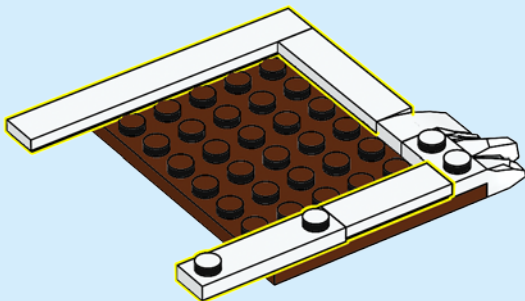

174

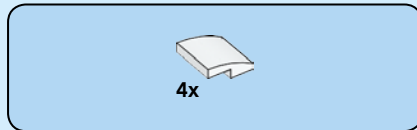
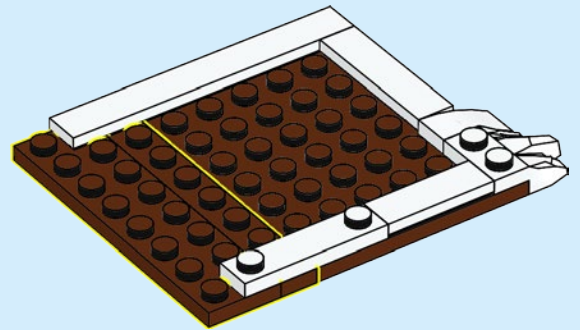

175

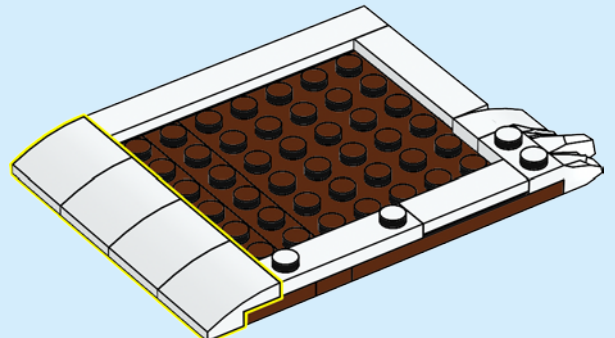

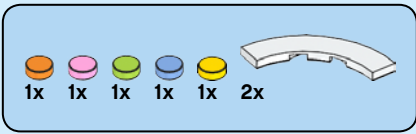

176

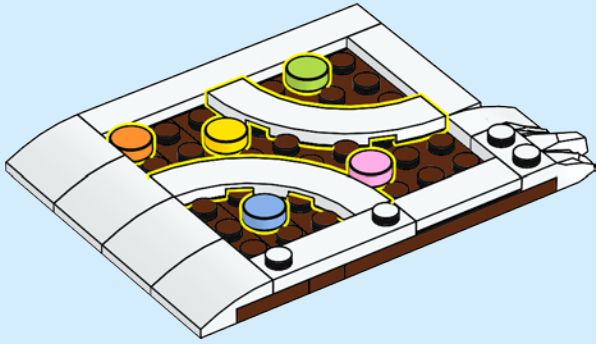

178

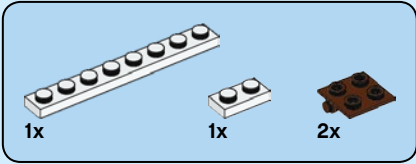
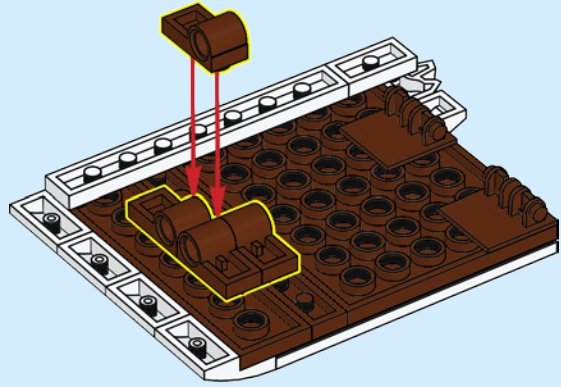

177

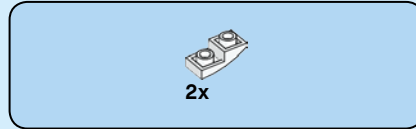
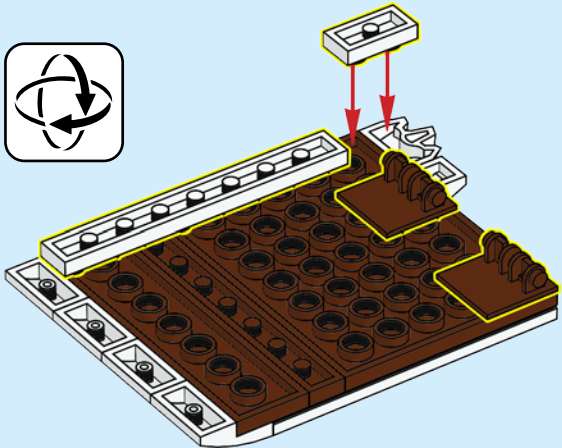

179

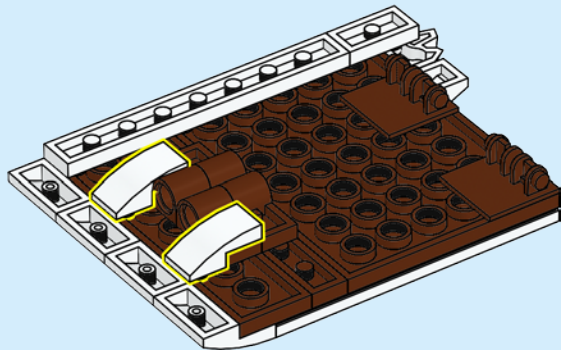

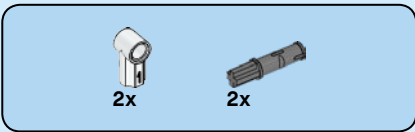

180

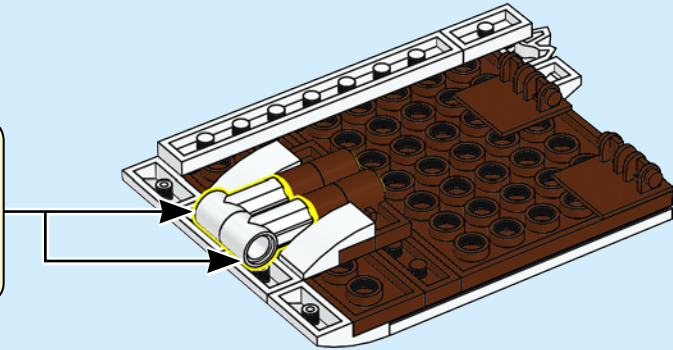
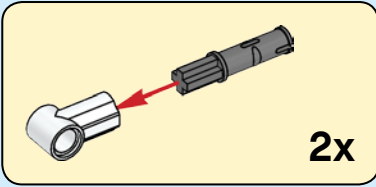

181



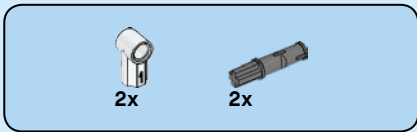

186

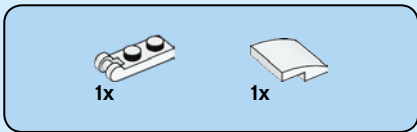
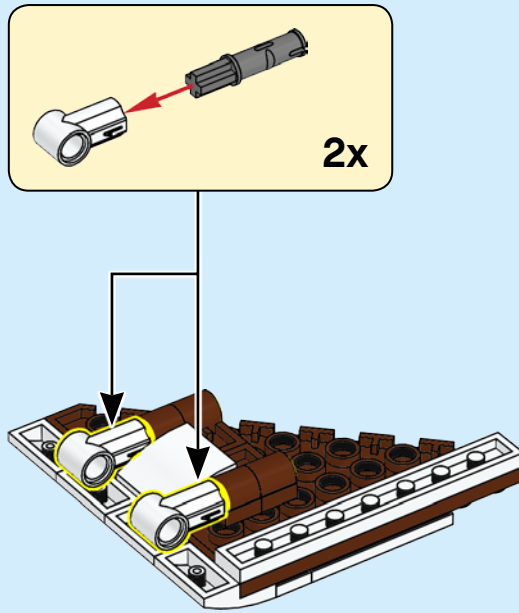

187

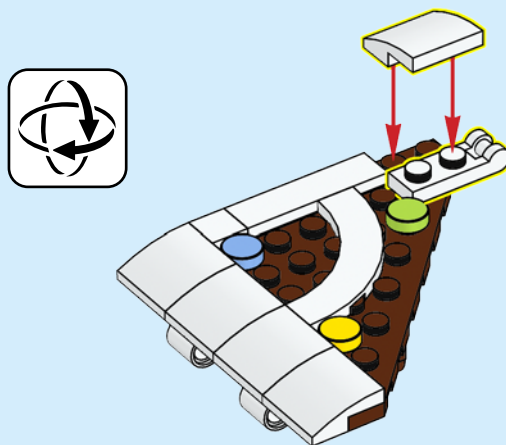



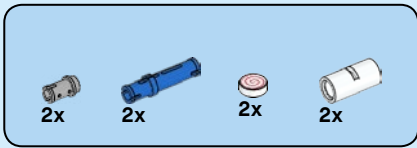

189

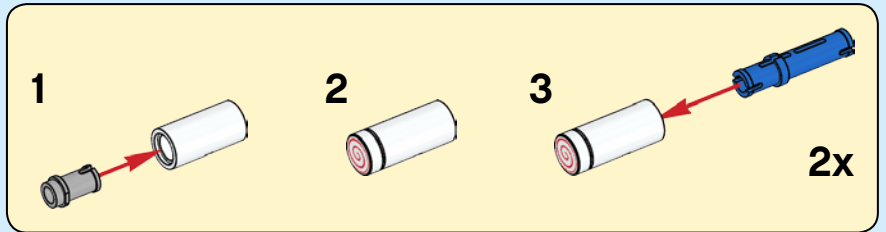

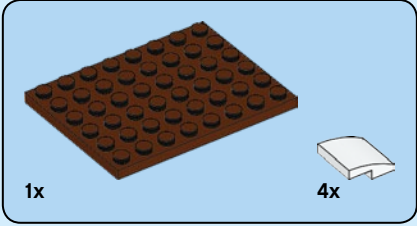
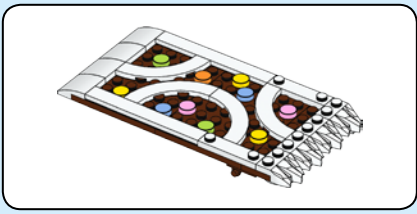

190

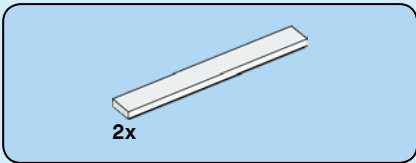
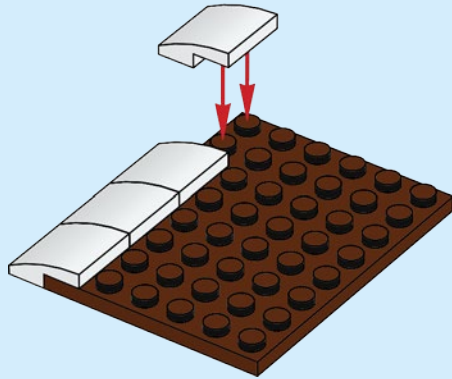

191

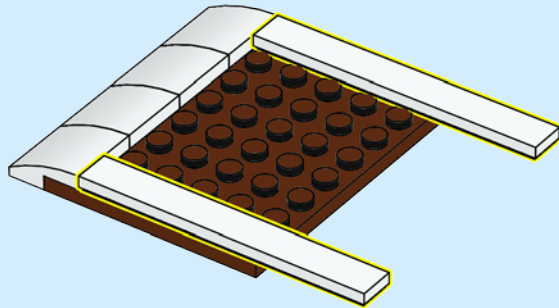

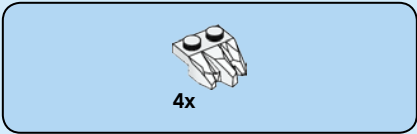

195

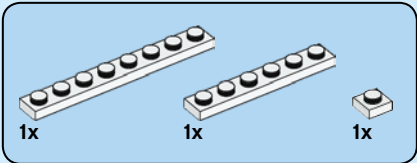
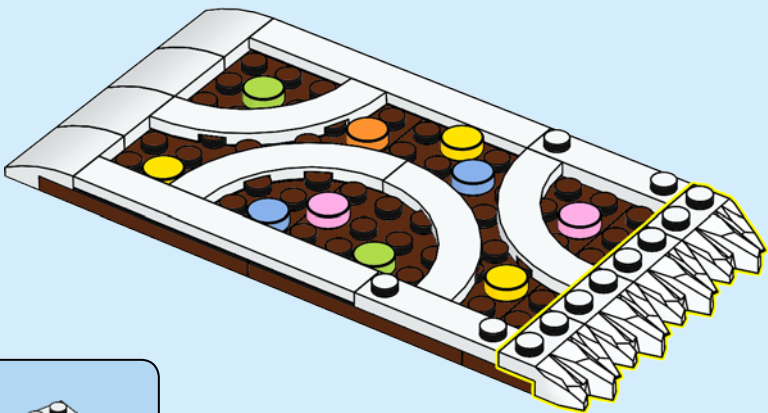

196

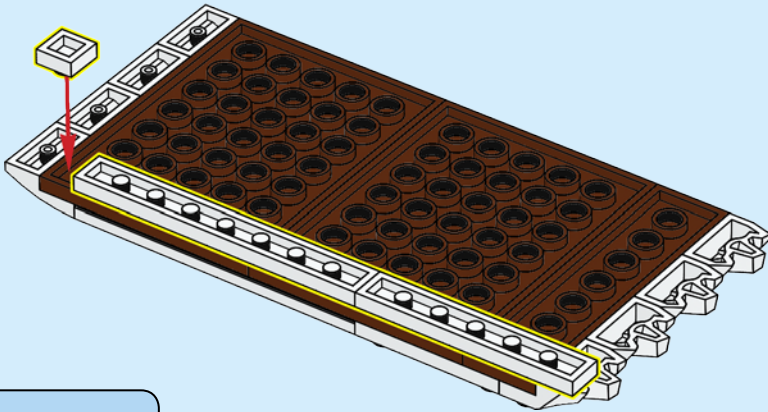

197

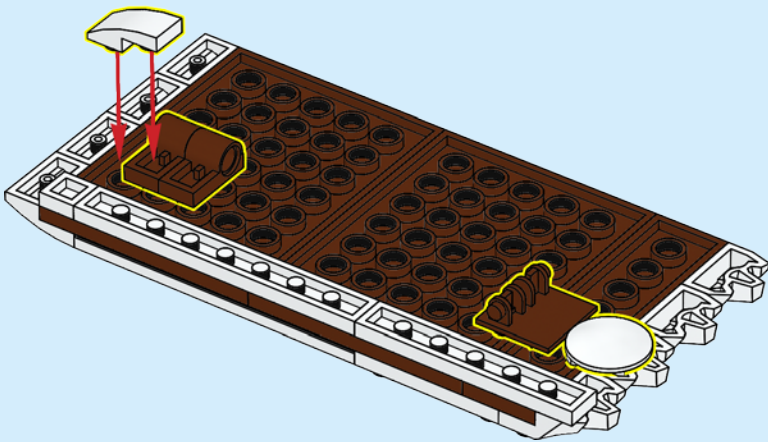

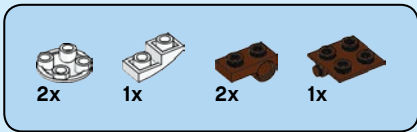

198

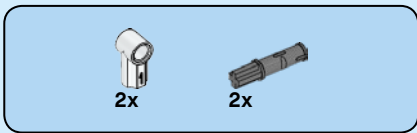
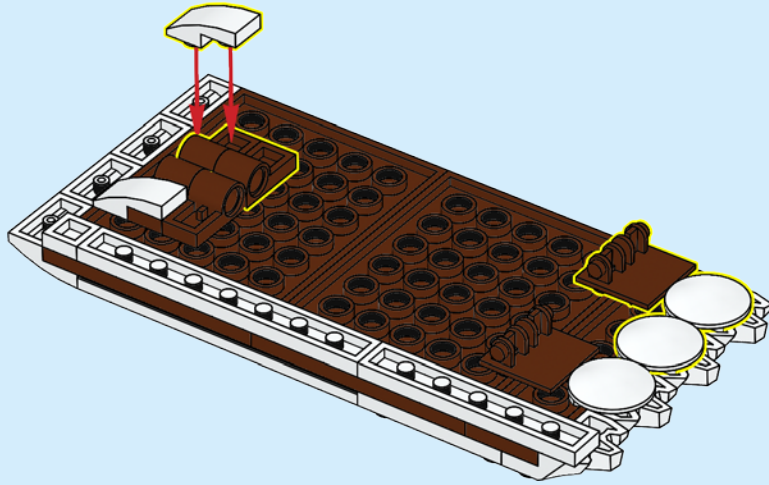

199

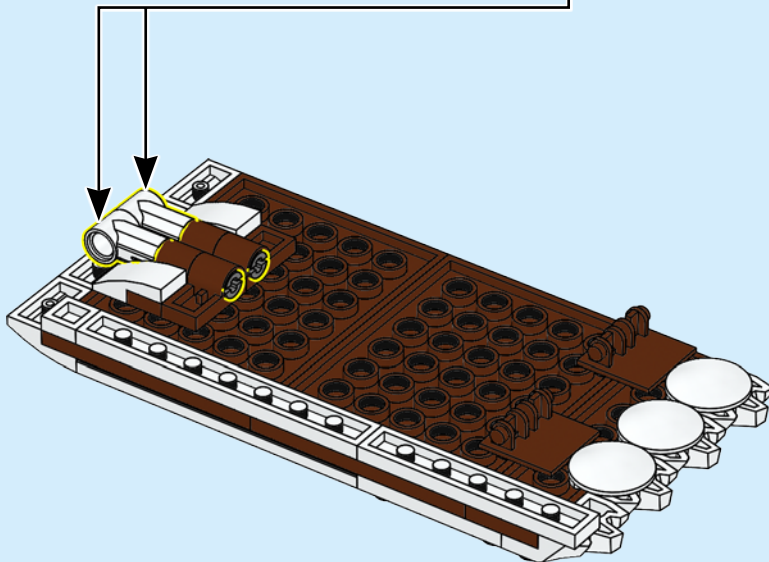
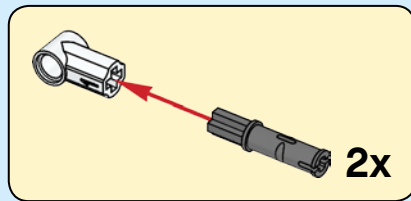



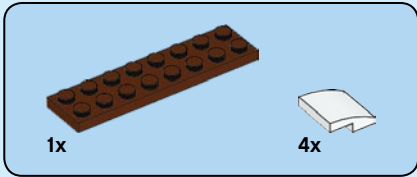

201

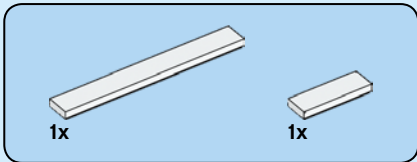
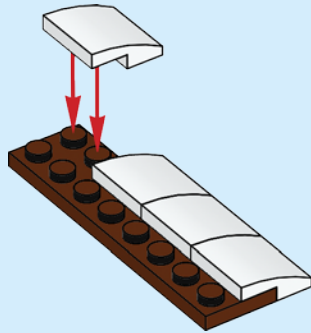

202

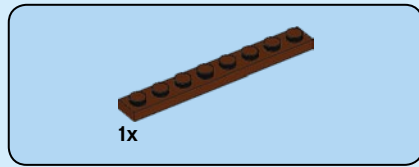
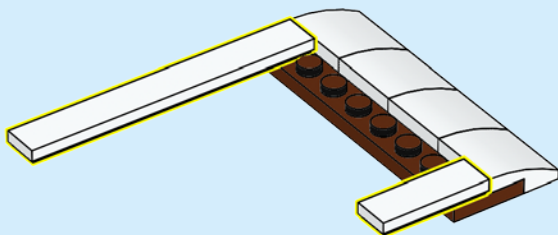

203

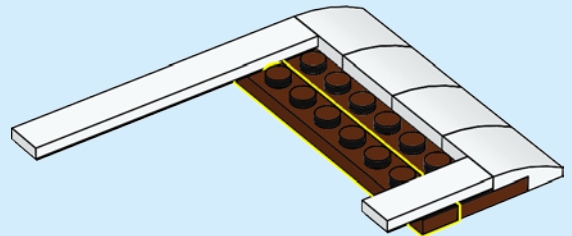

204

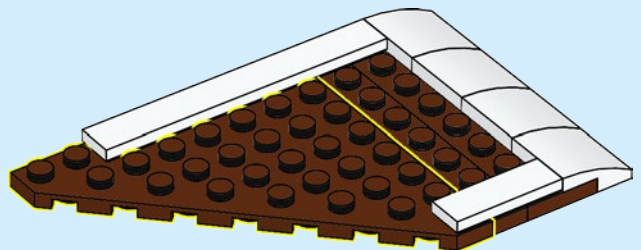

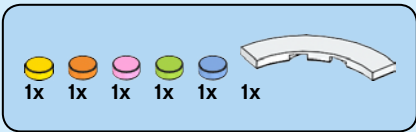

205

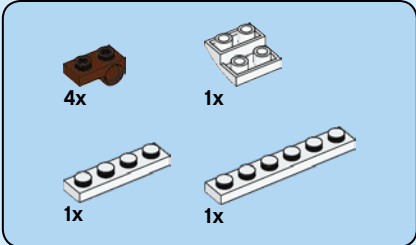
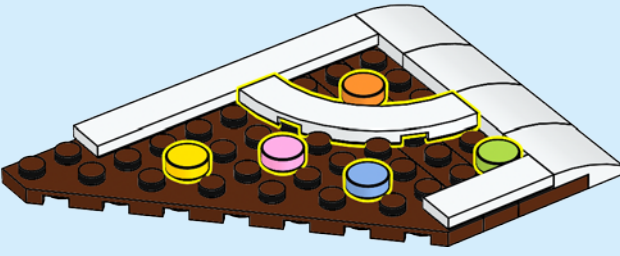

206

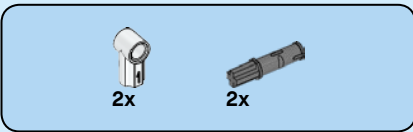
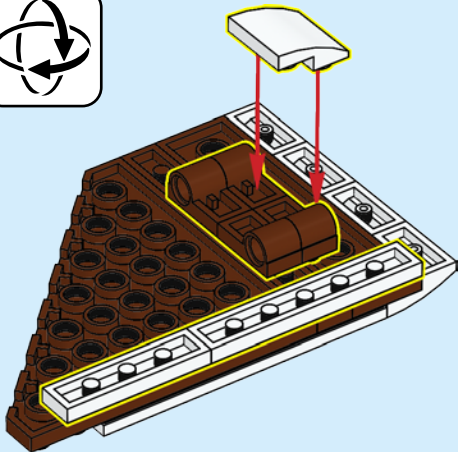

207

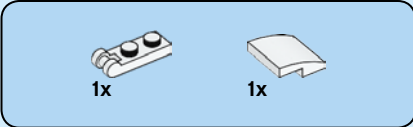
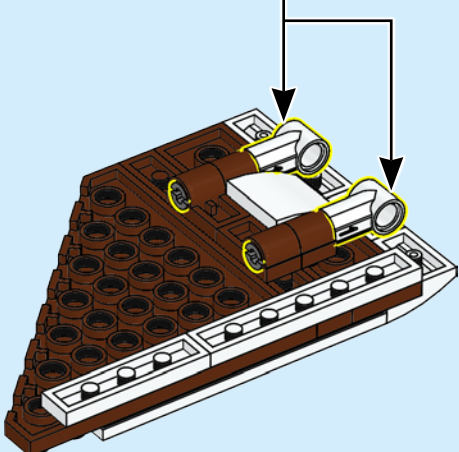
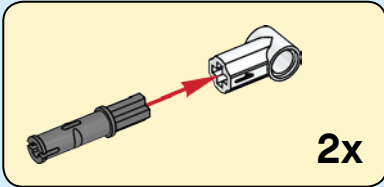

208

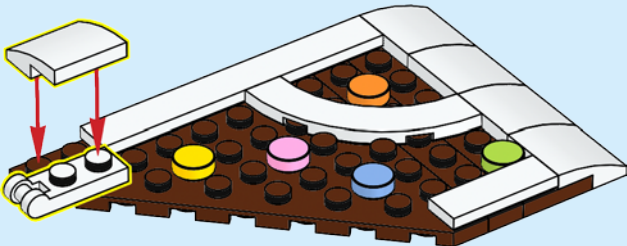



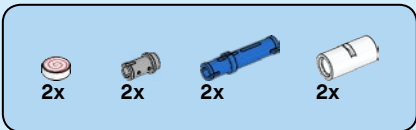

210

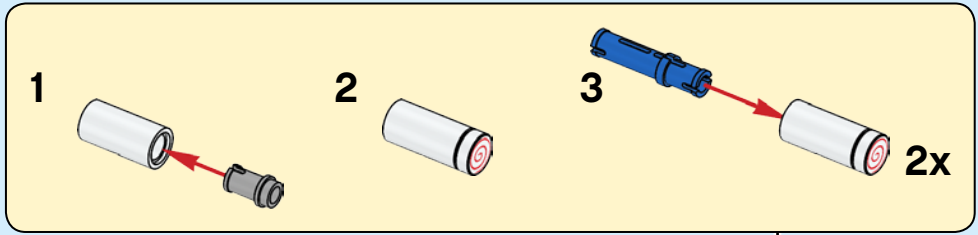

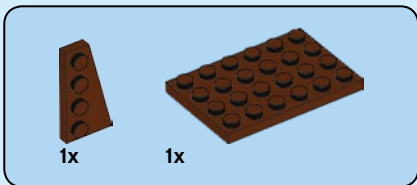

211

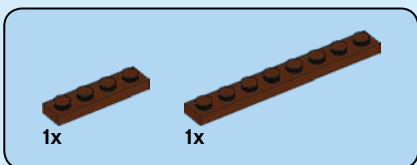
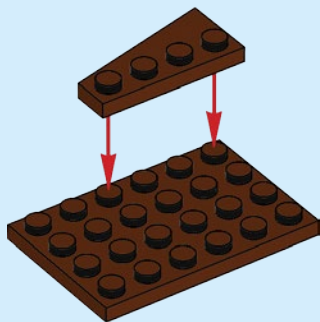

212

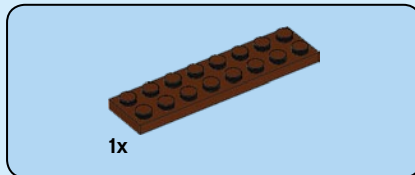
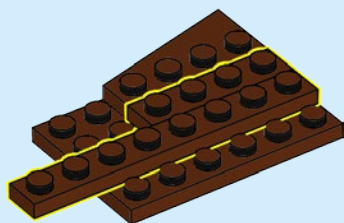

213

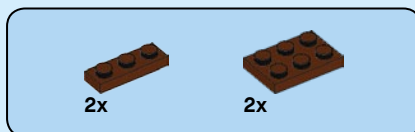
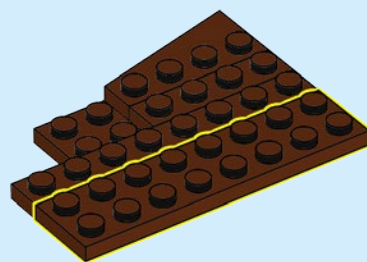

214

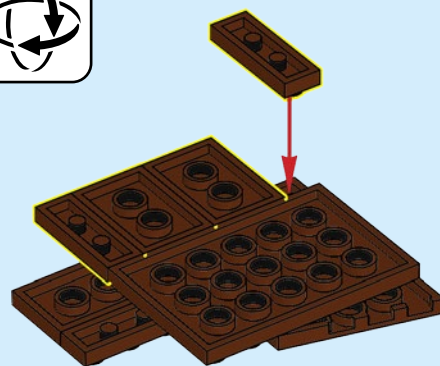

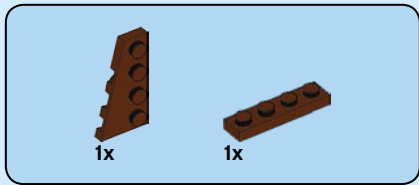

215

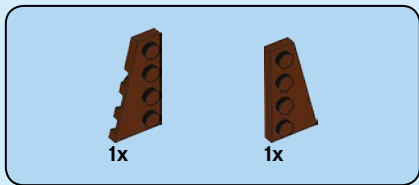
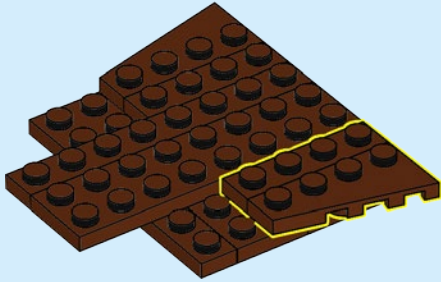

216

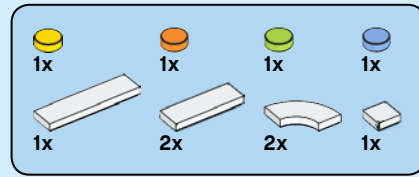
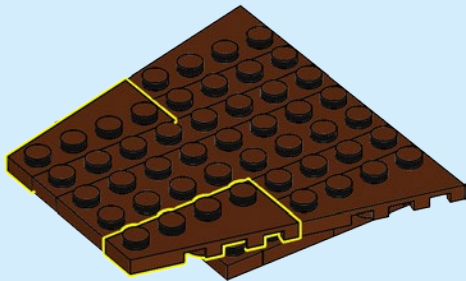

217

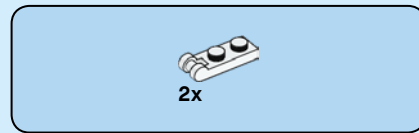
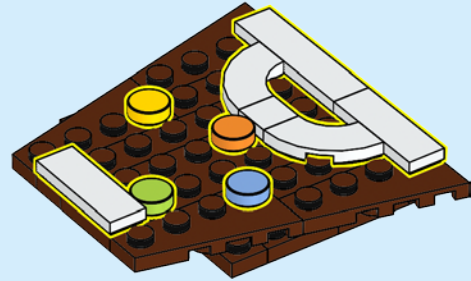

218

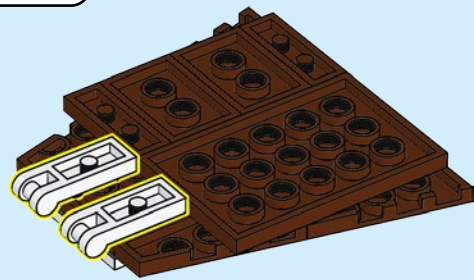
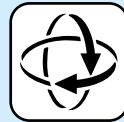

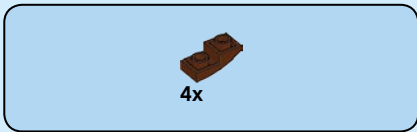

219

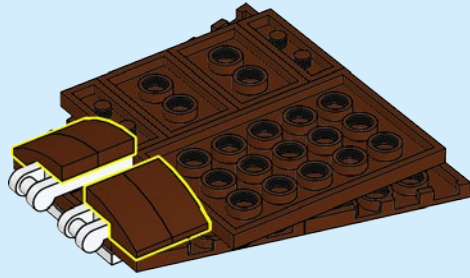

220

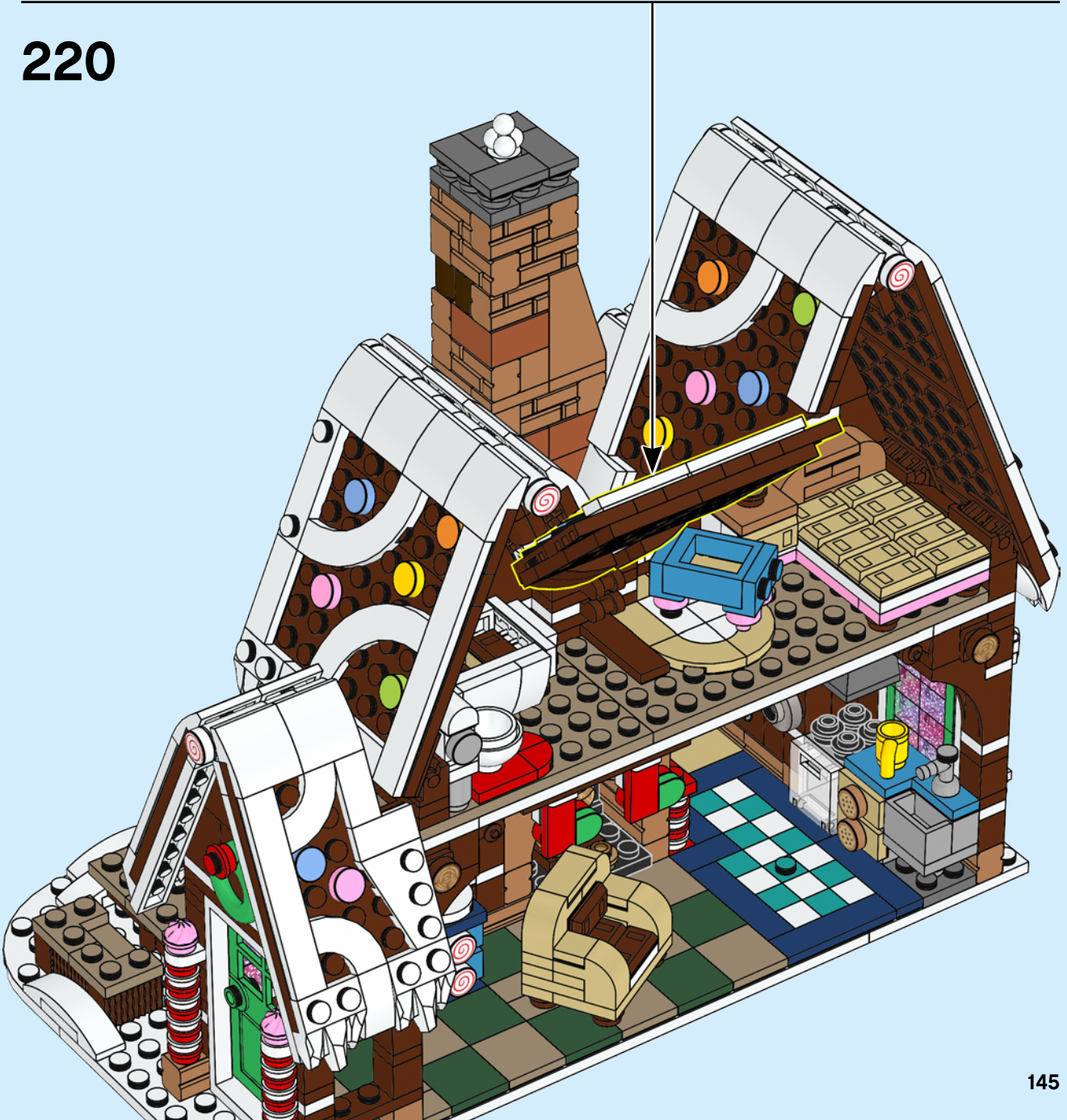

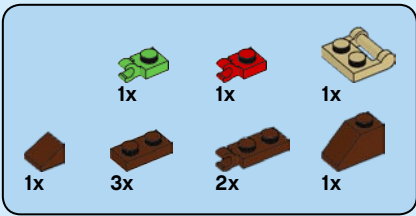

221

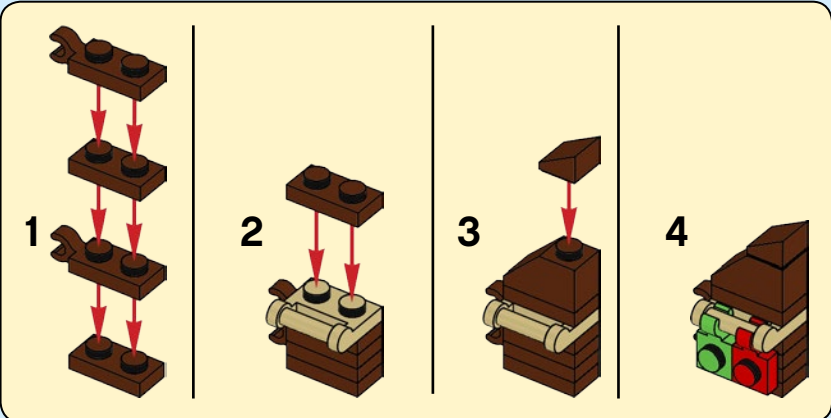

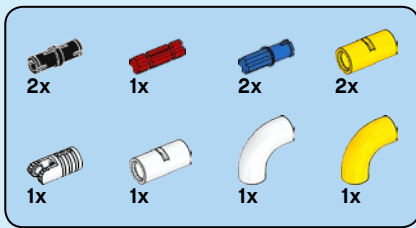

222

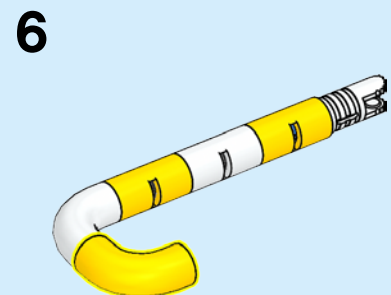
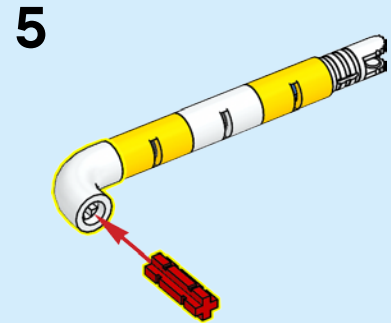
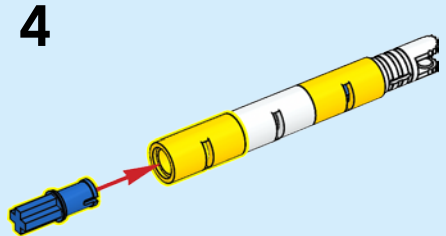
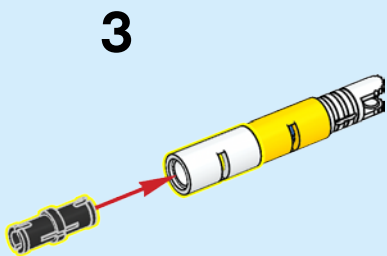
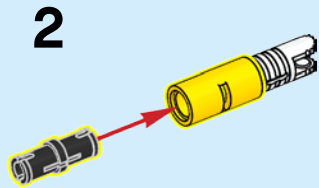
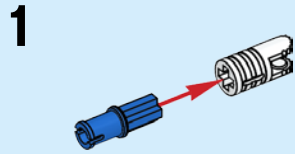



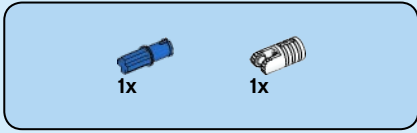

223

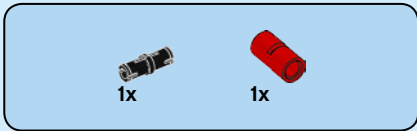
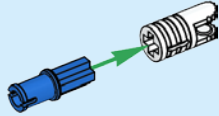

224

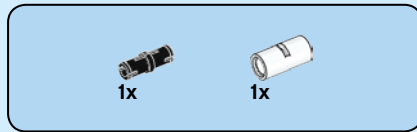
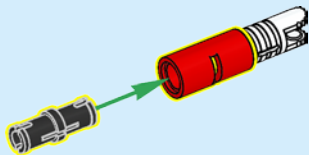

225

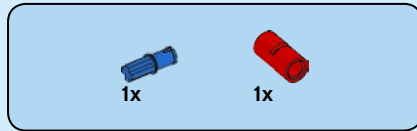
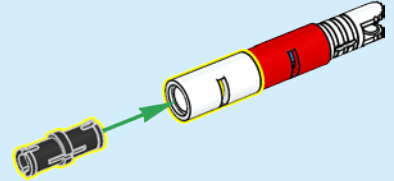

226

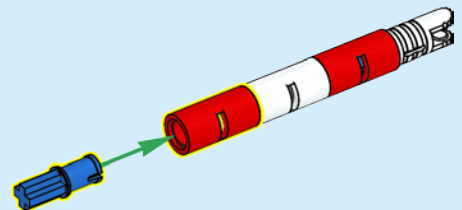

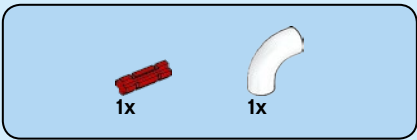

227

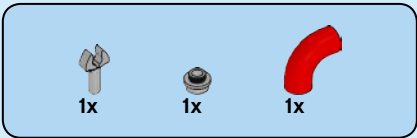
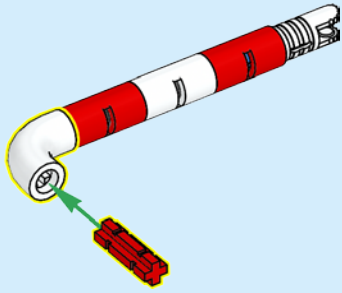

228

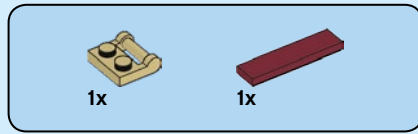
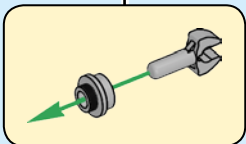
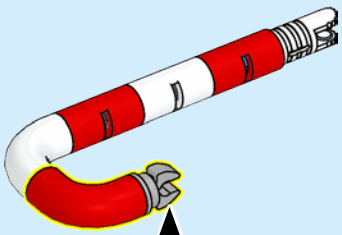

229

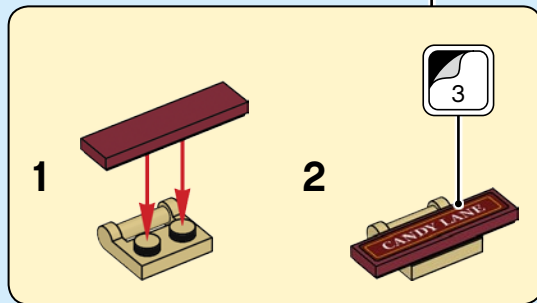
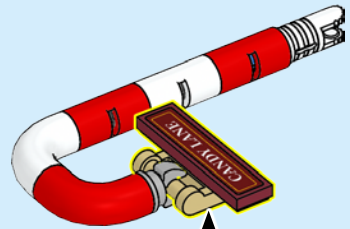



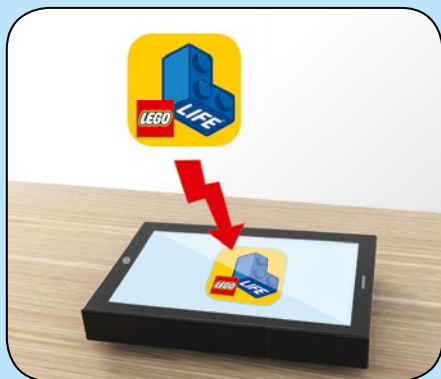

2x
6234807

1x
306201

32x
614101

2x
625401

1x
6177114

12x
4118981

23x
302401

11x
4504369

5x
6172366

4x
6258135

3x
407001

12x
307001

1x
300501

12x
6046905

2x
6242241

4x
6210272

1x
4613256

1x
4179874

1x
4179875

2x
4547489

2x
6194850

1x
6050914

3x
4278271

2x
6194851

1x
6093053

2x
6069002

9x
6173116

1x
6051511

26x
302301

6x
6034044

2x
300401

14x
306901

2x
4262011

4x
6172927

1x
6070698

1x
6097637

13x
6181319

1x
6093526

5x
302201

2x
6218822

2x
6210385

33x
6047220

12x
6172674

2x
242001

4x
4515364

1x
4179580

1x
6195371

1x
362301

6x
4558168

1x
302101

4x
4597131

6x
243101

8x
371001

6x
6023806

2x
6262945

3x
4560178

3x
302001

5x
366601

5x
663601

8x
6195358

1x
379501

7x
346001

4x
416201

2x
303201

1x
4144012

2x
6057460

2x
4528341

2x
4119227

1x
4618526

12x
6284600

9x
4159553

5x
4125253

1x
4516055

1x
6256080

2x
6175968

2x
6212758

2x
4666579

2x
4278422

1x
6271241

2x
6092587

1x
6069165

4x
6024495

2x
4114026

5x
4273526

11x
6271228

2x
4217562

3x
6226565

3x
4114077

2x
4121921

2x
4113233

2x
4114309

2x
6122047

1x
4651524

2x
6176298

2x
4179355

1x
302321

1x
6178488

5x
306921

2x
6001806

2x
6126048

2x
371021

1x
6256923





24x
4211149



29x
4211150



22x
4629736



8x
6261744



4x
6172922



1x
4211199



2x
6008297



4x
4216695



6x
4211257



4x
6167644



2x
6102975



1x
6100769



9x
4211152



2x
6055086



3x
6116613



6x
4211189



11x
4211190



2x
4211186



1x
6039192



13x
4221590



5x
4211193



1x
4211247



3x
4216945



2x
4271874



4x
4211211



2x
4211207



4x
4223729



2x
6234270



1x
6170418



2x
4211412



2x
4211525



1x
6168647



1x
4542590



3x
4211503



14x
4211483



4x
4211476



1x
6078985



10x
6144138



1x
6248492



1x
6028812



1x
4211388



1x
6004990



1x
4211397



4x
4211881



1x
4211491



1x
6284071



1x
4211394



8x
4210633



2x
6012451



1x
4211098



2x
6158469



1x
6006141



2x
4516546



4x
4211063



4x
4211052



1x
4261908



1x
6035351



13x
6015356



1x
4211002



1x
6256130



1x
6254513



8x
6060795



4x
6230579



7x
6055380



1x
6229124



1x
6096589



4x
6002148



2x
6209691



15x
4523159



1x
6212377



3x
4519970



7x
6055384



17x
6057986



1x
6192835



1x
4569385



1x
6278110



1x
6271226



2x
6262262



1x
6252197



15x
6218360



1x
6021997



35x
4656783



2x
6167645



1x
6058135



2x
6102994



5x
6252192



1x
6102882



1x
6177535



2x
6271234



1x
6271373



1x
6187006



16x
6055309



2x
6106193



2x
4624473



1x
4624615



1x
6251822



5x
6151671



1x
6152101



1x
6152110



1x
6029163



2x
4655246



2x
6146228



1x
6236582



1x
6119126



2x
6261546



1x
4619512



8x
6258092



1x
6226541



4x
4206482



6x
4514553



8x
6284577



2x
389924



1x
6253294



2x
6173122



1x
362324



Customer Service

Kundenservice

Service Consommateurs

Servicio Al Consumidor

LEGO.com/service or dial



: 00800 5346 5555

: 1-800-422-5346



CREATOR™



LEGO.com/creatorexpert



EXPERT



LEGO and the LEGO logo are trademarks of the LEGO Group.
©2019 The LEGO Group. 6294053

10264